

Label and Packaging, Product, VERASENSE for Exactech Equinox Family

DESCRIPTION

- This document specifies the information that is printed on to the Product Label and packaging assembly requirements for the following family:
VERASENSE for Exactech Equinox

PRODUCT LABEL NOTES

- Create label from: LB-1029 “VERASENSE Label Set Template”
- Record all required information on Device History Record (DHR).
- Print all required information directly onto Label Set blank using laser printer and black ink.
- Print each field per the Field-Description table below. Per the Print column, print either the exact text show, or the information as described.
- Items 8 and 10-12 are repeated on the three peel-off stickers.
- All printed text is to be legible with unaided eye. Printed text shall not overlap.
- Items 5 is GS1-128 single concatenated type one dimensional barcode and human readable printed below barcode as described below:
 - Generation of GS1-128 barcode may be accomplished by several validated software methods, such as specialized software, Excel add-in, or online software.
 - Information encoded into Barcode is particular to an individual sensor following programming and calibration.
 - Encode the following data per the example below (The values on the table for reference only. For the GTIN reference Table #2 and all other use the actual values from work order /route detailed in the table below in the order and formats shown.) Only the values are encoded, not the descriptor in the first column.

Descriptor	Value
GS1 Application Identifier (AI) for Global Trade Identification Number (GTIN)	01
GTIN (must be in a 14 digit format)	00816818021234
GS1 AI for Date of Manufacture	11
Date of Manufacture (six numeric characters)	YYMMDD
GS1 AI for Expiration Date	17
Use by Date (six numeric characters)	YYMMDD
GS1 AI for Lot number	10
Mfg Lot Number (maximum 20 alphanumeric characters)	1234567
GS1 AI for Serial Number	21
Serial Number (maximum 20 alphanumeric characters)	9876543210

- The data is encoded as a single text string of the format below:

010081681802123411YYMMDD17YYMMDD101234567219876543210

NOTE: For clarity, the numbers representing the AI and numbers representing the date element are shown in bold in the example above.

Label and Packaging, Product, VERASENSE for Exactech Equinox Family

- Barcodes symbol sizes





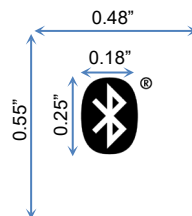







Item	X-dimension			Minimum Symbol Height for Given X mm (inches)			Quiet Zone		Minimum Quality Specification
	Minimum	Target	Maximum	For Minimum X-dimension	For Target X-dimension	For Maximum X-dimension	Left, Right	Above, Below	
5	0.170 (0.0067")	0.495 (0.0195")	0.495 (0.0195")	12.70 (0.500")	12.70 (0.500")	12.70 (0.500")	10X	2X	1.5 /06/660
34	0.170 (0.0067")	0.495 (0.0195")	0.495 (0.0195")	4.76 (0.1875")	4.76 (0.1875")	4.76 (0.1875")	10X	2X	1.5 /06/660

- Human readable format is printed below the barcode in the following format:
(01) 00816818021234 (11) YYMMDD (17) YYMMDD (10) 1234567 (21) 9876543210
- Items 18 and 30 are undefined fields to be used by the Contract Manufacturer for internal tracking (e.g. alphanumeric, 1D barcode, etc...). Print must fit within the specified space.
- Item 13, 22, 32, 41, and 44 contain the document number and revision.
- The specification for the Bluetooth® symbol is as described below:
 - Print the symbol with the size requirements shown below, including the required white space around the figure.
 - Use the highest possible resolution, not going below 16x16 pixels





Label and Packaging, Product, VERASENSE for Exactech Equinox Family

Product Label field Descriptions:

Item #	Field	Description	Font Size pts (Arial)	Print
1		Print image. See Table 1- Select image based on work order	NA	Fill all available space
2		Sizes accommodated. Table 2.	BOLD 9	Text
3		Programmed Device Model ID Number	BOLD 10	Text
4		Manufacturing Lot Number	BOLD 10	Info
5, 34		1D Bar-Code and Human Readable Interpretation. Select appropriate GTIN per work order.	7	Bar Code and human readable
6		Device Expiration Date = Manufactured date plus 24 months in YYYY-MM-DD format.	BOLD 10	Info
7		Manufacturing Date (date that FTS is preformed, obtained from the DHR) in YYYY-MM-DD format.	BOLD 10	Info
8		See table 2. Select the appropriate description per work order.	BOLD 7	Text
9, 28	Side	See table 2. Select the appropriate side per work order.	BOLD 20	Text
10, 36, 39, 43		Manufacturing Lot Number	BOLD 7	Info
11, 33, 38		Programmed Device Model ID Number	BOLD 7	Info
12, 31, 37, 42		See table 2. Select the appropriate description per work order	BOLD 7	Info
13, 22, 32, 41, 44		Document number and revision	6	Text
14, 29	Type	See table 2. Select the appropriate type per work order.	BOLD 20	
15, 27	Size	See table 2. Select the appropriate size per work order.	BOLD 20	Text
16		See table 2. Select the appropriate description per work order.	BOLD 19	Text
17		Programmed Device Model ID Number	BOLD 9	Text
18, 30, 47, 48		Contract Manufacturer's Internal Tracking Identifier (Optional)	NA	Bar Code
19		See table 2. Select the appropriate description per work order.	BOLD 10	Text
23		Manufacturing Lot Number	BOLD 9	Text
24		See table 2. Select the appropriate description per work order.	BOLD 9	Text
20		FCC ID XNL-ORTHOSNSR8	7	Text
25		Device Expiration Date = Manufactured date plus 24 months in YYYY-MM-DD format.	BOLD 9	Text
26		See table 2. Select the appropriate description per work order.	BOLD 9	Text
40, 45		Device Expiration Date = Manufactured date plus 24 months in YYYY-MM-DD format.	BOLD 7	Text
46		Print Bluetooth® symbol as specified in the product label notes.	NA	Symbol

Label and Packaging, Product, VERASENSE for Exactech Equinox Family

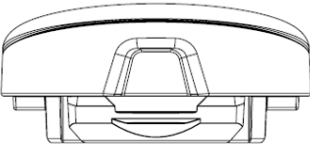
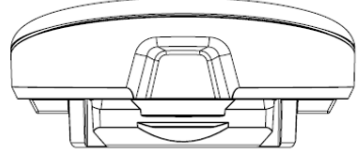
Table 1 DEVICE Images

Item # 1	
Reverse, 38 mm	Reverse, 42 mm
	
	

Label and Packaging, Product, VERASENSE for Exactech Equinox Family

Table #2

Item 5 GTIN	Item 2	Items 8, 16, 26	Items 12, 19, 24	Items 15 & 27	Items 9 & 28	Items 14 & 29
00816818022055	0 mm, 2.5 mm	VERASENSE for Exactech Equinox Reverse Size 38 mm	EXC-EQRV38	38	N/A	REV
00816818022062	0 mm, 2.5 mm	VERASENSE for Exactech Equinox Reverse Size 42 mm	EXC-EQRV42	42	N/A	REV

NOTE: When selecting the appropriate item, please ensure it is the correct side, size and type per the work order.

Label and Packaging, Product, VERASENSE for Exactech Equinox Family

PRODUCT LABEL REFERENCE FIGURES

1. Blank label is shown below with the required print fields highlight:

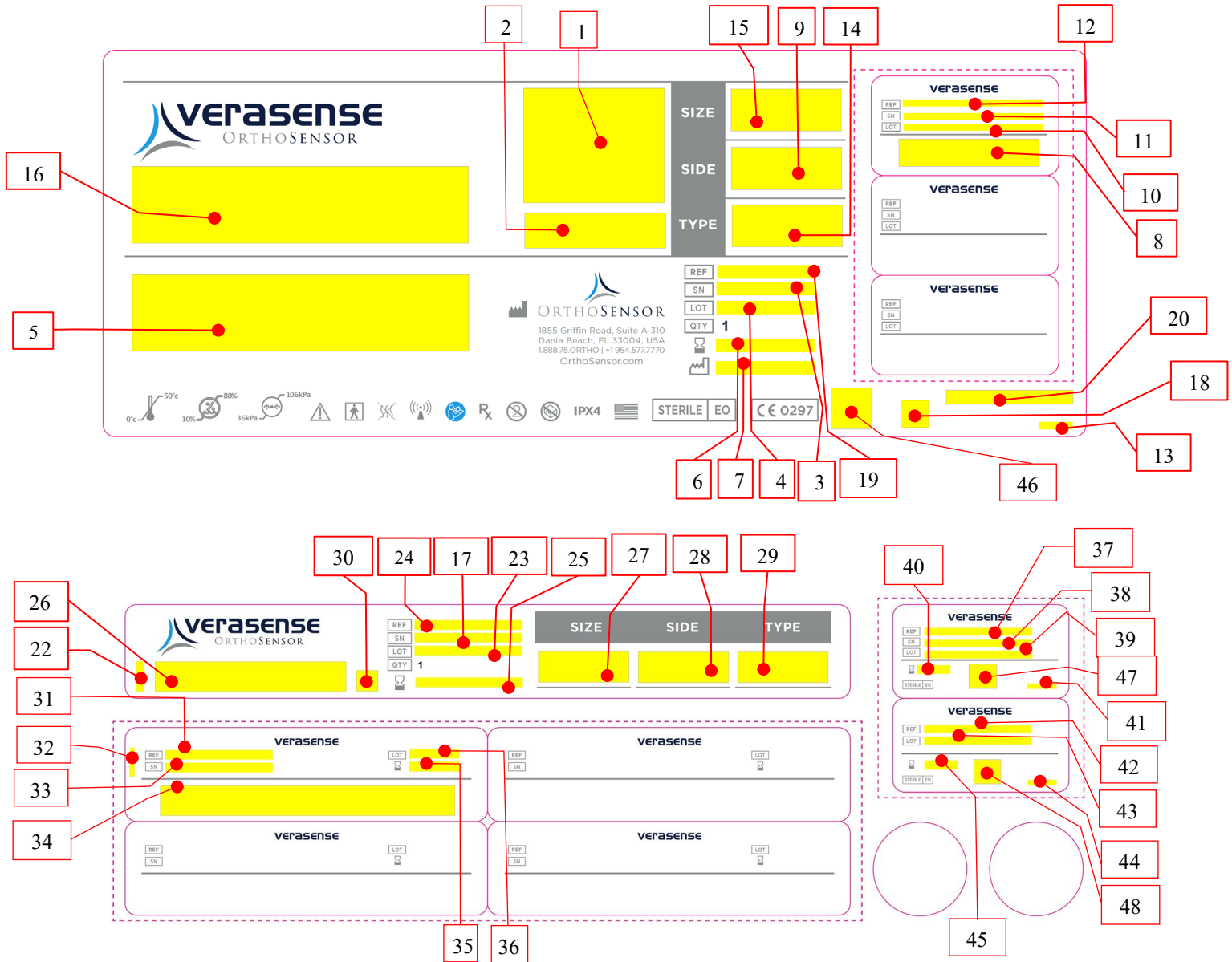

Label and Packaging, Product, VERASENSE for Exactech Equinox Family

2. Below is an example of the completed Label with all fields completed and the barcodes with encoded information. Appendix 1 includes an example label for each item listed in Table 2.

 <p>VERASENSE for Exactech Equinox Reverse Size 38 mm</p>	 <p>0 mm, 2.5 mm</p>	<p>SIZE 38</p>												
		<p>SIDE N/A</p>												
		<p>TYPE REV</p>												
 <p>(01) 00816818022055 (11) 180118 (17) 200118 (10) 20568 (21) 510845011</p>	 <p>1855 Griffin Road, Suite A-310 Danial Beach, FL 33004, USA 1888.75.ORTHO +1954.577.7770 OrthoSensor.com</p>	<table border="1"> <tr><td>REF</td><td>EXC-EQRV38</td></tr> <tr><td>SN</td><td>510845011</td></tr> <tr><td>LOT</td><td>20568</td></tr> <tr><td>QTY</td><td>1</td></tr> <tr><td>EXP</td><td>2020-01-18</td></tr> <tr><td>MFG</td><td>2018-01-18</td></tr> </table>	REF	EXC-EQRV38	SN	510845011	LOT	20568	QTY	1	EXP	2020-01-18	MFG	2018-01-18
REF	EXC-EQRV38													
SN	510845011													
LOT	20568													
QTY	1													
EXP	2020-01-18													
MFG	2018-01-18													
<p>0°C 50°C 10% 80% 36kPa 106kPa</p> <p>STERILE EO CE 0297</p> <p>FCC ID XNL-ORTHOSNSR8 LB-5191-3</p>														

 <p>VERASENSE for Exactech Equinox Reverse Size 38</p>	<table border="1"> <tr><td>REF</td><td>EXC-EQRV38</td></tr> <tr><td>SN</td><td>510845011</td></tr> <tr><td>LOT</td><td>20568</td></tr> <tr><td>QTY</td><td>1</td></tr> <tr><td>EXP</td><td>2020-01-18</td></tr> </table>	REF	EXC-EQRV38	SN	510845011	LOT	20568	QTY	1	EXP	2020-01-18	<p>SIZE 38</p>	<p>SIDE N/A</p>	<p>TYPE REV</p>
		REF	EXC-EQRV38											
SN	510845011													
LOT	20568													
QTY	1													
EXP	2020-01-18													

<table border="1"> <tr><td>REF</td><td>EXC-EQRV38</td></tr> <tr><td>SN</td><td>510845011</td></tr> <tr><td>LOT</td><td>20568</td></tr> </table> <p>2020-01-18</p> <p>STERILE EO</p>	REF	EXC-EQRV38	SN	510845011	LOT	20568	 <p>LB-5191-3</p>
REF	EXC-EQRV38						
SN	510845011						
LOT	20568						
<p>VERASENSE</p> <table border="1"> <tr><td>REF</td><td>DWG-07000-060</td></tr> <tr><td>LOT</td><td>510845011</td></tr> </table> <p>2020-01-18</p> <p>STERILE EO</p>	REF	DWG-07000-060	LOT	510845011	 <p>LB-5191-3</p>		
REF	DWG-07000-060						
LOT	510845011						

<table border="1"> <tr><td>REF</td><td>EXC-EQRV38</td></tr> <tr><td>SN</td><td>510845011</td></tr> </table> <p>VERASENSE</p> <table border="1"> <tr><td>LOT</td><td>20568</td></tr> <tr><td>EXP</td><td>2020-01-18</td></tr> </table>  <p>(01) 00816818022055 (11) 180118 (17) 200118 (10) 20568 (21) 510845011</p>	REF	EXC-EQRV38	SN	510845011	LOT	20568	EXP	2020-01-18	<table border="1"> <tr><td>REF</td><td>EXC-EQRV38</td></tr> <tr><td>SN</td><td>510845011</td></tr> </table> <p>verasense</p> <table border="1"> <tr><td>LOT</td><td>20568</td></tr> <tr><td>EXP</td><td>2020-01-18</td></tr> </table>  <p>(01) 00816818022055 (11) 180118 (17) 200118 (10) 20568 (21) 510845011</p>	REF	EXC-EQRV38	SN	510845011	LOT	20568	EXP	2020-01-18
REF	EXC-EQRV38																
SN	510845011																
LOT	20568																
EXP	2020-01-18																
REF	EXC-EQRV38																
SN	510845011																
LOT	20568																
EXP	2020-01-18																
<table border="1"> <tr><td>REF</td><td>EXC-EQRV38</td></tr> <tr><td>SN</td><td>510845011</td></tr> </table> <p>VERASENSE</p> <table border="1"> <tr><td>LOT</td><td>20568</td></tr> <tr><td>EXP</td><td>2020-01-18</td></tr> </table>  <p>(01) 00816818022055 (11) 180118 (17) 200118 (10) 20568 (21) 510845011</p>	REF	EXC-EQRV38	SN	510845011	LOT	20568	EXP	2020-01-18	<table border="1"> <tr><td>REF</td><td>EXC-EQRV38</td></tr> <tr><td>SN</td><td>510845011</td></tr> </table> <p>verasense</p> <table border="1"> <tr><td>LOT</td><td>20568</td></tr> <tr><td>EXP</td><td>2020-01-18</td></tr> </table>  <p>(01) 00816818022055 (11) 180118 (17) 200118 (10) 20568 (21) 510845011</p>	REF	EXC-EQRV38	SN	510845011	LOT	20568	EXP	2020-01-18
REF	EXC-EQRV38																
SN	510845011																
LOT	20568																
EXP	2020-01-18																
REF	EXC-EQRV38																
SN	510845011																
LOT	20568																
EXP	2020-01-18																

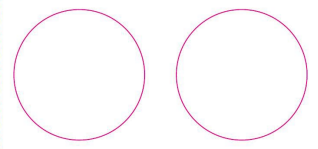

Label and Packaging, Product, VERASENSE for Exactech Equinox Family

PACKAGING ASSEMBLY NOTES

- See separate Bill of Materials, VERASENSE for Exactech Equinox for Item description.
- Refer to Contract Manufacturer’s Quality System for:
 - Part Inspection requirements
 - Functional testing requirements
 - Part handling and cleanliness
 - Packaging and Labeling
 - Traceability and Documentation requirements
- Contract Manufacturer’s Quality System shall meet or exceed the requirements per the Quality Agreement established with the Contract Manufacturer.
- Contract Manufacturer’s internal Tracking & Identification labels are permissible on all components per the following:
 - Labels are permitted on: Box, Envelope, Bags, IFU and Addendum, Product Label, and on the outer Pouch of the Pouched Sensor and Shim-Set.
 - Labels are not permitted on any Inner Pouch, or on any VERASENSE or Shim surfaces.
 - Labels must be permanent, and printed with indelible ink. Maximum label size is 1.0” x 0.5”.
 - Labels should be located near a corner, or in an innocuous location, and not obscure any other marking or lettering.

PACKAGING ASSEMBLY PROCEDURES

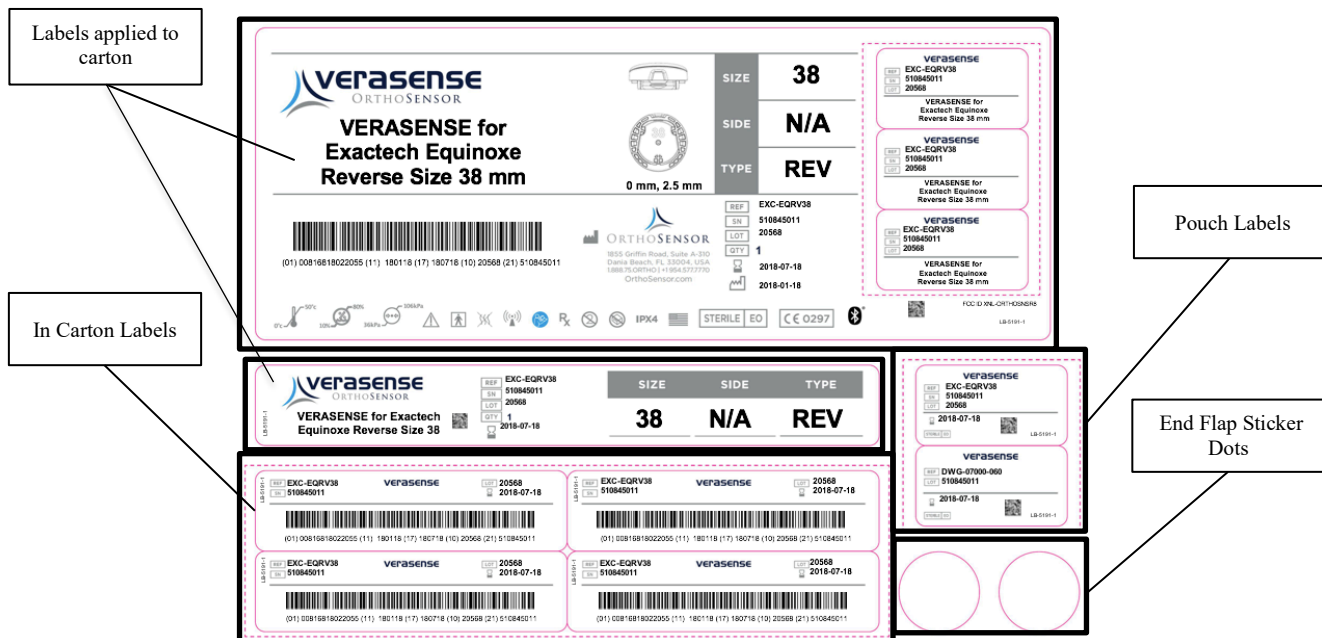

1. Build per Bill of Materials, VERASENSE for Exactech Equinox and Router/Work Instruction.



Label and Packaging, Product, VERASENSE for Exactech Equinox Family

2. If the device is for Design Verification Testing (DVT)
 - a. Add DVT-build number to the end of descriptions in fields 16 & 26.
 - b. Do not enter information in the following fields: 4, 5, 6, 7, 8, 10, 11, 12, 18, 23, 25, 30, 33, 35, 36, 39, 40, 42, 45, 47, 48.

Example labels for Size 38 DVT build

 <p>VERASENSE for Exactech Equinox Reverse Size 38 mm DVT-1</p> <p>0 mm, 2.5 mm</p>	<table border="1" style="width: 100%; border-collapse: collapse;"> <tr><td style="background-color: #cccccc;">SIZE</td><td style="text-align: center;">38</td></tr> <tr><td style="background-color: #cccccc;">SIDE</td><td style="text-align: center;">N/A</td></tr> <tr><td style="background-color: #cccccc;">TYPE</td><td style="text-align: center;">REV</td></tr> </table>	SIZE	38	SIDE	N/A	TYPE	REV	<table border="1" style="width: 100%; border-collapse: collapse;"> <tr><td style="text-align: center;">verasense</td></tr> <tr><td>REF EXC-EQRV38</td></tr> <tr><td>SN 510845011</td></tr> <tr><td>LOT</td></tr> </table> <table border="1" style="width: 100%; border-collapse: collapse;"> <tr><td style="text-align: center;">verasense</td></tr> <tr><td>REF EXC-EQRV38</td></tr> <tr><td>SN 510845011</td></tr> <tr><td>LOT</td></tr> </table> <table border="1" style="width: 100%; border-collapse: collapse;"> <tr><td style="text-align: center;">verasense</td></tr> <tr><td>REF EXC-EQRV38</td></tr> <tr><td>SN 510845011</td></tr> <tr><td>LOT</td></tr> </table>	verasense	REF EXC-EQRV38	SN 510845011	LOT	verasense	REF EXC-EQRV38	SN 510845011	LOT	verasense	REF EXC-EQRV38	SN 510845011	LOT
SIZE	38																			
SIDE	N/A																			
TYPE	REV																			
verasense																				
REF EXC-EQRV38																				
SN 510845011																				
LOT																				
verasense																				
REF EXC-EQRV38																				
SN 510845011																				
LOT																				
verasense																				
REF EXC-EQRV38																				
SN 510845011																				
LOT																				
 <p>1855 Griffin Road, Suite A-310 Dania Beach, FL 33004, USA 1.888.75.ORTHO +1.954.571.7770 OrthoSensor.com</p>	<table border="1" style="width: 100%; border-collapse: collapse;"> <tr><td>REF</td><td>EXC-EQRV38</td></tr> <tr><td>SN</td><td>510845011</td></tr> <tr><td>LOT</td><td></td></tr> <tr><td>QTY</td><td>1</td></tr> </table>	REF	EXC-EQRV38	SN	510845011	LOT		QTY	1											
REF	EXC-EQRV38																			
SN	510845011																			
LOT																				
QTY	1																			
	<p>FCC ID XNL-ORTHOSNR8</p> <p>LB-5191-3</p>																			

 <p>VERASENSE for Exactech Equinox Reverse Size 38 mm DVT-1</p>	<table border="1" style="width: 100%; border-collapse: collapse;"> <tr><td>REF</td><td>EXC-EQRV38</td></tr> <tr><td>SN</td><td>510845011</td></tr> <tr><td>LOT</td><td></td></tr> <tr><td>QTY</td><td>1</td></tr> </table>	REF	EXC-EQRV38	SN	510845011	LOT		QTY	1	<table border="1" style="width: 100%; border-collapse: collapse;"> <tr><td style="background-color: #cccccc;">SIZE</td><td style="background-color: #cccccc;">SIDE</td><td style="background-color: #cccccc;">TYPE</td></tr> <tr><td style="text-align: center;">38</td><td style="text-align: center;">N/A</td><td style="text-align: center;">REV</td></tr> </table>	SIZE	SIDE	TYPE	38	N/A	REV
REF	EXC-EQRV38															
SN	510845011															
LOT																
QTY	1															
SIZE	SIDE	TYPE														
38	N/A	REV														

verasense
REF EXC-EQRV38
SN 510845011
LOT
STERILE EO
LB-5191-3

verasense
REF
LOT
STERILE EO
LB-5199-0

<table border="1" style="width: 100%; border-collapse: collapse;"> <tr><td>REF EXC-EQRV38</td></tr> <tr><td>SN 510845011</td></tr> <tr><td>LOT</td></tr> </table>	REF EXC-EQRV38	SN 510845011	LOT	<table border="1" style="width: 100%; border-collapse: collapse;"> <tr><td>REF EXC-EQRV38</td></tr> <tr><td>SN 510845011</td></tr> <tr><td>LOT</td></tr> </table>	REF EXC-EQRV38	SN 510845011	LOT	<table border="1" style="width: 100%; border-collapse: collapse;"> <tr><td>REF EXC-EQRV38</td></tr> <tr><td>SN 510845011</td></tr> <tr><td>LOT</td></tr> </table>	REF EXC-EQRV38	SN 510845011	LOT	<table border="1" style="width: 100%; border-collapse: collapse;"> <tr><td>REF EXC-EQRV38</td></tr> <tr><td>SN 510845011</td></tr> <tr><td>LOT</td></tr> </table>	REF EXC-EQRV38	SN 510845011	LOT
REF EXC-EQRV38															
SN 510845011															
LOT															
REF EXC-EQRV38															
SN 510845011															
LOT															
REF EXC-EQRV38															
SN 510845011															
LOT															
REF EXC-EQRV38															
SN 510845011															
LOT															

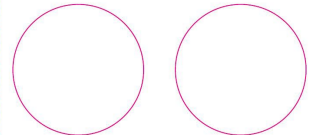

Label and Packaging, Product, VERASENSE for Exactech Equinox Family



Example labels for Size 42 DVT build

 <p>VERASENSE for Exactech Equinox Reverse Size 42 mm DVT-1</p> <p>0 mm, 2.5 mm</p>	SIZE	42
	SIDE	N/A
	TYPE	REV

 <p>1855 Griffin Road, Suite A-310 Dania Beach, FL 33004, USA 1.888.75.ORTHO +1.954.577.7770 OrthoSensor.com</p>	<table border="1"> <tr><td>REF</td><td>EXC-EQRV38</td></tr> <tr><td>SN</td><td>510845011</td></tr> <tr><td>LOT</td><td></td></tr> <tr><td>QTY</td><td>1</td></tr> </table>	REF	EXC-EQRV38	SN	510845011	LOT		QTY	1
REF	EXC-EQRV38								
SN	510845011								
LOT									
QTY	1								

	FCC ID XNL-ORTHOSENRS8
--	------------------------

 <p>VERASENSE for Exactech Equinox Reverse Size 42 mm DVT-1</p>	REF	EXC-EQRV42	SIZE	SIDE	TYPE
	SN	510845011	42	N/A	REV
	LOT				
	QTY	1			

 <p>REF: EXC-EQRV42 SN: 510845011 LOT: _____</p> <p>STERILE EO</p> <p>LB-5191-3</p>
 <p>REF: _____ SN: _____ LOT: _____</p> <p>STERILE EO</p> <p>LB-5189-0</p>

<p>REF: EXC-EQRV42 SN: 510845011</p> <p>VERASENSE</p> <p>LOT: _____</p>	<p>REF: EXC-EQRV42 SN: 510845011</p> <p>VERASENSE</p> <p>LOT: _____</p>
<p>REF: EXC-EQRV42 SN: 510845011</p> <p>VERASENSE</p> <p>LOT: _____</p>	<p>REF: EXC-EQRV42 SN: 510845011</p> <p>VERASENSE</p> <p>LOT: _____</p>

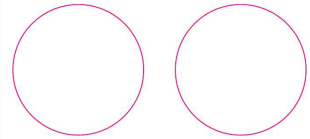

Label and Packaging, Product, VERASENSE for Exactech Equinox Family

3. With the box oriented as shown below, place contents into box in the order shown below: Return Envelope on bottom, followed by Instructions-for-Use, Translation Addendum, In-Carton Labels, Pouched Shim-Set, and the Pouched Sensor on top.
 1. Insert Pouched Shim-Set and Pouched Sensor clear side up, and the factory sealed end going into the box first.
 2. Do not bend, wrinkle or distort pouches when inserting into product box.

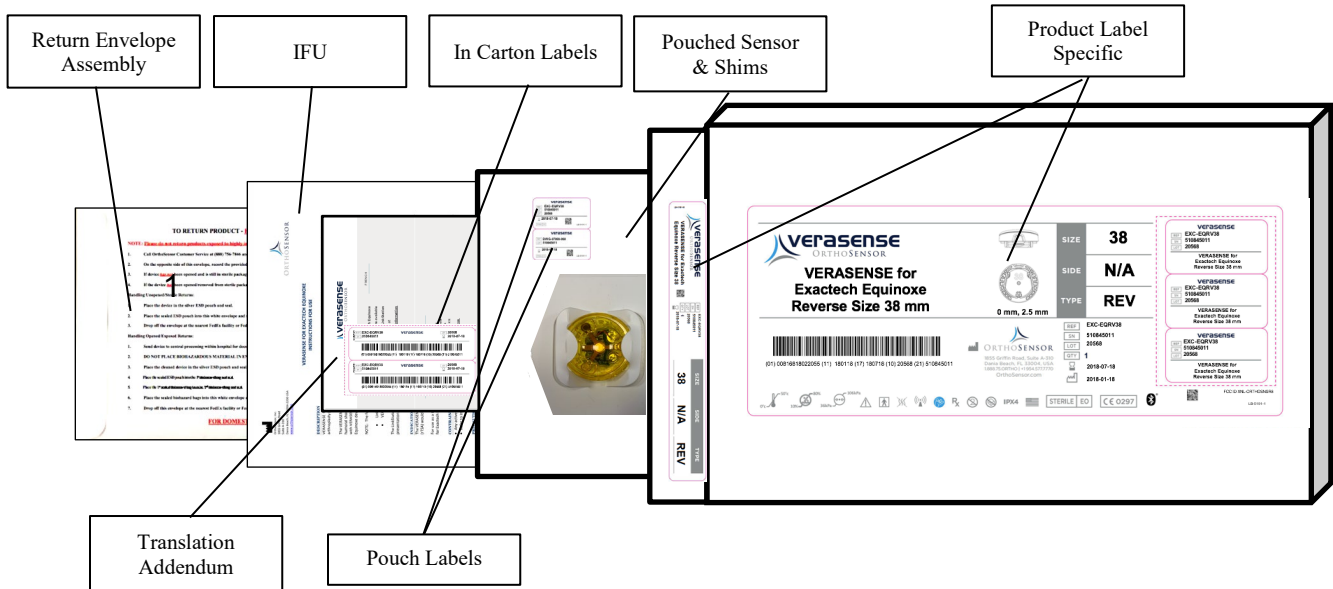

Note: Generic image used above for illustration.

4. Affix End Flap Labels as shown below. Label Barcode IDs shall be traceable to the Device Model ID number.

Back of Box

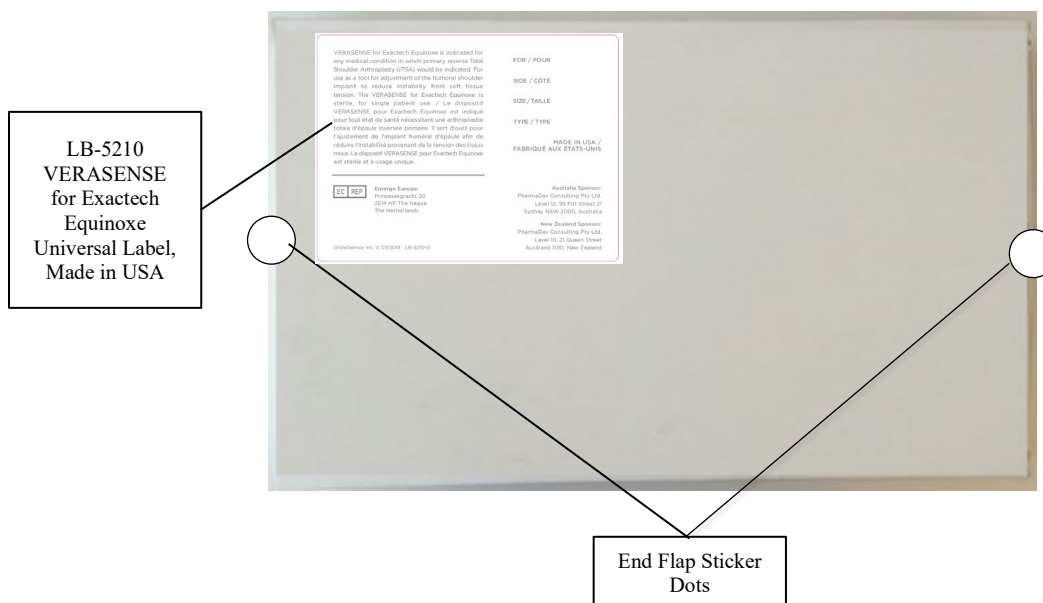

Label and Packaging, Product, VERASENSE for Exactech Equinoxe Family

5. If device was sterilized and is Not For Human Use, affix the “NOT FOR HUMAN USE” label over the symbol on the Product Label as shown below. CE 0297



6. If the device and/or shim were not sterilized:
- Affix a “CAUTION NON-STERILE” sticker on the outer pouch of the pouched sensor and shim-set, where indicated below.
 - Affix a “CAUTION NON-STERILE” sticker over the STERILE EO symbol on the Product Label as shown below.







Label and Packaging, Product, VERASENSE for Exactech Equinox Family

REVISION HISTORY

Rev	Description	Date
0	Initial Release.	1/17/2019
1	Added device images to Table 1. Updated example images in the Product Label Reference, Appendix, and Packaging Assembly Procedures sections.	4/9/2019
2	Added packaging instructions for translation addendum and universal label.	7/31/2019
3	Changed shelf life from 6 months to 24 months	8/16/2019

Label and Packaging, Product, VERASENSE for Exactech Equinox Family

APPENDIX 1: Example Labels

 <p>VERASENSE for Exactech Equinox Reverse Size 38 mm</p>	 <p>0 mm, 2.5 mm</p>	<p>SIZE 38</p>												
		<p>SIDE N/A</p>												
		<p>TYPE REV</p>												
 <p>(01) 00816818022055 (11) 180118 (17) 200118 (10) 20568 (21) 510845011</p>	 <p>1855 Griffin Road, Suite A-310 Dania Beach, FL 33004, USA 1.888.75.ORTHO +1.954.577.7770 OrthoSensor.com</p>	<table border="1"> <tr><td>REF</td><td>EXC-EQRV38</td></tr> <tr><td>SN</td><td>510845011</td></tr> <tr><td>LOT</td><td>20568</td></tr> <tr><td>QTY</td><td>1</td></tr> <tr><td>EXP</td><td>2020-01-18</td></tr> <tr><td>EXP</td><td>2018-01-18</td></tr> </table>	REF	EXC-EQRV38	SN	510845011	LOT	20568	QTY	1	EXP	2020-01-18	EXP	2018-01-18
REF	EXC-EQRV38													
SN	510845011													
LOT	20568													
QTY	1													
EXP	2020-01-18													
EXP	2018-01-18													
		<table border="1"> <tr><td>REF</td><td>EXC-EQRV38</td></tr> <tr><td>SN</td><td>510845011</td></tr> <tr><td>LOT</td><td>20568</td></tr> <tr><td>QTY</td><td>1</td></tr> <tr><td>EXP</td><td>2020-01-18</td></tr> <tr><td>EXP</td><td>2018-01-18</td></tr> </table>	REF	EXC-EQRV38	SN	510845011	LOT	20568	QTY	1	EXP	2020-01-18	EXP	2018-01-18
REF	EXC-EQRV38													
SN	510845011													
LOT	20568													
QTY	1													
EXP	2020-01-18													
EXP	2018-01-18													

<p>VERASENSE</p> <table border="1"> <tr><td>REF</td><td>EXC-EQRV38</td></tr> <tr><td>SN</td><td>510845011</td></tr> <tr><td>LOT</td><td>20568</td></tr> </table> <p>VERASENSE for Exactech Equinox Reverse Size 38 mm</p>	REF	EXC-EQRV38	SN	510845011	LOT	20568
REF	EXC-EQRV38					
SN	510845011					
LOT	20568					
<p>VERASENSE</p> <table border="1"> <tr><td>REF</td><td>EXC-EQRV38</td></tr> <tr><td>SN</td><td>510845011</td></tr> <tr><td>LOT</td><td>20568</td></tr> </table> <p>VERASENSE for Exactech Equinox Reverse Size 38 mm</p>	REF	EXC-EQRV38	SN	510845011	LOT	20568
REF	EXC-EQRV38					
SN	510845011					
LOT	20568					
<p>VERASENSE</p> <table border="1"> <tr><td>REF</td><td>EXC-EQRV38</td></tr> <tr><td>SN</td><td>510845011</td></tr> <tr><td>LOT</td><td>20568</td></tr> </table> <p>VERASENSE for Exactech Equinox Reverse Size 38 mm</p>	REF	EXC-EQRV38	SN	510845011	LOT	20568
REF	EXC-EQRV38					
SN	510845011					
LOT	20568					

 <p>VERASENSE for Exactech Equinox Reverse Size 38 mm</p>	<table border="1"> <tr><td>REF</td><td>EXC-EQRV38</td></tr> <tr><td>SN</td><td>510845011</td></tr> <tr><td>LOT</td><td>20568</td></tr> <tr><td>QTY</td><td>1</td></tr> <tr><td>EXP</td><td>2020-01-18</td></tr> </table>	REF	EXC-EQRV38	SN	510845011	LOT	20568	QTY	1	EXP	2020-01-18	<p>SIZE 38</p>	<p>SIDE N/A</p>	<p>TYPE REV</p>
		REF	EXC-EQRV38											
SN	510845011													
LOT	20568													
QTY	1													
EXP	2020-01-18													

<p>VERASENSE</p> <table border="1"> <tr><td>REF</td><td>EXC-EQRV38</td></tr> <tr><td>SN</td><td>510845011</td></tr> <tr><td>LOT</td><td>20568</td></tr> </table> <p>2020-01-18</p> <p>STERILE EO</p>	REF	EXC-EQRV38	SN	510845011	LOT	20568
REF	EXC-EQRV38					
SN	510845011					
LOT	20568					
<p>VERASENSE</p> <table border="1"> <tr><td>REF</td><td>DWG-07000-060</td></tr> <tr><td>LOT</td><td>510845011</td></tr> </table> <p>2020-01-18</p> <p>STERILE EO</p>	REF	DWG-07000-060	LOT	510845011		
REF	DWG-07000-060					
LOT	510845011					

<p>REF EXC-EQRV38 SN 510845011</p> <p>VERASENSE</p> <p>LOT 20568 EXP 2020-01-18</p>  <p>(01) 00816818022055 (11) 180118 (17) 200118 (10) 20568 (21) 510845011</p>	<p>REF EXC-EQRV38 SN 510845011</p> <p>VERASENSE</p> <p>LOT 20568 EXP 2020-01-18</p>  <p>(01) 00816818022055 (11) 180118 (17) 200118 (10) 20568 (21) 510845011</p>
<p>REF EXC-EQRV38 SN 510845011</p> <p>VERASENSE</p> <p>LOT 20568 EXP 2020-01-18</p>  <p>(01) 00816818022055 (11) 180118 (17) 200118 (10) 20568 (21) 510845011</p>	<p>REF EXC-EQRV38 SN 510845011</p> <p>VERASENSE</p> <p>LOT 20568 EXP 2020-01-18</p>  <p>(01) 00816818022055 (11) 180118 (17) 200118 (10) 20568 (21) 510845011</p>

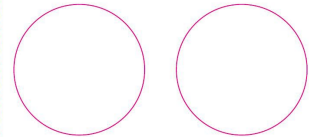

Label and Packaging, Product, VERASENSE for Exactech Equinox Family



VERASENSE for Exactech Equinox Reverse Size 42 mm





0 mm, 2.5 mm

SIZE	42
SIDE	N/A
TYPE	REV



(01) 00816818022062 (11) 180118 (17) 200118 (10) 20568 (21) 510845011



1855 Griffin Road, Suite A-310
Dania Beach, FL 33004, USA
1.888.75.ORTHO | +1.954.577.7770
OrthoSensor.com

REF	EXC-EQRV42
SN	510845011
LOT	20568
QTY	1
EXP	2020-01-18
EXP	2018-01-18



FCC ID: XNL-ORTHOSNSR8

LB-5191-3



VERASENSE for Exactech Equinox Reverse Size 42 mm

REF	EXC-EQRV42
SN	510845011
LOT	20568
QTY	1
EXP	2020-01-18

SIZE	SIDE	TYPE
42	N/A	REV

REF: EXC-EQRV42 VERASENSE LOT: 20568
SN: 510845011 2020-01-18



(01) 00816818022062 (11) 180118 (17) 200118 (10) 20568 (21) 510845011

REF: EXC-EQRV42 VERASENSE LOT: 20568
SN: 510845011 2020-01-18



(01) 00816818022062 (11) 180118 (17) 200118 (10) 20568 (21) 510845011

REF: EXC-EQRV42 VERASENSE LOT: 20568
SN: 510845011 2020-01-18



(01) 00816818022062 (11) 180118 (17) 200118 (10) 20568 (21) 510845011

REF: EXC-EQRV42 VERASENSE LOT: 20568
SN: 510845011 2020-01-18



(01) 00816818022062 (11) 180118 (17) 200118 (10) 20568 (21) 510845011

