

FCC Test Report

FCC ID : XNAWAM03
Equipment : Pulse HR
Model No. : WAM03
Brand Name : Withings
Applicant : Withings SA
Address : 2 rue Maurice Hartmann
92130 Issy-Les-Moulineaux
France
Standard : 47 CFR FCC Part 15.247
Received Date : Jul. 20, 2018
Tested Date : Aug. 30 ~ Sep. 04, 2018

We, International Certification Corp., would like to declare that the tested sample has been evaluated and in compliance with the requirement of the above standards. The test results contained in this report refer exclusively to the product. It may be duplicated completely for legal use with the approval of the applicant. It shall not be reproduced except in full without the written approval of our laboratory.

Reviewed by:



Along Chen / Assistant Manager

Approved by:



Gary Chang / Manager



Table of Contents

1	GENERAL DESCRIPTION	5
1.1	Information.....	5
1.2	Local Support Equipment List	7
1.3	Test Setup Chart	7
1.4	Test Equipment List and Calibration Data.....	8
1.5	Test Standards	9
1.6	Measurement Uncertainty	9
2	TEST CONFIGURATION	10
2.1	Testing Condition	10
2.2	The Worst Test Modes and Channel Details	10
3	TRANSMITTER TEST RESULTS.....	11
3.1	Conducted Emissions.....	11
3.2	6dB and Occupied Bandwidth	14
3.3	RF Output Power	17
3.4	Power Spectral Density	19
3.5	Emissions in Restricted Frequency Bands.....	22
3.6	Emissions in non-restricted Frequency Bands	34
4	TEST LABORATORY INFORMATION	37

Release Record

Report No.	Version	Description	Issued Date
FR872001	Rev. 01	Initial issue	Oct. 04, 2018

Summary of Test Results

FCC Rules	Test Items	Measured	Result
15.207	AC Power Line Conducted Emissions	[dBuV]: 0.367MHz 39.42 (Margin -9.14dB) - AV	Pass
15.247(d) 15.209	Radiated Emissions	[dBuV/m at 3m]: 70.76MHz 31.06 (Margin -8.94dB) - PK	Pass
15.247(b)(3)	Maximum Output Power	Power [dBm]: -0.34	Pass
15.247(a)(2)	6dB Bandwidth	Meet the requirement of limit	Pass
15.247(e)	Power Spectral Density	Meet the requirement of limit	Pass
15.203	Antenna Requirement	Meet the requirement of limit	Pass

1 General Description

1.1 Information

1.1.1 Specification of the Equipment under Test (EUT)

RF General Information				
Frequency Range (MHz)	Bluetooth Mode	Ch. Freq. (MHz)	Channel Number	Data Rate
2400-2483.5	V4.0 LE	2402-2480	0-39 [40]	1 Mbps
Note 1: Bluetooth LE (Low energy) uses GFSK modulation.				

1.1.2 Antenna Details

Ant. No.	Brand	Model	Type	Connector	Gain (dBi)	Remarks
1	ETHERTRONICS	1001312	Chip	N/A	1.88	---

1.1.3 Power Supply Type of Equipment under Test (EUT)

Power Supply Type	3.8Vdc from battery 5Vdc form host
--------------------------	---------------------------------------

1.1.4 Accessories

Accessories		
No.	Equipment	Description
1	Rechargeable li-ion battery	Brand: Everpower Technology Model: PL381225V Power Rating: Rating: 3.8V, 110mAh
2	USB Charger cable	Brand: Withings Model : RK-CD574-1 Power Line: 0.5m non-shielded without core

1.1.5 Channel List

Frequency band (MHz)				2400~2483.5			
Channel	Frequency (MHz)	Channel	Frequency (MHz)	Channel	Frequency (MHz)	Channel	Frequency (MHz)
37	2402	9	2422	18	2442	28	2462
0	2404	10	2424	19	2444	29	2464
1	2406	38	2426	20	2446	30	2466
2	2408	11	2428	21	2448	31	2468
3	2410	12	2430	22	2450	32	2470
4	2412	13	2432	23	2452	33	2472
5	2414	14	2434	24	2454	34	2474
6	2416	15	2436	25	2456	35	2476
7	2418	16	2438	26	2458	36	2478
8	2420	17	2440	27	2460	39	2480

1.1.6 Test Tool and Duty Cycle

Test tool	nrfgostudio, Version: V1.2.1.0
Duty cycle of test signal (%)	60.04%
Duty Factor (dB)	1.94

1.1.7 Power Setting

Modulation Mode	Test Frequency (MHz)		
	2402	2440	2480
GFSK/1Mbps	default	default	default

1.2 Local Support Equipment List

Support Equipment List					
No.	Equipment	Brand	Model	FCC ID	Remarks
1	Notebook	DELL	Latitude E5470	DoC	---

1.3 Test Setup Chart

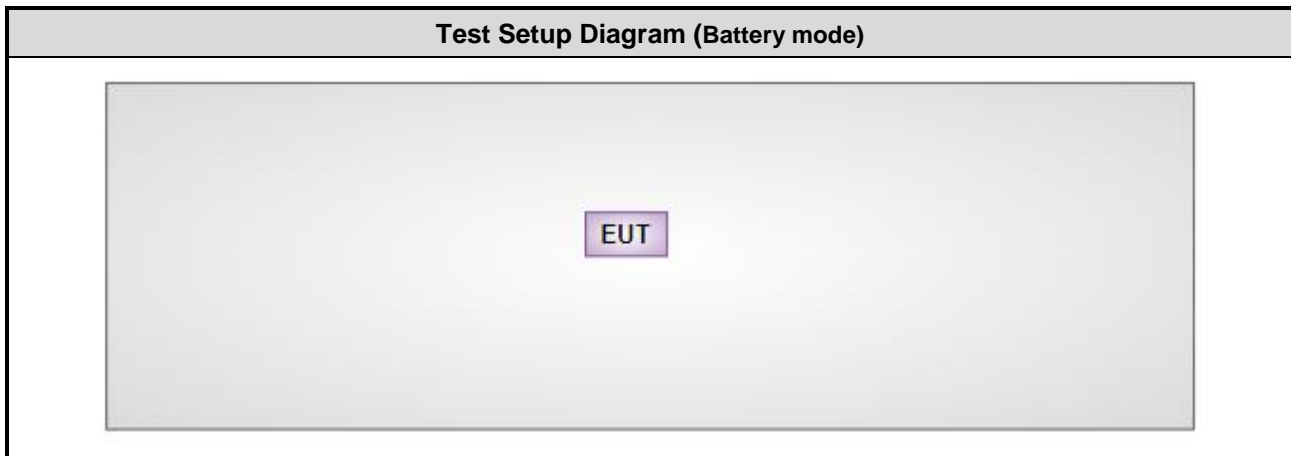

Note: The support console cable and Notebook are disconnected from EUT and removed from test table when EUT is set to transmit/receive continuously.

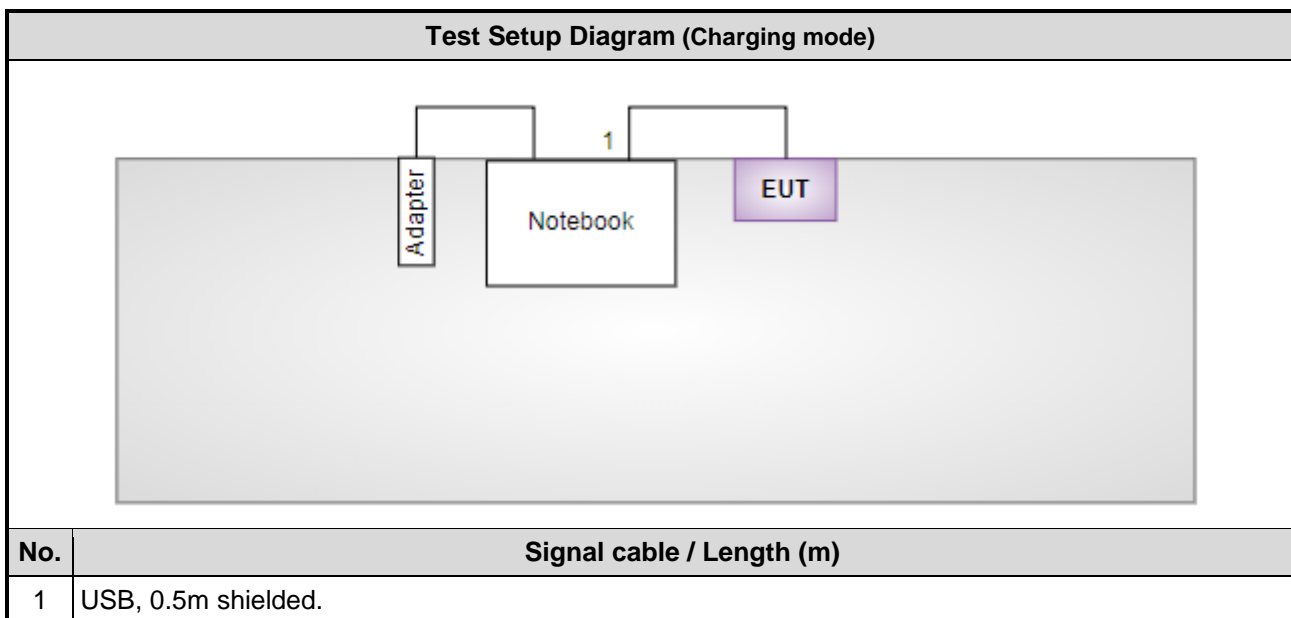

1.4 Test Equipment List and Calibration Data

Test Item	Conducted Emission				
Test Site	Conduction room 1 / (CO01-WS)				
Tested Date	Sep. 04, 2018				
Instrument	Manufacturer	Model No.	Serial No.	Calibration Date	Calibration Until
Receiver	R&S	ESR3	101657	Jan. 05, 2018	Jan. 04, 2019
LISN	SCHWARZBECK	Schwarzbeck 8127	8127-667	Nov. 13, 2017	Nov. 12, 2018
RF Cable-CON	EMC	EMCCFD300-BM-B M-6000	50821	Dec. 18, 2017	Dec. 17, 2018
Measurement Software	AUDIX	e3	6.120210k	NA	NA
Note: Calibration Interval of instruments listed above is one year.					

Test Item	Radiated Emission				
Test Site	966 chamber1 / (03CH01-WS)				
Tested Date	Aug. 13 ~ Aug. 16, 2018				
Instrument	Manufacturer	Model No.	Serial No.	Calibration Date	Calibration Until
Spectrum Analyzer	R&S	FSV40	101498	Dec. 04, 2017	Dec. 03, 2018
Receiver	R&S	ESR3	101658	Nov. 20, 2017	Nov. 19, 2018
Bilog Antenna	SCHWARZBECK	VULB9168	VULB9168-522	Jul. 18, 2018	Jul. 17, 2019
Horn Antenna 1G-18G	SCHWARZBECK	BBHA 9120 D	BBHA 9120 D 1096	Dec. 20, 2017	Dec. 19, 2018
Horn Antenna 18G-40G	SCHWARZBECK	BBHA 9170	BBHA 9170517	Nov. 23, 2017	Nov. 22, 2018
Preamplifier	EMC	EMC02325	980225	Jul. 20, 2018	Jul. 19, 2019
Preamplifier	Agilent	83017A	MY39501308	Oct. 06, 2017	Oct. 05, 2018
Preamplifier	EMC	EMC184045B	980192	Aug. 09, 2018	Aug. 08, 2019
RF Cable	HUBER+SUHNER	SUCOFLEX104	MY16140/4	May 09, 2018	May 08, 2019
RF Cable	HUBER+SUHNER	SUCOFLEX104	MY16019/4	Dec. 07, 2017	Dec. 06, 2018
RF Cable	HUBER+SUHNER	SUCOFLEX104	MY16139/4	Dec. 07, 2017	Dec. 06, 2018
LF cable 1M	EMC	EMCCFD400-NM-N M-1000	16052	Dec. 07, 2017	Dec. 06, 2018
LF cable 3M	Woken	CFD400NL-LW	CFD400NL-001	Dec. 07, 2017	Dec. 06, 2018
LF cable 10M	Woken	CFD400NL-LW	CFD400NL-002	Dec. 07, 2017	Dec. 06, 2018
Measurement Software	AUDIX	e3	6.120210g	NA	NA
Note: Calibration Interval of instruments listed above is one year.					

Test Item	RF Conducted				
Test Site	(TH01-WS)				
Tested Date	Aug. 30, 2018				
Instrument	Manufacturer	Model No.	Serial No.	Calibration Date	Calibration Until
Spectrum Analyzer	R&S	FSV40	101063	Apr. 16, 2018	Apr. 15, 2019
Power Meter	Anritsu	ML2495A	1241002	Oct. 16, 2017	Oct. 15, 2018
Power Sensor	Anritsu	MA2411B	1207366	Oct. 16, 2017	Oct. 15, 2018
DC POWER SOURCE	GW INSTRON	GPC-6030D	EM892433	Oct. 26, 2017	Oct. 25, 2018
Measurement Software	Sporton	Sporton_1	1.3.30	NA	NA
Note: Calibration Interval of instruments listed above is one year.					

1.5 Test Standards

According to the specification of EUT, the EUT must comply with following standards and KDB documents.

47 CFR FCC Part 15.247

ANSI C63.10-2013

FCC KDB 558074 D01 15.247 Meas Guidance v05

1.6 Measurement Uncertainty

ISO/IEC 17025 requires that an estimate of the measurement uncertainties associated with the emissions test results be included in the report. The measurement uncertainties given below are based on a 95% confidence level (based on a coverage factor (k=2))

Measurement Uncertainty	
Parameters	Uncertainty
Bandwidth	±34.134 Hz
Conducted power	±0.808 dB
Power density	±0.463 dB
Conducted emission	±2.670 dB
AC conducted emission	±2.90 dB
Radiated emission ≤ 1GHz	±3.66 dB
Radiated emission > 1GHz	±5.63 dB

2 Test Configuration

2.1 Testing Condition

Test Item	Test Site	Ambient Condition	Tested By
AC Conduction	CO01-WS	24°C / 57%	Alex Tsai
Radiated Emissions	03CH01-WS	23-25°C / 64-65%	Vincent Yeh
RF Conducted	TH01-WS	24°C / 66%	Aska Huang

- FCC Designation No.: TW2732
- FCC site registration No.: 181692
- IC site registration No.: 10807A-1

2.2 The Worst Test Modes and Channel Details

Test item	Mode	Test Frequency (MHz)	Data Rate	Test Configuration
AC Power Line Conducted Emissions	BT LE	2402	1Mbps	2
Radiated Emissions ≤ 1GHz	BT LE	2402	1Mbps	1, 2
Radiated Emissions > 1GHz Maximum Output Power 6dB bandwidth Power spectral density	BT LE	2402, 2440, 2480	1Mbps	1

NOTE:

1. The EUT was pretested with 3 orientations placed on the table for the radiated emission measurement – X, Y, and Z-plane. The **X-plane** results were found as the worst case and were shown in this report.
2. The device can be operated under battery mode and charging mode. Each mode was selected for related test items as below configuration.
 - 1) Configuration 1: Battery mode , X-plane
 - 2) Configuration 2: Charging mode, X-plane

3 Transmitter Test Results

3.1 Conducted Emissions

3.1.1 Limit of Conducted Emissions

Conducted Emissions Limit		
Frequency Emission (MHz)	Quasi-Peak	Average
0.15-0.5	66 - 56 *	56 - 46 *
0.5-5	56	46
5-30	60	50

Note 1: * Decreases with the logarithm of the frequency.

3.1.2 Test Procedures

1. The device is placed on a test table, raised 80 cm above the reference ground plane. The vertical conducting plane is located 40 cm to the rear of the device.
2. The device is connected to line impedance stabilization network (LISN) and other accessories are connected to other LISN. Measured levels of AC power line conducted emission are across the 50 Ω LISN port.
3. AC conducted emission measurements is made over frequency range from 150 kHz to 30 MHz.
4. This measurement was performed with AC 120V/60Hz

3.1.3 Test Setup

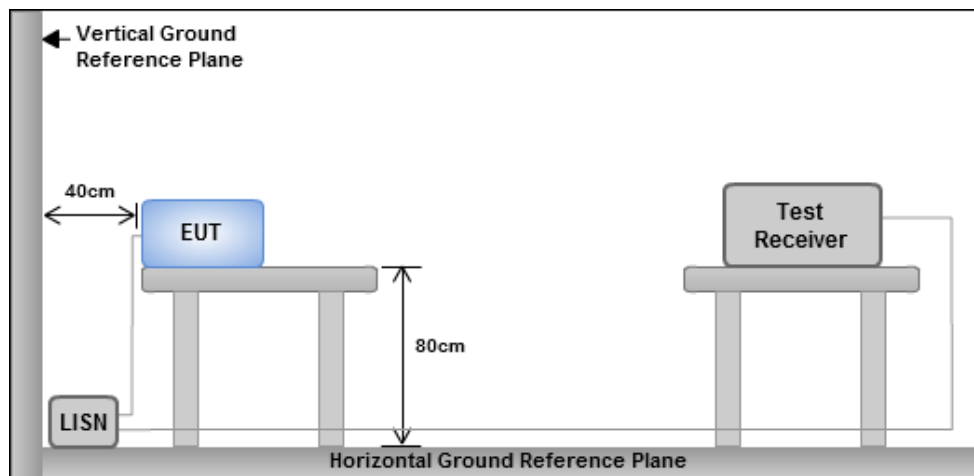

- Note: 1. Support units were connected to second LISN.
 2. Both of LISNs (AMN) are 80 cm from EUT and at least 80 cm from other units and other metal planes

3.1.4 Test Result of Conducted Emissions

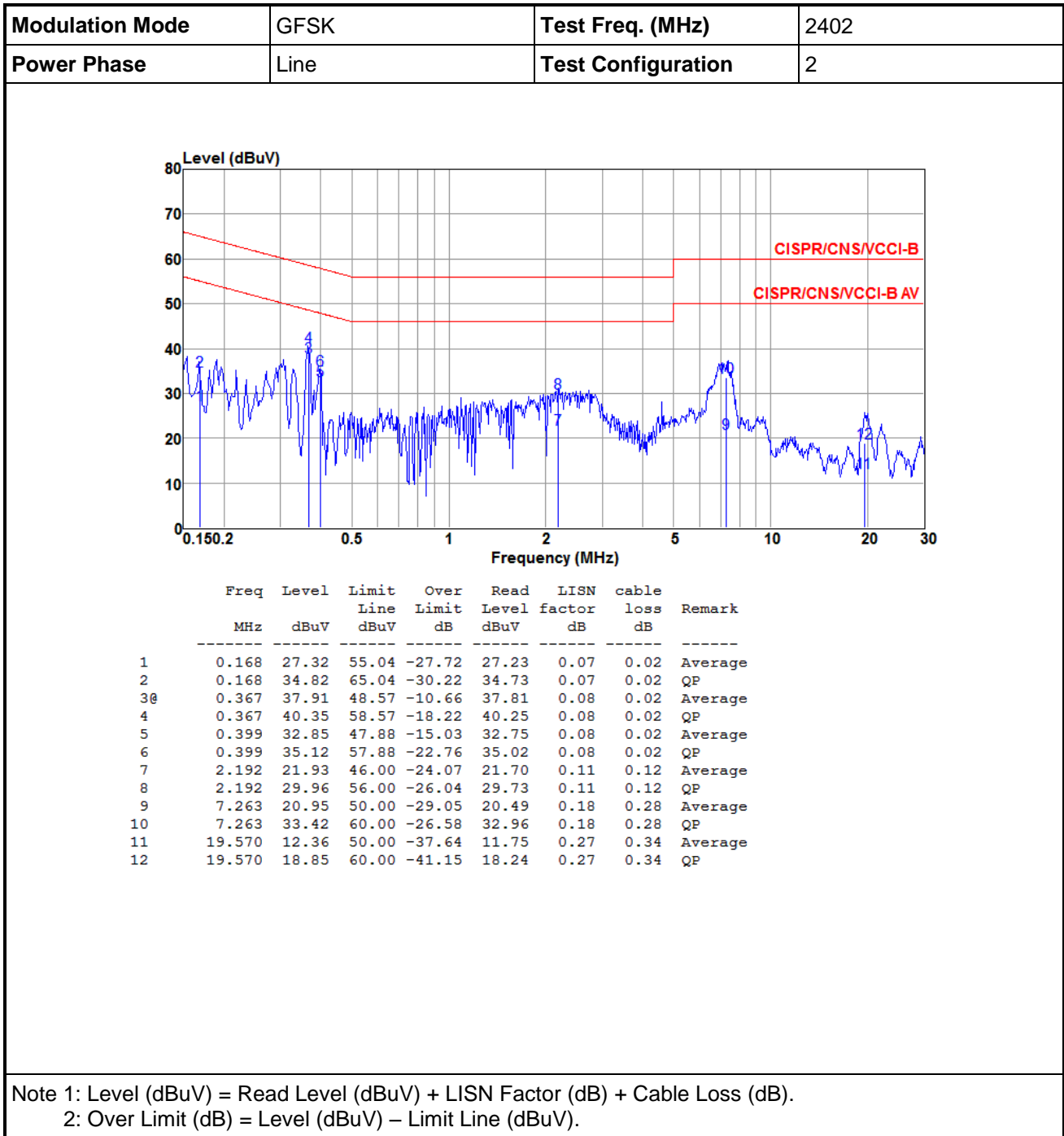

Modulation Mode	GFSK	Test Freq. (MHz)	2402
Power Phase	Neutral	Test Configuration	2

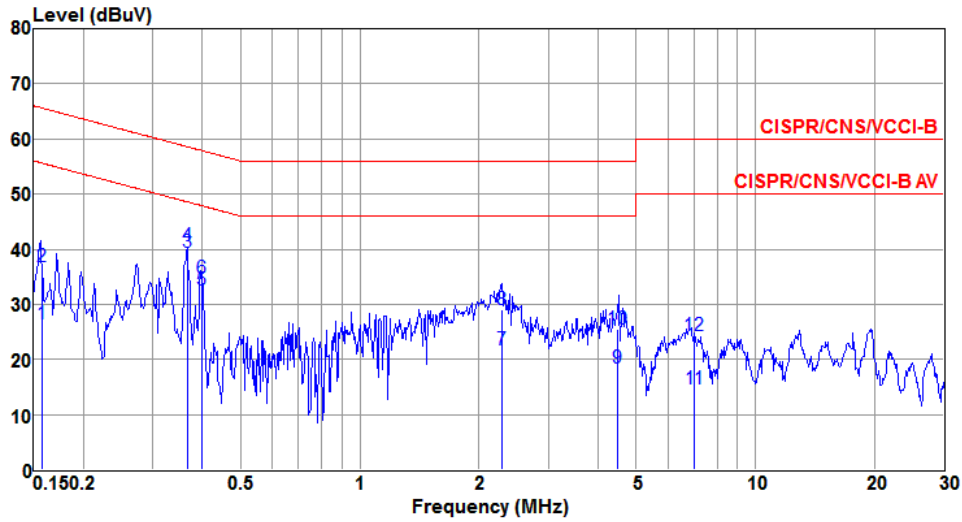

	Freq MHz	Level dBuV	Limit Line dBuV	Over Limit dB	Read Level dBuV	LISN factor dB	cable loss dB	Remark
1	0.157	26.45	55.60	-29.15	26.40	0.04	0.01	Average
2	0.157	36.87	65.60	-28.73	36.82	0.04	0.01	QP
3@	0.367	39.42	48.56	-9.14	39.36	0.04	0.02	Average
4	0.367	40.52	58.56	-18.04	40.46	0.04	0.02	QP
5	0.398	32.66	47.91	-15.25	32.60	0.04	0.02	Average
6	0.398	34.73	57.91	-23.18	34.67	0.04	0.02	QP
7	2.284	21.75	46.00	-24.25	21.56	0.07	0.12	Average
8	2.284	28.96	56.00	-27.04	28.77	0.07	0.12	QP
9	4.467	18.33	46.00	-27.67	18.00	0.10	0.23	Average
10	4.467	25.61	56.00	-30.39	25.28	0.10	0.23	QP
11	7.024	14.73	50.00	-35.27	14.31	0.14	0.28	Average
12	7.024	24.36	60.00	-35.64	23.94	0.14	0.28	QP

Note 1: Level (dBuV) = Read Level (dBuV) + LISN Factor (dB) + Cable Loss (dB).
 2: Over Limit (dB) = Level (dBuV) – Limit Line (dBuV).

3.2 6dB and Occupied Bandwidth

3.2.1 Limit of 6dB Bandwidth

The minimum 6dB bandwidth shall be at least 500 kHz.

3.2.2 Test Procedures

6dB Bandwidth

1. Set resolution bandwidth (RBW) = 100 kHz, Video bandwidth = 300 kHz.
2. Detector = Peak, Trace mode = max hold.
3. Sweep = auto couple, Allow the trace to stabilize.
4. Measure the maximum width of the emission that is constrained by the frequencies associated with the two outermost amplitude points (upper and lower) that are attenuated by 6dB relative to the maximum level measured in the fundamental emission.

Occupied Bandwidth

1. Set resolution bandwidth (RBW) = 1% ~ 5 % of OBW, Video bandwidth = 3 x RBW
2. Detector = Sample, Trace mode = max hold.
3. Sweep = auto couple, Allow the trace to stabilize.
4. Use the OBW measurement function of spectrum analyzer to measure the occupied bandwidth.

3.2.3 Test Setup

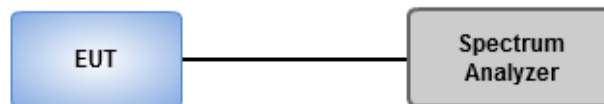

3.2.4 Test Result of 6dB and Occupied Bandwidth

Summary

Mode	Max-N dB (Hz)	Max-OBW (Hz)	ITU-Code	Min-N dB (Hz)	Min-OBW (Hz)
2.4-2.4835GHz	-	-	-	-	-
BT-LE(1Mbps)	688.406k	1.049M	1M05F1D	670.29k	1.038M

Max-N dB = Maximum 6dB down bandwidth; **Max-OBW** = Maximum 99% occupied bandwidth;

Min-N dB = Minimum 6dB down bandwidth; **Min-OBW** = Minimum 99% occupied bandwidth;

Result

Mode	Result	Limit (Hz)	Port 1-N dB (Hz)	Port 1-OBW (Hz)
BT-LE(1Mbps)	-	-	-	-
2402MHz	Pass	500k	673.913k	1.038M
2440MHz	Pass	500k	688.406k	1.038M
2480MHz	Pass	500k	670.29k	1.049M

Port X-N dB = Port X 6dB down bandwidth; **Port X-OBW** = Port X 99% occupied bandwidth;

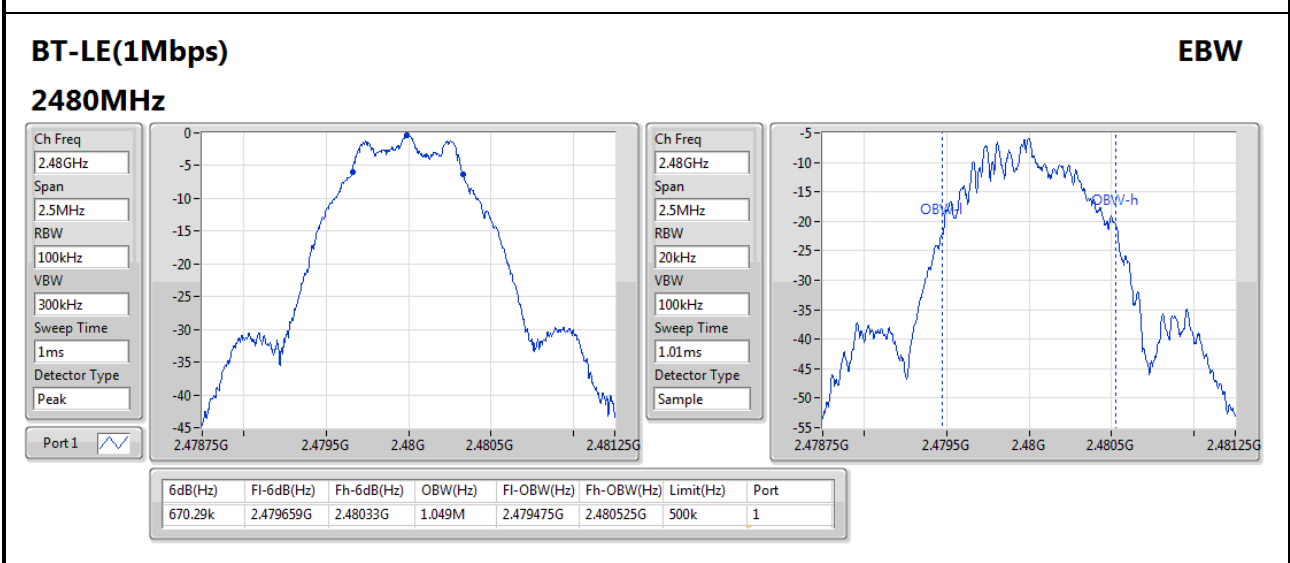
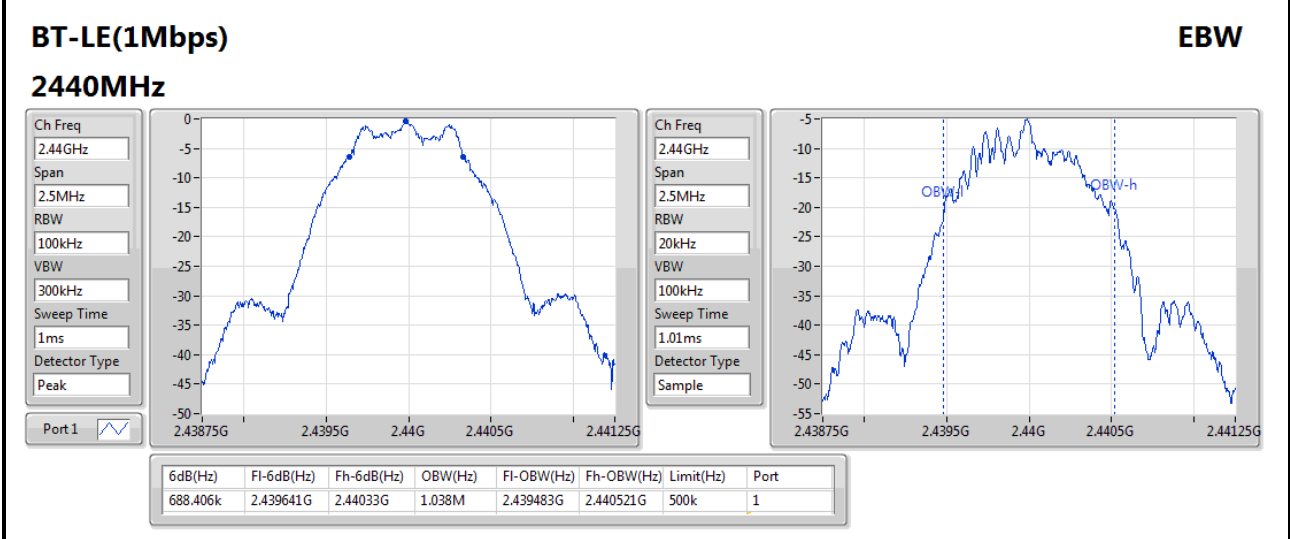
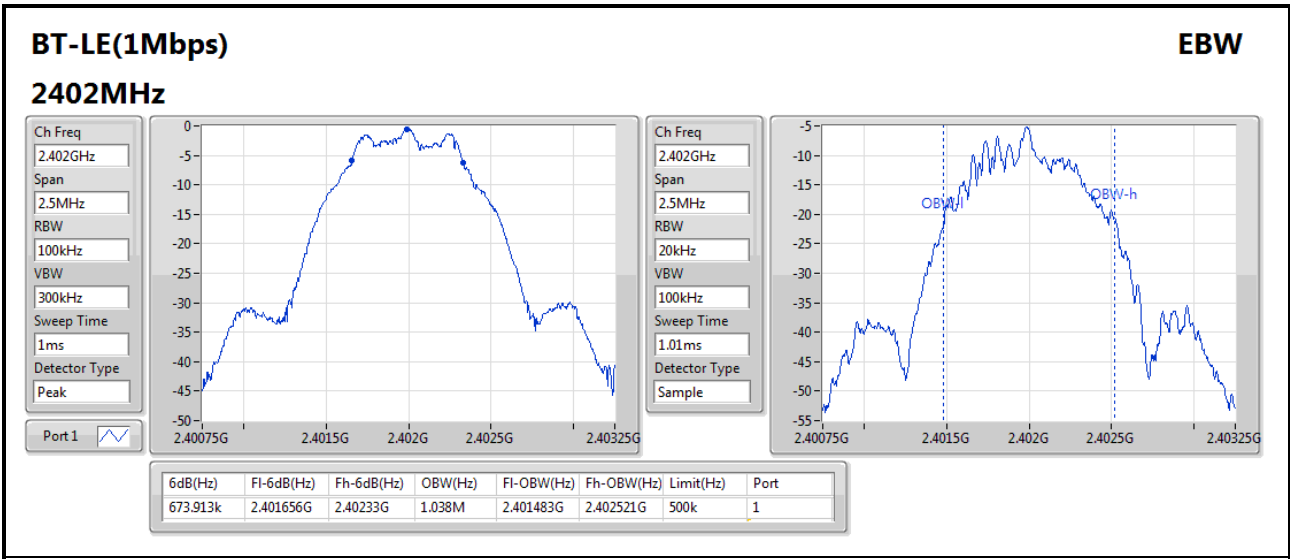

3.3 RF Output Power

3.3.1 Limit of RF Output Power

Conducted power shall not exceed 1Watt.

Antenna gain $\leq 6\text{dBi}$, no any corresponding reduction is in output power limit.

3.3.2 Test Procedures

A broadband RF power meter is used for output power measurement. The video bandwidth of power meter is greater than DTS bandwidth of EUT. If duty cycle of test signal is not 100 %, trigger and gating function of power meter will be enabled to capture transmission burst for measuring output power.

3.3.3 Test Setup

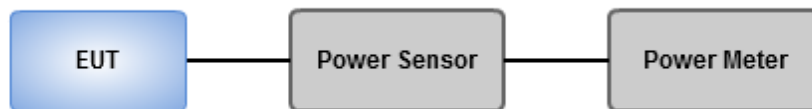

3.3.4 Test Result of Maximum Output Power

Summary

Mode	Power (dBm)	Power (W)
2.4-2.4835GHz	-	-
BT-LE(1Mbps)	-0.34	0.00092

Result

Mode	Result	Gain (dBi)	Power (dBm)	Power Limit (dBm)
BT-LE(1Mbps)	-	-	-	-
2402MHz	Pass	1.88	-0.34	30.00
2440MHz	Pass	1.88	-0.41	30.00
2480MHz	Pass	1.88	-0.45	30.00

Summary

Mode	Power (dBm)	Power (W)
2.4-2.4835GHz	-	-
BT-LE(1Mbps)	-0.38	0.00092

Result

Mode	Result	Gain (dBi)	Power (dBm)	Power Limit (dBm)
BT-LE(1Mbps)	-	-	-	-
2402MHz	Pass	1.88	-0.38	-
2440MHz	Pass	1.88	-0.45	-
2480MHz	Pass	1.88	-0.50	-

Note: Average power is for reference only.

3.4 Power Spectral Density

3.4.1 Limit of Power Spectral Density

Power spectral density shall not be greater than 8 dBm in any 3 kHz band.

3.4.2 Test Procedures

1. Set the RBW = 3 kHz, VBW = 10 kHz.
2. Detector = Peak, Sweep time = auto couple.
3. Trace mode = max hold, allow trace to fully stabilize.
4. Use the peak marker function to determine the maximum amplitude level.

3.4.3 Test Setup

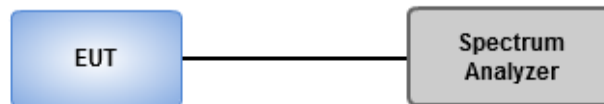

3.4.4 Test Result of Power Spectral Density

Summary

Mode	PD (dBm/RBW)
2.4-2.4835GHz	-
BT-LE(1Mbps)	-15.37

RBW=3kHz.

Result

Mode	Result	Gain (dBi)	PD (dBm/RBW)	PD Limit (dBm/RBW)
BT-LE(1Mbps)	-	-	-	-
2402MHz	Pass	1.88	-15.54	8.00
2440MHz	Pass	1.88	-15.48	8.00
2480MHz	Pass	1.88	-15.37	8.00

RBW=3kHz.

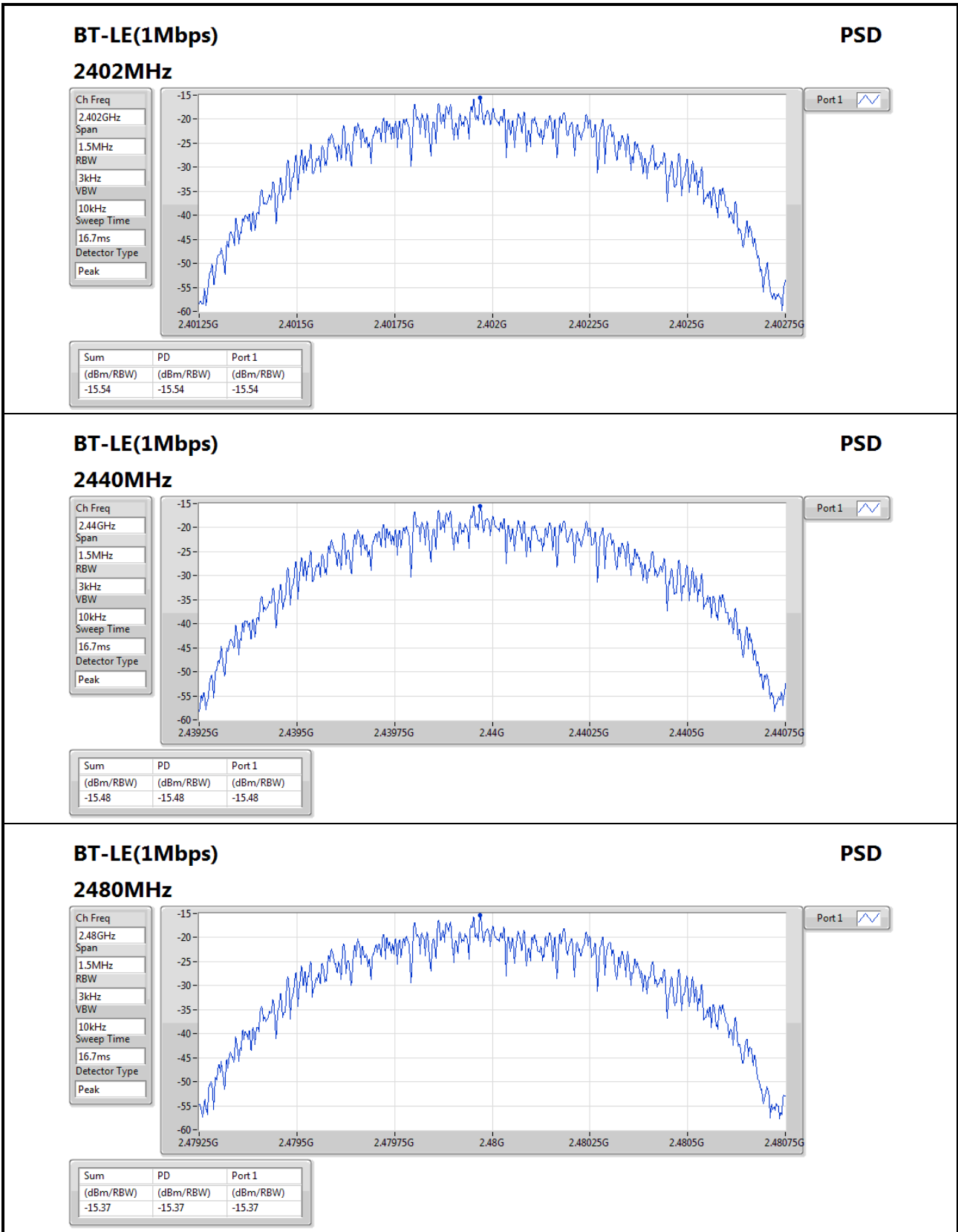

3.5 Emissions in Restricted Frequency Bands

3.5.1 Limit of Emissions in Restricted Frequency Bands

Restricted Band Emissions Limit			
Frequency Range (MHz)	Field Strength (uV/m)	Field Strength (dBuV/m)	Measure Distance (m)
0.009~0.490	2400/F(kHz)	48.5 - 13.8	300
0.490~1.705	24000/F(kHz)	33.8 - 23	30
1.705~30.0	30	29	30
30~88	100	40	3
88~216	150	43.5	3
216~960	200	46	3
Above 960	500	54	3

Note 1:
Quasi-Peak value is measured for frequency below 1GHz except for 9–90 kHz, 110–490 kHz frequency band. Peak and average value are measured for frequency above 1GHz. The limit on average radio frequency emission is as above table. The limit on peak radio frequency emissions is 20 dB above the maximum permitted average emission limit

Note 2:
Measurements may be performed at a distance other than what is specified provided. When performing measurements at a distance other than that specified, the results shall be extrapolated to the specified distance using an extrapolation factor as below, Frequency at or above 30 MHz: 20 dB/decade Frequency below 30 MHz: 40 dB/decade.

3.5.2 Test Procedures

1. Measurement is made at a semi-anechoic chamber that incorporates a turntable allowing a EUT rotation of 360°. A continuously-rotating, remotely-controlled turntable is installed at the test site to support the EUT and facilitate determination of the direction of maximum radiation for each EUT emission frequency. The EUT is placed at test table. For emissions testing at or below 1 GHz, the table height is 80 cm above the reference ground plane. For emission measurements above 1 GHz, the table height is 1.5 m
2. Measurement is made with the antenna positioned in both the horizontal and vertical planes of polarization. The measurement antenna is varied in height (1m ~ 4m) above the reference ground plane to obtain the maximum signal strength. Distance between EUT and antenna is 3 m.
3. This investigation is performed with the EUT rotated 360°, the antenna height scanned between 1 m and 4 m, and the antenna rotated to repeat the measurements for both the horizontal and vertical antenna polarizations.

Note:

1. 120kHz measurement bandwidth of test receiver and Quasi-peak detector is for radiated emission below 1GHz.
2. RBW=1MHz, VBW=3MHz and Peak detector is for peak measured value of radiated emission above 1GHz.
3. RBW=1MHz, VBW=1/T and Peak detector is for average measured value of radiated emission above 1GHz.

3.5.3 Test Setup

Radiated Emissions below 1 GHz

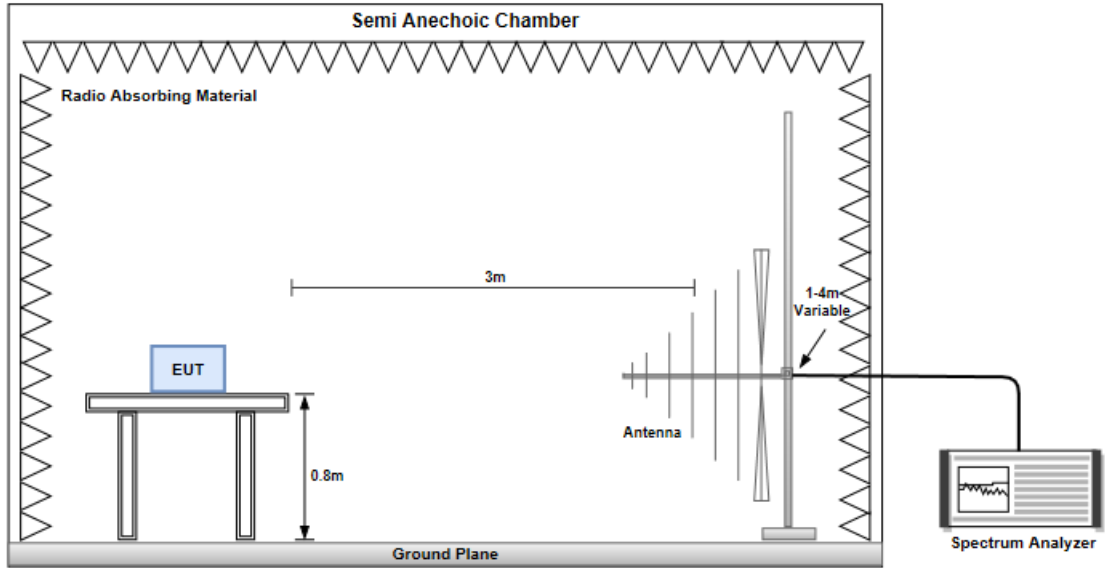

Radiated Emissions above 1 GHz

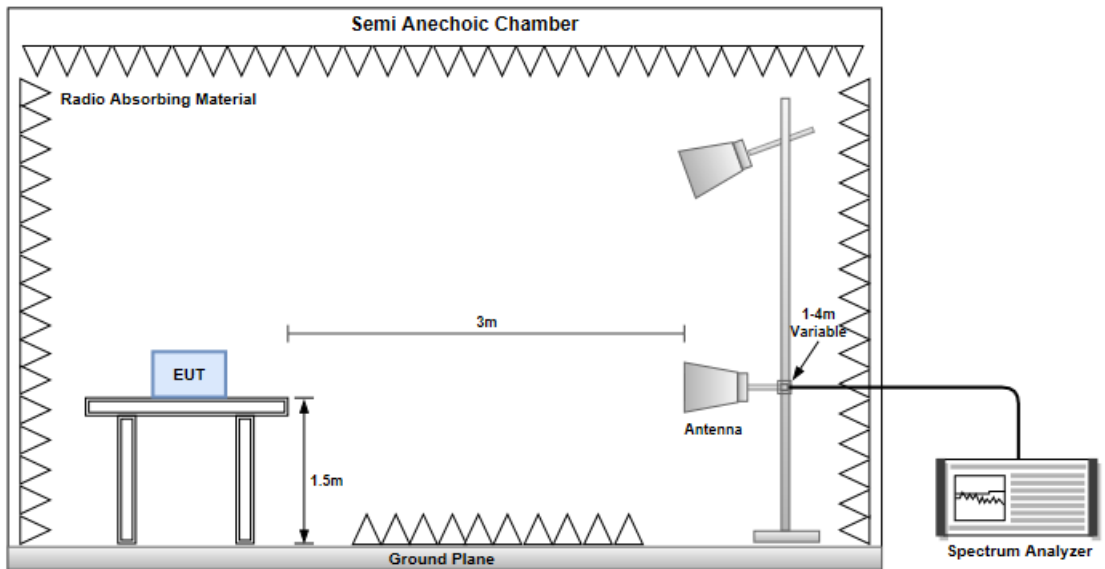

3.5.4 Transmitter Radiated Unwanted Emissions (Below 1GHz)

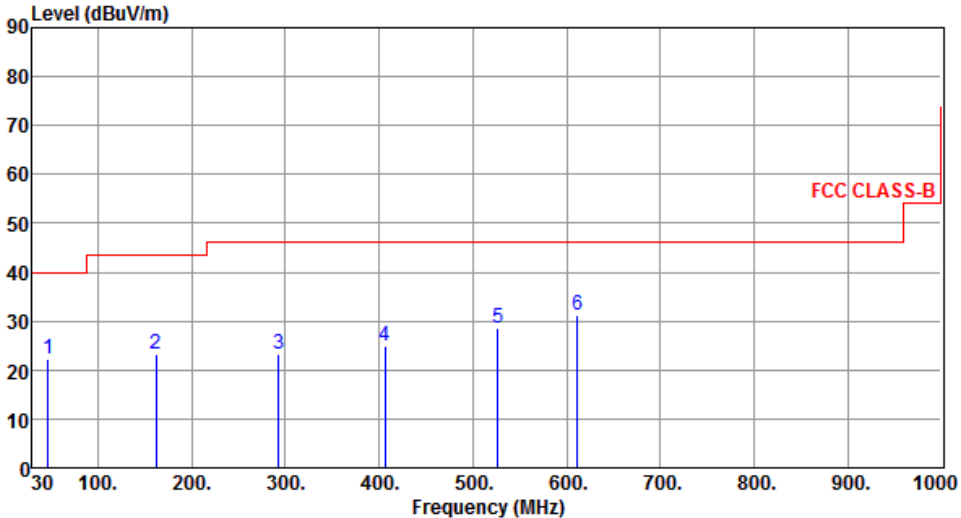
Modulation	GFSK	Test Freq. (MHz)	2402																																																																								
Polarization	Horizontal	Test Configuration	1																																																																								
																																																																											
	<table border="1"> <thead> <tr> <th>Freq.</th> <th>Emission level</th> <th>Limit</th> <th>Margin</th> <th>SA reading</th> <th>Factor</th> <th>Remark</th> <th>ANT High cm</th> <th>Turn Table deg</th> </tr> <tr> <th>MHz</th> <th>dBuV/m</th> <th>dBuV/m</th> <th>dB</th> <th>dBuV</th> <th>dB</th> <th></th> <th></th> <th></th> </tr> </thead> <tbody> <tr> <td>1</td> <td>46.49</td> <td>22.29</td> <td>40.00</td> <td>-17.71</td> <td>30.18</td> <td>-7.89</td> <td>Peak</td> <td>---</td> </tr> <tr> <td>2</td> <td>161.92</td> <td>23.21</td> <td>43.50</td> <td>-20.29</td> <td>31.56</td> <td>-8.35</td> <td>Peak</td> <td>---</td> </tr> <tr> <td>3</td> <td>292.87</td> <td>23.23</td> <td>46.00</td> <td>-22.77</td> <td>31.34</td> <td>-8.11</td> <td>Peak</td> <td>---</td> </tr> <tr> <td>4</td> <td>406.36</td> <td>25.00</td> <td>46.00</td> <td>-21.00</td> <td>30.17</td> <td>-5.17</td> <td>Peak</td> <td>---</td> </tr> <tr> <td>5</td> <td>526.64</td> <td>28.43</td> <td>46.00</td> <td>-17.57</td> <td>30.88</td> <td>-2.45</td> <td>Peak</td> <td>---</td> </tr> <tr> <td>6</td> <td>612.00</td> <td>31.12</td> <td>46.00</td> <td>-14.88</td> <td>31.84</td> <td>-0.72</td> <td>Peak</td> <td>---</td> </tr> </tbody> </table>	Freq.	Emission level	Limit	Margin	SA reading	Factor	Remark	ANT High cm	Turn Table deg	MHz	dBuV/m	dBuV/m	dB	dBuV	dB				1	46.49	22.29	40.00	-17.71	30.18	-7.89	Peak	---	2	161.92	23.21	43.50	-20.29	31.56	-8.35	Peak	---	3	292.87	23.23	46.00	-22.77	31.34	-8.11	Peak	---	4	406.36	25.00	46.00	-21.00	30.17	-5.17	Peak	---	5	526.64	28.43	46.00	-17.57	30.88	-2.45	Peak	---	6	612.00	31.12	46.00	-14.88	31.84	-0.72	Peak	---		
Freq.	Emission level	Limit	Margin	SA reading	Factor	Remark	ANT High cm	Turn Table deg																																																																			
MHz	dBuV/m	dBuV/m	dB	dBuV	dB																																																																						
1	46.49	22.29	40.00	-17.71	30.18	-7.89	Peak	---																																																																			
2	161.92	23.21	43.50	-20.29	31.56	-8.35	Peak	---																																																																			
3	292.87	23.23	46.00	-22.77	31.34	-8.11	Peak	---																																																																			
4	406.36	25.00	46.00	-21.00	30.17	-5.17	Peak	---																																																																			
5	526.64	28.43	46.00	-17.57	30.88	-2.45	Peak	---																																																																			
6	612.00	31.12	46.00	-14.88	31.84	-0.72	Peak	---																																																																			
<p>Note 1: Emission Level (dBuV/m) = SA Reading (dBuV/m) + Factor* (dB) *Factor includes antenna factor , cable loss and amplifier gain Note 2: Margin (dB) = Emission level (dBuV/m) – Limit (dBuV/m). Note 3: All spurious emissions below 30MHz are more than 20 dB below the limit.</p>																																																																											

Modulation	GFSK	Test Freq. (MHz)	2402
Polarization	Vertical	Test Configuration	1

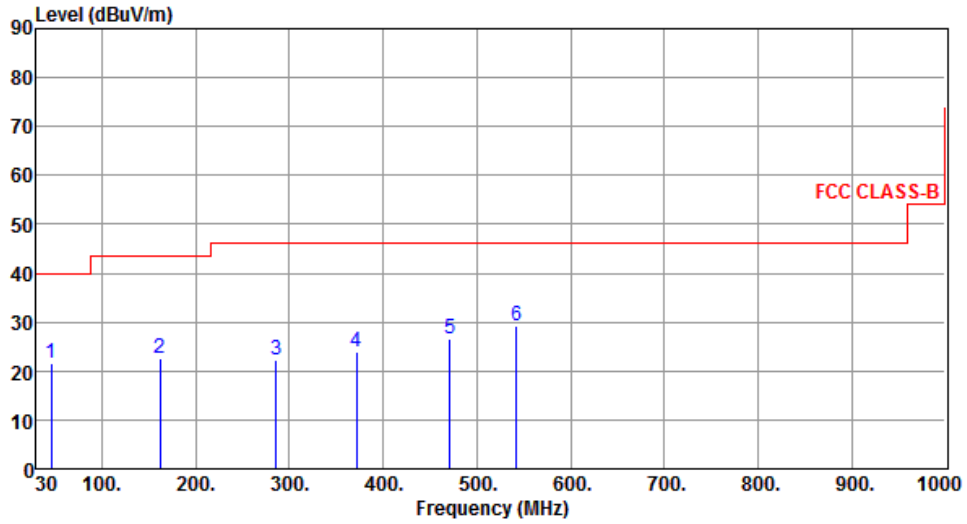

	Freq. MHz	Emission level dBuV/m	Limit dBuV/m	Margin dB	SA reading dBuV	Factor dB	Remark	ANT High cm	Turn Table deg
1	45.52	21.53	40.00	-18.47	29.43	-7.90	Peak	---	---
2	161.92	22.61	43.50	-20.89	30.96	-8.35	Peak	---	---
3	286.08	22.10	46.00	-23.90	30.28	-8.18	Peak	---	---
4	371.44	23.83	46.00	-22.17	29.79	-5.96	Peak	---	---
5	471.35	26.65	46.00	-19.35	30.43	-3.78	Peak	---	---
6	542.16	29.13	46.00	-16.87	31.36	-2.23	Peak	---	---

Note 1: Emission Level (dBuV/m) = SA Reading (dBuV/m) + Factor* (dB)

*Factor includes antenna factor , cable loss and amplifier gain

Note 2: Margin (dB) = Emission level (dBuV/m) – Limit (dBuV/m).

Note 3: All spurious emissions below 30MHz are more than 20 dB below the limit.

Modulation	GFSK	Test Freq. (MHz)	2402
Polarization	Horizontal	Test Configuration	2

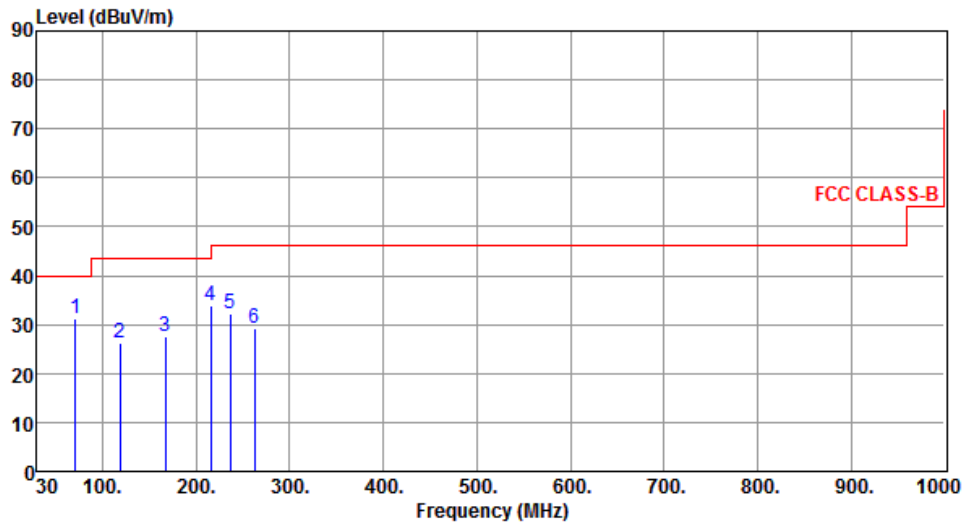

	Freq. MHz	Emission level dBUV/m	Limit dBUV/m	Margin dB	SA reading dBUV	Factor dB	Remark	ANT High cm	Turn Table deg
1	70.76	31.06	40.00	-8.94	42.07	-11.01	Peak	---	---
2	118.32	26.22	43.50	-17.28	37.08	-10.86	Peak	---	---
3	167.59	27.53	43.50	-15.97	36.02	-8.49	Peak	---	---
4	215.36	33.95	43.50	-9.55	44.89	-10.94	Peak	---	---
5	236.85	32.35	46.00	-13.65	42.24	-9.89	Peak	---	---
6	262.06	29.14	46.00	-16.86	38.20	-9.06	Peak	---	---

Note 1: Emission Level (dBUV/m) = SA Reading (dBUV/m) + Factor* (dB)

*Factor includes antenna factor , cable loss and amplifier gain

Note 2: Margin (dB) = Emission level (dBUV/m) – Limit (dBUV/m).

Note 3: All spurious emissions below 30MHz are more than 20 dB below the limit.

Modulation	GFSK	Test Freq. (MHz)	2402
Polarization	Vertical	Test Configuration	2

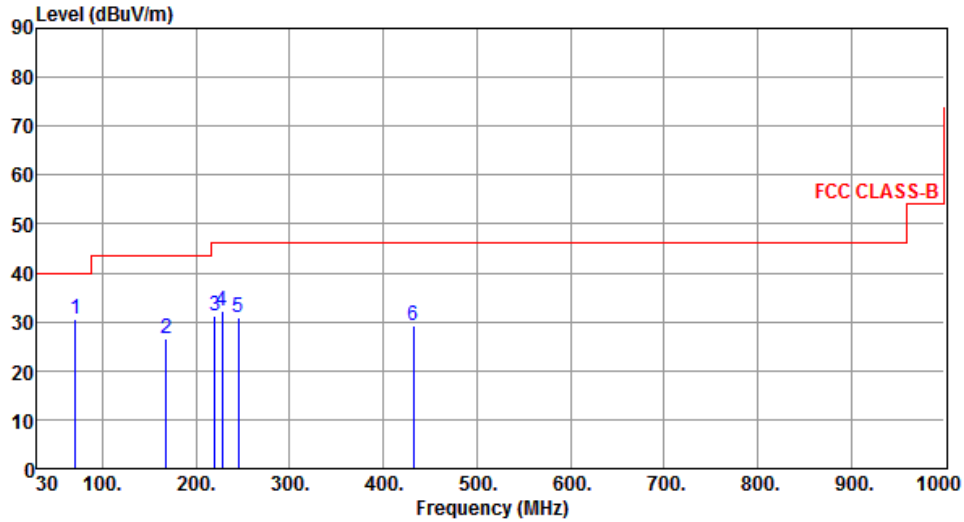

	Freq. MHz	Emission level dBuV/m	Limit dBuV/m	Margin dB	SA reading dBuV	Factor dB	Remark	ANT High cm	Turn Table deg
1	70.75	30.39	40.00	-9.61	41.40	-11.01	Peak	---	---
2	167.85	26.43	43.50	-17.07	34.94	-8.51	Peak	---	---
3	220.35	31.24	46.00	-14.76	42.17	-10.93	Peak	---	---
4	227.98	32.35	46.00	-13.65	42.97	-10.62	Peak	---	---
5	245.52	30.95	46.00	-15.05	40.53	-9.58	Peak	---	---
6	432.61	29.24	46.00	-16.76	33.77	-4.53	Peak	---	---

Note 1: Emission Level (dBuV/m) = SA Reading (dBuV/m) + Factor* (dB)

*Factor includes antenna factor , cable loss and amplifier gain

Note 2: Margin (dB) = Emission level (dBuV/m) – Limit (dBuV/m).

Note 3: All spurious emissions below 30MHz are more than 20 dB below the limit.

3.5.5 Transmitter Radiated Unwanted Emissions (Above 1GHz) for GFSK

Modulation	GFSK	Test Freq. (MHz)	2402
Polarization	Horizontal	Test Configuration	1

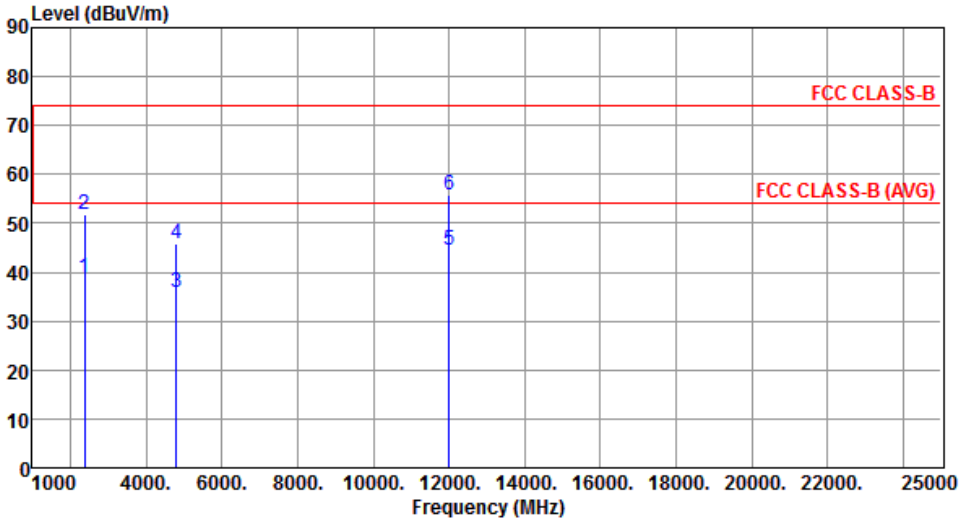

The graph plots Level (dBuV/m) on the y-axis (0 to 90) against Frequency (MHz) on the x-axis (1000 to 25000). Two horizontal red lines represent the FCC CLASS-B limit at approximately 74 dBuV/m and the FCC CLASS-B (AVG) limit at approximately 54 dBuV/m. Six vertical blue lines represent individual test results, labeled 1 through 6, with their peak values indicated at the top of each line.

	Freq. MHz	Emission level dBuV/m	Limit dBuV/m	Margin dB	SA reading dBuV	Factor dB	Remark	ANT High cm	Turn Table deg
1	2390.00	38.90	54.00	-15.10	42.41	-3.51	Average	296	185
2	2390.00	51.83	74.00	-22.17	55.34	-3.51	Peak	296	185
3	4804.00	35.70	54.00	-18.30	32.23	3.47	Average	305	2
4	4804.00	45.68	74.00	-28.32	42.21	3.47	Peak	305	2
5	12010.00	44.42	54.00	-9.58	31.08	13.34	Average	100	185
6	12010.00	55.79	74.00	-18.21	42.45	13.34	Peak	100	185

Note 1: Emission Level (dBuV/m) = SA Reading (dBuV/m) + Factor* (dB)
*Factor includes antenna factor , cable loss and amplifier gain
Note 2: Margin (dB) = Emission level (dBuV/m) – Limit (dBuV/m).

Modulation	GFSK	Test Freq. (MHz)	2402
Polarization	Vertical	Test Configuration	1

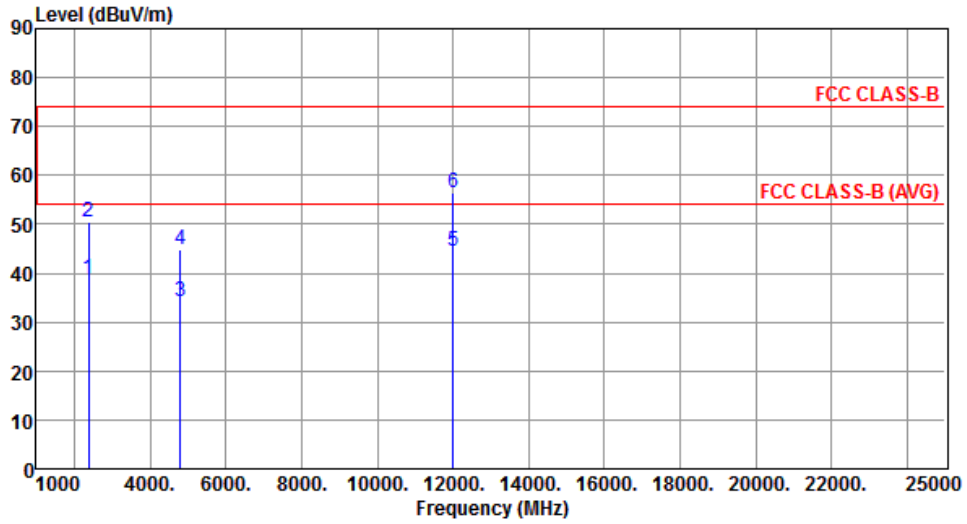

	Freq. MHz	Emission level dBuV/m	Limit dBuV/m	Margin dB	SA reading dBuV	Factor dB	Remark	ANT High cm	Turn Table deg
1	2390.00	38.97	54.00	-15.03	42.48	-3.51	Average	271	148
2	2390.00	50.60	74.00	-23.40	54.11	-3.51	Peak	271	148
3	4804.00	34.30	54.00	-19.70	30.83	3.47	Average	264	178
4	4804.00	44.80	74.00	-29.20	41.33	3.47	Peak	264	178
5	12010.00	44.34	54.00	-9.66	31.00	13.34	Average	100	302
6	12010.00	56.34	74.00	-17.66	43.00	13.34	Peak	100	302

Note 1: Emission Level (dBuV/m) = SA Reading (dBuV/m) + Factor* (dB)

*Factor includes antenna factor , cable loss and amplifier gain

Note 2: Margin (dB) = Emission level (dBuV/m) – Limit (dBuV/m).

Modulation	GFSK	Test Freq. (MHz)	2440
Polarization	Horizontal	Test Configuration	1

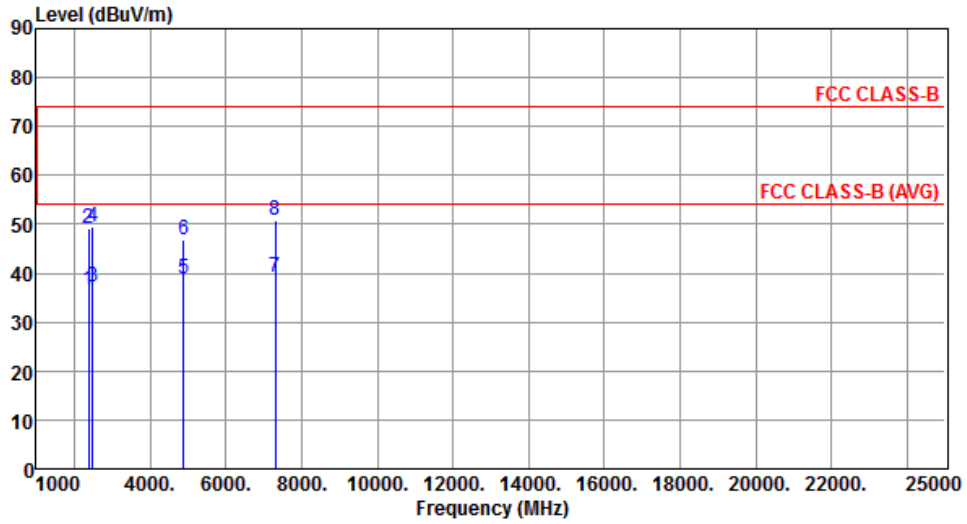

	Freq. MHz	Emission level dBuV/m	Limit dBuV/m	Margin dB	SA reading dBuV	Factor dB	Remark	ANT High cm	Turn Table deg
1	2390.00	36.52	54.00	-17.48	40.03	-3.51	Average	325	190
2	2390.00	49.31	74.00	-24.69	52.82	-3.51	Peak	325	190
3	2483.50	37.10	54.00	-16.90	40.21	-3.11	Average	325	190
4	2483.50	49.37	74.00	-24.63	52.48	-3.11	Peak	325	190
5	4880.00	38.81	54.00	-15.19	35.10	3.71	Average	295	7
6	4880.00	46.86	74.00	-27.14	43.15	3.71	Peak	295	7
7	7320.00	39.32	54.00	-14.68	30.90	8.42	Average	100	118
8	7320.00	50.82	74.00	-23.18	42.40	8.42	Peak	100	118

Note 1: Emission Level (dBuV/m) = SA Reading (dBuV/m) + Factor* (dB)

*Factor includes antenna factor , cable loss and amplifier gain

Note 2: Margin (dB) = Emission level (dBuV/m) – Limit (dBuV/m).

Modulation	GFSK	Test Freq. (MHz)	2440
Polarization	Vertical	Test Configuration	1

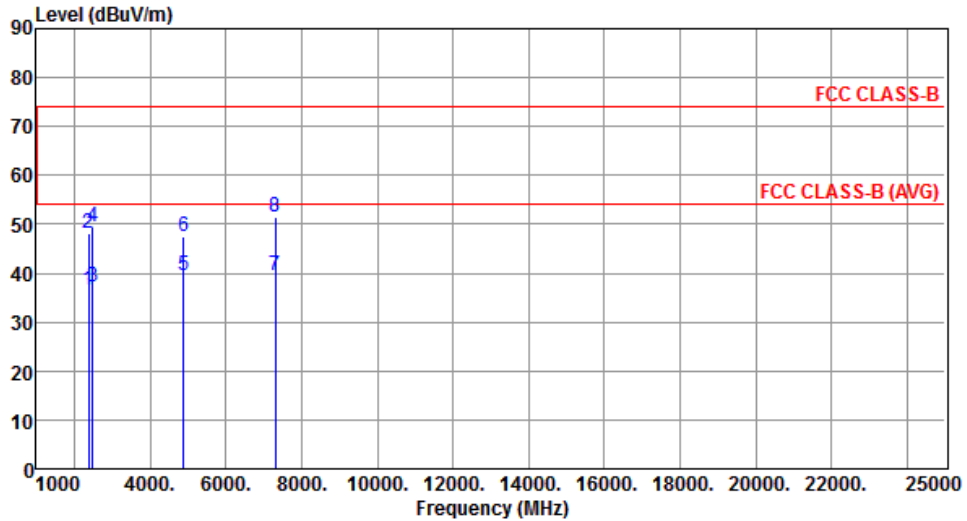

	Freq. MHz	Emission level dBuV/m	Limit dBuV/m	Margin dB	SA reading dBuV	Factor dB	Remark	ANT High cm	Turn Table deg
1	2390.00	36.65	54.00	-17.35	40.16	-3.51	Average	310	161
2	2390.00	48.26	74.00	-25.74	51.77	-3.51	Peak	310	161
3	2483.50	37.05	54.00	-16.95	40.16	-3.11	Average	310	161
4	2483.50	49.35	74.00	-24.65	52.46	-3.11	Peak	310	161
5	4880.00	39.51	54.00	-14.49	35.80	3.71	Average	247	185
6	4880.00	47.60	74.00	-26.40	43.89	3.71	Peak	247	185
7	7320.00	39.52	54.00	-14.48	31.10	8.42	Average	100	266
8	7320.00	51.42	74.00	-22.58	43.00	8.42	Peak	100	266

Note 1: Emission Level (dBuV/m) = SA Reading (dBuV/m) + Factor* (dB)

*Factor includes antenna factor , cable loss and amplifier gain

Note 2: Margin (dB) = Emission level (dBuV/m) – Limit (dBuV/m).

Modulation	GFSK	Test Freq. (MHz)	2480
Polarization	Horizontal	Test Configuration	1

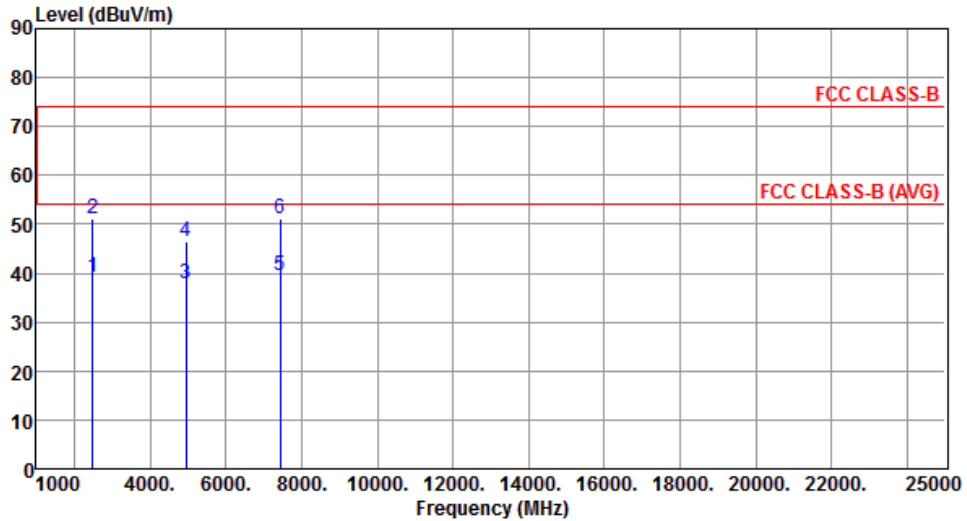

	Freq. MHz	Emission level dBuV/m	Limit dBuV/m	Margin dB	SA reading dBuV	Factor dB	Remark	ANT High cm	Turn Table deg
1	2483.50	39.28	54.00	-14.72	42.39	-3.11	Average	315	191
2	2483.50	51.21	74.00	-22.79	54.32	-3.11	Peak	315	191
3	4960.00	37.95	54.00	-16.05	33.99	3.96	Average	303	137
4	4960.00	46.48	74.00	-27.52	42.52	3.96	Peak	303	137
5	7440.00	39.55	54.00	-14.45	30.91	8.64	Average	100	122
6	7440.00	51.25	74.00	-22.75	42.61	8.64	Peak	100	122

Note 1: Emission Level (dBuV/m) = SA Reading (dBuV/m) + Factor* (dB)

*Factor includes antenna factor , cable loss and amplifier gain

Note 2: Margin (dB) = Emission level (dBuV/m) – Limit (dBuV/m).

Modulation	GFSK	Test Freq. (MHz)	2480
Polarization	Vertical	Test Configuration	1

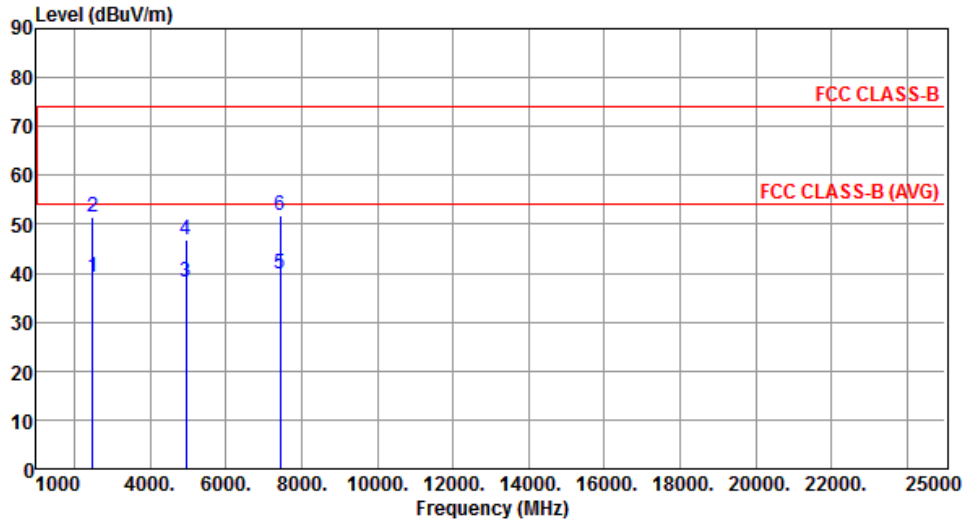

	Freq. MHz	Emission level dBuV/m	Limit dBuV/m	Margin dB	SA reading dBuV	Factor dB	Remark	ANT High cm	Turn Table deg
1	2483.50	39.22	54.00	-14.78	42.33	-3.11	Average	350	140
2	2483.50	51.47	74.00	-22.53	54.58	-3.11	Peak	350	140
3	4960.00	38.26	54.00	-15.74	34.30	3.96	Average	253	189
4	4960.00	46.81	74.00	-27.19	42.85	3.96	Peak	253	189
5	7440.00	39.83	54.00	-14.17	31.19	8.64	Average	100	262
6	7440.00	51.77	74.00	-22.23	43.13	8.64	Peak	100	262

Note 1: Emission Level (dBuV/m) = SA Reading (dBuV/m) + Factor* (dB)

*Factor includes antenna factor , cable loss and amplifier gain

Note 2: Margin (dB) = Emission level (dBuV/m) – Limit (dBuV/m).

3.6 Emissions in non-restricted Frequency Bands

3.6.1 Emissions in non-restricted frequency bands limit

Peak power in any 100 kHz bandwidth outside of the authorized frequency band shall be attenuated by at least 20 dB relative to the maximum in-band peak PSD level in 100 kHz.

3.6.2 Test Procedures

Reference level measurement

1. Set RBW=100kHz, VBW = 300kHz , Detector = Peak, Sweep time = Auto
2. Trace = max hold , Allow Trace to fully stabilize
3. Use the peak marker function to determine the maximum PSD level

Emission level measurement

1. Set RBW=100kHz, VBW = 300kHz , Detector = Peak, Sweep time = Auto
2. Trace = max hold , Allow Trace to fully stabilize
3. Scan Frequency range is up to 25GHz
4. Use the peak marker function to determine the maximum amplitude level

3.6.3 Test Setup

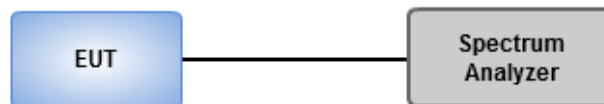

3.6.4 Test Result of Emissions in non-restricted Frequency Bands

Summary

Mode	Result	Ref (Hz)	Ref (dBm)	Limit (dBm)	Freq (Hz)	Level (dBm)	Freq (Hz)	Level (dBm)	Freq (Hz)	Level (dBm)	Freq (Hz)	Level (dBm)	Port
2.4-2.4835GHz	-	-	-	-	-	-	-	-	-	-	-	-	-
BT-LE(1Mbps)	Pass	2.401837G	-0.53	-20.53	2.15528G	-44.02	2.39964G	-43.79	2.48442G	-43.33	24.746712G	-45.49	1

Result

Mode	Result	Ref (Hz)	Ref (dBm)	Limit (dBm)	Freq (Hz)	Level (dBm)	Freq (Hz)	Level (dBm)	Freq (Hz)	Level (dBm)	Freq (Hz)	Level (dBm)	Port
BT-LE(1Mbps)	-	-	-	-	-	-	-	-	-	-	-	-	-
2402MHz	Pass	2.401837G	-0.53	-20.53	2.15528G	-44.02	2.39964G	-43.79	2.48442G	-43.33	24.746712G	-45.49	1
2440MHz	Pass	2.439913G	-0.61	-20.61	2.126864G	-44.45	2.399784G	-44.10	2.483876G	-43.75	24.952157G	-45.53	1
2480MHz	Pass	2.479993G	-0.52	-20.52	2.00136G	-44.08	2.398544G	-44.22	2.485116G	-43.39	24.811441G	-45.79	1

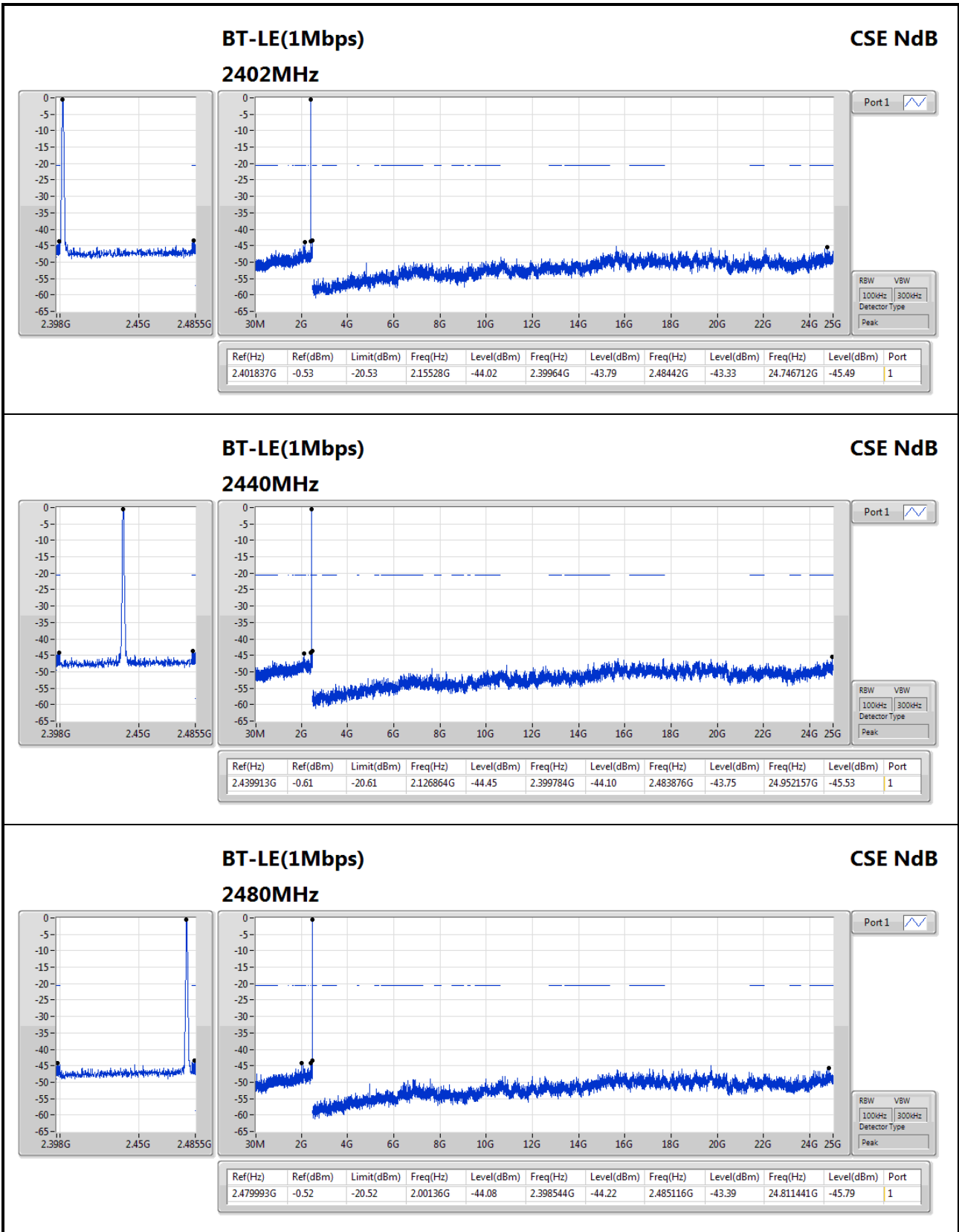

4 Test laboratory information

Established in 2012, ICC provides foremost EMC & RF Testing and advisory consultation services by our skilled engineers and technicians. Our services employ a wide variety of advanced edge test equipment and one of the widest certification extents in the business.

International Certification Corp (EMC and Wireless Communication Laboratory), it is our definitive objective is to institute long term, trust-based associations with our clients. The expectation we set up with our clients is based on outstanding service, practical expertise and devotion to a certified value structure. Our passion is to grant our clients with best EMC / RF services by oriented knowledgeable and accommodating staff.

Our Test sites are located at Linkou District and Kwei Shan District. Location map can be found on our website <http://www.icertifi.com.tw>.

Linkou

Tel: 886-2-2601-1640

No. 30-2, Ding Fwu Tsuen, Lin
Kou District, New Taipei City,
Taiwan, R.O.C.

Kwei Shan

Tel: 886-3-271-8666

No. 3-1, Lane 6, Wen San 3rd St.,
Kwei Shan District, Tao Yuan City
333, Taiwan, R.O.C.

Kwei Shan Site II

Tel: 886-3-271-8640

No. 14-1, Lane 19, Wen San 3rd
St., Kwei Shan District, Tao Yuan
City 333, Taiwan, R.O.C.

If you have any suggestion, please feel free to contact us as below information.

Tel: 886-3-271-8666

Fax: 886-3-318-0155

Email: ICC_Service@icertifi.com.tw

==END==