



RADIO TEST REPORT
FCC ID: XN6-SB3821-C6TX
IC: 8819A-SB3821C6TX

Product : 38" Sound Bar 2.1 System
Trade Name : VIZIO
Model Name : SB3821-C6 Soundbar
Serial Model : N/A
Report No. : NTEK-2014NT1119826F2

Prepared for

Zylux Acoustic Corporation
3F, 22, Lane 35, Jihu Road, Taipei Neihu Technology Park, 114 Taipei
Taiwan-R.O.C

Prepared by

Shenzhen NTEK Testing Technology Co., Ltd.
1/F, Building E, Fenda Science Park, Sanwei Community, Xixiang Street
Bao'an District, Shenzhen P.R. China
Tel.: +86-0755-61156588 Fax.: +86-0755-61156599
Website: www.ntek.org.cn

TEST RESULT CERTIFICATION

Applicant's name Zylux Acoustic Corporation

Address 3F,22,Lane 35,Jihu Road,Taipei Neihu Technology Park,
114 Taipei Taiwan-R.O.C

Manufacturer's Name... Zhao Yang Electronic(Shenzhen)Co., Ltd.

Address Sec.A, 4F, Building 1&2, De Yong Jia Ind. Park, GuangQiao Rd. Yu Lv
Com., GongMing St. 518100 Guang Ming New Distr., Shenzhen, China

Product description

Product name 38"Sound Bar 2.1 System

Model and/or type reference SB3821-C6 Soundbar

Serial Model N/A

Standards FCC Part15.247:01 Oct. 2014
IC RSS-210,Issue 8, December 2010

Test procedure ANSI C63.4-2003
RSS-Gen ISSUE 4 November 2014 and KDB 558074:June 5, 2014,
RSS-210 Issue 8 Dec 2010

This device described above has been tested by NTEK, and the test results show that the equipment under test (EUT) is in compliance with the FCC requirements/ the Industry Canada requirements. And it is applicable only to the tested sample identified in the report.

This report shall not be reproduced except in full, without the written approval of NTEK, this document may be altered or revised by NTEK, personal only, and shall be noted in the revision of the document.

Date of Test

Date (s) of performance of tests 19 Nov. 2014 ~28 Nov. 2014

Date of Issue 28 Nov. 2014

Test Result **Pass**

Testing Engineer :

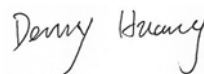

Denny Huang

Technical Manager :

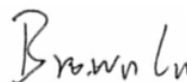

(Brown Lu)

Authorized Signatory :



(Bill Yao)

Table of Contents

	Page
1 . SUMMARY OF TEST RESULTS	5
1.1 TEST FACILITY	6
1.2 MEASUREMENT UNCERTAINTY	6
2 . GENERAL INFORMATION	7
2.1 GENERAL DESCRIPTION OF EUT	7
2.2 DESCRIPTION OF TEST MODES	9
2.3 BLOCK DIGRAM SHOWING THE CONFIGURATION OF SYSTEM TESTED	10
2.4 DESCRIPTION OF SUPPORT UNITS(CONDUCTED MODE)	11
2.5 EQUIPMENTS LIST FOR ALL TEST ITEMS	12
3 . EMC EMISSION TEST	13
3.1 CONDUCTED EMISSION MEASUREMENT	13
3.1.1 POWER LINE CONDUCTED EMISSION LIMITS	13
3.1.2 TEST PROCEDURE	14
3.1.3 DEVIATION FROM TEST STANDARD	14
3.1.4 TEST SETUP	14
3.1.5 EUT OPERATING CONDITIONS	14
3.1.6 TEST RESULTS	15
3.2 RADIATED EMISSION MEASUREMENT	19
3.2.1 RADIATED EMISSION LIMITS	19
3.2.2 TEST PROCEDURE	20
3.2.3 DEVIATION FROM TEST STANDARD	20
3.2.4 TEST SETUP	21
3.2.5 EUT OPERATING CONDITIONS	22
3.2.6 TEST RESULTS (BETWEEN 9KHZ – 30 MHZ)	23
3.2.7 TEST RESULTS (BETWEEN 30MHZ – 1GHZ)	24
3.2.8 TEST RESULTS (ABOVE 1000 MHZ)	28
4 . POWER SPECTRAL DENSITY TEST	30
4.1 APPLIED PROCEDURES / LIMIT	30
4.1.1 TEST PROCEDURE	30
4.1.2 DEVIATION FROM STANDARD	30
4.1.3 TEST SETUP	30
4.1.4 EUT OPERATION CONDITIONS	30
4.1.5 TEST RESULTS	31
5 . BANDWIDTH TEST	33
5.1 APPLIED PROCEDURES / LIMIT	33
5.1.1 TEST PROCEDURE	33

Table of Contents

	Page
5.1.2 EUT OPERATION CONDITIONS	33
5.1.3 TEST RESULTS	34
6 . MAX CONDUCTED OUTPUT POWER TEST	36
6.1 APPLIED PROCEDURES / LIMIT	36
6.1.1 TEST PROCEDURE	36
6.1.2 DEVIATION FROM STANDARD	36
6.1.3 TEST SETUP	36
6.1.4 EUT OPERATION CONDITIONS	36
6.1.5 TEST RESULTS	37
7 . 100 KHZ BANDWIDTH OF FREQUENCY BAND EDGE	38
7.1 DEVIATION FROM STANDARD	38
7.2 TEST SETUP	38
7.3 EUT OPERATION CONDITIONS	38
7.4 TEST RESULTS	39
8 . ANTENNA REQUIREMENT	41
8.1 STANDARD REQUIREMENT	41
8.2 EUT ANTENNA	41
9 . EUT TEST PHOTO	42
APPENDIX-PHOTOGRAPHS OF EUT CONSTRUCTIONAL DETAILS	

1. SUMMARY OF TEST RESULTS

Test procedures according to the technical standards:

FCC Part15 (15.247) , Subpart C/ RSS-210 & RSS-Gen Rules			
Standard Section	Test Item	Judgment	Remark
15.207/ RSS-Gen §7.2.4	Conducted Emission	PASS	
15.247 (a)(2)/ RSS-Gen§4.6.1&RSS-210§A8.2 (a)	99% Occupied Bandwidth & 6dB Bandwidth	PASS	
15.247 (b)/ RSS-210 §A8.4 (4)	Peak Output Power	PASS	
15.247 (c)/ RSS-210 §2.2, §A8.5	Radiated Spurious Emission	PASS	
15.247 (d)/ RSS-210 §A8.2 (b)	Power Spectral Density	PASS	
15.205/ RSS-210 §2.2, §A8.5	Band Edge Emission	PASS	
15.203/ RSS-Gen §7.1.2	Antenna Requirement	PASS	

NOTE:

(1) " N/A " denotes test is not applicable in this Test Report

1.1 TEST FACILITY

NTEK Testing Technology Co., Ltd

Add.:1/F, Building E, Fenda Science Park, Sanwei Community, Xixiang Street, Bao'an District, Shenzhen P.R. China.

FCC Registration No.:238937; IC Registration No.:9270A-1

CNAS Registration No.:L5516

1.2 MEASUREMENT UNCERTAINTY

The reported uncertainty of measurement $y \pm U$, where expanded uncertainty U is based on a standard uncertainty multiplied by a coverage factor of $k=2$, providing a level of confidence of approximately 95 %.

No.	Item	Uncertainty
1	Conducted Emission Test	$\pm 1.38\text{dB}$
2	RF power,conducted	$\pm 0.16\text{dB}$
3	Spurious emissions,conducted	$\pm 0.21\text{dB}$
4	All emissions,radiated(<1G)	$\pm 4.68\text{dB}$
5	All emissions,radiated(>1G)	$\pm 4.89\text{dB}$
6	Temperature	$\pm 0.5^{\circ}\text{C}$
7	Humidity	$\pm 2\%$

2. GENERAL INFORMATION

2.1 GENERAL DESCRIPTION OF EUT

Equipment	38"Sound Bar 2.1 System	
Trade Name	VIZIO	
Model Name	SB3821-C6 Soundbar	
Serial Model	N/A	
Model Difference	N/A	
Product Description	The EUT is a 38"Sound Bar 2.1 System	
	Operation Frequency:	2402~2480MHz
	Modulation Type:	GFSK
	Number Of Channel	40CH
	Antenna Designation:	Please see Note 3.
	Antenna Gain (dBi)	1.0dbi
Channel List	Please refer to the Note 2.	
Ratings	AC 120V,60Hz	
Adapter	Adapter 1: main test Adapter 2: Deputy test	
Battery	N/A	
Connecting I/O Port(s)	Please refer to the User's Manual	

Note:

1. For a more detailed features description, please refer to the manufacturer's specifications or the User's Manual.

2.

Channel	Frequency (MHz)
00	2402
01	2404
.....
.....
.....	...
.....
38	2478
39	2480

3.

Table for Filed Antenna

Ant	Brand	Model Name	Antenna Type	Connector	Gain (dBi)	NOTE
A	N/A	N/A	PCB Antenna	N/A	1.0	BT Antenna

2.2 DESCRIPTION OF TEST MODES

To investigate the maximum EMI emission characteristics generates from EUT, the test system was pre-scanning tested base on the consideration of following EUT operation mode or test configuration mode which possible have effect on EMI emission level. Each of these EUT operation mode(s) or test configuration mode(s) mentioned above was evaluated respectively.

Pretest Mode	Description
Mode 1	CH00
Mode 2	CH19
Mode 3	CH39
Mode 4	Keeping TX mode

For Conducted Emission	
Final Test Mode	Description
Mode 4	Keeping TX mode

For Radiated Emission	
Final Test Mode	Description
Mode 1	CH00
Mode 2	CH19
Mode 3	CH39
Mode 4	Keeping TX mode

Note:

- (1) The measurements are performed at the highest, middle, lowest available channels.
- (2) The measurements are performed at all Bit Rate of Transmitter, the worst data was reported

2.3 BLOCK DIGRAM SHOWING THE CONFIGURATION OF SYSTEM TESTED

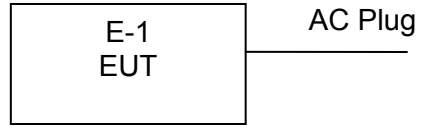

2.4 DESCRIPTION OF SUPPORT UNITS(CONDUCTED MODE)

The EUT has been tested as an independent unit together with other necessary accessories or support units. The following support units or accessories were used to form a representative test configuration during the tests.

Item	Equipment	Brand	Model/Type No.	Series No.	Note
E-1	38"Sound Bar 2.1 System	VIZIO	SB3821-C6 Soundbar	N/A	EUT

Item	Shielded Type	Ferrite Core	Length	Note

Note:

- (1) The support equipment was authorized by Declaration of Confirmation.
- (2) For detachable type I/O cable should be specified the length in cm in 『Length』 column.

2.5 EQUIPMENTS LIST FOR ALL TEST ITEMS

Radiation Test equipment

Item	Kind of Equipment	Manufacturer	Type No.	Serial No.	Last calibration	Calibrated until	Calibration period
1	Spectrum Analyzer	Agilent	E4407B	MY45108040	2014.07.06	2015.07.05	1 year
2	Test Receiver	R&S	ESPI	101318	2014.06.07	2015.06.06	1 year
3	Bilog Antenna	TESEQ	CBL6111D	31216	2014.07.06	2015.07.05	1 year
4	50Ω Coaxial Switch	Anritsu	MP59B	6200264416	2014.06.07	2015.06.06	1 year
5	Spectrum Analyzer	ADVANTEST	R3132	150900201	2014.06.07	2015.06.06	1 year
6	Horn Antenna	EM	EM-AH-10180	2011071402	2014.07.06	2015.07.05	1 year
7	Horn Ant	Schwarzbeck	BBHA 9170	9170-181	2014.07.06	2015.07.05	1 year
8	Amplifier	EM	EM-30180	060538	2013.12.22	2014.12.21	1 year
9	Loop Antenna	ARA	PLA-1030/B	1029	2014.06.08	2015.06.07	1 year
10	Power Meter	R&S	NRVS	100696	2014.07.06	2015.07.05	1 year
11	Power Sensor	R&S	URV5-Z4	0395.1619.05	2014.07.06	2015.07.05	1 year

Conduction Test equipment

Item	Kind of Equipment	Manufacturer	Type No.	Serial No.	Last calibration	Calibrated until	Calibration period
1	Test Receiver	R&S	ESCI	101160	2014.06.06	2015.06.05	1 year
2	LISN	R&S	ENV216	101313	2014.08.24	2015.08.23	1 year
3	LISN	EMCO	3816/2	00042990	2014.08.24	2015.08.23	1 year
4	50Ω Coaxial Switch	Anritsu	MP59B	6200264417	2014.06.07	2015.06.06	1 year
5	Passive Voltage Probe	R&S	ESH2-Z3	100196	2014.06.07	2015.06.06	1 year
6	Absorbing clamp	R&S	MOS-21	100423	2014.06.08	2015.06.07	1 year

1	Attenuation	MCE	24-10-34	BN9258	2014.06.08	2015.06.07	1 year
---	-------------	-----	----------	--------	------------	------------	--------

3. EMC EMISSION TEST

3.1 CONDUCTED EMISSION MEASUREMENT

3.1.1 POWER LINE CONDUCTED EMISSION Limits (Frequency Range 150KHz-30MHz)

FREQUENCY (MHz)	Class A (dBuV)		Class B (dBuV)		Standard
	Quasi-peak	Average	Quasi-peak	Average	
0.15 -0.5	79.00	66.00	66 - 56 *	56 - 46 *	CISPR
0.50 -5.0	73.00	60.00	56.00	46.00	CISPR
5.0 -30.0	73.00	60.00	60.00	50.00	CISPR

0.15 -0.5	79.00	66.00	66 - 56 *	56 - 46 *	FCC/ RSS-210
0.50 -5.0	73.00	60.00	56.00	46.00	FCC/ RSS-210
5.0 -30.0	73.00	60.00	60.00	50.00	FCC/ RSS-210

Note:

- (1) The tighter limit applies at the band edges.
- (2) The limit of " * " marked band means the limitation decreases linearly with the logarithm of the frequency in the range.

The following table is the setting of the receiver

Receiver Parameters	Setting
Attenuation	10 dB
Start Frequency	0.15 MHz
Stop Frequency	30 MHz
IF Bandwidth	9 kHz

3.1.2 TEST PROCEDURE

- a. The EUT was placed 0.8 meters from the horizontal ground plane with EUT being connected to the power mains through a line impedance stabilization network (LISN). All other support equipments powered from additional LISN(s). The LISN provide 50 Ohm/ 50uH of coupling impedance for the measuring instrument.
- b. Interconnecting cables that hang closer than 40 cm to the ground plane shall be folded back and forth in the center forming a bundle 30 to 40 cm long.
- c. I/O cables that are not connected to a peripheral shall be bundled in the center. The end of the cable may be terminated, if required, using the correct terminating impedance. The overall length shall not exceed 1 m.
- d. LISN at least 80 cm from nearest part of EUT chassis.
- e. For the actual test configuration, please refer to the related Item –EUT Test Photos.

3.1.3 DEVIATION FROM TEST STANDARD

No deviation

3.1.4 TEST SETUP

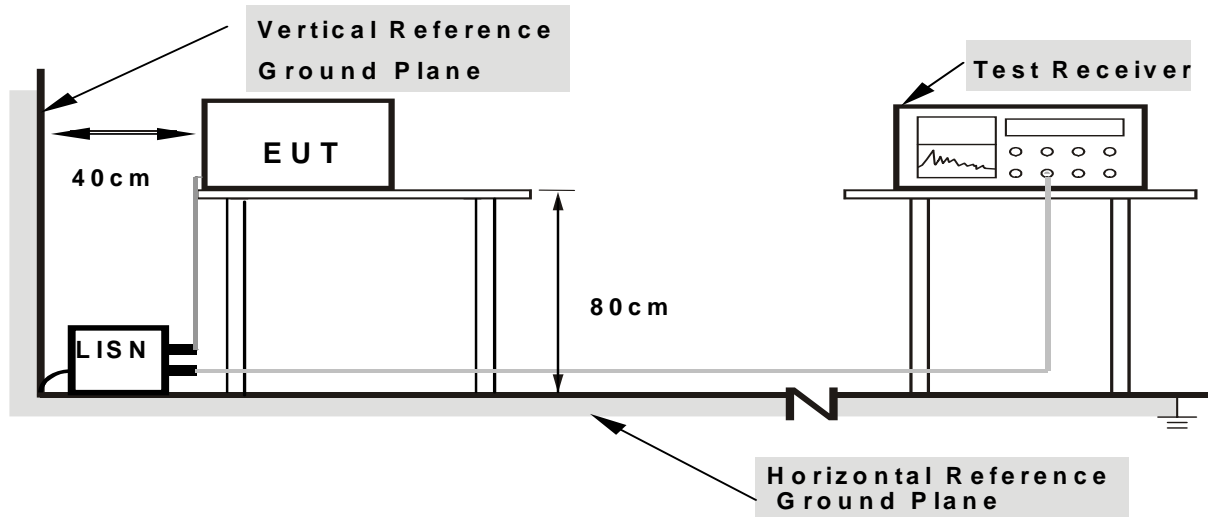

- Note:**
- 1. Support units were connected to second LISN.
 - 2. Both of LISNs (AMN) are 80 cm from EUT and at least 80 from other units and other metal planes

3.1.5 EUT OPERATING CONDITIONS

The EUT was configured for testing in a typical fashion (as a customer would normally use it). The EUT has been programmed to continuously transmit during test. This operating condition was tested and used to collect the included data.

3.1.6 TEST RESULTS

EUT :	38" Sound Bar 2.1 System	Model Name. :	SB3821-C6 Soundbar
Temperature :	26 °C	Relative Humidity :	56%
Pressure :	1010hPa	Phase :	L
Test Voltage :	AC 120V/60Hz- Adapter 1	Test Mode :	Mode 4

Frequency (MHz)	Meter Reading (dBμV)	Factor (dB)	Emission Level (dBμV)	Limits (dBμV)	Margin (dB)	Remark
0.2058	44.58	9.47	54.05	63.37	-9.32	QP
0.2058	25.81	9.47	35.28	53.37	-18.09	AVG
0.4020	37.63	9.45	47.08	57.81	-10.73	QP
0.4020	30.17	9.45	39.62	47.81	-8.19	AVG
0.5140	35.39	9.47	44.86	56.00	-11.14	QP
0.5140	26.39	9.47	35.86	46.00	-10.14	AVG
1.0260	31.91	9.46	41.37	56.00	-14.63	QP
1.0260	26.52	9.46	35.98	46.00	-10.02	AVG
3.0739	30.00	9.45	39.45	56.00	-16.55	QP
3.0739	22.14	9.45	31.59	46.00	-14.41	AVG
21.506	33.71	9.80	43.51	60.00	-16.49	QP
21.506	28.01	9.80	37.81	50.00	-12.19	AVG

Remark:

1. All readings are Quasi-Peak and Average values.
2. Factor = Insertion Loss + Cable Loss.

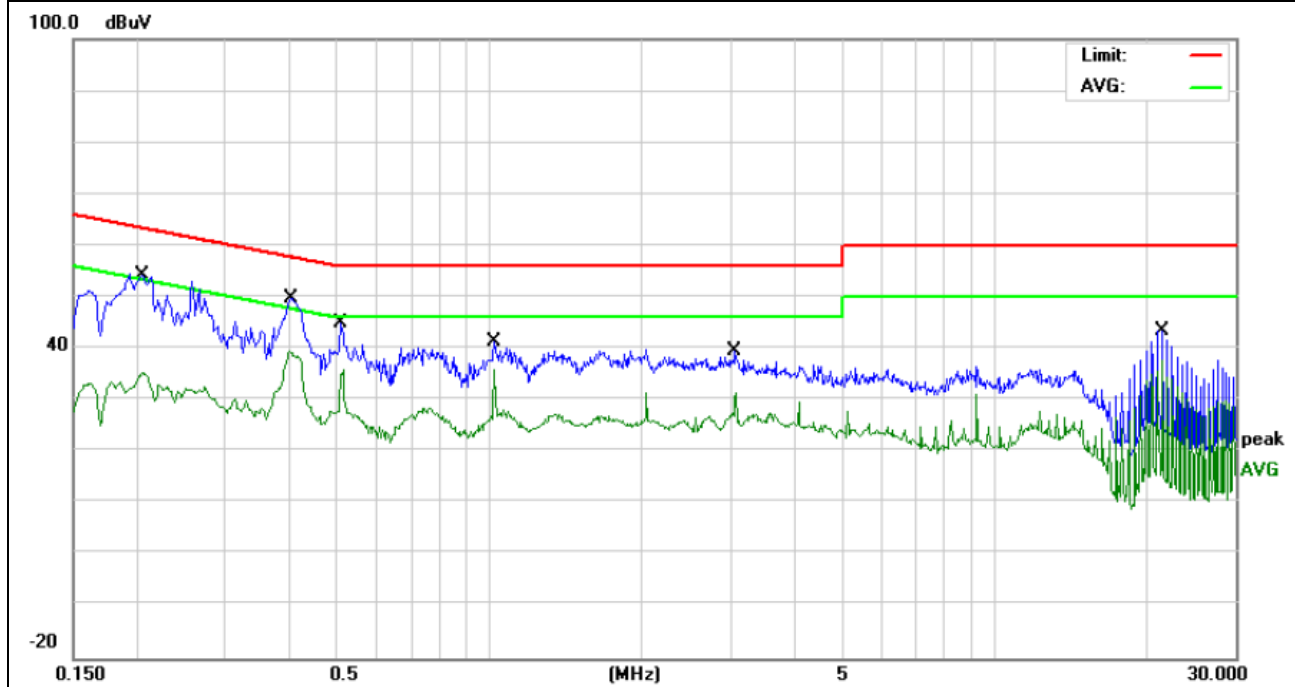

EUT :	38"Sound Bar 2.1 System	Model Name. :	SB3821-C6 Soundbar
Temperature :	26 °C	Relative Humidity :	56%
Pressure :	1010hPa	Phase :	N
Test Voltage :	AC 120V/60Hz- Adapter 1	Test Mode :	Mode 4

Frequency (MHz)	Meter Reading (dBμV)	Factor (dB)	Emission Level (dBμV)	Limits (dBμV)	Margin (dB)	Remark
0.2020	42.17	9.47	51.64	63.52	-11.88	QP
0.2020	25.32	9.47	34.79	53.52	-18.73	AVG
0.3996	37.38	9.45	46.83	57.86	-11.03	QP
0.3996	28.62	9.45	38.07	47.86	-9.79	AVG
0.5140	31.74	9.47	41.21	56.00	-14.79	QP
0.5140	25.80	9.47	35.27	46.00	-10.73	AVG
1.0260	31.42	9.46	40.88	56.00	-15.12	QP
1.0260	26.01	9.46	35.47	46.00	-10.53	AVG
2.0499	29.46	9.46	38.92	56.00	-17.08	QP
2.0499	21.99	9.46	31.45	46.00	-14.55	AVG
21.506	33.76	9.80	43.56	60.00	-16.44	QP
21.506	29.53	9.80	39.33	50.00	-10.67	AVG

Remark:

1. All readings are Quasi-Peak and Average values.
2. Factor = Insertion Loss + Cable Loss.

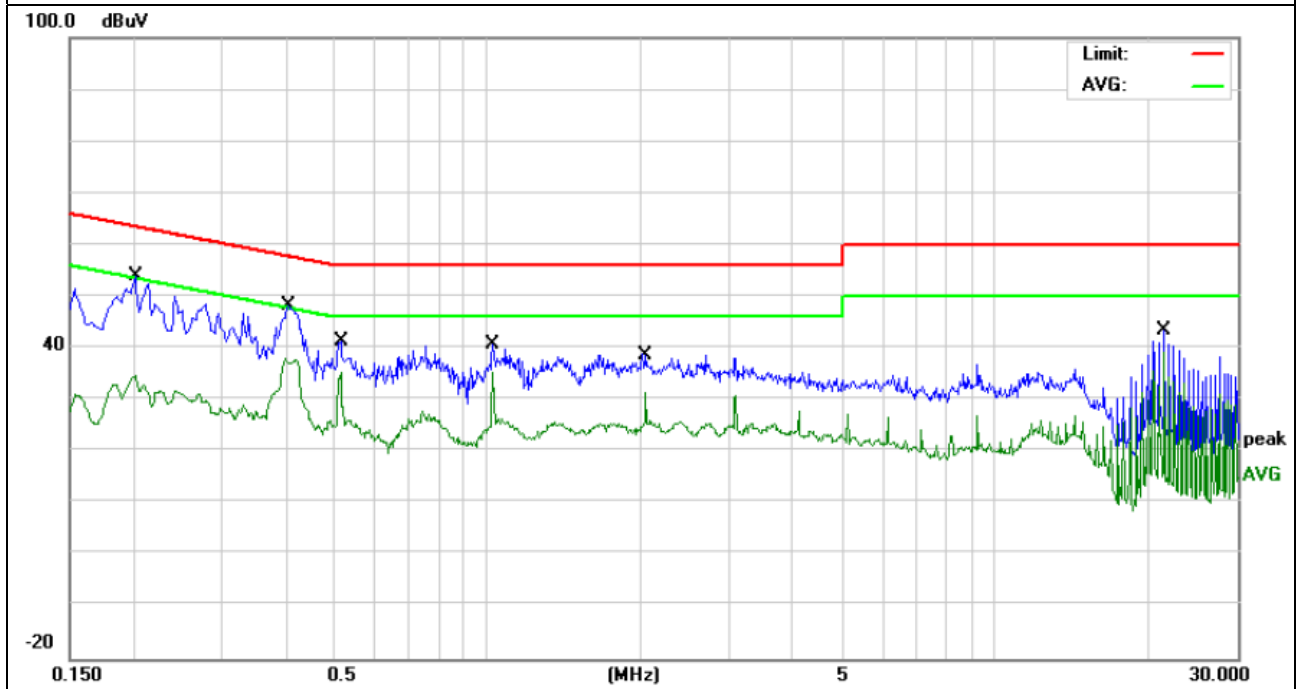

EUT :	38"Sound Bar 2.1 System	Model Name. :	SB3821-C6 Soundbar
Temperature :	26 °C	Relative Humidity :	56%
Pressure :	1010hPa	Phase :	L
Test Voltage :	AC 120V/60Hz- Adapter 2	Test Mode :	Mode 4

Frequency (MHz)	Meter Reading (dBμV)	Factor (dB)	Emission Level (dBμV)	Limits (dBμV)	Margin (dB)	Remark
0.1660	42.35	9.59	51.94	65.15	-13.21	QP
0.1660	22.16	9.59	31.75	55.15	-23.40	AVG
0.4099	35.03	9.45	44.48	57.65	-13.17	QP
0.4099	24.66	9.45	34.11	47.65	-13.54	AVG
0.5140	33.79	9.47	43.26	56.00	-12.74	QP
0.5140	29.31	9.47	38.78	46.00	-7.22	AVG
1.0260	26.81	9.46	36.27	56.00	-19.73	QP
1.0260	20.08	9.46	29.54	46.00	-16.46	AVG
2.0499	24.31	9.46	33.77	56.00	-22.23	QP
2.0499	15.51	9.46	24.97	46.00	-21.03	AVG
27.6499	28.42	9.91	38.33	60.00	-21.67	QP
27.6499	19.79	9.91	29.70	50.00	-20.30	AVG

Remark:

1. All readings are Quasi-Peak and Average values.
2. Factor = Insertion Loss + Cable Loss.

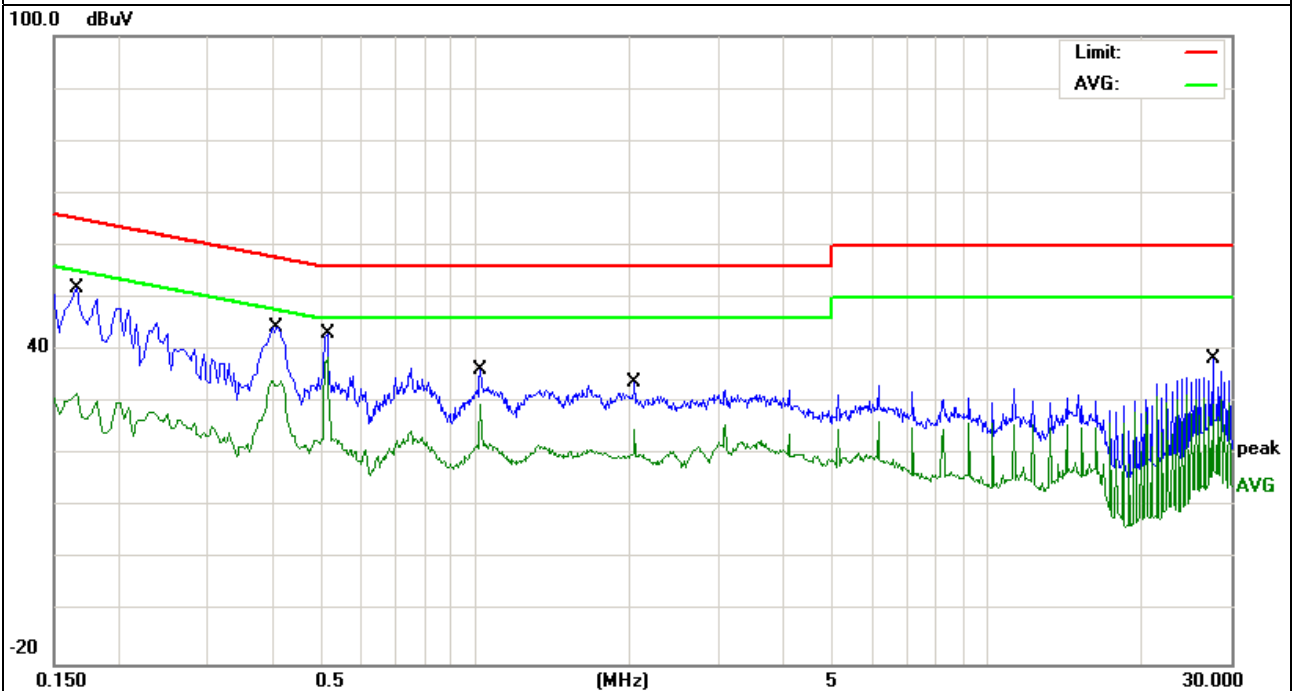

EUT :	38"Sound Bar 2.1 System	Model Name. :	SB3821-C6 Soundbar
Temperature :	26 °C	Relative Humidity :	56%
Pressure :	1010hPa	Phase :	N
Test Voltage :	AC 120V/60Hz- Adapter 2	Test Mode :	Mode 4

Frequency (MHz)	Meter Reading (dBμV)	Factor (dB)	Emission Level (dBμV)	Limits (dBμV)	Margin (dB)	Remark
0.1660	42.47	9.59	52.06	65.15	-13.09	QP
0.1660	22.50	9.59	32.09	55.15	-23.06	AVG
0.4020	32.71	9.45	42.16	57.81	-15.65	QP
0.4020	23.56	9.45	33.01	47.81	-14.80	AVG
0.5140	32.92	9.47	42.39	56.00	-13.61	QP
0.5140	28.55	9.47	38.02	46.00	-7.98	AVG
1.0260	25.68	9.46	35.14	56.00	-20.86	QP
1.0260	18.77	9.46	28.23	46.00	-17.77	AVG
2.0499	23.12	9.46	32.58	56.00	-23.42	QP
2.0499	14.27	9.46	23.73	46.00	-22.27	AVG
27.6499	30.60	9.91	40.51	60.00	-19.49	QP
27.6499	23.66	9.91	33.57	50.00	-16.43	AVG

Remark:

1. All readings are Quasi-Peak and Average values.
2. Factor = Insertion Loss + Cable Loss.

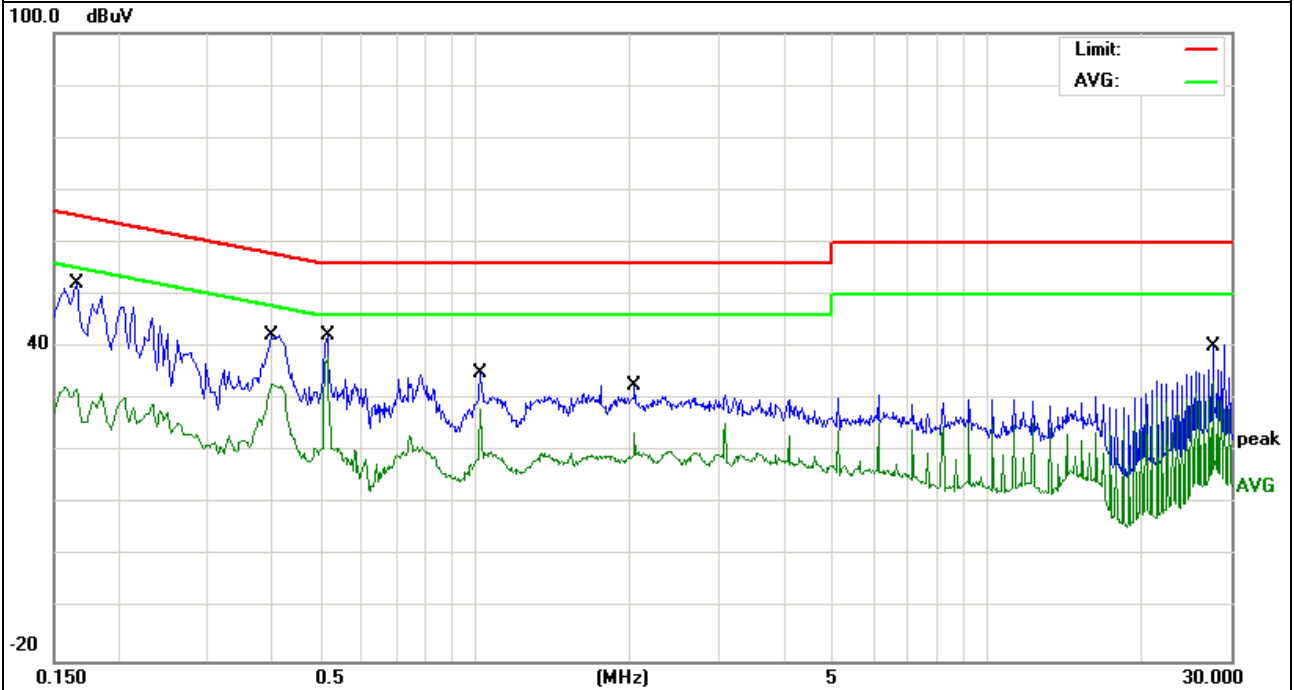

3.2 RADIATED EMISSION MEASUREMENT

3.2.1 RADIATED EMISSION LIMITS (Frequency Range 9kHz-1000MHz)

20dBc in any 100 kHz bandwidth outside the operating frequency band. In case the emission fall within the restricted band specified on 15.205(a)/ RSS-210 §2.2& A8.5, then the 15.209(a)/ RSS-210 & A8.5 limit in the table below has to be followed.

Frequencies (MHz)	Field Strength (micorvolts/meter)	Measurement Distance (meters)
0.009~0.490	2400/F(KHz)	300
0.490~1.705	24000/F(KHz)	30
1.705~30.0	30	30
30~88	100	3
88~216	150	3
216~960	200	3
Above 960	500	3

LIMITS OF RADIATED EMISSION MEASUREMENT (Above 1000MHz)

FREQUENCY (MHz)	(dBuV/m) (at 3M)	
	PEAK	AVERAGE
Above 1000	74	54

Notes:

- (1) The limit for radiated test was performed according to FCC PART 15C/ RSS-Gen.
- (2) The tighter limit applies at the band edges.
- (3) Emission level (dBuV/m)=20log Emission level (uV/m).

Spectrum Parameter	Setting
Attenuation	Auto
Start Frequency	1000 MHz
Stop Frequency	10th carrier harmonic

The frequency spectrum from 30 MHz to 25 GHz was investigated.

All readings from 30 MHz to 1 GHz are Quasi-peak values with a resolution bandwidth of 120 kHz. For measurement above 1GHz, peak values with RBW=1MHz VBW=3MHz and PK detector. AV value with RBW=1MHz, VBW=3MHz and RMS detector.

3.2.2 TEST PROCEDURE

- a. The measuring distance of at 3 m shall be used for measurements at frequency up to 1GHz. For frequencies above 1GHz, any suitable measuring distance may be used.
- b. The EUT was placed on the top of a rotating table 0.8 meters above the ground at a 3 meter open area test site. The table was rotated 360 degrees to determine the position of the highest radiation.
- c. The height of the equipment or of the substitution antenna shall be 0.8 m; the height of the test antenna shall vary between 1 m to 4 m. Both horizontal and vertical polarizations of the antenna are set to make the measurement.
- d. The initial step in collecting conducted emission data is a spectrum analyzer peak detector mode pre-scanning the measurement frequency range. Significant peaks are then marked and then Quasi Peak detector mode re-measured.
- e. If the Peak Mode measured value compliance with and lower than Quasi Peak Mode Limit, the EUT shall be deemed to meet QP Limits and then no additional QP Mode measurement performed.
- f. For the actual test configuration, please refer to the related Item –EUT Test Photos.

Note:

Both horizontal and vertical antenna polarities were tested and performed pretest to three orthogonal axis. The worst case emissions were reported

3.2.3 DEVIATION FROM TEST STANDARD

No deviation

3.2.4 TEST SETUP

(A) Radiated Emission Test-Up Frequency Below 30MHz

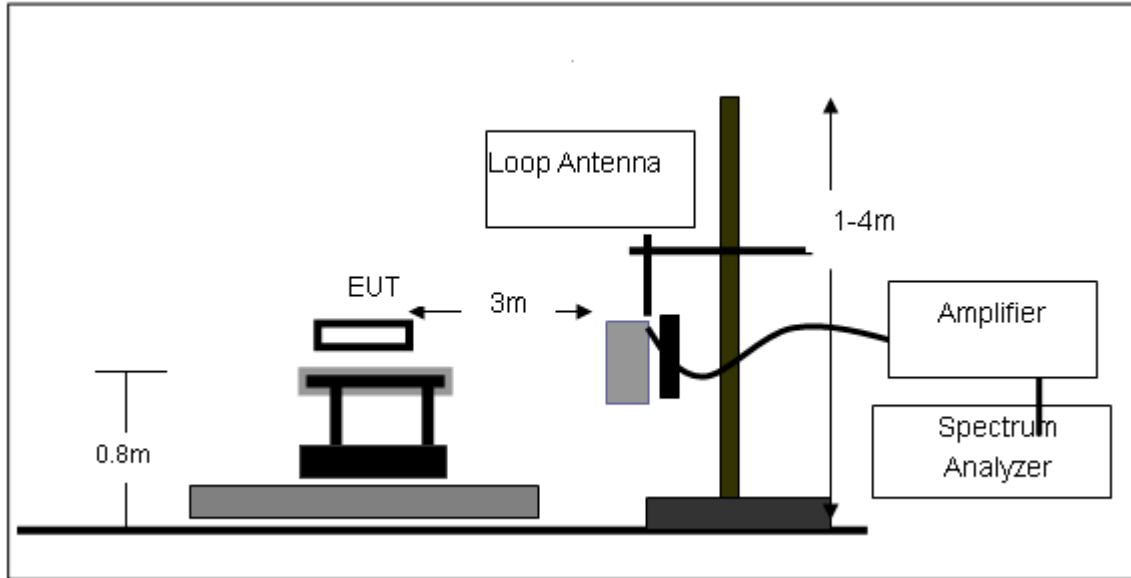

(B) Radiated Emission Test-Up Frequency 30MHz~1GHz

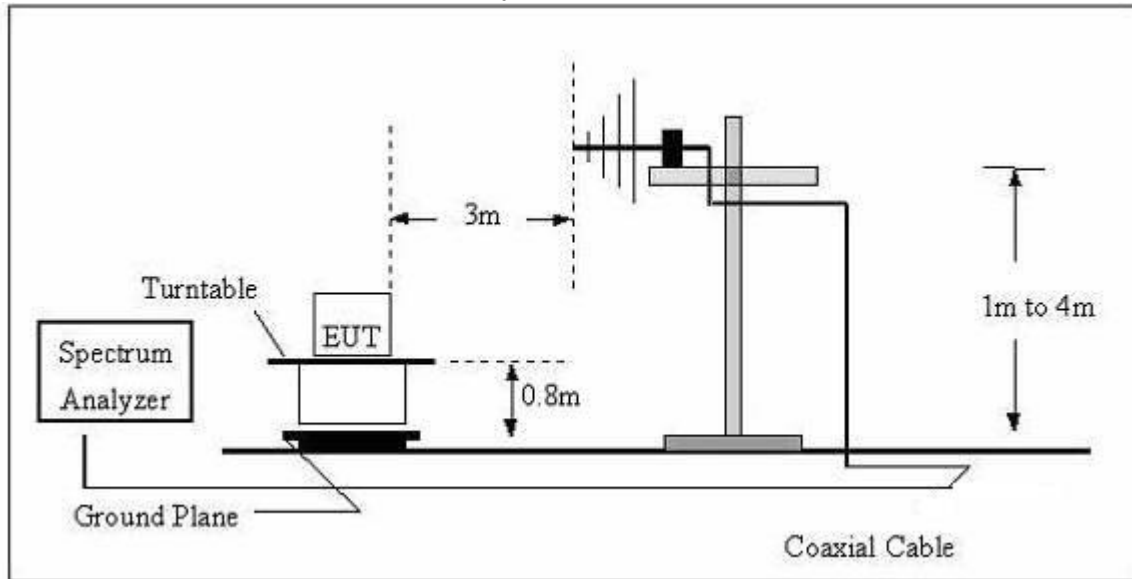

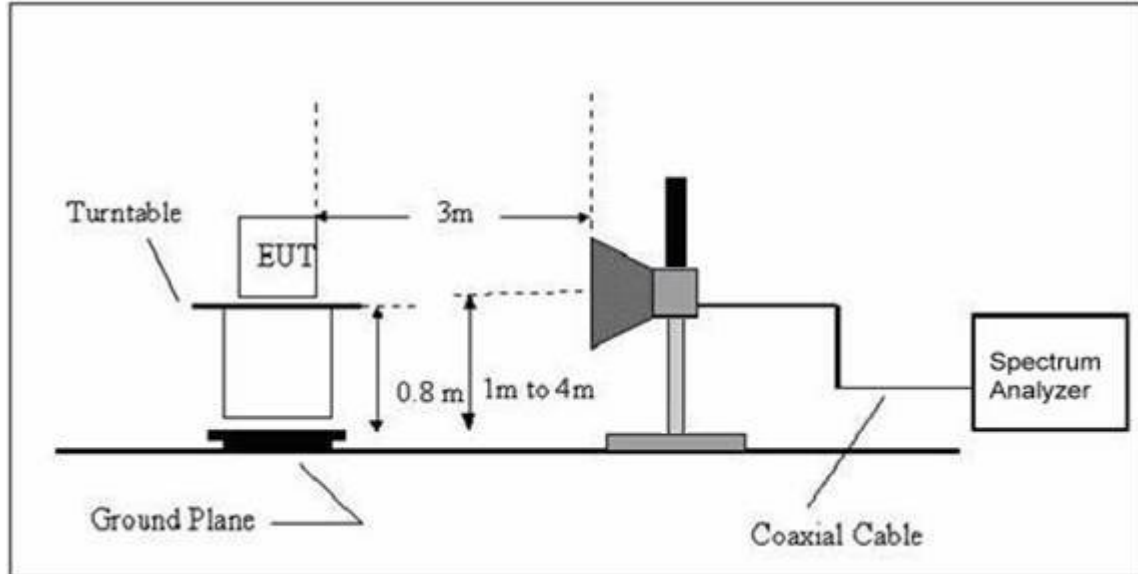
(C) Radiated Emission Test-Up Frequency Above 1GHz**3.2.5 EUT OPERATING CONDITIONS**

The EUT tested system was configured as the statements of 2.4 Unless otherwise a special operating condition is specified in the follows during the testing.

3.2.6 TEST RESULTS (BETWEEN 9KHZ – 30 MHZ)

EUT:	38"Sound Bar 2.1 System	Model Name. :	SB3821-C6 Soundbar
Temperature:	20 °C	Relative Humidity:	48%
Pressure:	1010 hPa	Test Voltage :	AC 120V/60Hz
Test Mode :	TX	Polarization :	--

Freq.	Reading	Limit	Margin	State
(MHz)	(dBuV/m)	(dBuV/m)	(dB)	P/F
--	--	--	--	N/A
--	--	--	--	N/A

NOTE:

The amplitude of spurious emissions which are attenuated by more than 20dB below the permissible value has no need to be reported.

Distance extrapolation factor = $40 \log (\text{specific distance}/\text{test distance})(\text{dB})$;

Limit line = specific limits(dBuv) + distance extrapolation factor.

3.2.7 TEST RESULTS (BETWEEN 30MHZ – 1GHZ)

EUT :	38"Sound Bar 2.1 System	Model Name :	SB3821-C6 Soundbar
Temperature :	20 °C	Relative Humidity :	48%
Pressure:	1010 hPa	Test Voltage :	AC 120V/60Hz- Adapter 1
Test Mode :	TX		

Polar (H/V)	Frequency	Meter Reading	Factor	Emission Level	Limits	Margin	Remark
	(MHz)	(dBuV)	(dB)	(dBuV/m)	(dBuV/m)	(dB)	
V	39.8542	18.71	13.63	32.34	40.00	-7.66	QP
V	46.0164	19.10	11.67	30.77	40.00	-9.23	QP
V	58.4074	24.24	8.28	32.52	40.00	-7.48	QP
V	98.1419	21.24	8.78	30.02	43.50	-13.48	QP
V	133.6188	21.75	11.71	33.46	43.50	-10.04	QP
V	348.0274	20.01	16.16	36.17	46.00	-9.83	QP

Remark:

Absolute Level= ReadingLevel+ Factor, Margin= Absolute Level - Limit

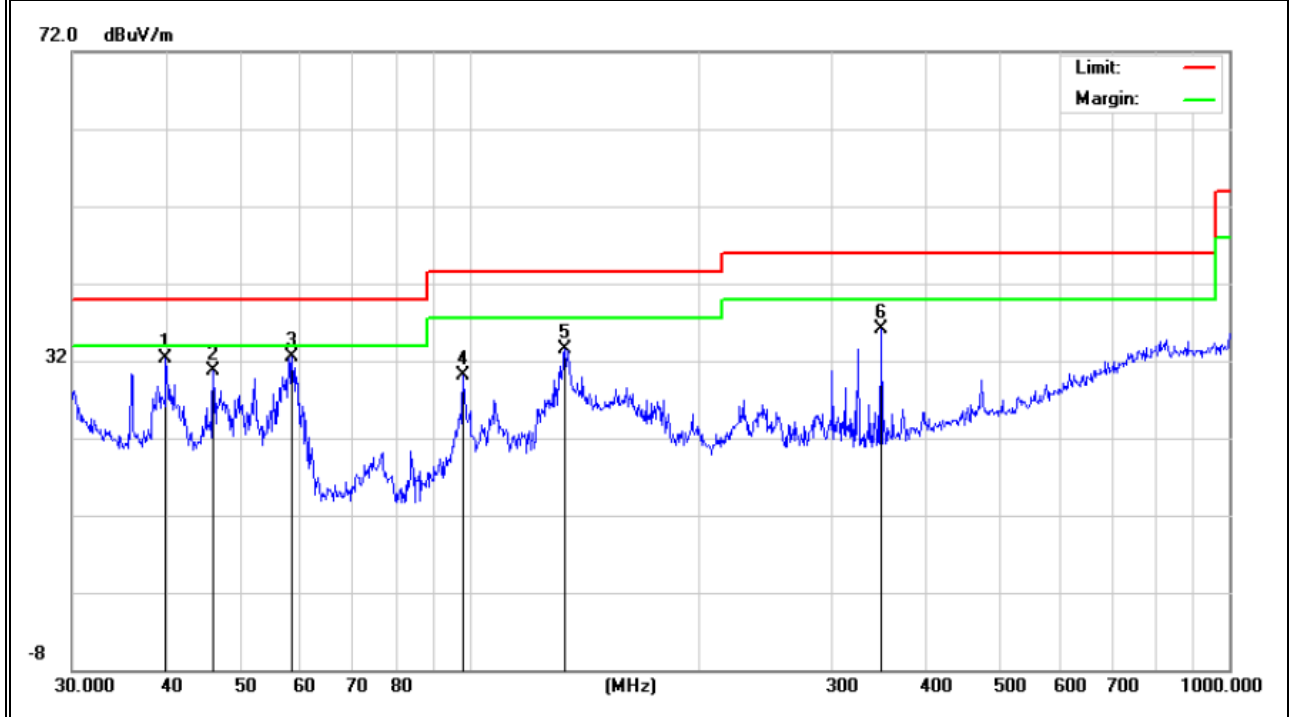

Polar (H/V)	Frequency	Meter Reading	Factor	Emission Level	Limits	Margin	Remark
	(MHz)	(dBuV)	(dB)	(dBuV/m)	(dBuV/m)	(dB)	
H	58.4074	22.47	8.28	30.75	40.00	-9.25	QP
H	108.2667	23.77	9.78	33.55	43.50	-9.95	QP
H	133.6188	28.09	11.71	39.8	43.50	-3.70	QP
H	176.8878	24.64	10.60	35.24	43.50	-8.26	QP
H	348.0274	25.82	16.16	41.98	46.00	-4.02	QP
H	372.0045	17.76	17.16	34.92	46.00	-11.08	QP

Remark:

Absolute Level= ReadingLevel+ Factor, Margin= Absolute Level - Limit

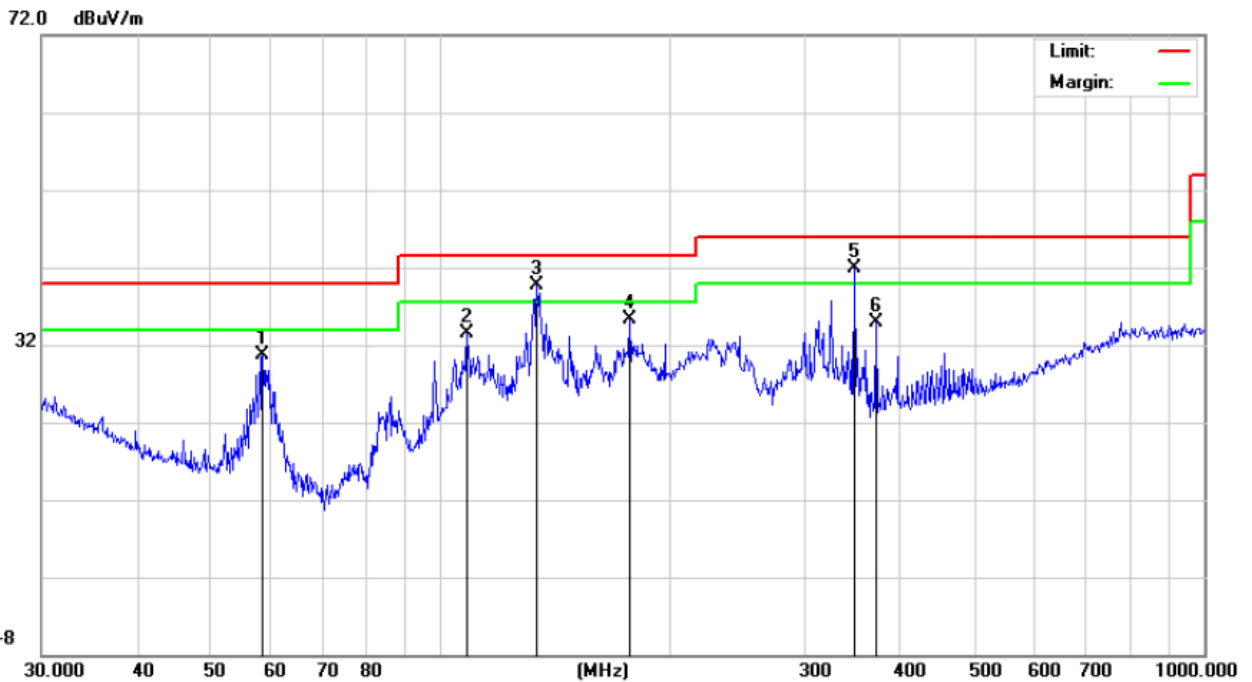

EUT :	38"Sound Bar 2.1 System	Model Name :	SB3821-C6 Soundbar
Temperature :	20 °C	Relative Humidity :	48%
Pressure:	1010 hPa	Test Voltage :	AC 120V/60Hz- Adapter 2
Test Mode :	TX		

Polar (H/V)	Frequency	Meter Reading	Factor	Emission Level	Limits	Margin	Remark
	(MHz)	(dBuV)	(dB)	(dBuV/m)	(dBuV/m)	(dB)	
V	59.8588	16.40	7.87	24.27	40.00	-15.73	QP
V	109.4116	19.89	9.89	29.78	43.50	-13.72	QP
V	134.5592	20.97	11.67	32.64	43.50	-10.86	QP
V	196.5098	22.68	10.75	33.43	43.50	-10.07	QP
V	255.6229	21.35	13.66	35.01	46.00	-10.99	QP
V	370.7022	17.99	17.10	35.09	46.00	-10.91	QP

Remark:

Absolute Level= ReadingLevel+ Factor, Margin= Absolute Level - Limit

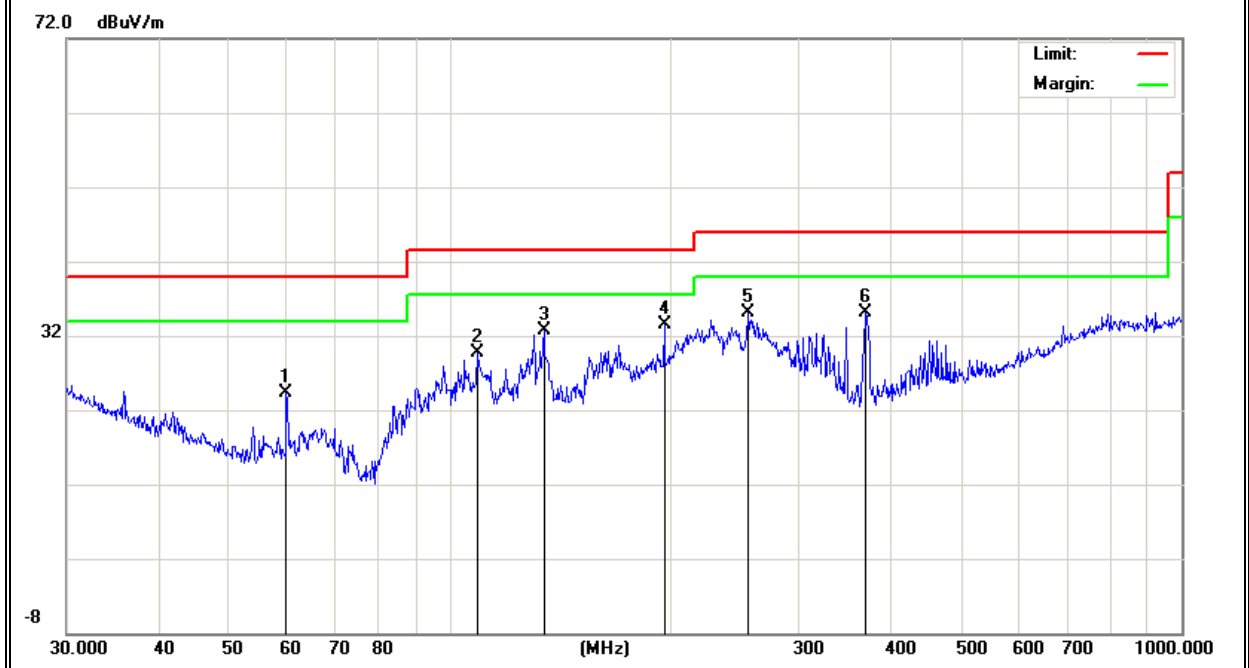

Polar (H/V)	Frequency	Meter Reading	Factor	Emission Level	Limits	Margin	Remark
	(MHz)	(dBuV)	(dB)	(dBuV/m)	(dBuV/m)	(dB)	
H	36.0007	18.92	16.06	34.98	40.00	-5.02	QP
H	56.3947	20.95	8.87	29.82	40.00	-10.18	QP
H	107.8876	21.65	9.74	31.39	43.50	-12.11	QP
H	132.6850	21.01	11.76	32.77	43.50	-10.73	QP
H	196.5098	25.29	10.75	36.04	43.50	-7.46	QP
H	370.7022	14.85	17.10	31.95	46.00	-14.05	QP

Remark:

Absolute Level= ReadingLevel+ Factor, Margin= Absolute Level - Limit

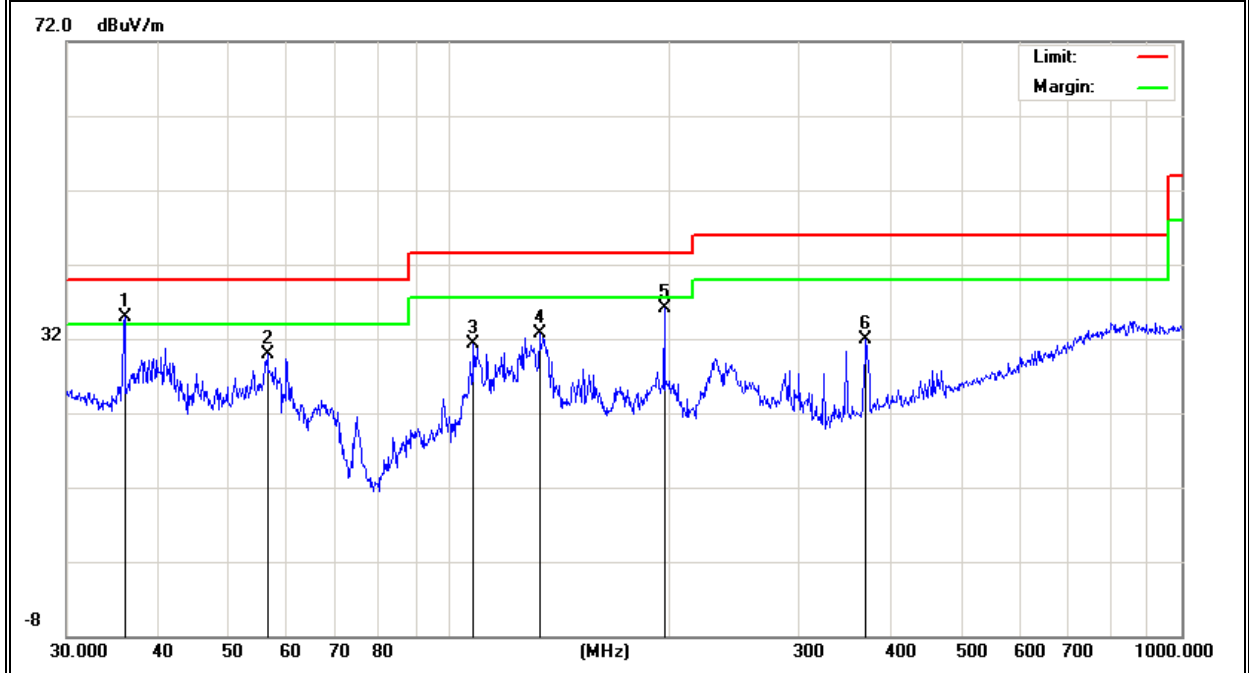

3.2.8 TEST RESULTS (ABOVE 1000 MHZ)

EUT :	38"Sound Bar 2.1 System	Model Name :	SB3821-C6 Soundbar
Temperature :	20 °C	Relative Humidity :	48%
Pressure:	1010 hPa	Test Voltage :	AC 120V/60Hz- Adapter 1
Test Mode :	TX		

Frequency (MHz)	Reading (dBµV)	Factor (dB)	Corrected Amplitude (dBµV/m)	Limit (dBµV/m)	Margin (dB)	Remark	Polar (H/V)
Low Channel (2402 MHz)-Above 1G							
4804.116	60.14	-3.64	56.5	74	-17.5	Pk	Vertical
4804.116	42.48	-3.64	38.84	54	-15.16	AV	Vertical
7206.203	60.29	-0.95	59.34	74	-14.66	Pk	Vertical
7206.203	38.42	-0.95	37.47	54	-16.53	AV	Vertical
4804.158	60.52	-3.64	56.88	74	-17.12	Pk	Horizontal
4804.158	43.38	-3.64	39.74	54	-14.26	AV	Horizontal
7206.369	58.49	-0.95	57.54	74	-16.46	Pk	Horizontal
7206.369	38.31	-0.95	37.36	54	-16.64	AV	Horizontal
Mid Channel (2440 MHz)-Above 1G							
4880.148	59.99	-3.68	56.31	74	-17.69	Pk	Vertical
4880.148	42.02	-3.68	38.34	54	-15.66	AV	Vertical
7320.251	59.38	-0.82	58.56	74	-15.44	Pk	Vertical
7320.251	40.22	-0.82	39.4	54	-14.6	AV	Vertical
4880.362	61.89	-3.68	58.21	74	-15.79	Pk	Horizontal
4880.362	45.02	-3.68	41.34	54	-12.66	AV	Horizontal
7320.058	59.32	-0.82	58.5	74	-15.5	Pk	Horizontal
7320.058	39.49	-0.82	38.67	54	-15.33	AV	Horizontal
High Channel (2480MHz)- Above 1G							
4960.185	59.31	-3.59	55.72	74	-18.28	Pk	Vertical
4960.185	42.16	-3.59	38.57	54	-15.43	AV	Vertical
7440.172	57.78	-0.68	57.1	74	-16.9	Pk	Vertical
7440.172	42.04	-0.68	41.36	54	-12.64	AV	Vertical
4960.095	59.14	-3.59	55.55	74	-18.45	Pk	Horizontal
4960.095	42.32	-3.59	38.73	54	-15.27	AV	Horizontal
7440.248	60.67	-0.68	59.99	74	-14.01	Pk	Horizontal
7440.248	39.51	-0.68	38.83	54	-15.17	AV	Horizontal

EUT :	38"Sound Bar 2.1 System	Model Name :	SB3821-C6 Soundbar
Temperature :	20 °C	Relative Humidity :	48%
Pressure:	1010 hPa	Test Voltage :	AC 120V/60Hz- Adapter 2
Test Mode :	TX		

Frequency (MHz)	Reading (dBµV)	Factor (dB)	Corrected Amplitude (dBµV/m)	Limit (dBµV/m)	Margin (dB)	Remark	Polar (H/V)
Low Channel (2402 MHz)-Above 1G							
4804.205	59.62	-3.64	55.98	74	-18.02	Pk	Vertical
4804.205	41.96	-3.64	38.32	54	-15.68	AV	Vertical
7206.142	59.77	-0.95	58.82	74	-15.18	Pk	Vertical
7206.142	37.92	-0.95	36.97	54	-17.03	AV	Vertical
4804.069	60.36	-3.64	56.72	74	-17.28	Pk	Horizontal
4804.069	42.86	-3.64	39.22	54	-14.78	AV	Horizontal
7206.185	57.97	-0.95	57.02	74	-16.98	Pk	Horizontal
7206.185	37.79	-0.95	36.84	54	-17.16	AV	Horizontal
Mid Channel (2440 MHz)-Above 1G							
4880.306	59.47	-3.68	55.79	74	-18.21	Pk	Vertical
4880.306	41.51	-3.68	37.83	54	-16.17	AV	Vertical
7320.185	58.86	-0.82	58.04	74	-15.96	Pk	Vertical
7320.185	39.72	-0.82	38.9	54	-15.1	AV	Vertical
4880.163	61.37	-3.68	57.69	74	-16.31	Pk	Horizontal
4880.163	44.51	-3.68	40.83	54	-13.17	AV	Horizontal
7320.158	58.84	-0.82	58.02	74	-15.98	Pk	Horizontal
7320.158	38.97	-0.82	38.15	54	-15.85	AV	Horizontal
High Channel (2480MHz)- Above 1G							
4960.241	58.79	-3.59	55.2	74	-18.8	Pk	Vertical
4960.241	41.64	-3.59	38.05	54	-15.95	AV	Vertical
7440.369	57.26	-0.68	56.58	74	-17.42	Pk	Vertical
7440.369	41.52	-0.68	40.84	54	-13.16	AV	Vertical
4960.148	58.62	-3.59	55.03	74	-18.97	Pk	Horizontal
4960.148	41.82	-3.59	38.23	54	-15.77	AV	Horizontal
7440.263	60.15	-0.68	59.47	74	-14.53	Pk	Horizontal
7440.263	38.99	-0.68	38.31	54	-15.69	AV	Horizontal

4. POWER SPECTRAL DENSITY TEST

4.1 APPLIED PROCEDURES / LIMIT

FCC Part15 (15.247) , Subpart C/ RSS-210				
Section	Test Item	Limit	Frequency Range (MHz)	Result
15.247/ RSS-210§A8. 2 (b)	Power Spectral Density	8 dBm (in any 3KHz)	2400-2483.5	PASS

4.1.1 TEST PROCEDURE

1. Set analyzer center frequency to DTS channel center frequency.
2. Set the span to 1.5 times the DTS channel bandwidth.
3. Set the RBW \geq 3 kHz.
4. Set the VBW \geq 3 x RBW.
5. Detector = peak.
6. Sweep time = auto couple.
7. Trace mode = max hold.
8. Allow trace to fully stabilize.
9. Use the peak marker function to determine the maximum amplitude level.
10. If measured value exceeds limit, reduce RBW (no less than 3 kHz) and repeat.

4.1.2 DEVIATION FROM STANDARD

No deviation.

4.1.3 TEST SETUP

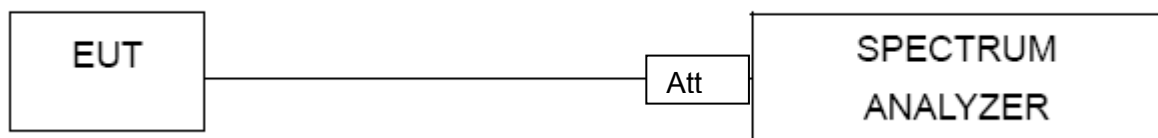

4.1.4 EUT OPERATION CONDITIONS

The EUT tested system was configured as the statements of 2.1 Unless otherwise a special operating condition is specified in the follows during the testing.

4.1.5 TEST RESULTS

EUT :	38"Sound Bar 2.1 System	Model Name :	SB3821-C6 Soundbar
Temperature :	25 °C	Relative Humidity :	56%
Pressure :	1015 hPa	Test Voltage :	AC 120V/60Hz
Test Mode :	TX Mode /CH00, CH19, CH39		

Frequency	Power Density (dBm)	Limit (dBm)	Result
2402 MHz	-16.87	8	PASS
2440 MHz	-17.52	8	PASS
2480 MHz	-18.43	8	PASS

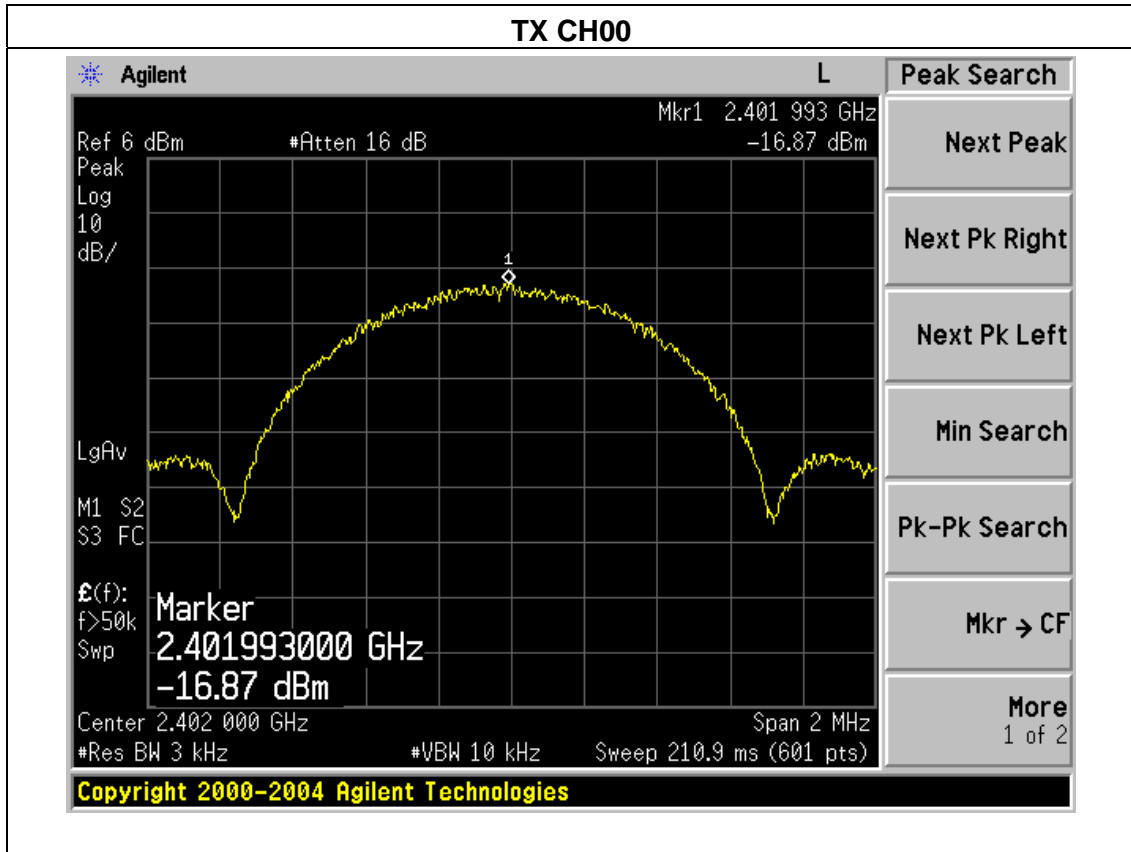

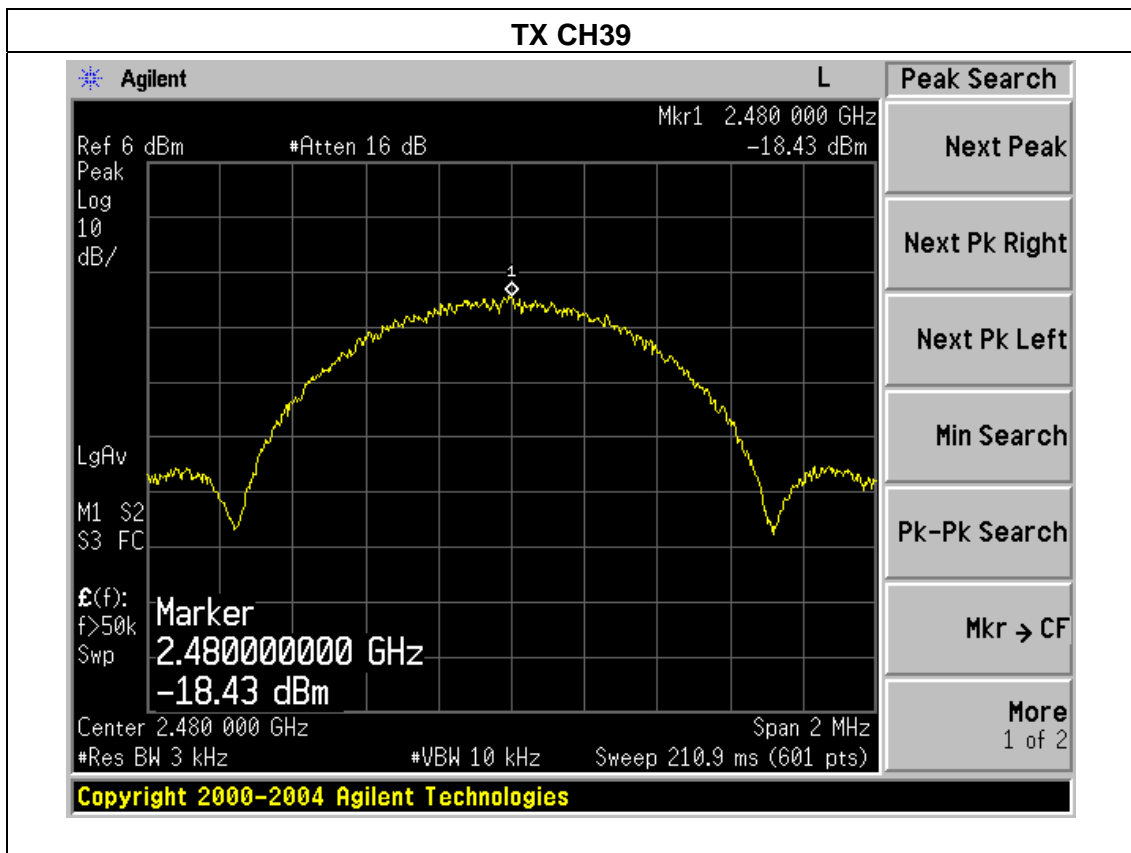
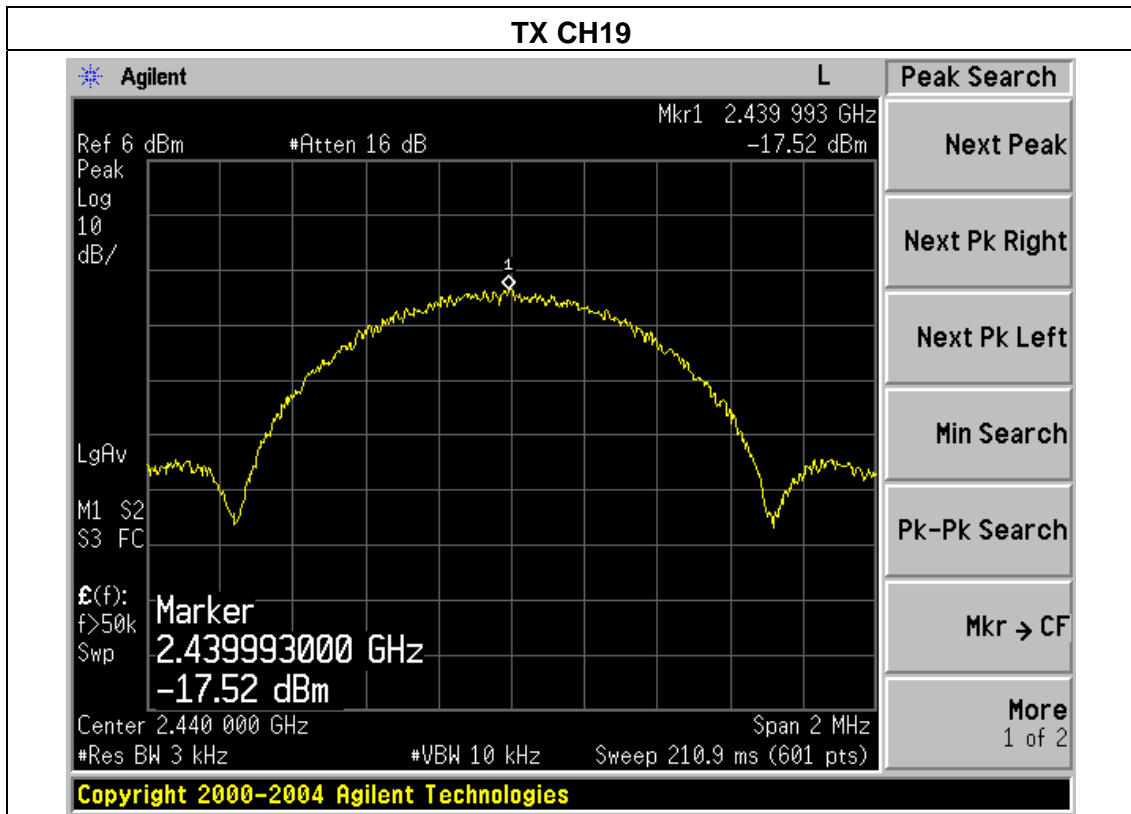

5. BANDWIDTH TEST

5.1 APPLIED PROCEDURES / LIMIT

FCC Part15 (15.247) , Subpart C/ RSS-210				
Section	Test Item	Limit	Frequency Range (MHz)	Result
15.247(a)(2)/ RSS-Gen§4.6 .1&RSS-210§ A8.2 (a)	Bandwidth	>= 500KHz (6dB bandwidth)	2400-2483.5	PASS

5.1.1 TEST PROCEDURE

According to KDB 558074 D01 DTS Meas Guidance v03r01

1. Check the calibration of the measuring instrument using either an internal calibrator or a known signal from an external generator
2. Position the EUT without connection to measurement instrument. Turn on the EUT and connect it to measurement instrument. Then set it to any one convenient frequency within its operating range. Set a reference level on the measuring instrument equal to the highest peak value.
3. Measure the frequency difference of two frequencies that were attenuated 6 dB from the reference level. Record the frequency difference as the emission bandwidth.
4. Repeat above procedures until all frequencies measured were complete.

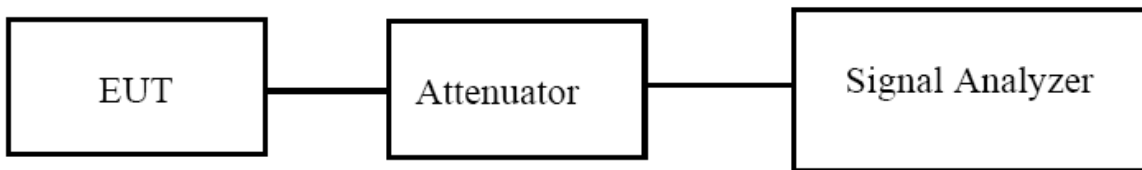

5.1.2 EUT OPERATION CONDITIONS

The EUT tested system was configured as the statements of 2.4 Unless otherwise a special operating condition is specified in the follows during the testing.

5.1.3 TEST RESULTS

EUT :	38"Sound Bar 2.1 System	Model Name :	SB3821-C6 Soundbar
Temperature :	25 °C	Relative Humidity :	56%
Pressure :	1012 hPa	Test Voltage :	AC 120V/60Hz
Test Mode :	TX Mode /CH00, CH19, CH39		

Channel	Frequency (MHz)	6dB bandwidth (kHz)	99% Bandwidth (MHz)	Limit (kHz)	Result
Low	2402	709.302	1.043	500	Pass
Middle	2440	714.481	1.044	500	Pass
High	2480	712.428	1.041	500	Pass

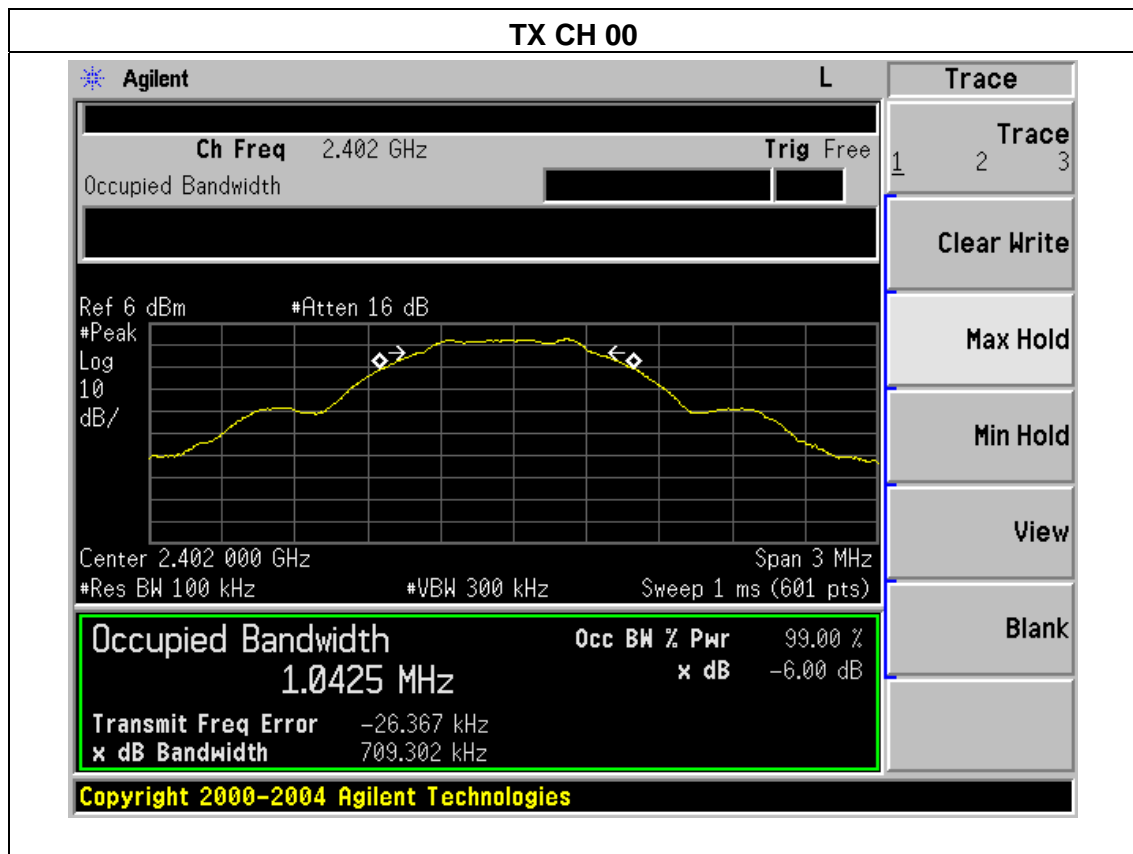

TX CH 19

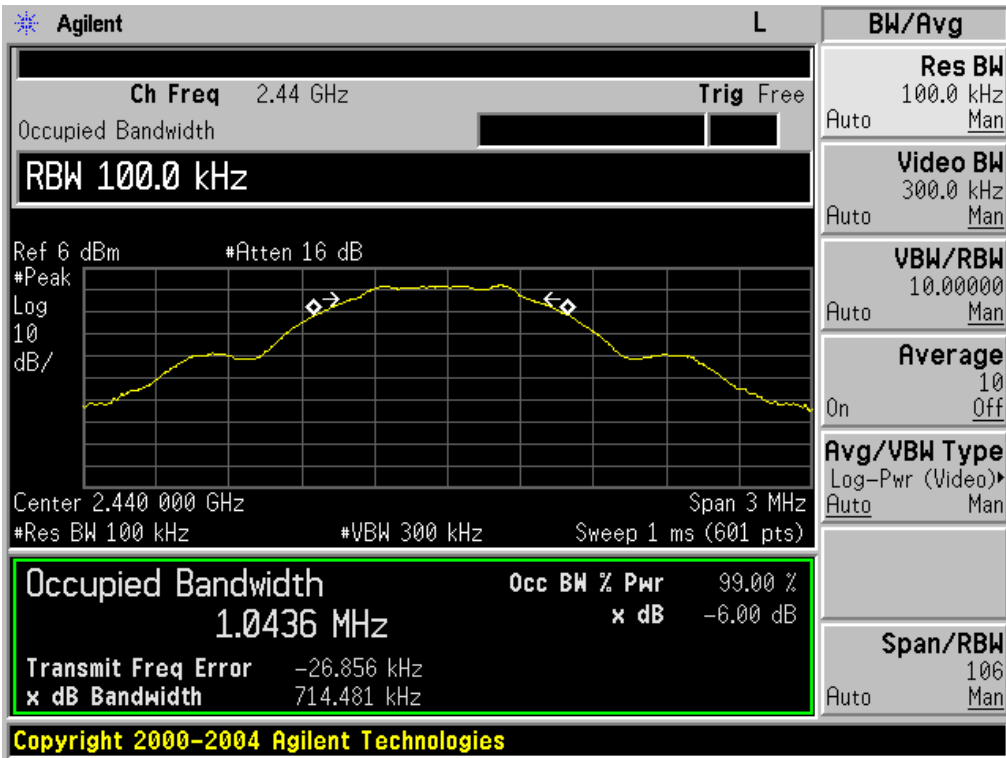

TX CH 39

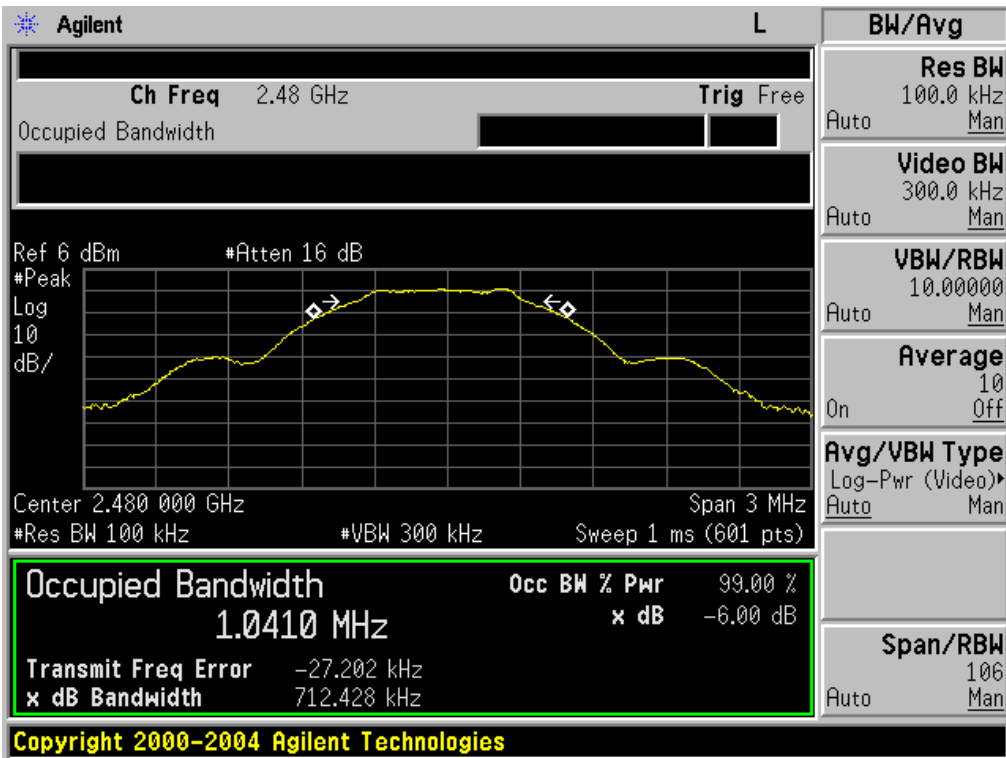

6. MAX CONDUCTED OUTPUT POWER TEST

6.1 APPLIED PROCEDURES / LIMIT

FCC Part15 (15.247) , Subpart C/ RSS-210				
Section	Test Item	Limit	Frequency Range (MHz)	Result
15.247(b)(3)/ RSS-210 §A8.4 (4)	Max Conducted output power	1 watt or 30dBm	2400-2483.5	PASS

6.1.1 TEST PROCEDURE

- a. The EUT was directly connected to the Power meter

6.1.2 DEVIATION FROM STANDARD

No deviation.

6.1.3 TEST SETUP



6.1.4 EUT OPERATION CONDITIONS

The EUT tested system was configured as the statements of 2.4 Unless otherwise a special operating condition is specified in the follows during the testing.

6.1.5 TEST RESULTS

EUT :	38"Sound Bar 2.1 System	Model Name :	SB3821-C6 Soundbar
Temperature :	25 °C	Relative Humidity :	60%
Pressure :	1012 hPa	Test Voltage :	AC 120V/60Hz
Test Mode :	TX Mode		

Test Channel	Frequency	Maximum Conducted Output Power	LIMIT
	(MHz)	(dBm)	dBm
CH01	2402	-0.31	30
CH19	2440	-0.29	30
CH39	2480	-0.32	30

7. 100 KHZ BANDWIDTH OF FREQUENCY BAND EDGE

APPLICABLE STANDARD

In any 100 kHz bandwidth outside the frequency band in which the spread spectrum or digitally modulated intentional radiator is operating, the radio frequency power that is produced by the intentional radiator shall be at least 20 dB below that in the 100 kHz bandwidth within the band that contains the highest level of the desired power, based on either an RF conducted or a radiated measurement, provided the transmitter demonstrates compliance with the peak conducted power limits. If the transmitter complies with the conducted power limits based on the use of RMS averaging over a time interval, as permitted under paragraph (b)(3) of this section, the attenuation required under this paragraph shall be 30 dB instead of 20 dB. Attenuation below the general limits specified in §15.209(a) is not required. In addition, radiated emissions which fall in the restricted bands, as defined in §15.205(a), must also comply with the radiated emission limits specified in §15.209(a) (see §15.205(c)).

TEST PROCEDURE

- a) Check the calibration of the measuring instrument using either an internal calibrator or a known signal from an external generator.
- b) Position the EUT without connection to measurement instrument. Turn on the EUT and connect its antenna terminal to measurement instrument via a low loss cable. Then set it to any one measured frequency within its operating range, and make sure the instrument is operated in its linear range.
- c) Set RBW to 100 kHz and VBW of spectrum analyzer to 300 kHz with a convenient frequency span including 100 kHz bandwidth from band edge.
- d) Measure the highest amplitude appearing on spectral display and set it as a reference level. Plot the graph with marking the highest point and edge frequency.
- e) Repeat above procedures until all measured frequencies were complete.

7.1 DEVIATION FROM STANDARD

No deviation.

7.2 TEST SETUP

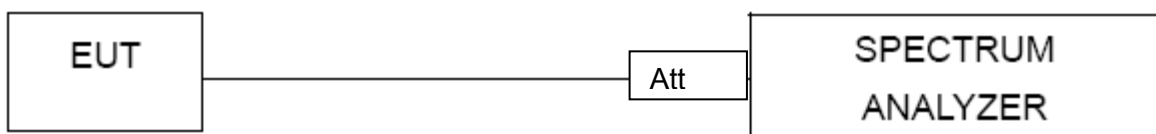

7.3 EUT OPERATION CONDITIONS

The EUT tested system was configured as the statements of 2.4 Unless otherwise a special operating condition is specified in the follows during the testing.

7.4 TEST RESULTS

EUT :	38"Sound Bar 2.1 System	Model Name :	SB3821-C6 Soundbar
Temperature :	25 °C	Relative Humidity :	56%
Pressure :	1012 hPa	Test Voltage :	AC 120V/60Hz

Frequency Band	Delta Peak to band emission (dBc)	> Limit (dBc)	Result
Left-band	59.51	30	Pass
Right-band	65.06	30	Pass

Radiated band edge:

Frequency (MHz)	Meter Reading (dBµV)	Factor (dB)	Emission Level (dBµV/m)	Limits (dBµV/m)	Margin (dB)	Remark	Comment
2390	58.57	-13.06	45.51	74	-28.49	peak	Vertical
2390	58.31	-13.06	45.25	74	-28.75	peak	Horizontal
2483.5	59.54	-12.78	46.76	74	-27.24	peak	Vertical
2483.5	59.55	-12.78	46.77	74	-27.23	peak	Horizontal

Note: Test method to see chapter 3.2 . When PK value is lower than the Average value limit, average not record.

Band Edge, Left Side

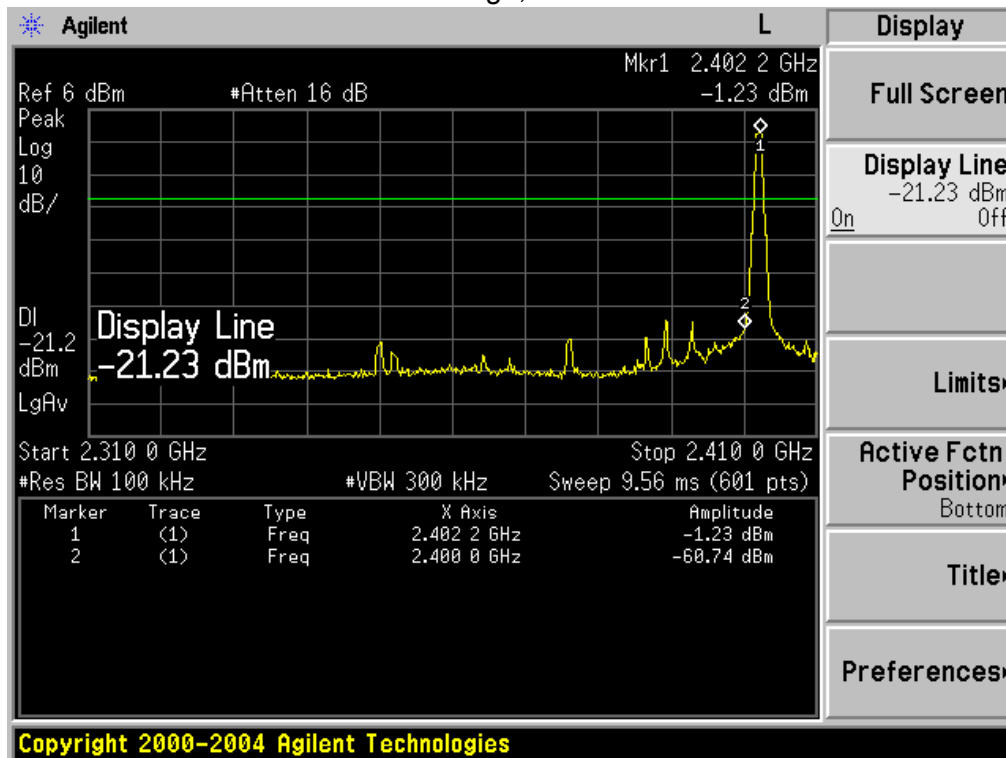

Band Edge, Right Side

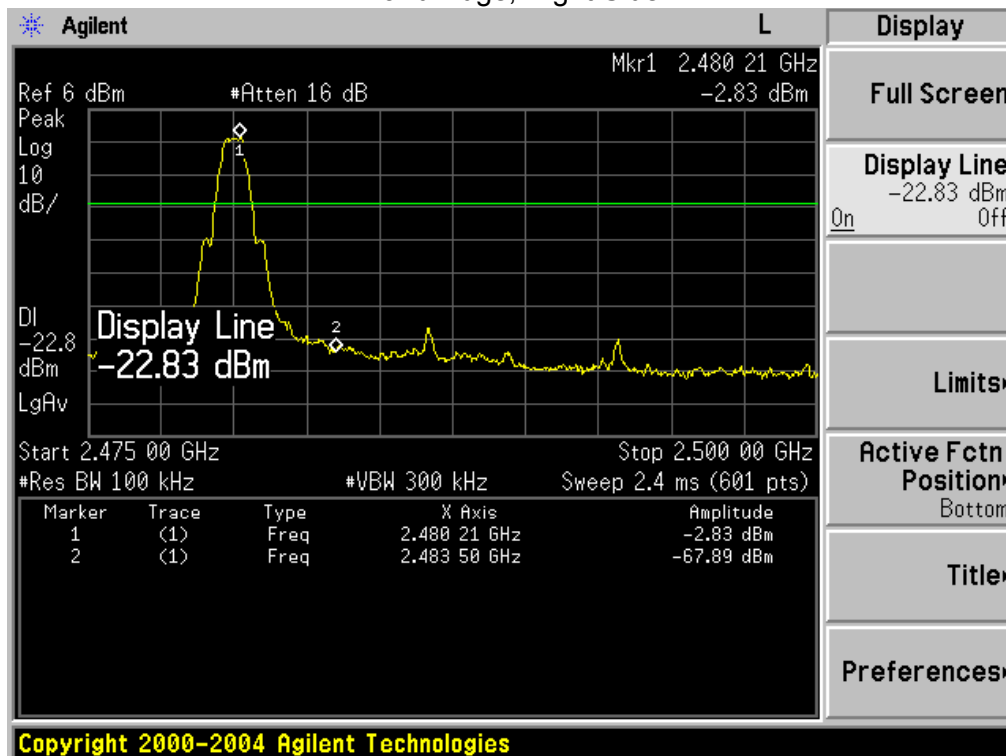

8. ANTENNA REQUIREMENT

8.1 STANDARD REQUIREMENT

15.203 requirement: For intentional device, according to 15.203: an intentional radiator shall be designed to ensure that no antenna other than that furnished by the responsible party shall be used with the device.

8.2 EUT ANTENNA

The EUT antenna is PCB antenna. It comply with the standard requirement.

9. EUT TEST PHOTO

Radiated Measurement Photos

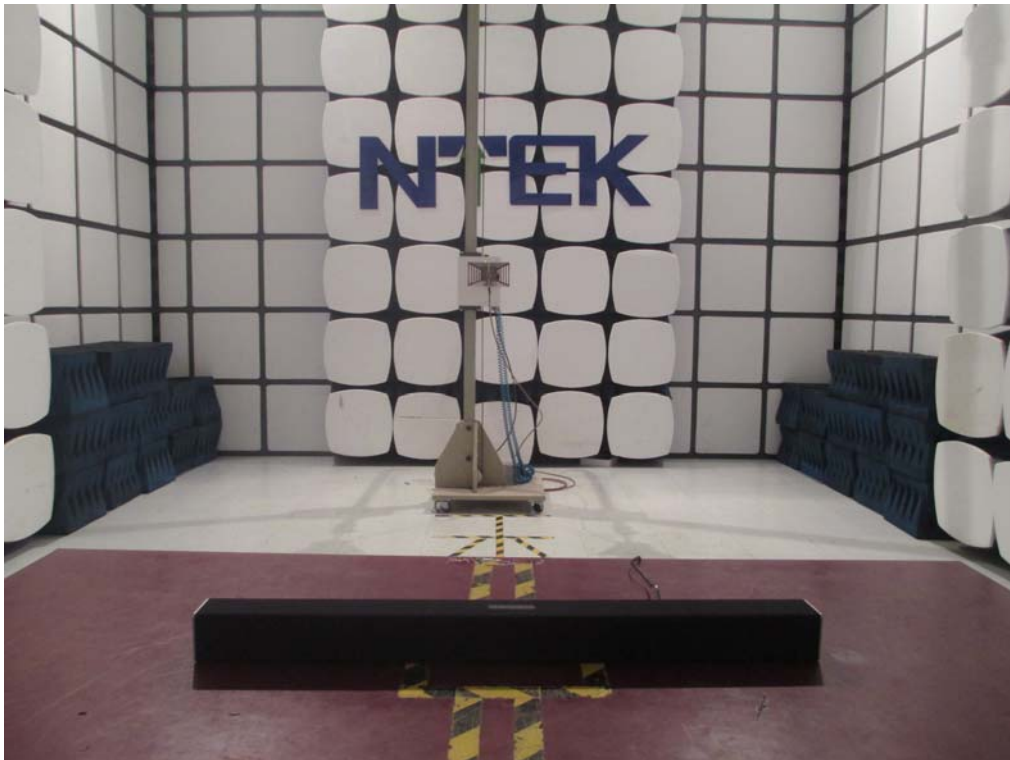
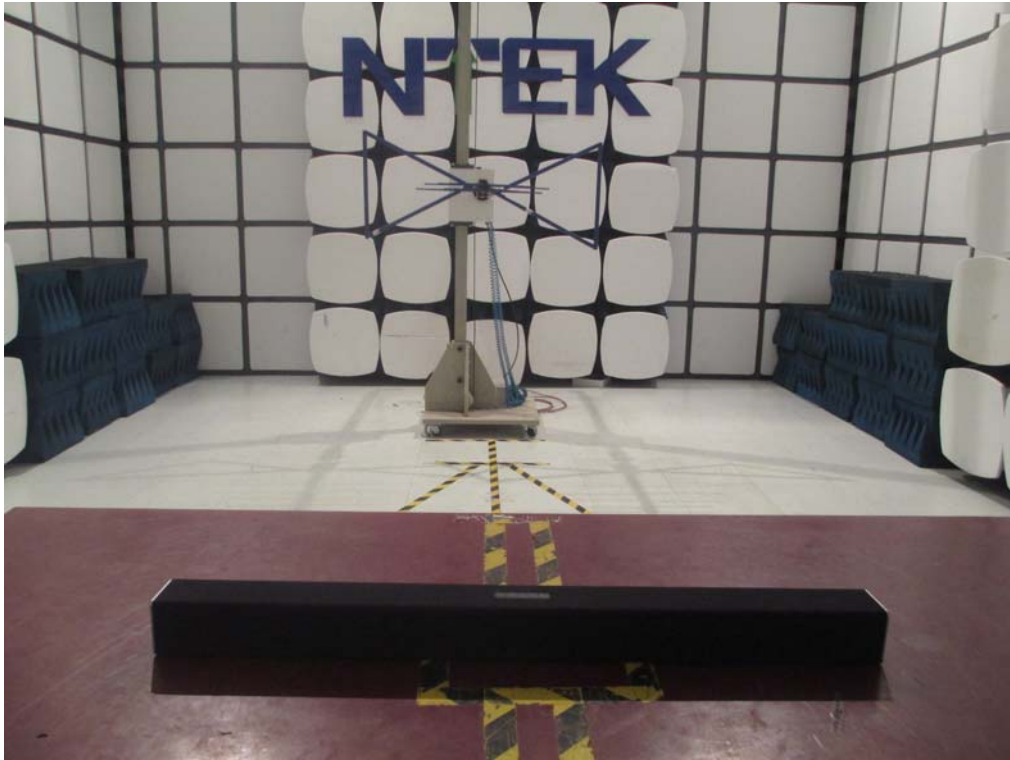

Conducted Measurement Photos

