

VIZIO



1202-0001161

QUICK START GUIDE

IMPORTANT SAFETY INSTRUCTIONS

Your Unit is designed and manufactured to operate within defined design limits, and misuse may result in electric shock or fire. To prevent your Unit from being damaged, the following rules should be observed for its installation, use, and maintenance. Please read the following safety instructions before operating your Unit. Keep these instructions in a safe place for future reference.

- Read these instructions.
- Keep these instructions.
- Heed all warnings.
- Follow all instructions.
- Do not use this apparatus near water.
- Clean only with a dry cloth.
- Do not block any ventilation openings. Install in accordance with the manufacturer's instructions.
- Do not install near any heat sources such as radiators, heat registers, stoves, or other apparatus (including amplifiers) that produce heat.
- Do not defeat the safety purpose of the polarized or grounding-type plug. A polarized plug has two blades with one wider than the other. A grounding type plug has two blades and a third grounding prong. The wide blade or the third prong are provided for your safety. If the provided plug does not fit into your outlet, consult an electrician for replacement of the obsolete outlet.
- Protect the power cord from being walked on or pinched, particularly at plugs, convenience receptacles, and the point where they exit from the apparatus.
- Only use attachments/accessories specified by the manufacturer.
- Use only with the cart, stand, tripod, bracket, or table specified by the manufacturer, or sold with the apparatus. When a cart is used, use caution when moving the cart/apparatus combination to avoid injury from tip-over.
- Unplug this apparatus during lightning storms or when unused for long periods of time.
- Refer all servicing to qualified service personnel. Servicing is required when the apparatus has been damaged in any way, such as when the power supply cord or plug is damaged, liquid has been spilled or objects have fallen into the apparatus, the apparatus has been exposed to rain or moisture, does not operate normally, or has been dropped.
- To reduce the risk of electric shock or component damage, switch off the power before connecting other components to your Unit.
- Unplug the power cord before cleaning your Unit. A damp cloth is sufficient for cleaning. Do not use a liquid or a spray cleaner on your Unit. Do not use abrasive cleaners.
- Always use the accessories recommended by the manufacturer to insure compatibility.
- When moving your Unit from an area of low temperature to an area of high temperature, condensation may form in the housing. Wait before turning on your Unit to avoid causing fire, electric shock, or component damage.
- Slots and openings in the back and bottom of the cabinet are provided for ventilation. To ensure reliable operation of your Unit and to protect it from overheating, be sure these openings are not blocked or covered. Do not place your Unit in a bookcase or cabinet unless proper ventilation is provided.
- Never push any object into the slots and openings on your Unit enclosure. Do not place any objects on the top of your Unit. Doing so could short circuit parts causing a fire or electric shock. Never spill liquids on your Unit.
- When connected to a power outlet, power is always flowing into your Unit. To totally disconnect power, unplug the power cord.



- Do not overload power strips and extension cords. Overloading can result in fire or electric shock.
- The wall socket should be located near your Unit and be easily accessible
- Keep your Unit away from moisture. Do not expose your Unit to rain or moisture. If water penetrates into your Unit, unplug the power cord and contact your dealer. Continuous use in this case may result in fire or electric shock.
- Do not use your Unit if any abnormality occurs. If any smoke or odor becomes apparent, unplug the power cord and contact your dealer immediately. Do not try to repair your Unit yourself.
- Avoid using dropped or damaged appliances. If your Unit is dropped and the housing is damaged, the internal components may function abnormally. Unplug the power cord immediately and contact your dealer for repair. Continued use of your Unit may cause fire or electric shock.
- Do not install your Unit in an area with heavy dust or high humidity. Operating your Unit in environments with heavy dust or high humidity may cause fire or electric shock.
- Ensure that the power cord and any other cables are unplugged before moving your Unit.
- When unplugging your Unit, hold the power plug, not the cord. Pulling on the power cord may damage the wires inside the cord and cause fire or electric shock. When your Unit will not be used for an extended period of time, unplug the power cord.
- To reduce risk of electric shock, do not touch the connector with wet hands.
- Insert the remote control batteries in accordance with instructions. Incorrect polarity may cause the battery to leak which can damage the remote control or injure the operator.
- See the important note and rating located on the back of the unit.
- WARNING - This equipment is not waterproof. To prevent a fire or shock hazard, do not place any container filled with liquid near the equipment (such as a vase or flower pot) or expose it to dripping, splashing, rain, or moisture.
- CAUTION - Danger of explosion or fire if batteries are mistreated. Replace only with the same or specified type.
- Do not leave the batteries exposed to direct sunlight for a long period of time with doors and windows closed. Do not disassemble the batteries or dispose of it in fire.

WARNING: To reduce the risk of fire or electric shock, do not expose this apparatus to rain or moisture.



Explanation of WARNING symbols:



The lightning flash with arrowhead symbol within an equilateral triangle is intended to alert the user to the presence of not isolated dangerous voltage within the product that may be sufficient magnitude to constitute a risk of shock to persons.



The exclamation point within an equilateral triangle is intended to alert the user to the presence of important operating and servicing instructions in the literature accompanying the appliance.

PACKAGE CONTENTS



High Definition Sound Bar



Remote Control
with Batteries



This Quick
Start Guide



Power Cable



Stereo RCA to 3.5mm
Audio Cable



Digital Optical
Cable



2 x Sound Bar Wall
Mount Brackets



2 x Wall
Mount Screws
(Size: M4 x 10mm)

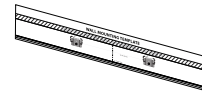

Wall Mount
Template

CONTROLS & CONNECTIONS

Back of Sound Bar



AUX (1)
Analog Audio In
(Stereo RCA)

Power Port

Service Port
For use by service technicians only.

USB* (6)
USB In

SUB OUT
Subwoofer Out

DIGITAL (3)
Coaxial In
OPTICAL (4)
Digital Optical Audio In
AUX (2)
Analog Audio In
(Stereo 3.5mm)

*Supports .WAV file format playback only

Back of Sound Bar

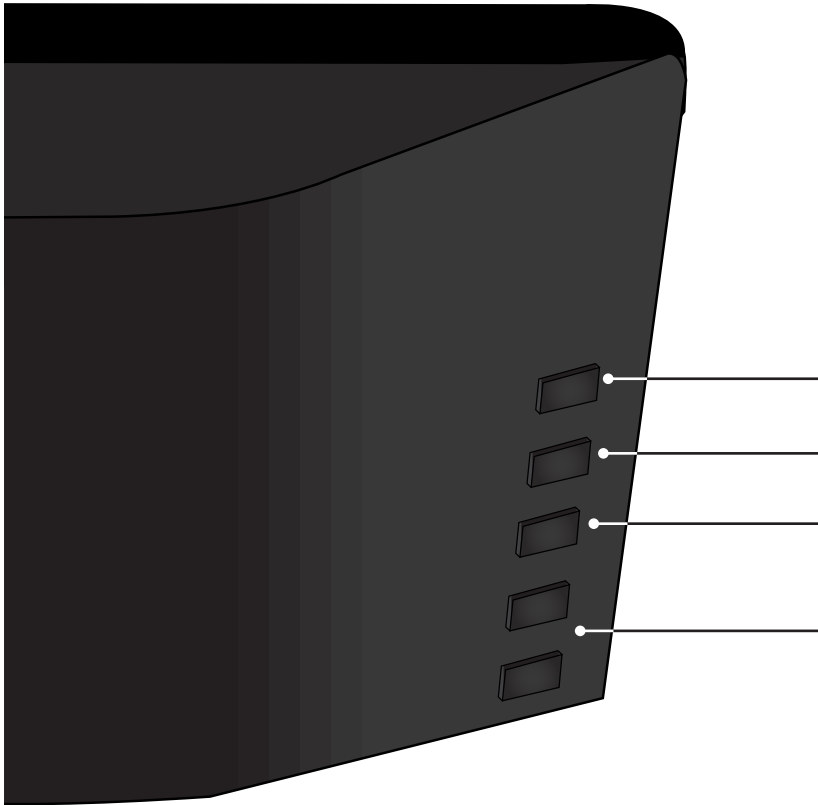

Control Buttons are located here:



Power Press to turn soundbar on or off.



Input Press to change the audio source.



Bluetooth Input Hold to pair.
(See 'Bluetooth Pairing' for more information.)



Volume Increase or decrease the loudness of the audio.

FIRST-TIME SETUP

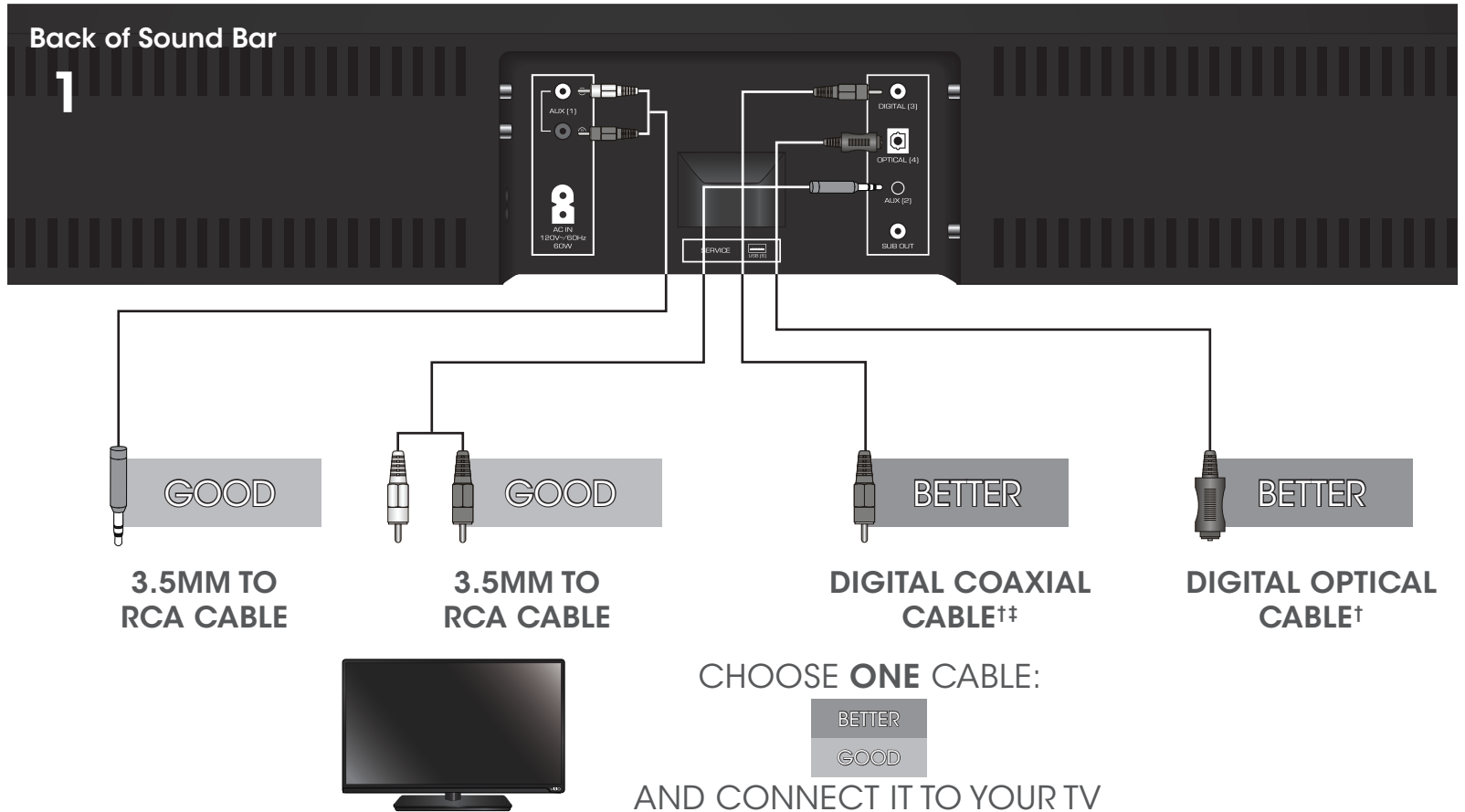

* Not all TVs have the audio outputs shown above. To connect the Sound Bar directly to your other devices (Blu-ray player, game system, etc.) see your device's user manual.

† When using either of the Digital Inputs, if there is no audio: (A) try setting the TV output to PCM or (B) Connect directly to your Blu-ray/other source, some TVs do not pass through digital audio.

‡ Cable not included.

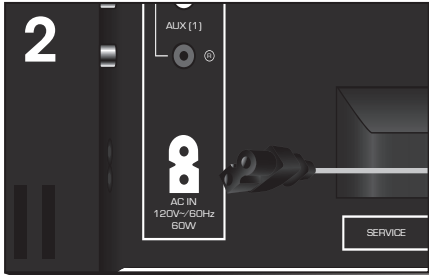

Connect the Power Cable to the Sound Bar.



Plug the Power Cable into a power outlet.

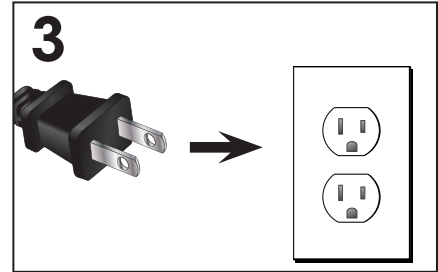

4

Sound Bar is centered
below the TV.

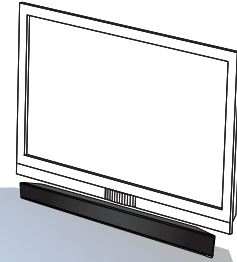

For the best surround sound experience, position the Sound Bar as shown.
The Sound Bar should be close to ear level.

5



Remove the battery cover by gently sliding it away from the remote.

6



Insert the included batteries and gently slide the battery cover back into place.

7

Turn your TV on, then press the **Power** button on the remote to turn the Sound Bar on.

Press the **Input** button to switch between audio sources. For example, if you connected your TV to Input 1, set the Sound Bar to Input 1.

Hardware setup is complete.

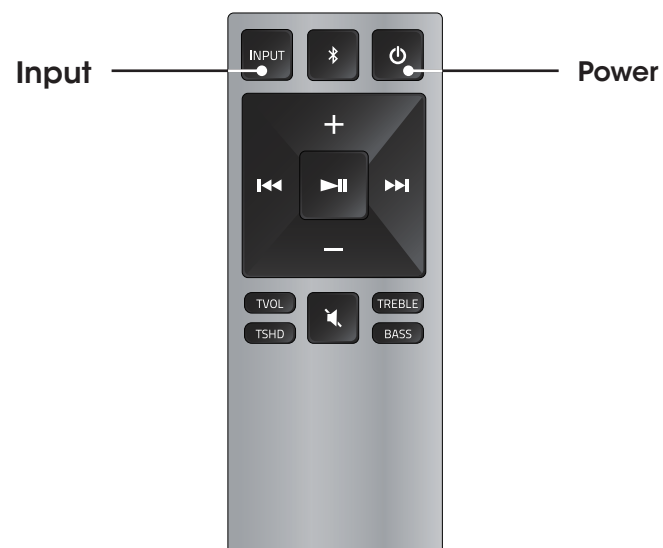

USING THE REMOTE

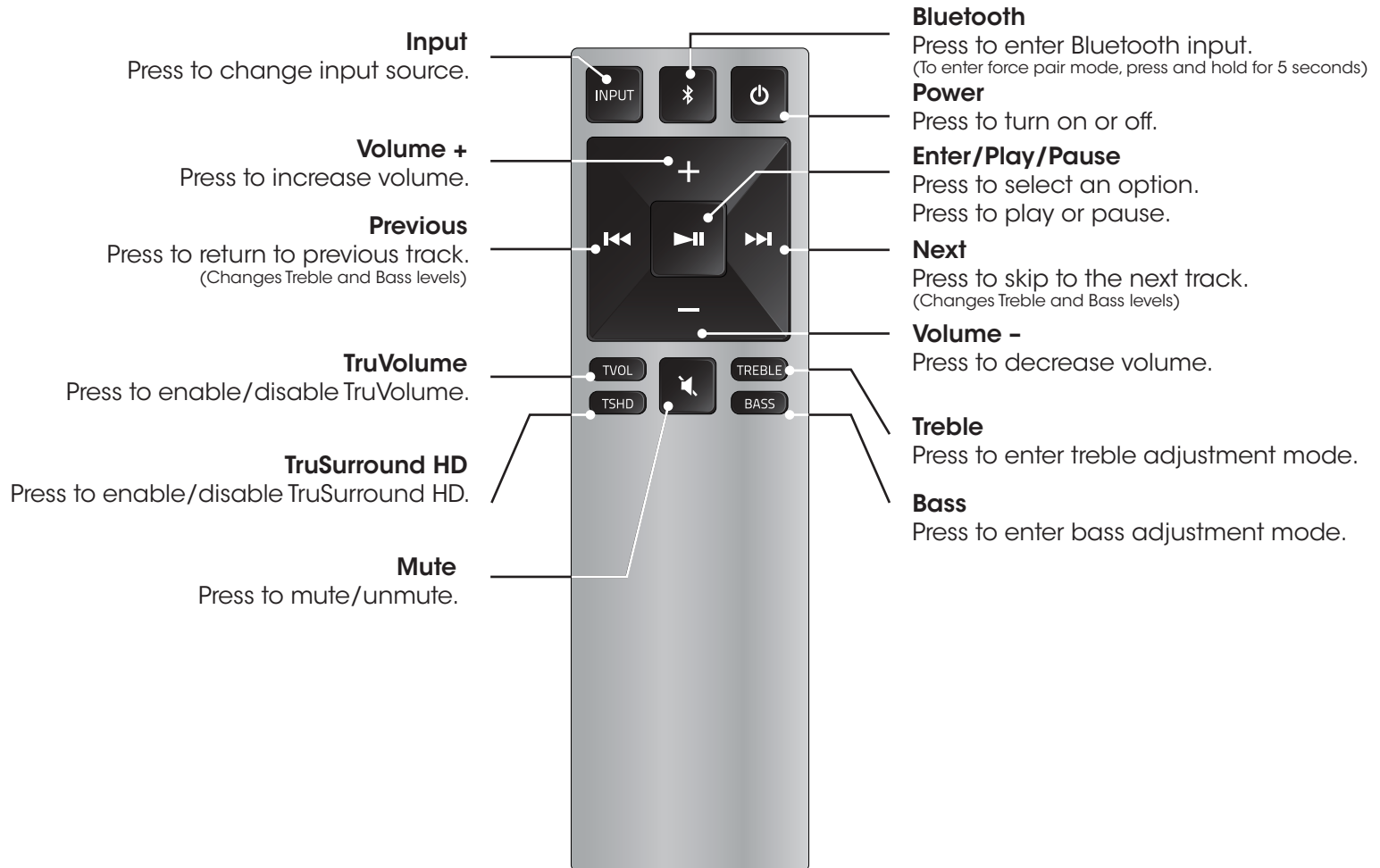



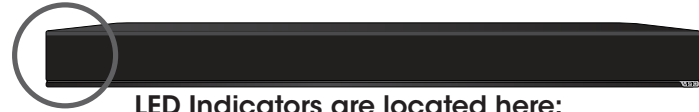







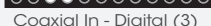

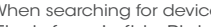
LED INDICATORS

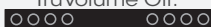

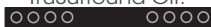

LED Indicators are located here:

The LED Indicators will behave differently with each button on the remote control.

Function	LED Behavior	Description
Input	Analog Audio In - AUX (1)  Analog Audio In - AUX (2)  Coaxial In - Digital (3)  Digital Optical Audio In - Optical (4)  Bluetooth 	Press the INPUT button on the remote to cycle through the available inputs: <ul style="list-style-type: none"> Analog Audio In - AUX Stereo RCA (1) Analog Audio In - AUX Stereo 3.5mm (2) Coaxial In- Digital (3) Digital Optical Audio In - Optical (4) Bluetooth
Bluetooth Pairing	(When searching for device) Flash from Left to Right and back continuously. 	Press and hold the  button on the remote. The Sound Bar will be discoverable for 15 minutes. You can now search for the Sound Bar (VIZIO S3820w) using your Bluetooth Device. The sound bar will power down if no device is found. Note: Set your Bluetooth device into pairing mode prior to the Sound Bar.
DTS TruVolume On/Off	TruVolume On:  TruVolume Off: 	Press the TVOL button to enable/disable TruVolume. When enabled (On), TruVolume provides a consistent and comfortable volume level for a more enjoyable listening experience.
DTS TruSurround On/Off	TruSurround On:  TruSurround Off: 	Press the TSHD button to enable/disable DTS TruSurround. When enabled (On), all inputs will produce virtual surround sound. When disabled (Off), all sources will playback in stereo.
Treble Levels	Two center LEDs indicate Treble level 0. 	Press the TREBLE button then press the Next/Previous button to increase/decrease the treble level. The LED indicators will move to the right with increasing levels and to the left with decreasing levels.
Bass Levels	Two center LEDs indicate Bass level 0. 	Press the BASS button then press the Next/Previous button to increase/decrease the bass level. The LED indicators will move to the right with increasing levels and to the left with decreasing levels.
Dolby Digital	Dolby Digital Logo. 	Dolby Digital is only available on either the Coaxial In or Digital Optical Audio In inputs. When a Dolby Digital signal is detected, the Dolby Digital logo will light up for 5 seconds before fading away.

BLUETOOTH PAIRING

To pair the Sound Bar with a Bluetooth device:

1. Press and hold the **Bluetooth** button  on the Sound Bar or the **Bluetooth** button  on the remote for five (5) seconds. When the Sound Bar is in Bluetooth Pairing Mode, the LED Indicators on the Display Panel on the front of the Sound Bar will light sequentially from left to right and back again.

Once the device is paired, the LED Indicators will stop flashing.

2. You can now search for the Sound Bar (VIZIO S3820w) using your Bluetooth device. For more information, see the documentation that came with your device.
3. Play audio from your Bluetooth device. Volume can be controlled on your source device and the Sound Bar.

Back of Sound Bar

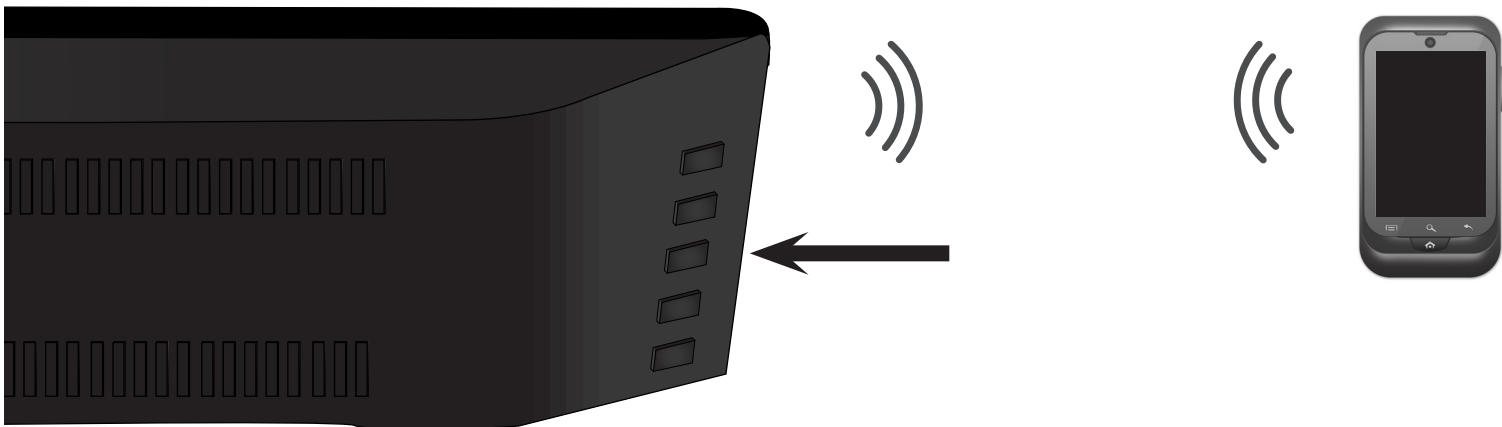

USING BLUETOOTH MODE

Your Sound Bar supports music streaming from smartphones, tablets, and computers with Bluetooth capability. Device compatibility will vary, see your device's documentation for more information. Once you have paired your source device to the Sound Bar, as long as you stay within range of the Sound Bar, your device should remain paired, even if you change the input on the Sound Bar.



Your Sound Bar is not equipped with a microphone, so it cannot operate as a hands-free device for a smartphone.

Maximizing Signal

A Bluetooth signal has a range of up to 30 feet. Keep in mind that Bluetooth is a compressed audio format, so streamed music may lose some integrity when compared to a wired connection.

Try the following if your sound quality is less than optimal:

- If you hear any break-up or disconnect while streaming music from your device, move the source device closer to the Sound Bar.
- Be sure that there are no solid obstructions in the line-of-sight between the Sound Bar and the source device.
- Other wireless devices can affect Bluetooth range, including wireless security cameras, wireless video baby monitors, cordless phones, and microwave ovens. Turning off or moving these devices may improve Bluetooth range.



Reduce the volume levels on your device and on the Sound Bar before pressing **Play**. High volume levels can damage your hearing.

ADVANCED SETUP

Connect up to four (4) different devices to the Sound Bar (devices shown are examples; you can use any device).

To listen to a device, change the input source on the Sound Bar.

Optical, Coaxial, and 3.5mm cables transmit audio only. Connecting a video device requires a separate video connection from the device to your TV.

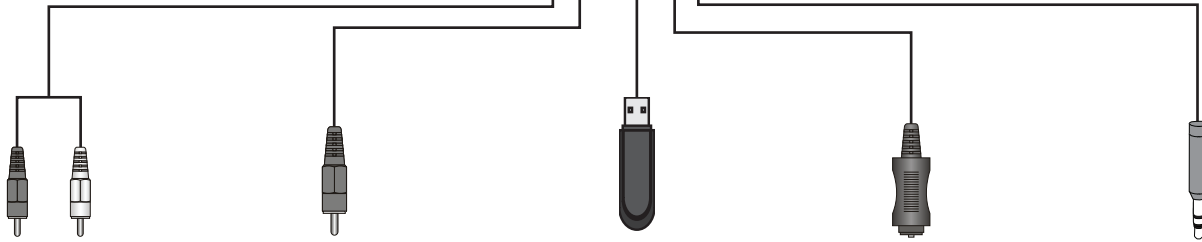
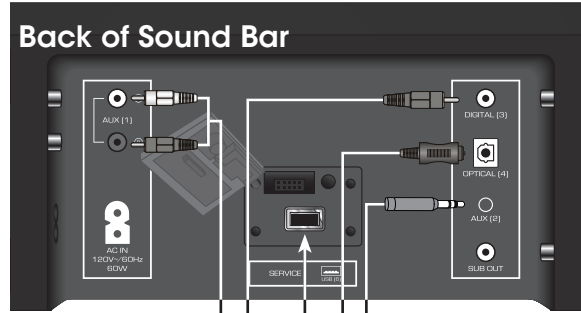

RCA AUDIO CABLE

DIGITAL COAXIAL CABLE

USB THUMB DRIVE*

DIGITAL OPTICAL CABLE†

3.5mm AUDIO CABLE



Game Console



Network Media Player



Tablet/MP3 Player/Laptop

† Cable not included.
* Supports .WAV file format playback only.

CONNECTING A SUBWOOFER



Back of Sound Bar

Optional Subwoofer*



RCA Subwoofer Cable*

To connect a subwoofer:

1. Press the **BASS** button on the remote control to enter bass adjustment mode.
2. Use the **Previous/Next** buttons to adjust the bass level to the center position.
3. Power **Off** the Sound Bar and Subwoofer. Connect an RCA cable from the Sound Bar to the Subwoofer.
4. Power **On** the Sound Bar and Subwoofer.
5. Manually adjust the SUB gain (Volume) and phase to your preference. See your subwoofer's user manual for more information.
6. Use the **BASS** button on the remote control to adjust the subwoofer's output.

*RCA subwoofer cable and subwoofer not included.

WALL MOUNTING THE SOUND BAR

1

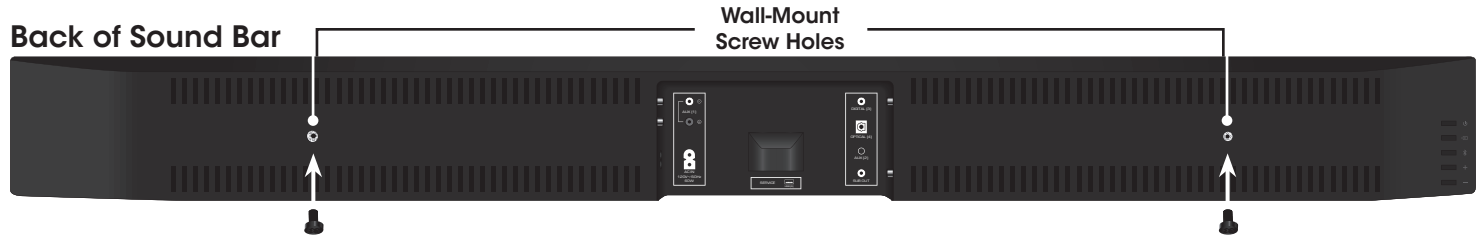

Insert the two wall-mount screws into the wall-mount screw holes, and then tighten them with a Phillips screwdriver.

2

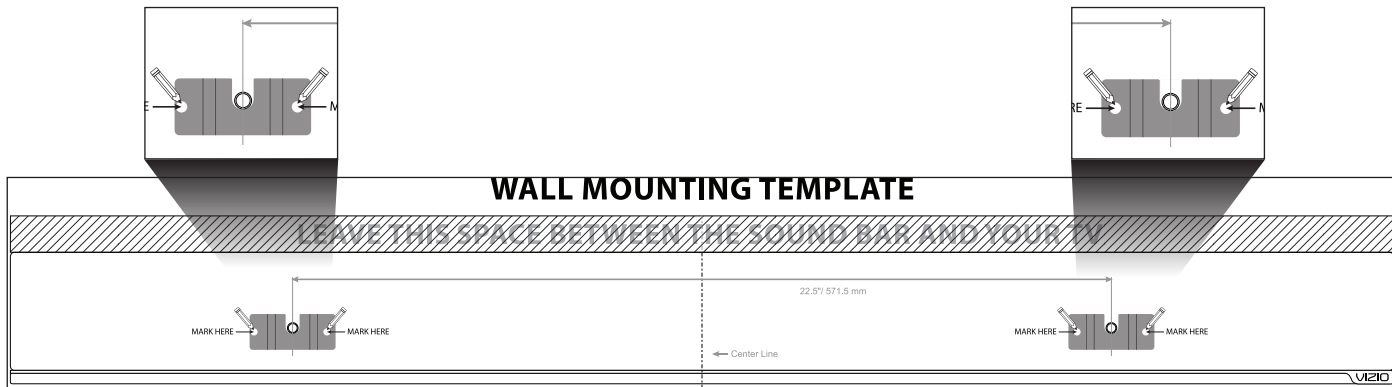

Place the included wall mounting template against the wall under your TV. Mark the four bracket holes using a pencil.

3



Be sure your screws are attached to wood studs, drywall anchors (for drywall), or concrete anchors (for brick/concrete walls).

Screws for attaching the brackets to the wall are not included. Choose the screw type and length appropriate to your home's construction. If in doubt, consult a professional installer.

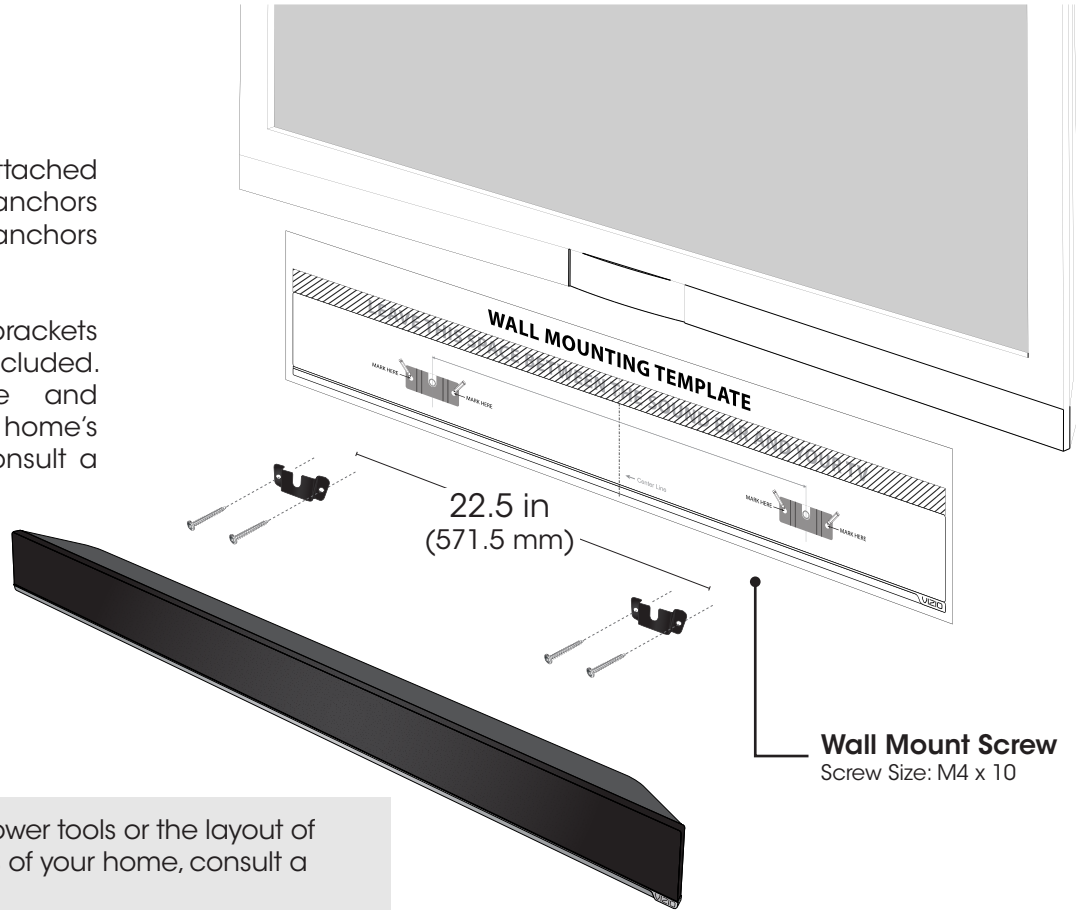





Wall Mount Screw
Screw Size: M4 x 10



If you are unfamiliar with power tools or the layout of electrical wiring in the walls of your home, consult a professional installer.

USING BUTTON COMBINATIONS

There are 3 functions that are triggered by 3 different button combinations on the Sound Bar.

Function	LED Behavior	Description
Factory Reset	All 12 LEDs will flash 3 times: 	Reset the Sound Bar to the factory default settings. To perform a Factory Reset, <u>Press and Hold</u> the Bluetooth (⌘) and Volume Down (←) buttons for 5 seconds . Note: This will erase all settings and preferences that you have set.
VIZIO TV Remote Control	Enable VIZIO TV Remote:  Disable VIZIO TV Remote: 	Enable/disable the use of a VIZIO TV remote control to power on and adjust the volume of the sound bar. To enable/disable this function, <u>Press and Hold</u> the Power (⏻) and Volume Up (+) buttons for 5 seconds .
Energy Star	Enable Energy Star:  Disable Energy Star: 	When the Energy Star setting is enabled, the sound bar will automatically power down after a period of inactivity. When disabled, the sound bar will remain powered on until you turn it off. To enable/disable this function, <u>Press and Hold</u> the Power (⏻) and Volume Down (←) buttons for 5 seconds . Note: Energy Star setting is enabled by default.

Back of Sound Bar

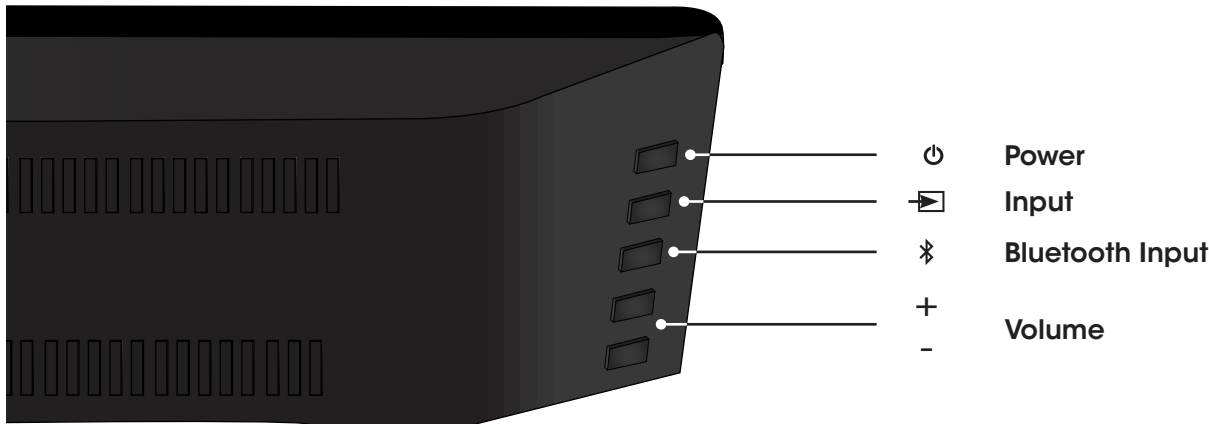

HELP & TROUBLESHOOTING

There is no power.

- Press the **POWER** button on the remote control or on the top of your Sound Bar.
- Ensure the power cord is securely connected.
- Plug a different device into the electrical outlet to verify that the outlet is working correctly.

There is no sound.

- Increase the volume. Press **Volume Up** on the remote control or on the top of your Sound Bar.
- Press **MUTE** on the remote to ensure the Sound Bar is not muted.
- Press **INPUT** on the remote or on the top of your Sound Bar to select a different input source.
- When using either of the Digital Inputs, if there is no audio: (A) Try setting the TV output to PCM or (B) Connect directly to your Blu-ray/other source, some TVs do not pass through digital audio.
- On digital inputs, the input LEDs will flash rapidly if an unsupported format is present. Set the source to output PCM.
- Your TV may be set to variable audio output. Confirm that the audio output setting is set to FIXED or STANDARD, not VARIABLE. Consult your TV's user manual for more detailed information.
- If using Bluetooth, ensure that the volume on your source device is turned up and that the device is not muted.

I hear buzzing or humming.

- Ensure all cables and wires are securely connected.
- Connect a different source device (TV, Blu-ray player, etc) to see if the buzzing persists. If it does not, the problem may be with the original device.
- Connect your device to a different input on the Sound Bar.

The remote isn't working.

- Replace the remote batteries with new ones.
- Point the remote directly at the center of the Sound Bar when pressing a button.
- If using a Bluetooth connection, some of the buttons on the remote may not be supported by the streaming application. (e.g., Pandora doesn't support the Back button.)

Take A Moment To Register Your Product At

VIZIO.COM/PRODUCT-REGISTRATION

Why Register?



Customized Support

Get assistance quickly with your information on-hand.



News & Offers

Take advantage of the latest news and special offers from VIZIO.



Safety & Satisfaction

Stay up to date with important product updates and notifications.

REGISTER YOUR VIZIO PRODUCT NOW

Do You Have Questions? Find Answers At

SUPPORT.VIZIO.COM

Find help with:

- New Product Setup
- Connecting Your Devices
- Technical Problems
- Product Updates
- And More



**Live Chat
Support Available**

You can also contact our
award-winning support team at:

Phone: (877) 878-4946 (TOLL-FREE)

Email: techsupport@VIZIO.com

Hours Of Operation:

Monday - Friday: 7 AM TO 11 PM (CST)

Saturday - Sunday: 9 AM TO 6 PM (CST)



ONE-YEAR LIMITED WARRANTY

ON PARTS AND LABOR

Covers units purchased as new in United States and Puerto Rico Only

VIZIO provides a warranty to the original purchaser of a new Product against defects in materials and workmanship for a period of one year of non-commercial usage and ninety (90) days of commercial use. If a Product covered by this warranty is determined to be defective within the warranty period, VIZIO will either repair or replace the Product at its sole option and discretion.

To obtain warranty service, contact VIZIO Technical Support via email: TechSupport@VIZIO.com or via phone at 877 MY VIZIO (877.698.4946) from 5:00AM to 9:00PM Monday through Friday and 8:00AM to 4:00PM Saturday and Sunday, Pacific Time, or visit www.VIZIO.com. PRE-AUTHORIZATION MUST BE OBTAINED BEFORE SENDING ANY PRODUCT TO A VIZIO SERVICE CENTER. Proof of purchase in the form of a purchase receipt or copy thereof is required to show that a Product is within the warranty period.

Parts and Labor

There will be no charge for parts or labor during the warranty period. Replacement parts and Products may be new or recertified at VIZIO's option and sole discretion. Replacement parts and Products are warranted for the remaining portion of the original warranty or for ninety (90) days from warranty service or replacement, whichever is greater.

Type of Service

Defective Products must be sent to a VIZIO service center to obtain warranty service. VIZIO is not responsible for transportation costs to the service center, but VIZIO will cover return shipping to the customer. PRE-AUTHORIZATION IS REQUIRED BEFORE SENDING ANY PRODUCT TO A VIZIO SERVICE CENTER FOR WARRANTY SERVICE.

Product returns to VIZIO's service centers must utilize either the original carton box and shipping material or packaging that affords an equal degree of protection. VIZIO Technical Support will provide instructions for packing and shipping the covered Product to the VIZIO service center.

Limitations and Exclusions

VIZIO's one-year limited warranty only covers defects in materials and workmanship. This warranty does not cover, for example: cosmetic damage, normal wear and tear, improper operation, improper voltage supply or power surges, signal issues, damages from shipping, acts of God, any type of customer misuse, modifications or adjustments, as well as installation and set-up issues or any repairs attempted by anyone other than by a VIZIO authorized service center. Products with unreadable or removed serial numbers, or requiring routine maintenance are not covered. This one year limited warranty does not cover Products sold "AS IS", "FACTORY RECERTIFIED", or by a non-authorized reseller.

THERE ARE NO EXPRESS WARRANTIES OTHER THAN THOSE LISTED OR DESCRIBED ABOVE. ANY IMPLIED WARRANTIES, INCLUDING ANY IMPLIED WARRANTY OF MERCHANTABILITY AND FITNESS FOR A PARTICULAR PURPOSE, SHALL BE LIMITED IN DURATION TO THE PERIOD OF TIME SET FORTH ABOVE. VIZIO'S TOTAL LIABILITY FOR ANY AND ALL LOSSES AND DAMAGES RESULTING FROM ANY CAUSE WHATSOEVER INCLUDING VIZIO'S NEGLIGENCE, ALLEGED DAMAGE, OR DEFECTIVE GOODS, WHETHER SUCH DEFECTS ARE DISCOVERABLE OR LATENT, SHALL IN NO EVENT EXCEED THE PURCHASE PRICE OF THE PRODUCT. VIZIO SHALL NOT BE RESPONSIBLE FOR LOSS OF USE, LOSS OF INFORMATION OR DATA, COMMERCIAL LOSS, LOST REVENUE OR LOST PROFITS, OR OTHER INCIDENTAL OR CONSEQUENTIAL DAMAGES. SOME STATES DO NOT ALLOW LIMITATIONS ON HOW LONG AN IMPLIED WARRANTY LASTS OR THE EXCLUSION OF INCIDENTAL OR CONSEQUENTIAL DAMAGES, SO THE ABOVE LIMITATIONS OR EXCLUSIONS MAY NOT APPLY TO YOU. THIS WARRANTY GIVES YOU SPECIFIC LEGAL RIGHTS, AND YOU MAY ALSO HAVE OTHER RIGHTS, WHICH VARY FROM STATE TO STATE. THIS WARRANTY IS SUBJECT TO CHANGE WITHOUT NOTICE. CHECK www.VIZIO.com FOR THE MOST CURRENT VERSION.

SPECIFICATIONS

Sound Bar: Two 3" High-Efficiency Full-Range Transducers
Two 2" x 4" Bass Radiators

Inputs: One 3.5mm Stereo Audio
One RCA Stereo Audio
One Optical (Toslink)
One Digital Coaxial Audio
Bluetooth (Wireless)

Sound Pressure Level (System): 98 dB

Frequency Response (System): 70 Hz - 19 KHz

Voltage: 120 VAC, 60 Hz

Compliances: UL, C-UL, FCC

LEGAL & COMPLIANCE

FCC Class B Radio Interference Statement

NOTE: This equipment has been tested and found to comply with the limits for a Class B digital device, pursuant to Part 15 of the FCC Rules. These limits are designed to provide reasonable protection against harmful interference in a residential installation. This equipment generates, uses and can radiate radio frequency energy, and if not installed and used in accordance with the instructions, may cause harmful interference to radio communications. However, there is no guarantee that interference will not occur in a particular installation. If this equipment does cause harmful interference to radio or television reception, which can be determined by turning the equipment off and on, the user is encouraged to try to correct the interference by one or more of the following measures:

1. Reorient or relocate the receiving antenna.
2. Increase the separation between the equipment and receiver.
3. Connect the equipment into an outlet on a circuit different from that to which the receiver is connected.
4. Consult the dealer or an experienced radio/TV technician for help.

This device complies with Part 15 of the FCC Rules. Operation is subject to the following two conditions: (1) this device may not cause harmful interference, and (2) this device must accept any interference received, including interference that may cause undesired operation.

Notice:

1. The changes or modifications not expressly approved by the party responsible for compliance could void the user's authority to operate the equipment.
2. Shielded interface cables and AC power cord, if any, must be used in order to comply with the emission limits.
3. The manufacturer is not responsible for any radio or TV interference caused by unauthorized modification to this equipment. It is the responsibilities of the user to correct such interference.

RF Exposure Information

This device meets the government's requirements for exposure to radio waves. This device is designed and manufactured not to exceed the emission limits for exposure to radio frequency (RF) energy set by the Federal Communications Commission of the U.S. Government. This device complies with FCC radiation exposure limits set forth for an uncontrolled environment.

IC Statement

This device complies with Industry Canada's licence-exempt RSSs. Operation is subject to the following two conditions:

- (1) This device may not cause interference; and
 - (2) This device must accept any interference, including interference that may cause undesired operation of the device.
2. Changes or modifications not expressly approved by the party responsible for compliance could void the user's authority to operate the equipment.

Cet appareil est conforme aux CNR exemptés de licence d'Industrie Canada .

Son fonctionnement est soumis aux deux conditions suivantes :

- (1) Ce dispositif ne peut causer d'interférences ; et
- (2) Ce dispositif doit accepter toute interférence ,
y compris les interférences qui peuvent causer un mauvais fonctionnement de l'appareil.

IC Radiation Exposure Statement

This equipment complies with IC RSS-102 radiation exposure limits set forth for an uncontrolled environment.

Disposal and Recycling

You must dispose of this product properly, according to local laws and regulations. Because this product contains electronic components and a battery, it must be disposed of separately from household waste. Contact local authorities to learn about disposal and recycling options.

Other:

Image(s) used under license from Shutterstock.com



For DTS patents, see <http://patents.dts.com>. Manufactured under license from DTS Licensing Limited. DTS, the Symbol, & DTS and the Symbol together are registered trademarks, and DTS TruSurround is a trademark of DTS, Inc. © DTS, Inc. All Rights Reserved.



For DTS patents, see <http://patents.dts.com>. Manufactured under license from DTS Licensing Limited. DTS, the Symbol, & DTS and the Symbol together are registered trademarks, and DTS TruVolume is a trademark of DTS, Inc. © DTS, Inc. All Rights Reserved.



This product qualifies for ENERGY STAR in the "factory default" setting and this is the setting in which power savings will be achieved. Changing the factory default settings or enabling other features will increase power consumption that could exceed the limits necessary to qualify for ENERGY STAR rating.

We want to help you save energy.

