

Test Report

FCC ID: XN6-SB2020NJ6

Applicant: Zylux Acoustic Corporation

Address: 7F, 70, Rui Guang Road, Neihu District, Taipei 114, Taiwan

Manufacturer: Zylux Acoustic Corporation

Address: 7F, 70, Rui Guang Road, Neihu District, Taipei 114, Taiwan

Product: 20" Sound Bar 2.0 System

Brand: 

Test Model(s): SB2020n-J6

Series Model(s): N/A

Test Date: Dec.25, 2020 ~ Jan. 08, 2021

Issued By: Hwa-Hsing (Dongguan) Testing Co., Ltd.

Address: No.101, Bld N1, Yuyuan 2Rd, Yuyuan Industrial Park, HuangJiang Town, Dongguan, China

FCC Designation No.: CN1255

Standards: 47 CFR FCC Part 15, Subpart C (Section 15.247)
ANSI C63.10:2013

The above equipment has been tested by **Hwa-Hsing (Dongguan) Testing Co., Ltd.**, and found compliance with the requirement of the above standards. The test record, data evaluation & Equipment Under Test (EUT) configurations represented herein are true and accurate accounts of the measurements of the sample's EMC characteristics under the conditions specified in this report.

Prepared by :



Date: Jan. 12, 2021

Scott He/ Project Engineer

Approved by :

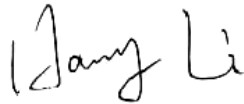

Date: Jan. 15, 2021

Harry Li/ Technical Director

This report is for your exclusive use. Any copying or replication of this report to or for any other person or entity, or use of our name or trademark, is permitted only with our prior written permission. This report sets forth our findings solely with respect to the test samples identified herein. The results set forth in this report are not indicative or representative of the quality or characteristics of the lot from which a test sample was taken or any similar or identical product unless specifically and expressly noted. Our report includes all of the tests requested by you and the results thereof based upon the information that you provided to us. You have 60 days from date of issuance of this report to notify us of any material error or omission caused by our negligence, provided, however, that such notice shall be in writing and shall specifically address the issue you wish to raise. A failure to raise such issue within the prescribed time shall constitute your unqualified acceptance of the completeness of this report, the tests conducted and the correctness of the report contents. Unless specific mention, the uncertainty of measurement has been explicitly taken into account to declare the compliance or non-compliance to the specification. The report must not be used by the client to claim product certification, approval, or endorsement by A2LA or any agency of the federal government. The report must not be used by the client to claim product certification, approval, or endorsement by TAF or any government agencies.

Table of Contents

Release Control Record	4
1 Summary of Test Results	5
1.1 Measurement Uncertainty.....	5
1.2 Modification Record.....	5
2 General Information	6
2.1 General Description of EUT.....	6
2.2 Description of Test Modes.....	7
2.2.1 Test Mode Applicability and Tested Channel Detail.....	8
2.3 Description of Support Units.....	9
2.3.1 Configuration of System under Test.....	9
2.4 General Description of Applied Standards.....	10
3 Test Types and Results	11
3.1 Radiated Emission and Bandedge Measurement.....	11
3.1.1 Limits of Radiated Emission and Bandedge Measurement.....	11
3.1.2 Test Instruments.....	12
3.1.3 Test Procedures.....	13
3.1.4 Deviation from Test Standard.....	13
3.1.5 Test Setup.....	14
3.1.6 EUT Operating Conditions.....	15
3.1.7 Test Results.....	16
3.2 Conducted Emission Measurement.....	28
3.2.1 Limits of Conducted Emission Measurement.....	28
3.2.2 Test Instruments.....	28
3.2.3 Test Procedures.....	28
3.2.4 Deviation from Test Standard.....	28
3.2.5 Test Setup.....	29
3.2.6 EUT Operating Condition.....	29
3.2.7 Test Results.....	30
3.3 Number of Hopping Frequency Used.....	32
3.3.1 Limits of Hopping Frequency Used Measurement.....	32
3.3.2 Test Setup.....	32
3.3.3 Test Instruments.....	32
3.3.4 Test Procedure.....	32
3.3.5 Deviation from Test Standard.....	32
3.3.6 Test Results.....	33
3.4 Dwell Time on Each Channel.....	34
3.4.1 Limits of Dwell Time on Each Channel Measurement.....	34
3.4.2 Test Setup.....	34
3.4.3 Test Instruments.....	34
3.4.4 Test Procedures.....	34
3.4.5 Deviation from Test Standard.....	34
3.4.6 Test Results.....	35
3.5 Channel Bandwidth.....	38
3.5.1 Limits of Channel Bandwidth Measurement.....	38
3.5.2 Test Setup.....	38
3.5.3 Test Instruments.....	38
3.5.4 Test Procedure.....	38
3.5.5 Deviation from Test Standard.....	38
3.5.6 EUT Operating Condition.....	38
3.5.7 Test Results.....	39
3.6 Occupied Bandwidth Measurement.....	40
3.6.1 Test Setup.....	40

3.6.2	Test Instruments	40
3.6.3	Test Procedure	40
3.6.4	Deviation from Test Standard	40
3.6.5	EUT Operating Conditions.....	40
3.6.6	Test Results	41
3.7	Hopping Channel Separation.....	42
3.7.1	Limits of Hopping Channel Separation Measurement.....	42
3.7.2	Test Setup.....	42
3.7.3	Test Instruments	42
3.7.4	Test Procedure	42
3.7.5	Deviation from Test Standard	42
3.7.6	Test Results	43
3.8	Maximum Output Power	44
3.8.1	Limits of Maximum Output Power Measurement	44
3.8.2	Test Setup.....	44
3.8.3	Test Instruments	44
3.8.4	Test Procedure	44
3.8.5	Deviation from Test Standard	44
3.8.6	EUT Operating Condition	44
3.8.7	Test Results	45
3.9	Conducted Out of Band Emission Measurement	46
3.9.1	Limits of Conducted Out of Band Emission Measurement.....	46
3.9.2	Test Instruments	46
3.9.3	Test Procedure	46
3.9.4	Deviation from Test Standard	46
3.9.5	EUT Operating Condition	46
3.9.6	Test Results	47
4	Pictures of Test Arrangements.....	51
4.1.2	Test Instruments.....	51
Appendix – Information on the Testing Laboratories		52

Release Control Record

Issue No.	Description	Date Issued
201022KH17-FR	Original Release	Jan. 15, 2021

1 Summary of Test Results

47 CFR FCC Part 15, Subpart C (Section 15.247)			
ANSI C63.10:2013; KDB 558074 D01 15.247 Meas Guidance v05r02			
FCC Clause	Test Item	Result	Remarks
15.207	AC Power Conducted Emission	Pass	Meet the requirement of limit.
15.247(a)(1) (iii)	Number of Hopping Frequency Used	Pass	Meet the requirement of limit.
15.247(a)(1) (iii)	Dwell Time on Each Channel	Pass	Meet the requirement of limit.
15.247(a)(1)	1. Hopping Channel Separation 2. Spectrum Bandwidth of a Frequency Hopping Sequence Spread Spectrum System	Pass	Meet the requirement of limit.
15.247(b)	Maximum Peak Output Power	Pass	Meet the requirement of limit.
---	Occupied Bandwidth Measurement	Pass	Reference only
15.205 & 209	Radiated Emissions	Pass	Meet the requirement of limit.
15.247(d)	Band Edge Measurement	Pass	Meet the requirement of limit.
15.247(d)	Antenna Port Emission	Pass	Meet the requirement of limit.
15.203	Antenna Requirement	Pass	No antenna connector is used.

Note: If the Frequency Hopping System operating in 2400-2483.5 MHz band and the output power less than 125mW. The hopping channel carrier frequencies separated by a minimum of 25 kHz or two-thirds of the 20 dB bandwidth of hopping channel whichever is greater.

1.1 Measurement Uncertainty

Where relevant, the following measurement uncertainty levels have been estimated for tests performed on the EUT as specified in CISPR 16-4-2:

The listed uncertainties are the worst-case uncertainty for the entire range of measurement. Please note that the uncertainty values are provided for informational purposes only and are not used in determining the PASS/FAIL results.

Measurement	Frequency	Expanded Uncertainty (k=2) (\pm)
Conducted Emissions at mains ports	150 kHz ~ 30 MHz	2.66 dB
Radiated Emissions up to 1 GHz	9KHz ~ 30MHz	2.90dB
	30 MHz ~ 1000 MHz	3.47 dB
Radiated Emissions above 1 GHz	1 GHz ~ 18 GHz	4.84 dB
	18 GHz ~ 40 GHz	4.62 dB

Note: This uncertainty represents an expanded uncertainty expressed at approximately the 95% confidence level using a coverage factor of $k = 2$.

1.2 Modification Record

There were no modifications required for compliance.

2 General Information

2.1 General Description of EUT

Product	20" Sound Bar 2.0 System
Brand	
Test Model(s)	SB2020n-J6
Series Model(s)	N/A
FCC ID:	XN6-SB2020NJ6
Identification No. of EUT	N/A
Status of EUT	Engineering prototype
Power Supply Rating	AC100-240V, 50/60Hz, 10W
Modulation Type	GFSK, $\pi/4$ DQPSK, 8DPSK
Transfer Rate	1/2/3 Mbps
Operating Frequency	2402 ~ 2480 MHz
Number of Channel	79
Output Power	3.034mW(4.82dBm)
Antenna Type	PCB Antenna
Antenna Gain	4.1 dBi Maximum peak Gain
Antenna Connector	N/A
Accessory Device	IR Remote Controller
Cable Supplied	AC line: 1.6m, un-shielding Stereo RCA to 3.5mm Audio Cable : 1.1m, un-shielding

Note:

1. Please refer to the EUT photo document (Reference No.: 201022KH17) for detailed product photo.
2. The above EUT information is declared by manufacturer and for more detailed features description, please refer to the manufacturer's specifications or User's Manual.
3. For the test results, the EUT had been tested with all power board, the worst case was show in test report.

Power board difference:

Manufacturer	Model	Input	Output
DONGGUAN DONGSONG ELECTRONIC CO., LTD	DSP120-120100W	100-240Vac 50/60Hz; 0.5A max.	12Vdc, 1.0A
Chou Sen Electronics Co., LTD	CS12J120100FO	100-240Vac 50/60Hz; 0.5A max.	12Vdc, 1.0A

2.2 Description of Test Modes

79 channels are provided to this EUT:

Channel	Freq. (MHz)	Channel	Freq. (MHz)	Channel	Freq. (MHz)	Channel	Freq. (MHz)
0	2402	20	2422	40	2442	60	2462
1	2403	21	2423	41	2443	61	2463
2	2404	22	2424	42	2444	62	2464
3	2405	23	2425	43	2445	63	2465
4	2406	24	2426	44	2446	64	2466
5	2407	25	2427	45	2447	65	2467
6	2408	26	2428	46	2448	66	2468
7	2409	27	2429	47	2449	67	2469
8	2410	28	2430	48	2450	68	2470
9	2411	29	2431	49	2451	69	2471
10	2412	30	2432	50	2452	70	2472
11	2413	31	2433	51	2453	71	2473
12	2414	32	2434	52	2454	72	2474
13	2415	33	2435	53	2455	73	2475
14	2416	34	2436	54	2456	74	2476
15	2417	35	2437	55	2457	75	2477
16	2418	36	2438	56	2458	76	2478
17	2419	37	2439	57	2459	77	2479
18	2420	38	2440	58	2460	78	2480
19	2421	39	2441	59	2461		

2.2.1 Test Mode Applicability and Tested Channel Detail

EUT Configure Mode	Applicable To				Description
	RE≥1G	RE<1G	PLC	APCM	
-	√	√	√	√	AC120V/60Hz

Where **RE≥1G**: Radiated Emission above 1 GHz **RE<1G**: Radiated Emission below 1 GHz
PLC: Power Line Conducted Emission **APCM**: Antenna Port Conducted Measurement

Note:

1. For Radiated emission test, pre-tested GFSK, π/4-DQPSK, 8DPSK modulation type and found GFSK was the worse, therefore chosen for the final test and presented in the test report.
2. The EUT had been pre-tested on the positioned of each 3 Axis. The worst case was found when positioned on **X-plane**.
3. "-" means no effect.

Radiated Emission Test (Above 1 GHz):

- Pre-Scan has been conducted to determine the worst-case mode from all possible combinations between available modulations, data rates and antenna ports (if EUT with antenna diversity architecture).
- Following channel(s) was (were) selected for the final test as listed below.

EUT Configure Mode	Available Channel	Tested Channel	Modulation Technology	Modulation Type	Packet Type
-	0 to 78	0, 39, 78	FHSS	GFSK	DH5
-	0 to 78	0, 39, 78	FHSS	8DPSK	3DH5

Radiated Emission Test (Below 1 GHz):

- Pre-Scan has been conducted to determine the worst-case mode from all possible combinations between available modulations, data rates and antenna ports (if EUT with antenna diversity architecture).
- Following channel(s) was (were) selected for the final test as listed below.

EUT Configure Mode	Available Channel	Tested Channel	Modulation Technology	Modulation Type	Packet Type
-	0 to 78	39	FHSS	GFSK	3DH5

Power Line Conducted Emission Test:

- Pre-Scan has been conducted to determine the worst-case mode from all possible combinations between available modulations, data rates and antenna ports (if EUT with antenna diversity architecture).
- Following channel(s) was (were) selected for the final test as listed below.

EUT Configure Mode	Available Channel	Tested Channel	Modulation Technology	Modulation Type	Packet Type
-	0 to 78	0 to 78	FHSS	GFSK	DH5

Antenna Port Conducted Measurement:

- This item includes all test value of each mode, but only includes spectrum plot of worst value of each mode.
- Pre-Scan has been conducted to determine the worst-case mode from all possible combinations between available modulations, data rates and antenna ports (if EUT with antenna diversity architecture).
- Following channel(s) was (were) selected for the final test as listed below.

EUT Configure Mode	Available Channel	Tested Channel	Modulation Technology	Modulation Type	Packet Type
-	0 to 78	0, 39, 78	FHSS	GFSK	DH5
-	0 to 78	0, 39, 78	FHSS	8DPSK	3DH5

Test Condition:

Applicable To	Environmental Conditions	Power supply	Tested by
RE \geq 1G	15 deg. C, 45 % RH	AC120V/60Hz	Tank Tan
RE<1G	15 deg. C, 45 % RH	AC120V/60Hz	Tank Tan
PLC	15 deg. C, 45 % RH	AC120V/60Hz	Tank Tan
APCM	15 deg. C, 45 % RH	AC120V/60Hz	Harry Li

2.3 Description of Support Units

The EUT has been tested as an independent unit together with other necessary accessories or support units. The following support units or accessories were used to form a representative test configuration during the tests.

No.	Product	Brand	Model No.	Serial No.	FCC ID
1.	Notebook	Lenovo	E430	MP-0DN27	N/A

No.	Signal Cable Description Of The Above Support Units
1.	AC Line: Un-shieldin 2.0m
2.	/
3.	/

2.3.1 Configuration of System under Test

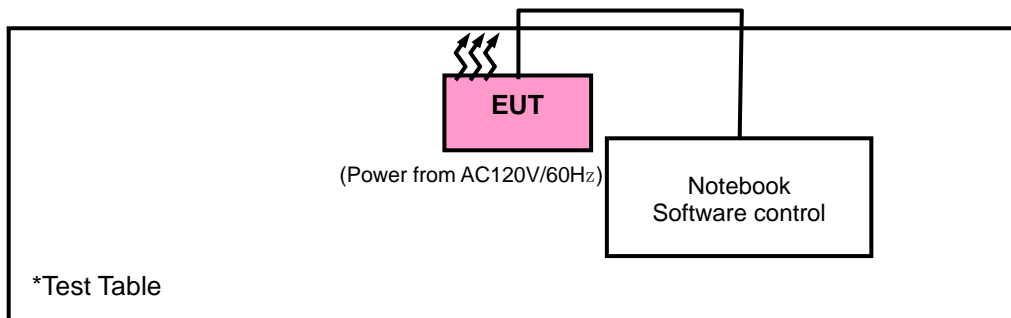

2.4 General Description of Applied Standards

The EUT is a RF Product. According to the specifications of the manufacturer, it must comply with the requirements of the following standards:

FCC Part 15, Subpart C (15.247)

FCC Public Notice DA 00-705

ANSI C63.10-2013

KDB 558074 D01 15.247 Meas Guidance v05r02

All test items have been performed and recorded as per the above standards.

Note: The EUT has been verified to comply with the requirements of FCC Part 15, Subpart B, Class B (sDoC).
The test report has been issued separately.

3 Test Types and Results

3.1 Radiated Emission and Bandedge Measurement

3.1.1 Limits of Radiated Emission and Bandedge Measurement

Radiated emissions which fall in the restricted bands must comply with the radiated emission limits specified as below table. Other emissions shall be at least 20 dB below the highest level of the desired power:

Frequencies (MHz)	Field Strength (microvolts/meter)	Measurement Distance (meters)
0.009 ~ 0.490	2400/F (kHz)	300
0.490 ~ 1.705	24000/F (kHz)	30
1.705 ~ 30.0	30	30
30 ~ 88	100	3
88 ~ 216	150	3
216 ~ 960	200	3
Above 960	500	3

Note:

1. The lower limit shall apply at the transition frequencies.
2. Emission level (dBuV/m) = 20 log Emission level (uV/m).
3. For frequencies above 1000 MHz, the field strength limits are based on average detector, however, the peak field strength of any emission shall not exceed the maximum permitted average limits, specified above by more than 20 dB under any condition of modulation.

3.1.2 Test Instruments

For radiated emission test (9kHz-30MHz)

Equipment	Manufacturer	Model No.	Serial No.	Last Cal.	Next Cal.
EMI Test Receiver (10kHz~7GHz)	Rohde&Schwarz	ESCI 7	100962	2020/05/14	2021/05/13
Loop antenna (9kHz~30MHz)	TESEQ	HLA 6121	56735	2020/04/15	2021/04/15
3m Semi-anechoic Chamber	MAORUI	9m*6m*6m	NSEMC003	2020/04/15	2021/04/14
Attenuator	R&S	TS2GA-6dB	18101101	N/A	N/A
Test software	EZ	EZ_EMV V1.1.4.2	N/A	N/A	N/A

For radiated emission test (30MHz-1GHz)

Equipment	Manufacturer	Model No.	Serial No.	Last Cal.	Next Cal.
EMI Test Receiver (10kHz~7GHz)	Rohde&Schwarz	ESCI 7	100962	2020/05/14	2021/05/13
Broadband antenna (25MHz~2500MHz)	Schwarzbeck	VULB 9168	00937	2020/4/15	2021/04/15
3m Semi-anechoic Chamber	MAORUI	9m*6m*6m	NSEMC003	2020/04/15	2021/04/14
Signal Amplifier (30MHz~1000MHz)	Com-power	PAM-103	18020051	2020/4/15	2021/04/15
Attenuator	R&S	TS2GA-6dB	18101101	N/A	N/A
Test software	EZ	EZ_EMV V1.1.4.2	N/A	N/A	N/A

For radiated emission test (1GHz-40GHz, 966 m Chamber)

Equipment	Manufacturer	Model No.	Serial No.	Last Cal.	Next Cal.
Horn Antenna (1GHz-18GHz)	Schwarzbeck	BBHA 9170	01959	2020/4/15	2021/04/15
Broadband Coaxial Preamplifier (1GHz-18GHz)	Schwarzbeck	BBV 9718	00025	2020/4/15	2021/04/15
Spectrum Analyzer	Rohde&Schwarz	FSV-40N	10783	2020/4/15	2021/04/15
Horn Antenna (18GHz-40GHz)	Schwarzbeck	BBHA 9170	BBHA9170242	2020/4/15	2021/04/15
Pre-Amplifier (18GHz-40GHz)	EMCI	EMC 184045	980102	2020/4/15	2021/04/15
High pass filter	Micro-Tronics	HPM50107	G050	2020/09/16	2021/09/16
High pass filter	Micro-Tronics	HPM50117	G007	2020/09/16	2021/09/16
Test software	EZ	EZ_EMV V1.1.4.2	N/A	N/A	N/A
Spectrum (10kHz~26.5GHz)	Keysight	N9020A	MY51240612	2020/09/16	2021/09/16

- Note: 1. The calibration interval of the above test instruments is 12/24months and the calibrations are traceable to CEPREI/CHINA.
 2. The test was performed in 966.

3.1.3 Test Procedures

- a. The EUT was placed on the top of a rotating table 0.8 meters (for below 1 GHz) / 1.5 meters (for above 1 GHz) above the ground at 3 meter chamber room for test. The table was rotated 360 degrees to determine the position of the highest radiation.
- b. The EUT was set 3 meters away from the interference-receiving antenna, which was mounted on the top of a variable-height antenna tower.
- c. The height of antenna is varied from one meter to four meters above the ground to determine the maximum value of the field strength. Both horizontal and vertical polarizations of the antenna are set to make the measurement.
- d. For each suspected emission, the EUT was arranged to its worst case and then the antenna was tuned to heights from 1 meter to 4 meters and the rotatable table was turned from 0 degrees to 360 degrees to find the maximum reading.
- e. The test-receiver system was set to quasi-peak detect function and specified bandwidth with maximum hold mode when the test frequency is below 1 GHz.
- f. The test-receiver system was set to peak and average detected function and specified bandwidth with maximum hold mode when the test frequency is above 1 GHz. If the peak reading value also meets average limit, measurement with the average detector is unnecessary.

Note:

1. The resolution bandwidth and video bandwidth of test receiver/spectrum analyzer is 120 kHz & 360 kHz for Quasi-peak detection (QP) at frequency below 1 GHz.
2. The resolution bandwidth of test receiver/spectrum analyzer is 1 MHz and the video bandwidth is 3 MHz for Peak detection (PK) at frequency above 1 GHz.
3. The resolution bandwidth of test receiver/spectrum analyzer is 1 MHz and the video bandwidth is 1/T for Average (Duty cycle < 98 %) detection at frequency above 1 GHz.
4. The resolution bandwidth of test receiver/spectrum analyzer is 1 MHz and the video bandwidth is 10 Hz (Duty cycle \geq 98 %) for Average detection (AV) at frequency above 1 GHz.
5. Test procedures for measuring FHSS device: The use of a duty cycle correction factor (DCCF) is permitted for calculating average radiated field strength emission levels for an FHSS device in 15.247. This DCCF can be applied when the unwanted emission limit is subject to an average field strength limit (e.g., within a Government Restricted band) and the conditions specified in Section 15.35(c) can be satisfied. The average radiated field strength is calculated by subtracting the DCCF from the maximum radiated field strength level as determined through measurement. The maximum radiated field strength level represents the worst-case (maximum amplitude) RMS measurement of the emission(s) during continuous transmission (i.e., not including any time intervals during which the transmitter is off or is transmitting at a reduced power level). It is also acceptable to apply the DCCF to a measurement performed with a peak detector instead of the specified RMS power averaging detector. Note that Section 15.35(c) specifies that the DCCF shall represent the worst-case (greatest duty cycle) over any 100 msec transmission period. Subclause 7.5 of ANSI C63.10 provides additional measurement guidance applicable to determination of the DCCF.
6. All modes of operation were investigated and the worst-case emissions are reported.

3.1.4 Deviation from Test Standard

No deviation.

3.1.5 Test Setup

Radiated emission below 30 MHz:

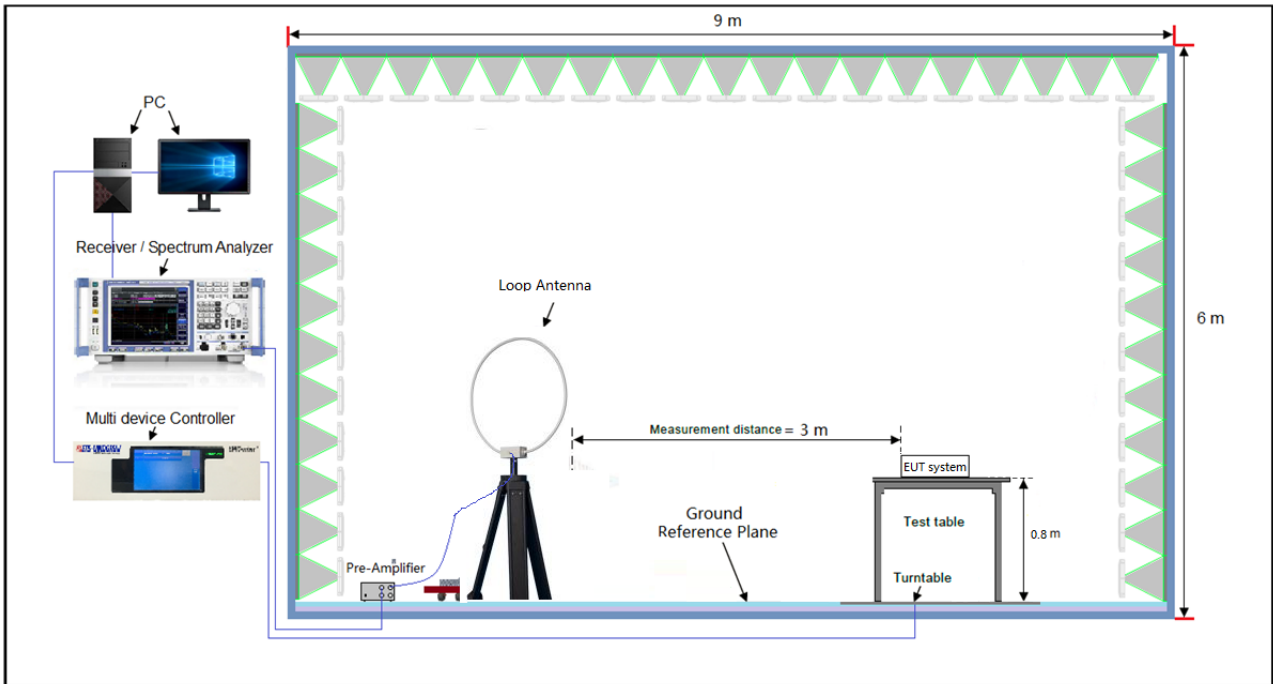

Frequency Range below 1 GHz:

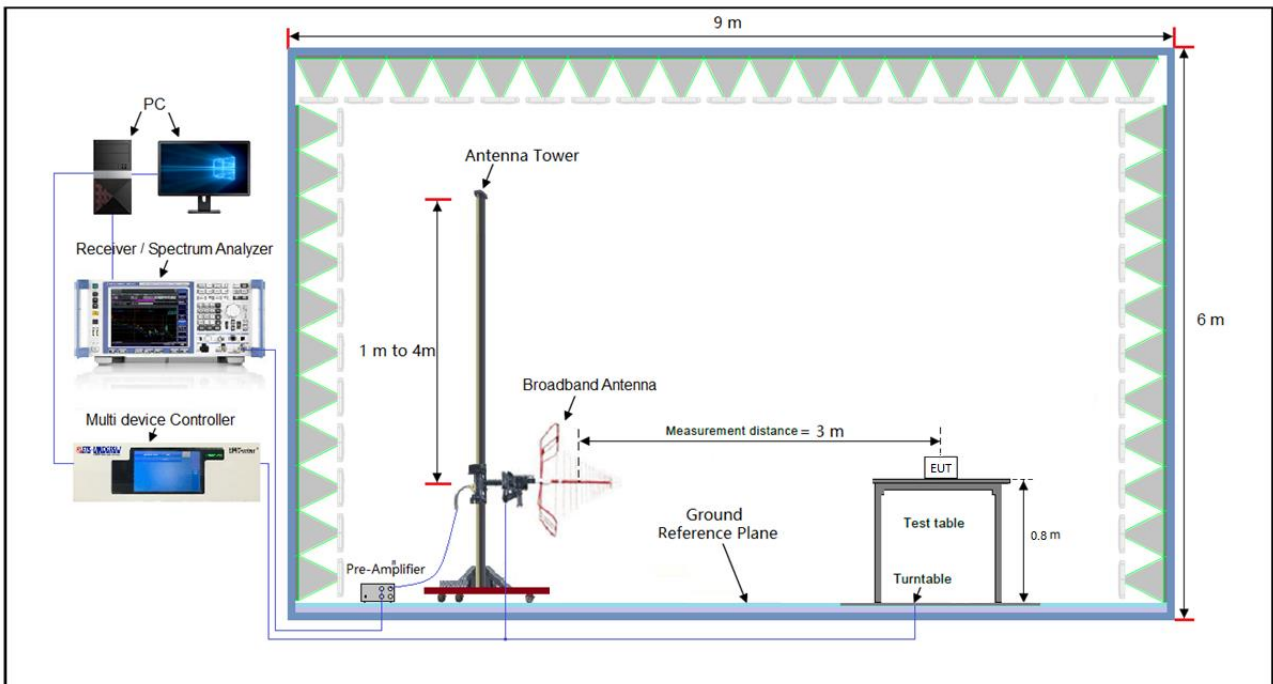

Frequency Range above 1 GHz:

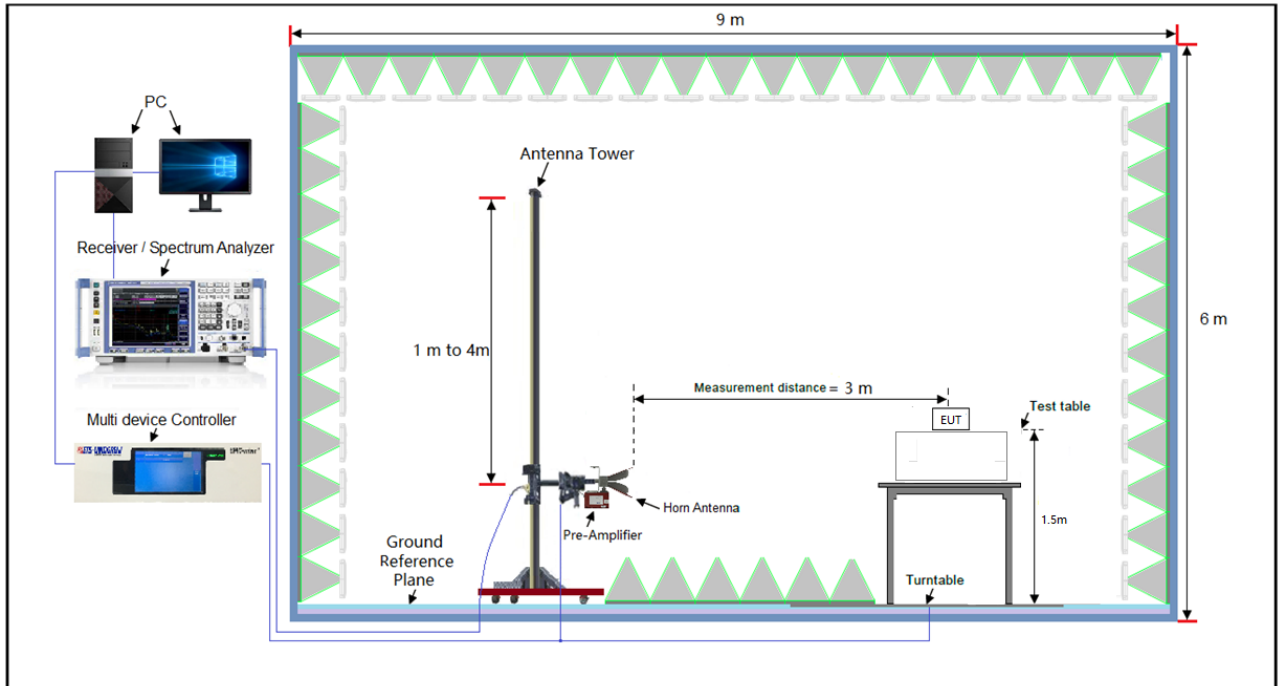

Frequency Range 18-40GHz:

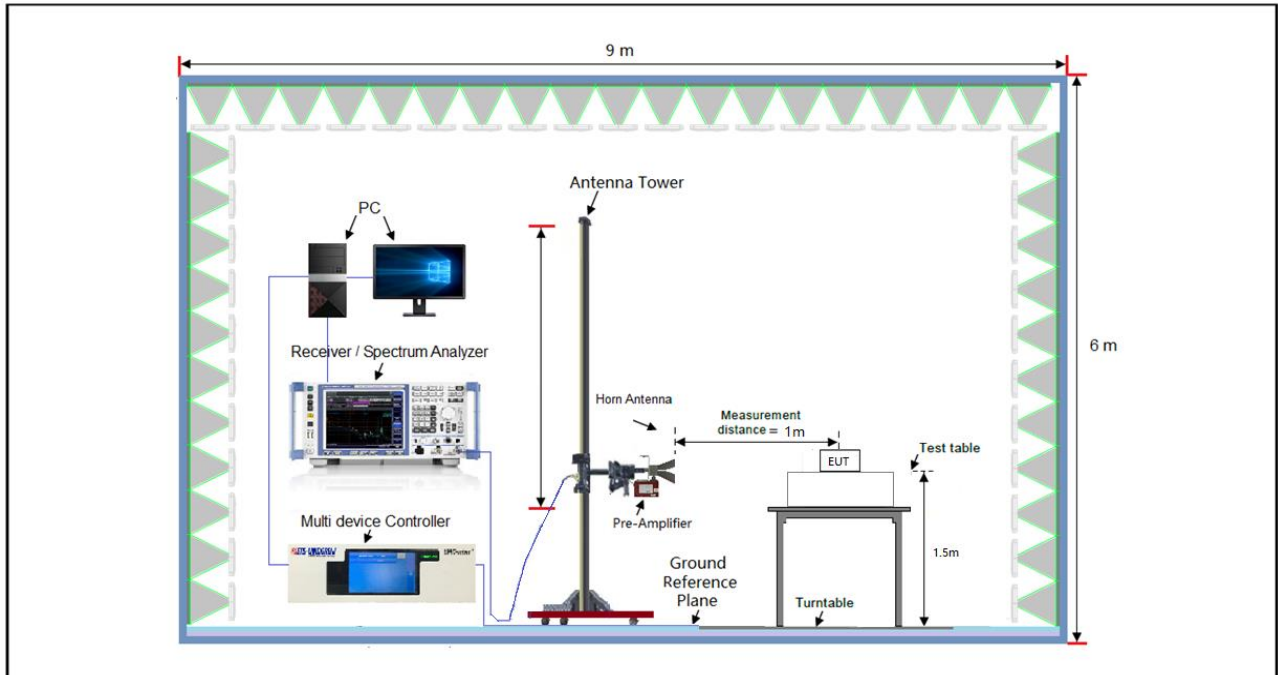

Directional antenna.

For the actual test configuration, please refer to the attached file (Test Setup Photo).

3.1.6 EUT Operating Conditions

Set the EUT under transmission condition continuously at specific channel frequency.

3.1.7 Test Results

9 kHz ~ 30 MHz Data:

The amplitude of spurious emissions attenuated more than 20 dB below the permissible value is not required to be report.

30 MHz ~ 1 GHz Worst-Case Data:

EUT Test Condition		Measurement Detail	
Channel	Hopping mode 0~78	Frequency Range	30 MHz ~ 1 GHz
Power supply	AC120V/60Hz	Detector Function	Peak (PK) Quasi-peak (QP)
Environmental Conditions	25 deg. C, 65 % RH	Tested By	Tech Chen

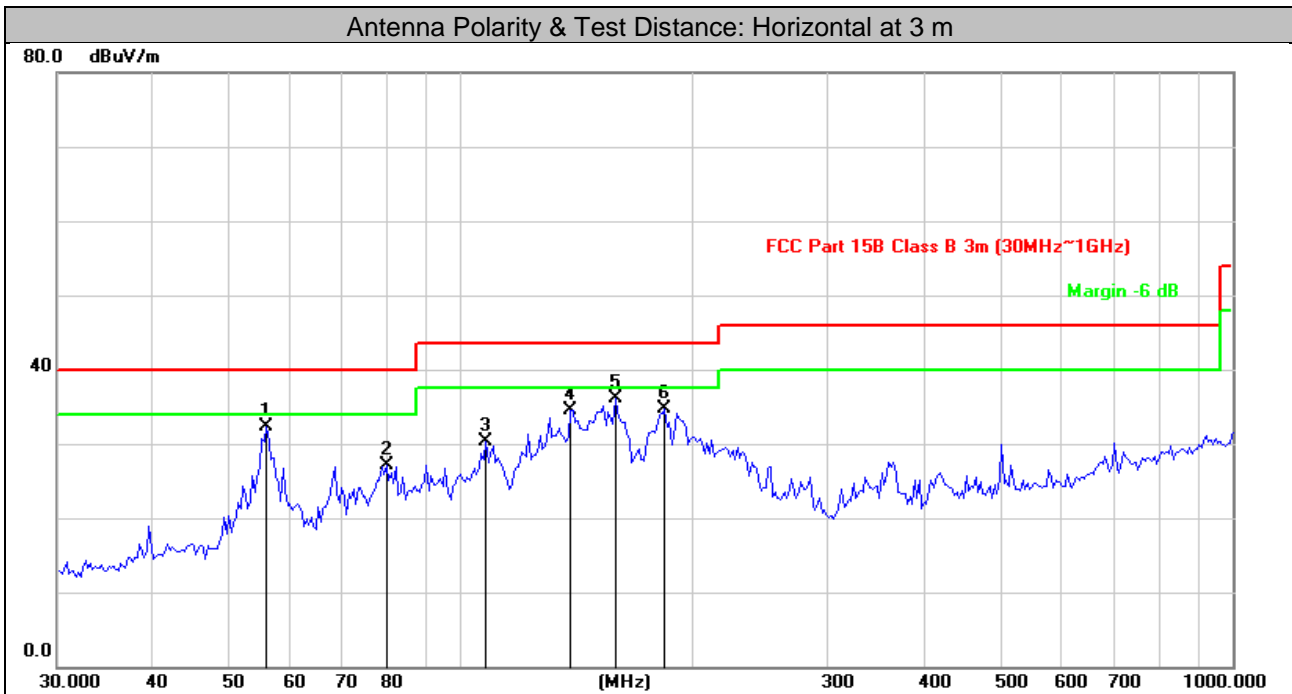

No.	Frequency (MHz)	Reading (dBuV)	Factor (dB)	Emission Level (dBuV/m)	Limit (dBuV/m)	Margin (dB)	Detector	Antenna Height (cm)	Table Angle (Degree)	Remark
1	56.0708	46.42	-14.10	32.32	40.00	-7.68	QP	300	95	
2	80.2382	45.01	-17.83	27.18	40.00	-12.82	QP	200	62	
3	107.7853	46.95	-16.61	30.34	43.50	-13.16	QP	100	229	
4	138.8120	48.91	-14.35	34.56	43.50	-8.94	QP	100	38	
5	158.6399	48.42	-12.36	36.06	43.50	-7.44	QP	100	243	
6	183.8660	49.65	-15.03	34.62	43.50	-8.88	QP	400	1	

Remarks:

*Emission Level = Read Level + Factor (Antenna Factor + Cable Loss - Preamp Factor)

*Margin value = Emission level – Limit value

EUT Test Condition		Measurement Detail	
Channel	Hopping mode 0~78	Frequency Range	30 MHz ~ 1 GHz
Power supply	AC120V/60Hz	Detector Function	Peak (PK) Quasi-peak (QP)
Environmental Conditions	25 deg. C, 65 % RH	Tested By	Tech Chen

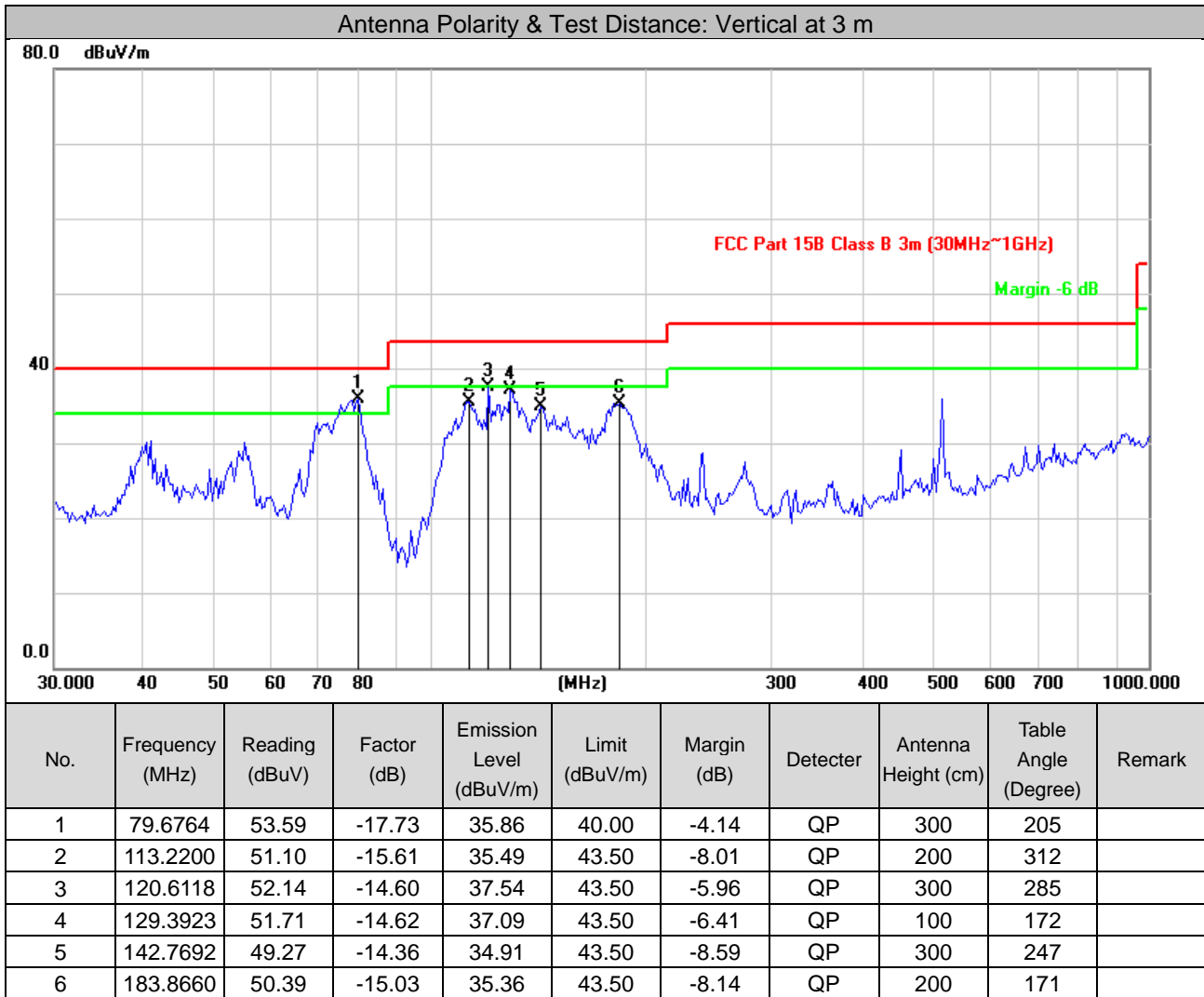

Remarks:

*Emission Level = Read Level + Factor (Antenna Factor + Cable Loss - Preamp Factor)

*Margin value = Emission level – Limit value

Above 1 GHz Data:
GFSK

EUT Test Condition		Measurement Detail	
Channel	Channel 0	Frequency Range	1 GHz ~ 25 GHz
Power supply	AC120V/60Hz	Detector Function	Peak (PK) Average (AV)
Environmental Conditions	25 deg. C, 65 % RH	Tested By	Tech Chen

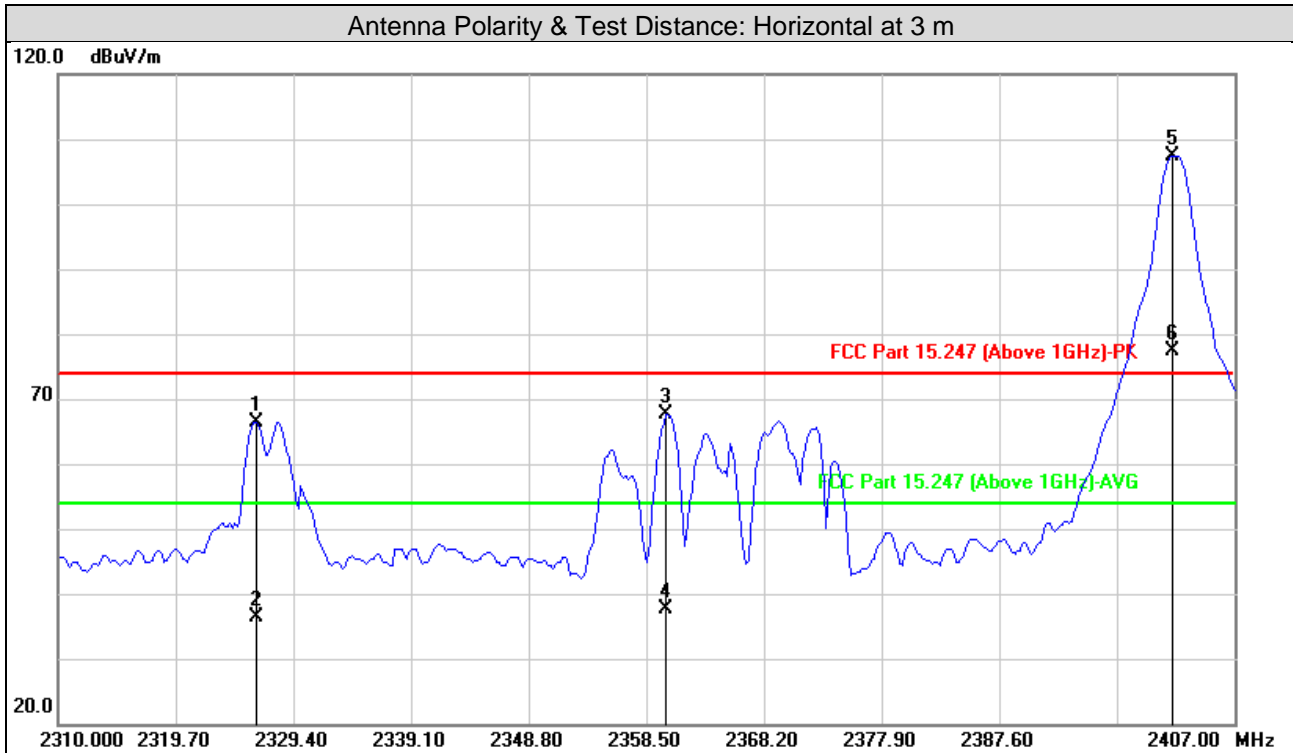

No.	Frequency (MHz)	Reading (dBuV)	Factor (dB)	Emission Level (dBuV/m)	Limit (dBuV/m)	Margin (dB)	Detector	Antenna Height (cm)	Table Angle (Degree)	Remark
1	2326.329	68.10	-1.74	66.36	74.00	-7.64	peak	100	130	
2	2326.329	38.00	-1.74	36.26	54.00	-17.74	AVG	100	130	
3	2360.152	69.39	-1.70	67.69	74.00	-6.31	peak	100	130	
4	2360.152	39.29	-1.70	37.59	54.00	-16.41	AVG	100	130	
#5	2401.946	109.12	-1.66	107.46			peak	100	130	
#6	2401.946	79.02	-1.66	77.36			AVG	100	130	
7	4804.000	48.39	4.49	52.88	74.00	-21.12	peak	145	58	
8	4804.000	18.29	4.49	22.78	54.00	-31.22	AVG	145	58	
9	7206.000	48.49	8.44	56.93	74.00	-17.07	peak	276	297	
10	7206.000	18.39	8.44	26.83	54.00	-27.17	AVG	276	297	

Remarks:

- Emission Level = Read Level + Factor (Antenna Factor + Cable Loss - Preamp Factor)
Margin value = Emission level – Limit value
- #2402 MHz: Fundamental frequency.

EUT Test Condition		Measurement Detail	
Channel	Channel 0	Frequency Range	1 GHz ~ 25 GHz
Power supply	AC120V/60Hz	Detector Function	Peak (PK) Average (AV)
Environmental Conditions	25 deg. C, 65 % RH	Tested By	Tech Chen

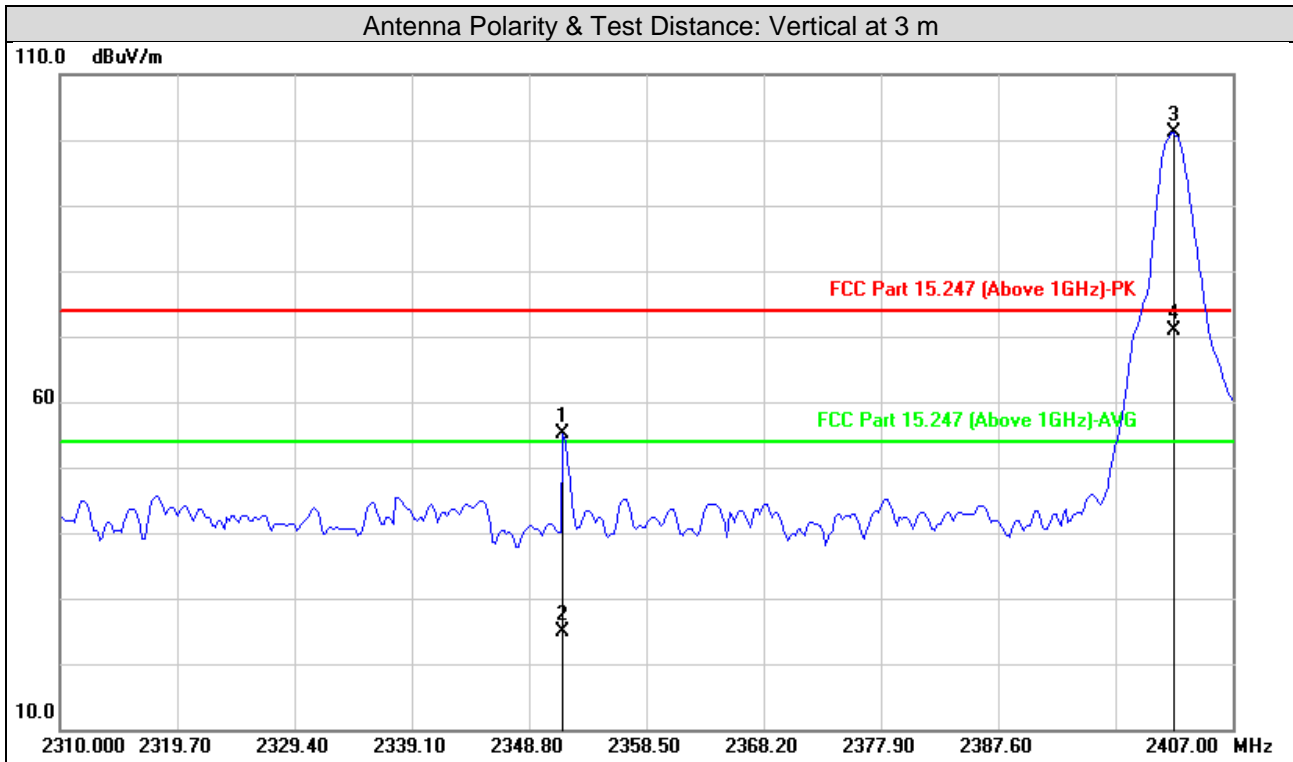

No.	Frequency (MHz)	Reading (dBuV)	Factor (dB)	Emission Level (dBuV/m)	Limit (dBuV/m)	Margin (dB)	Detector	Antenna Height (cm)	Table Angle (Degree)	Remark
1	2351.599	56.80	-1.71	55.09	74.00	-18.91	peak	100	174	
2	2351.599	26.70	-1.71	24.99	54.00	-29.01	AVG	100	174	
#3	2402.140	102.74	-1.66	101.08			peak	100	174	
#4	2402.140	72.64	-1.66	70.98			AVG	100	174	
5	4804.000	52.92	4.49	57.41	74.00	-16.59	peak	228	75	
6	4804.000	22.82	4.49	27.31	54.00	-26.69	AVG	228	75	
7	7206.000	52.40	8.44	60.84	74.00	-13.16	peak	306	347	
8	7206.000	22.30	8.44	30.74	54.00	-23.26	AVG	306	347	

Remarks:

1. Emission Level = Read Level + Factor (Antenna Factor + Cable Loss - Preamp Factor)

Margin value = Emission level – Limit value

2. #2402 MHz: Fundamental frequency.

EUT Test Condition		Measurement Detail	
Channel	Channel 39	Frequency Range	1 GHz ~ 25 GHz
Power supply	AC120V/60Hz	Detector Function	Peak (PK) Average (AV)
Environmental Conditions	25 deg. C, 65 % RH	Tested By	Tech Chen

Antenna Polarity & Test Distance: Horizontal at 3 m										
No.	Frequency (MHz)	Reading (dBuV)	Factor (dB)	Emission Level (dBuV/m)	Limit (dBuV/m)	Margin (dB)	Detector	Antenna Height (cm)	Table Angle (Degree)	Remark
#1	2441.000	106.09	-1.61	104.48			peak	100	15	
#2	2441.000	75.99	-1.61	74.38			AVG	100	15	
3	4880.000	49.03	4.65	53.68	74.00	-20.32	peak	100	276	
4	4880.000	18.93	4.65	23.58	54.00	-30.42	AVG	100	276	
5	7320.000	54.34	8.73	63.07	74.00	-10.93	peak	275	250	
6	7320.000	24.24	8.73	32.97	54.00	-21.03	AVG	275	250	
Antenna Polarity & Test Distance: Vertical at 3 m										
No.	Frequency (MHz)	Reading (dBuV)	Factor (dB)	Emission Level (dBuV/m)	Limit (dBuV/m)	Margin (dB)	Detector	Antenna Height (cm)	Table Angle (Degree)	Remark
#1	2441.000	104.50	-1.61	102.89			peak	150	85	
#2	2441.000	77.40	-1.61	75.79			AVG	150	85	
3	4880.000	51.33	4.65	55.98	74.00	-18.02	peak	100	286	
4	4880.000	21.23	4.65	25.88	54.00	-28.12	AVG	100	286	
5	7320.000	54.77	8.73	63.50	74.00	-10.50	peak	100	273	
6	7320.000	24.67	8.73	33.40	54.00	-20.60	AVG	100	273	

Remarks:

1. Emission Level = Read Level + Factor (Antenna Factor + Cable Loss - Preamp Factor)

Margin value = Emission level – Limit value

2. #2441 MHz: Fundamental frequency.

EUT Test Condition		Measurement Detail	
Channel	Channel 78	Frequency Range	1 GHz ~ 25 GHz
Power supply	AC120V/60Hz	Detector Function	Peak (PK) Average (AV)
Environmental Conditions	25 deg. C, 65 % RH	Tested By	Tech Chen

Antenna Polarity & Test Distance: Horizontal at 3 m

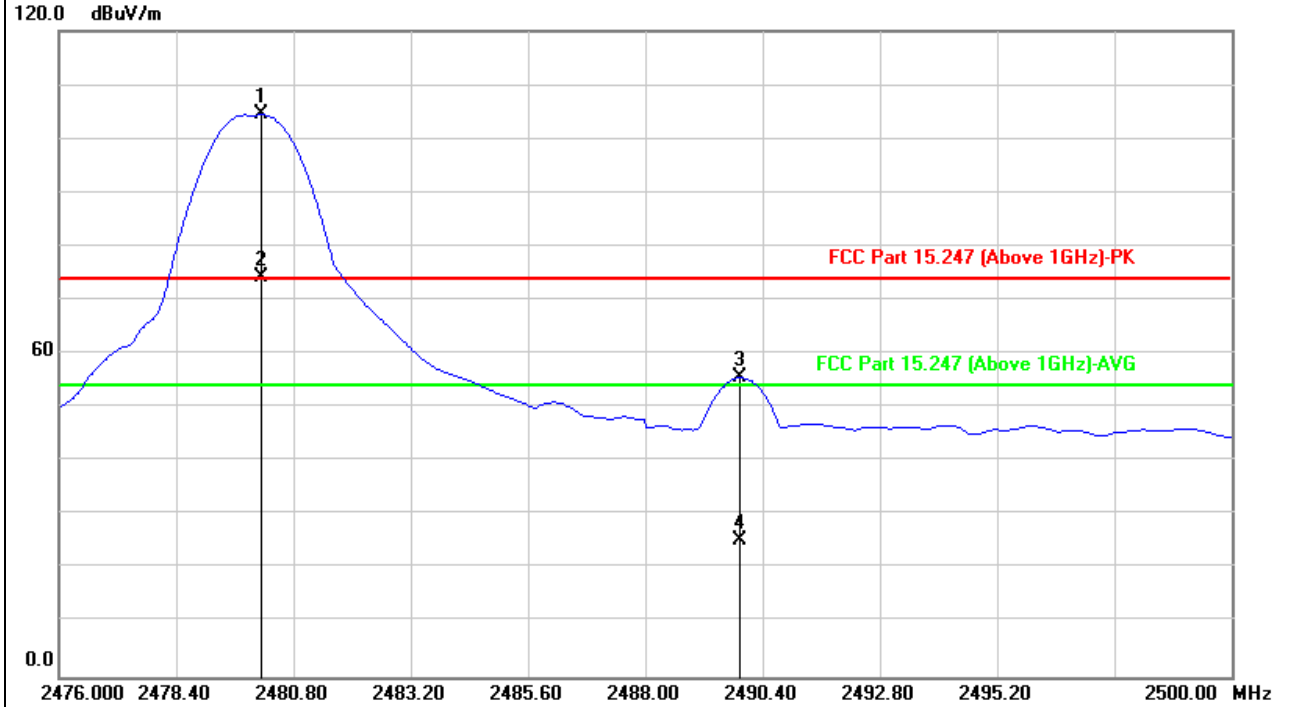

No.	Frequency (MHz)	Reading (dBuV)	Factor (dB)	Emission Level (dBuV/m)	Limit (dBuV/m)	Margin (dB)	Detector	Antenna Height (cm)	Table Angle (Degree)	Remark
#1	2480.136	106.02	-1.55	104.47			peak	256	312	
#2	2480.136	75.92	-1.55	74.37			AVG	256	312	
3	2489.948	57.13	-1.55	55.58	74.00	-18.42	peak	256	312	
4	2489.948	27.03	-1.55	25.48	54.00	-28.52	AVG	256	312	
5	4960.000	51.06	4.83	55.89	74.00	-18.11	peak	175	196	
6	4960.000	20.96	4.83	25.79	54.00	-28.21	AVG	175	196	
7	7440.000	51.94	9.02	60.96	74.00	-13.04	peak	286	311	
8	7440.000	21.84	9.02	30.86	54.00	-23.14	AVG	286	311	

Remarks:

- Emission Level = Read Level + Factor (Antenna Factor + Cable Loss - Preamp Factor)
Margin value = Emission level – Limit value
- #2480 MHz: Fundamental frequency.

EUT Test Condition		Measurement Detail	
Channel	Channel 78	Frequency Range	1 GHz ~ 25 GHz
Power supply	AC120V/60Hz	Detector Function	Peak (PK) Average (AV)
Environmental Conditions	25 deg. C, 65 % RH	Tested By	Tech Chen

Antenna Polarity & Test Distance: Vertical at 3 m

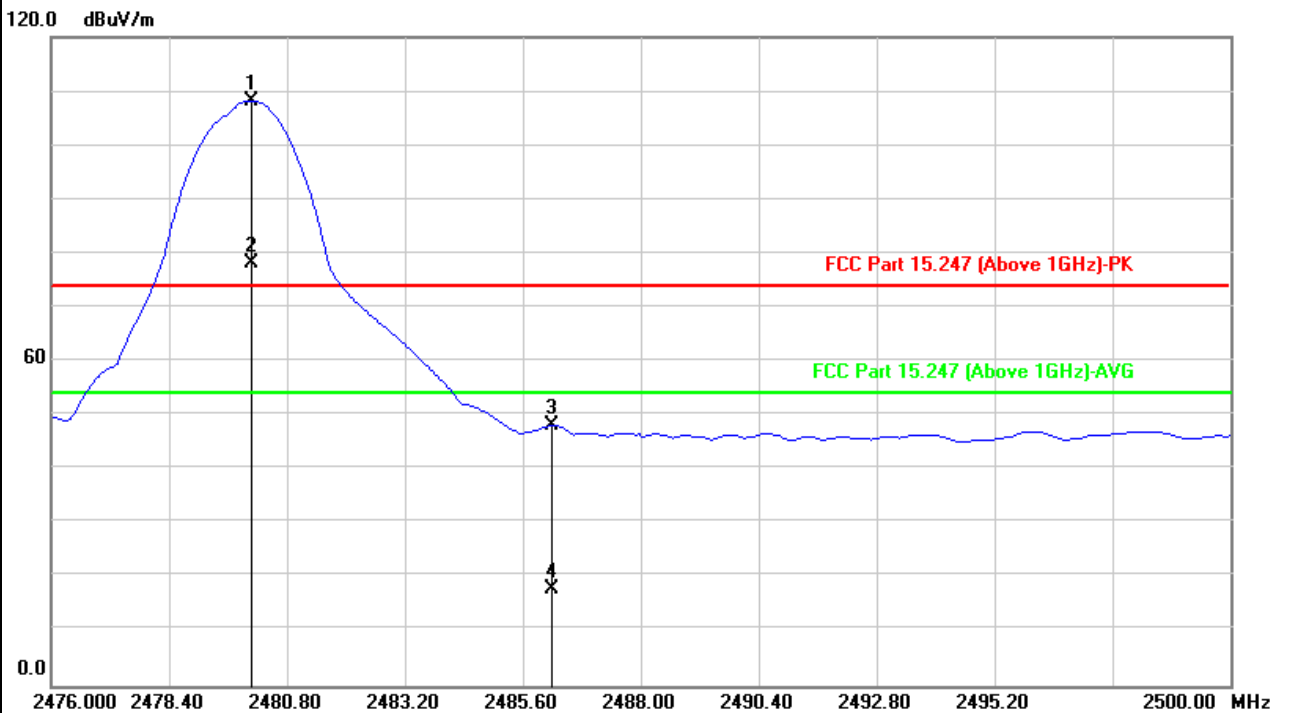

No.	Frequency (MHz)	Reading (dBuV)	Factor (dB)	Emission Level (dBuV/m)	Limit (dBuV/m)	Margin (dB)	Detector	Antenna Height (cm)	Table Angle (Degree)	Remark
#1	2480.088	109.84	-1.55	108.29			peak	175	101	
#2	2480.088	79.74	-1.55	78.19			AVG	175	101	
3	2486.196	49.65	-1.55	48.10	74.00	-25.90	peak	175	101	
4	2486.196	19.55	-1.55	18.00	54.00	-36.00	AVG	175	101	
5	4960.000	52.42	4.83	57.25	74.00	-16.75	peak	157	225	
6	4960.000	22.32	4.83	27.15	54.00	-26.85	AVG	157	225	
7	7440.000	53.87	9.02	62.89	74.00	-11.11	peak	265	322	
8	7440.000	23.77	9.02	32.79	54.00	-21.21	AVG	265	322	

Remarks:

- Emission Level = Read Level + Factor (Antenna Factor + Cable Loss - Preamp Factor)
Margin value = Emission level – Limit value
- #The 2480 MHz: Fundamental frequency.

8DPSK

EUT Test Condition		Measurement Detail	
Channel	Channel 0	Frequency Range	1 GHz ~ 25 GHz
Power supply	AC120V/60Hz	Detector Function	Peak (PK) Average (AV)
Environmental Conditions	25 deg. C, 65 % RH	Tested By	Tech Chen

Antenna Polarity & Test Distance: Horizontal at 3 m

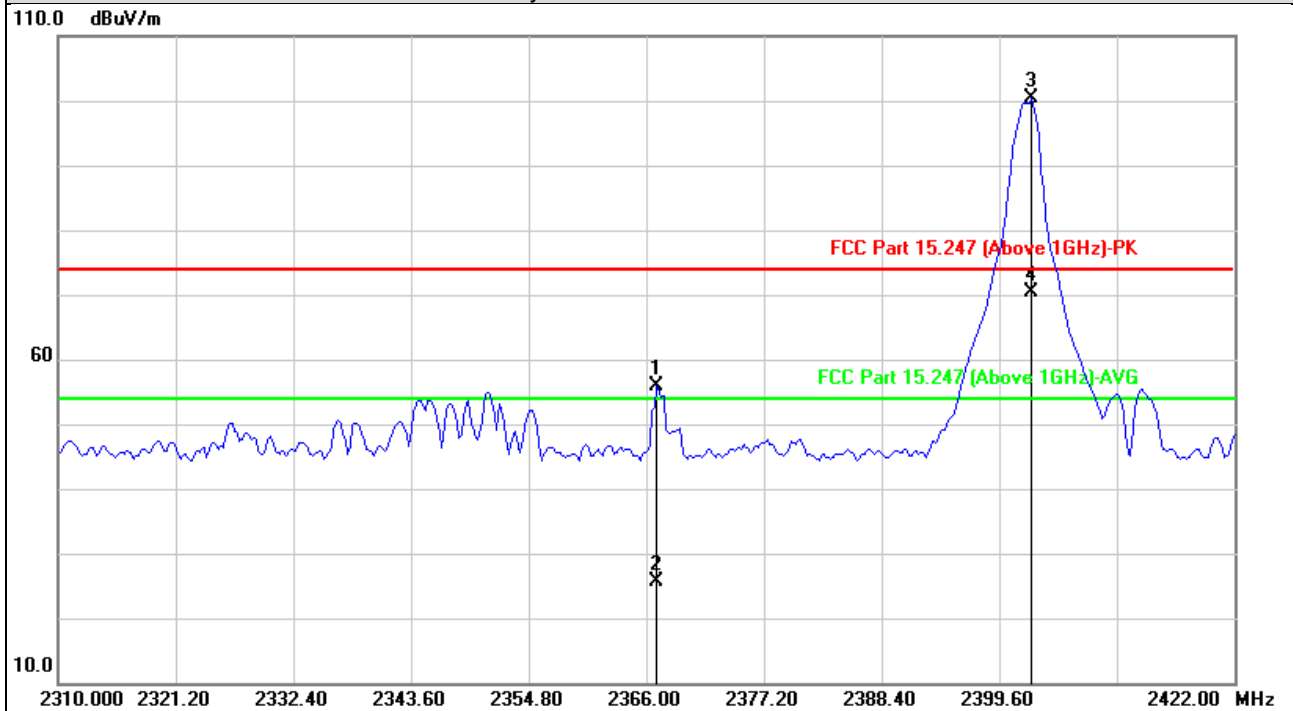

No.	Frequency (MHz)	Reading (dBUV)	Factor (dB)	Emission Level (dBUV/m)	Limit (dBUV/m)	Margin (dB)	Detector	Antenna Height (cm)	Table Angle (Degree)	Remark
1	2367.010	57.48	-1.68	55.80	74.00	-18.20	peak	199	320	
2	2367.010	27.38	-1.68	25.70	54.00	-28.30	AVG	199	320	
#3	2402.697	102.01	-1.65	100.36			peak	230	168	
#4	2402.697	71.91	-1.65	70.26			AVG	230	168	
5	4804.000	49.53	4.49	54.02	74.00	-19.98	peak	213	58	
6	4804.000	19.43	4.49	23.92	54.00	-30.08	AVG	213	58	
7	7206.000	49.24	8.44	57.68	74.00	-16.32	peak	304	157	
8	7206.000	19.14	8.44	27.58	54.00	-26.42	AVG	304	157	

Remarks:

- Emission Level = Read Level + Factor (Antenna Factor + Cable Loss - Preamp Factor)
Margin value = Emission level – Limit value
- #2402MHz: C.F.: Fundamental frequency.

EUT Test Condition		Measurement Detail	
Channel	Channel 0	Frequency Range	1 GHz ~ 25 GHz
Power supply	AC120V/60Hz	Detector Function	Peak (PK) Average (AV)
Environmental Conditions	25 deg. C, 65 % RH	Tested By	Tech Chen

Antenna Polarity & Test Distance: Vertical at 3 m

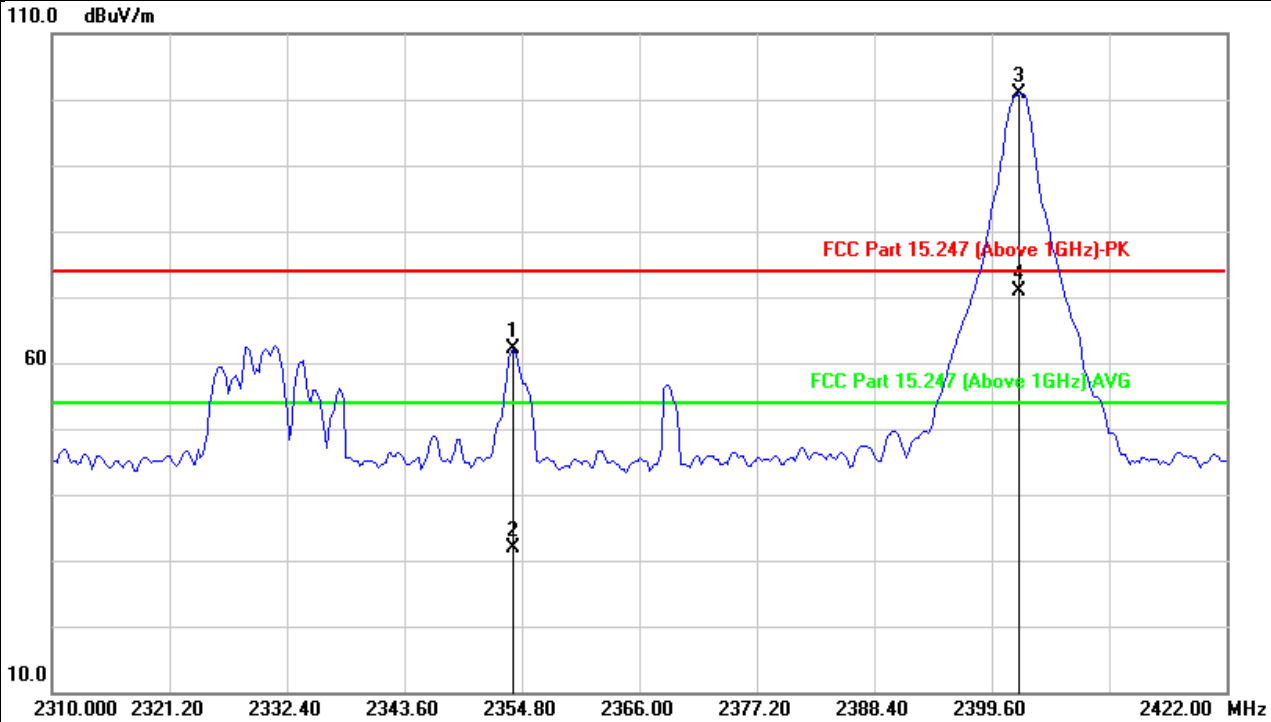

No.	Frequency (MHz)	Reading (dBuV)	Factor (dB)	Emission Level (dBuV/m)	Limit (dBuV/m)	Margin (dB)	Detector	Antenna Height (cm)	Table Angle (Degree)	Remark
1	2353.992	63.72	-1.71	62.01	74.00	-11.99	peak	127	185	
2	2353.992	33.62	-1.71	31.91	54.00	-22.09	AVG	127	185	
#3	2402.249	102.66	-1.66	101.00			peak	226	52	
#4	2402.249	72.56	-1.66	70.90			AVG	226	52	
5	4804.000	54.13	4.49	58.62	74.00	-15.38	peak	136	48	
6	4804.000	24.03	4.49	28.52	54.00	-25.48	AVG	136	48	
7	7206.000	54.68	8.44	63.12	74.00	-10.88	peak	263	117	
8	7206.000	24.58	8.44	33.02	54.00	-20.98	AVG	263	117	

Remarks:

- Emission Level = Read Level + Factor (Antenna Factor + Cable Loss - Preamp Factor)
Margin value = Emission level – Limit value
- #2402MHz: C.F.: Fundamental frequency.

EUT Test Condition		Measurement Detail	
Channel	Channel 39	Frequency Range	1 GHz ~ 25 GHz
Power supply	AC120V/60Hz	Detector Function	Peak (PK) Average (AV)
Environmental Conditions	25 deg. C, 65 % RH	Tested By	Tech Chen

Antenna Polarity & Test Distance: Horizontal at 3 m										
No.	Frequency (MHz)	Reading (dBuV)	Factor (dB)	Emission Level (dBuV/m)	Limit (dBuV/m)	Margin (dB)	Detector	Antenna Height (cm)	Table Angle (Degree)	Remark
#1	2441.000	107.94	-1.61	106.33			peak	245	306	
#2	2441.000	75.61	-1.61	74.00			AVG	245	306	
3	4880.000	51.73	4.65	56.38	74.00	-17.62	peak	286	309	
4	4880.000	21.63	4.65	26.28	54.00	-27.72	AVG	286	309	
5	7320.000	56.71	8.73	65.44	74.00	-8.56	peak	305	278	
6	7320.000	26.61	8.73	35.34	54.00	-18.66	AVG	305	278	
Antenna Polarity & Test Distance: Vertical at 3 m										
No.	Frequency (MHz)	Reading (dBuV)	Factor (dB)	Emission Level (dBuV/m)	Limit (dBuV/m)	Margin (dB)	Detector	Antenna Height (cm)	Table Angle (Degree)	Remark
#1	2441.000	107.61	-1.61	106.00			peak	321	324	
#2	2441.000	77.51	-1.61	75.90			AVG	324	324	
3	4880.000	53.03	4.65	57.68	74.00	-16.32	peak	265	120	
4	4880.000	22.93	4.65	27.58	54.00	-26.42	AVG	265	120	
5	7320.000	56.39	8.73	65.12	74.00	-8.88	peak	100	278	
6	7320.000	26.29	8.73	35.02	54.00	-18.98	AVG	100	278	

Remarks:

- Emission Level = Read Level + Factor (Antenna Factor + Cable Loss - Preamp Factor)
Margin value = Emission level – Limit value
- #2441 MHz: Fundamental frequency.

EUT Test Condition		Measurement Detail	
Channel	Channel 78	Frequency Range	1 GHz ~ 25 GHz
Power supply	AC120V/60Hz	Detector Function	Peak (PK) Average (AV)
Environmental Conditions	25 deg. C, 65 % RH	Tested By	Tech Chen

Antenna Polarity & Test Distance: Horizontal at 3 m

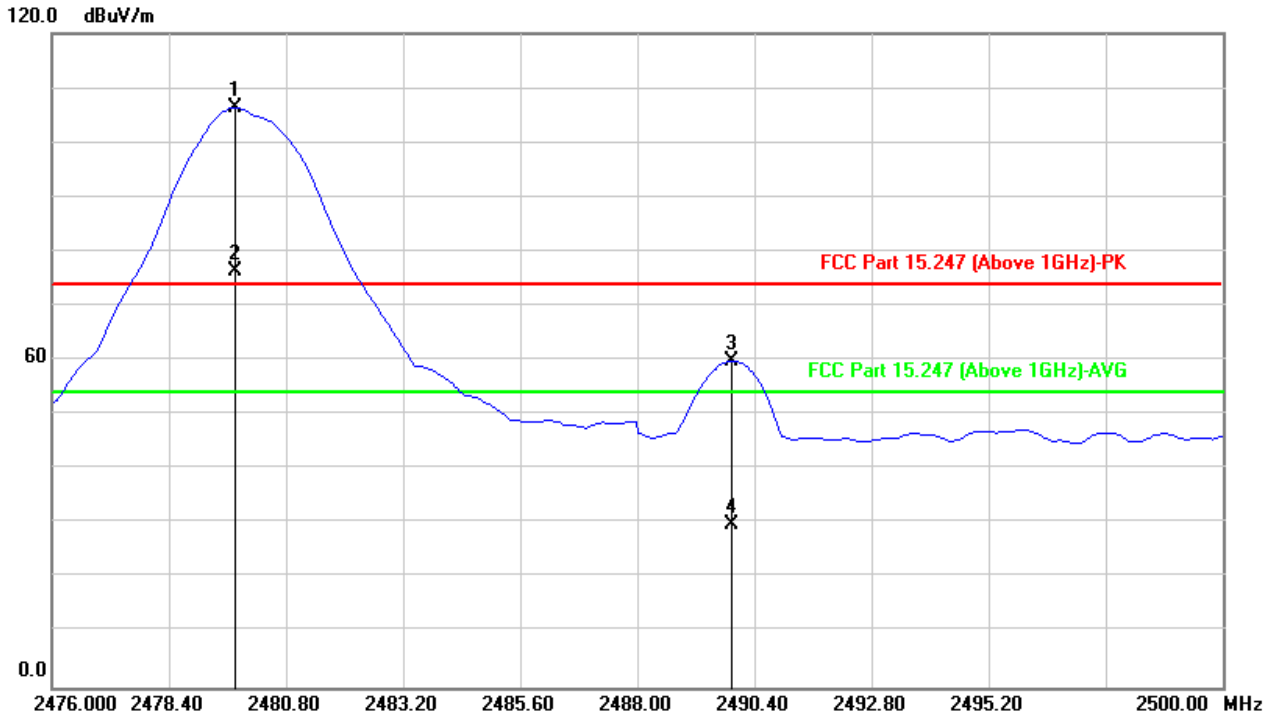

No.	Frequency (MHz)	Reading (dBuV)	Factor (dB)	Emission Level (dBuV/m)	Limit (dBuV/m)	Margin (dB)	Detector	Antenna Height (cm)	Table Angle (Degree)	Remark
#1	2479.751	107.91	-1.55	106.36			peak	120	351	
#2	2479.751	77.81	-1.55	76.26			AVG	120	351	
3	2489.948	61.43	-1.55	59.88	74.00	-14.12	peak	120	351	
4	2489.948	31.33	-1.55	29.78	54.00	-24.22	AVG	120	351	
5	4960.000	48.13	4.83	52.96	74.00	-21.04	peak	145	58	
6	4960.000	18.03	4.83	22.86	54.00	-31.14	AVG	145	58	
7	7440.000	49.75	9.02	58.77	74.00	-15.23	peak	276	297	
8	7440.000	19.65	9.02	28.67	54.00	-25.33	AVG	276	297	

Remarks:

1. Emission Level = Read Level + Factor (Antenna Factor + Cable Loss - Preamp Factor)

Margin value = Emission level – Limit value

2. #2480 MHz: Fundamental frequency.

EUT Test Condition		Measurement Detail	
Channel	Channel 78	Frequency Range	1 GHz ~ 25 GHz
Power supply	AC120V/60Hz	Detector Function	Peak (PK) Average (AV)
Environmental Conditions	25 deg. C, 65 % RH	Tested By	Tech Chen

Antenna Polarity & Test Distance: Vertical at 3 m

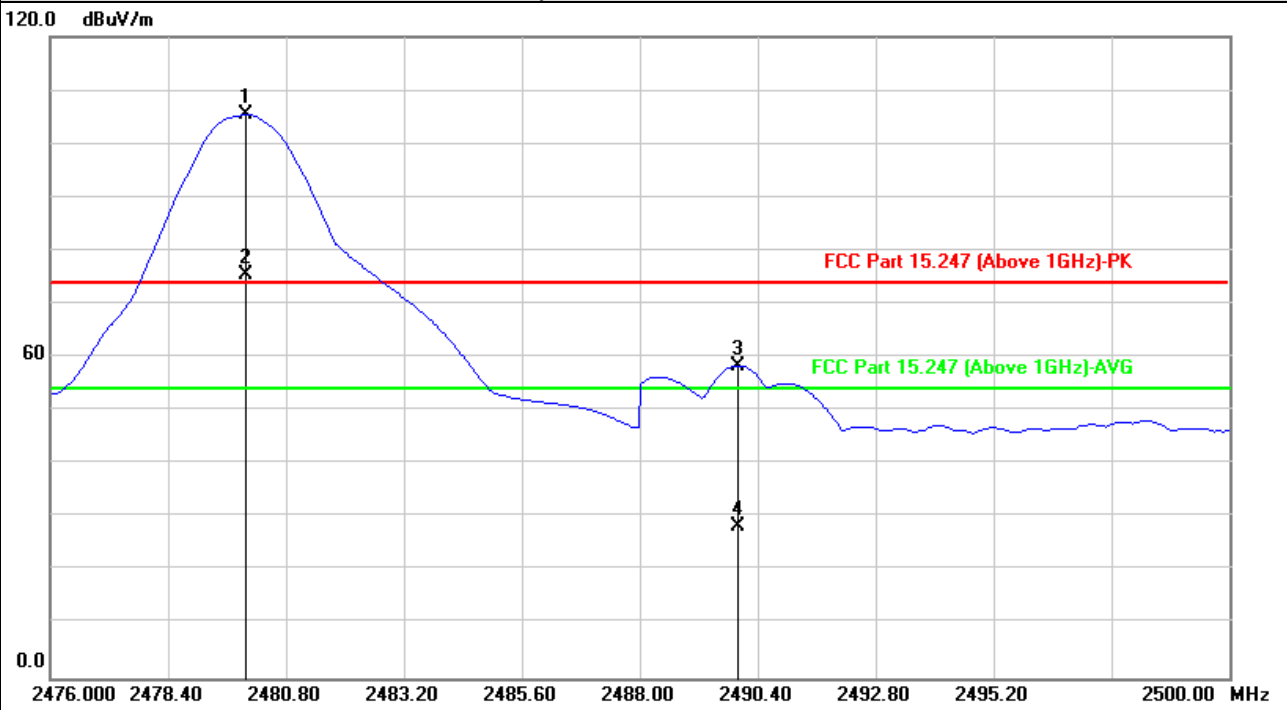

No.	Frequency (MHz)	Reading (dBuV)	Factor (dB)	Emission Level (dBuV/m)	Limit (dBuV/m)	Margin (dB)	Detector	Antenna Height (cm)	Table Angle (Degree)	Remark
#1	2479.992	107.05	-1.55	105.50			peak	185	278	
#2	2479.992	76.95	-1.55	75.40			AVG	185	278	
3	2489.996	59.96	-1.55	58.41	74.00	-15.59	peak	185	278	
4	2489.996	29.86	-1.55	28.31	54.00	-25.69	AVG	185	278	
5	4960.000	52.04	4.83	56.87	74.00	-17.13	peak	228	75	
6	4960.000	21.94	4.83	26.77	54.00	-27.23	AVG	228	75	
7	7440.000	54.94	9.02	63.96	74.00	-10.04	peak	306	347	
8	7440.000	24.84	9.02	33.86	54.00	-20.14	AVG	306	347	

Remarks:

1. Emission Level = Read Level + Factor (Antenna Factor + Cable Loss - Preamp Factor)

Margin value = Emission level – Limit value

2. #2480 MHz: Fundamental frequency.

3.2 Conducted Emission Measurement

3.2.1 Limits of Conducted Emission Measurement

Frequency (MHz)	Conducted Limit (dBuV)	
	Quasi-peak	Average
0.15 - 0.5	66 - 56	56 - 46
0.50 - 5.0	56	46
5.0 - 30.0	60	50

Note: 1. The lower limit shall apply at the transition frequencies.
 2. The limit decreases in line with the logarithm of the frequency in the range of 0.15 to 0.50 MHz.

3.2.2 Test Instruments

Description & Manufacturer	Model No.	Serial No.	Due Date Of Calibration
EMI Test Receiver Rohde&Schwarz	ESCI3	101418	2021/09/05
Artificial Mains Network Rohde&Schwarz	ENV216	3560.6550.15	2021/09/16
Test software FARAD	EZ EMC V1.1.4.2	N/A	N/A
Hygrothermograph Yuhuaze	HTC-1	NA	2021/09/16
Digital Multimeter FLUKE	15B+	43512617WS	2021/09/16

Note: 1. The calibration interval of the above test instruments is 12 months and the calibrations are traceable to CEPREI/CHINA.
 2. The test was performed in Shielded Room 1.

3.2.3 Test Procedures

- The EUT was placed 0.4 meters from the conducting wall of the shielded room with EUT being connected to the power mains through a line impedance stabilization network (LISN). Other support units were connected to the power mains through another LISN. The two LISNs provide 50 ohm/ 50 uH of coupling impedance for the measuring instrument.
- Both lines of the power mains connected to the EUT were checked for maximum conducted interference.
- The frequency range from 150 kHz to 30 MHz was searched. Emission levels under (Limit – 20 dB) was not recorded.

Note: All modes of operation were investigated and the worst-case emissions are reported.

3.2.4 Deviation from Test Standard

No deviation.

3.2.5 Test Setup

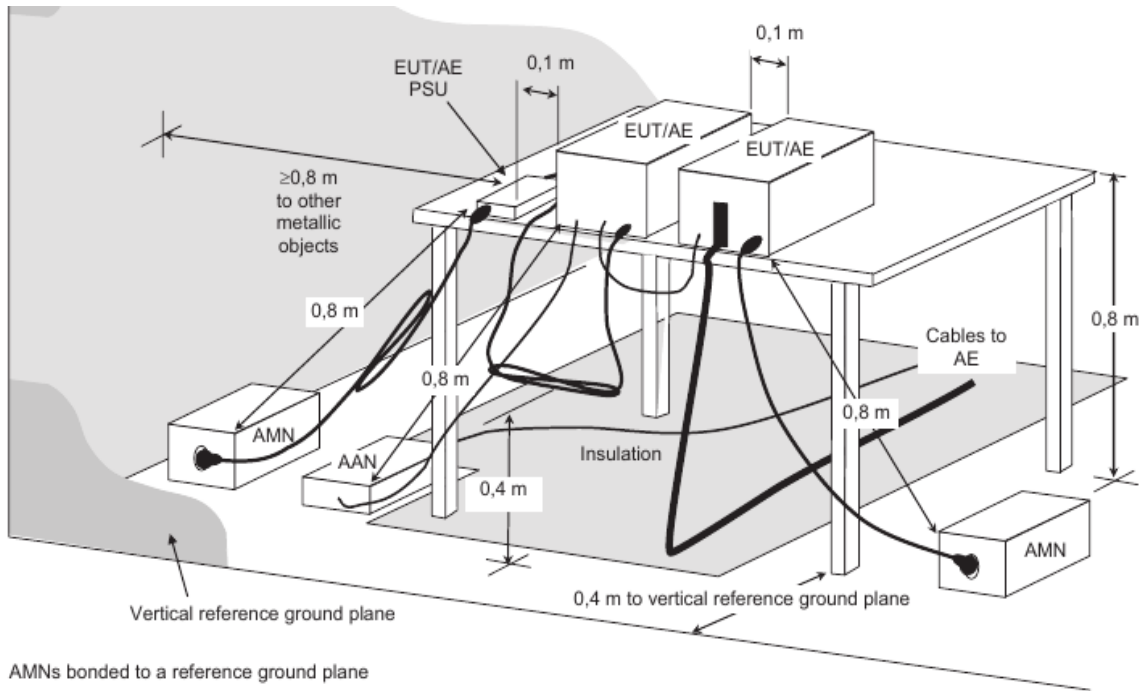

For the actual test configuration, please refer to the attached file (Test Setup Photo).

3.2.6 EUT Operating Condition

Set the EUT under transmission condition continuously at specific channel frequency.

3.2.7 Test Results

Conducted Worst-Case Data: GFSK

Frequency Range	150kHz ~ 30MHz	Detector Function & Resolution bandwidth	Quasi-Peak (QP) / Average (AV), 9kHz
Power supply	AC120V/60Hz	Environmental Conditions	25°C, 60%RH
Tested by	Tech Chen	Test Date	2021/01/11

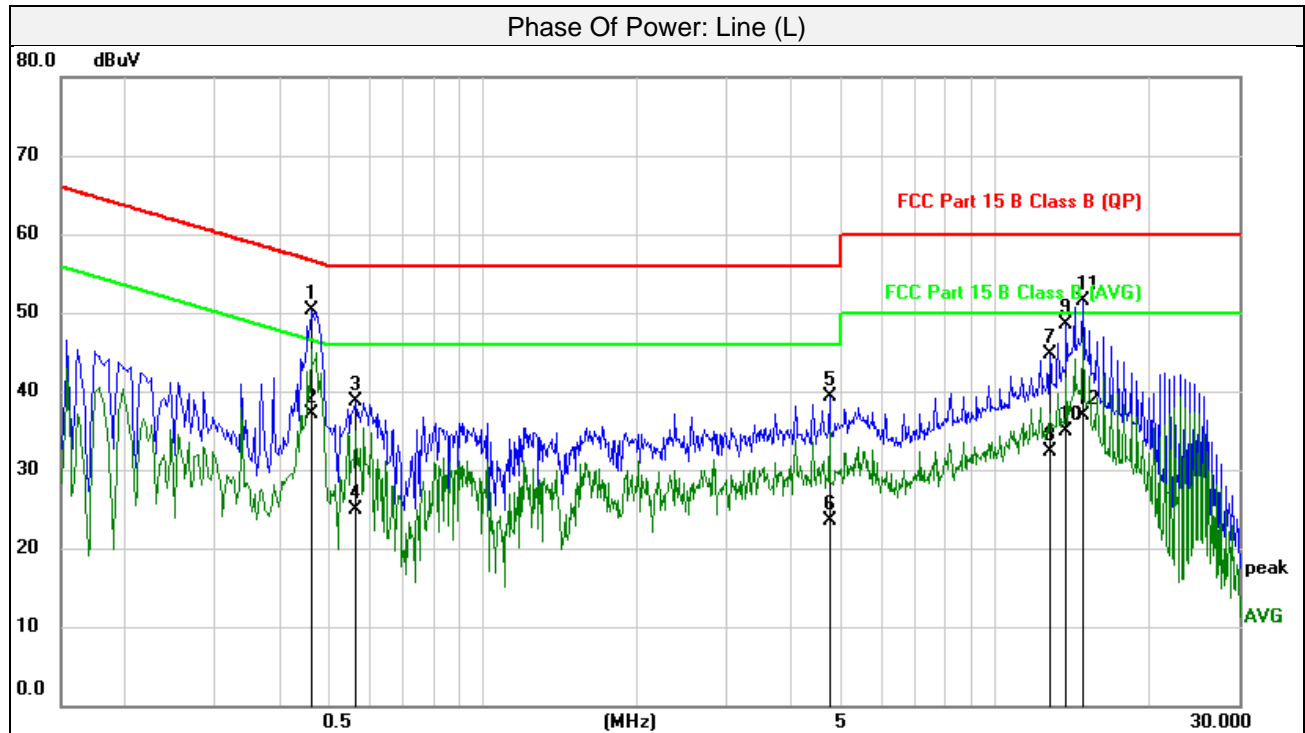

No.	Frequency (MHz)	Reading (dBuV)	Correction Factor (dB)	Emission Level (dBuV)	Limit (dBuV)	Margin (dB)	Remark
1	0.4660	40.52	9.72	50.24	56.58	-6.34	peak
2	0.4660	27.48	9.72	37.20	46.58	-9.38	AVG
3	0.5660	29.05	9.71	38.76	56.00	-17.24	peak
4	0.5660	15.21	9.71	24.92	46.00	-21.08	AVG
5	4.7580	29.67	9.71	39.38	56.00	-16.62	peak
6	4.7580	13.88	9.71	23.59	46.00	-22.41	AVG
7	12.8020	34.71	10.05	44.76	60.00	-15.24	peak
8	12.8020	22.28	10.05	32.33	50.00	-17.67	AVG
9	13.8260	38.37	10.10	48.47	60.00	-11.53	peak
10	13.8260	24.81	10.10	34.91	50.00	-15.09	AVG
11	14.8500	41.30	10.15	51.45	60.00	-8.55	peak
12	14.8500	26.81	10.15	36.96	50.00	-13.04	AVG

Remarks:

1. Q.P. and AV. are abbreviations of quasi-peak and average individually.
2. The emission levels of other frequencies were very low against the limit.
3. Margin value = Emission level - Limit value
4. Correction factor = Insertion loss + Cable loss
5. Emission Level = Correction Factor + Reading Value.

Frequency Range	150kHz ~ 30MHz	Detector Function & Resolution andwidth	Quasi-Peak (QP) / Average (AV), 9kHz
Power supply	AC120V/60Hz	Environmental Conditions	25°C, 60%RH
Tested by	Tech Chen	Test Date	2021/01/11

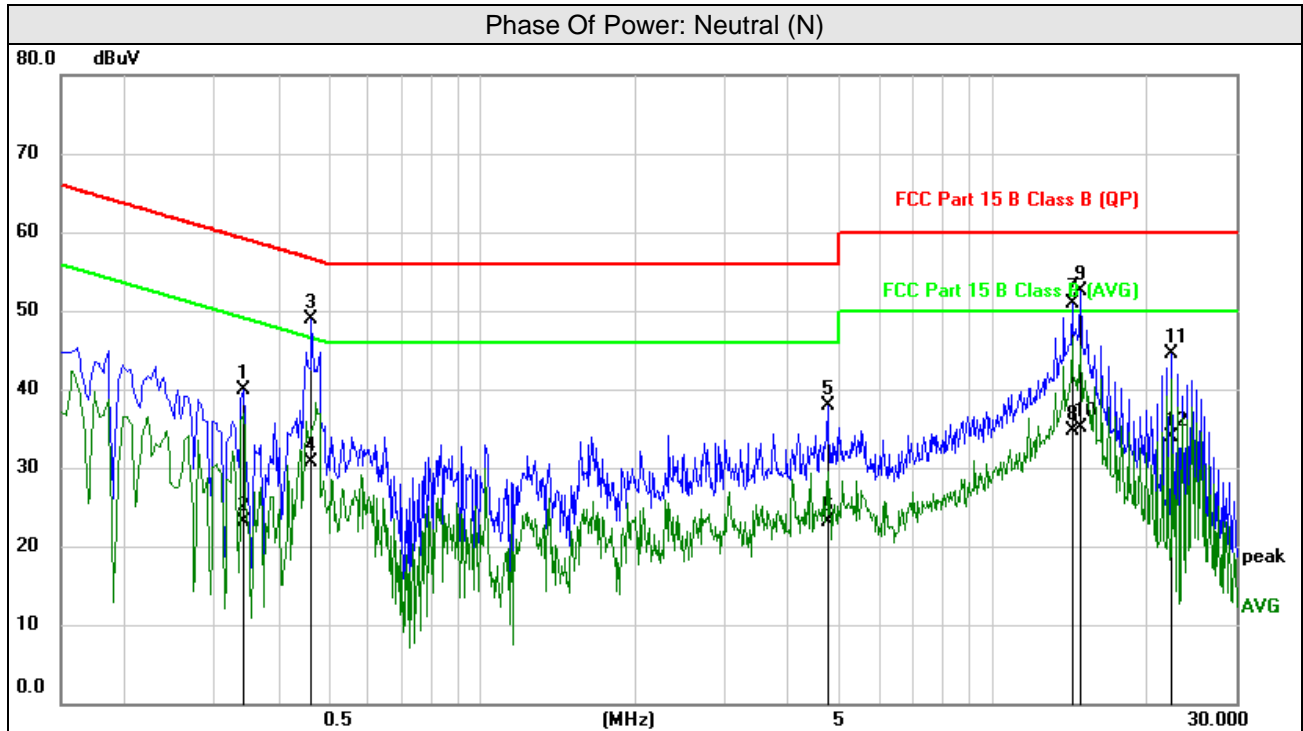

No.	Frequency (MHz)	Reading (dBuV)	Correct Factor (dB)	Emission Level (dBuV)	Limit (dBuV)	Margin (dB)	Remark
1	0.3420	30.20	9.70	39.90	59.15	-19.25	peak
2	0.3420	13.35	9.70	23.05	49.15	-26.10	AVG
3	0.4660	39.19	9.72	48.91	56.58	-7.67	peak
4	0.4660	20.93	9.72	30.65	46.58	-15.93	AVG
5	4.7500	28.23	9.71	37.94	56.00	-18.06	peak
6	4.7500	13.34	9.71	23.05	46.00	-22.95	AVG
7	14.3380	40.79	10.12	50.91	60.00	-9.09	peak
8	14.3380	24.62	10.12	34.74	50.00	-15.26	AVG
9	14.8500	42.40	10.15	52.55	60.00	-7.45	peak
10	14.8500	24.96	10.15	35.11	50.00	-14.89	AVG
11	22.5300	33.78	10.65	44.43	60.00	-15.57	peak
12	22.5300	23.25	10.65	33.90	50.00	-16.10	AVG

Remarks:

1. Q.P. and AV. are abbreviations of quasi-peak and average individually.
2. The emission levels of other frequencies were very low against the limit.
3. Margin value = Emission level - Limit value
4. Correction factor = Insertion loss + Cable loss
5. Emission Level = Correction Factor + Reading Value.

3.3 Number of Hopping Frequency Used

3.3.1 Limits of Hopping Frequency Used Measurement

At least 15 channels frequencies, and should be equally spaced.

3.3.2 Test Setup



3.3.3 Test Instruments

Refer to section 4.1.2 to get information of above instrument.

3.3.4 Test Procedure

- a. Check the calibration of the measuring instrument (SA) using either an internal calibrator or a known signal from an external generator.
- b. Turn on the EUT and connect its antenna terminal to measurement via a low loss cable. Then set it to any one measured frequency within its operating range and make sure the instrument is operated in its linear range.
- c. Set the SA on MaxHold Mode, and then keep the EUT in hopping mode. Record all the signals from each channel until each one has been recorded.
- d. Set the SA on View mode and then plot the result on SA screen.
- e. Repeat above procedures until all frequencies measured were complete.

3.3.5 Deviation from Test Standard

No deviation.

3.3.6 Test Results

There are 79 hopping frequencies in the hopping mode. Please refer to next page for the test result. On the plots, it shows that the hopping frequencies are equally spaced.

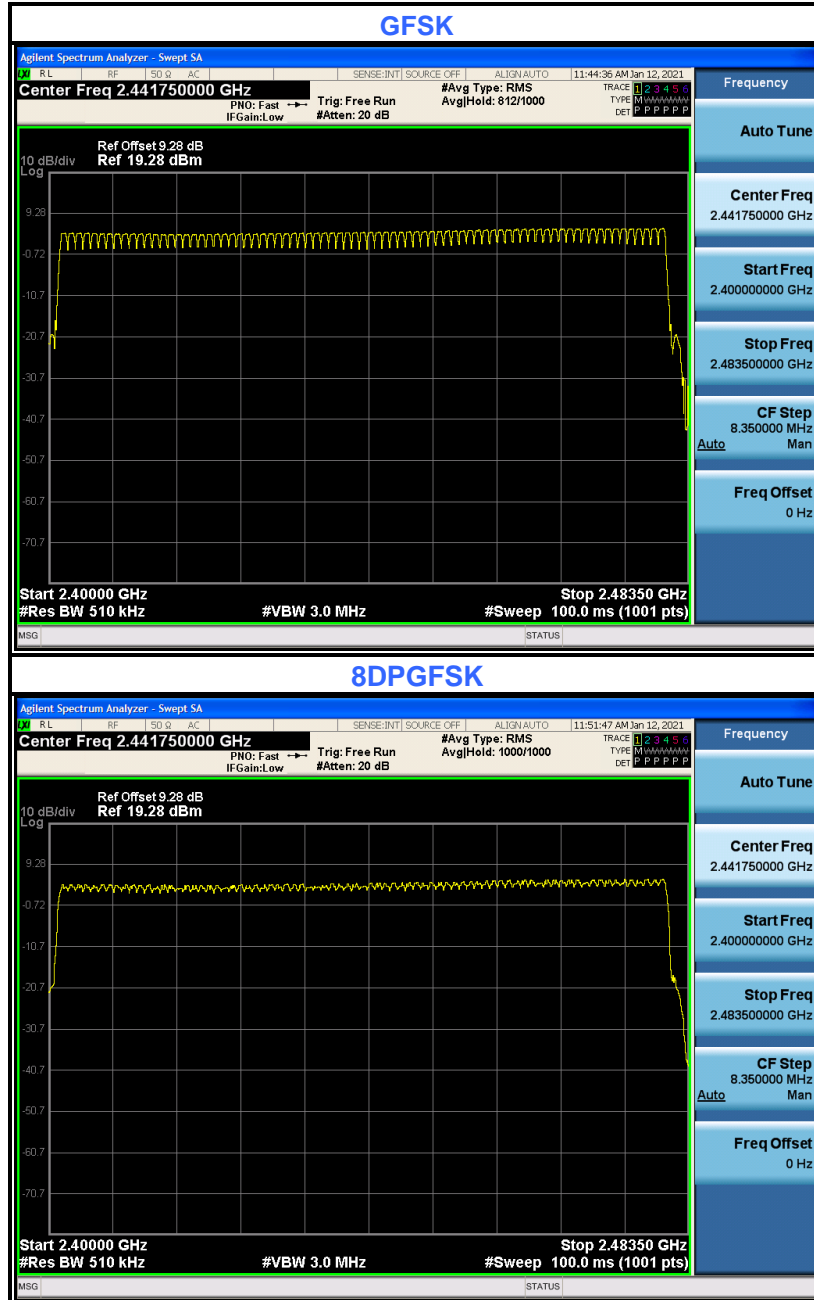

3.4 Dwell Time on Each Channel

3.4.1 Limits of Dwell Time on Each Channel Measurement

The average time of occupancy on any channel shall not be greater than 0.4 seconds within a period of 0.4 seconds multiplied by the number of hopping channels employed.

3.4.2 Test Setup

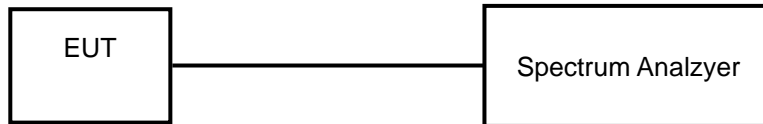

3.4.3 Test Instruments

Refer to section 4.1.2 to get information of above instrument.

3.4.4 Test Procedures

- a. Check the calibration of the measuring instrument (SA) using either an internal calibrator or a known signal from an external generator.
- b. Turn on the EUT and connect its antenna terminal to measurement via a low loss cable. Then set it to any one measured frequency within its operating range and make sure the instrument is operated in its linear range.
- c. Adjust the center frequency of SA on any frequency be measured and set SA to zero span mode. And then, set RBW and VBW of spectrum analyzer to proper value.
- d. Measure the time duration of one transmission on the measured frequency. And then plot the result with time difference of this time duration.
- e. Repeat above procedures until all different time-slot modes have been completed.

3.4.5 Deviation from Test Standard

No deviation.

3.4.6 Test Results

GFSK

Mode	Number of Hopping Channel	Number of transmission in a period (channel number*0.4 sec)				Length of transmission time (msec)	Result (msec)	Limit (msec)	Pass / Fail
		Period (sec)	Sweep time (sec)	times in a sweep	times in a period				
DH1	79	31.6	3.16	32	320	0.419	134.176	400	PASS
DH3	79	31.6	3.16	16	160	1.675	268.000	400	PASS
DH5	79	31.6	3.16	11	110	2.922	321.420	400	PASS

Note: Test plots of the transmitting time slot are shown as below.

8DPSK

Mode	Number of Hopping Channel	Number of transmission in a period (channel number*0.4 sec)				Length of transmission time (msec)	Result (msec)	Limit (msec)	Pass / Fail
		Period (sec)	Sweep time (sec)	times in a sweep	times in a period				
3DH1	79	31.6	3.16	32	320	0.429	137.408	400	PASS
3DH3	79	31.6	3.16	16	160	1.678	268.480	400	PASS
3DH5	79	31.6	3.16	11	110	2.930	322.300	400	PASS

Note: Test plots of the transmitting time slot are shown as below.

GFSK

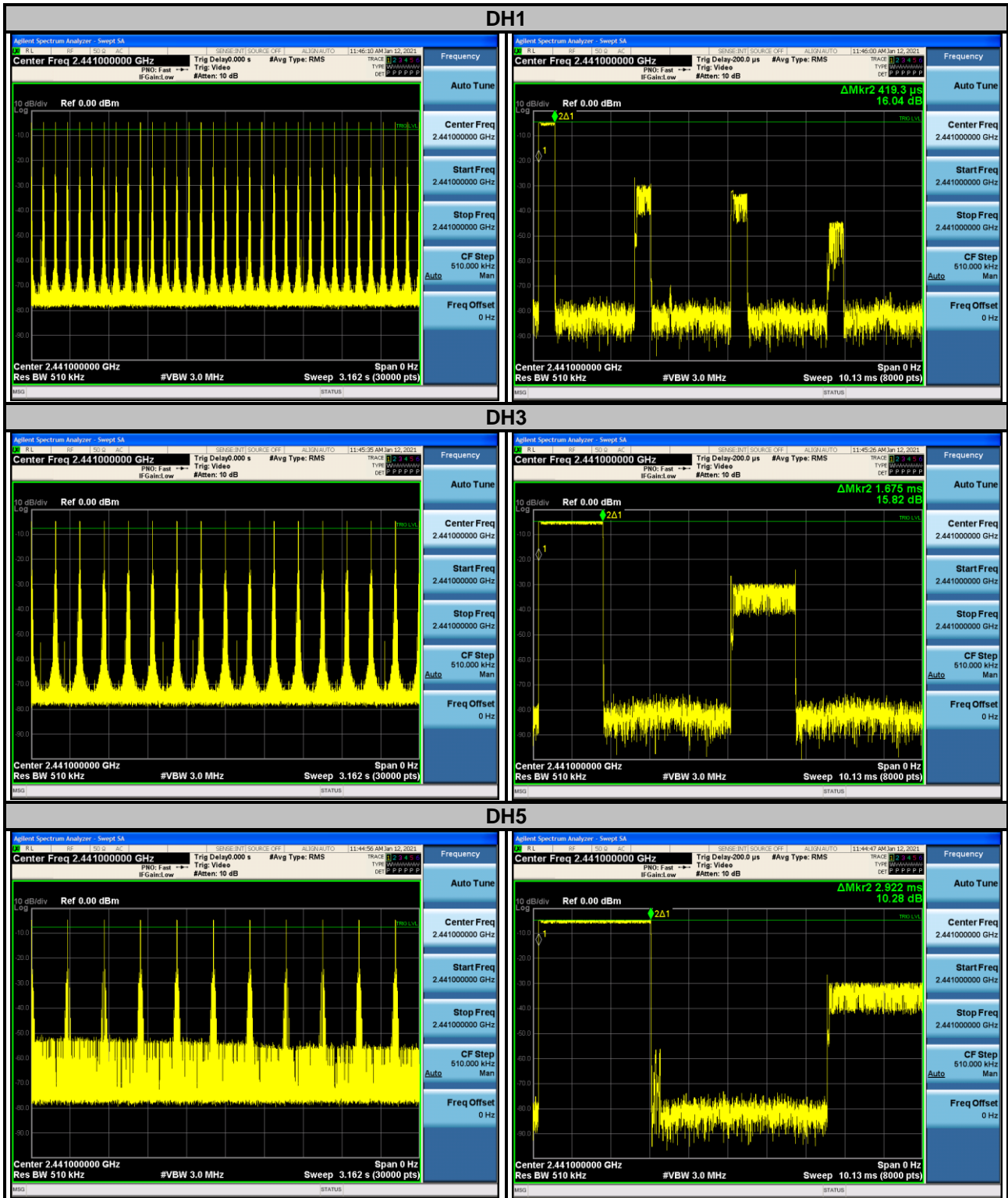

8DPSK

3DH1

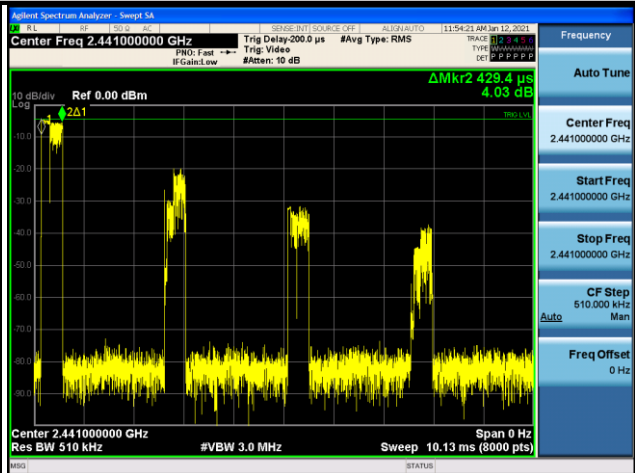
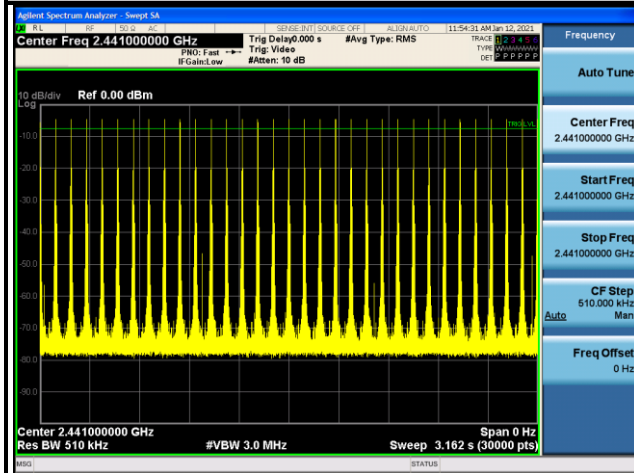

3DH3

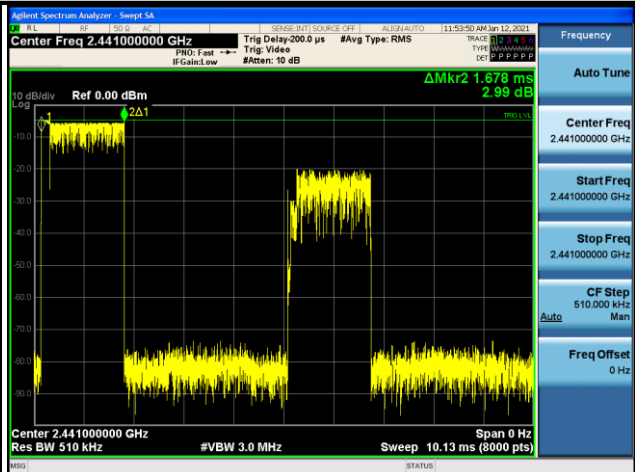
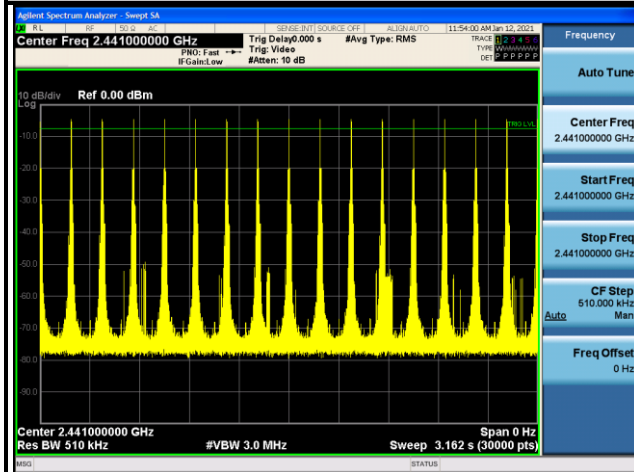

3DH5

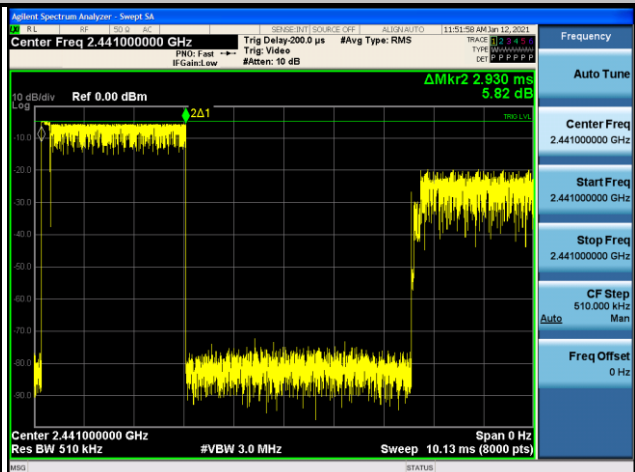
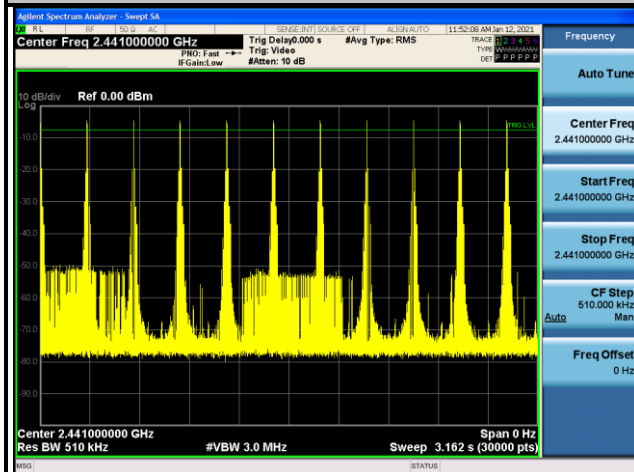

3.5 Channel Bandwidth

3.5.1 Limits of Channel Bandwidth Measurement

For frequency hopping system operating in the 2400-2483.5 MHz, if the 20 dB bandwidth of hopping channel is greater than 25 kHz, two-thirds 20 dB bandwidth of hopping channel shall be a minimum limit for the hopping channel separation.

3.5.2 Test Setup

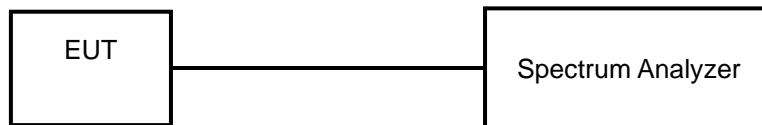

3.5.3 Test Instruments

Refer to section 4.1.2 to get information of above instrument.

3.5.4 Test Procedure

- a. Check the calibration of the measuring instrument using either an internal calibrator or a known signal from an external generator.
- b. Turn on the EUT and connect it to measurement instrument. Then set it to any one convenient frequency within its operating range. Set a reference level on the measuring instrument equal to the highest peak value.
- c. Measure the frequency difference of two frequencies that were attenuated 20 dB from the reference level. Record the frequency difference as the emission bandwidth.
- d. Repeat above procedures until all frequencies measured were complete.

3.5.5 Deviation from Test Standard

No deviation.

3.5.6 EUT Operating Condition

The software provided by client enabled the EUT to transmit and receive data at lowest, middle and highest channel frequencies individually.

3.5.7 Test Results

Channel	Frequency (MHz)	20 dB Bandwidth (MHz)	
		GFSK	8DPSK
0	2402	0.954	1.287
39	2441	1.005	1.296
78	2480	0.936	1.284

Spectrum Plot of Worst Value

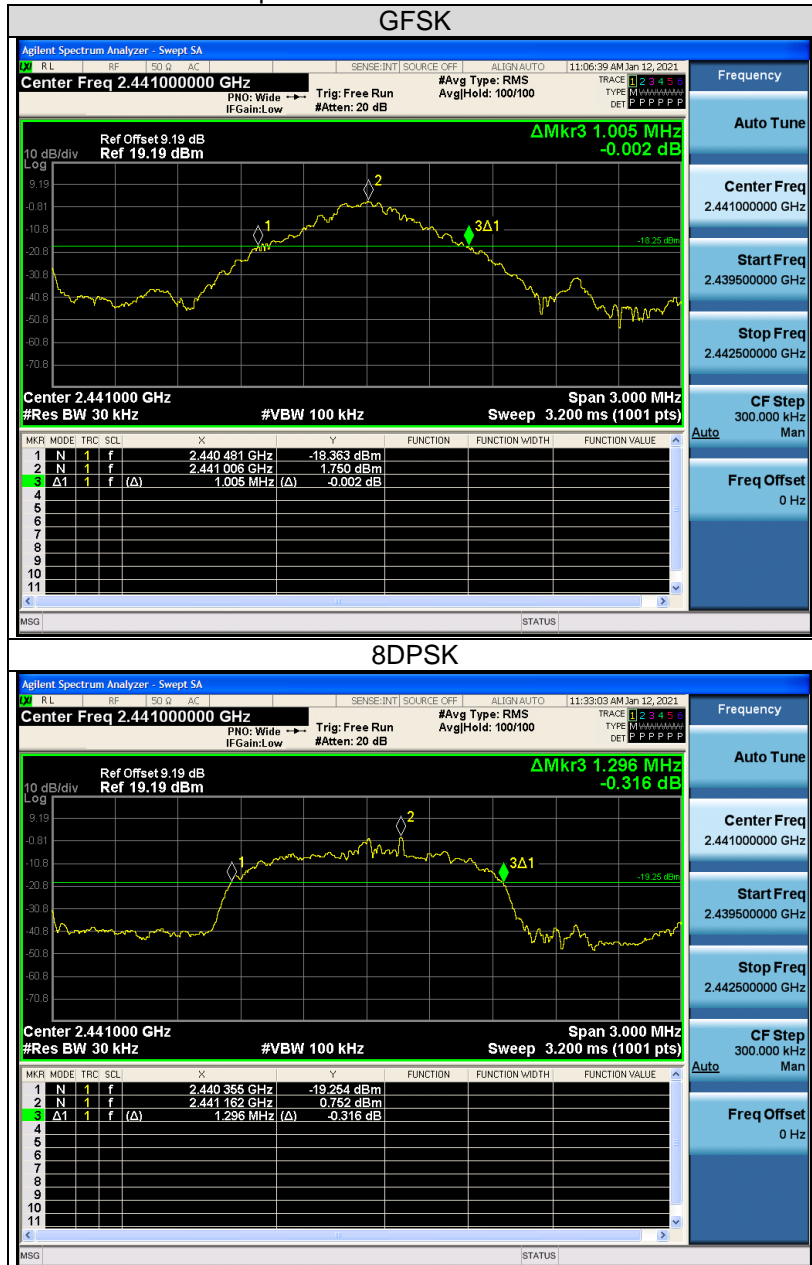

3.6 Occupied Bandwidth Measurement

3.6.1 Test Setup

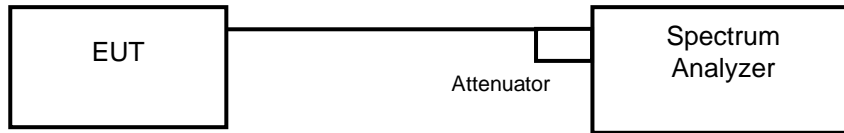

3.6.2 Test Instruments

Refer to section 4.1.2 to get information of above instrument

3.6.3 Test Procedure

The transmitter output was connected to the spectrum analyzer through an attenuator. The bandwidth of the fundamental frequency was measured by spectrum analyzer with resolution bandwidth in the range of 1 % to 5 % of the anticipated emission bandwidth, and a video bandwidth at least 3x the resolution bandwidth and set the detector to PEAK. The width of a frequency band such that, below the lower and above the upper frequency limits, the mean powers emitted are each equal to a specified percentage 0.5 % of the total mean power of a given emission.

3.6.4 Deviation from Test Standard

No deviation.

3.6.5 EUT Operating Conditions

The software provided by client to enable the EUT under transmission condition continuously at lowest, middle and highest channel frequencies individually.

3.6.6 Test Results

Channel	Frequency (MHz)	Occupied Bandwidth (MHz)	
		GFSK	8DPSK
0	2402	0.88043	1.20440
39	2441	0.89338	1.19980
78	2480	0.89413	1.19260



3.7 Hopping Channel Separation

3.7.1 Limits of Hopping Channel Separation Measurement

At least 25 kHz or two-third of 20 dB hopping channel bandwidth (whichever is greater).

3.7.2 Test Setup



3.7.3 Test Instruments

Refer to section 4.1.2 to get information of above instrument.

3.7.4 Test Procedure

Measurement Procedure REF

- a. Check the calibration of the measuring instrument using either an internal calibrator or a known signal from an external generator.
- b. Turn on the EUT and connect it to measurement instrument. Then set it to any one convenient frequency within its operating range.
- c. By using the MaxHold function record the separation of two adjacent channels.
- d. Measure the frequency difference of these two adjacent channels by SA MARK function. And then plot the result on SA screen.
- e. Repeat above procedures until all frequencies measured were complete.

3.7.5 Deviation from Test Standard

No deviation.

3.7.6 Test Results

Channel No.	Frequency (MHz)	Adjacent Channel Separation (MHz)		Minimum Limit (MHz)		Pass / Fail
		GFSK	8DPSK	GFSK	8DPSK	
0	2402	1.002	0.999	0.636	0.858	Pass
39	2441	0.999	0.996	0.670	0.864	Pass
78	2480	0.996	0.996	0.624	0.856	Pass

Note:

- The minimum limit is two-third 20 dB bandwidth.



3.8 Maximum Output Power

3.8.1 Limits of Maximum Output Power Measurement

The Maximum Output Power Measurement is 125 mW.

3.8.2 Test Setup

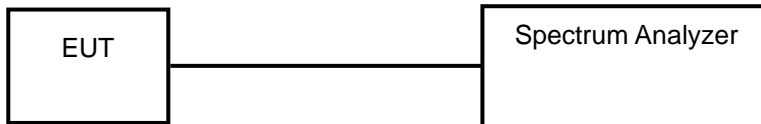

3.8.3 Test Instruments

Refer to section 4.1.2 to get information of above instrument.

3.8.4 Test Procedure

- a. Check the calibration of the measuring instrument using either an internal calibrator or a known signal from an external generator.
- b. Turn on the EUT and connect it to measurement instrument. Then set it to any one convenient frequency within its operating range. Set a reference level on the measuring instrument equal to the highest peak value.
- c. The center frequency of the spectrum analyzer is set to the fundamental frequency and using 1 MHz RBW and 3 MHz VBW.
- d. Measure the captured power within the band and recording the plot.
- e. Repeat above procedures until all frequencies required were complete.

3.8.5 Deviation from Test Standard

No deviation.

3.8.6 EUT Operating Condition

The software provided by client enabled the EUT to transmit and receive data at lowest, middle and highest channel frequencies individually.

3.8.7 Test Results

Peak power

Channel No.	Freq. (MHz)	Output Power (mW)		Output Power (dBm)		Power Limit (mW)	Pass / Fail
		GFSK	8DPSK	GFSK	8DPSK		
0	2402	2.767	2.698	4.42	4.31	125	Pass
39	2441	2.636	2.767	4.21	4.42	125	Pass
78	2480	2.649	3.034	4.23	4.82	125	Pass

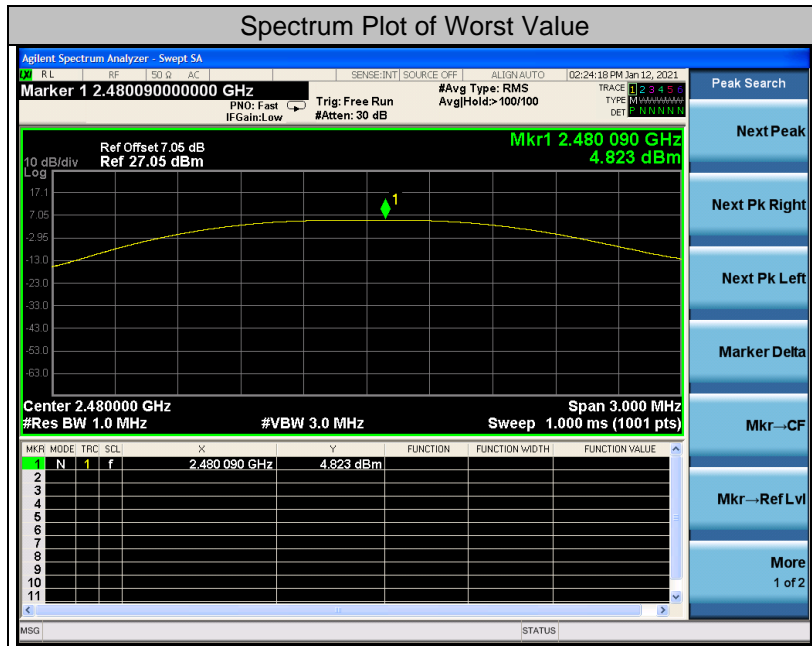

3.9 Conducted Out of Band Emission Measurement

3.9.1 Limits of Conducted Out of Band Emission Measurement

For average power:

Below -30 dB of the highest emission level of operating band (in 100 kHz Resolution Bandwidth).

For peak power:

Below -20 dB of the highest emission level of operating band (in 100 kHz Resolution Bandwidth)

3.9.2 Test Instruments

Refer to section 4.1.2 to get information of above instrument.

3.9.3 Test Procedure

The transmitter output was connected to the spectrum analyzer via a low lose cable. Set both RBW and VBW of spectrum analyzer to 100 kHz and 300 kHz with suitable frequency span including 100 MHz bandwidth from band edge. The band edges was measured and recorded.

3.9.4 Deviation from Test Standard

No deviation.

3.9.5 EUT Operating Condition

The software provided by client enabled the EUT to transmit and receive data at lowest, middle and highest channel frequencies individually.

3.9.6 Test Results

The spectrum plots are attached on the following images. D1 line indicates the highest level, D2 line indicates the 20 dB offset below D1. It shows compliance with the requirement.

GFSK

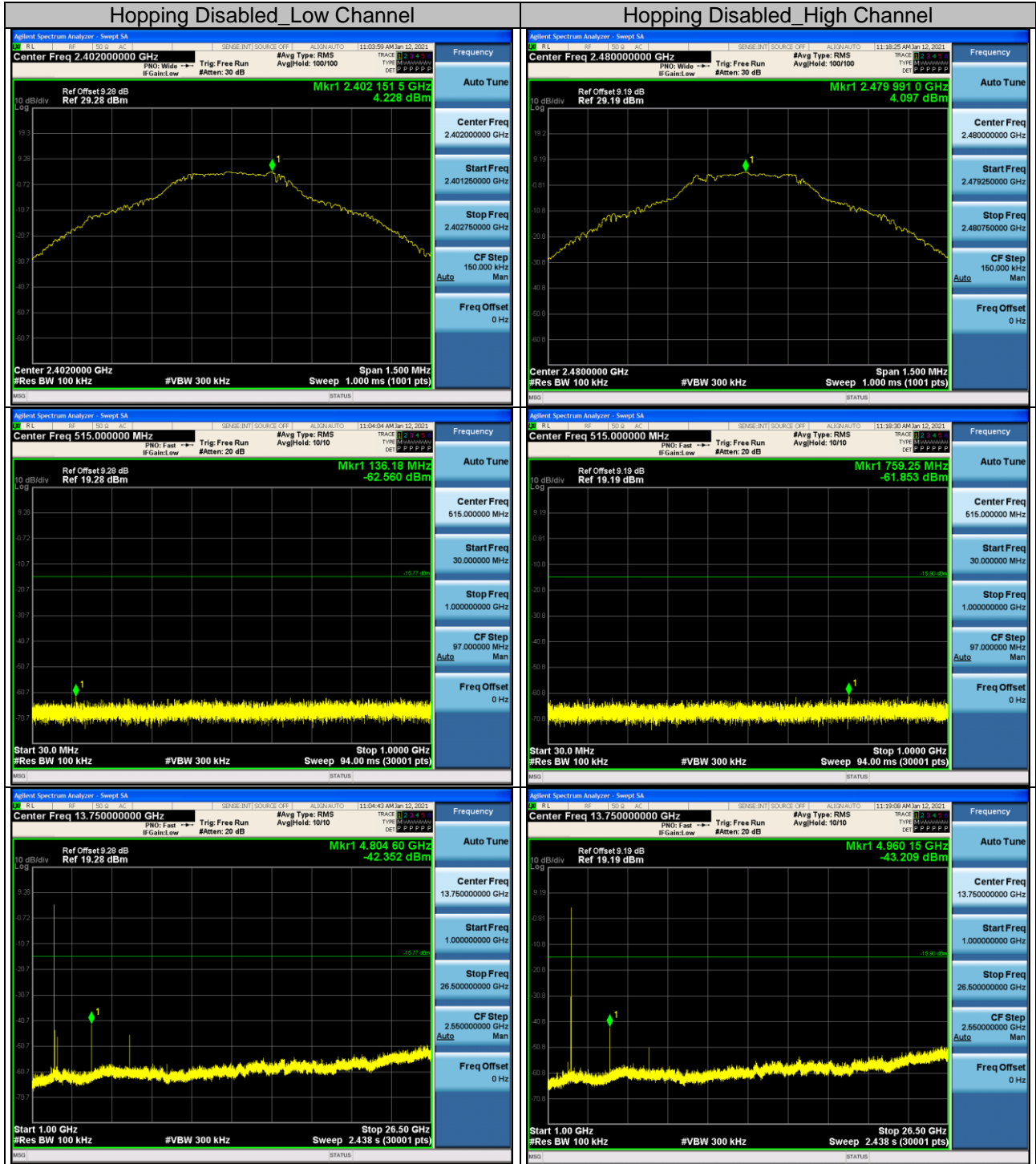

8DPSK

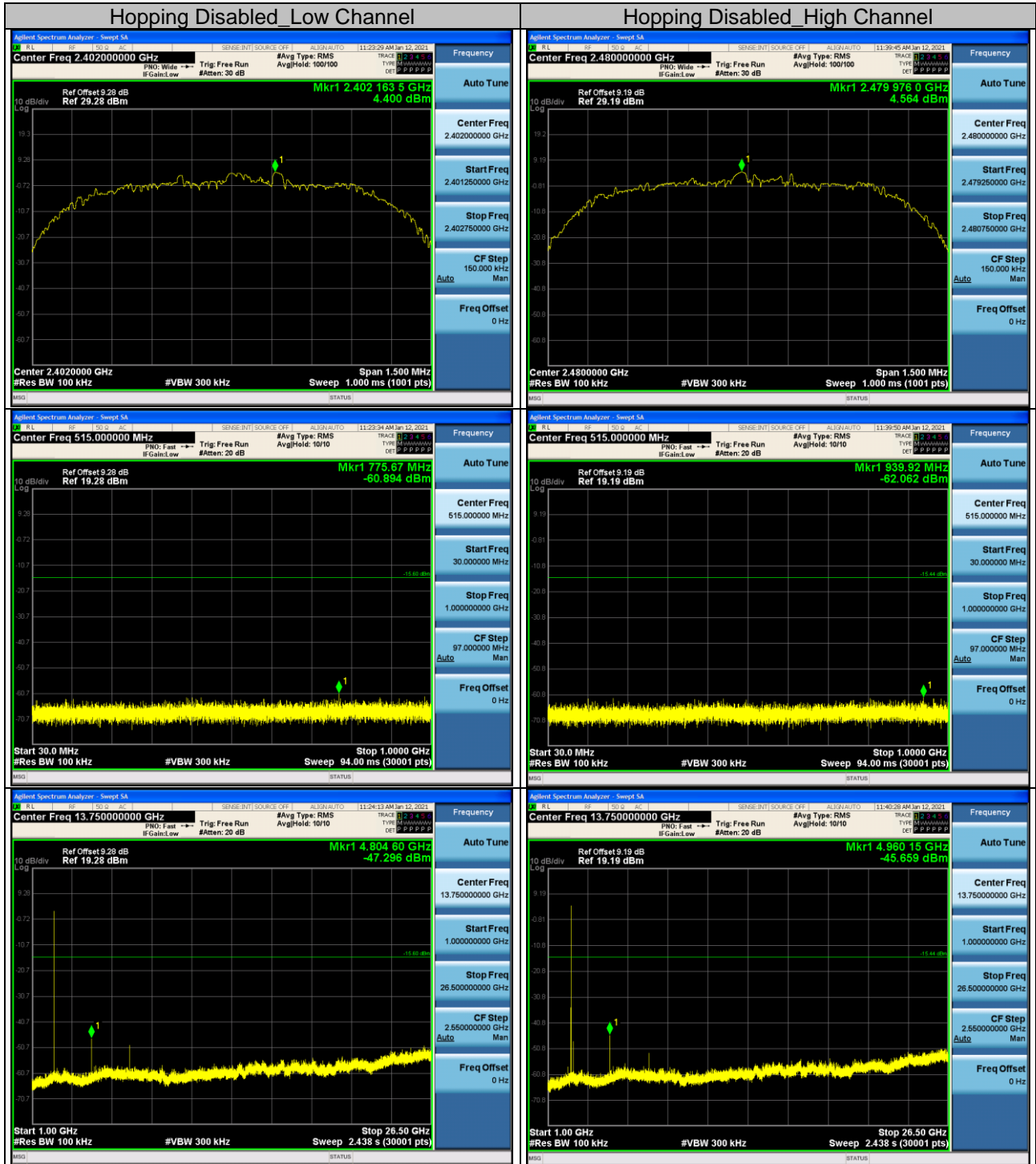

Bandedge: GFSK

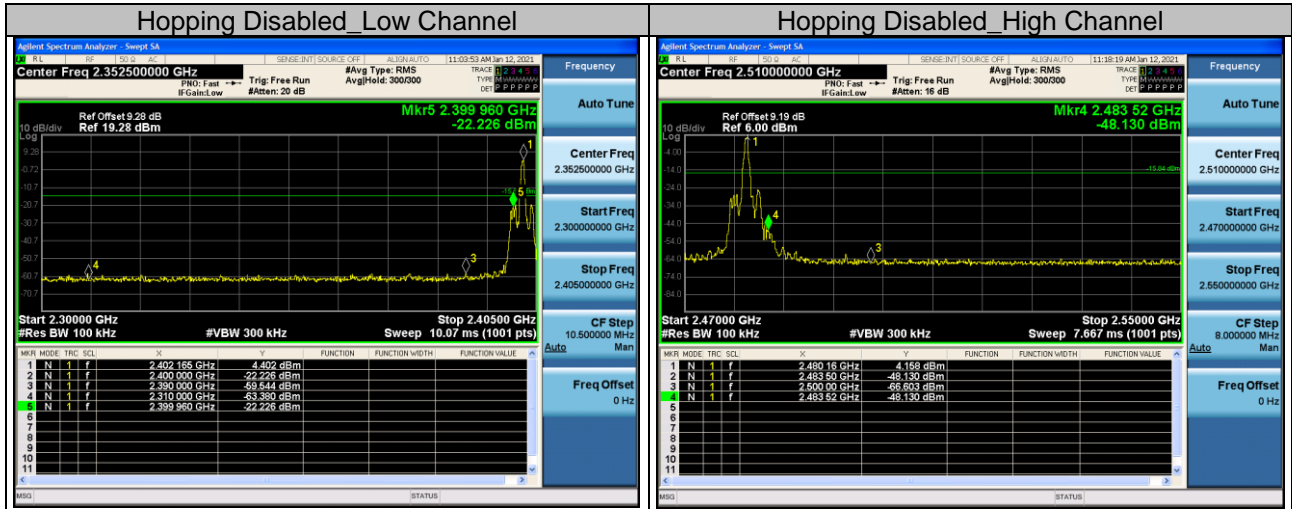

Bandedge: 8DPSK

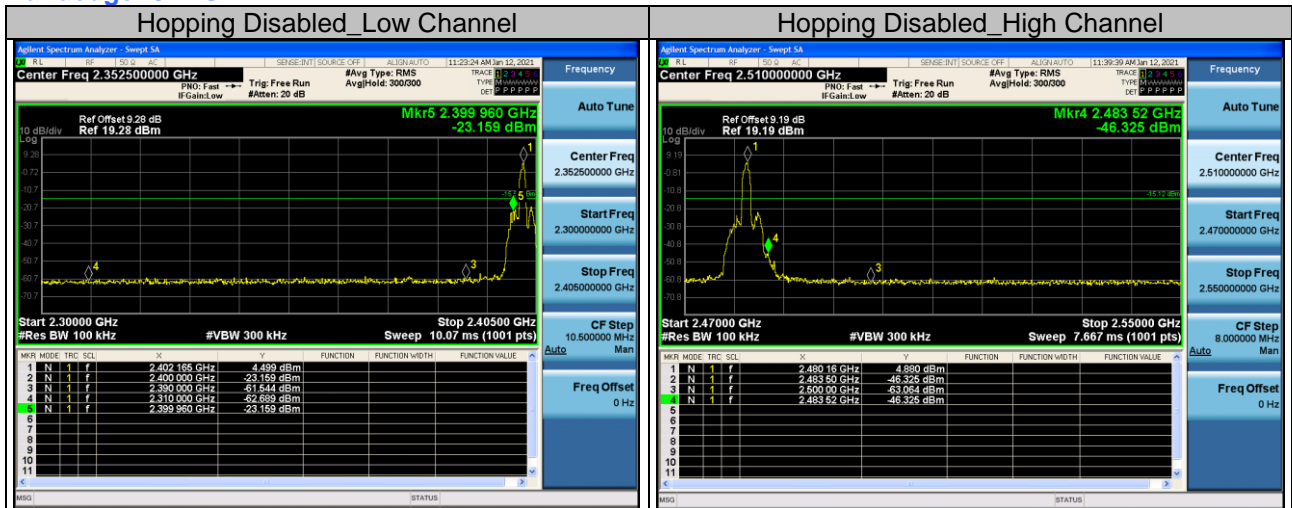

GFSK

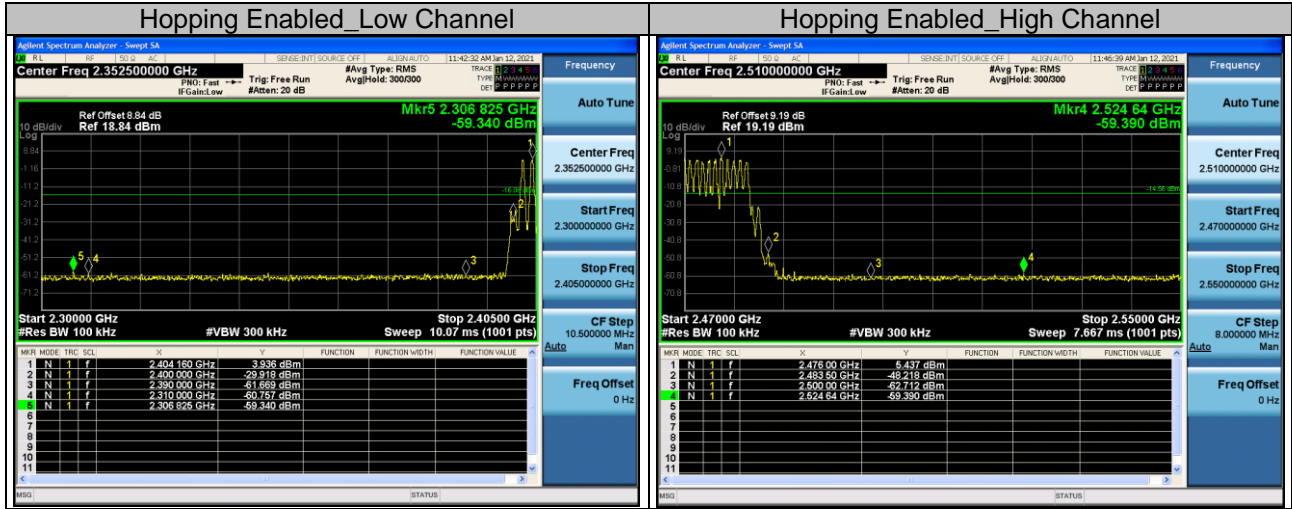

8DPSK

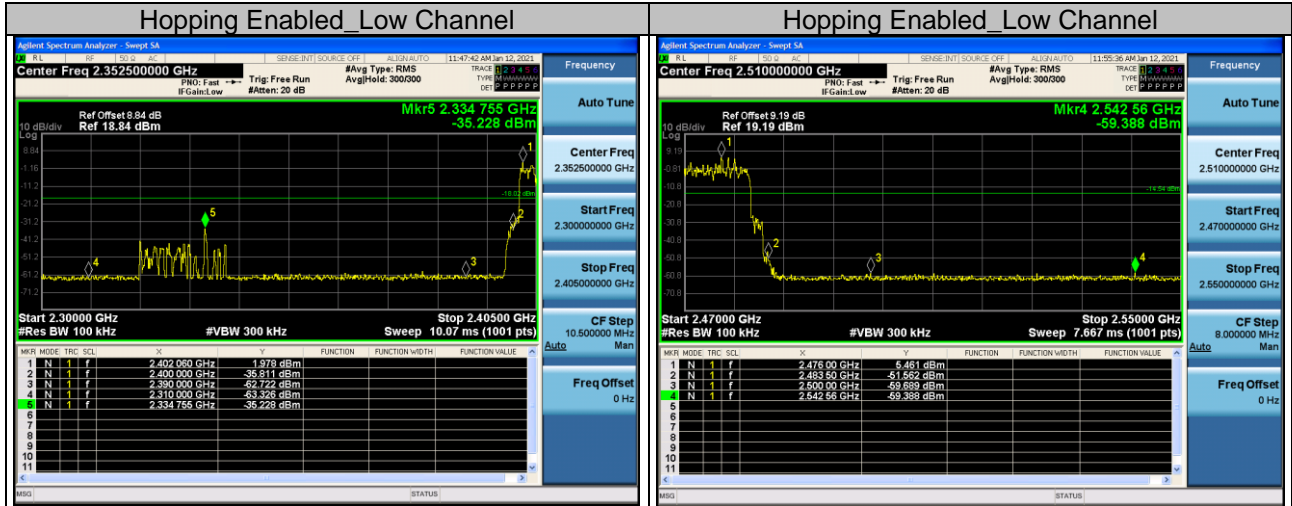

4 Pictures of Test Arrangements

Please refer to the attached file (Test Setup Photo).

4.1.2 Test Instruments

Description & Manufacturer	Model No.	Serial No.	Due Date of Calibration
Spectrum Keysight	N9020A	MY51240612	2021/09/16
Spectrum Analyzer Rohde&Schwarz	FSV-40N	101783	2021/09/16
Power Meter 10Hz~18GHz Tonscend	JS0806-2	188060126	2021/09/16
Signal generator Keysight	E4421B	GB40051020	2021/09/16
Signal generator Keysight	N5182A	MY47420944	2021/09/16
Test Software Tonscend	JS0806-2	NA	NA
Hygrothermograph Yuhuaze	HTC-1	NA	2021/09/16

1. The calibration interval of the above test instruments is 12 months and the calibrations are Note: traceable to CEPREI/CHINA.
2. The test was performed in Chamber 1.

Appendix – Information on the Testing Laboratories

We, [Hwa-Hsing \(Dongguan\) Co., Ltd.](#), A global provider of TESTING and CERTIFICATION services for consumer products, electronic products and wireless information technology products. Adhering to the core values “HONEST and TRUSTWORTHY, OBJECTIVE and IMPARTIALITY, RIGOROUS and AFFICIENT”, commitment to provide professional, perfect and efficient comprehensive ONE-STOP solution of TESTING and CERTIFICATION services for Manufacturers, Buyers, Traders, Brands, Retailers. Assist client to better manage risk, protect their brands, reduce costs and cut time to over 150 markets in global. Our laboratories are FCC recognized accredited test firms and accredited and approved according to ISO/IEC 17025.

If you have any comments, please feel free to contact us at the following:

Lab Address: [No.101, Bld N1, Yuyuan 2Rd, Yuyuan Industrial Park, HuangJiang Town, Dongguan, China](#)

Contact Tel: [0769-83078199](tel:0769-83078199)

Email: customerservice.dg@hwa-hsing.com

Web Site: www.hwa-hsing.com

The address and road map of all our labs can be found in our web site also.

--- END ---