



# FCC RADIO TEST REPORT

## FCC ID: XN6-S3821WSUB

**Product :** Wireless Subwoofer For 38" Sound Bar 2.1 System

**Trade Name :** VIZIO

**Model Name :** S3821w-C0 Subwoofer

**Serial Model :** S3821w-xxx Subwoofer( "x" is "A-Z" or "0-9" or "Blank")

**Report No. :** NTEK-2013NT0411903F

### Prepared for

Zylux Acoustic Corporation

3F, 22, Lane 35, Jihu Road, Neihu Technology Park, Taipei 11492, Taiwan

### Prepared by

Shenzhen NTEK Testing Technology Co., Ltd.

1/F, Building E, Fenda Science Park, Sanwei Community, Xixiang Street  
Bao'an District, Shenzhen P.R. China

Tel.: +86-0755-61156588 Fax.: +86-0755-61156599

Website: [www.ntek.org.cn](http://www.ntek.org.cn)

### TEST RESULT CERTIFICATION

**Applicant's name** ..... : Zylux Acoustic Corporation  
**Address** ..... : 3F, 22, Lane 35, Jihu Road, Neihu Technology Park, Taipei 11492, Taiwan  
**Manufacture's Name**..... : ZHAO YANG ELEC. (SHENZHEN) CO., LTD.  
**Address** ..... : Section A,4th Floor, Building 1 & Building 2, De Yong Jia Industrial Park, Guang Qiao Road, Yu Lv Community, Gong Ming Street, Guang Ming New District, Shenzhen

**Product description**

**Product name** ..... : Wireless Subwoofer For 38" Sound Bar 2.1 System  
**Model and/or type reference** : S3821w-C0 Subwoofer  
**Serial Model** : S3821w-xxx Subwoofer( "x" is "A-Z" or "0-9" or "Blank")  
**Rating(s)** ..... : AC 120V, 60Hz  
**Standards** ..... : FCC Part15.249  
**Test procedure**..... ANSI C63.4-2003

This device described above has been tested by NTEK, and the test results show that the equipment under test (EUT) is in compliance with the FCC requirements. And it is applicable only to the tested sample identified in the report.

This report shall not be reproduced except in full, without the written approval of NTEK, this document may be altered or revised by NTEK, personal only, and shall be noted in the revision of the document.

**Date of Test** ..... :  
**Date (s) of performance of tests** ..... : 11 Apr. 2013 ~24 Apr. 2013  
**Date of Issue**..... : 24 Apr. 2013  
**Test Result**..... : **Pass**

Testing Engineer : Apple Huang  
(Apple Huang)

Technical Manager : Tom Zhang  
(Tom Zhang)

Authorized Signatory : Bovey Yang  
(Bovey Yang)

<b>Table of Contents</b>	<b>Page</b>
<b>1 . SUMMARY OF TEST RESULTS</b>	<b>4</b>
1.1 TEST FACILITY	5
1.2 MEASUREMENT UNCERTAINTY	5
<b>2 . GENERAL INFORMATION</b>	<b>6</b>
2.1 GENERAL DESCRIPTION OF EUT	6
2.2 DESCRIPTION OF TEST MODES	8
2.3 BLOCK DIGRAM SHOWING THE CONFIGURATION OF SYSTEM TESTED	9
2.4 DESCRIPTION OF SUPPORT UNITS(CONDUCTED MODE)	10
2.5 EQUIPMENTS LIST FOR ALL TEST ITEMS	11
<b>3 . ANTENNA REQUIREMENT</b>	<b>12</b>
3.1 STANDARD REQUIREMENT	12
3.2 EUT ANTENNA	12
3.3 CONDUCTED EMISSION MEASUREMENT	13
3.3.1 POWER LINE CONDUCTED EMISSION LIMITS	13
3.3.2 TEST PROCEDURE	14
3.3.3 DEVIATION FROM TEST STANDARD	14
3.3.4 TEST SETUP	14
3.2.5 TEST RESULT	15
3.4 RADIATED EMISSION MEASUREMENT	19
3.4.1 RADIATED EMISSION LIMITS	19
3.4.2 TEST PROCEDURE	20
3.4.3 DEVIATION FROM TEST STANDARD	20
3.4.4 TEST SETUP	21
3.4.5 TEST RESULTS (BELOW 30MHZ)	23
3.4.6 TEST RESULTS (BETWEEN 30 – 1000 MHZ)	24
3.4.7 TEST RESULTS (ABOVE 1000 MHZ)	28
3.4.8 TEST RESULTS (RESTRICTED BANDS REQUIREMENTS)	34
<b>4 . BANDWIDTH TEST</b>	<b>38</b>
4.1 TEST PROCEDURE	38
4.2 DEVIATION FROM STANDARD	38
4.3 TEST SETUP	38
4.4 TEST RESULTS	39
<b>5 . EUT TEST PHOTO</b>	<b>42</b>
APPENDIX-PHOTOGRAPHS OF EUT CONSTRUCTIONAL DETAILS	

## 1. SUMMARY OF TEST RESULTS

Test procedures according to the technical standards:

<b>FCC Part15, Subpart C (15.249)</b>			
Standard Section	Test Item	Judgment	Remark
15.207	Conducted Emission	Pass	
15.203	Antenna Requirement	Pass	
15.249	Radiated Spurious Emission	Pass	
15.205	Band Edge Emission	Pass	
15.249	Occupied Bandwidth	Pass	

### 1.1 TEST FACILITY

NTEK Testing Technology Co., Ltd

Add. : 1/F, Building E, Fenda Science Park, Sanwei Community, Xixiang Street, Bao'an District, Shenzhen P.R. China.

FCC Registration No.:238937; IC Registration No.:9270A-1

CNAS Registration No.:L5516

### 1.2 MEASUREMENT UNCERTAINTY

The reported uncertainty of measurement  $y \pm U$ , where expanded uncertainty  $U$  is based on a standard uncertainty multiplied by a coverage factor of  $k=2$ , providing a level of confidence of approximately 95%.

No.	Item	Uncertainty
1	Conducted Emission Test	$\pm 1.38\text{dB}$
2	RF power,conducted	$\pm 0.16\text{dB}$
3	Spurious emissions,conducted	$\pm 0.21\text{dB}$
4	All emissions,radiated(<1G)	$\pm 4.68\text{dB}$
5	All emissions,radiated(>1G)	$\pm 4.89\text{dB}$
6	Temperature	$\pm 0.5^{\circ}\text{C}$
7	Humidity	$\pm 2\%$

## 2. GENERAL INFORMATION

### 2.1 GENERAL DESCRIPTION OF EUT

Equipment	Wireless Subwoofer For 38" Sound Bar 2.1 System	
Trade Name	<b>VIZIO</b>	
Model Name	S3821w-C0 Subwoofer	
Serial Model	S3821w-xxx Subwoofer( "x" is "A-Z" or "0-9" or "Blank")	
Model Difference	All the model are the same circuit and RF module,except the packaging.	
Product Description	The EUT is a Wireless Subwoofer For 38" Sound Bar 2.1 System	
	Operation Frequency:	2405.376~2475.008MHz
	Modulation Type:	GFSK
	Antenna Designation:	PCB Antenna
	Antenna Gain(Peak)	0.8 dBi
	Field Strength (at what distance):	85.94dbuv/m@3m(AV)
	Based on the application, features, or specification exhibited in User's Manual, the EUT is considered as an ITE/Computing Device. More details of EUT technical specification, please refer to the User's Manual.	
Channel List	Please refer to the Note 2.	
Adapter	N/A	
Battery	N/A	

Note:

1. For a more detailed features description, please refer to the manufacturer's specifications or the User's Manual.

2.

Channel No.	TX frequency (MHz)
CH1	2405.376
CH2	2415.616
CH3	2425.856
CH4	2436.096
CH5	2446.336
CH6	2456.576
CH7	2466.816
CH8	2475.008

3.

Table for Filed Antenna

Ant .	Brand	Model Name	Antenna Type	Connector	Gain (dBi)	NOTE
1	N/A	N/A	PCB Antenna	N/A	0.8	Antenna

## 2.2 DESCRIPTION OF TEST MODES

To investigate the maximum EMI emission characteristics generates from EUT, the test system was pre-scanning tested base on the consideration of following EUT operation mode or test configuration mode which possible have effect on EMI emission level. Each of these EUT operation mode(s) or test configuration mode(s) mentioned above was evaluated respectively.

Pretest Mode	Description
Mode 1	TX(Power supply board1)
Mode 2	TX(Power supply board2)

For Conducted Emission	
Final Test Mode	Description
Mode 1	TX(Power supply board1)
Mode 2	TX(Power supply board2)

For Radiated Emission	
Final Test Mode	Description
Mode 1	TX(Power supply board1)
Mode 2	TX(Power supply board2)

Note:

- (1) The measurements are performed at the highest, middle, lowest available channels.
- (2) The EUT use new battery.



### 2.3 BLOCK DIGRAM SHOWING THE CONFIGURATION OF SYSTEM TESTED

Conducted Emission Test

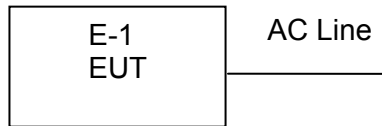

**2.4 DESCRIPTION OF SUPPORT UNITS(CONDUCTED MODE)**

The EUT has been tested as an independent unit together with other necessary accessories or support units. The following support units or accessories were used to form a representative test configuration during the tests.

Item	Equipment	Mfr/Brand	Model/Type No.	Series No.	Note
E-1	Wireless Subwoofer For 38" Sound Bar 2.1 System	VIZIO	S3821w-C0 Subwoofer	N/A	EUT

Item	Shielded Type	Ferrite Core	Length	Note

Note:

- (1) The support equipment was authorized by Declaration of Confirmation.
- (2) For detachable type I/O cable should be specified the length in cm in 『Length』 column.

## 2.5 EQUIPMENTS LIST FOR ALL TEST ITEMS

### Radiation Test equipment

Item	Kind of Equipment	Manufacturer	Type No.	Serial No.	Last calibration	Calibrated until	Calibration period
1	Bilog Antenna	TESEQ	CBL6111D	31216	Jul. 06, 2012	Jul. 05, 2013	1 year
2	Test Cable	N/A	R-01	N/A	Dec. 25, 2012	Dec. 24, 2013	1 year
3	Test Cable	N/A	R-02	N/A	Dec. 25, 2012	Dec. 24, 2013	1 year
4	EMI Test Receiver	R&S	ESCI-7	101318	Jul. 06, 2012	Jul. 05, 2013	1 year
5	Antenna Mast	EM	SC100_1	N/A	N/A	N/A	N/A
6	Turn Table	EM	SC100	060531	N/A	N/A	N/A
7	50Ω Switch	Anritsu Corp	MP59B	6200983705	Jul. 06, 2012	Jul. 05, 2013	1 year
8	Spectrum Analyzer	Aglient	E4407B	MY45108040	Jul. 06, 2012	Jul. 05, 2013	1 year
9	Horn Antenna	EM	EM-AH-10180	2011071402	Jul. 06, 2012	Jul. 05, 2013	1 year
10	Amplifier	EM	EM-30180	060538	Jul. 06, 2012	Jul. 05, 2013	1 year

### Conduction Test equipment

Item	Kind of Equipment	Manufacturer	Type No.	Serial No.	Last calibration	Calibrated until	Calibration period
1	LISN	R&S	ENV216	101313	Jul. 06, 2012	Jul. 05, 2013	1 year
2	LISN	SCHWARZBECK	NNLK 8129	8129245	Dec. 25, 2012	Dec. 24, 2013	1 year
3	Pulse Limiter	SCHWARZBECK	VTSD 9561F	9716	Dec. 25, 2012	Dec. 24, 2013	1 year
4	50Ω Switch	ANRITSU CORP	MP59B	6200983704	Jul. 06, 2012	Jul. 05, 2013	1 year
5	Test Cable	N/A	C01	N/A	Jul. 06, 2012	Jul. 05, 2013	1 year
6	Test Cable	N/A	C02	N/A	Jul. 06, 2012	Jul. 05, 2013	1 year
7	Test Cable	N/A	C03	N/A	Jul. 06, 2012	Jul. 05, 2013	1 year
8	Passive Voltage Probe	ESH2-Z3	R&S	100196	Jul. 06, 2012	Jul. 05, 2013	1 year
9	Absorbing Clamp	R&S	MDS-21	100423	Jul. 08, 2012	Jul. 07, 2013	1 year

### **3. ANTENNA REQUIREMENT**

#### **3.1 STANDARD REQUIREMENT**

15.203 requirement: For intentional device, according to 15.203: an intentional radiator shall be designed to ensure that no antenna other than that furnished by the responsible party shall be used with the device.

#### **3.2 EUT ANTENNA**

The EUT antenna is PCB Antenna. It comply with the standard requirement.

### 3.3 CONDUCTED EMISSION MEASUREMENT

#### 3.3.1 POWER LINE CONDUCTED EMISSION Limits (Frequency Range 150KHz-30MHz)

FREQUENCY (MHz)	Class A (dBuV)		Class B (dBuV)		Standard
	Quasi-peak	Average	Quasi-peak	Average	
0.15 -0.5			66 - 56 *	56 - 46 *	CISPR
0.50 -5.0			56.00	46.00	CISPR
5.0 -30.0			60.00	50.00	CISPR

0.15 -0.5			66 - 56 *	56 - 46 *	LP002.
0.50 -5.0			56.00	46.00	LP002.
5.0 -30.0			60.00	50.00	LP002.

Note:

- (1) The tighter limit applies at the band edges.
- (2) The limit of " \* " marked band means the limitation decreases linearly with the logarithm of the frequency in the range.

The following table is the setting of the receiver

Receiver Parameters	Setting
Attenuation	10 dB
Start Frequency	0.15 MHz
Stop Frequency	30 MHz
IF Bandwidth	9 kHz

### 3.3.2 TEST PROCEDURE

- a. The EUT was placed 0.4 meters from the horizontal ground plane with EUT being connected to the power mains through a line impedance stabilization network (LISN). All other support equipments powered from additional LISN(s). The LISN provide 50 Ohm/ 50uH of coupling impedance for the measuring instrument.
- b. Interconnecting cables that hang closer than 40 cm to the ground plane shall be folded back and forth in the center forming a bundle 30 to 40 cm long.
- c. I/O cables that are not connected to a peripheral shall be bundled in the center. The end of the cable may be terminated, if required, using the correct terminating impedance. The overall length shall not exceed 1 m.
- d. LISN at least 80 cm from nearest part of EUT chassis.
- e. For the actual test configuration, please refer to the related Item –EUT Test Photos.

### 3.3.3 DEVIATION FROM TEST STANDARD

No deviation

### 3.3.4 TEST SETUP

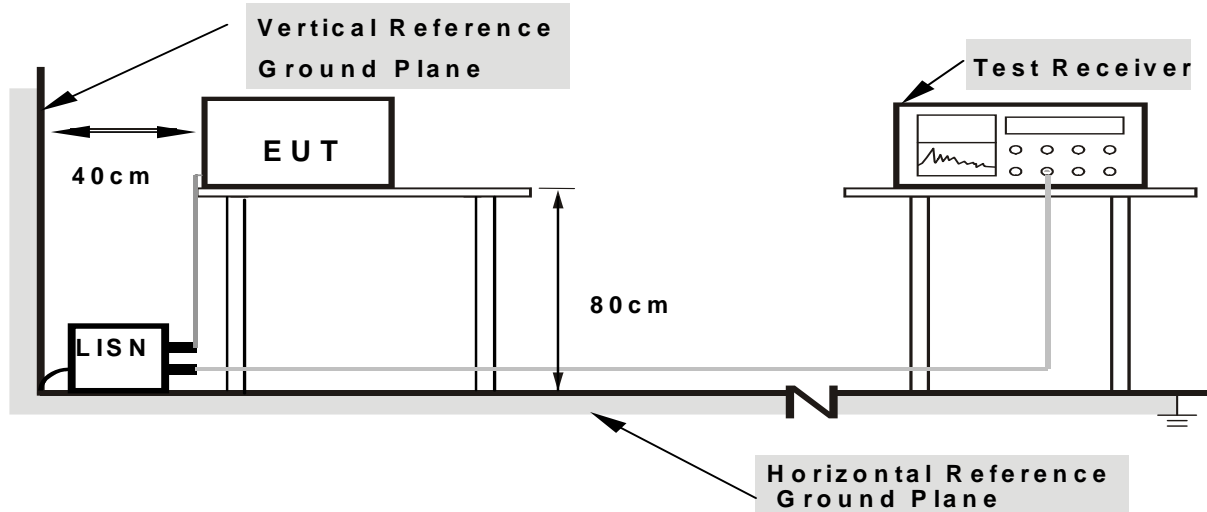

**Note: 1. Support units were connected to second LISN.**

**2. Both of LISNs (AMN) are 80 cm from EUT and at least 80 cm from other units and other metal planes**

### 3.2.5 TEST RESULT

EUT :	Wireless Subwoofer For 38" Sound Bar 2.1 System	Model Name. :	S3821w-C0 Subwoofer
Temperature :	26 °C	Relative Humidity :	54%
Pressure :	1010hPa	Phase :	L
Test Voltage :	AC 120V/60Hz	Test Mode :	Mode 1

Frequency (MHz)	Reading Level (dBμV)	Correct Factor (dB)	Measure-ment (dBμV)	Limits (dBμV)	Margin (dB)	Detector Type
0.1539	52.99	9.82	62.81	65.78	-2.97	QP
0.1539	32.22	9.82	42.04	55.78	-13.74	AVG
0.3820	35.74	10.03	45.77	58.23	-12.46	QP
0.3820	28.62	10.03	38.65	48.23	-9.58	AVG
4.5499	31.66	10.36	42.02	56.00	-13.98	QP
4.5499	15.12	10.36	25.48	46.00	-20.52	AVG

Remark:

1. All readings are Quasi-Peak and Average values.
2. Factor = Insertion Loss + Cable Loss.

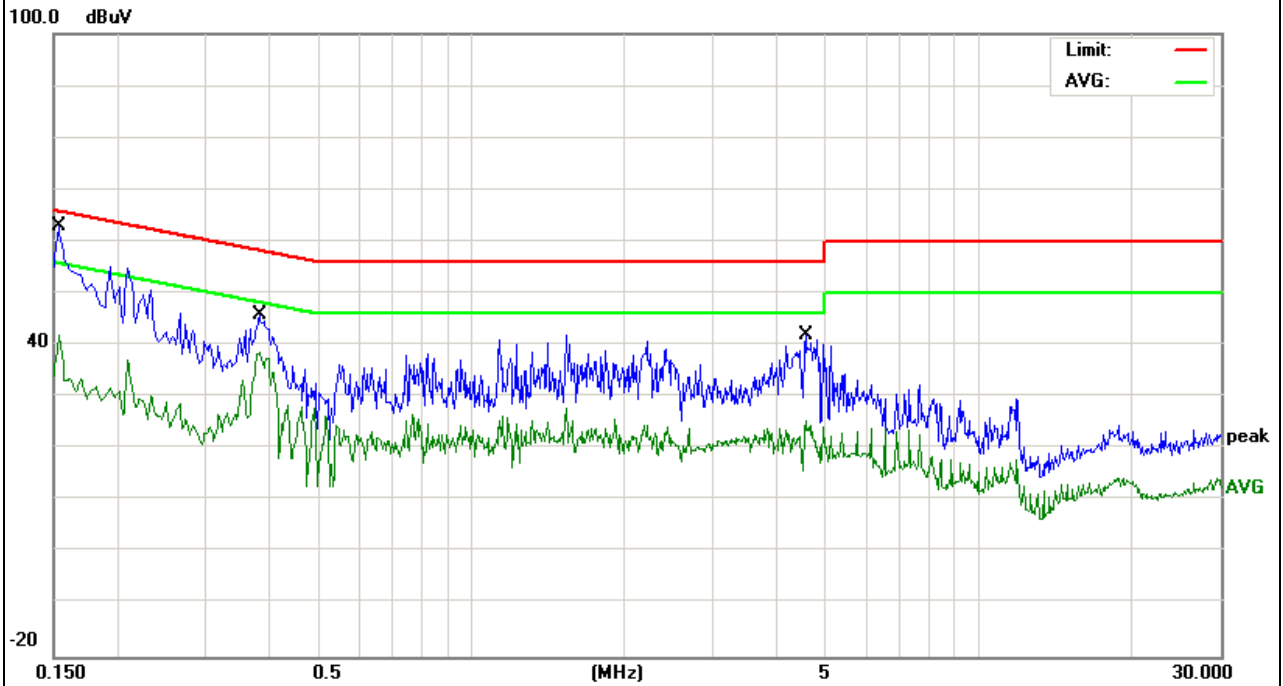

EUT :	Wireless Subwoofer For 38" Sound Bar 2.1 System	Model Name. :	S3821w-C0 Subwoofer
Temperature :	26 °C	Relative Humidity :	54%
Pressure :	1010hPa	Phase :	N
Test Voltage :	AC 120V/60Hz	Test Mode :	Mode 1

Frequency (MHz)	Reading Level (dBμV)	Correct Factor (dB)	Measure-ment (dBμV)	Limits (dBμV)	Margin (dB)	Detector Type
0.1500	51.99	9.82	61.81	65.99	-4.18	QP
0.1500	29.66	9.82	39.48	55.99	-16.51	AVG
0.3820	34.66	10.20	44.86	58.23	-13.37	QP
0.3820	28.69	10.20	38.89	48.23	-9.34	AVG
4.9939	26.81	10.35	37.16	56.00	-18.84	QP
4.9939	13.03	10.35	23.38	46.00	-22.62	AVG

Remark:

1. All readings are Quasi-Peak and Average values.
2. Factor = Insertion Loss + Cable Loss.

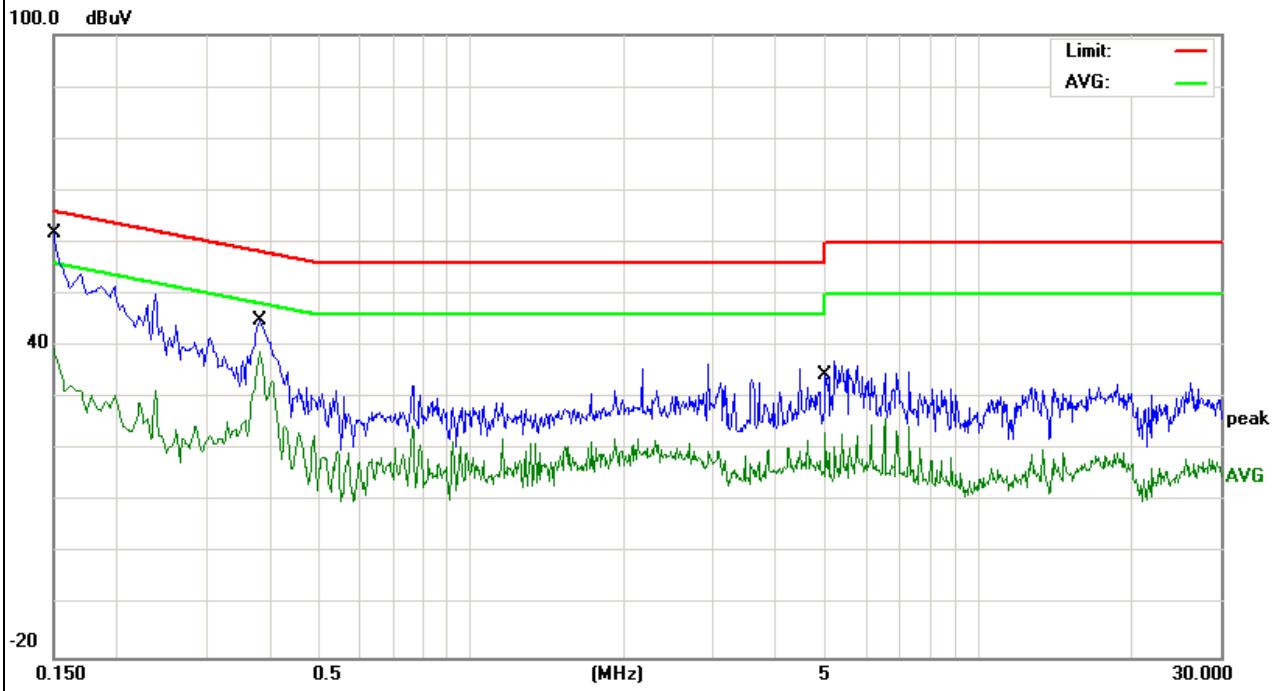



EUT :	Wireless Subwoofer For 38" Sound Bar 2.1 System	Model Name. :	S3821w-C0 Subwoofer
Temperature :	26 °C	Relative Humidity :	54%
Pressure :	1010hPa	Phase :	L
Test Voltage :	AC 120V/60Hz	Test Mode :	Mode 2

Frequency (MHz)	Reading Level (dBμV)	Correct Factor (dB)	Measure-ment (dBμV)	Limits (dBμV)	Margin (dB)	Detector Type
0.1539	43.22	9.82	53.04	65.78	-12.74	QP
0.1539	24.84	9.82	34.66	55.78	-21.12	AVG
0.3100	33.27	9.93	43.20	59.97	-16.77	QP
0.3100	30.39	9.93	40.32	49.97	-9.65	AVG
13.4819	29.17	10.43	39.60	60.00	-20.40	QP
13.4819	20.64	10.43	31.07	50.00	-18.93	AVG

Remark:

1. All readings are Quasi-Peak and Average values.
2. Factor = Insertion Loss + Cable Loss.

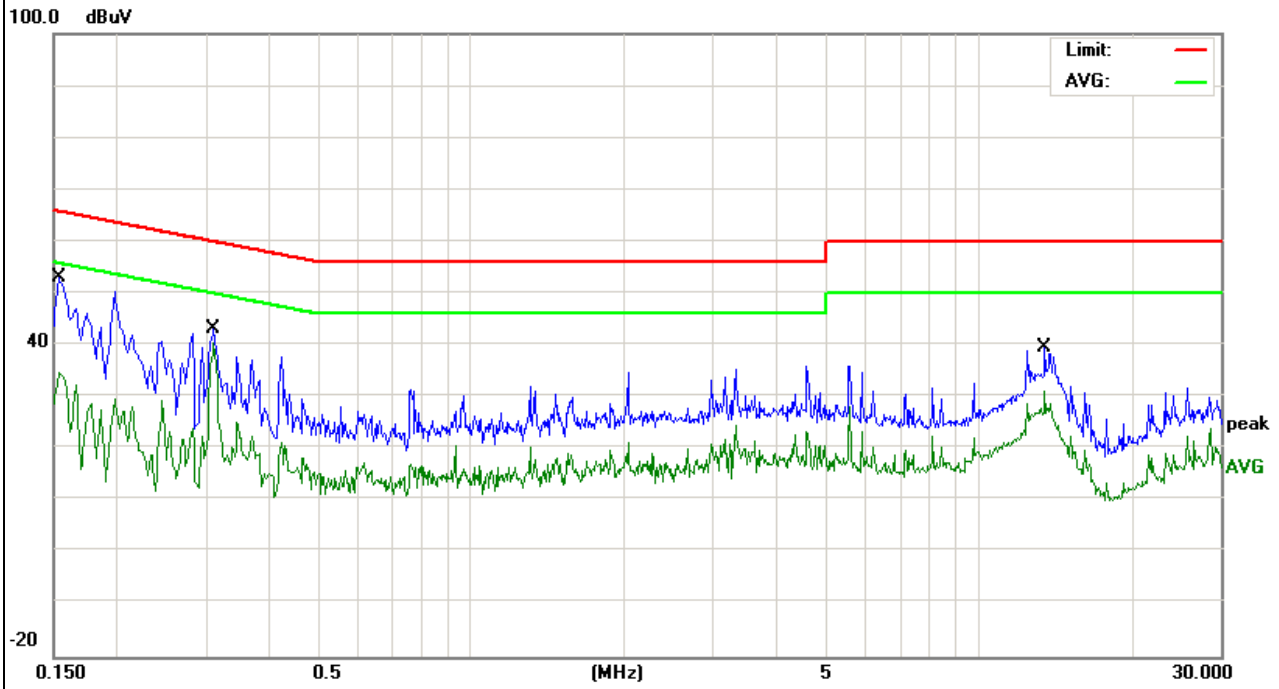

EUT :	Wireless Subwoofer For 38" Sound Bar 2.1 System	Model Name. :	S3821w-C0 Subwoofer
Temperature :	26 °C	Relative Humidity :	54%
Pressure :	1010hPa	Phase :	N
Test Voltage :	AC 120V/60Hz	Test Mode :	Mode 2

Frequency (MHz)	Reading Level (dBμV)	Correct Factor (dB)	Measure-ment (dBμV)	Limits (dBμV)	Margin (dB)	Detector Type
0.3100	31.69	9.93	41.62	59.97	-18.35	QP
0.3100	30.33	9.93	40.26	49.97	-9.71	AVG
1.5620	23.21	10.21	33.42	56.00	-22.58	QP
1.5620	9.53	10.21	19.74	46.00	-26.26	AVG
4.3419	22.48	10.36	32.84	56.00	-23.16	QP
4.3419	14.99	10.36	25.35	46.00	-20.65	AVG

Remark:

1. All readings are Quasi-Peak and Average values.
2. Factor = Insertion Loss + Cable Loss.

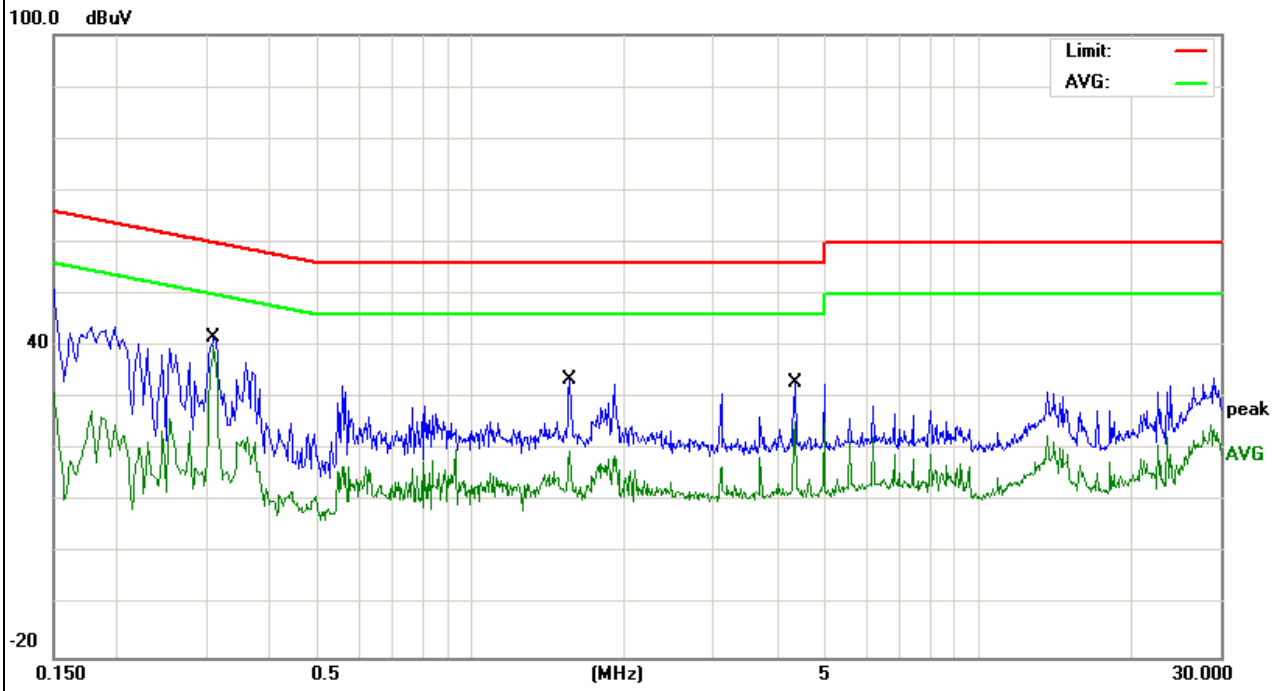

### 3.4 RADIATED EMISSION MEASUREMENT

#### 3.4.1 Radiated Emission Limits ( FCC 15.209 )

Frequencies (MHz)	Field Strength (micorvolts/meter)	Measurement Distance (meters)
0.009~0.490	2400/F(KHz)	300
0.490~1.705	24000/F(KHz)	30
1.705~30.0	30	30
30~88	100	3
88~216	150	3
216~960	200	3
Above 960	500	3

Note:

- (1) The tighter limit applies at the band edges.
- (2) Emission level (dBuV/m)=20log Emission level (uV/m).

#### LIMITS OF RADIATED EMISSION MEASUREMENT ( FCC 15.249)

Frequency of Emission (MHz)	Field Strength of fundamental ((millivolts /meter)	Field Strength of Harmonics (microvolts/meter)
2400 - 2483.5	50	500

Notes:

- (1) Emissions radiated outside of the specified frequency bands, except for harmonics, shall be attenuated by at least 50 dB below the level of the fundamental or to the general radiated emission limits in Section 15.209, whichever is the lesser attenuation.

Spectrum Parameter	Setting
Attenuation	Auto
Start Frequency	1000 MHz
Stop Frequency	10th carrier harmonic
RB / VB (emission in restricted band)	1MHz / 1MHz for Peak

Receiver Parameter	Setting
Attenuation	Auto
Start ~ Stop Frequency	9kHz~150kHz / RB 200Hz for QP
Start ~ Stop Frequency	150kHz~30MHz / RB 9kHz for QP
Start ~ Stop Frequency	30MHz~1000MHz / RB 120kHz for QP

### 3.4.2 TEST PROCEDURE

- a. The measuring distance of at 3 m shall be used for measurements at frequency up to 1GHz. For frequencies above 1GHz, any suitable measuring distance may be used.
- b. The EUT was placed on the top of a rotating table 0.8 meters above the ground at a 3m meter open area test site. The table was rotated 360 degrees to determine the position of the highest radiation.
- c. The height of the equipment or of the substitution antenna shall be 0.8 m; the height of the test antenna shall vary between 1 m to 4 m.
- d. The initial step in collecting conducted emission data is a spectrum analyzer peak detector mode pre-scanning the measurement frequency range. Significant peaks are then marked and then Quasi Peak detector mode re-measured.
- e. If the Peak Mode measured value compliance with and lower than Quasi Peak Mode Limit, the EUT shall be deemed to meet QP Limits and then no additional QP Mode measurement performed.
- f. For the actual test configuration, please refer to the related Item –EUT Test Photos.

Note:

Both horizontal and vertical antenna polarities were tested and performed pretest to three orthogonal axis. The worst case emissions were reported

### 3.4.3 DEVIATION FROM TEST STANDARD

No deviation

### 3.4.4 TEST SETUP

(A) Radiated Emission Test-Up Frequency Below 30MHz

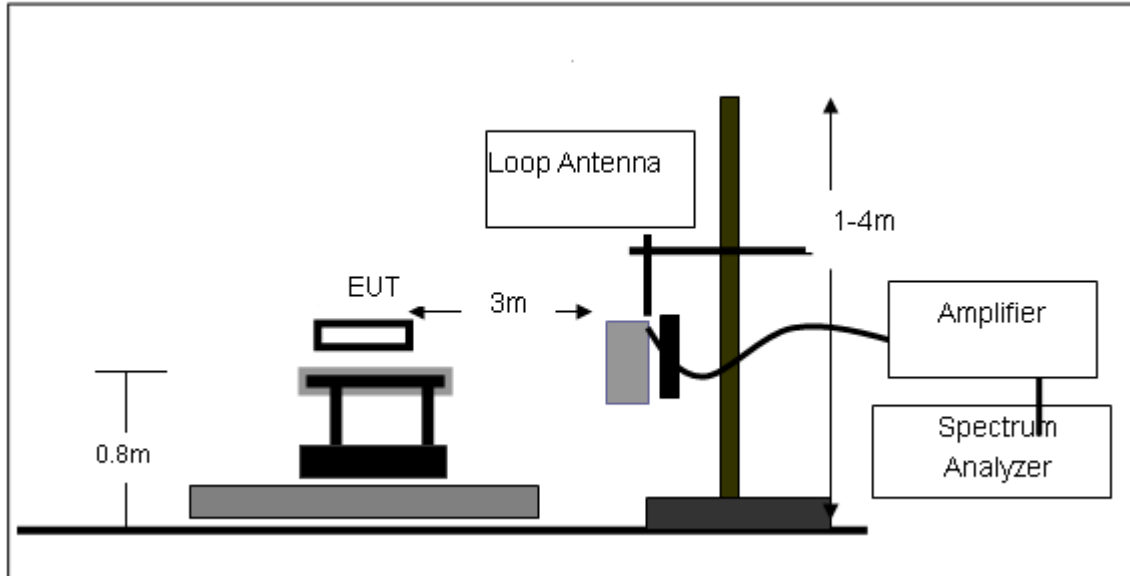

(B) Radiated Emission Test-Up Frequency 30MHz~1GHz

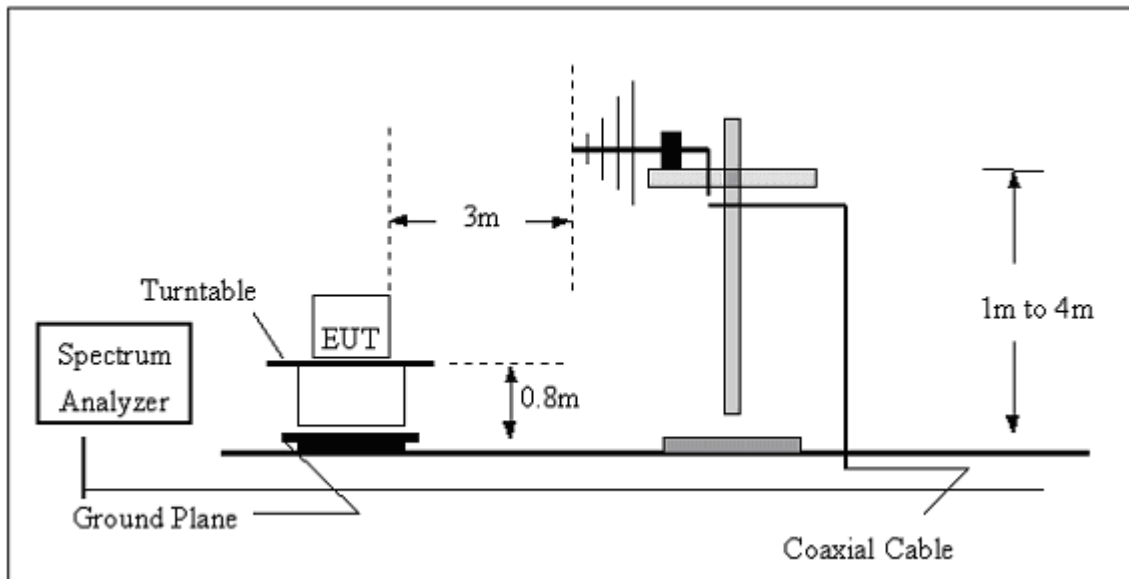

(C) Radiated Emission Test-Up Frequency Above 1GHz

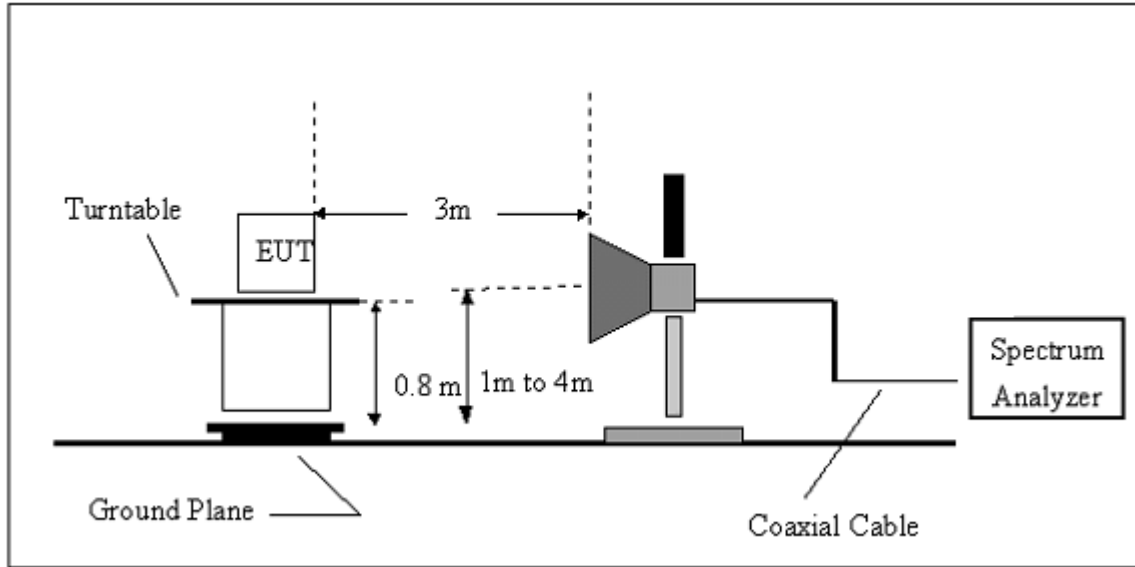

**3.4.5 TEST RESULTS (BELOW 30MHz)**

EUT :	Wireless Subwoofer For 38" Sound Bar 2.1 System	Model Name. :	S3821w-C0 Subwoofer
Temperature :	20 °C	Relative Humidity :	48%
Pressure :	1010 hPa	Test Voltage :	AC 120V/60Hz
Test Mode :	TX	Polarization :	--

Freq.	Reading	Limit	Margin	State
(MHz)	(dBuV/m)	(dBuV/m)	(dB)	P/F
--	--	--	--	PASS
--	--	--	--	PASS

**NOTE:**

The amplitude of spurious emissions which are attenuated by more than 20dB below the permissible value has no need to be reported.

Distance extrapolation factor =  $20 \log (\text{specific distance}/\text{test distance})(\text{dB})$ ;

Limit line = specific limits(dBuv) + distance extrapolation factor.

### 3.4.6 TEST RESULTS (BETWEEN 30 – 1000 MHZ)

EUT :	Wireless Subwoofer For 38" Sound Bar 2.1 System	Model Name :	S3821w-C0 Subwoofer
Temperature :	20 °C	Relative Humidity :	48%
Pressure :	1010 hPa	Test Voltage :	AC 120V/60Hz
Test Mode :	Mode 1	Polarization :	Vertical

Frequency (MHz)	Meter Reading (dBμV)	Factor (dB)	Emission Level (dBμV/m)	Limits (dBμV/m)	Margin (dB)	Detector Type
36.1272	16.58	15.31	31.89	40.00	-8.11	QP
63.5356	17.40	5.40	22.80	40.00	-17.20	QP
106.0126	14.09	11.17	25.26	43.50	-18.24	QP
143.8293	12.61	12.06	24.67	43.50	-18.83	QP
248.5517	14.50	13.25	27.75	46.00	-18.25	QP
614.2142	7.86	23.48	31.34	46.00	-14.66	QP

Remark:

- Factor = Antenna Factor + Cable Loss – Pre-amplifier.

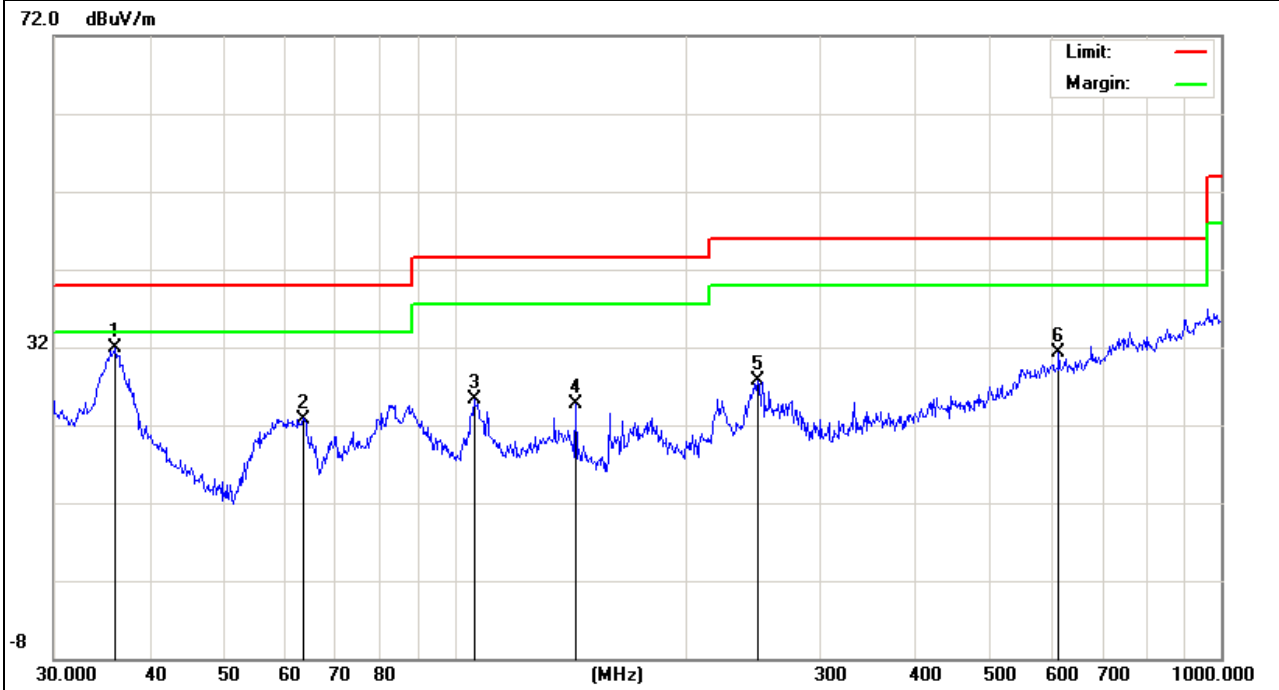



EUT :	Wireless Subwoofer For 38" Sound Bar 2.1 System	Model Name :	S3821w-C0 Subwoofer
Temperature :	20 °C	Relative Humidity :	48%
Pressure :	1010 hPa	Test Voltage :	AC 120V/60Hz
Test Mode :	Mode 1	Polarization :	Horizontal

Frequency (MHz)	Meter Reading (dBμV)	Factor (dB)	Emission Level (dBμV/m)	Limits (dBμV/m)	Margin (dB)	Detector Type
167.8240	24.30	10.59	34.89	43.50	-8.61	QP
227.6904	25.82	10.77	36.59	46.00	-9.41	QP
263.8190	22.97	14.62	37.59	46.00	-8.41	QP
293.0842	20.89	14.56	35.45	46.00	-10.55	QP
739.6603	7.76	26.47	34.23	46.00	-11.77	QP
962.1621	9.60	29.87	39.47	54.00	-14.53	QP

Remark:

1. Factor = Antenna Factor + Cable Loss – Pre-amplifier.

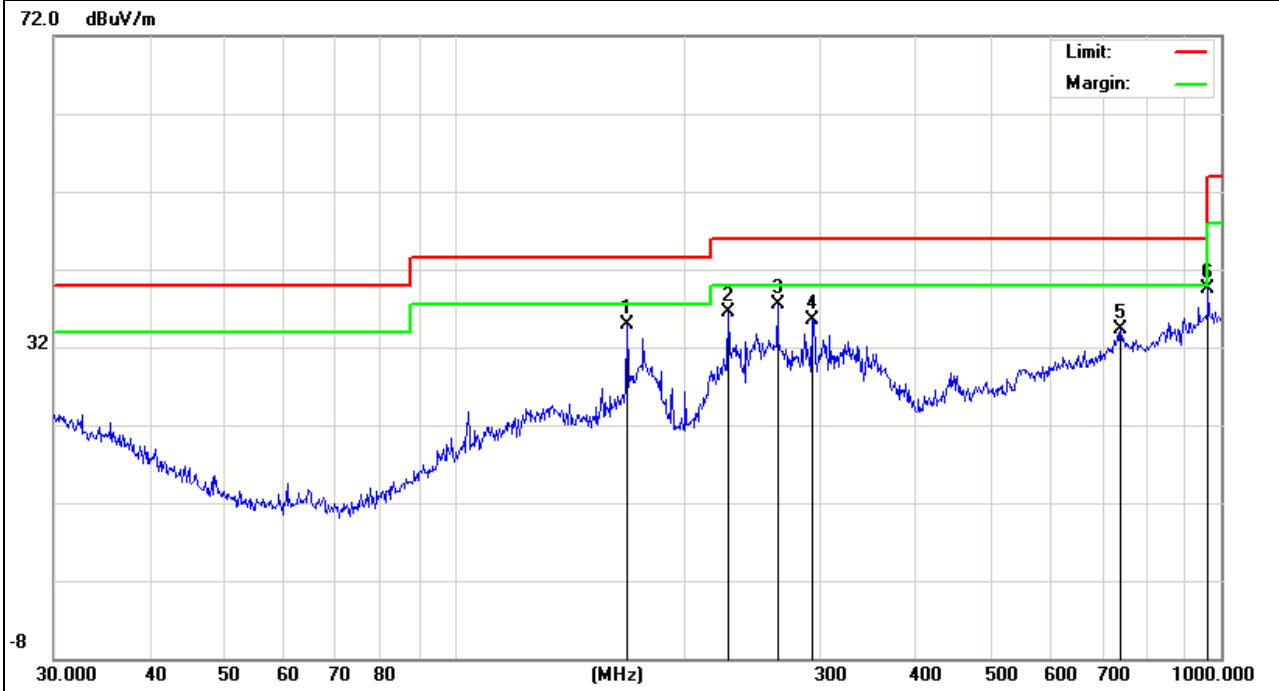

EUT :	Wireless Subwoofer For 38" Sound Bar 2.1 System	Model Name :	S3821w-C0 Subwoofer
Temperature :	20 °C	Relative Humidity :	48%
Pressure :	1010 hPa	Test Voltage :	AC 120V/60Hz
Test Mode :	Mode 2	Polarization :	Vertical

Frequency (MHz)	Meter Reading (dBμV)	Factor (dB)	Emission Level (dBμV/m)	Limits (dBμV/m)	Margin (dB)	Detector Type
30.4237	7.52	18.14	25.66	40.00	-14.34	QP
84.7018	12.77	8.65	21.42	40.00	-18.58	QP
135.0319	17.02	12.25	29.27	43.50	-14.23	QP
332.5187	16.39	15.92	32.31	46.00	-13.69	QP
356.6757	15.93	16.41	32.34	46.00	-13.66	QP
763.3757	9.44	26.33	35.77	46.00	-10.23	QP

Remark:

1. Factor = Antenna Factor + Cable Loss – Pre-amplifier.

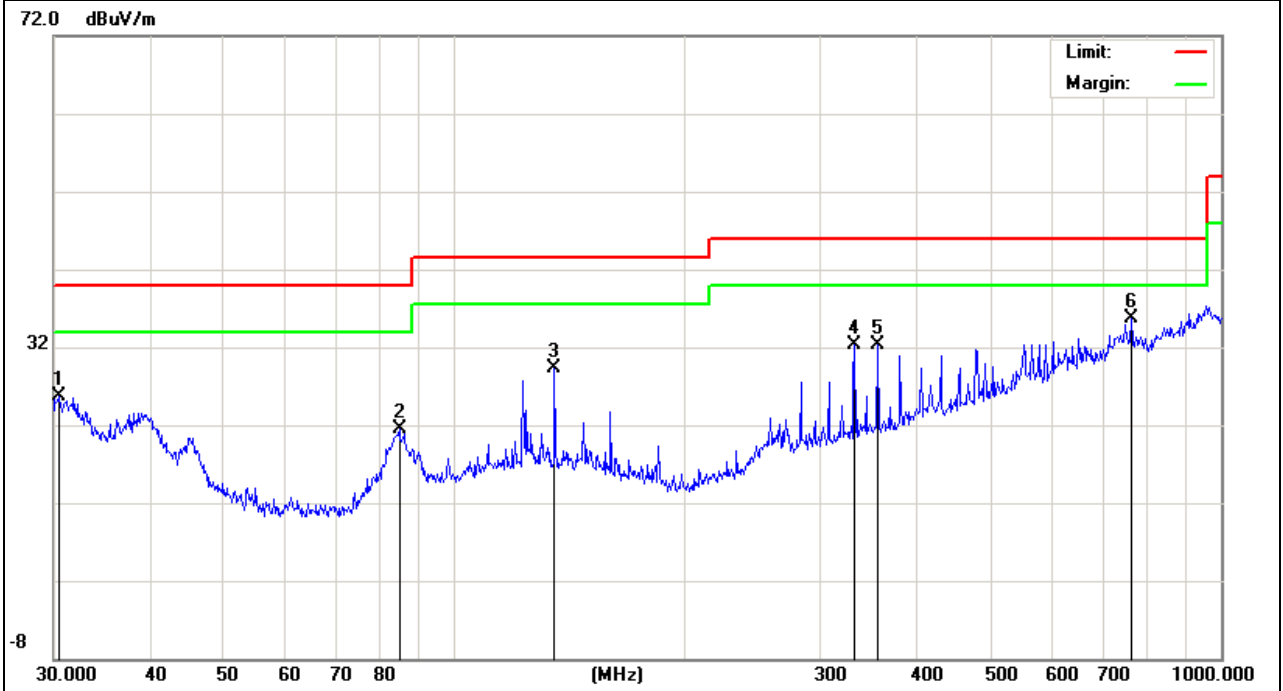

EUT :	Wireless Subwoofer For 38" Sound Bar 2.1 System	Model Name :	S3821w-C0 Subwoofer
Temperature :	20 °C	Relative Humidity :	48%
Pressure :	1010 hPa	Test Voltage :	AC 120V/60Hz
Test Mode :	Mode 2	Polarization :	Horizontal

Frequency (MHz)	Meter Reading (dBμV)	Factor (dB)	Emission Level (dBμV/m)	Limits (dBμV/m)	Margin (dB)	Detector Type
30.7454	6.79	18.00	24.79	40.00	-15.21	QP
122.8340	13.47	12.16	25.63	43.50	-17.87	QP
332.5187	24.80	15.92	40.72	46.00	-5.28	QP
356.6757	25.99	16.41	42.40	46.00	-3.60	QP
381.2485	17.68	17.22	34.90	46.00	-11.10	QP
948.7608	7.33	29.75	37.08	46.00	-8.92	QP

Remark:

- Factor = Antenna Factor + Cable Loss – Pre-amplifier.

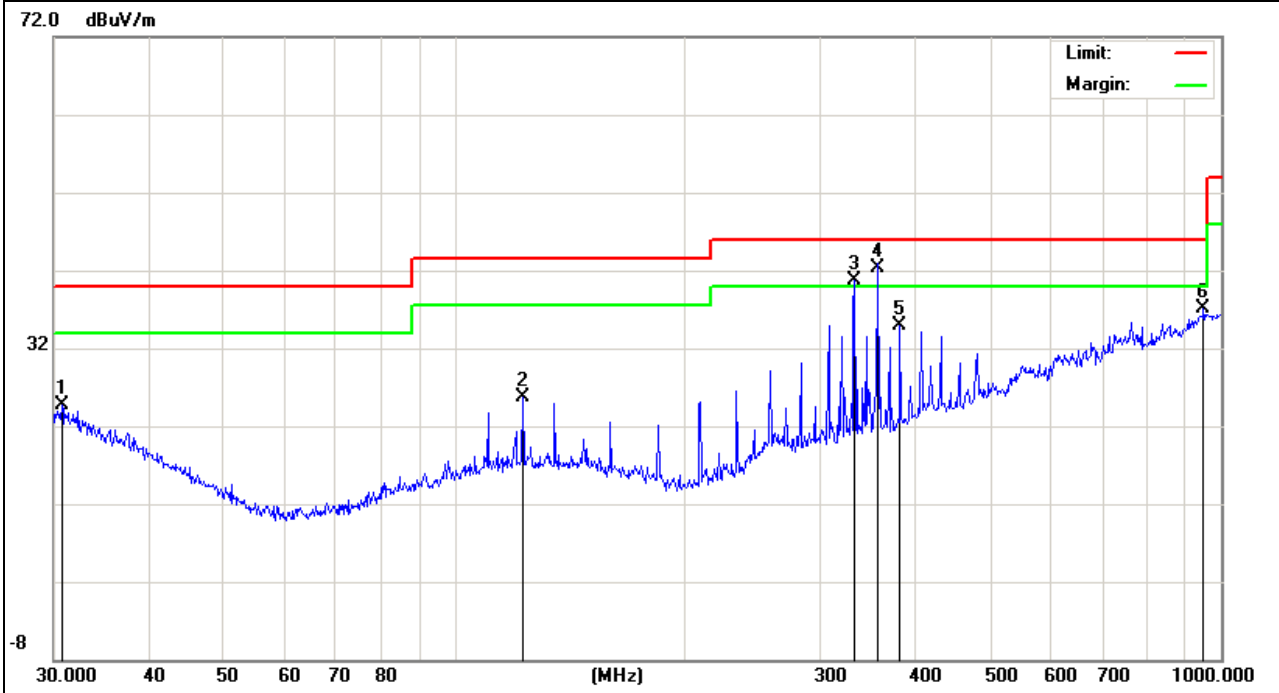

**3.4.7 TEST RESULTS (ABOVE 1000 MHZ)**

EUT :	Wireless Subwoofer For 38" Sound Bar 2.1 System	Model Name :	S3821w-C0 Subwoofer
Temperature :	20 °C	Relative Humidity :	48%
Pressure :	1010 hPa	Test Voltage :	AC 120V/60Hz
Test Mode :	TX /2405.376MHz	Polarization :	Horizontal

Frequency (MHz)	Meter Reading (dBμV)	Factor (dB)	Emission Level (dBμV/m)	Limits (dBμV/m)	Margin (dB)	Detector Type
2405.500	117.44	-12.99	104.45	114.0 0	-9.55	peak
2405.500	97.42	-12.99	84.43	94	-9.57	AVG
4810.500	54.33	-3.63	50.7	74	-23.3	peak
7216.135	55.17	-0.97	54.2	74	-19.8	peak
7216.135	40.73	-0.97	39.76	54	-14.24	AVG

Remark:  
 Factor = Antenna Factor + Cable Loss – Pre-amplifier.  
 No emission detected above 18GHz.

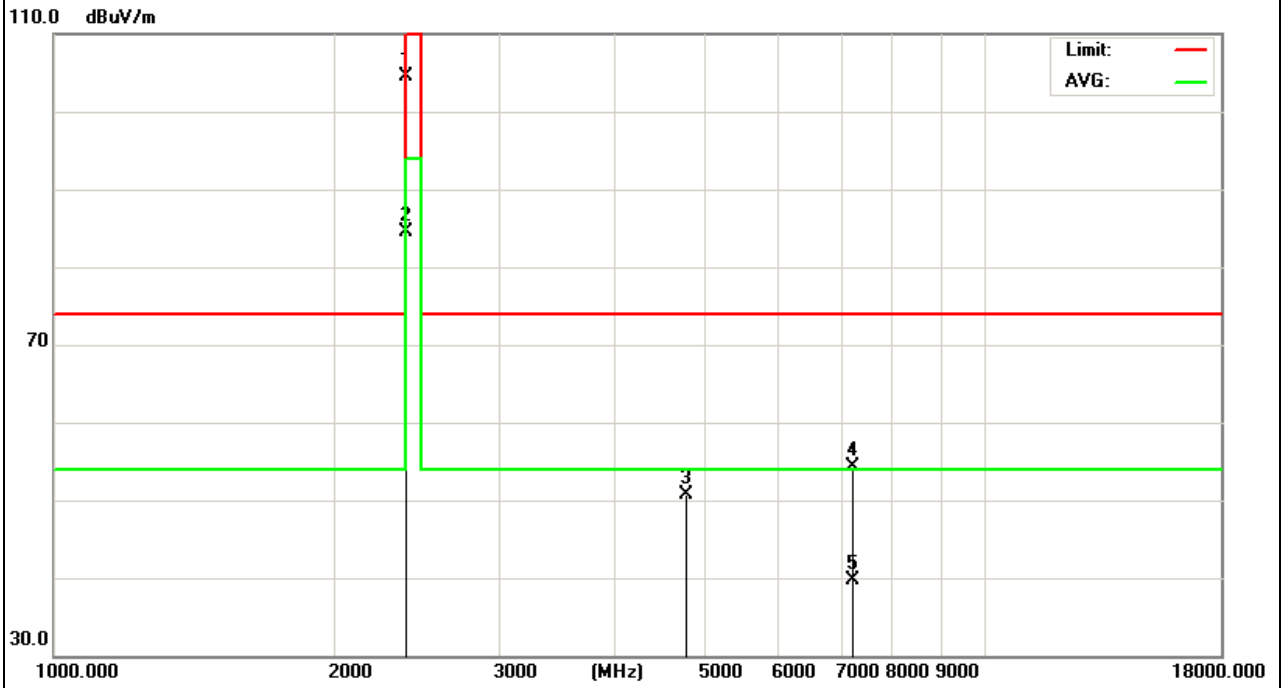

EUT :	Wireless Subwoofer For 38" Sound Bar 2.1 System	Model Name :	S3821w-C0 Subwoofer
Temperature :	20 °C	Relative Humidity :	48%
Pressure :	1010 hPa	Test Voltage :	AC 120V/60Hz
Test Mode :	TX /2405.376MHz	Polarization :	Vertical

Frequency (MHz)	Meter Reading (dBµV)	Factor (dB)	Emission Level (dBµV/m)	Limits (dBµV/m)	Margin (dB)	Detector Type
2405.500	117.51	-12.99	104.52	114.0 0	-9.48	peak
2405.500	97.75	-12.99	84.76	94	-9.24	AVG
4810.500	55.23	-3.63	51.6	74	-22.4	peak
7216.135	56.07	-0.97	55.1	74	-18.9	peak
7216.135	40.39	-0.97	39.42	54	-14.58	AVG

Remark:  
 Factor = Antenna Factor + Cable Loss – Pre-amplifier.  
 No emission detected above 18GHz.

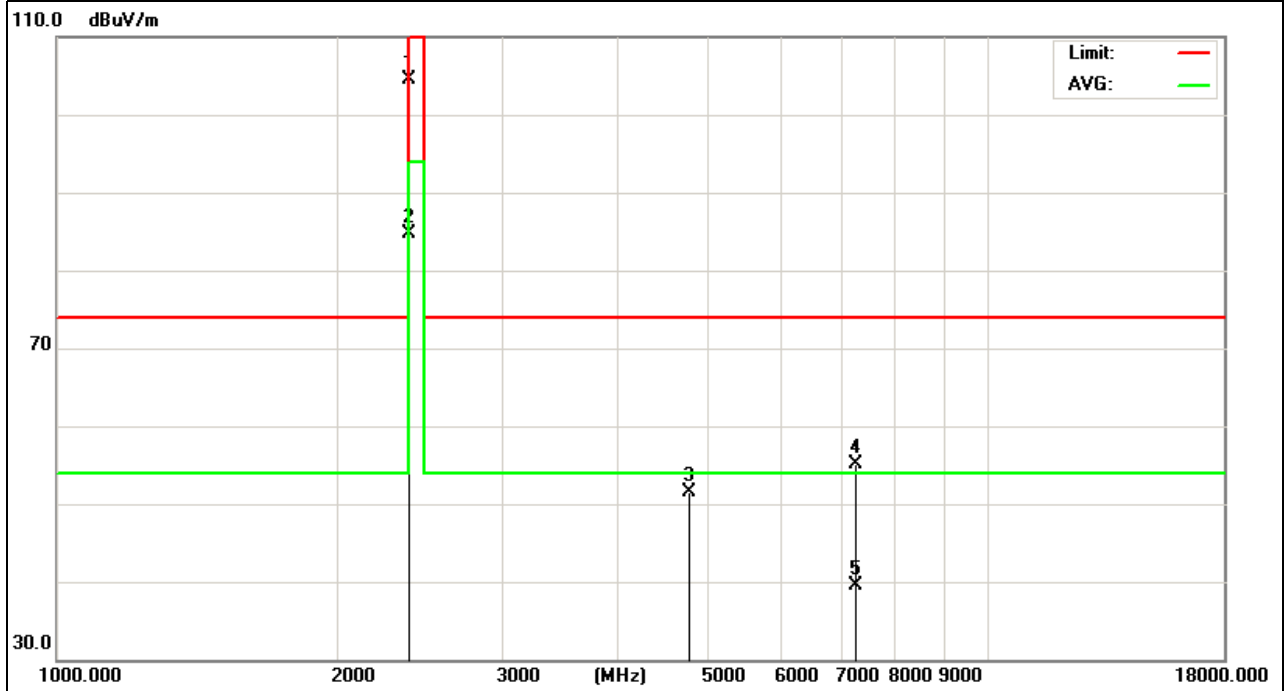

EUT :	Wireless Subwoofer For 38" Sound Bar 2.1 System	Model Name :	S3821w-C0 Subwoofer
Temperature :	20 °C	Relative Humidity :	48%
Pressure :	1010 hPa	Test Voltage :	AC 120V/60Hz
Test Mode :	TX /2436.096MHz	Polarization :	Horizontal

Frequency (MHz)	Meter Reading (dBμV)	Factor (dB)	Emission Level (dBμV/m)	Limits (dBμV/m)	Margin (dB)	Detector Type
2436.096	117.46	-12.93	104.53	114.0 0	-9.47	peak
2436.096	98.27	-12.93	85.34	94	-8.66	AVG
4872.173	54.32	-3.72	50.6	74	-23.4	peak
7308.265	55.32	-0.82	54.5	74	-19.5	peak
7308.265	41.35	-0.82	40.53	54	-13.47	AVG

Remark:  
 Factor = Antenna Factor + Cable Loss – Pre-amplifier.  
 No emission detected above 18GHz.

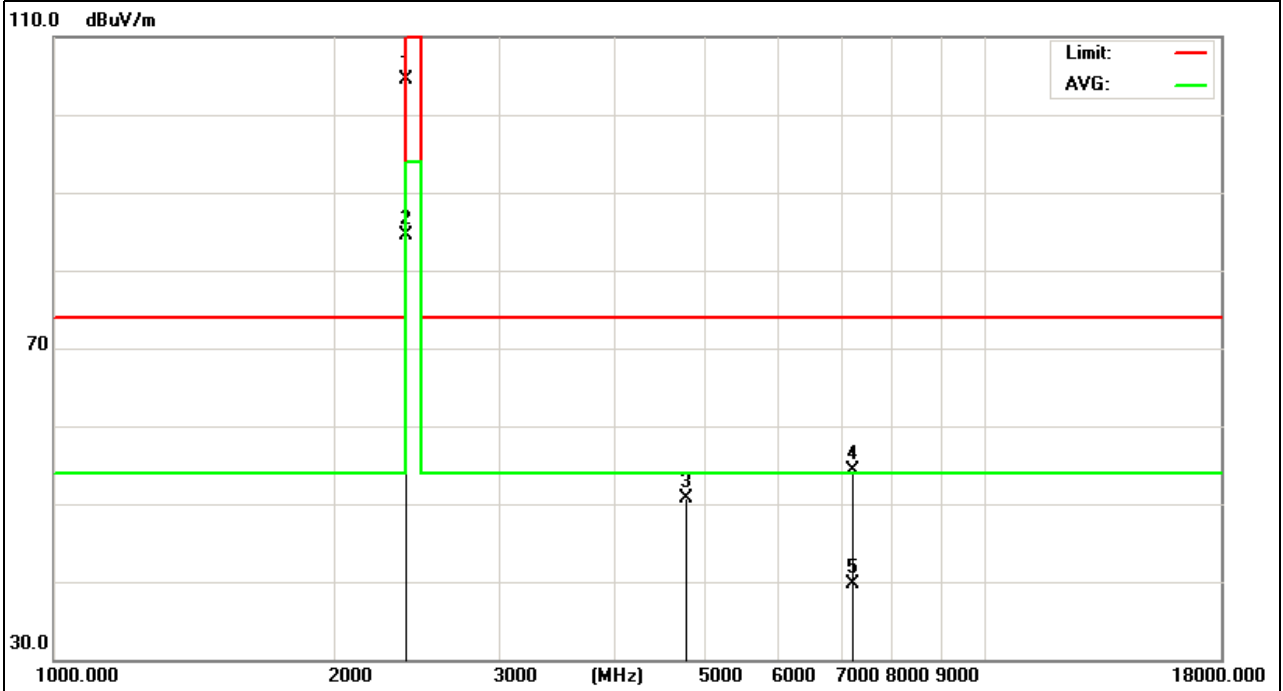

EUT :	Wireless Subwoofer For 38" Sound Bar 2.1 System	Model Name :	S3821w-C0 Subwoofer
Temperature :	20 °C	Relative Humidity :	48%
Pressure :	1010 hPa	Test Voltage :	AC 120V/60Hz
Test Mode :	TX /2436.096MHz	Polarization :	Vertical

Frequency (MHz)	Meter Reading (dBμV)	Factor (dB)	Emission Level (dBμV/m)	Limits (dBμV/m)	Margin (dB)	Detector Type
2436.096	117.48	-12.77	104.71	114	-9.29	peak
2436.096	98.71	-12.77	85.94	94	-8.06	AVG
4872.173	55.23	-3.53	51.7	74	-22.3	peak
7308.265	53.75	-0.85	52.9	74	-21.1	peak

Remark:  
 Factor = Antenna Factor + Cable Loss – Pre-amplifier.  
 No emission detected above 18GHz.

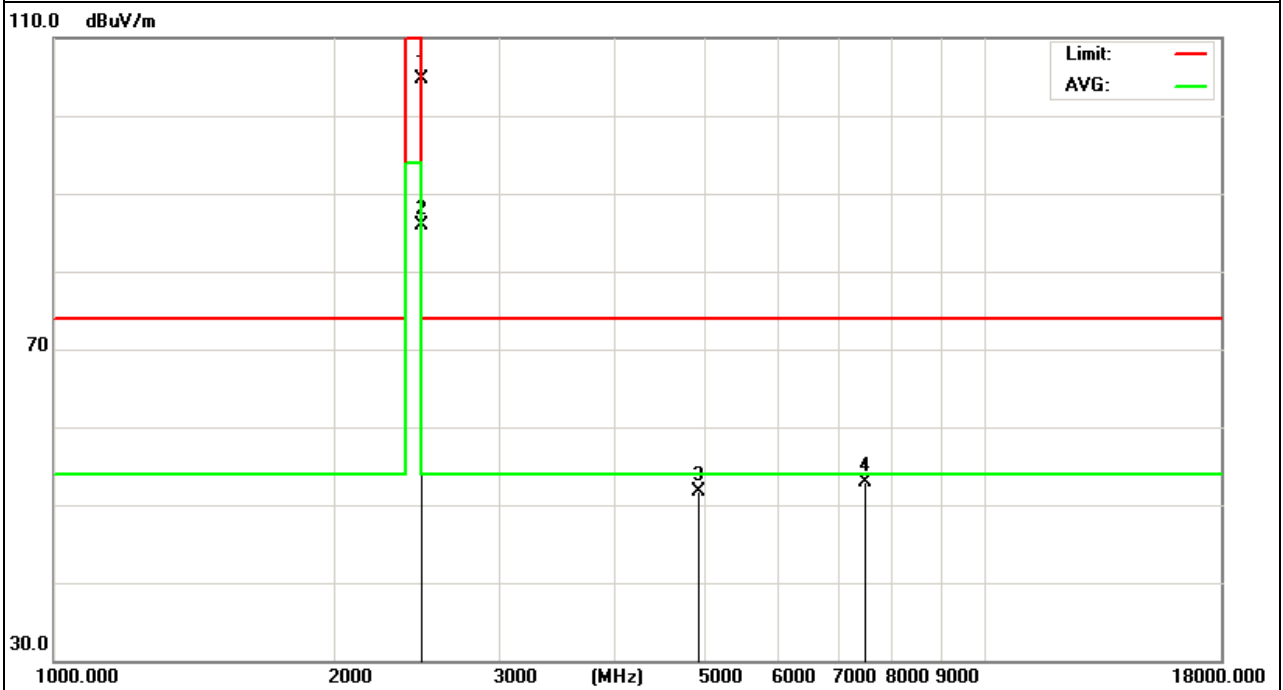

EUT :	Wireless Subwoofer For 38" Sound Bar 2.1 System	Model Name :	S3821w-C0 Subwoofer
Temperature :	20 °C	Relative Humidity :	48%
Pressure :	1010 hPa	Test Voltage :	AC 120V/60Hz
Test Mode :	TX /2475.008MHz	Polarization :	Horizontal

Frequency (MHz)	Meter Reading (dBµV)	Factor (dB)	Emission Level (dBµV/m)	Limits (dBµV/m)	Margin (dB)	Detector Type
2475.008	117.57	-12.77	104.8	114	-9.2	peak
2475.008	98.57	-12.77	85.8	94	-8.2	AVG
4950.125	54.03	-3.53	50.5	74	-23.5	peak
7425.350	54.25	-0.85	53.4	74	-20.6	peak

Remark:  
 Factor = Antenna Factor + Cable Loss – Pre-amplifier.  
 No emission detected above 18GHz.

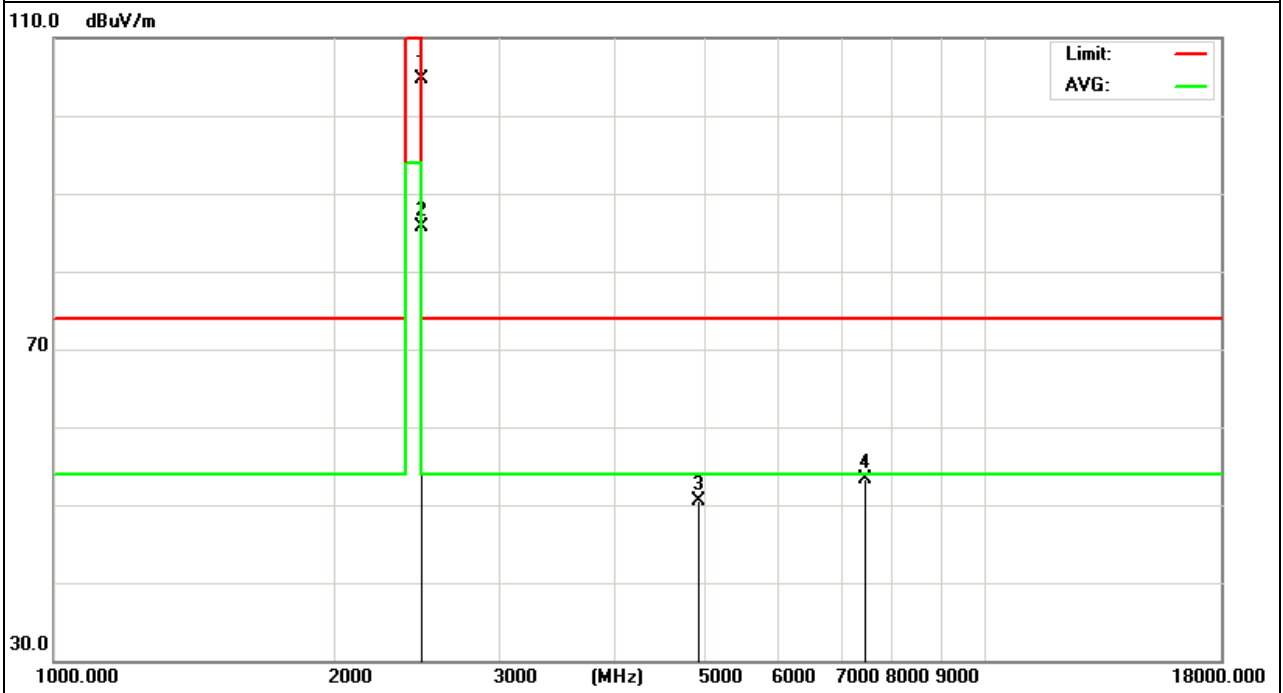



EUT :	Wireless Subwoofer For 38" Sound Bar 2.1 System	Model Name :	S3821w-C0 Subwoofer
Temperature :	20 °C	Relative Humidity :	48%
Pressure :	1010 hPa	Test Voltage :	AC 120V/60Hz
Test Mode :	TX /2475.008MHz	Polarization :	Vertical

Frequency (MHz)	Meter Reading (dBμV)	Factor (dB)	Emission Level (dBμV/m)	Limits (dBμV/m)	Margin (dB)	Detector Type
2475.008	117.48	-12.77	104.71	114	-9.29	peak
2475.008	98.71	-12.77	85.94	94	-8.06	AVG
4950.125	55.23	-3.53	51.7	74	-22.3	peak
7425.350	53.75	-0.85	52.9	74	-21.1	peak

Remark:  
 Factor = Antenna Factor + Cable Loss – Pre-amplifier.  
 No emission detected above 18GHz.

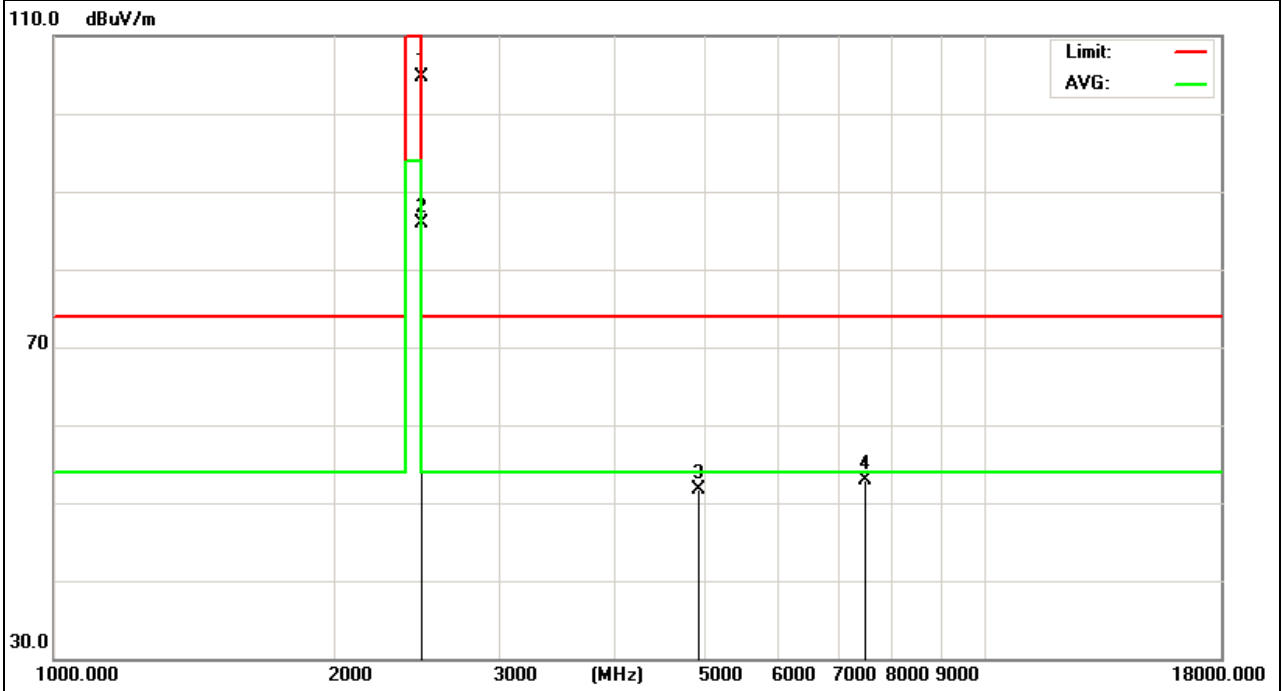

**3.4.8 TEST RESULTS (RESTRICTED BANDS REQUIREMENTS)**

EUT :	Wireless Subwoofer For 38" Sound Bar 2.1 System	Model Name :	S3821w-C0 Subwoofer
Temperature :	20 °C	Relative Humidity :	48%
Pressure :	1010 hPa	Test Voltage :	AC 120V/60Hz
Test Mode :	TX /2475.008MHz	Polarization :	Vertical

Frequency (MHz)	Meter Reading (dBµV)	Factor (dB)	Emission Level (dBµV/m)	Limits (dBµV/m)	Margin (dB)	Detector Type
2483.500	54.75	-12.78	41.97	74.00	-32.03	peak

Remark:  
Factor = Antenna Factor + Cable Loss – Pre-amplifier.

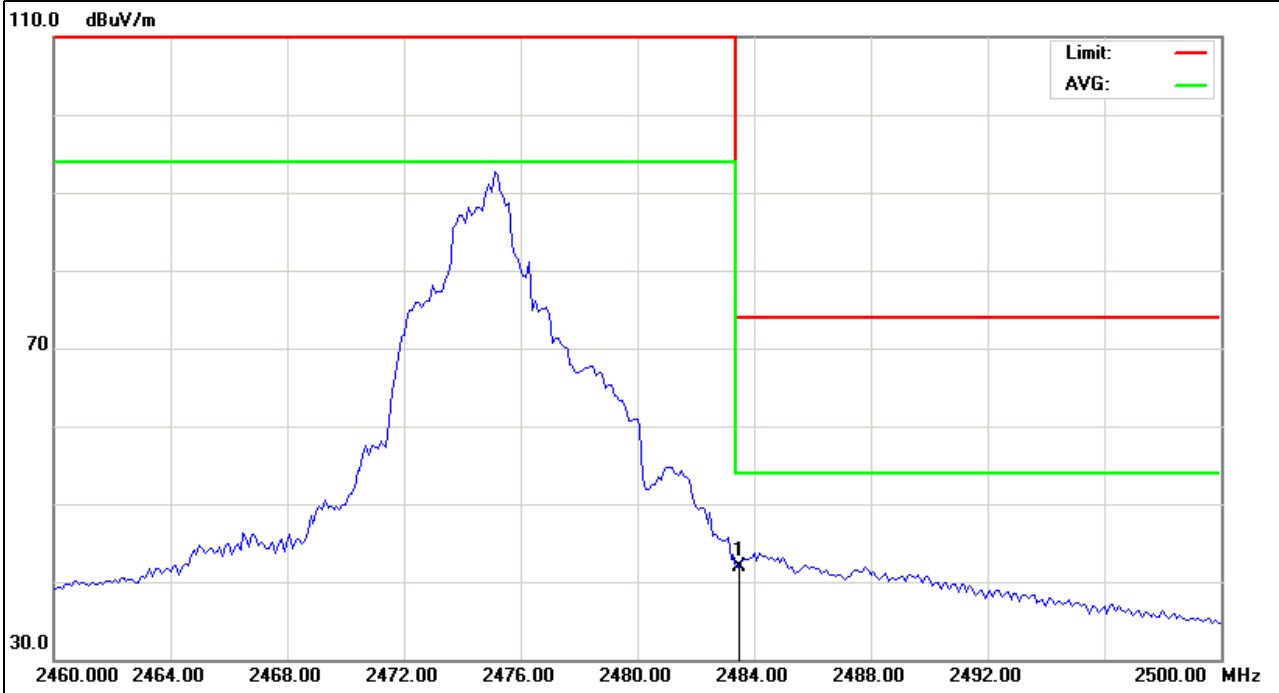

EUT :	Wireless Subwoofer For 38" Sound Bar 2.1 System	Model Name :	S3821w-C0 Subwoofer
Temperature :	20 °C	Relative Humidity :	48%
Pressure :	1010 hPa	Test Voltage :	AC 120V/60Hz
Test Mode :	TX /2475.008MHz	Polarization :	Horizontal

Frequency (MHz)	Meter Reading (dBμV)	Factor (dB)	Emission Level (dBμV/m)	Limits (dBμV/m)	Margin (dB)	Detector Type
2483.500	54.93	-12.78	42.15	74.00	-31.85	peak

Remark:  
 Factor = Antenna Factor + Cable Loss – Pre-amplifier.

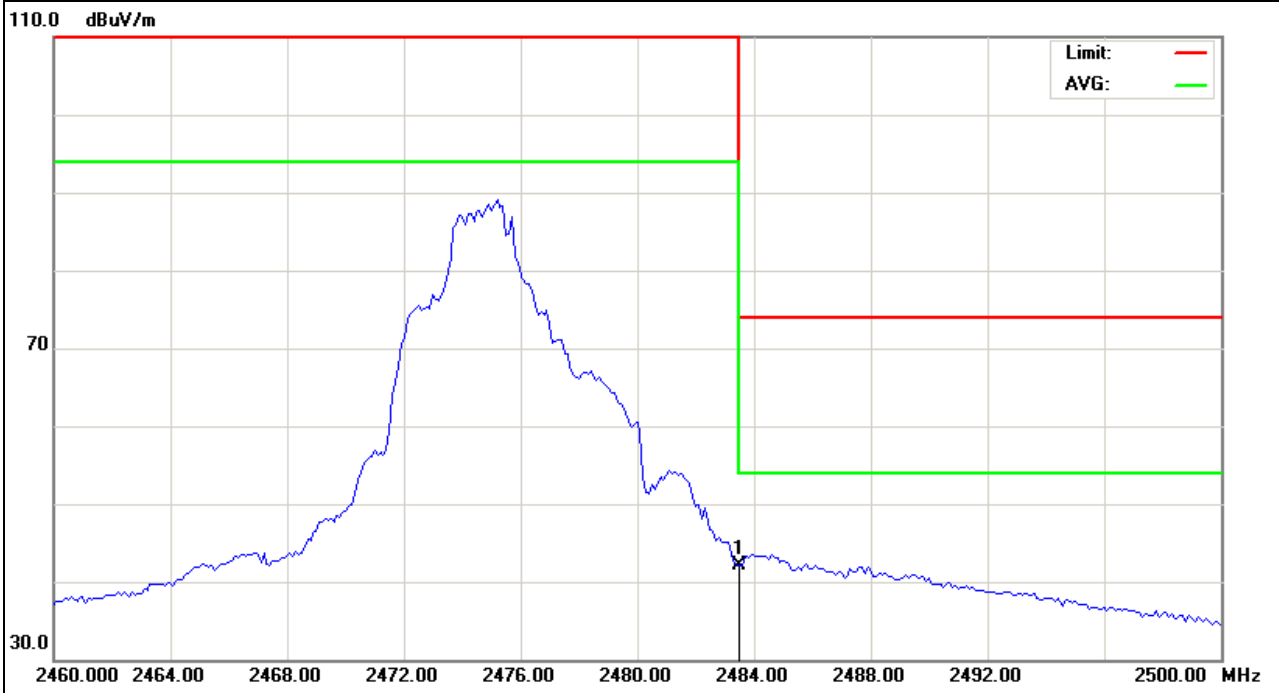

EUT :	Wireless Subwoofer For 38" Sound Bar 2.1 System	Model Name :	S3821w-C0 Subwoofer
Temperature :	20 °C	Relative Humidity :	48%
Pressure :	1010 hPa	Test Voltage :	AC 120V/60Hz
Test Mode :	TX /2405.376MHz	Polarization :	Vertical

Frequency (MHz)	Meter Reading (dBμV)	Factor (dB)	Emission Level (dBμV/m)	Limits (dBμV/m)	Margin (dB)	Detector Type
2400.000	63.22	-12.99	50.23	74.00	-23.77	peak

Remark:  
 Factor = Antenna Factor + Cable Loss – Pre-amplifier.

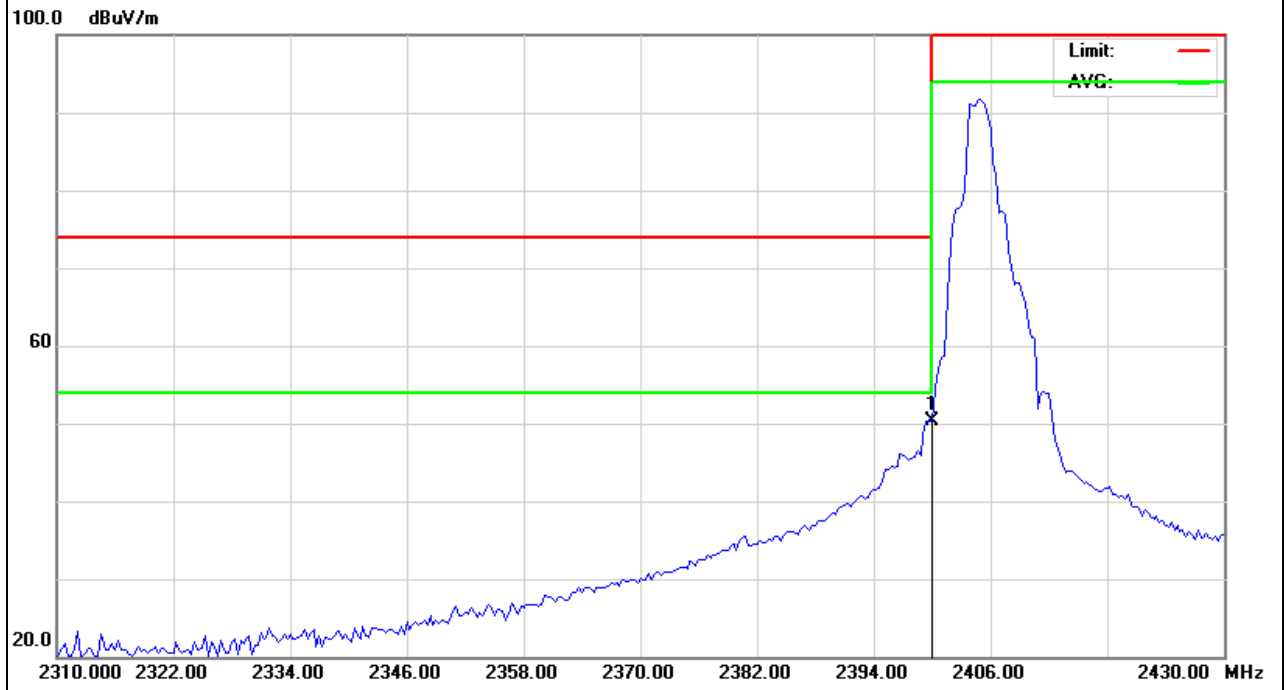

EUT :	Wireless Subwoofer For 38" Sound Bar 2.1 System	Model Name :	S3821w-C0 Subwoofer
Temperature :	20 °C	Relative Humidity :	48%
Pressure :	1010 hPa	Test Voltage :	AC 120V/60Hz
Test Mode :	TX /2405.376MHz	Polarization :	Horizontal

Frequency (MHz)	Meter Reading (dBμV)	Factor (dB)	Emission Level (dBμV/m)	Limits (dBμV/m)	Margin (dB)	Detector Type
2400.000	65.46	-12.99	52.47	74.00	-21.53	peak

Remark:  
 Factor = Antenna Factor + Cable Loss – Pre-amplifier.

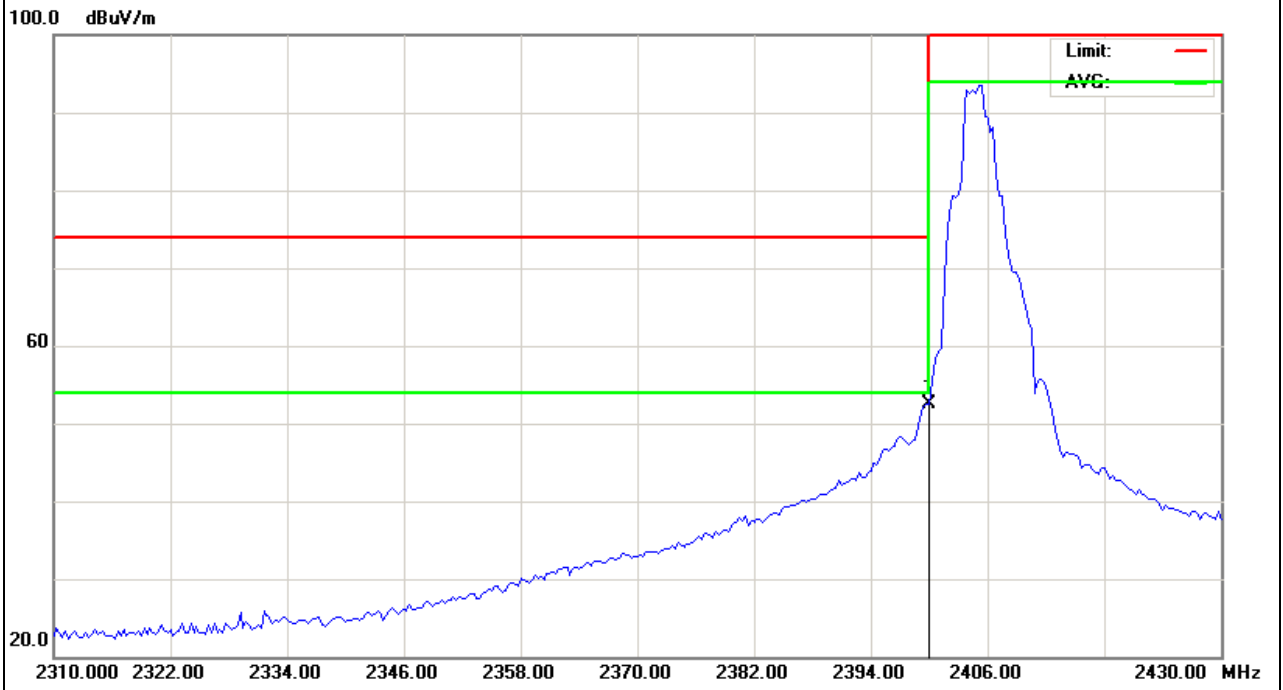

#### 4. BANDWIDTH TEST

##### 4.1 TEST PROCEDURE

- a. The EUT was directly connected to the spectrum analyzer and antenna output port as show in the block diagram below,
- b. Spectrum Setting : RBW= 100KHz, VBW $\geq$ RBW, Sweep time = Auto.

##### 4.2 DEVIATION FROM STANDARD

No deviation.

##### 4.3 TEST SETUP



#### 4.4 TEST RESULTS

EUT :	Wireless Subwoofer For 38" Sound Bar 2.1 System	Model Name :	S3821w-C0 Subwoofer
Temperature :	26 °C	Relative Humidity :	53%
Pressure :	1020 hPa	Test Power :	AC 120V/60Hz
Test Mode :	TX		

Test Channel	Frequency (MHz)	20 dBc Bandwidth (MHz)	99% Bandwidth (MHz)
CH1	2405.376	6.973	6.974
CH4	2436.096	6.894	6.964
CH8	2475.008	6.582	6.840

### The Lowest Channel: 2405.376MHz

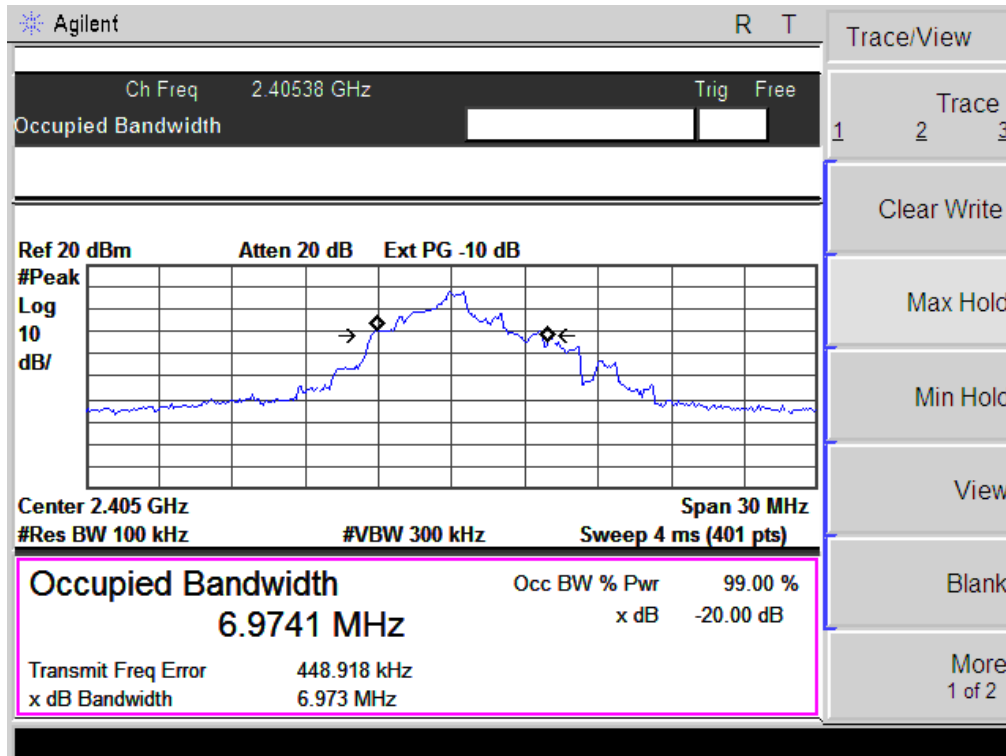

### The Middle Channel: 2436.096MHz

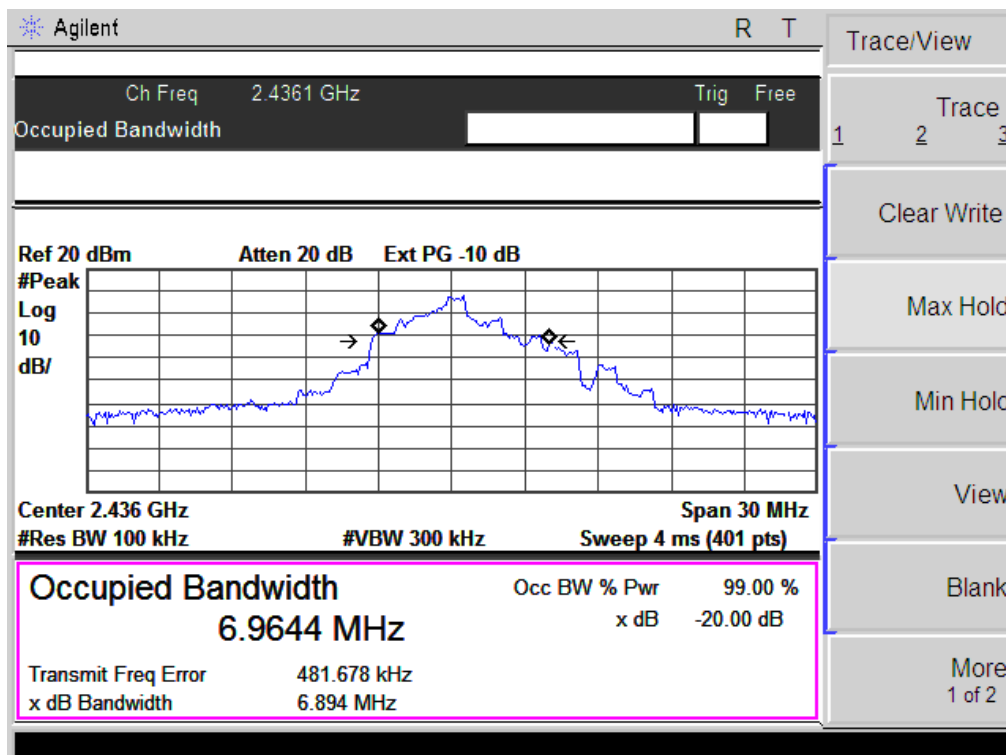



### The High Channel:2475.008MHz

Agilent
R T

---

Ch Freq 2.47501 GHz
Trig Free

---

Occupied Bandwidth

---

Ref 20 dBm
Atten 20 dB
Ext PG -10 dB

Center 2.475 GHz
Span 30 MHz

#Res BW 100 kHz
#VBW 300 kHz
Sweep 4 ms (401 pts)

---

**Occupied Bandwidth**

**6.8395 MHz**

Transmit Freq Error 636.896 kHz

x dB Bandwidth 6.582 MHz

Occ BW % Pwr 99.00 %

x dB -20.00 dB

Trace/View

---

Trace

1 2 3

---

Clear Write

---

Max Hold

---

Min Hold

---

View

---

Blank

---

More

1 of 2

**5. EUT TEST PHOTO**

**Radiated Measurement Photos**

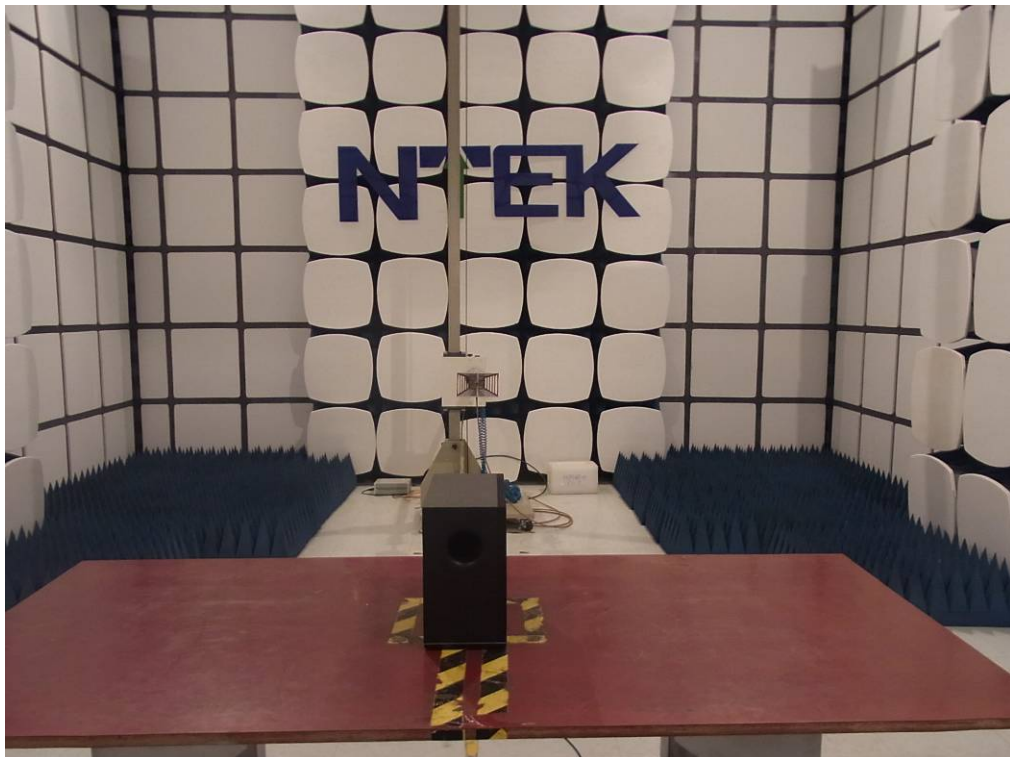
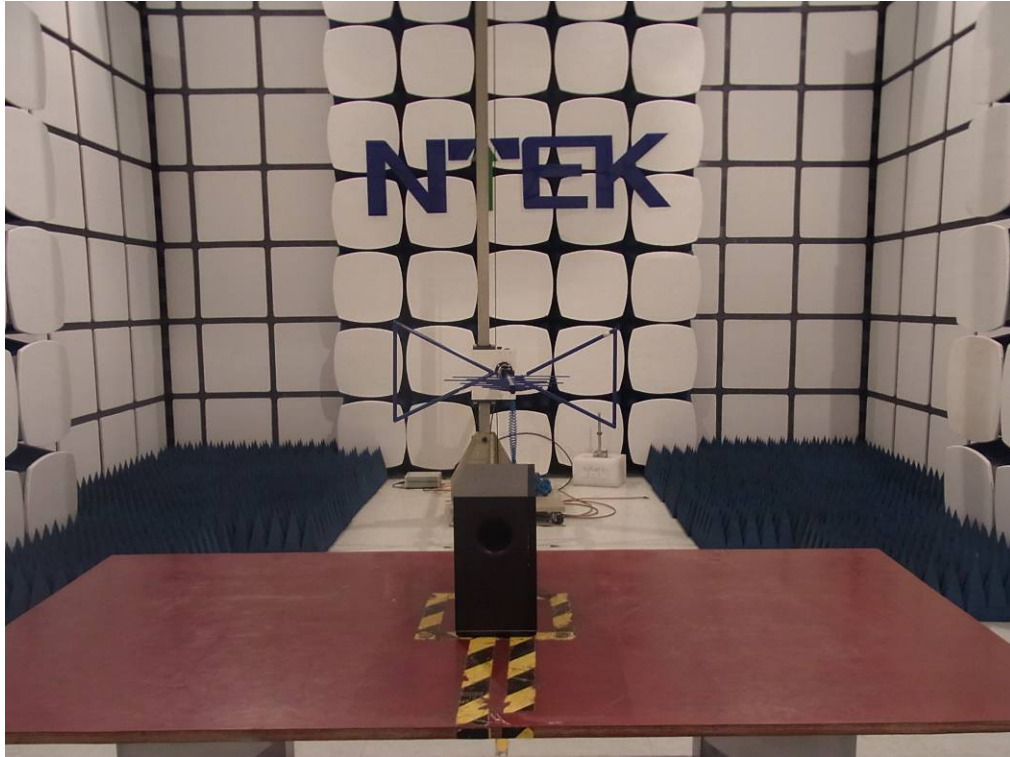

**Conducted Measurement Photos**

