

APPLICATION CERTIFICATION FCC Part 15C
On Behalf of
Zylux Acoustic Corporation

MC200Air
Model No.: MC200Air

FCC ID: XN6-MC200AIR

Prepared for : Zylux Acoustic Corporation
Address : 3F, 22, Lane 35, Jihu Road, Neihu Technology Park,
Taipei 11492, Taiwan

Prepared by : ACCURATE TECHNOLOGY CO., LTD
Address : F1, Bldg. A, Changyuan New Material Port, Keyuan Rd.
Science & Industry Park, Nanshan, Shenzhen, Guangdong
P.R. China

Tel: (0755) 26503290
Fax: (0755) 26503396

Report Number : ATE20120668
Date of Test : June 20-30 & July 28, 2012
Date of Report : July 30, 2012

TABLE OF CONTENTS

Description	Page
Test Report Certification	
1. GENERAL INFORMATION	5
1.1. Description of Device (EUT).....	5
1.2. Test Procedure	6
1.3. Description of Test Facility	6
1.4. Measurement Uncertainty.....	6
2. MEASURING DEVICE AND TEST EQUIPMENT	7
3. OPERATION OF EUT DURING TESTING	8
3.1. Operating Mode.....	8
3.2. Configuration and peripherals	8
4. TEST PROCEDURES AND RESULTS	9
5. 6DB BANDWIDTH MEASUREMENT.....	10
5.1. Block Diagram of Test Setup.....	10
5.2. The Requirement For Section 15.247(a)(2).....	10
5.3. EUT Configuration on Measurement	10
5.4. Operating Condition of EUT	10
5.5. Test Procedure	11
5.6. Test Result	11
6. MAXIMUM PEAK OUTPUT POWER	18
6.1. Block Diagram of Test Setup.....	18
6.2. The Requirement For Section 15.247(b)(3).....	18
6.3. EUT Configuration on Measurement	18
6.4. Operating Condition of EUT	18
6.5. Test Procedure	19
6.6. Test Result	19
7. POWER SPECTRAL DENSITY MEASUREMENT.....	26
7.1. Block Diagram of Test Setup.....	26
7.2. The Requirement For Section 15.247(e).....	26
7.3. EUT Configuration on Measurement	26
7.4. Operating Condition of EUT	26
7.5. Test Procedure	27
7.6. Test Result	28
8. BAND EDGE COMPLIANCE TEST	35
8.1. Block Diagram of Test Setup.....	35
8.2. The Requirement For Section 15.247(d)	35
8.3. EUT Configuration on Measurement	35
8.4. Operating Condition of EUT	36
8.5. Test Procedure	36
8.6. Test Result	37
9. RADIATED SPURIOUS EMISSION TEST	54
9.1. Block Diagram of Test Setup.....	54
9.2. The Limit For Section 15.247(d)	55
9.3. Restricted bands of operation	55
9.4. Configuration of EUT on Measurement	56
9.5. Operating Condition of EUT	56
9.6. Test Procedure	56

- 9.7. The Field Strength of Radiation Emission Measurement Results57
- 10. CONDUCTED SPURIOUS EMISSION COMPLIANCE TEST 99**
 - 10.1. Block Diagram of Test Setup.....99
 - 10.2. The Requirement For Section 15.247(d)99
 - 10.3. EUT Configuration on Measurement99
 - 10.4. Operating Condition of EUT 100
 - 10.5. Test Procedure 100
 - 10.6. Test Result 100
- 11. AC POWER LINE CONDUCTED EMISSION FOR FCC PART 15 SECTION 15.207(A) 107**
 - 11.1. Block Diagram of Test Setup..... 107
 - 11.2. The Emission Limit 107
 - 11.3. Configuration of EUT on Measurement 108
 - 11.4. Operating Condition of EUT 108
 - 11.5. Test Procedure 108
 - 11.6. Power Line Conducted Emission Measurement Results 109
- 12. ANTENNA REQUIREMENT..... 112**
 - 12.1. The Requirement 112
 - 12.2. Antenna Construction 112

Test Report Certification

Applicant : Zylux Acoustic Corporation
Manufacturer : Boston Acoustics, Inc.
EUT Description : MC200Air
(A) MODEL NO.: MC200Air
(B) SERIAL NO.: N/A
(C) POWER SUPPLY: DC 15V (Power by Adapter)

Measurement Procedure Used:

**FCC Rules and Regulations Part 15 Subpart C Section 15.247
ANSI C63.4: 2003**

The EUT was tested according to DTS test procedure of January 18, 2012 KDB558074 for compliance to FCC 47CFR 15.247 requirements.

The device described above is tested by ACCURATE TECHNOLOGY CO. LTD to determine the maximum emission levels emanating from the device. The maximum emission levels are compared to the FCC Part 15 Subpart C Section 15.247 limits. The measurement results are contained in this test report and ACCURATE TECHNOLOGY CO. LTD is assumed full responsibility for the accuracy and completeness of these measurements. Also, this report shows that the Equipment Under Test (EUT) is to be technically compliant with the FCC requirements.

This report applies to above tested sample only. This report shall not be reproduced in part without written approval of ACCURATE TECHNOLOGY CO. LTD.

Date of Test : June 20-30 & July 28, 2012

Prepared by : Apple Lv
(Engineer)

Approved & Authorized Signer : Genulo
(Manager)

1. GENERAL INFORMATION

1.1. Description of Device (EUT)

EUT : MC200Air

Model Number : MC200Air

Frequency Band : 2412-2462MHz

Number of Channels : 11

Antenna Gain : 2dBi

Power Supply : DC 15 (Power by Adapter)
Adapter : Model number: DSA-42D-12 2 150280
Input: AC 100-240V; 50/60Hz; 1.2A
Output: DC 15V/2.8A

Data Rate : IEEE 802.11b: 11/5.5/2/1Mbps
IEEE 802.11g: 54/48/36/24/18/12/9/6Mbps

Applicant : Zylux Acoustic Corporation
Address : 3F, 22, Lane 35, Jihu Road, Neihu Technology Park,
Taipei 11492, Taiwan

Manufacturer : Boston Acoustics, Inc.
Address : 7 Constitution Way Woburn, MA 01801 USA

Date of sample received : June 19, 2012

Date of Test : June 20-30 & July 28, 2012

1.2. Test Procedure

The EUT was tested according to DTS test procedure of January 18, 2012 KDB558074 for compliance to FCC 47CFR 15.247 requirements.

1.3. Description of Test Facility

EMC Lab : Accredited by TUV Rheinland Shenzhen

Listed by FCC
The Registration Number is 752051

Listed by Industry Canada
The Registration Number is 5077A-2

Accredited by China National Accreditation Committee
for Laboratories
The Certificate Registration Number is L3193

Name of Firm : ACCURATE TECHNOLOGY CO. LTD

Site Location : F1, Bldg. A, Changyuan New Material Port, Keyuan Rd.
Science & Industry Park, Nanshan, Shenzhen, Guangdong
P.R. China

1.4. Measurement Uncertainty

Conducted Emission Expanded Uncertainty = 2.23dB, k=2

Radiated emission expanded uncertainty = 3.08dB, k=2
(9kHz-30MHz)

Radiated emission expanded uncertainty = 4.42dB, k=2
(30MHz-1000MHz)

Radiated emission expanded uncertainty = 4.06dB, k=2
(Above 1GHz)

2. MEASURING DEVICE AND TEST EQUIPMENT

Table 1: List of Test and Measurement Equipment

Kind of equipment	Manufacturer	Type	S/N	Calibrated dates	Calibrated until
EMI Test Receiver	Rohde&Schwarz	ESCS30	100307	Jan. 8, 2012	Jan. 7, 2013
EMI Test Receiver	Rohde&Schwarz	ESPI3	101526/003	Jan. 8, 2012	Jan. 7, 2013
Spectrum Analyzer	Agilent	E7405A	MY45115511	Jan. 8, 2012	Jan. 7, 2013
Pre-Amplifier	Rohde&Schwarz	CBLU118354 0-01	3791	Jan. 8, 2012	Jan. 7, 2013
Loop Antenna	Schwarzbeck	FMZB1516	1516131	Jan. 8, 2012	Jan. 7, 2013
Bilog Antenna	Schwarzbeck	VULB9163	9163-323	Jan. 8, 2012	Jan. 7, 2013
Horn Antenna	Schwarzbeck	BBHA9120D	9120D-655	Jan. 8, 2012	Jan. 7, 2013
Horn Antenna	Schwarzbeck	BBHA9170	9170-359	Jan. 8, 2012	Jan. 7, 2013
LISN	Rohde&Schwarz	ESH3-Z5	100305	Jan. 8, 2012	Jan. 7, 2013
LISN	Schwarzbeck	NSLK8126	8126431	Jan. 8, 2012	Jan. 7, 2013

3. OPERATION OF EUT DURING TESTING

3.1. Operating Mode

The mode is used: **802.11b Transmitting mode**

Low Channel: 2412MHz

Middle Channel: 2437MHz

High Channel: 2462MHz

802.11g Transmitting mode

Low Channel: 2412MHz

Middle Channel: 2437MHz

High Channel: 2462MHz

3.2. Configuration and peripherals

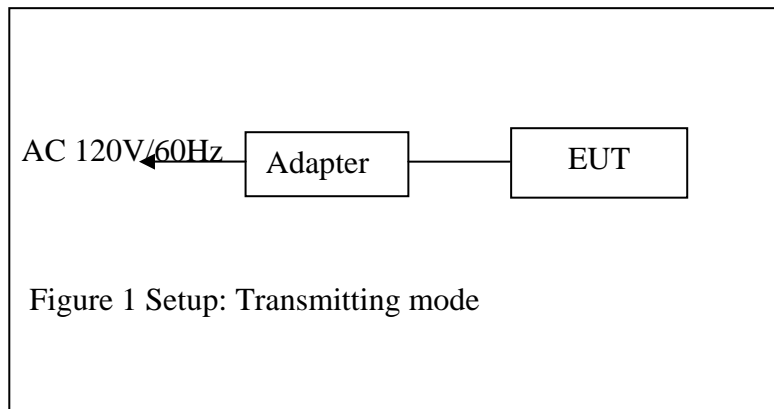

4. TEST PROCEDURES AND RESULTS

FCC Rules	Description of Test	Result
Section 15.247(a)(2)	6dB Bandwidth Test	Compliant
Section 15.247(e)	Power Spectral Density Test	Compliant
Section 15.247(b)(3)	Maximum Peak Output Power Test	Compliant
Section 15.247(d)	Band Edge Compliance Test	Compliant
Section 15.247(d) Section 15.209	Radiated Spurious Emission Test	Compliant
Section 15.247(d)	Antenna Conducted Spurious Emission Test	Compliant
Section 15.207	AC Power Line Conducted Emission Test	Compliant
Section 15.203	Antenna Requirement	Compliant

5. 6DB BANDWIDTH MEASUREMENT

5.1. Block Diagram of Test Setup

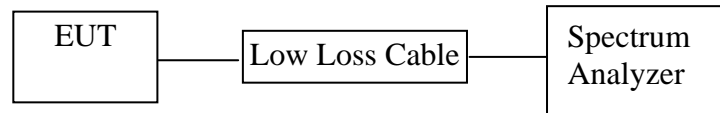

(EUT: MC200Air)

5.2. The Requirement For Section 15.247(a)(2)

Section 15.247(a)(2): Systems using digital modulation techniques may operate in the 902-928MHz, 2400-2483.5MHz, and 5725-5850MHz bands. The minimum 6 dB bandwidth shall be at least 500 kHz.

5.3. EUT Configuration on Measurement

The following equipment are installed on the emission measurement to meet the commission requirements and operating regulations in a manner which tends to maximize its emission characteristics in normal application.

5.3.1. MC200Air (EUT)

Model Number : MC200Air
 Serial Number : N/A
 Manufacturer : Boston Acoustics, Inc.

5.4. Operating Condition of EUT

5.4.1. Setup the EUT and simulator as shown as Section 5.1.

5.4.2. Turn on the power of all equipment.

5.4.3. Let the EUT work in TX modes measure it. The transmit frequency are 2412-2462MHz. We select 2412MHz, 2437MHz, 2462MHz TX frequency to transmit.

5.5. Test Procedure

5.5.1. The transmitter output was connected to the spectrum analyzer through a low loss cable.

5.5.2. Set RBW of spectrum analyzer to 300kHz and VBW to 1MHz.

5.5.3. The 6dB bandwidth is defined as the total spectrum the power of which is higher than peak power minus 6dB.

5.6. Test Result

PASS.

Date of Test:	<u>June 26, 2012</u>	Temperature:	<u>25°C</u>
EUT:	<u>MC200Air</u>	Humidity:	<u>50%</u>
Model No.:	<u>MC200Air</u>	Power Supply:	<u>AC 120V/60HZ</u>
Test Mode:	<u>TX</u>	Test Engineer:	<u>Apple</u>

The test was performed with 802.11b

Channel	Frequency (MHz)	6dB Bandwidth (MHz)	Limit (MHz)
Low	2412	12.48	> 0.5MHz
Middle	2437	12.52	> 0.5MHz
High	2462	12.56	> 0.5MHz

The test was performed with 802.11g

Channel	Frequency (MHz)	6dB Bandwidth (MHz)	Limit (MHz)
Low	2412	16.72	> 0.5MHz
Middle	2437	16.68	> 0.5MHz
High	2462	16.72	> 0.5MHz

The spectrum analyzer plots are attached as below.

802.11b Channel Low 2412MHz

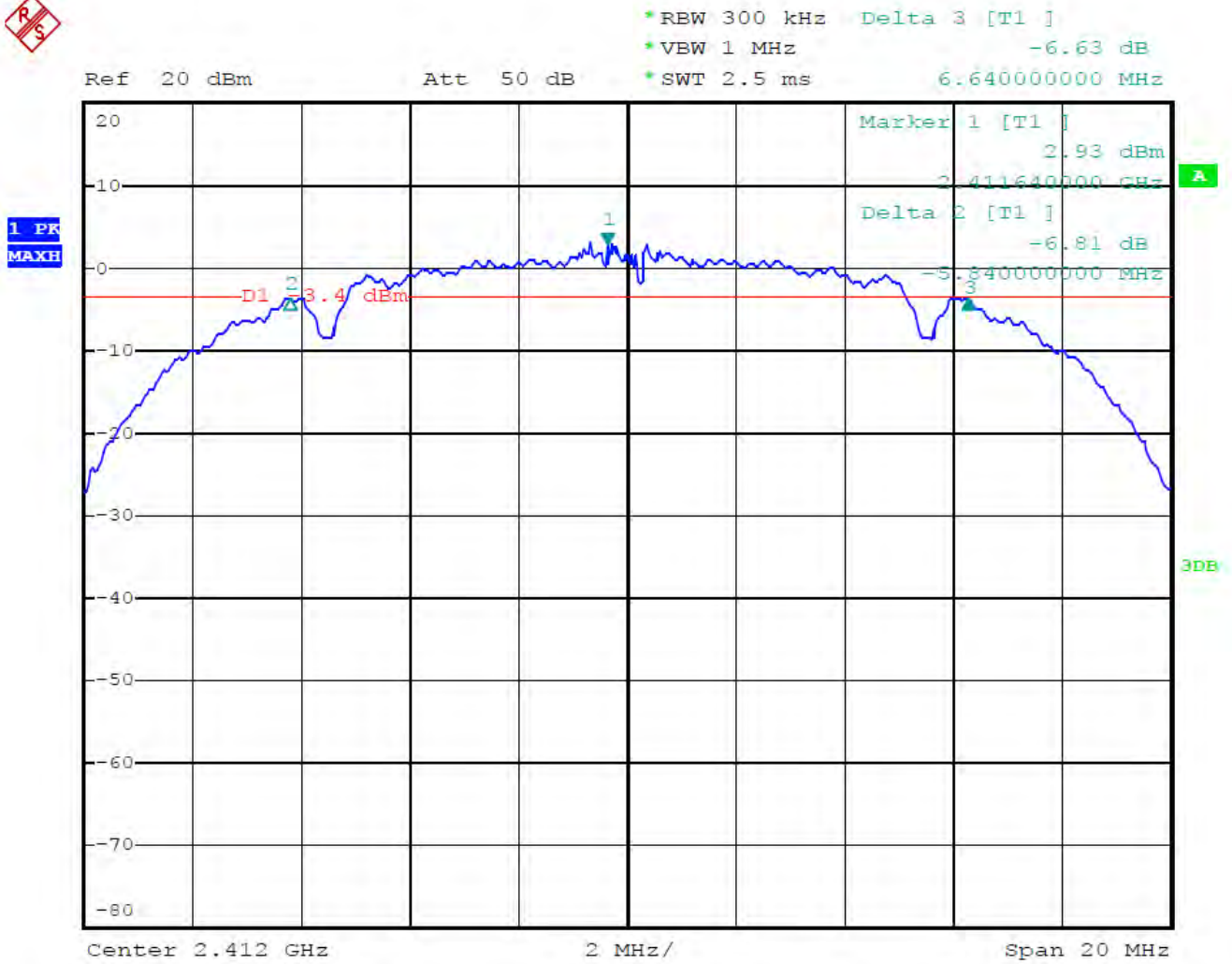

Date: 26.JUN.2012 17:17:20

802.11b Channel Middle 2437MHz

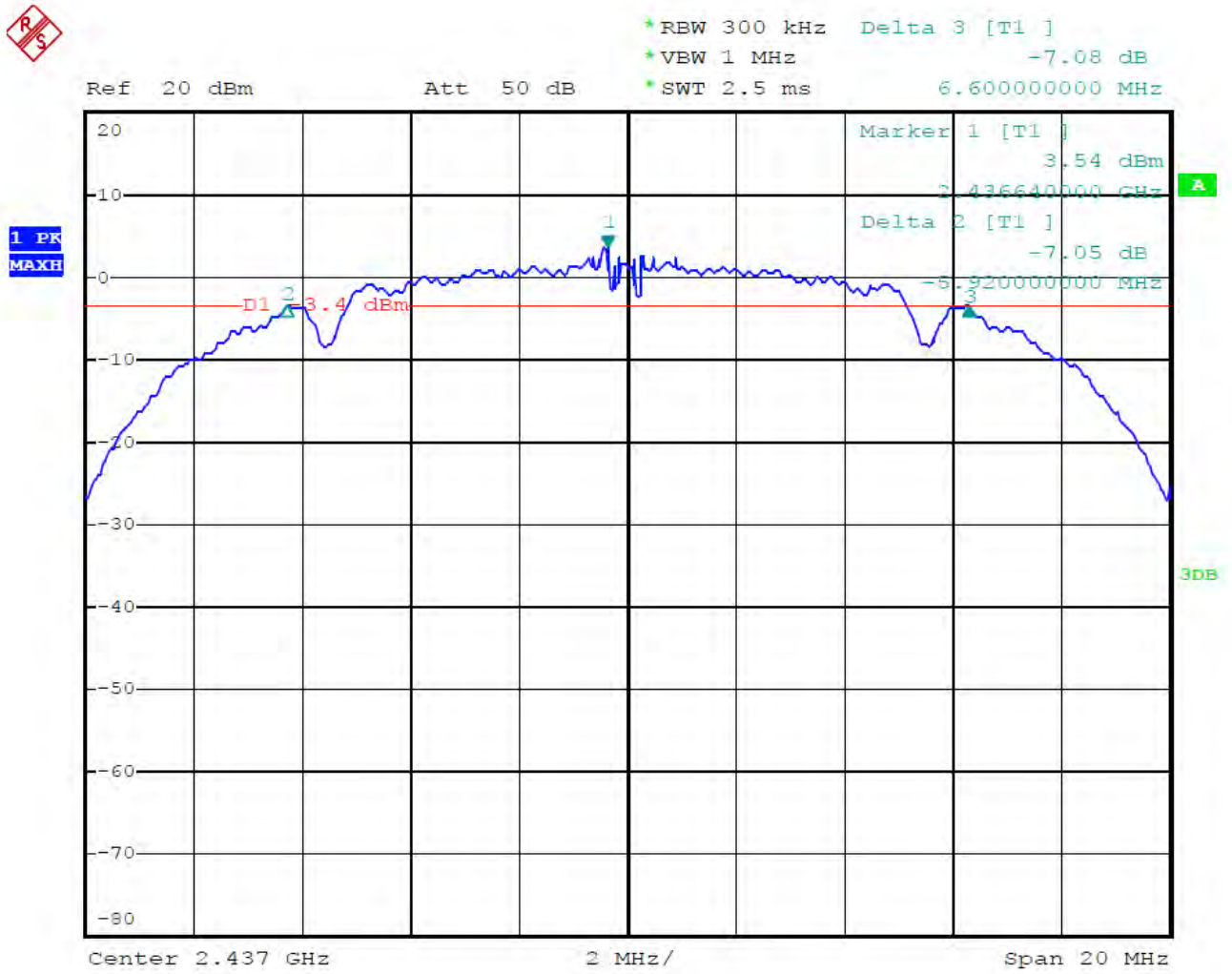

Date: 26.JUN.2012 17:25:31

6. MAXIMUM PEAK OUTPUT POWER

6.1. Block Diagram of Test Setup

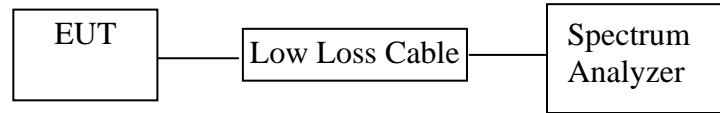

(EUT: MC200Air)

6.2. The Requirement For Section 15.247(b)(3)

Section 15.247(b)(3): For systems using digital modulation in the 902-928MHz, 2400-2483.5MHz, and 5725-5850MHz bands: 1 Watt.

6.3. EUT Configuration on Measurement

The following equipment are installed on the emission Measurement to meet the commission requirements and operating regulations in a manner which tends to maximize its emission characteristics in normal application.

6.3.1. MC200Air (EUT)

Model Number : MC200Air
 Serial Number : N/A
 Manufacturer : Boston Acoustics, Inc.

6.4. Operating Condition of EUT

6.4.1. Setup the EUT and simulator as shown as Section 6.1.

6.4.2. Turn on the power of all equipment.

6.4.3. Let the EUT work in TX modes measure it. The transmit frequency are 2412-2462MHz. We select 2412MHz, 2437MHz, 2462MHz TX frequency to transmit.

6.5. Test Procedure

6.5.1. The transmitter output was connected to the spectrum analyzer through a low loss cable.

6.5.2. Set RBW of spectrum analyzer to 1MHz and VBW to 3MHz.

6.5.3. Measurement the maximum peak output power.

6.6. Test Result

PASS.

Date of Test:	<u>June 26, 2012</u>	Temperature:	<u>25°C</u>
EUT:	<u>MC200Air</u>	Humidity:	<u>50%</u>
Model No.:	<u>MC200Air</u>	Power Supply:	<u>AC 120V/60HZ</u>
Test Mode:	<u>TX</u>	Test Engineer:	<u>Apple</u>

The test was performed with 802.11b				
Channel	Frequency (MHz)	Peak Output Power (dBm)	Peak Output Power (mW)	Limits dBm / W
Low	2412	15.19	33.04	30 dBm / 1 W
Middle	2437	15.30	33.88	30 dBm / 1 W
High	2462	15.45	35.08	30 dBm / 1 W

The test was performed with 802.11g				
Channel	Frequency (MHz)	Peak Output Power (dBm)	Peak Output Power (mW)	Limits dBm / W
Low	2412	18.78	75.51	30 dBm / 1 W
Middle	2437	18.67	73.62	30 dBm / 1 W
High	2462	18.57	71.94	30 dBm / 1 W

The spectrum analyzer plots are attached as below.

802.11b Channel Low 2412MHz

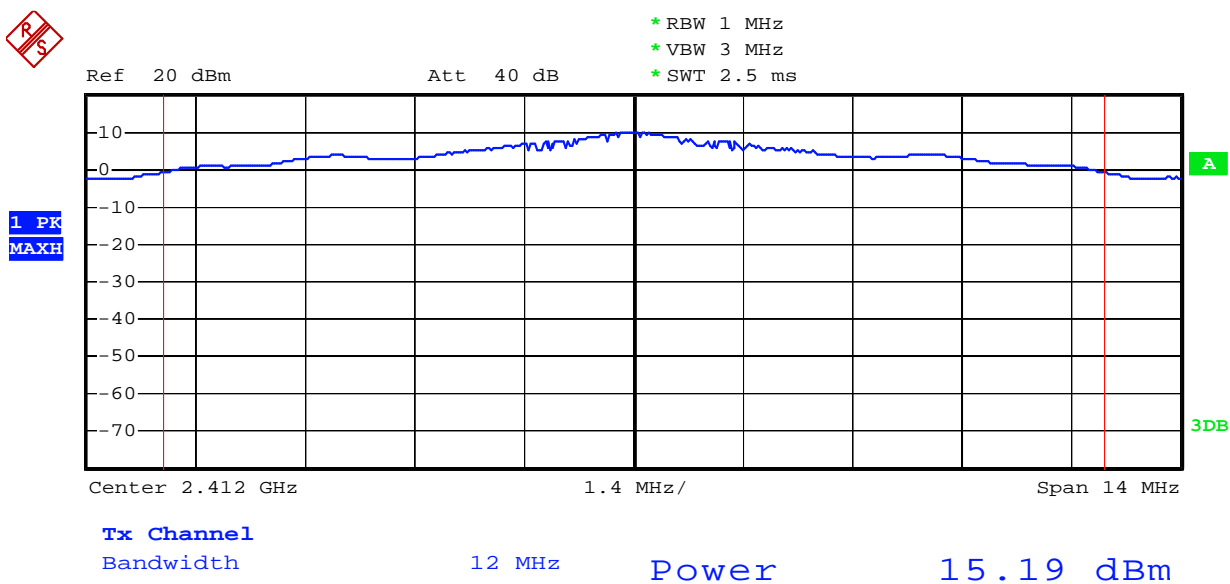

Date: 26.JUN.2012 17:35:22

802.11b Channel Middle 2437MHz

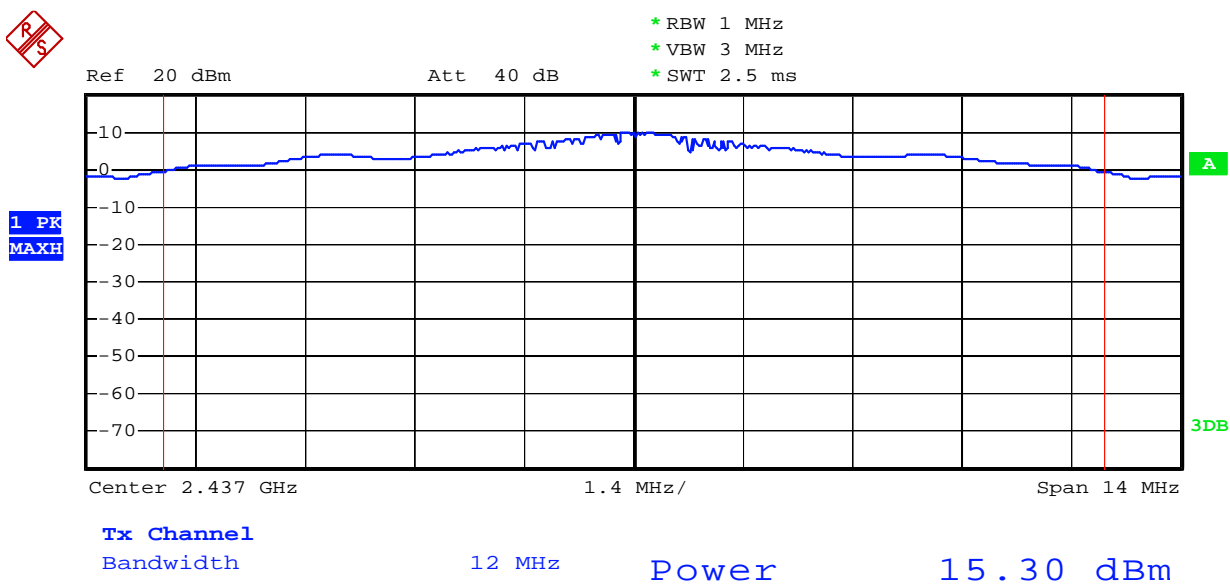

Date: 26.JUN.2012 17:33:14

802.11b Channel High 2462MHz

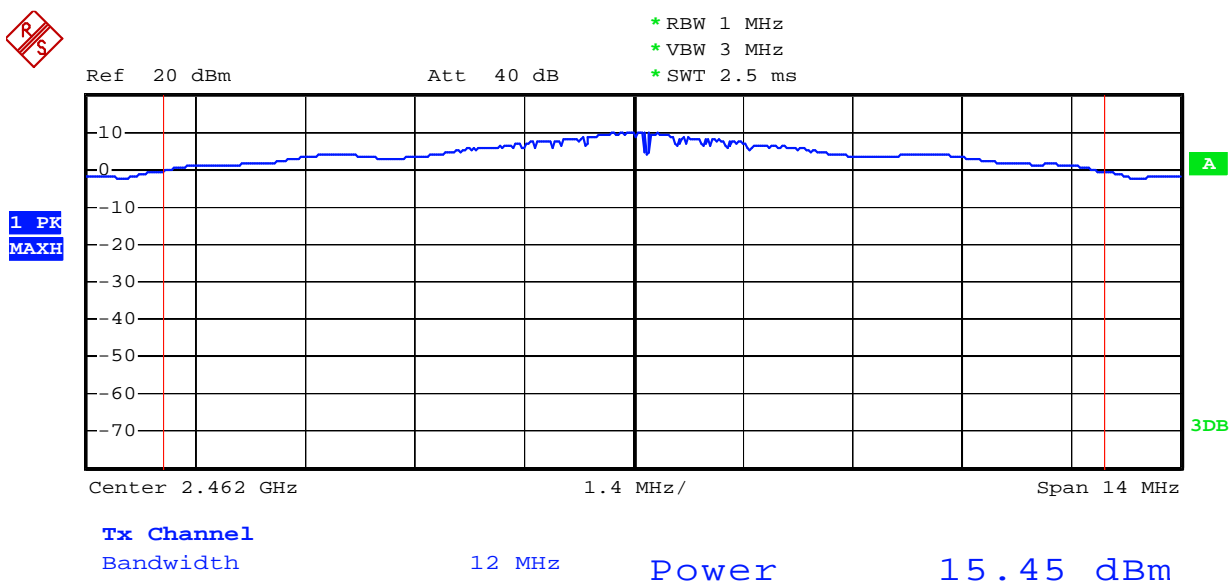

Date: 26.JUN.2012 17:30:59

802.11g Channel Low 2412MHz

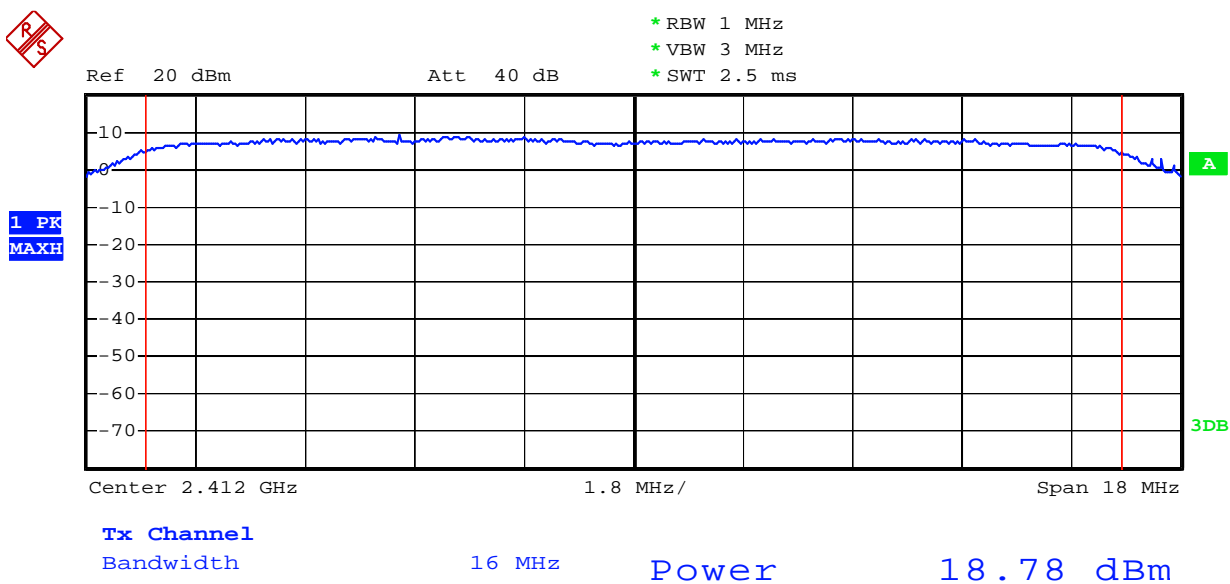

Date: 26.JUN.2012 17:57:58

802.11g Channel Middle 2437MHz



- * RBW 1 MHz
- * VBW 3 MHz
- * SWT 2.5 ms

Ref 20 dBm

Att 40 dB

1 PK
MAXH



Center 2.437 GHz

1.8 MHz/

Span 18 MHz

Tx Channel

Bandwidth

16 MHz

Power

18.67 dBm

Date: 26.JUN.2012 17:57:12

802.11g Channel High 2462MHz

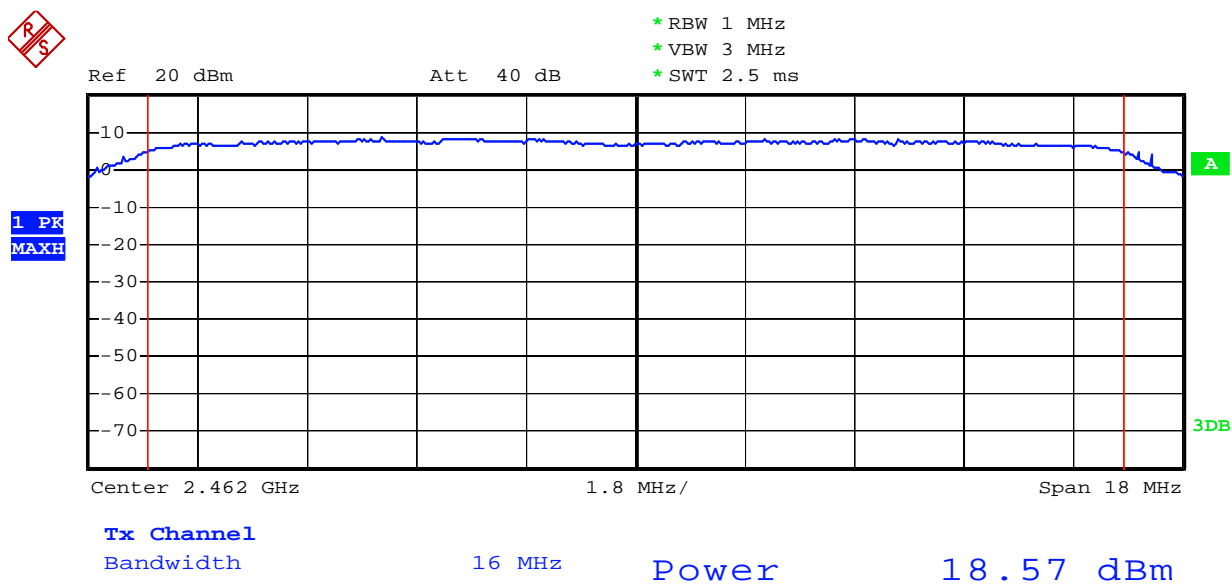

Date: 26.JUN.2012 17:55:01

7. POWER SPECTRAL DENSITY MEASUREMENT

7.1. Block Diagram of Test Setup

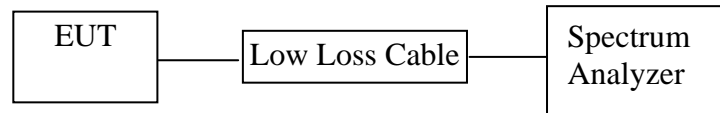

(EUT: MC200Air)

7.2. The Requirement For Section 15.247(e)

Section 15.247(e): For digitally modulated systems, the power spectral density conducted from the intentional radiator to the antenna shall not be greater than 8 dBm in any 3 kHz band during any time interval of continuous transmission.

7.3. EUT Configuration on Measurement

The following equipment are installed on the emission Measurement to meet the commission requirements and operating regulations in a manner which tends to maximize its emission characteristics in normal application.

7.3.1. MC200Air (EUT)

Model Number : MC200Air
 Serial Number : N/A
 Manufacturer : Boston Acoustics, Inc.

7.4. Operating Condition of EUT

7.4.1. Setup the EUT and simulator as shown as Section 7.1.

7.4.2. Turn on the power of all equipment.

7.4.3. Let the EUT work in TX modes measure it. The transmit frequency are 2412-2462MHz. We select 2412MHz, 2437MHz, 2462MHz TX frequency to transmit.

7.5. Test Procedure

7.5.1. The transmitter output was connected to the spectrum analyzer through a low loss cable.

7.5.2. Measurement Procedure PKPSD:

1. Use this procedure when the maximum peak conducted output power in the fundamental emission is used to demonstrate compliance.
2. Set the RBW = 100 kHz.
3. Set the VBW \geq 300 kHz.
4. Set the span to 5-30 % greater than the EBW.
5. Detector = peak.
6. Sweep time = auto couple.
7. Trace mode = max hold.
8. Allow trace to fully stabilize.
9. Use the peak marker function to determine the maximum power level in any 100 kHz band segment within the fundamental EBW.
10. Scale the observed power level to an equivalent value in 3 kHz by adjusting (reducing) the measured power by a bandwidth correction factor (BWCF) where $BWCF = 10\log(3 \text{ kHz}/100 \text{ kHz}) = -15.2 \text{ dB}$.
11. The resulting peak PSD level must be \leq 8 dBm.

7.5.3. Measurement the maximum power spectral density.

7.6. Test Result

PASS.

Date of Test:	June 26, 2012	Temperature:	25°C
EUT:	MC200Air	Humidity:	50%
Model No.:	MC200Air	Power Supply:	AC 120V/60HZ
Test Mode:	TX	Test Engineer:	Apple

The test was performed with 802.11b

Channel	Frequency (MHz)	Power Spectral Density(dBm/100 kHz)	BWCF factor (100kHz to 3kHz)	Power Spectral Density(dBm/3 kHz)	Limits (dBm)
Low	2412	1.26	-15.2	-13.94	8 dBm
Middle	2437	1.48	-15.2	-13.72	8 dBm
High	2462	1.43	-15.2	-13.77	8 dBm

The test was performed with 802.11g

Channel	Frequency (MHz)	Power Spectral Density(dBm/100 kHz)	BWCF factor (100kHz to 3kHz)	Power Spectral Density(dBm/3 kHz)	Limits (dBm)
Low	2412	-1.27	-15.2	-16.47	8 dBm
Middle	2437	-1.46	-15.2	-16.66	8 dBm
High	2462	-1.49	-15.2	-16.69	8 dBm

The spectrum analyzer plots are attached as below.

802.11b Channel Low 2412MHz



*RBW 100 kHz Marker 1 [T1]
*VBW 300 kHz 1.26 dBm
*SWT 100 s 2.412728000 GHz

Ref 20 dBm

Att 50 dB

1 PK
MAXH

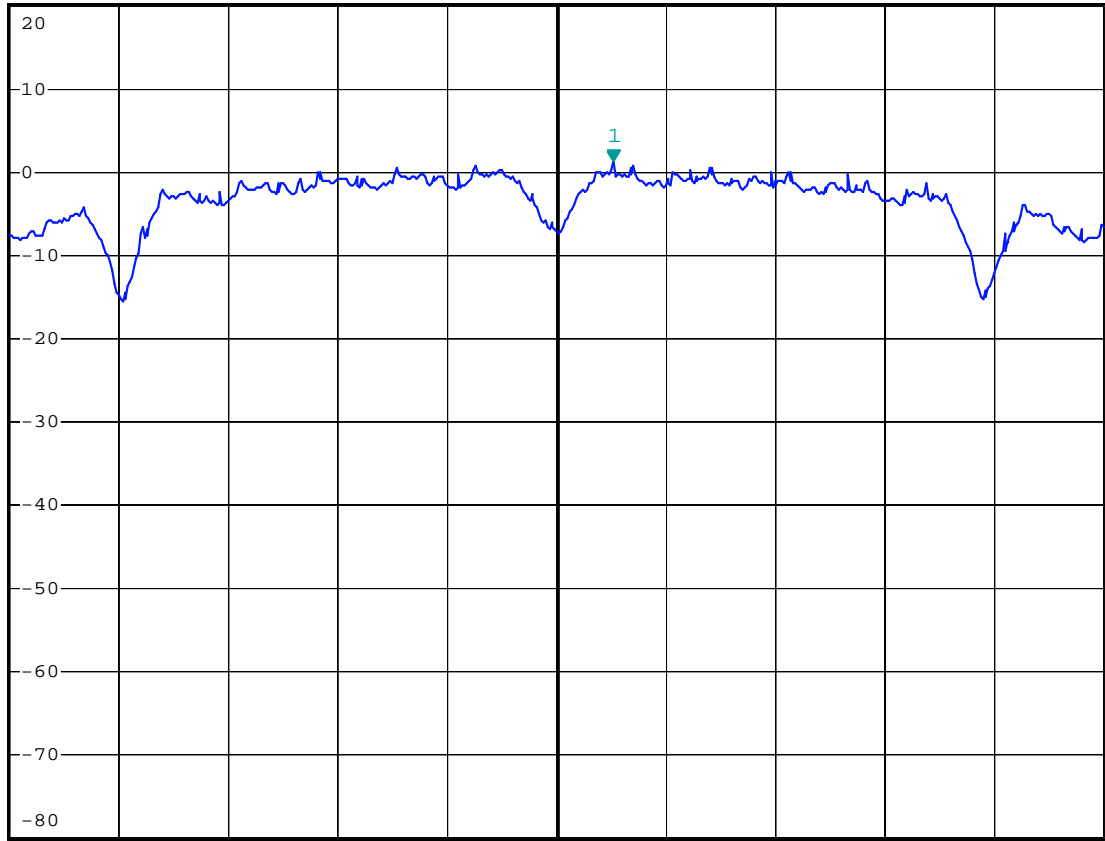

Center 2.412 GHz

1.4 MHz/

Span 14 MHz

Date: 26.JUN.2012 17:47:47

802.11b Channel Middle 2437MHz



*RBW 100 kHz Marker 1 [T1]
*VBW 300 kHz 1.48 dBm
*SWT 100 s 2.437728000 GHz

Ref 20 dBm

Att 50 dB

1 PK
MAXH

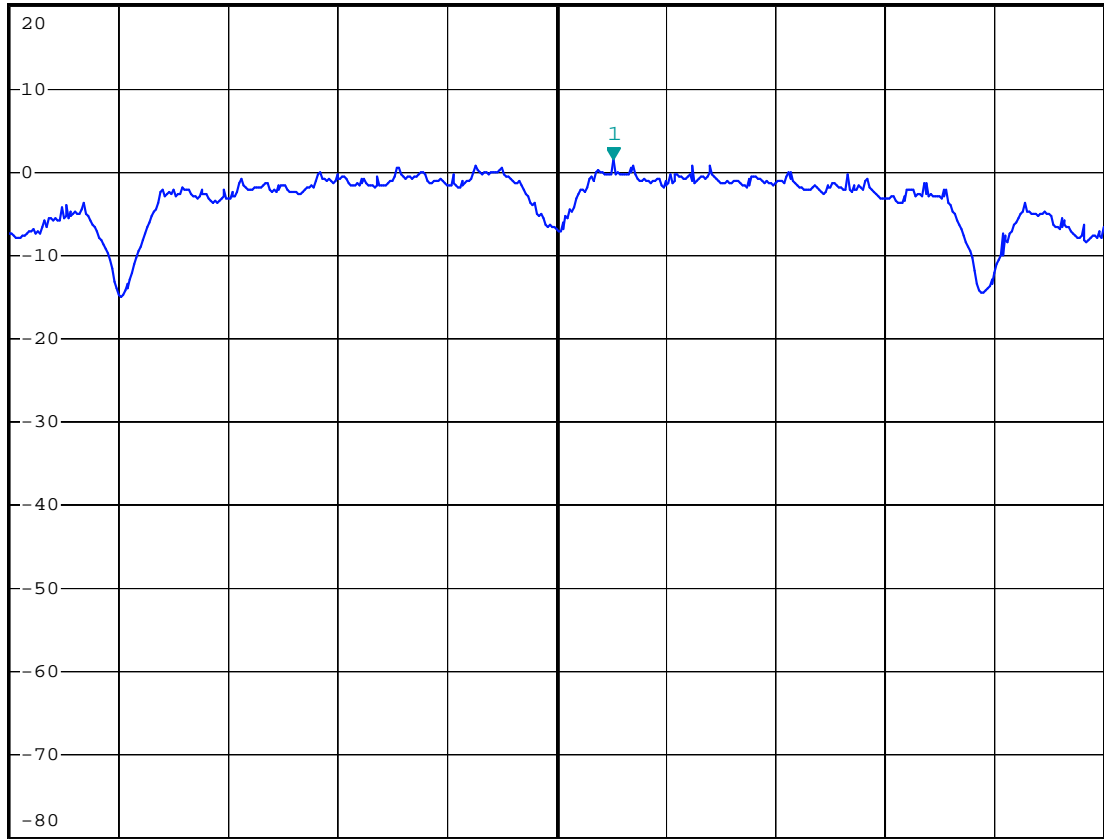

Center 2.437 GHz

1.4 MHz/

Span 14 MHz

Date: 26.JUN.2012 17:44:15

802.11b Channel High 2462MHz



*RBW 100 kHz Marker 1 [T1]
*VBW 300 kHz 1.43 dBm
*SWT 100 s 2.462728000 GHz

Ref 20 dBm

Att 50 dB

1 PK
MAXH

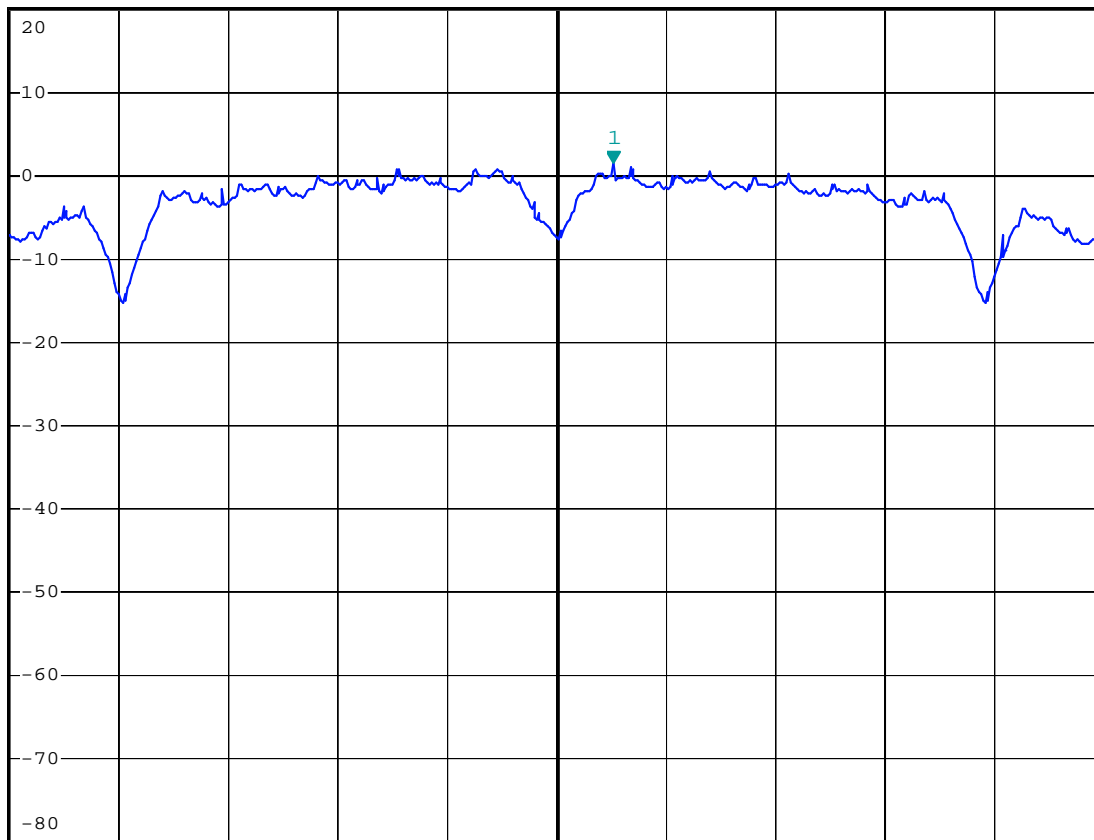

Center 2.462 GHz

1.4 MHz/

Span 14 MHz

Date: 26.JUN.2012 17:40:24

802.11g Channel Low 2412MHz



*RBW 100 kHz Marker 1 [T1]
*VBW 300 kHz -1.27 dBm
*SWT 100 s 2.414484000 GHz

Ref 20 dBm

Att 50 dB

1 PK
MAXH

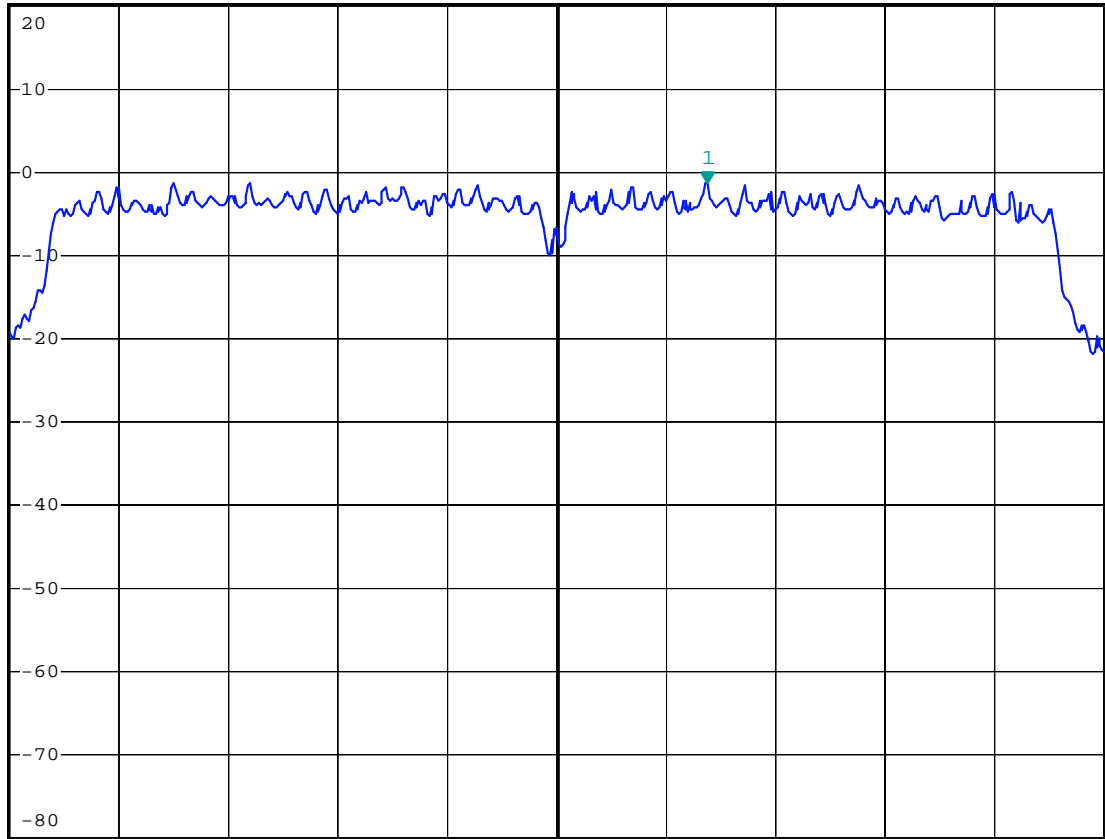

Center 2.412 GHz

1.8 MHz/

Span 18 MHz

Date: 26.JUN.2012 18:12:10

802.11g Channel Middle 2437MHz



*RBW 100 kHz Marker 1 [T1]
*VBW 300 kHz -1.46 dBm
*SWT 100 s 2.439484000 GHz

Ref 20 dBm

Att 50 dB

1 PK
MAXH

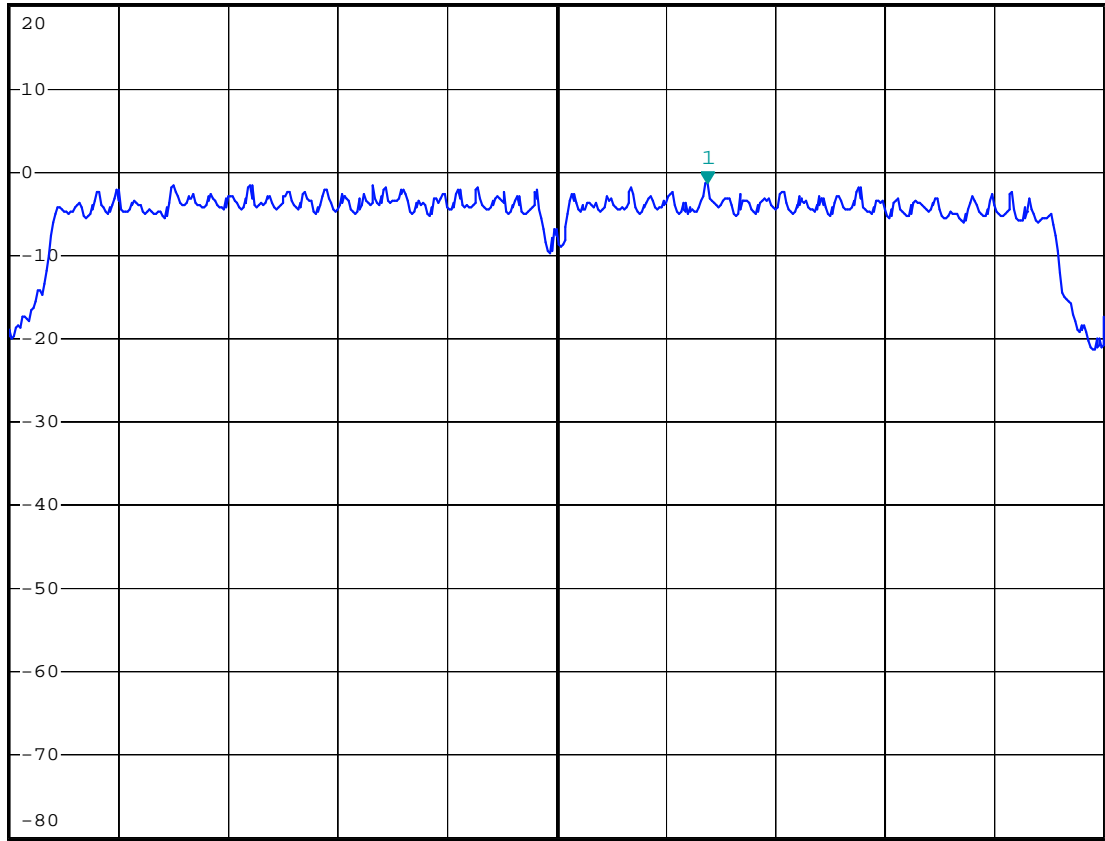

Center 2.437 GHz

1.8 MHz/

Span 18 MHz

Date: 26.JUN.2012 18:08:31

802.11g Channel High 2462MHz



*RBW 100 kHz Marker 1 [T1]
*VBW 300 kHz -1.49 dBm
*SWT 100 s 2.464484000 GHz

Ref 20 dBm

Att 50 dB

1 PK
MAXH

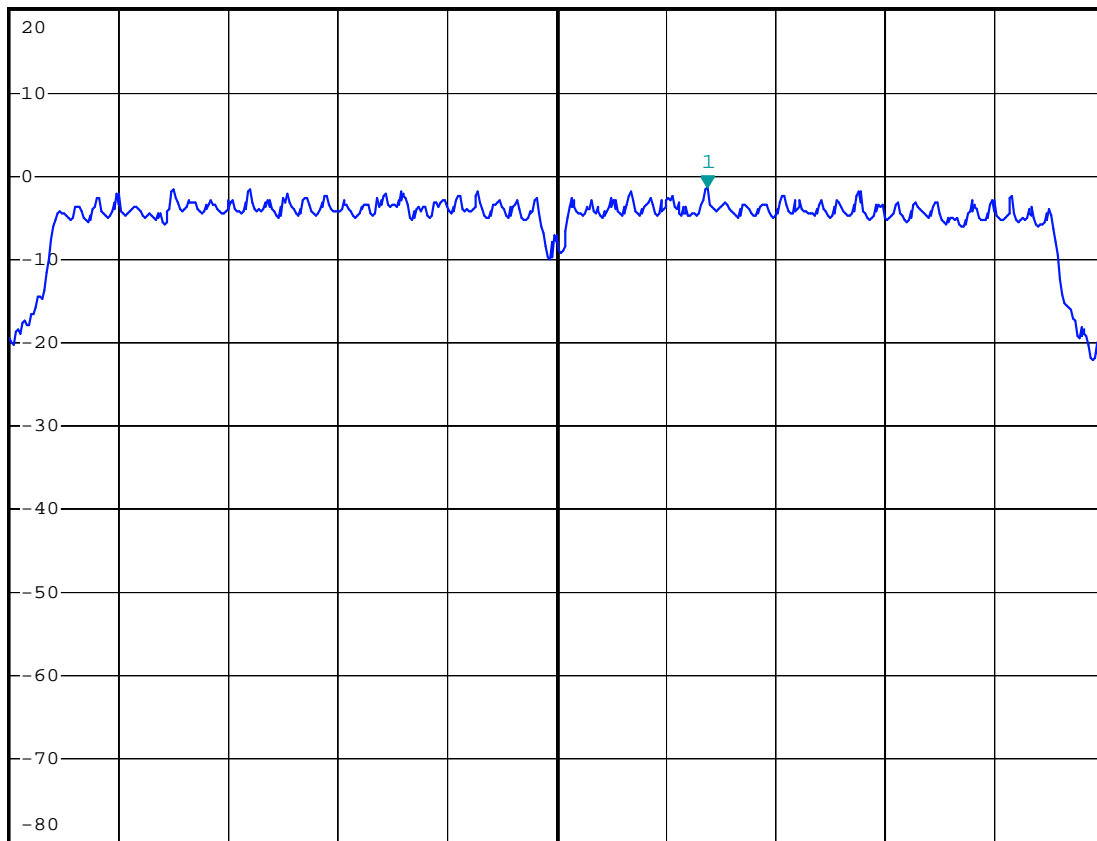

Center 2.462 GHz

1.8 MHz/

Span 18 MHz

Date: 26.JUN.2012 18:04:36

8. BAND EDGE COMPLIANCE TEST

8.1. Block Diagram of Test Setup

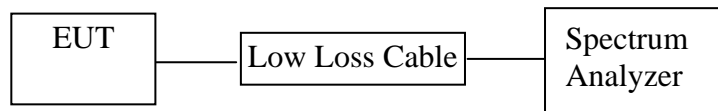

(EUT: MC200Air)

8.2. The Requirement For Section 15.247(d)

Section 15.247(d): In any 100 kHz bandwidth outside the frequency band in which the spread spectrum or digitally modulated intentional radiator is operating, the radio frequency power that is produced by the intentional radiator shall be at least 20 dB below that in the 100 kHz bandwidth within the band that contains the highest level of the desired power, based on either an RF conducted or a radiated measurement, provided the transmitter demonstrates compliance with the peak conducted power limits. If the transmitter complies with the conducted power limits based on the use of RMS averaging over a time interval, as permitted under paragraph (b)(3) of this section, the attenuation required under this paragraph shall be 30 dB instead of 20 dB. Attenuation below the general limits specified in Section 15.209(a) is not required. In addition, radiated emissions which fall in the restricted bands, as defined in Section 15.205(a), must also comply with the radiated emission limits specified in Section 15.209(a).

8.3. EUT Configuration on Measurement

The following equipment are installed on the emission Measurement to meet the commission requirements and operating regulations in a manner which tends to maximize its emission characteristics in normal application.

8.3.1. MC200Air (EUT)

Model Number	:	MC200Air
Serial Number	:	N/A
Manufacturer	:	Boston Acoustics, Inc.

8.4. Operating Condition of EUT

8.4.1. Setup the EUT and simulator as shown as Section 8.1.

8.4.2. Turn on the power of all equipment.

8.4.3. Let the EUT work in TX modes measure it. The transmit frequency are 2412-2462MHz. We select 2412MHz, 2462MHz TX frequency to transmit.

8.5. Test Procedure

Conducted Band Edge:

8.5.1. The transmitter output was connected to the spectrum analyzer via a low loss cable.

8.5.2. Set RBW of spectrum analyzer to 100kHz and VBW to 300kHz.

Radiate Band Edge:

8.5.3. The EUT is placed on a turntable, which is 0.8m above the ground plane and worked at highest radiated power.

8.5.4. The turntable was rotated for 360 degrees to determine the position of maximum emission level.

8.5.5. EUT is set 3m away from the receiving antenna, which is varied from 1m to 4m to find out the highest emission.

8.5.6. Set the spectrum analyzer in the following setting in order to capture the lower and upper band-edges of the emission:

RBW=1MHz, VBW=1MHz

8.5.7. The band edges was measured and recorded.

8.6. Test Result

Pass**Conducted test**

Date of Test:	June 26, 2012	Temperature:	25°C
EUT:	MC200Air	Humidity:	50%
Model No.:	MC200Air	Power Supply:	AC 120V/60HZ
Test Mode:	TX	Test Engineer:	Apple

The test was performed with 802.11b

Frequency (MHz)	Result of Band Edge (dBc)	Limit of Band Edge (dBc)
2412	39.65	> 20dBc
2462	43.24	> 20dBc

The test was performed with 802.11g

Frequency (MHz)	Result of Band Edge (dBc)	Limit of Band Edge (dBc)
2412	38.62	> 20dBc
2462	40.56	> 20dBc

802.11b Channel Low 2412MHz



*RBW 100 kHz Delta 2 [T1]
*VBW 300 kHz -39.65 dB
*SWT 10 ms -12.800000000 MHz

Ref 20 dBm

Att 50 dB

1 PK
MAXH

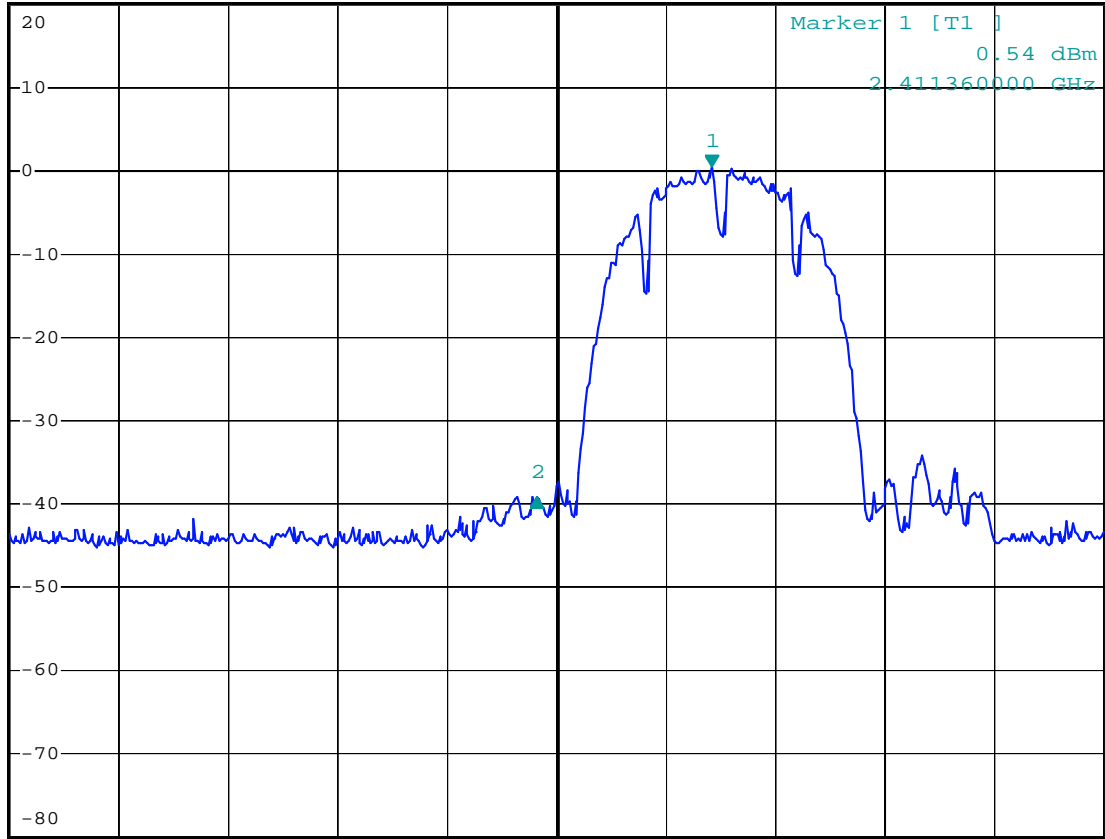

Date: 26.JUN.2012 17:36:24

802.11b Channel High 2462MHz



*RBW 100 kHz Delta 2 [T1]
*VBW 300 kHz -43.24 dB
*SWT 10 ms 25.600000000 MHz

Ref 20 dBm

Att 50 dB

1 PK
MAXH

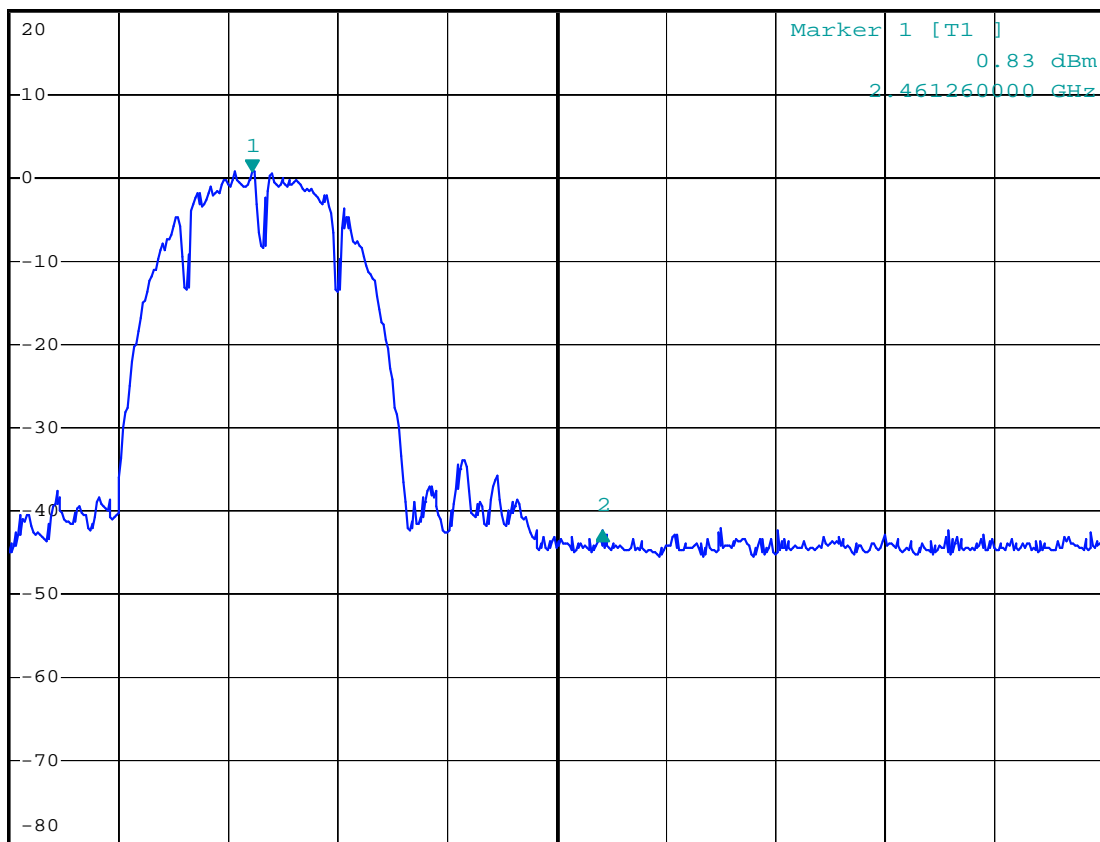

Center 2.4835 GHz

8 MHz/

Span 80 MHz

Date: 26.JUN.2012 17:37:32

802.11g Channel Low 2412MHz



*RBW 100 kHz Delta 2 [T1]
*VBW 300 kHz -38.62 dB
*SWT 10 ms -15.040000000 MHz

Ref 20 dBm

Att 50 dB

1 PK
MAXH

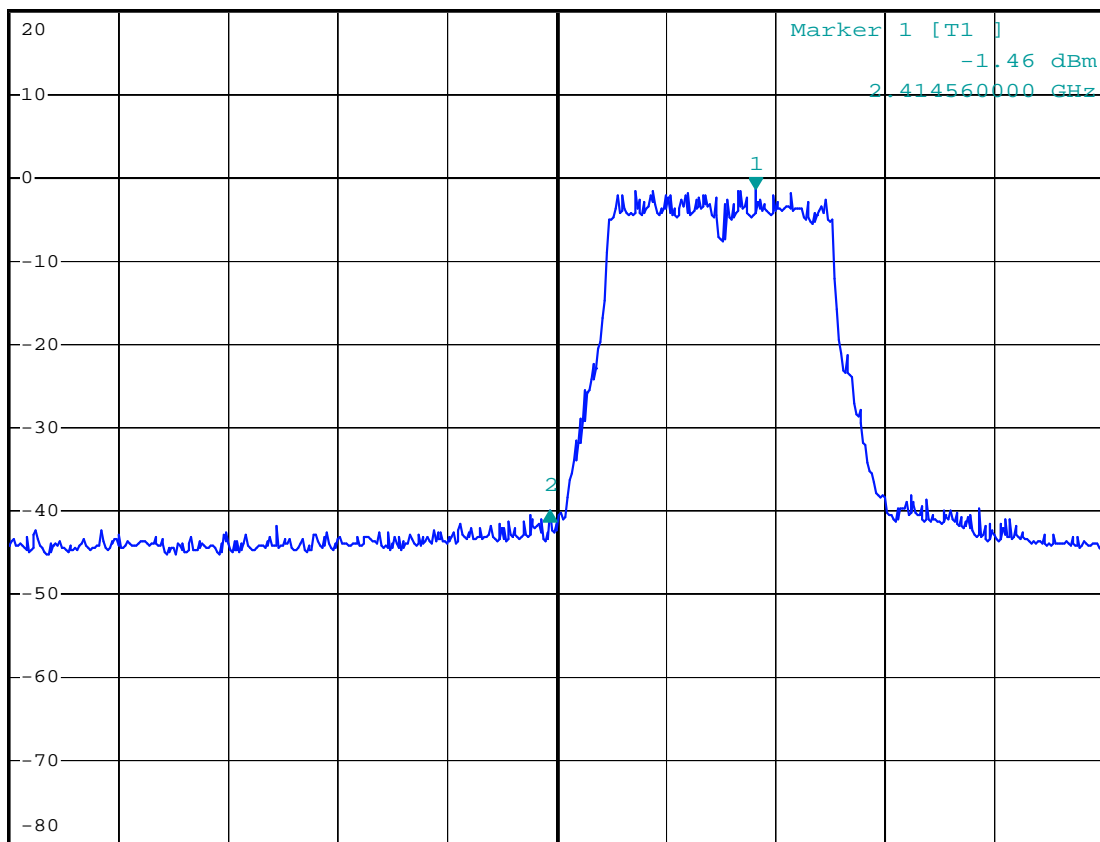

Center 2.4 GHz

8 MHz/

Span 80 MHz

Date: 26.JUN.2012 17:59:22

802.11g Channel High 2462MHz



*RBW 100 kHz Delta 2 [T1]
*VBW 300 kHz -40.56 dB
*SWT 10 ms 22.720000000 MHz

Ref 20 dBm

Att 50 dB

1 PK
MAXH

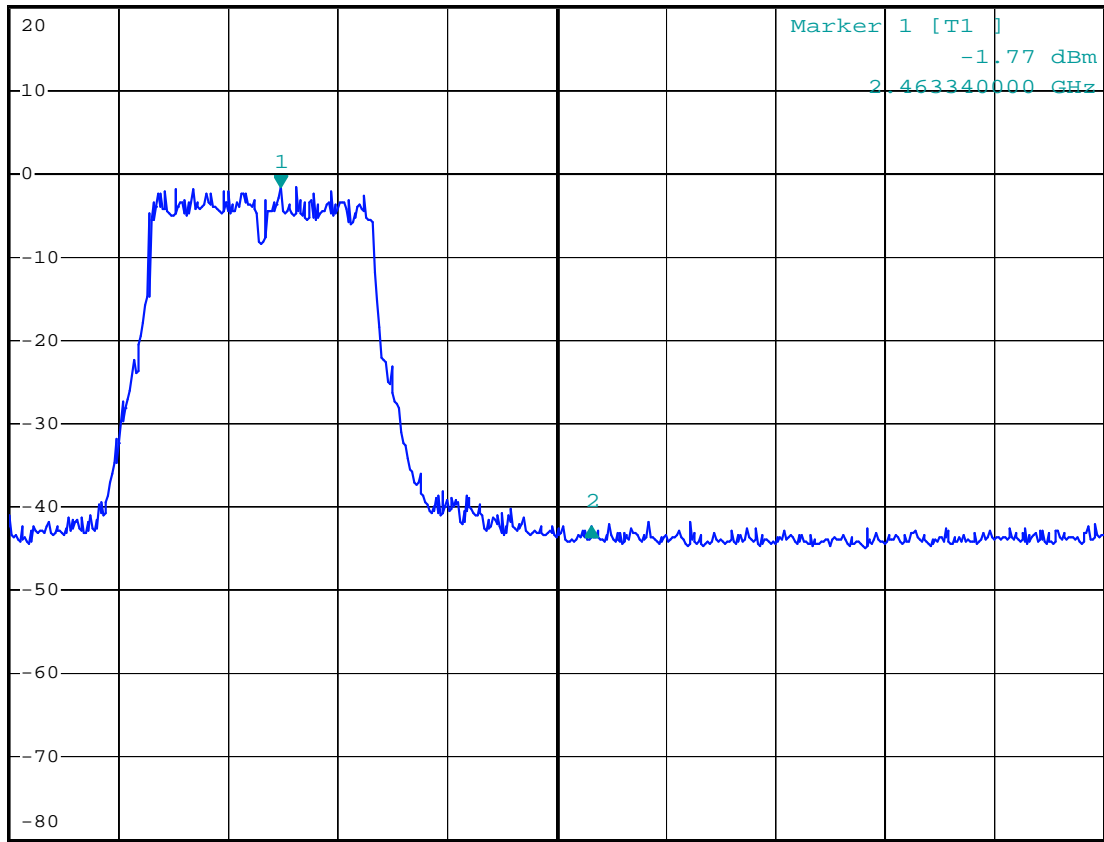

Center 2.4835 GHz

8 MHz/

Span 80 MHz

Date: 26.JUN.2012 18:00:25

Radiated Band Edge Result

Date of Test:	<u>July 28 2012</u>	Temperature:	<u>25°C</u>
EUT:	<u>MC200Air</u>	Humidity:	<u>50%</u>
Model No.:	<u>MC200Air</u>	Power Supply:	<u>AC 120V/60HZ</u>
Test Mode:	<u>802.11b Channel Low 2412MHz</u>	Test Engineer:	<u>Apple</u>

Frequency (MHz)	Reading(dBμV/m)		Factor(dB) Corr.	Result(dBμV/m)		Limit(dBμV/m)		Margin(dB)		Polarization
	AV	PEAK		AV	PEAK	AV	PEAK	AV	PEAK	
2310.000	49.36	54.60	-7.81	41.55	46.79	54	74	-12.45	-27.21	Vertical
2369.250	48.75	53.76	-7.66	41.09	46.10	54	74	-12.91	-27.90	
2390.000	48.78	52.75	-7.53	41.25	45.22	54	74	-12.75	-28.78	
2310.000	45.58	50.27	-7.81	37.77	42.46	54	74	-16.23	-31.54	Horizontal
2369.185	45.25	50.43	-7.66	37.59	42.77	54	74	-16.41	-31.23	
2390.000	46.69	51.78	-7.53	39.16	44.25	54	74	-14.84	-29.75	

Note:

1. Emissions attenuated more than 20 dB below the permissible value are not reported.
2. The field strength is calculated by adding the antenna factor, high pass filter loss(if used) and cable loss, and subtracting the amplifier gain(if any)from the measured reading. The basic equation calculation is as follows:
Result = Reading + Corrected Factor
3. Display the measurement of peak values.

Date of Test:	<u>July 28 2012</u>	Temperature:	<u>25°C</u>
EUT:	<u>MC200Air</u>	Humidity:	<u>50%</u>
Model No.:	<u>MC200Air</u>	Power Supply:	<u>AC 120V/60HZ</u>
Test Mode:	<u>802.11b Channel High 2462MHz</u>	Test Engineer:	<u>Apple</u>

Frequency (MHz)	Reading(dBμV/m)		Factor(dB) Corr.	Result(dBμV/m)		Limit(dBμV/m)		Margin(dB)		Polarization
	AV	PEAK		AV	PEAK	AV	PEAK	AV	PEAK	
2483.500	46.24	50.10	-7.37	38.87	42.73	54	74	-15.13	-31.27	Vertical
2489.580	42.78	47.01	-7.39	35.39	39.62	54	74	-18.61	-34.38	
2500.000	41.88	46.91	-7.40	34.48	39.51	54	74	-19.52	-34.49	
2483.500	43.85	47.58	-7.37	36.48	40.21	54	74	-17.52	-33.79	Horizontal
2489.883	41.25	46.02	-7.39	33.86	38.63	54	74	-20.14	-35.37	
2500.000	42.19	47.43	-7.40	34.79	40.03	54	74	-19.21	-33.97	

Note:

1. Emissions attenuated more than 20 dB below the permissible value are not reported.
2. The field strength is calculated by adding the antenna factor, high pass filter loss(if used) and cable loss, and subtracting the amplifier gain(if any)from the measured reading. The basic equation calculation is as follows:
Result = Reading + Corrected Factor
3. Display the measurement of peak values.

Date of Test:	<u>July 28 2012</u>	Temperature:	<u>25°C</u>
EUT:	<u>MC200Air</u>	Humidity:	<u>50%</u>
Model No.:	<u>MC200Air</u>	Power Supply:	<u>AC 120V/60HZ</u>
Test Mode:	<u>802.11g Channel Low 2412MHz</u>	Test Engineer:	<u>Apple</u>

Frequency (MHz)	Reading(dBμV/m)		Factor(dB) Corr.	Result(dBμV/m)		Limit(dBμV/m)		Margin(dB)		Polarization
	AV	PEAK		AV	PEAK	AV	PEAK	AV	PEAK	
2310.000	47.77	52.21	-7.81	39.96	44.40	54	74	-14.04	-29.60	Vertical
2369.650	46.93	51.49	-7.66	39.27	43.83	54	74	-14.73	-30.17	
2390.000	48.82	53.56	-7.53	41.29	46.03	54	74	-12.71	-27.97	
2310.000	45.77	50.40	-7.81	37.96	42.59	54	74	-16.04	-31.41	Horizontal
2369.180	43.15	48.23	-7.66	35.49	40.57	54	74	-18.51	-33.43	
2390.356	46.69	51.59	-7.53	39.16	44.06	54	74	-14.84	-29.94	

Note:

1. Emissions attenuated more than 20 dB below the permissible value are not reported.
2. The field strength is calculated by adding the antenna factor, high pass filter loss(if used) and cable loss, and subtracting the amplifier gain(if any)from the measured reading. The basic equation calculation is as follows:

$$\text{Result} = \text{Reading} + \text{Corrected Factor}$$
3. Display the measurement of peak values.

Date of Test:	<u>July 28 2012</u>	Temperature:	<u>25°C</u>
EUT:	<u>MC200Air</u>	Humidity:	<u>50%</u>
Model No.:	<u>MC200Air</u>	Power Supply:	<u>AC 120V/60HZ</u>
Test Mode:	<u>802.11g Channel High 2462MHz</u>	Test Engineer:	<u>Apple</u>

Frequency (MHz)	Reading(dBμV/m)		Factor(dB) Corr.	Result(dBμV/m)		Limit(dBμV/m)		Margin(dB)		Polarization
	AV	PEAK		AV	PEAK	AV	PEAK	AV	PEAK	
2483.500	43.55	48.45	-7.37	36.18	41.08	54	74	-17.82	-32.92	Vertical
2489.250	42.99	48.67	-7.39	35.60	41.28	54	74	-18.40	-32.72	
2500.363	41.47	46.55	-7.40	34.07	39.15	54	74	-19.93	-34.85	
2483.500	42.58	47.77	-7.37	35.21	40.40	54	74	-18.79	-33.60	Horizontal
2489.850	42.22	47.48	-7.39	34.83	40.09	54	74	-19.17	-33.91	
2500.000	41.96	46.50	-7.40	34.56	39.10	54	74	-19.44	-34.90	

Note:

1. Emissions attenuated more than 20 dB below the permissible value are not reported.
2. The field strength is calculated by adding the antenna factor, high pass filter loss(if used) and cable loss, and subtracting the amplifier gain(if any)from the measured reading. The basic equation calculation is as follows:
Result = Reading + Corrected Factor
3. Display the measurement of peak values.



ACCURATE TECHNOLOGY CO., LTD.

F1,Bldg,A,Changyuan New Material Port Keyuan Rd,
Science & Industry Park,Nanshan Shenzhen,P.R.China

Site: 966 chamber
Tel:+86-0755-26503290
Fax:+86-0755-26503396

Job No.: Bob #2578	Polarization: Horizontal
Standard: FCC 15C PK	Power Source: AC 120V/60Hz
Test item: Radiation Test	Date: 2012/07/28/
Temp.(C)/Hum.(%) 24 C / 48 %	Time: 22:32:18
EUT: MC200Air	Engineer Signature:
Mode: TX Channel 1 (802.11b)	Distance: 3m
Model: MC200Air	
Manufacturer: Boston	

Note: Report NO.:ATE20120668

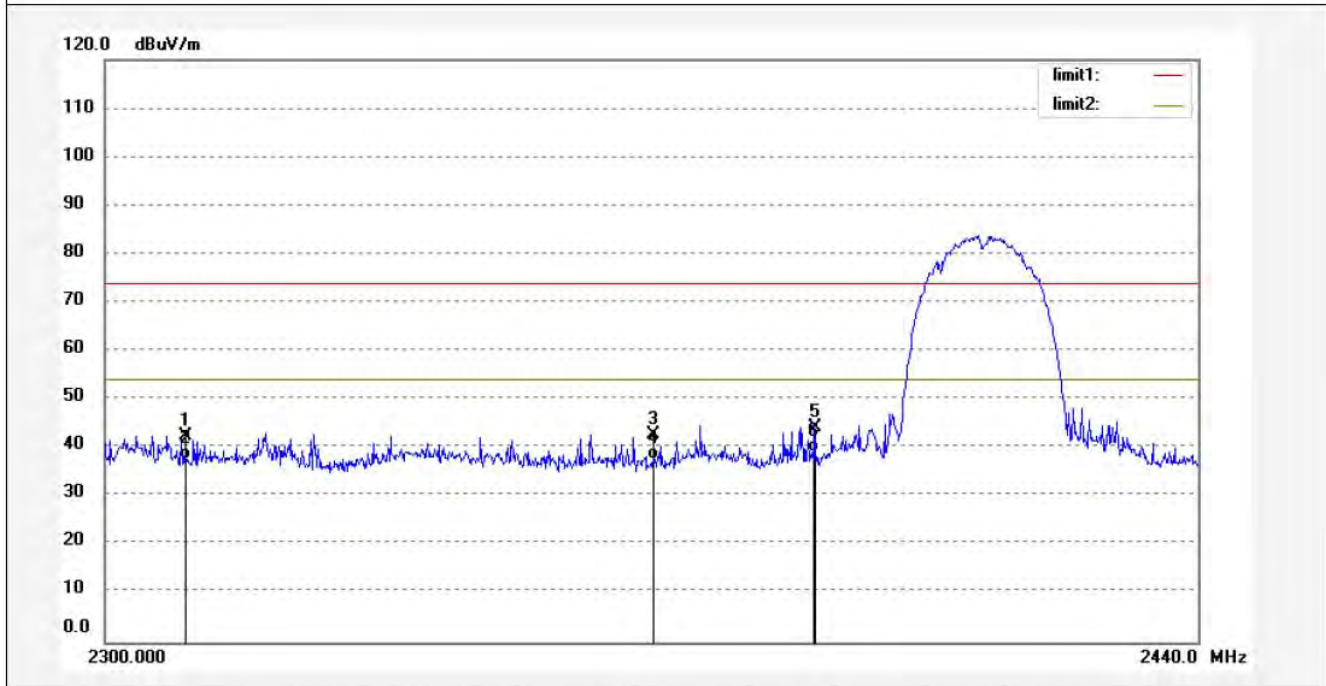

No.	Freq. (MHz)	Reading (dBuV/m)	Factor (dB)	Result (dBuV/m)	Limit (dBuV/m)	Margin (dB)	Detector	Height (cm)	Degree (deg.)	Remark
1	2310.000	50.27	-7.81	42.46	74.00	-31.54	peak			
2	2310.000	45.58	-7.81	37.77	54.00	-16.23	AVG			
3	2369.185	50.43	-7.66	42.77	74.00	-31.23	peak			
4	2369.185	45.25	-7.66	37.59	54.00	-16.41	AVG			
5	2390.000	51.78	-7.53	44.25	74.00	-29.75	peak			
6	2390.000	46.69	-7.53	39.16	54.00	-14.84	AVG			



ACCURATE TECHNOLOGY CO., LTD.

F1,Bldg,A,Changyuan New Material Port Keyuan Rd,
Science & Industry Park,Nanshan Shenzhen,P.R.China

Site: 966 chamber
Tel:+86-0755-26503290
Fax:+86-0755-26503396

Job No.: Bob #2579
Standard: FCC 15C PK
Test item: Radiation Test
Temp.(C)/Hum.(%) 24 C / 48 %
EUT: MC200Air
Mode: TX Channel 1 (802.11b)
Model: MC200Air
Manufacturer: Boston

Polarization: Vertical
Power Source: AC 120V/60Hz
Date: 2012/07/28/
Time: 22:35:05
Engineer Signature:
Distance: 3m

Note: Report NO.:ATE20120668

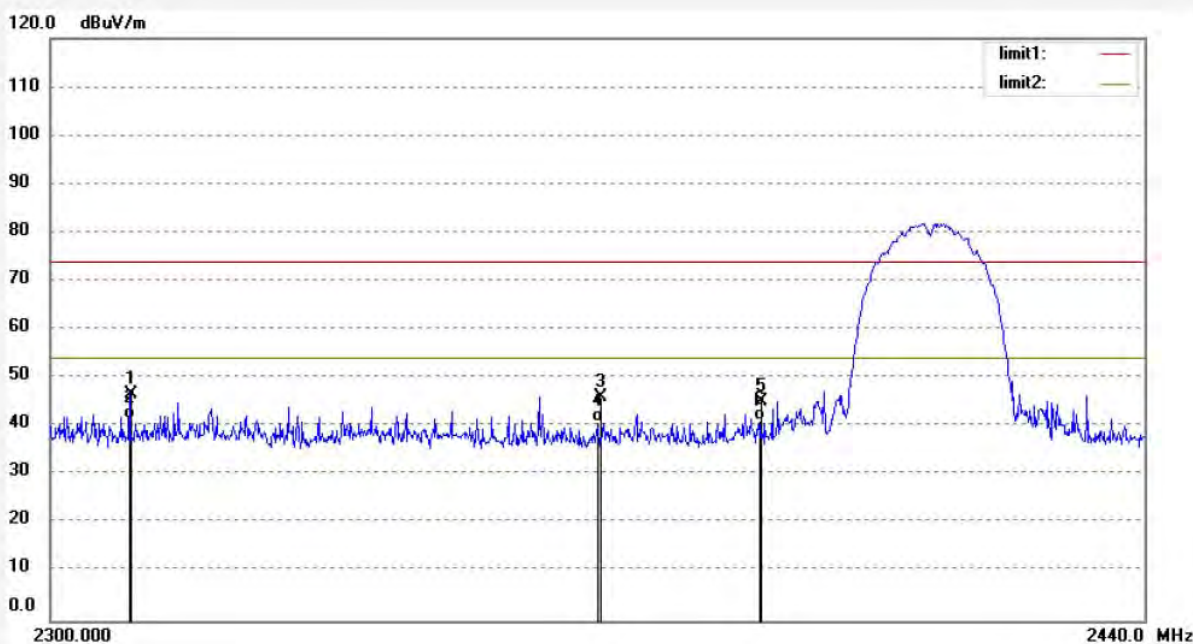

No.	Freq. (MHz)	Reading (dBuV/m)	Factor (dB)	Result (dBuV/m)	Limit (dBuV/m)	Margin (dB)	Detector	Height (cm)	Degree (deg.)	Remark
1	2310.000	54.60	-7.81	46.79	74.00	-27.21	peak			
2	2310.000	49.36	-7.81	41.55	54.00	-12.45	AVG			
3	2369.250	53.76	-7.66	46.10	74.00	-27.90	peak			
4	2369.250	48.75	-7.66	41.09	54.00	-12.91	AVG			
5	2390.000	52.75	-7.53	45.22	74.00	-28.78	peak			
6	2390.000	48.78	-7.53	41.25	54.00	-12.75	AVG			



ACCURATE TECHNOLOGY CO., LTD.

F1,Bldg,A,Changyuan New Material Port Keyuan Rd,
Science & Industry Park,Nanshan Shenzhen,P.R.China

Site: 966 chamber
Tel:+86-0755-26503290
Fax:+86-0755-26503396

Job No.: Bob #2581	Polarization: Horizontal
Standard: FCC 15C PK	Power Source: AC 120V/60Hz
Test item: Radiation Test	Date: 2012/07/28/
Temp.(C)/Hum.(%) 24 C / 48 %	Time: 22:40:26
EUT: MC200Air	Engineer Signature:
Mode: TX Channel 11 (802.11b)	Distance: 3m
Model: MC200Air	
Manufacturer: Boston	

Note: Report NO.:ATE20120668

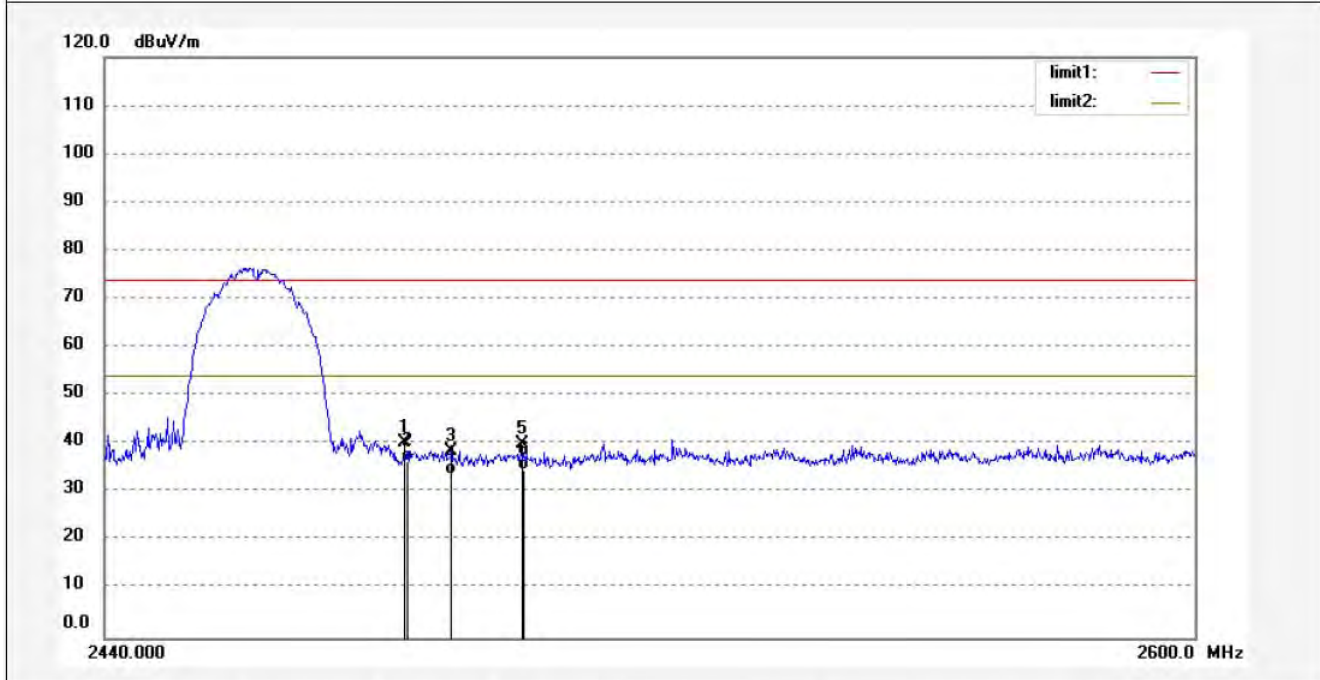

No.	Freq. (MHz)	Reading (dBuV/m)	Factor (dB)	Result (dBuV/m)	Limit (dBuV/m)	Margin (dB)	Detector	Height (cm)	Degree (deg.)	Remark
1	2483.500	47.58	-7.37	40.21	74.00	-33.79	peak			
2	2483.500	43.85	-7.37	36.48	54.00	-17.52	AVG			
3	2489.883	46.02	-7.39	38.63	74.00	-35.37	peak			
4	2489.883	41.25	-7.39	33.86	54.00	-20.14	AVG			
5	2500.000	47.43	-7.40	40.03	74.00	-33.97	peak			
6	2500.000	42.19	-7.40	34.79	54.00	-19.21	AVG			



ACCURATE TECHNOLOGY CO., LTD.

F1,Bldg,A.Changyuan New Material Port Keyuan Rd,
Science & Industry Park,Nanshan Shenzhen,P.R.China

Site: 966 chamber
Tel:+86-0755-26503290
Fax:+86-0755-26503396

Job No.: Bob #2580	Polarization: Vertical
Standard: FCC 15C PK	Power Source: AC 120V/60Hz
Test item: Radiation Test	Date: 2012/07/28/
Temp.(C)/Hum.(%) 24 C / 48 %	Time: 22:37:52
EUT: MC200Air	Engineer Signature:
Mode: TX Channel 11 (802.11b)	Distance: 3m
Model: MC200Air	
Manufacturer: Boston	

Note: Report NO.:ATE20120668

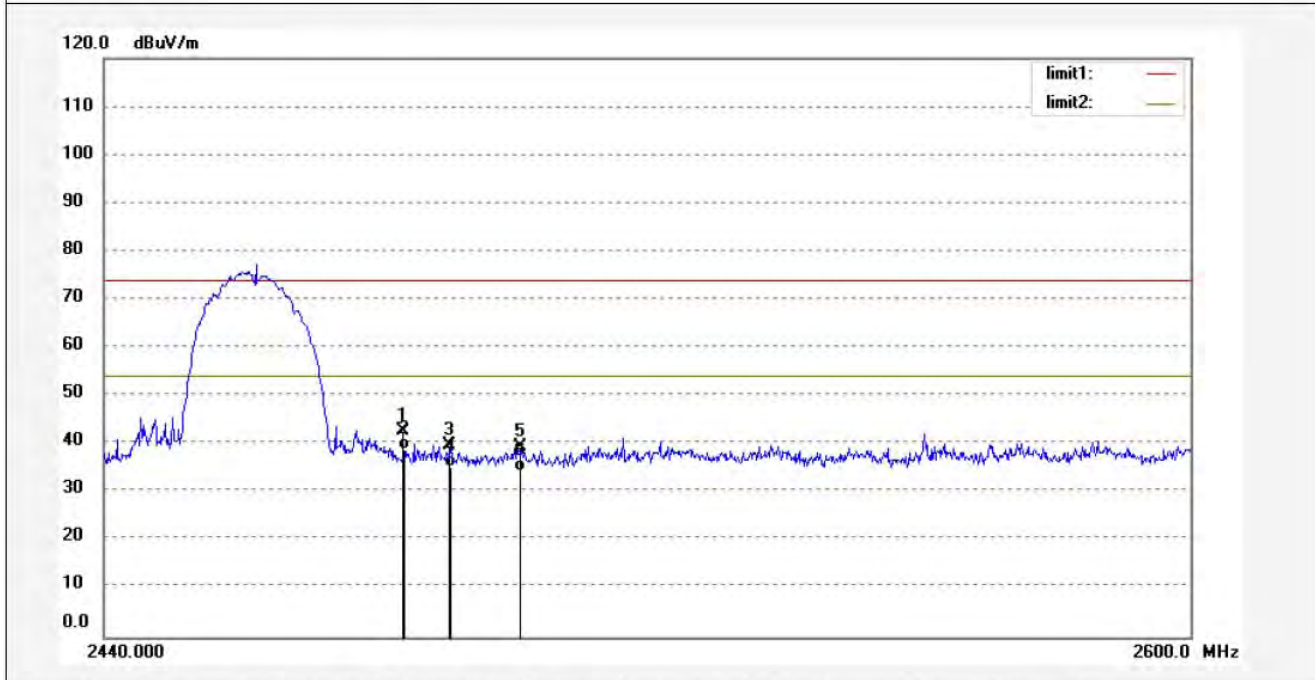

No.	Freq. (MHz)	Reading (dBuV/m)	Factor (dB)	Result (dBuV/m)	Limit (dBuV/m)	Margin (dB)	Detector	Height (cm)	Degree (deg.)	Remark
1	2483.500	50.10	-7.37	42.73	74.00	-31.27	peak			
2	2483.500	46.24	-7.37	38.87	54.00	-15.13	AVG			
3	2489.580	47.01	-7.39	39.62	74.00	-34.38	peak			
4	2489.580	42.78	-7.39	35.39	54.00	-18.61	AVG			
5	2500.000	46.91	-7.40	39.51	74.00	-34.49	peak			
6	2500.000	41.88	-7.40	34.48	54.00	-19.52	AVG			



ACCURATE TECHNOLOGY CO., LTD.

F1,Bldg,A,Changyuan New Material Port Keyuan Rd,
Science & Industry Park,Nanshan Shenzhen,P.R.China

Site: 966 chamber
Tel:+86-0755-26503290
Fax:+86-0755-26503396

Job No.: Bob #2585
Standard: FCC 15C PK
Test item: Radiation Test
Temp.(C)/Hum.(%) 24 C / 48 %
EUT: MC200Air
Mode: TX Channel 1 (802.11g)
Model: MC200Air
Manufacturer: Boston

Polarization: Horizontal
Power Source: AC 120V/60Hz
Date: 2012/07/28/
Time: 22:51:04
Engineer Signature:
Distance: 3m

Note: Report NO.:ATE20120668

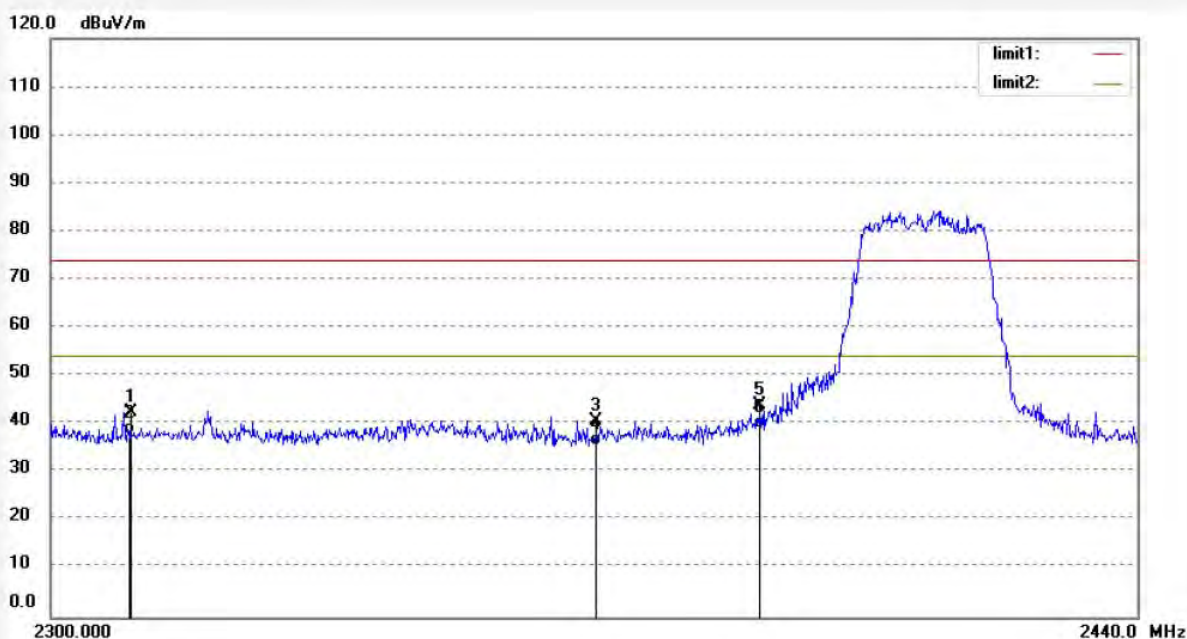

No.	Freq. (MHz)	Reading (dBuV/m)	Factor (dB)	Result (dBuV/m)	Limit (dBuV/m)	Margin (dB)	Detector	Height (cm)	Degree (deg.)	Remark
1	2310.000	50.40	-7.81	42.59	74.00	-31.41	peak			
2	2310.000	45.77	-7.81	37.96	54.00	-16.04	AVG			
3	2369.180	48.23	-7.66	40.57	74.00	-33.43	peak			
4	2369.180	43.15	-7.66	35.49	54.00	-18.51	AVG			
5	2390.356	51.59	-7.53	44.06	74.00	-29.94	peak			
6	2390.356	46.69	-7.53	39.16	54.00	-14.84	AVG			



ACCURATE TECHNOLOGY CO., LTD.

F1,Bldg,A,Changyuan New Material Port Keyuan Rd,
Science & Industry Park,Nanshan Shenzhen,P.R.China

Site: 966 chamber
Tel:+86-0755-26503290
Fax:+86-0755-26503396

Job No.: Bob #2584	Polarization: Vertical
Standard: FCC 15C PK	Power Source: AC 120V/60Hz
Test item: Radiation Test	Date: 2012/07/28/
Temp.(C)/Hum.(%) 24 C / 48 %	Time: 22:48:37
EUT: MC200Air	Engineer Signature:
Mode: TX Channel 1 (802.11g)	Distance: 3m
Model: MC200Air	
Manufacturer: Boston	

Note: Report NO.:ATE20120668

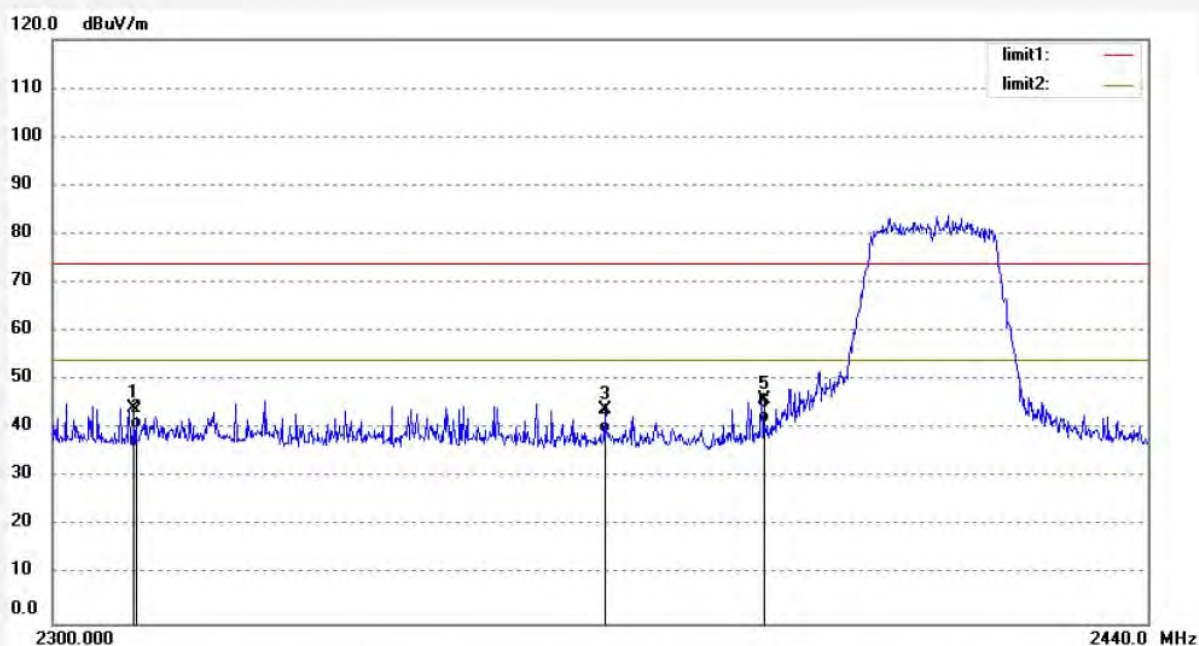

No.	Freq. (MHz)	Reading (dBuV/m)	Factor (dB)	Result (dBuV/m)	Limit (dBuV/m)	Margin (dB)	Detector	Height (cm)	Degree (deg.)	Remark
1	2310.000	52.21	-7.81	44.40	74.00	-29.60	peak			
2	2310.000	47.77	-7.81	39.96	54.00	-14.04	AVG			
3	2369.650	51.49	-7.66	43.83	74.00	-30.17	peak			
4	2369.650	46.93	-7.66	39.27	54.00	-14.73	AVG			
5	2390.000	53.56	-7.53	46.03	74.00	-27.97	peak			
6	2390.000	48.82	-7.53	41.29	54.00	-12.71	AVG			



ACCURATE TECHNOLOGY CO., LTD.

F1,Bldg,A,Changyuan New Material Port Keyuan Rd,
Science & Industry Park,Nanshan Shenzhen,P.R.China

Site: 966 chamber
Tel:+86-0755-26503290
Fax:+86-0755-26503396

Job No.: Bob #2582	Polarization: Horizontal
Standard: FCC 15C PK	Power Source: AC 120V/60Hz
Test item: Radiation Test	Date: 2012/07/28/
Temp.(C)/Hum.(%) 24 C / 48 %	Time: 22:43:14
EUT: MC200Air	Engineer Signature:
Mode: TX Channel 11 (802.11g)	Distance: 3m
Model: MC200Air	
Manufacturer: Boston	

Note: Report NO.:ATE20120668

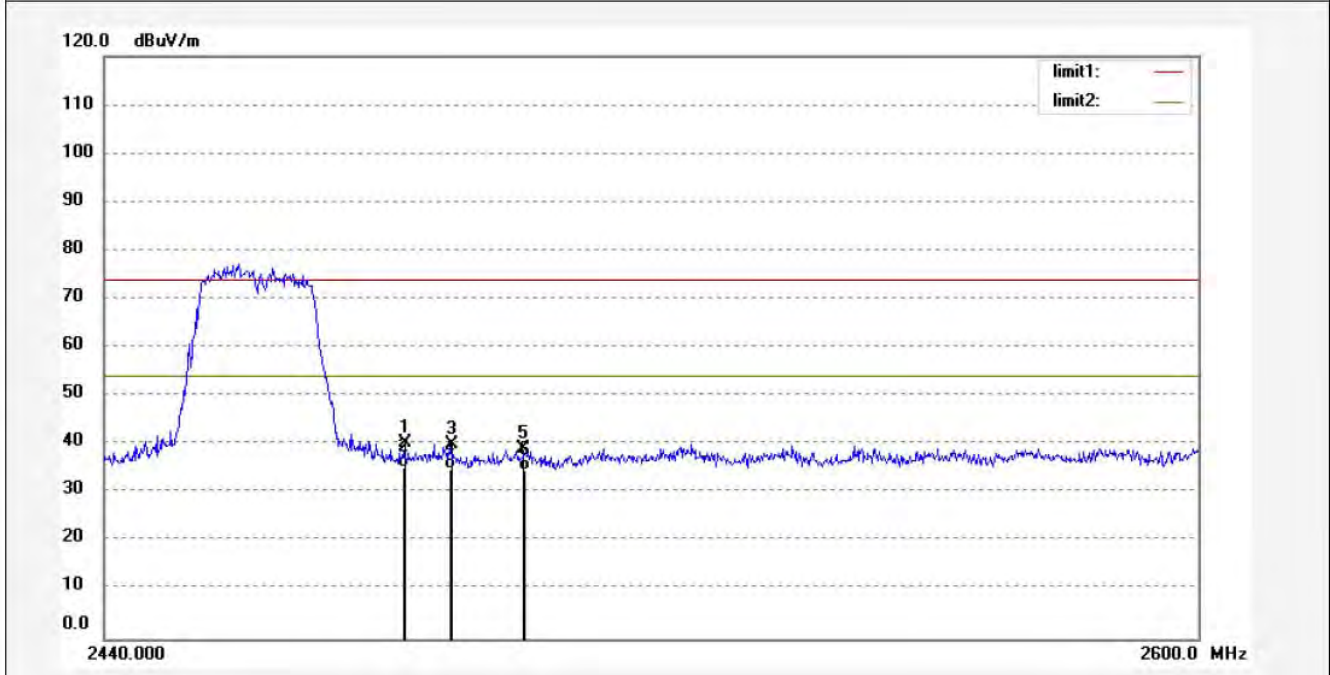

No.	Freq. (MHz)	Reading (dBuV/m)	Factor (dB)	Result (dBuV/m)	Limit (dBuV/m)	Margin (dB)	Detector	Height (cm)	Degree (deg.)	Remark
1	2483.500	47.77	-7.37	40.40	74.00	-33.60	peak			
2	2483.500	42.58	-7.37	35.21	54.00	-18.79	AVG			
3	2489.850	47.48	-7.39	40.09	74.00	-33.91	peak			
4	2489.850	42.22	-7.39	34.83	54.00	-19.17	AVG			
5	2500.000	46.50	-7.40	39.10	74.00	-34.90	peak			
6	2500.000	41.96	-7.40	34.56	54.00	-19.44	AVG			



ACCURATE TECHNOLOGY CO., LTD.

F1,Bldg,A,Changyuan New Material Port Keyuan Rd,
Science & Industry Park,Nanshan Shenzhen,P.R.China

Site: 966 chamber
Tel:+86-0755-26503290
Fax:+86-0755-26503396

Job No.: Bob #2583
Standard: FCC 15C PK
Test item: Radiation Test
Temp.(C)/Hum.(%) 24 C / 48 %
EUT: MC200Air
Mode: TX Channel 11 (802.11g)
Model: MC200Air
Manufacturer: Boston

Polarization: Vertical
Power Source: AC 120V/60Hz
Date: 2012/07/28/
Time: 22:45:41
Engineer Signature:
Distance: 3m

Note: Report NO.:ATE20120668

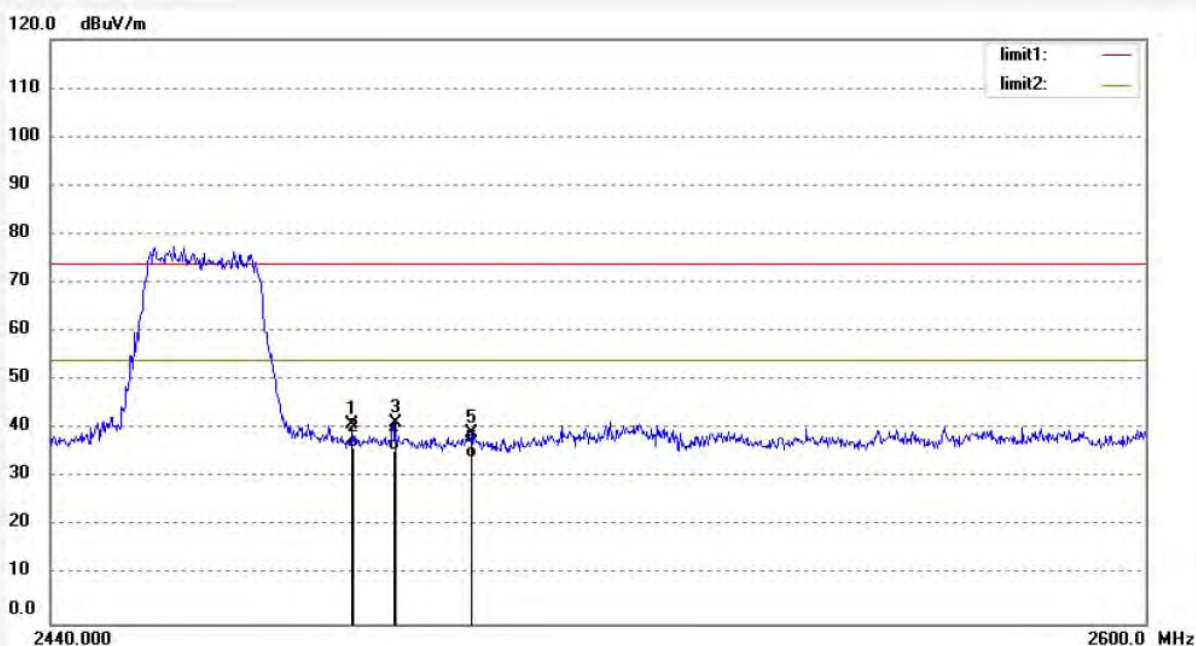

No.	Freq. (MHz)	Reading (dBuV/m)	Factor (dB)	Result (dBuV/m)	Limit (dBuV/m)	Margin (dB)	Detector	Height (cm)	Degree (deg.)	Remark
1	2483.500	48.45	-7.37	41.08	74.00	-32.92	peak			
2	2483.500	43.55	-7.37	36.18	54.00	-17.82	AVG			
3	2489.250	48.67	-7.39	41.28	74.00	-32.72	peak			
4	2489.250	42.99	-7.39	35.60	54.00	-18.40	AVG			
5	2500.363	46.55	-7.40	39.15	74.00	-34.85	peak			
6	2500.363	41.47	-7.40	34.07	54.00	-19.93	AVG			

9. RADIATED SPURIOUS EMISSION TEST

9.1. Block Diagram of Test Setup

9.1.1. Block diagram of connection between the EUT and peripherals

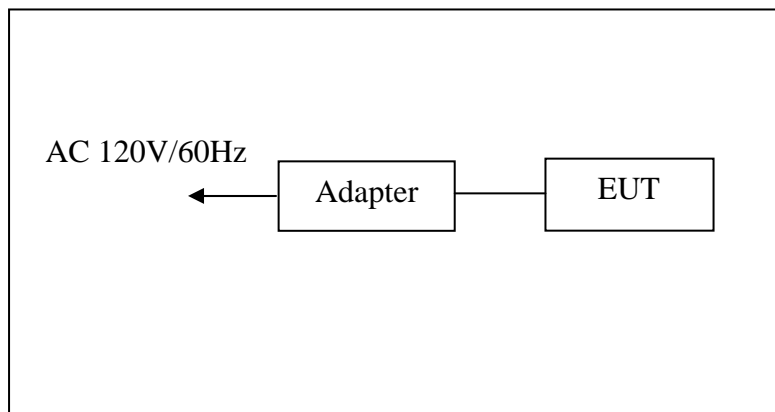

Setup: Transmitting mode

(EUT: MC200Air)

9.1.2. Semi-Anechoic Chamber Test Setup Diagram

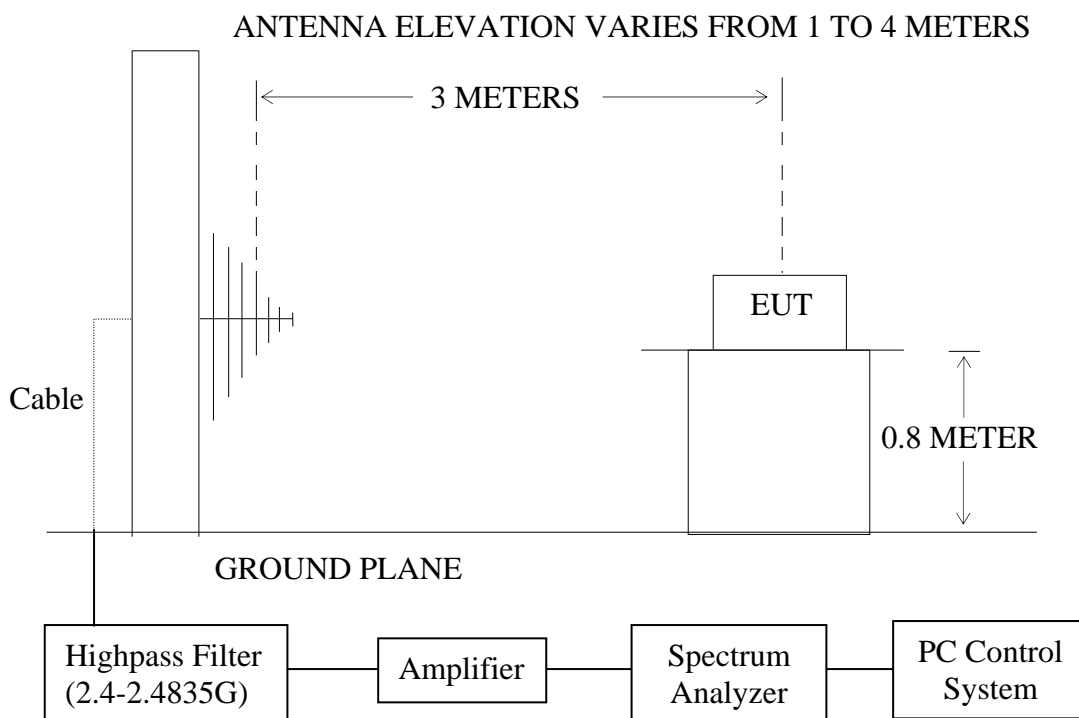

(EUT: MC200Air)

9.2.The Limit For Section 15.247(d)

Section 15.247(d): In any 100 kHz bandwidth outside the frequency band in which the spread spectrum or digitally modulated intentional radiator is operating, the radio frequency power that is produced by the intentional radiator shall be at least 20 dB below that in the 100 kHz bandwidth within the band that contains the highest level of the desired power, based on either an RF conducted or a radiated measurement, provided the transmitter demonstrates compliance with the peak conducted power limits. If the transmitter complies with the conducted power limits based on the use of RMS averaging over a time interval, as permitted under paragraph (b)(3) of this section, the attenuation required under this paragraph shall be 30 dB instead of 20 dB. Attenuation below the general limits specified in Section 15.209(a) is not required. In addition, radiated emissions which fall in the restricted bands, as defined in Section 15.205(a), must also comply with the radiated emission limits specified in Section 15.209(a).

9.3.Restricted bands of operation

9.3.1.FCC Part 15.205 Restricted bands of operation

(a) Except as shown in paragraph (d) of this section, Only spurious emissions are permitted in any of the frequency bands listed below:

MHz	MHz	MHz	GHz
0.090-0.110	16.42-16.423	399.9-410	4.5-5.15
¹ 0.495-0.505	16.69475-16.69525	608-614	5.35-5.46
2.1735-2.1905	16.80425-16.80475	960-1240	7.25-7.75
4.125-4.128	25.5-25.67	1300-1427	8.025-8.5
4.17725-4.17775	37.5-38.25	1435-1626.5	9.0-9.2
4.20725-4.20775	73-74.6	1645.5-1646.5	9.3-9.5
6.215-6.218	74.8-75.2	1660-1710	10.6-12.7
6.26775-6.26825	108-121.94	1718.8-1722.2	13.25-13.4
6.31175-6.31225	123-138	2200-2300	14.47-14.5
8.291-8.294	149.9-150.05	2310-2390	15.35-16.2
8.362-8.366	156.52475-156.52525	2483.5-2500	17.7-21.4
8.37625-8.38675	156.7-156.9	2690-2900	22.01-23.12
8.41425-8.41475	162.0125-167.17	3260-3267	23.6-24.0
12.29-12.293	167.72-173.2	3332-3339	31.2-31.8
12.51975-12.52025	240-285	3345.8-3358	36.43-36.5
12.57675-12.57725	322-335.4	3600-4400	(²)
13.36-13.41			

¹Until February 1, 1999, this restricted band shall be 0.490-0.510

²Above 38.6

(b) Except as provided in paragraphs (d) and (e), the field strength of emission appearing within these frequency bands shall not exceed the limits shown in Section 15.209. At frequencies equal to or less than 1000MHz, Compliance with the limits in Section 15.209 shall be demonstrated using measurement instrumentation employing a CISPR quasi-peak detector. Above 1000MHz, compliance with the emission limits in Section 15.209 shall be demonstrated based on the average value of the measured emissions. The provisions in Section 15.35 apply to these measurements.

9.4. Configuration of EUT on Measurement

The following equipment are installed on Radiated Emission Measurement to meet the commission requirements and operating regulations in a manner which tends to maximize its emission characteristics in normal application.

9.4.1. MC200Air (EUT)

Model Number : MC200Air
 Serial Number : N/A
 Manufacturer : Boston Acoustics, Inc.

9.5. Operating Condition of EUT

9.5.1. Setup the EUT and simulator as shown as Section 9.1.

9.5.2. Turn on the power of all equipment.

9.5.3. Let the EUT work in TX modes measure it. The transmit frequency are 2412-2462MHz. We select 2412MHz, 2437MHz, 2462MHz TX frequency to transmit.

9.6. Test Procedure

The EUT and its simulators are placed on a turntable, which is 0.8 meter high above ground. The turntable can rotate 360 degrees to determine the position of the maximum emission level. EUT is set 3.0 meters away from the receiving antenna, which is mounted on an antenna tower. The antenna can be moved up and down between 1.0 meter and 4 meters to find out the maximum emission level. Broadband antenna (calibrated bilog antenna) is used as receiving antenna. Both horizontal and vertical polarizations of the antenna are set on measurement. In order to find the maximum emission levels, all of the interface cables must be manipulated according to ANSI C63.4: 2003 on radiated emission measurement. The EUT was tested in 3 orthogonal planes.

The worst-case data rate for this channel to be 11Mbps for 802.11b mode and 54Mbps for 802.11g mode, based on previous with 802.11 WLAN product design architectures.

The bandwidth of test receiver is set at 9kHz in below 30MHz. and set at 120kHz in 30-1000MHz, and 1MHz in above 1000MHz.

The frequency range from 9kHz to 25GHz is checked.

The final measurement in band 9-90kHz, 110-490kHz and above 1000MHz is performed with Average detector. Except those frequency bands mention above, the final measurement for frequencies below 1000MHz is performed with Quasi Peak detector.

The field strength is calculated by adding the antenna factor, and cable loss, and subtracting the amplifier gain from the measured reading. The basic equation calculation is as follows:

Result = Reading + Corrected Factor

Where Corrected Factor = Antenna Factor + Cable Loss – Amplifier Gain

Between the antenna and Amplifier have a Highpass Filter (Restricted bands of operation is 2.4-2.4835G), setup show to 9.1.2

9.7. The Field Strength of Radiation Emission Measurement Results

PASS.

Date of Test:	<u>July 28, 2012</u>	Temperature:	<u>25°C</u>
EUT:	<u>MC200Air</u>	Humidity:	<u>50%</u>
Model No.:	<u>MC200Air</u>	Power Supply:	<u>AC 120V/60HZ</u>
Test Mode:	<u>802.11b Channel Low 2412MHz</u>	Test Engineer:	<u>Apple</u>

For Below 30MHz

Frequency (MHz)	Reading (dBμV/m)	Factor(dB) Corr.	Result (dBμV/m)	Limit (dBμV/m)	Margin (dB)	Polarization
	QP		QP	QP	QP	
-	-	-	-	-	-	X
-	-	-	-	-	-	Y
-	-	-	-	-	-	Z

For 30MHz-1000MHz

Corrected Factor = Antenna Factor + Cable Loss – Amplifier Gain

Frequency (MHz)	Reading (dBμV/m)	Factor Corr. (dB)	Result (dBμV/m)	Limit (dBμV/m)	Margin (dB)	Polarization
	QP		QP	QP	QP	
556.1214	11.97	25.34	37.31	46.00	-8.69	Vertical
635.5576	14.28	26.07	40.35	46.00	-5.65	Vertical
779.2179	13.89	27.83	41.72	46.00	-4.28	Vertical
284.2606	21.76	18.42	40.18	46.00	-5.82	Horizontal
736.6209	14.66	27.47	42.13	46.00	-3.87	Horizontal
955.3509	13.08	29.63	42.71	46.00	-3.29	Horizontal

For 1GHz-25GHz

Corrected Factor = Antenna Factor + Cable Loss – Amplifier Gain

Frequency (MHz)	Reading(dBμV/m)		Factor Corr. (dB)	Result(dBμV/m)		Limit(dBμV/m)		Margin(dBμV/m)		Polarization
	AV	PEAK		AV	PEAK	AV	PEAK	AV	PEAK	
-	-	-	-	-	-	-	-	-	-	Vertical
-	-	-	-	-	-	-	-	-	-	Horizontal

Note: 1. Emissions attenuated more than 20 dB below the permissible value are not reported.

2. *: Denotes restricted band of operation.

Date of Test:	July 28, 2012	Temperature:	25°C
EUT:	MC200Air	Humidity:	50%
Model No.:	MC200Air	Power Supply:	AC 120V/60HZ
Test Mode:	802.11b Channel Middle 2437MHz	Test Engineer:	Pei

For Below 30MHz

Frequency (MHz)	Reading (dBμV/m)		Factor(dB) Corr.	Result (dBμV/m)		Limit (dBμV/m)	Margin (dB)		Polarization
	QP			QP			QP		
-	-	-	-	-	-	-	-	-	X
-	-	-	-	-	-	-	-	-	Y
-	-	-	-	-	-	-	-	-	Z

For 30MHz-1000MHz

Corrected Factor = Antenna Factor + Cable Loss – Amplifier Gain

Frequency (MHz)	Reading (dBμV/m)		Factor Corr. (dB)	Result (dBμV/m)		Limit (dBμV/m)	Margin (dB)		Polarization
	QP			QP			QP		
319.2071	14.14		19.31	33.45		46.00	-12.55		Vertical
736.6209	11.91		27.47	39.38		46.00	-6.62		Vertical
779.2179	10.90		27.83	38.73		46.00	-7.27		Vertical
207.9261	21.30		16.28	37.58		43.50	-5.92		Horizontal
319.2071	18.46		19.31	37.77		46.00	-8.23		Horizontal
779.2179	13.47		27.83	41.30		46.00	-4.70		Horizontal

For 1GHz-25GHz

Corrected Factor = Antenna Factor + Cable Loss – Amplifier Gain

Frequency (MHz)	Reading(dBμV/m)		Factor Corr. (dB)	Result(dBμV/m)		Limit(dBμV/m)		Margin(dBμV/m)		Polarization
	AV	PEAK		AV	PEAK	AV	PEAK	AV	PEAK	
-	-	-	-	-	-	-	-	-	-	Vertical
-	-	-	-	-	-	-	-	-	-	Horizontal

Note: 1. Emissions attenuated more than 20 dB below the permissible value are not reported.**2. *: Denotes restricted band of operation.**

Date of Test:	July 28, 2012	Temperature:	25°C
EUT:	MC200Air	Humidity:	50%
Model No.:	MC200Air	Power Supply:	AC 120V/60HZ
Test Mode:	802.11b Channel High 2462MHz	Test Engineer:	Pei

For Below 30MHz

Frequency (MHz)	Reading (dBμV/m)		Factor(dB) Corr.	Result (dBμV/m)		Limit (dBμV/m)	Margin (dB)		Polarization
	QP			QP			QP		
-	-	-	-	-	-	-	-	-	X
-	-	-	-	-	-	-	-	-	Y
-	-	-	-	-	-	-	-	-	Z

For 30MHz-1000MHz

Corrected Factor = Antenna Factor + Cable Loss – Amplifier Gain

Frequency (MHz)	Reading (dBμV/m)		Factor Corr. (dB)	Result (dBμV/m)		Limit (dBμV/m)	Margin (dB)		Polarization
	QP			QP			QP		
319.2071	13.69		19.31	33.00		46.00	-13.00		Vertical
779.2179	11.55		27.83	39.38		46.00	-6.62		Vertical
868.8860	10.09		28.63	38.72		46.00	-7.28		Vertical
207.1968	20.24		16.25	36.49		43.50	-7.01		Horizontal
779.2179	13.33		27.83	41.16		46.00	-4.84		Horizontal
955.3509	13.27		29.63	42.90		46.00	-3.10		Horizontal

For 1GHz-25GHz

Corrected Factor = Antenna Factor + Cable Loss – Amplifier Gain

Frequency (MHz)	Reading(dBμV/m)		Factor Corr. (dB)	Result(dBμV/m)		Limit(dBμV/m)		Margin(dBμV/m)		Polarization
	AV	PEAK		AV	PEAK	AV	PEAK	AV	PEAK	
-	-	-	-	-	-	-	-	-	-	Vertical
-	-	-	-	-	-	-	-	-	-	Horizontal

Note: 1. Emissions attenuated more than 20 dB below the permissible value are not reported.**2. *: Denotes restricted band of operation.**

Date of Test:	July 28, 2012	Temperature:	25°C
EUT:	MC200Air	Humidity:	50%
Model No.:	MC200Air	Power Supply:	AC 120V/60HZ
Test Mode:	802.11g Channel Low 2412MHz	Test Engineer:	Pei

For Below 30MHz

Frequency (MHz)	Reading (dBμV/m)	Factor(dB) Corr.	Result (dBμV/m)	Limit (dBμV/m)	Margin (dB)	Polarization
	QP		QP	QP	QP	
-	-	-	-	-	-	X
-	-	-	-	-	-	Y
-	-	-	-	-	-	Z

For 30MHz-1000MHz

Corrected Factor = Antenna Factor + Cable Loss – Amplifier Gain

Frequency (MHz)	Reading (dBμV/m)	Factor Corr. (dB)	Result (dBμV/m)	Limit (dBμV/m)	Margin (dB)	Polarization
	QP		QP	QP	QP	
319.2071	12.42	19.31	31.73	46.00	-14.27	Vertical
617.9417	8.12	25.99	34.11	46.00	-11.89	Vertical
736.6209	13.43	27.47	40.90	46.00	-5.10	Vertical
310.3594	21.59	19.06	40.65	46.00	-5.35	Horizontal
736.6209	13.76	27.47	41.23	46.00	-4.77	Horizontal
955.3509	13.18	29.63	42.81	46.00	-3.19	Horizontal

For 1GHz-25GHz

Corrected Factor = Antenna Factor + Cable Loss – Amplifier Gain

Frequency (MHz)	Reading(dBμV/m)		Factor Corr. (dB)	Result(dBμV/m)		Limit(dBμV/m)		Margin(dBμV/m)		Polarization
	AV	PEAK		AV	PEAK	AV	PEAK	AV	PEAK	
-	-	-	-	-	-	-	-	-	-	Vertical
-	-	-	-	-	-	-	-	-	-	Horizontal

Note: 1. Emissions attenuated more than 20 dB below the permissible value are not reported.

2. *: Denotes restricted band of operation.

Date of Test:	July 28, 2012	Temperature:	25°C
EUT:	MC200Air	Humidity:	50%
Model No.:	MC200Air	Power Supply:	AC 120V/60HZ
Test Mode:	802.11g Channel Middle 2437MHz	Test Engineer:	Pei

For Below 30MHz

Frequency (MHz)	Reading (dBμV/m)		Factor(dB) Corr.	Result (dBμV/m)		Limit (dBμV/m)	Margin (dB)		Polarization
	QP			QP			QP		
-	-	-	-	-	-	-	-	-	X
-	-	-	-	-	-	-	-	-	Y
-	-	-	-	-	-	-	-	-	Z

For 30MHz-1000MHz

Corrected Factor = Antenna Factor + Cable Loss – Amplifier Gain

Frequency (MHz)	Reading (dBμV/m)		Factor Corr. (dB)	Result (dBμV/m)		Limit (dBμV/m)	Margin (dB)		Polarization
	QP			QP			QP		
246.1238	15.04		17.19	32.23		46.00	-13.77		Vertical
736.6209	12.25		27.47	39.72		46.00	-6.28		Vertical
868.8860	10.43		28.63	39.06		46.00	-6.94		Vertical
246.1238	22.39		17.19	39.58		46.00	-6.42		Horizontal
736.6209	12.99		27.47	40.46		46.00	-5.54		Horizontal
955.3509	10.45		29.63	40.08		46.00	-5.92		Horizontal

For 1GHz-25GHz

Corrected Factor = Antenna Factor + Cable Loss – Amplifier Gain

Frequency (MHz)	Reading(dBμV/m)		Factor Corr. (dB)	Result(dBμV/m)		Limit(dBμV/m)		Margin(dBμV/m)		Polarization
	AV	PEAK		AV	PEAK	AV	PEAK	AV	PEAK	
-	-	-	-	-	-	-	-	-	-	Vertical
-	-	-	-	-	-	-	-	-	-	Horizontal

Note: 1. Emissions attenuated more than 20 dB below the permissible value are not reported.**2. *: Denotes restricted band of operation.**

Date of Test:	July 28, 2012	Temperature:	25°C
EUT:	MC200Air	Humidity:	50%
Model No.:	MC200Air	Power Supply:	AC 120V/60HZ
Test Mode:	802.11g Channel High 2462MHz	Test Engineer:	Pei

For Below 30MHz

Frequency (MHz)	Reading (dBμV/m)		Factor(dB) Corr.	Result (dBμV/m)		Limit (dBμV/m)	Margin (dB)		Polarization
	QP			QP			QP		
-	-	-	-	-	-	-	-	-	X
-	-	-	-	-	-	-	-	-	Y
-	-	-	-	-	-	-	-	-	Z

For 30MHz-1000MHz

Corrected Factor = Antenna Factor + Cable Loss – Amplifier Gain

Frequency (MHz)	Reading (dBμV/m)		Factor Corr. (dB)	Result (dBμV/m)		Limit (dBμV/m)	Margin (dB)		Polarization
	QP			QP			QP		
319.2071	12.64		19.31	31.95		46.00	-14.05		Vertical
736.6209	11.88		27.47	39.35		46.00	-6.65		Vertical
868.8860	10.48		28.63	39.11		46.00	-6.89		Vertical
319.2071	19.75		19.31	39.06		46.00	-6.94		Horizontal
736.6209	14.23		27.47	41.70		46.00	-4.30		Horizontal
955.3509	12.99		29.63	42.62		46.00	-3.38		Horizontal

For 1GHz-25GHz

Corrected Factor = Antenna Factor + Cable Loss – Amplifier Gain

Frequency (MHz)	Reading(dBμV/m)		Factor Corr. (dB)	Result(dBμV/m)		Limit(dBμV/m)		Margin(dBμV/m)		Polarization
	AV	PEAK		AV	PEAK	AV	PEAK	AV	PEAK	
-	-	-	-	-	-	-	-	-	-	Vertical
-	-	-	-	-	-	-	-	-	-	Horizontal

Note: 1. Emissions attenuated more than 20 dB below the permissible value are not reported.**2. *: Denotes restricted band of operation.**



ACCURATE TECHNOLOGY CO., LTD.

F1,Bldg,A,Changyuan New Material Port Keyuan Rd,
Science & Industry Park,Nanshan Shenzhen,P.R.China

Site: 966 chamber
Tel:+86-0755-26503290
Fax:+86-0755-26503396

Job No.: Bob #1647	Polarization: Horizontal
Standard: FCC Class B 3M Radiated	Power Source: AC 120V/60Hz
Test item: Radiation Test	Date: 12/07/28/
Temp.(C)/Hum.(%) 24 C / 48 %	Time: 10/34/13
EUT: MC200Air	Engineer Signature:
Mode: TX Channel 1 (802.11b)	Distance: 3m
Model: MC200Air	
Manufacturer: Boston	

Note: Report NO.:ATE20120668

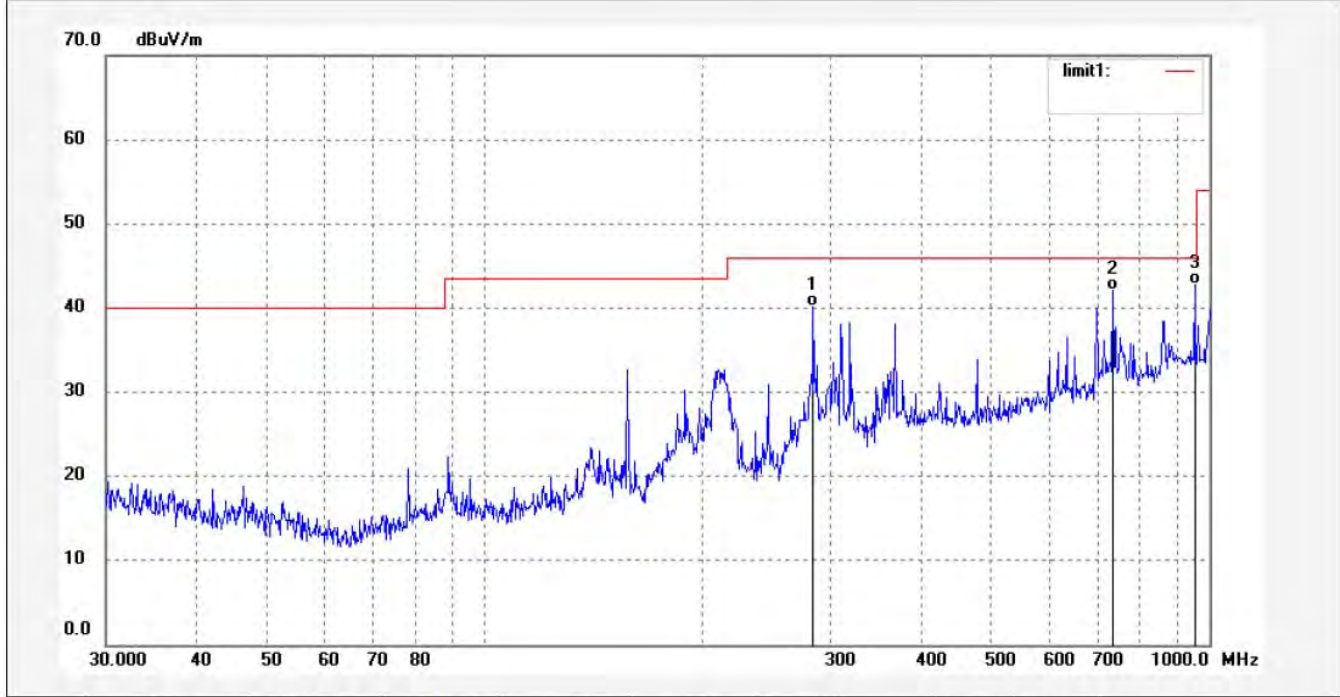

No.	Freq. (MHz)	Reading (dBuV/m)	Factor (dB)	Result (dBuV/m)	Limit (dBuV/m)	Margin (dB)	Detector	Height (cm)	Degree (deg.)	Remark
1	284.2606	21.76	18.42	40.18	46.00	-5.82	QP			
2	736.6209	14.66	27.47	42.13	46.00	-3.87	QP			
3	955.3509	13.08	29.63	42.71	46.00	-3.29	QP			



ACCURATE TECHNOLOGY CO., LTD.

F1,Bldg,A,Changyuan New Material Port Keyuan Rd,
Science & Industry Park,Nanshan Shenzhen,P.R.China

Site: 966 chamber
Tel:+86-0755-26503290
Fax:+86-0755-26503396

Job No.: Bob #1646
Standard: FCC Class B 3M Radiated
Test item: Radiation Test
Temp.(C)/Hum.(%) 24 C / 48 %
EUT: MC200Air
Mode: TX Channel 1 (802.11b)
Model: MC200Air
Manufacturer: Boston

Polarization: Vertical
Power Source: AC 120V/60Hz
Date: 12/07/28/
Time: 10/31/40
Engineer Signature:
Distance: 3m

Note: Report NO.:ATE20120668

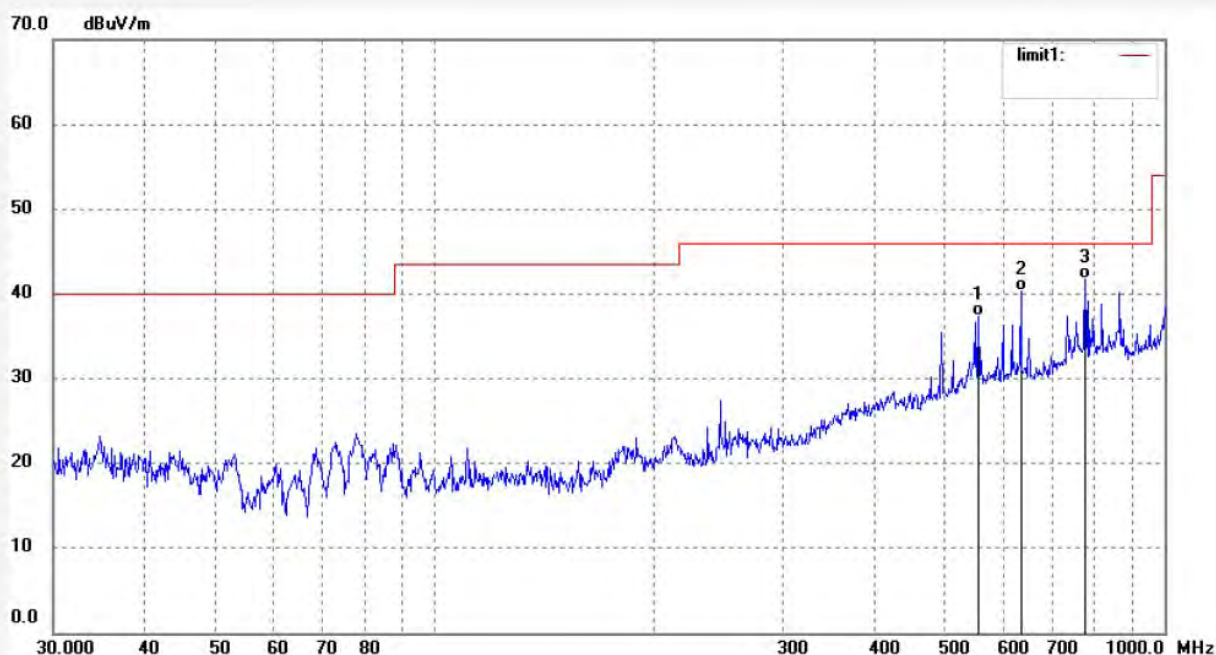

No.	Freq. (MHz)	Reading (dBuV/m)	Factor (dB)	Result (dBuV/m)	Limit (dBuV/m)	Margin (dB)	Detector	Height (cm)	Degree (deg.)	Remark
1	556.1214	11.97	25.34	37.31	46.00	-8.69	QP			
2	635.5576	14.28	26.07	40.35	46.00	-5.65	QP			
3	779.2179	13.89	27.83	41.72	46.00	-4.28	QP			



ACCURATE TECHNOLOGY CO., LTD.

F1,Bldg,A,Changyuan New Material Port Keyuan Rd,
Science & Industry Park,Nanshan Shenzhen,P.R.China

Site: 966 chamber
Tel:+86-0755-26503290
Fax:+86-0755-26503396

Job No.: Bob #1603
Standard: FCC Class B 3M Radiated
Test item: Radiation Test
Temp.(C)/Hum.(%) 24 C / 48 %
EUT: MC200Air
Mode: TX Channel 1 (802.11b)
Model: MC200Air
Manufacturer: Boston

Polarization: Horizontal
Power Source: AC 120V/60Hz
Date: 12/07/28/
Time: 8/52/55
Engineer Signature:
Distance: 3m

Note: Report NO.:ATE20120668

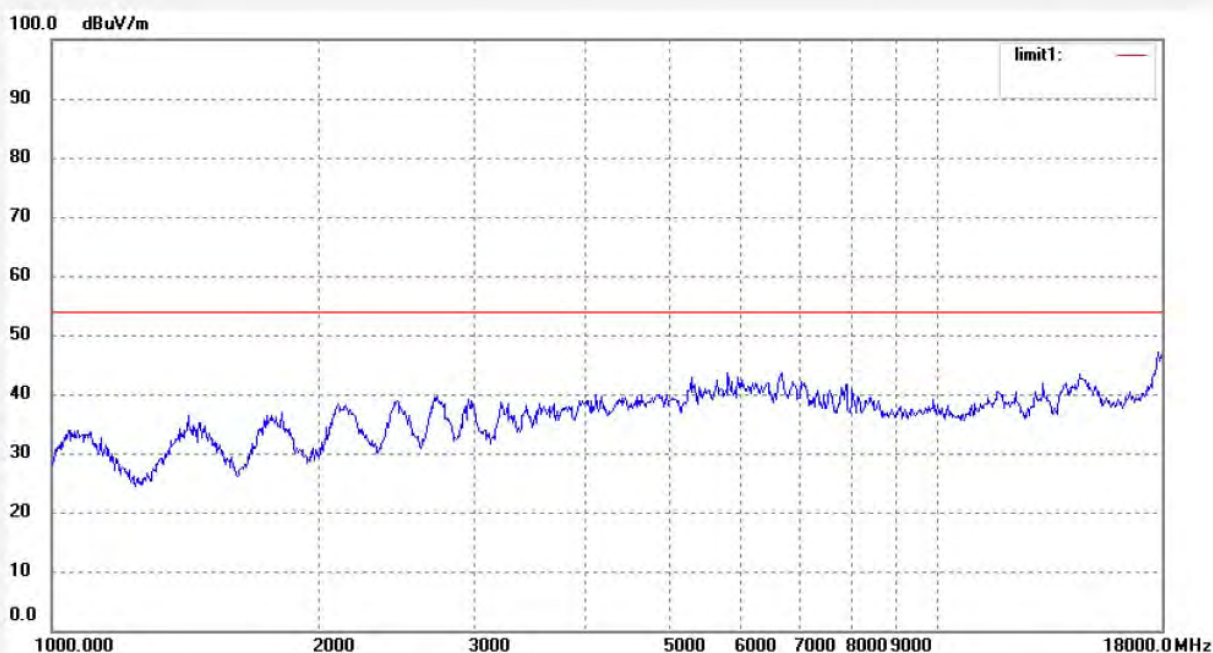

No.	Freq. (MHz)	Reading (dBuV/m)	Factor (dB)	Result (dBuV/m)	Limit (dBuV/m)	Margin (dB)	Detector	Height (cm)	Degree (deg.)	Remark
-----	-------------	------------------	-------------	-----------------	----------------	-------------	----------	-------------	---------------	--------



ACCURATE TECHNOLOGY CO., LTD.

F1,Bldg,A,Changyuan New Material Port Keyuan Rd,
Science & Industry Park,Nanshan Shenzhen,P.R.China

Site: 966 chamber
Tel:+86-0755-26503290
Fax:+86-0755-26503396

Job No.: Bob #1602	Polarization: Vertical
Standard: FCC Class B 3M Radiated	Power Source: AC 120V/60Hz
Test item: Radiation Test	Date: 12/07/28/
Temp.(C)/Hum.(%) 24 C / 48 %	Time: 8/51/27
EUT: MC200Air	Engineer Signature:
Mode: TX Channel 1 (802.11b)	Distance: 3m
Model: MC200Air	
Manufacturer: Boston	

Note: Report NO.:ATE20120668

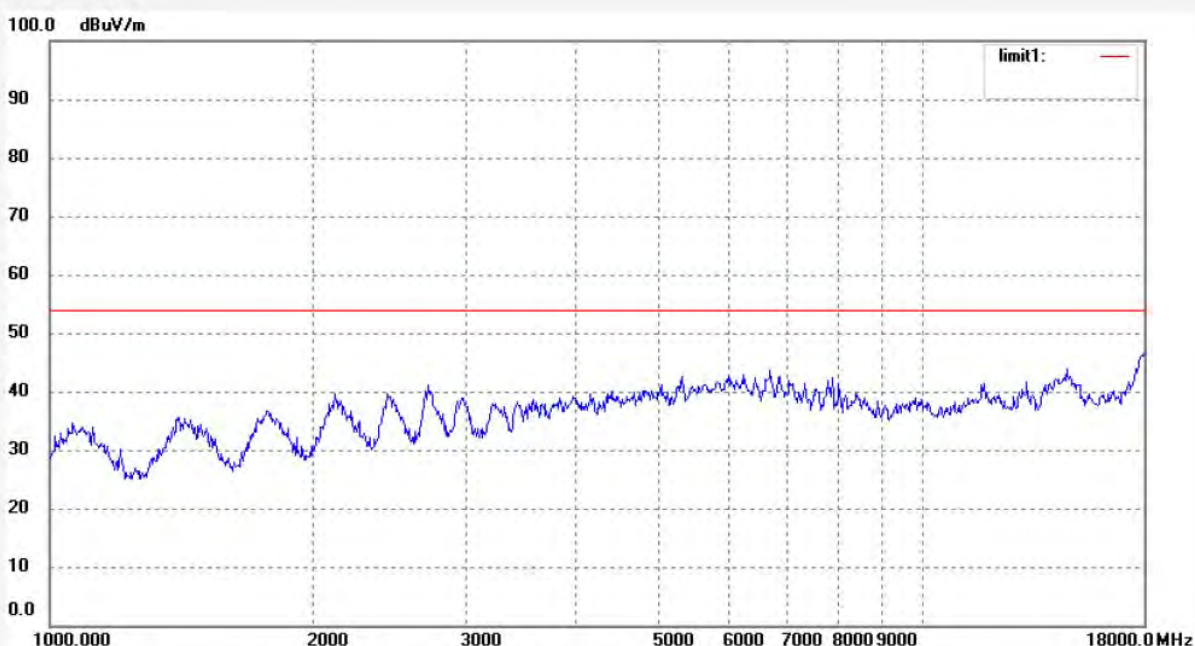

No.	Freq. (MHz)	Reading (dBuV/m)	Factor (dB)	Result (dBuV/m)	Limit (dBuV/m)	Margin (dB)	Detector	Height (cm)	Degree (deg.)	Remark
-----	-------------	------------------	-------------	-----------------	----------------	-------------	----------	-------------	---------------	--------



ACCURATE TECHNOLOGY CO., LTD.

F1,Bldg,A,Changyuan New Material Port Keyuan Rd,
Science & Industry Park,Nanshan Shenzhen,P.R.China

Site: 966 chamber
Tel:+86-0755-26503290
Fax:+86-0755-26503396

Job No.: Bob #1670	Polarization: Horizontal
Standard: FCC Class B 3M Radiated	Power Source: AC 120V/60Hz
Test item: Radiation Test	Date: 12/07/28/
Temp.(C)/Hum.(%) 25 C / 50 %	Time: 11:07:15
EUT: MC200Air	Engineer Signature: Bob
Mode: TX Channel 1 (802.11b)	Distance: 3m
Model: MC200Air	
Manufacturer: Boston	

Note: Report No.:ATE20120668

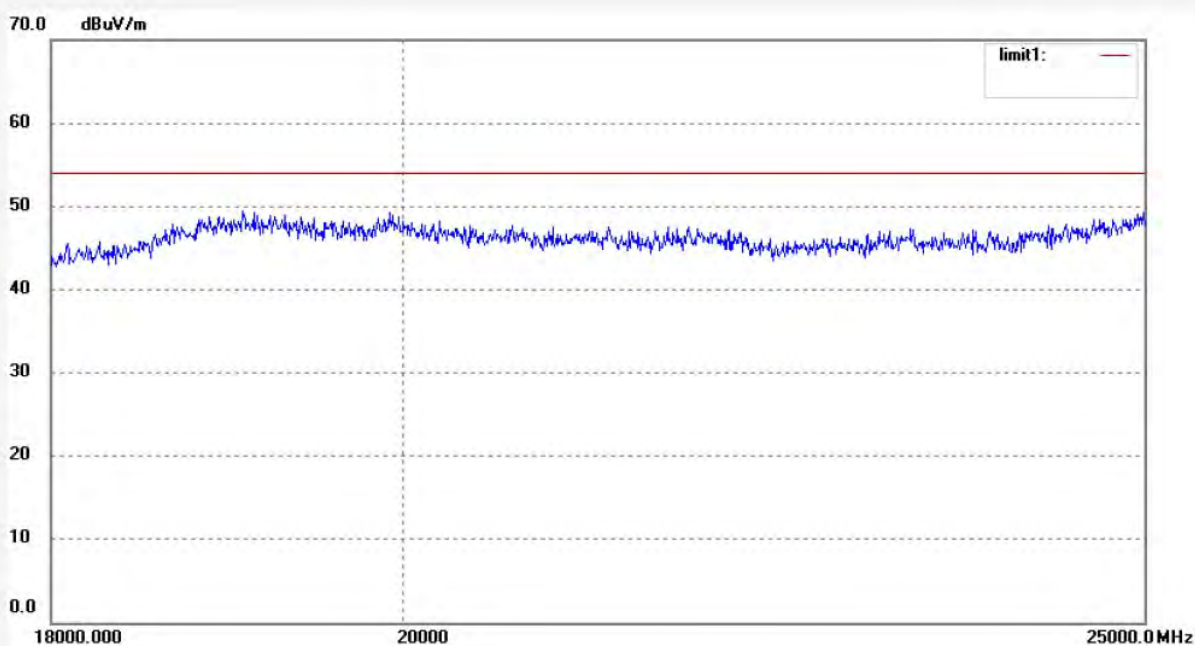

No.	Freq. (MHz)	Reading (dBuV/m)	Factor (dB)	Result (dBuV/m)	Limit (dBuV/m)	Margin (dB)	Detector	Height (cm)	Degree (deg.)	Remark
-----	-------------	------------------	-------------	-----------------	----------------	-------------	----------	-------------	---------------	--------



ACCURATE TECHNOLOGY CO., LTD.

F1,Bldg,A,Changyuan New Material Port Keyuan Rd,
Science & Industry Park,Nanshan Shenzhen,P.R.China

Site: 966 chamber
Tel:+86-0755-26503290
Fax:+86-0755-26503396

Job No.: Bob #1671	Polarization: Vertical
Standard: FCC Class B 3M Radiated	Power Source: AC 120V/60Hz
Test item: Radiation Test	Date: 12/07/28/
Temp.(C)/Hum.(%) 25 C / 50 %	Time: 11:09:22
EUT: MC200Air	Engineer Signature: Bob
Mode: TX Channel 1 (802.11b)	Distance: 3m
Model: MC200Air	
Manufacturer: Boston	

Note: Report No.:ATE20120668

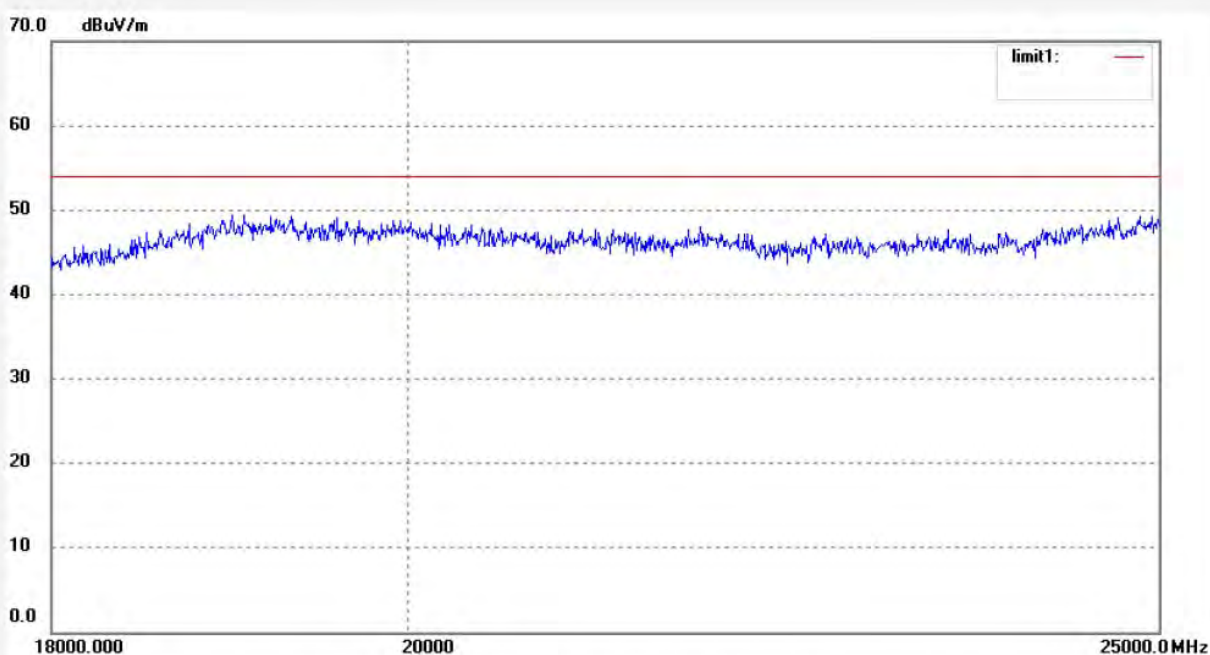

No.	Freq. (MHz)	Reading (dBuV/m)	Factor (dB)	Result (dBuV/m)	Limit (dBuV/m)	Margin (dB)	Detector	Height (cm)	Degree (deg.)	Remark
-----	-------------	------------------	-------------	-----------------	----------------	-------------	----------	-------------	---------------	--------



ACCURATE TECHNOLOGY CO., LTD.

F1,Bldg,A,Changyuan New Material Port Keyuan Rd,
Science & Industry Park,Nanshan Shenzhen,P.R.China

Site: 966 chamber
Tel:+86-0755-26503290
Fax:+86-0755-26503396

Job No.: Bob #1652	Polarization: Horizontal
Standard: FCC Class B 3M Radiated	Power Source: AC 120V/60Hz
Test item: Radiation Test	Date: 12/07/28/
Temp.(C)/Hum.(%) 24 C / 48 %	Time: 10/49/13
EUT: MC200Air	Engineer Signature:
Mode: TX Channel 6 (802.11b)	Distance: 3m
Model: MC200Air	
Manufacturer: Boston	

Note: Report NO.:ATE20120668

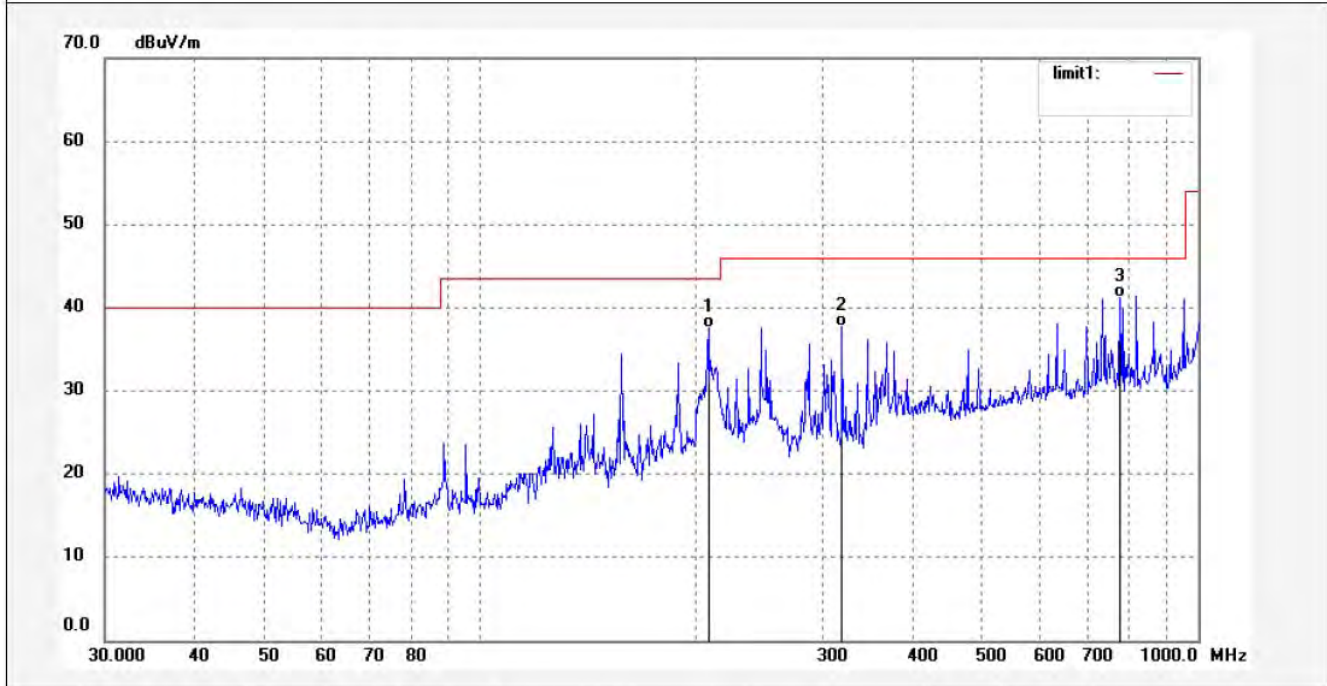

No.	Freq. (MHz)	Reading (dBuV/m)	Factor (dB)	Result (dBuV/m)	Limit (dBuV/m)	Margin (dB)	Detector	Height (cm)	Degree (deg.)	Remark
1	207.9261	21.30	16.28	37.58	43.50	-5.92	QP			
2	319.2071	18.46	19.31	37.77	46.00	-8.23	QP			
3	779.2179	13.47	27.83	41.30	46.00	-4.70	QP			



ACCURATE TECHNOLOGY CO., LTD.

F1,Bldg,A,Changyuan New Material Port Keyuan Rd,
Science & Industry Park,Nanshan Shenzhen,P.R.China

Site: 966 chamber
Tel:+86-0755-26503290
Fax:+86-0755-26503396

Job No.: Bob #1653	Polarization: Vertical
Standard: FCC Class B 3M Radiated	Power Source: AC 120V/60Hz
Test item: Radiation Test	Date: 12/07/28/
Temp.(C)/Hum.(%) 24 C / 48 %	Time: 10/52/03
EUT: MC200Air	Engineer Signature:
Mode: TX Channel 6 (802.11b)	Distance: 3m
Model: MC200Air	
Manufacturer: Boston	

Note: Report NO.:ATE20120668

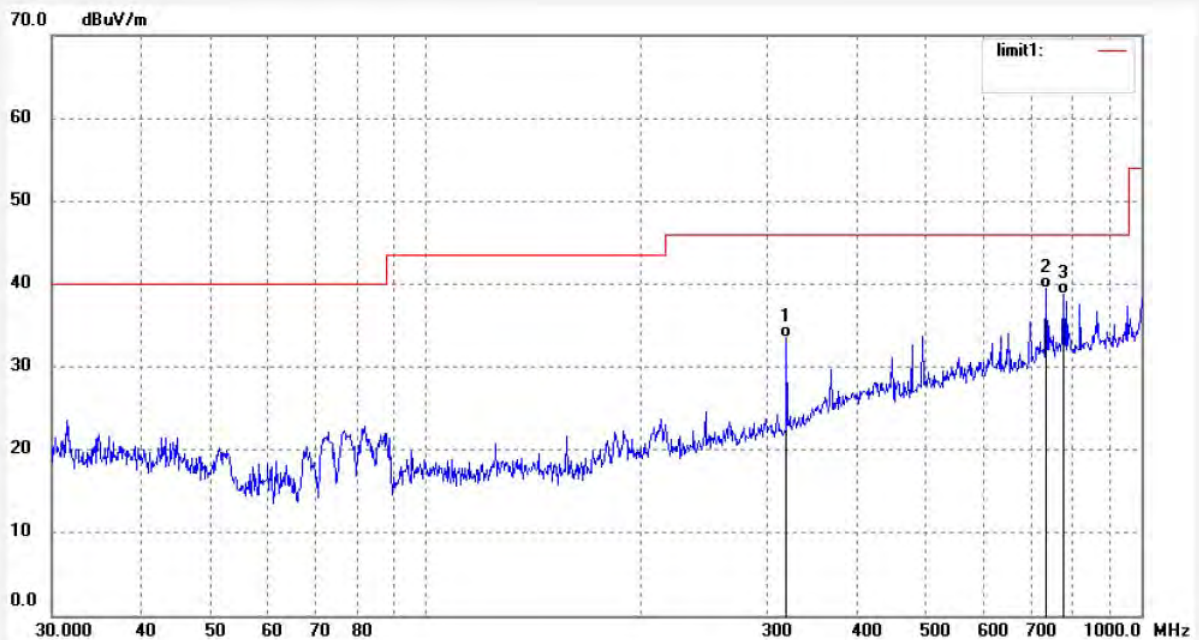

No.	Freq. (MHz)	Reading (dBuV/m)	Factor (dB)	Result (dBuV/m)	Limit (dBuV/m)	Margin (dB)	Detector	Height (cm)	Degree (deg.)	Remark
1	319.2071	14.14	19.31	33.45	46.00	-12.55	QP			
2	736.6209	11.91	27.47	39.38	46.00	-6.62	QP			
3	779.2179	10.90	27.83	38.73	46.00	-7.27	QP			



ACCURATE TECHNOLOGY CO., LTD.

F1,Bldg.A,Changyuan New Material Port Keyuan Rd,
Science & Industry Park,Nanshan Shenzhen,P.R.China

Site: 966 chamber
Tel:+86-0755-26503290
Fax:+86-0755-26503396

Job No.: Bob #1607	Polarization: Horizontal
Standard: FCC Class B 3M Radiated	Power Source: AC 120V/60Hz
Test item: Radiation Test	Date: 12/07/28/
Temp.(C)/Hum.(%) 24 C / 48 %	Time: 8/58/56
EUT: MC200Air	Engineer Signature:
Mode: TX Channel 6 (802.11b)	Distance: 3m
Model: MC200Air	
Manufacturer: Boston	

Note: Report NO.:ATE20120668

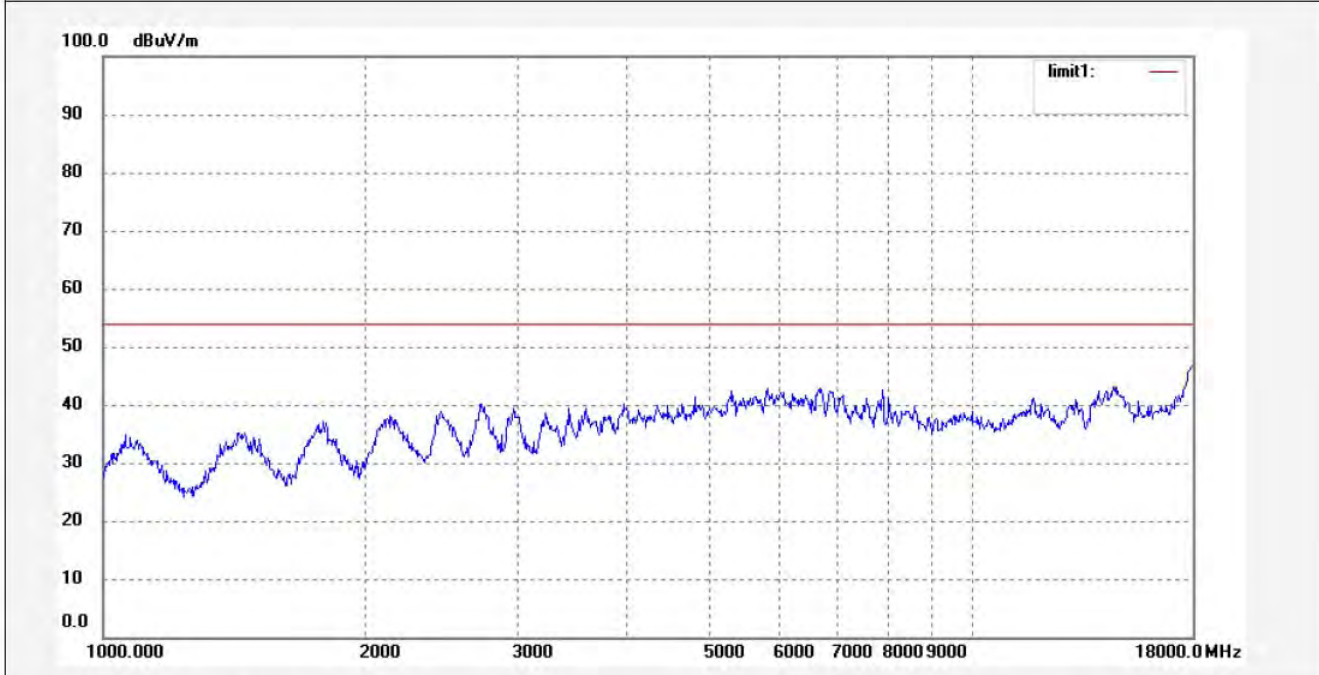

No.	Freq. (MHz)	Reading (dBuV/m)	Factor (dB)	Result (dBuV/m)	Limit (dBuV/m)	Margin (dB)	Detector	Height (cm)	Degree (deg.)	Remark
-----	-------------	------------------	-------------	-----------------	----------------	-------------	----------	-------------	---------------	--------



ACCURATE TECHNOLOGY CO., LTD.

F1,Bldg,A,Changyuan New Material Port Keyuan Rd,
Science & Industry Park,Nanshan Shenzhen,P.R.China

Site: 966 chamber
Tel:+86-0755-26503290
Fax:+86-0755-26503396

Job No.: Bob #1606	Polarization: Vertical
Standard: FCC Class B 3M Radiated	Power Source: AC 120V/60Hz
Test item: Radiation Test	Date: 12/07/28/
Temp.(C)/Hum.(%) 24 C / 48 %	Time: 8/57/32
EUT: MC200Air	Engineer Signature:
Mode: TX Channel 6 (802.11b)	Distance: 3m
Model: MC200Air	
Manufacturer: Boston	

Note: Report NO.:ATE20120668

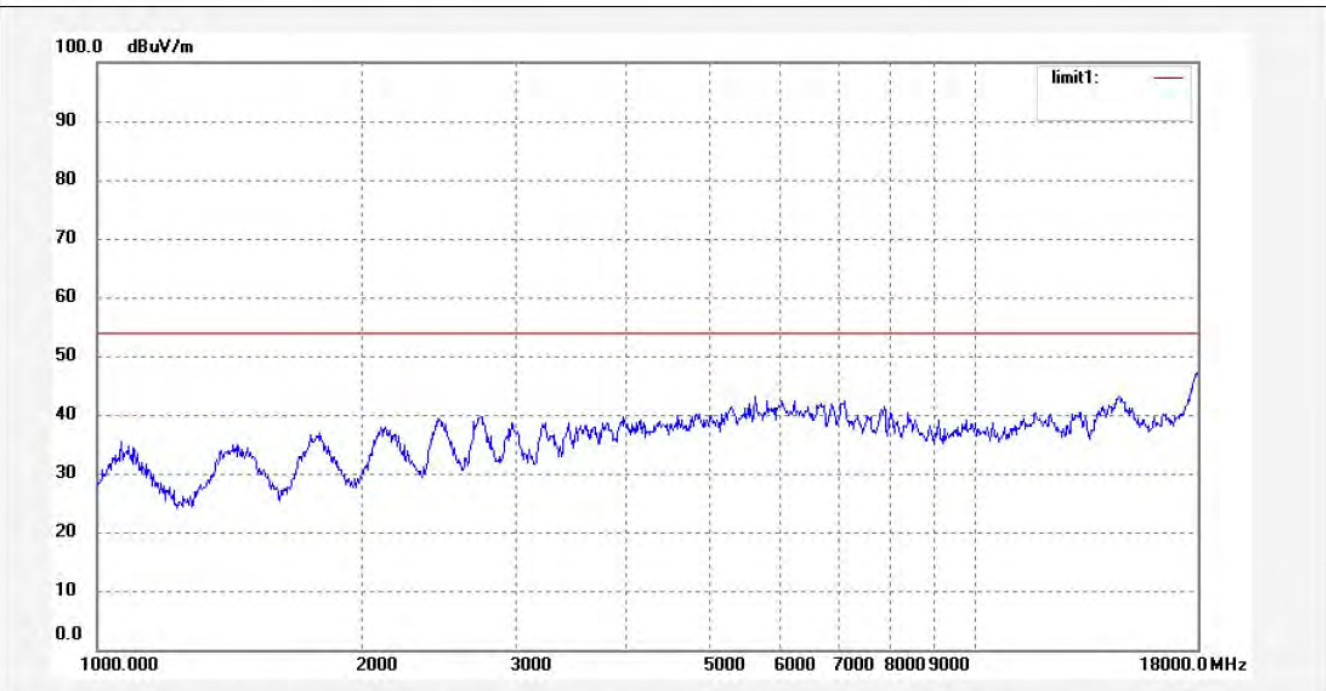

No.	Freq. (MHz)	Reading (dBuV/m)	Factor (dB)	Result (dBuV/m)	Limit (dBuV/m)	Margin (dB)	Detector	Height (cm)	Degree (deg.)	Remark
-----	-------------	------------------	-------------	-----------------	----------------	-------------	----------	-------------	---------------	--------



ACCURATE TECHNOLOGY CO., LTD.

F1,Bldg,A,Changyuan New Material Port Keyuan Rd,
Science & Industry Park,Nanshan Shenzhen,P.R.China

Site: 966 chamber
Tel:+86-0755-26503290
Fax:+86-0755-26503396

Job No.: Bob #1673	Polarization: Horizontal
Standard: FCC Class B 3M Radiated	Power Source: AC 120V/60Hz
Test item: Radiation Test	Date: 12/07/28/
Temp.(C)/Hum.(%) 25 C / 50 %	Time: 11:18:36
EUT: MC200Air	Engineer Signature: Bob
Mode: TX Channel 6 (802.11b)	Distance: 3m
Model: MC200Air	
Manufacturer: Boston	

Note: Report No.:ATE20120668

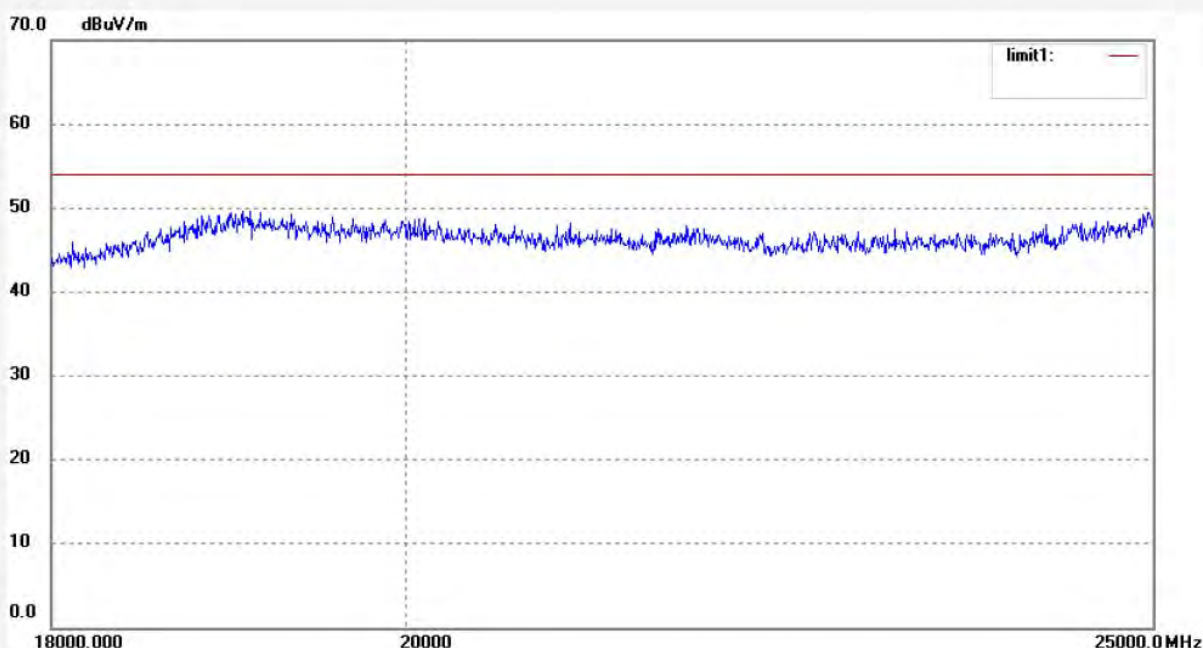

No.	Freq. (MHz)	Reading (dBuV/m)	Factor (dB)	Result (dBuV/m)	Limit (dBuV/m)	Margin (dB)	Detector	Height (cm)	Degree (deg.)	Remark
-----	-------------	------------------	-------------	-----------------	----------------	-------------	----------	-------------	---------------	--------



ACCURATE TECHNOLOGY CO., LTD.

F1,Bldg,A,Changyuan New Material Port Keyuan Rd,
Science & Industry Park,Nanshan Shenzhen,P.R.China

Site: 966 chamber
Tel:+86-0755-26503290
Fax:+86-0755-26503396

Job No.: Bob #1672	Polarization: Vertical
Standard: FCC Class B 3M Radiated	Power Source: AC 120V/60Hz
Test item: Radiation Test	Date: 12/07/28/
Temp.(C)/Hum.(%) 25 C / 50 %	Time: 11:14:45
EUT: MC200Air	Engineer Signature: Bob
Mode: TX Channel 6 (802.11b)	Distance: 3m
Model: MC200Air	
Manufacturer: Boston	

Note: Report No.:ATE20120668

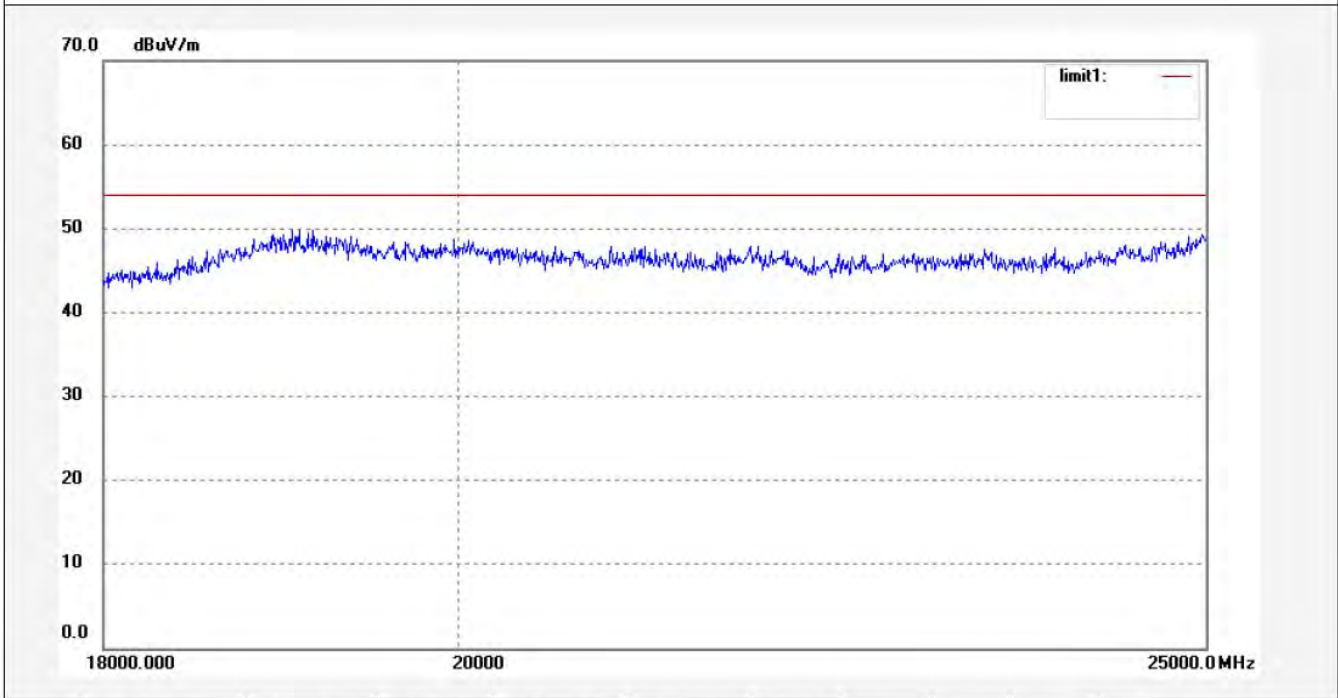

No.	Freq. (MHz)	Reading (dBuV/m)	Factor (dB)	Result (dBuV/m)	Limit (dBuV/m)	Margin (dB)	Detector	Height (cm)	Degree (deg.)	Remark
-----	-------------	------------------	-------------	-----------------	----------------	-------------	----------	-------------	---------------	--------



ACCURATE TECHNOLOGY CO., LTD.

F1,Bldg,A,Changyuan New Material Port Keyuan Rd,
Science & Industry Park,Nanshan Shenzhen,P.R.China

Site: 966 chamber
Tel:+86-0755-26503290
Fax:+86-0755-26503396

Job No.: Bob #1655	Polarization: Horizontal
Standard: FCC Class B 3M Radiated	Power Source: AC 120V/60Hz
Test item: Radiation Test	Date: 12/07/28/
Temp.(C)/Hum.(%) 24 C / 48 %	Time: 10/58/12
EUT: MC200Air	Engineer Signature:
Mode: TX Channel 11 (802.11b)	Distance: 3m
Model: MC200Air	
Manufacturer: Boston	

Note: Report NO.:ATE20120668

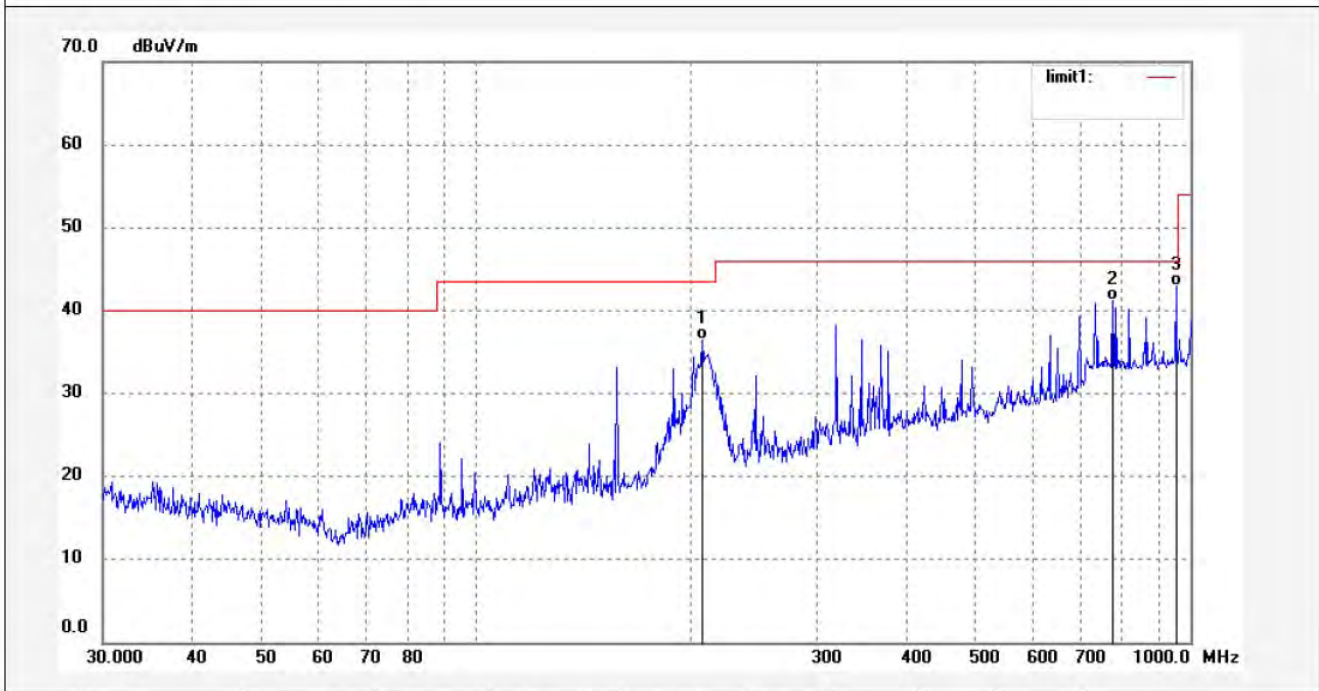

No.	Freq. (MHz)	Reading (dBuV/m)	Factor (dB)	Result (dBuV/m)	Limit (dBuV/m)	Margin (dB)	Detector	Height (cm)	Degree (deg.)	Remark
1	207.1968	20.24	16.25	36.49	43.50	-7.01	QP			
2	779.2179	13.33	27.83	41.16	46.00	-4.84	QP			
3	955.3509	13.27	29.63	42.90	46.00	-3.10	QP			



ACCURATE TECHNOLOGY CO., LTD.

F1,Bldg,A,Changyuan New Material Port Keyuan Rd,
Science & Industry Park,Nanshan Shenzhen,P.R.China

Site: 966 chamber
Tel:+86-0755-26503290
Fax:+86-0755-26503396

Job No.: Bob #1654
Standard: FCC Class B 3M Radiated
Test item: Radiation Test
Temp.(C)/Hum.(%) 24 C / 48 %
EUT: MC200Air
Mode: TX Channel 11 (802.11b)
Model: MC200Air
Manufacturer: Boston

Polarization: Vertical
Power Source: AC 120V/60Hz
Date: 12/07/28/
Time: 10/55/36
Engineer Signature:
Distance: 3m

Note: Report NO.:ATE20120668

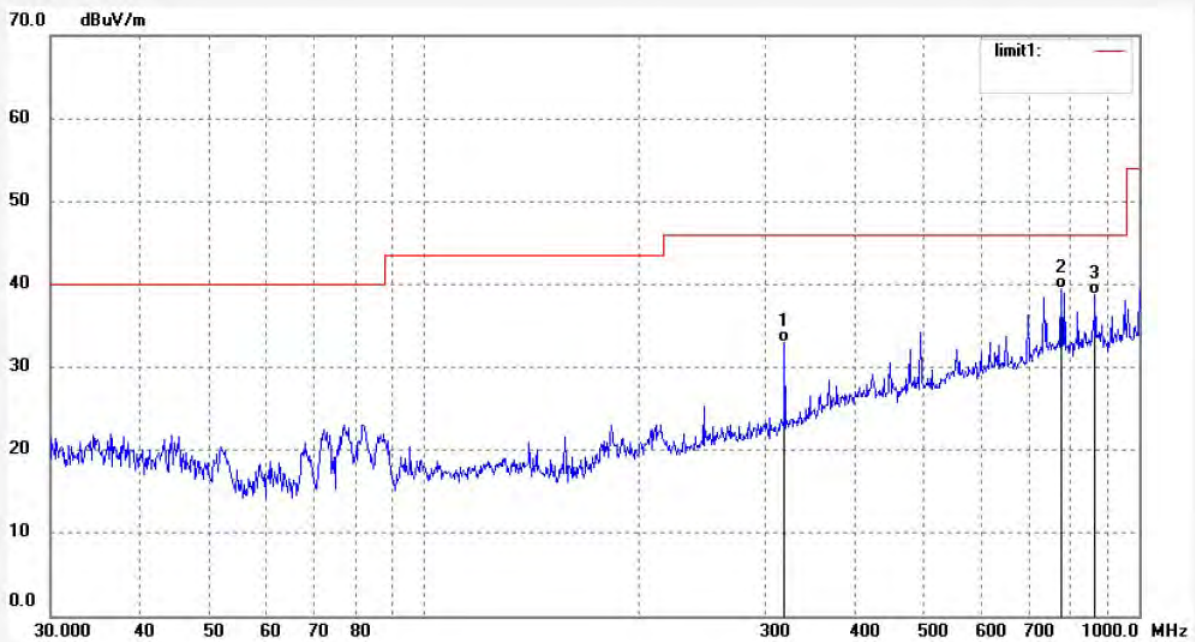

No.	Freq. (MHz)	Reading (dBuV/m)	Factor (dB)	Result (dBuV/m)	Limit (dBuV/m)	Margin (dB)	Detector	Height (cm)	Degree (deg.)	Remark
1	319.2071	13.69	19.31	33.00	46.00	-13.00	QP			
2	779.2179	11.55	27.83	39.38	46.00	-6.62	QP			
3	868.8860	10.09	28.63	38.72	46.00	-7.28	QP			



ACCURATE TECHNOLOGY CO., LTD.

F1,Bldg,A,Changyuan New Material Port Keyuan Rd,
Science & Industry Park,Nanshan Shenzhen,P.R.China

Site: 966 chamber
Tel:+86-0755-26503290
Fax:+86-0755-26503396

Job No.: Bob #1611	Polarization: Horizontal
Standard: FCC Class B 3M Radiated	Power Source: AC 120V/60Hz
Test item: Radiation Test	Date: 12/07/28/
Temp.(C)/Hum.(%) 24 C / 48 %	Time: 9/05/21
EUT: MC200Air	Engineer Signature:
Mode: TX Channel 11 (802.11b)	Distance: 3m
Model: MC200Air	
Manufacturer: Boston	

Note: Report NO.:ATE20120668

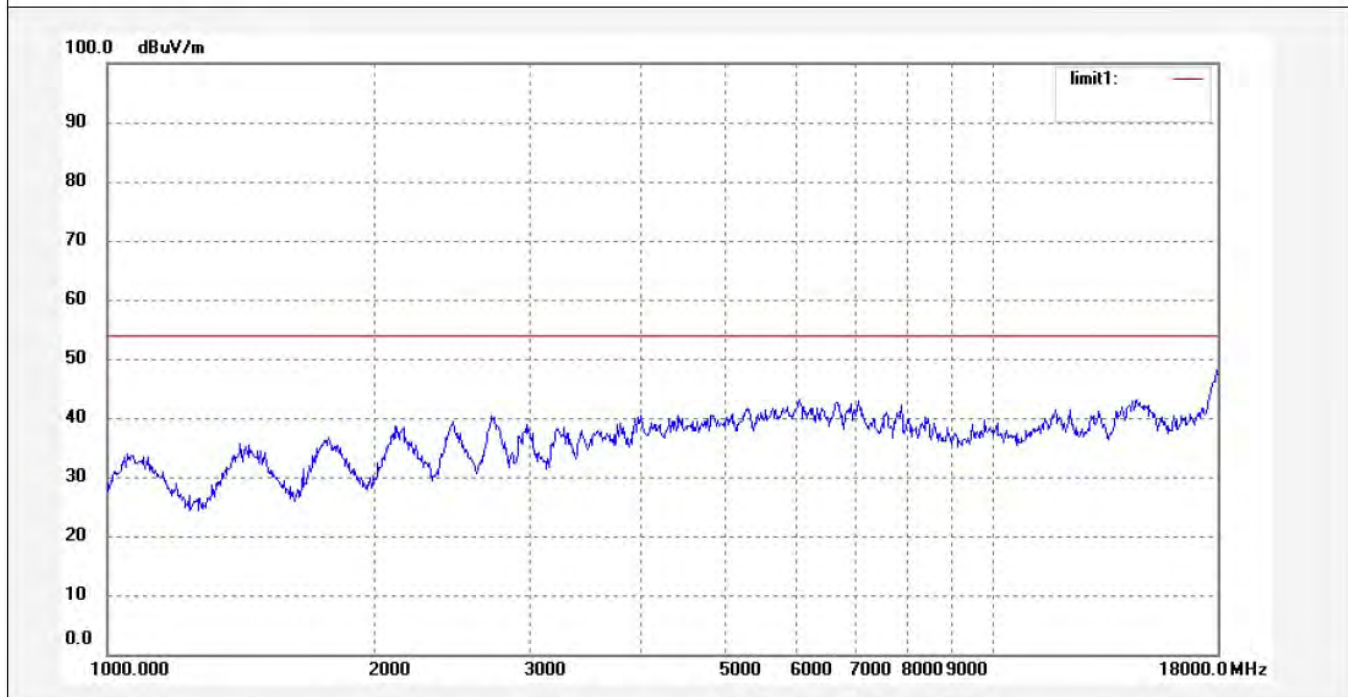

No.	Freq. (MHz)	Reading (dBuV/m)	Factor (dB)	Result (dBuV/m)	Limit (dBuV/m)	Margin (dB)	Detector	Height (cm)	Degree (deg.)	Remark
-----	-------------	------------------	-------------	-----------------	----------------	-------------	----------	-------------	---------------	--------



ACCURATE TECHNOLOGY CO., LTD.

F1,Bldg,A,Changyuan New Material Port Keyuan Rd,
Science & Industry Park,Nanshan Shenzhen,P.R.China

Site: 966 chamber
Tel:+86-0755-26503290
Fax:+86-0755-26503396

Job No.: Bob #1610	Polarization: Vertical
Standard: FCC Class B 3M Radiated	Power Source: AC 120V/60Hz
Test item: Radiation Test	Date: 12/07/28/
Temp.(C)/Hum.(%) 24 C / 48 %	Time: 9/03/56
EUT: MC200Air	Engineer Signature:
Mode: TX Channel 11 (802.11b)	Distance: 3m
Model: MC200Air	
Manufacturer: Boston	

Note: Report NO.:ATE20120668

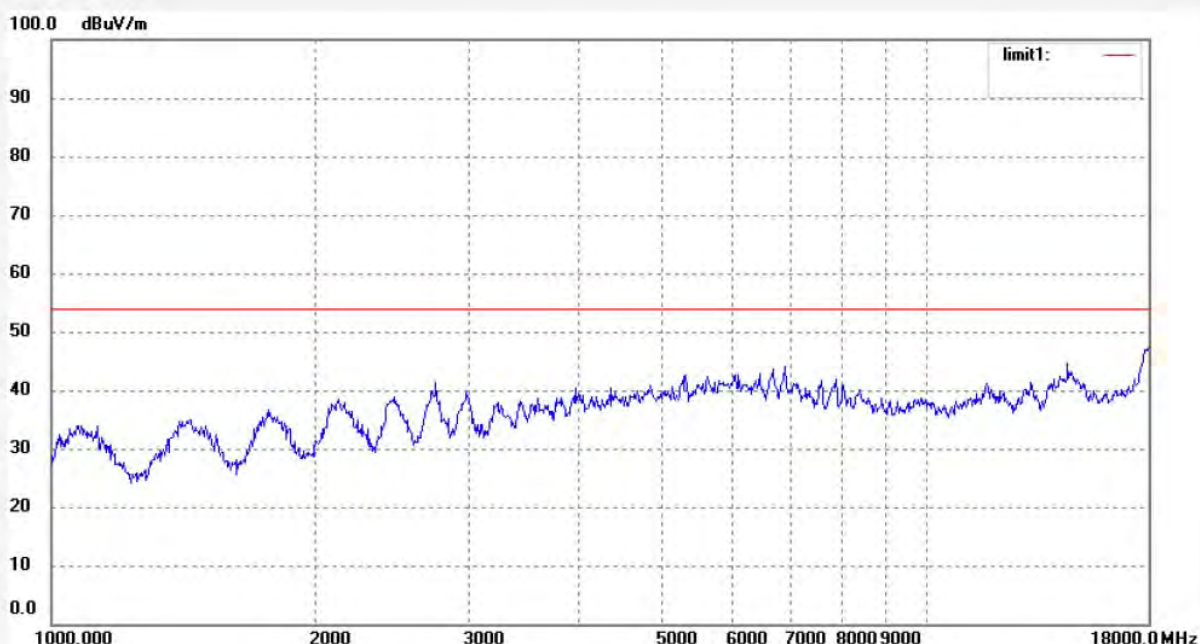

No.	Freq. (MHz)	Reading (dBuV/m)	Factor (dB)	Result (dBuV/m)	Limit (dBuV/m)	Margin (dB)	Detector	Height (cm)	Degree (deg.)	Remark
-----	-------------	------------------	-------------	-----------------	----------------	-------------	----------	-------------	---------------	--------



ACCURATE TECHNOLOGY CO., LTD.

F1,Bldg,A,Changyuan New Material Port Keyuan Rd,
Science & Industry Park,Nanshan Shenzhen,P.R.China

Site: 966 chamber
Tel:+86-0755-26503290
Fax:+86-0755-26503396

Job No.: Bob #1674	Polarization: Horizontal
Standard: FCC Class B 3M Radiated	Power Source: AC 120V/60Hz
Test item: Radiation Test	Date: 12/07/28/
Temp.(C)/Hum.(%) 25 C / 50 %	Time: 11:23:55
EUT: MC200Air	Engineer Signature: Bob
Mode: TX Channel 11 (802.11b)	Distance: 3m
Model: MC200Air	
Manufacturer: Boston	

Note: Report No.:ATE20120668

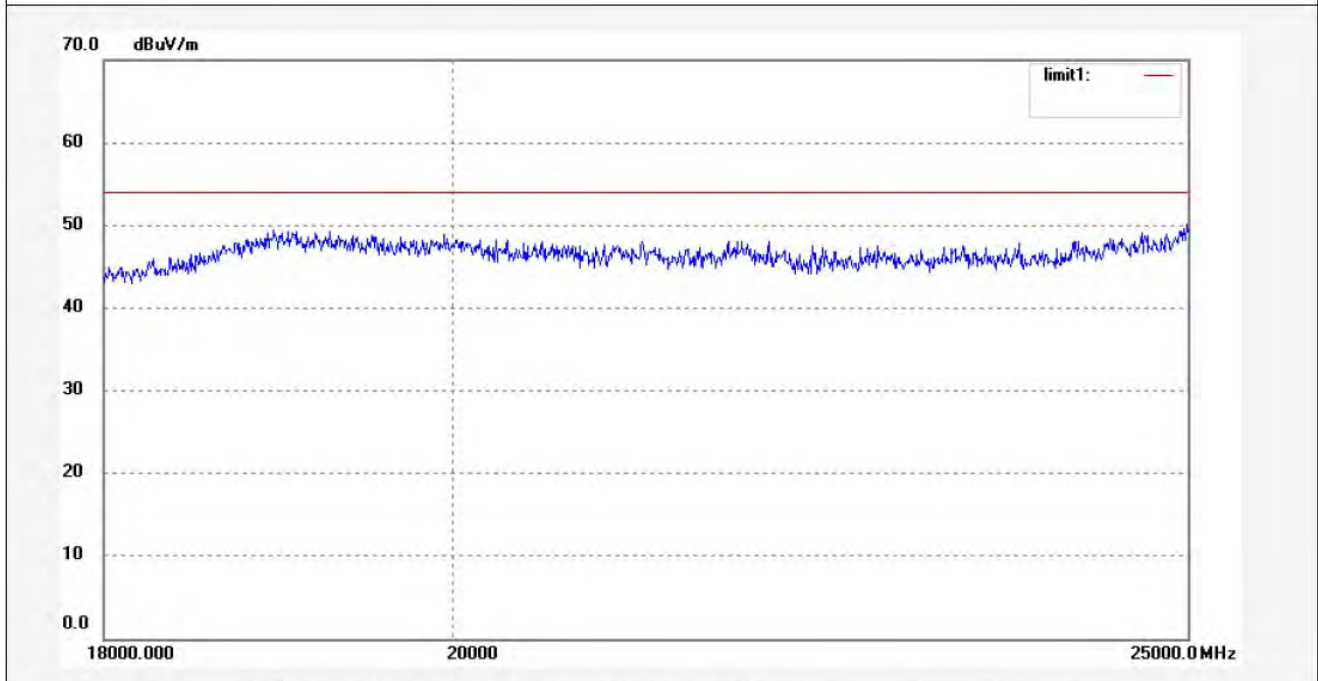

No.	Freq. (MHz)	Reading (dBuV/m)	Factor (dB)	Result (dBuV/m)	Limit (dBuV/m)	Margin (dB)	Detector	Height (cm)	Degree (deg.)	Remark
-----	-------------	------------------	-------------	-----------------	----------------	-------------	----------	-------------	---------------	--------



ACCURATE TECHNOLOGY CO., LTD.

F1,Bldg,A,Changyuan New Material Port Keyuan Rd,
Science & Industry Park,Nanshan Shenzhen,P.R.China

Site: 966 chamber
Tel:+86-0755-26503290
Fax:+86-0755-26503396

Job No.: Bob #1675
Standard: FCC Class B 3M Radiated
Test item: Radiation Test
Temp.(C)/Hum.(%) 25 C / 50 %
EUT: MC200Air
Mode: TX Channel 11 (802.11b)
Model: MC200Air
Manufacturer: Boston

Polarization: Vertical
Power Source: AC 120V/60Hz
Date: 12/07/28/
Time: 11:27:11
Engineer Signature: Bob
Distance: 3m

Note: Report No.:ATE20120668

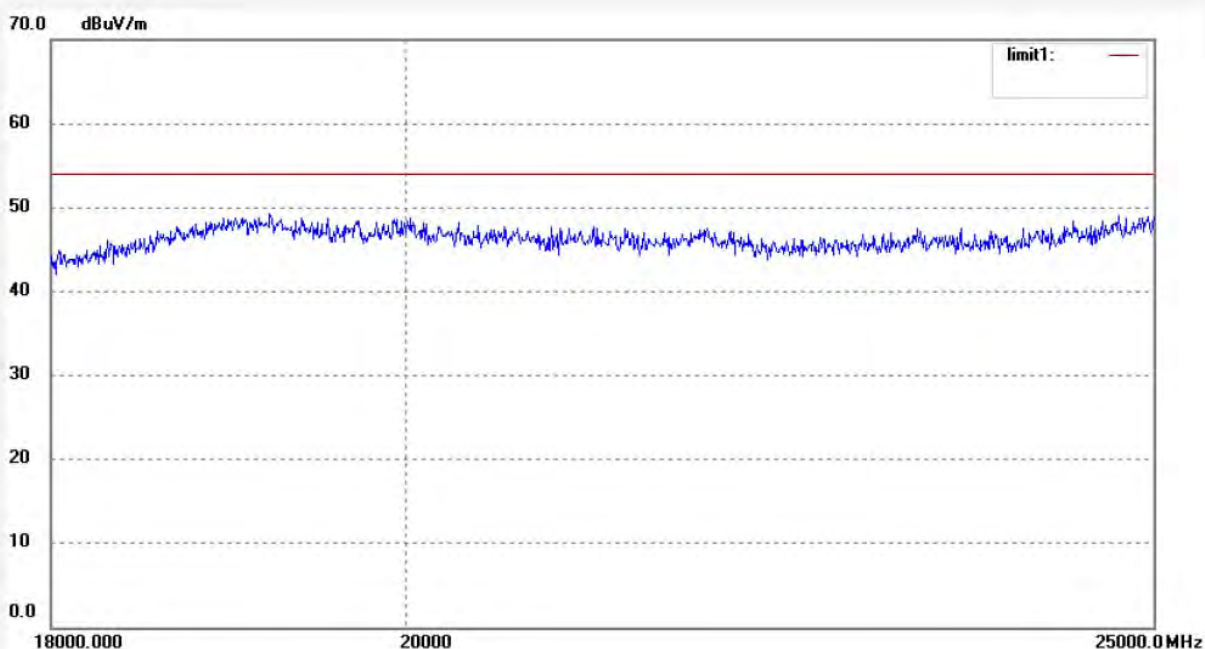

No.	Freq. (MHz)	Reading (dBuV/m)	Factor (dB)	Result (dBuV/m)	Limit (dBuV/m)	Margin (dB)	Detector	Height (cm)	Degree (deg.)	Remark
-----	-------------	------------------	-------------	-----------------	----------------	-------------	----------	-------------	---------------	--------



ACCURATE TECHNOLOGY CO., LTD.

F1,Bldg,A,Changyuan New Material Port Keyuan Rd,
Science & Industry Park,Nanshan Shenzhen,P.R.China

Site: 966 chamber
Tel:+86-0755-26503290
Fax:+86-0755-26503396

Job No.: Bob #1648	Polarization: Horizontal
Standard: FCC Class B 3M Radiated	Power Source: AC 120V/60Hz
Test item: Radiation Test	Date: 12/07/28/
Temp.(C)/Hum.(%) 24 C / 48 %	Time: 10/37/46
EUT: MC200Air	Engineer Signature:
Mode: TX Channel 1 (802.11g)	Distance: 3m
Model: MC200Air	
Manufacturer: Boston	

Note: Report NO.:ATE20120668

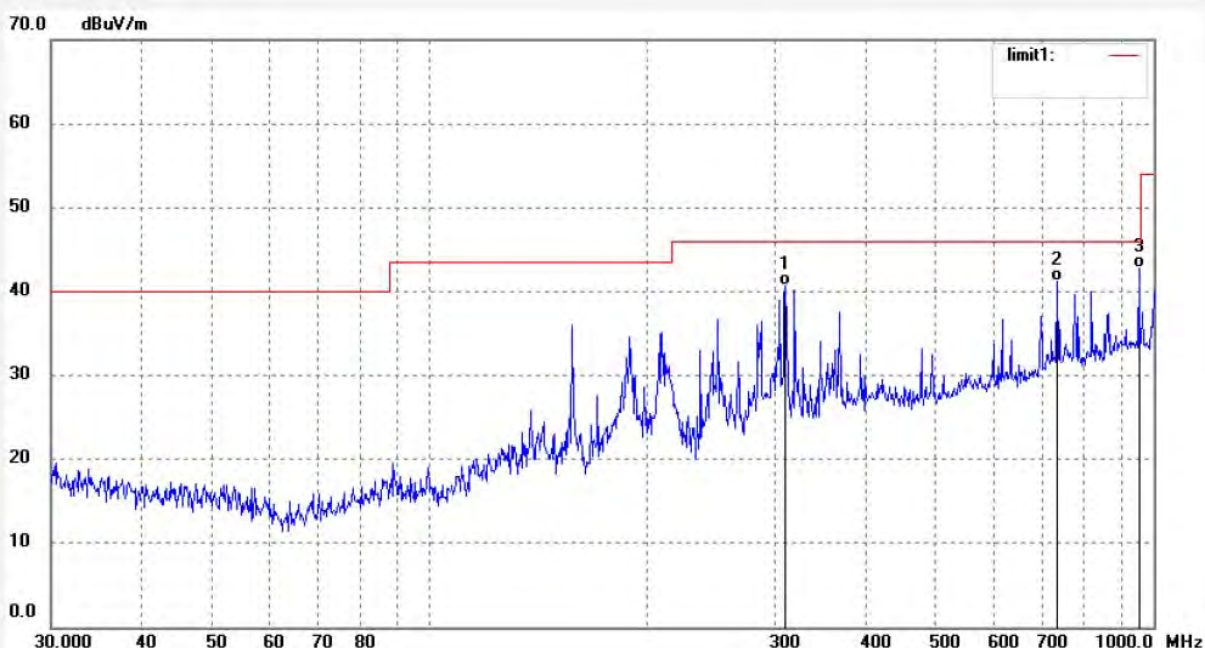

No.	Freq. (MHz)	Reading (dBuV/m)	Factor (dB)	Result (dBuV/m)	Limit (dBuV/m)	Margin (dB)	Detector	Height (cm)	Degree (deg.)	Remark
1	310.3594	21.59	19.06	40.65	46.00	-5.35	QP			
2	736.6209	13.76	27.47	41.23	46.00	-4.77	QP			
3	955.3509	13.18	29.63	42.81	46.00	-3.19	QP			



ACCURATE TECHNOLOGY CO., LTD.

F1,Bldg,A,Changyuan New Material Port Keyuan Rd,
Science & Industry Park,Nanshan Shenzhen,P.R.China

Site: 966 chamber
Tel:+86-0755-26503290
Fax:+86-0755-26503396

Job No.: Bob #1649
Standard: FCC Class B 3M Radiated
Test item: Radiation Test
Temp.(C)/Hum.(%) 24 C / 48 %
EUT: MC200Air
Mode: TX Channel 1 (802.11g)
Model: MC200Air
Manufacturer: Boston

Polarization: Vertical
Power Source: AC 120V/60Hz
Date: 12/07/28/
Time: 10/40/47
Engineer Signature:
Distance: 3m

Note: Report NO.:ATE20120668

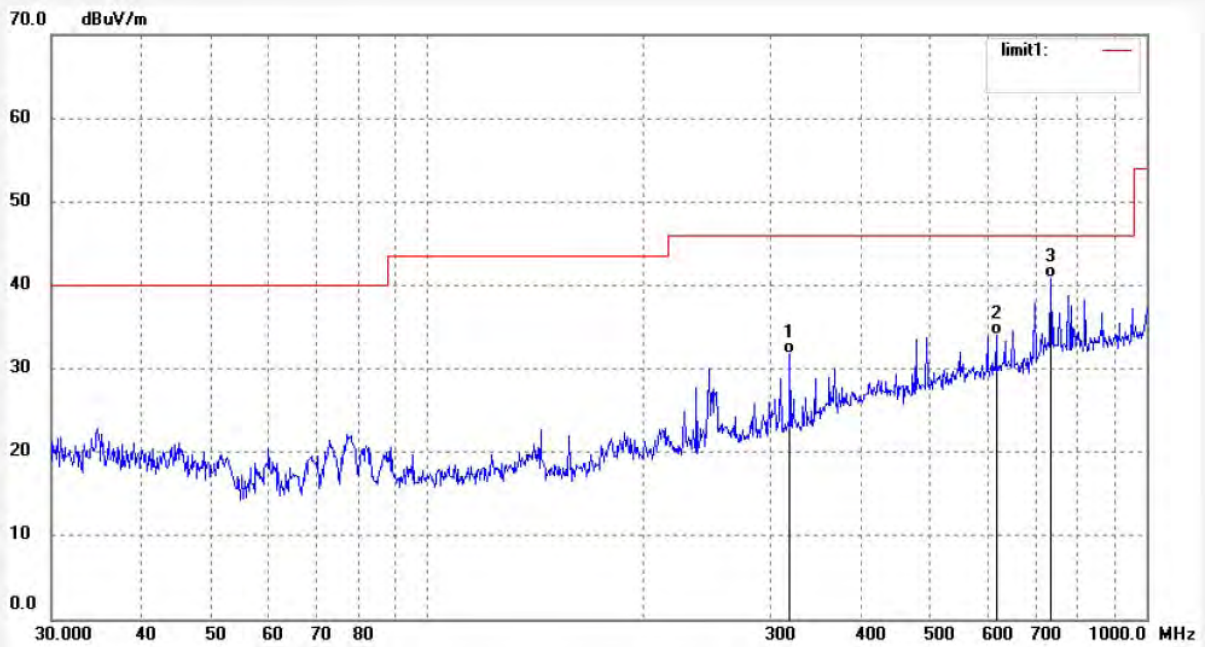

No.	Freq. (MHz)	Reading (dBuV/m)	Factor (dB)	Result (dBuV/m)	Limit (dBuV/m)	Margin (dB)	Detector	Height (cm)	Degree (deg.)	Remark
1	319.2071	12.42	19.31	31.73	46.00	-14.27	QP			
2	617.9417	8.12	25.99	34.11	46.00	-11.89	QP			
3	736.6209	13.43	27.47	40.90	46.00	-5.10	QP			



ACCURATE TECHNOLOGY CO., LTD.

F1,Bldg,A,Changyuan New Material Port Keyuan Rd,
Science & Industry Park,Nanshan Shenzhen,P.R.China

Site: 966 chamber
Tel:+86-0755-26503290
Fax:+86-0755-26503396

Job No.: Bob #1604	Polarization: Horizontal
Standard: FCC Class B 3M Radiated	Power Source: AC 120V/60Hz
Test item: Radiation Test	Date: 12/07/28/
Temp.(C)/Hum.(%) 24 C / 48 %	Time: 8/54/33
EUT: MC200Air	Engineer Signature:
Mode: TX Channel 1 (802.11g)	Distance: 3m
Model: MC200Air	
Manufacturer: Boston	

Note: Report NO.:ATE20120668

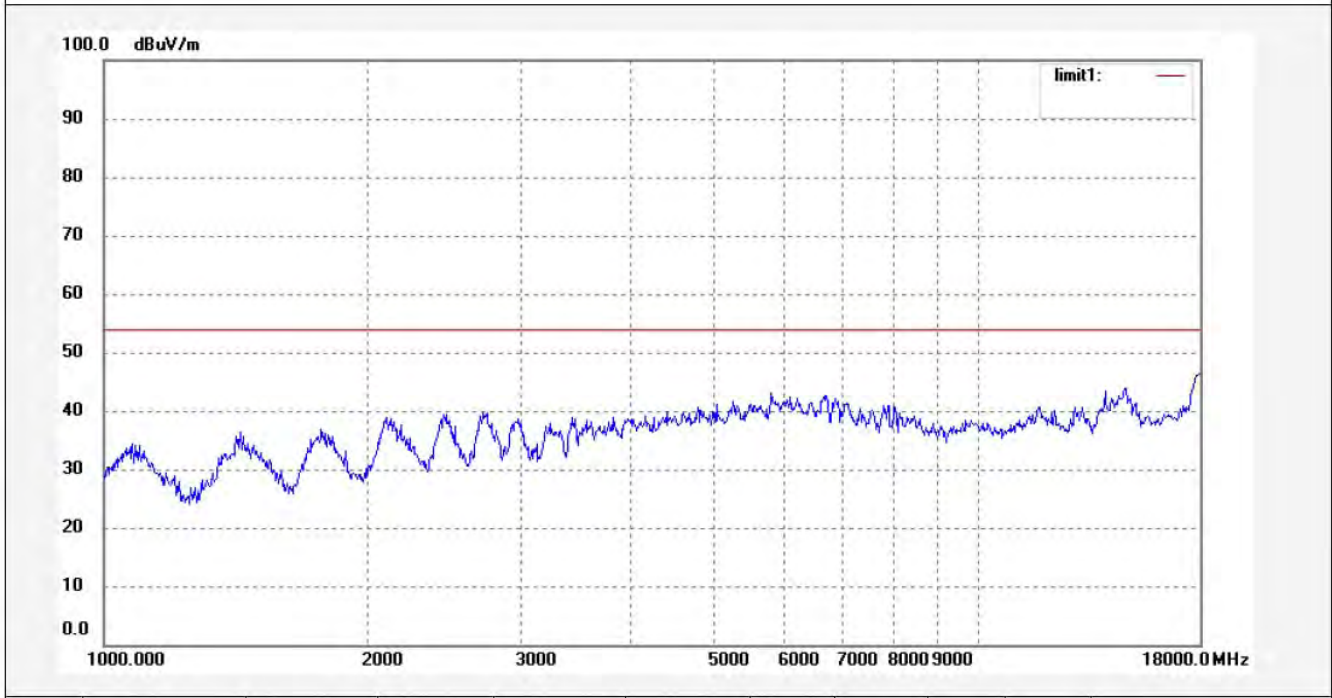

No.	Freq. (MHz)	Reading (dBuV/m)	Factor (dB)	Result (dBuV/m)	Limit (dBuV/m)	Margin (dB)	Detector	Height (cm)	Degree (deg.)	Remark
-----	-------------	------------------	-------------	-----------------	----------------	-------------	----------	-------------	---------------	--------



ACCURATE TECHNOLOGY CO., LTD.

F1,Bldg,A,Changyuan New Material Port Keyuan Rd,
Science & Industry Park,Nanshan Shenzhen,P.R.China

Site: 966 chamber
Tel:+86-0755-26503290
Fax:+86-0755-26503396

Job No.: Bob #1605	Polarization: Vertical
Standard: FCC Class B 3M Radiated	Power Source: AC 120V/60Hz
Test item: Radiation Test	Date: 12/07/28/
Temp.(C)/Hum.(%) 24 C / 48 %	Time: 8/55/58
EUT: MC200Air	Engineer Signature:
Mode: TX Channel 1 (802.11g)	Distance: 3m
Model: MC200Air	
Manufacturer: Boston	

Note: Report NO.:ATE20120668

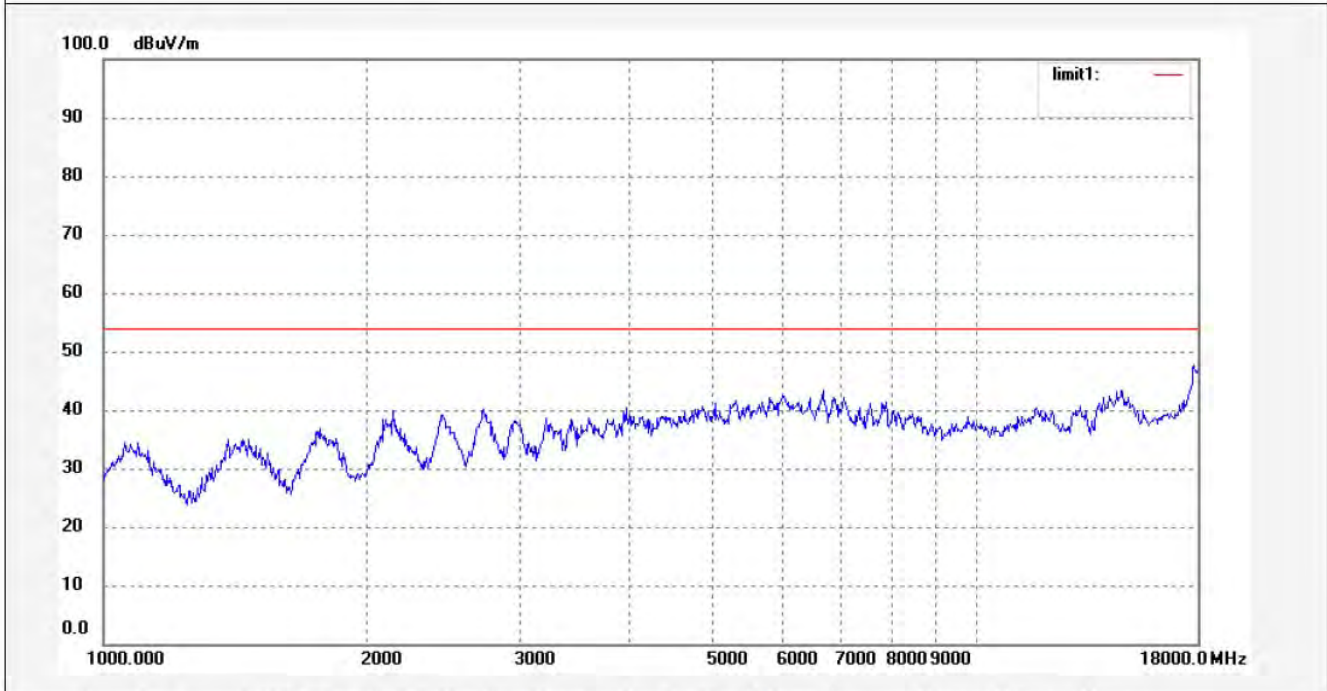

No.	Freq. (MHz)	Reading (dBuV/m)	Factor (dB)	Result (dBuV/m)	Limit (dBuV/m)	Margin (dB)	Detector	Height (cm)	Degree (deg.)	Remark
-----	-------------	------------------	-------------	-----------------	----------------	-------------	----------	-------------	---------------	--------



ACCURATE TECHNOLOGY CO., LTD.

F1,Bldg,A,Changyuan New Material Port Keyuan Rd,
Science & Industry Park,Nanshan Shenzhen,P.R.China

Site: 966 chamber
Tel:+86-0755-26503290
Fax:+86-0755-26503396

Job No.: Bob #1677
Standard: FCC Class B 3M Radiated
Test item: Radiation Test
Temp.(C)/Hum.(%) 25 C / 50 %
EUT: MC200Air
Mode: TX Channel 1 (802.11g)
Model: MC200Air
Manufacturer: Boston

Polarization: Horizontal
Power Source: AC 120V/60Hz
Date: 12/07/28/
Time: 11:35:56
Engineer Signature: Bob
Distance: 3m

Note: Report No.:ATE20120668

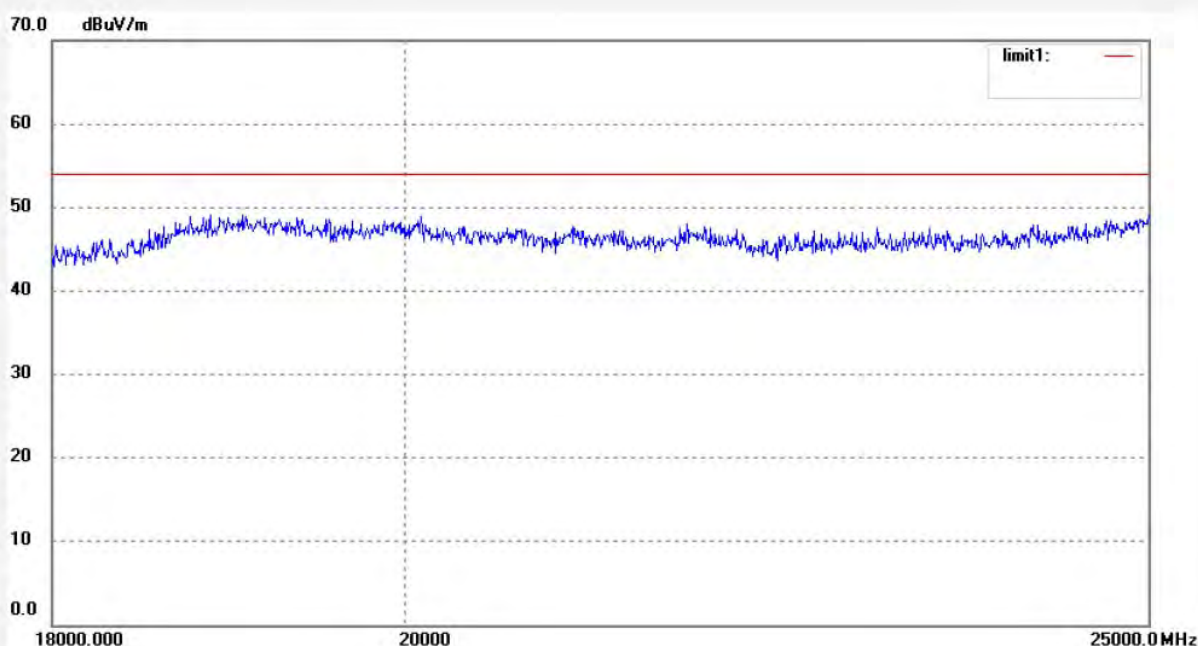

No.	Freq. (MHz)	Reading (dBuV/m)	Factor (dB)	Result (dBuV/m)	Limit (dBuV/m)	Margin (dB)	Detector	Height (cm)	Degree (deg.)	Remark
-----	-------------	------------------	-------------	-----------------	----------------	-------------	----------	-------------	---------------	--------



ACCURATE TECHNOLOGY CO., LTD.

F1,Bldg,A,Changyuan New Material Port Keyuan Rd,
Science & Industry Park,Nanshan Shenzhen,P.R.China

Site: 966 chamber
Tel:+86-0755-26503290
Fax:+86-0755-26503396

Job No.: Bob #1676
Standard: FCC Class B 3M Radiated
Test item: Radiation Test
Temp.(C)/Hum.(%) 25 C / 50 %
EUT: MC200Air
Mode: TX Channel 1 (802.11g)
Model: MC200Air
Manufacturer: Boston

Polarization: Vertical
Power Source: AC 120V/60Hz
Date: 12/07/28/
Time: 11:32:05
Engineer Signature: Bob
Distance: 3m

Note: Report No.:ATE20120668

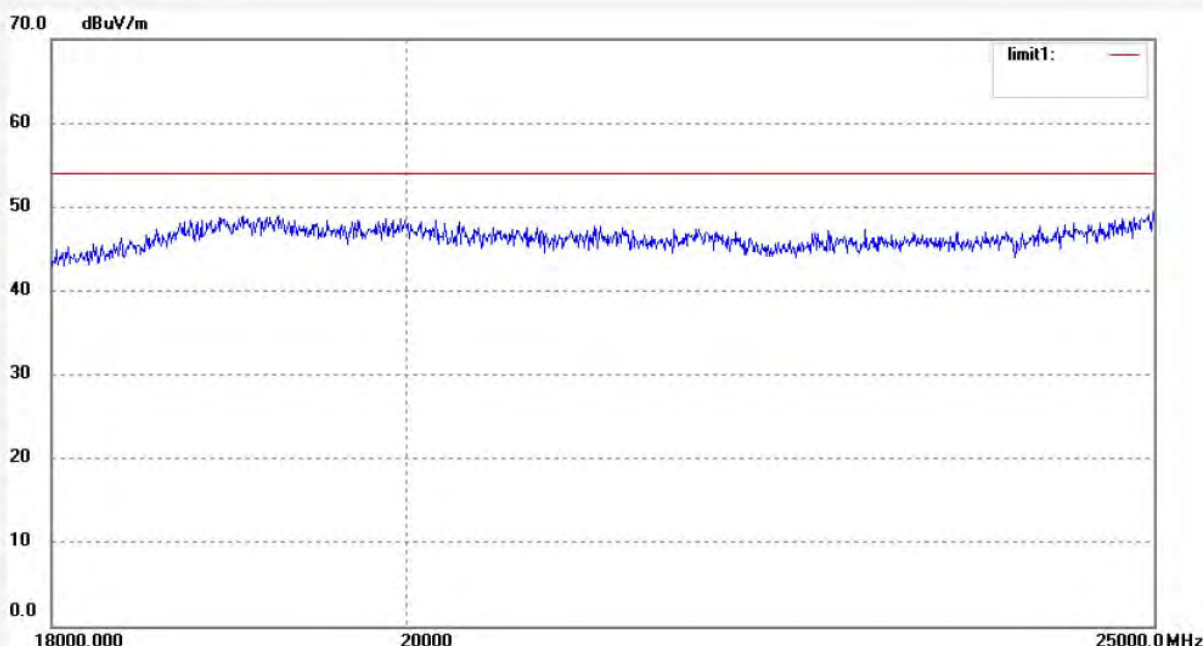

No.	Freq. (MHz)	Reading (dBuV/m)	Factor (dB)	Result (dBuV/m)	Limit (dBuV/m)	Margin (dB)	Detector	Height (cm)	Degree (deg.)	Remark
-----	-------------	------------------	-------------	-----------------	----------------	-------------	----------	-------------	---------------	--------



ACCURATE TECHNOLOGY CO., LTD.

F1,Bldg,A,Changyuan New Material Port Keyuan Rd,
Science & Industry Park,Nanshan Shenzhen,P.R.China

Site: 966 chamber
Tel:+86-0755-26503290
Fax:+86-0755-26503396

Job No.: Bob #1651	Polarization: Horizontal
Standard: FCC Class B 3M Radiated	Power Source: AC 120V/60Hz
Test item: Radiation Test	Date: 12/07/28/
Temp.(C)/Hum.(%) 24 C / 48 %	Time: 10/46/40
EUT: MC200Air	Engineer Signature:
Mode: TX Channel 6 (802.11g)	Distance: 3m
Model: MC200Air	
Manufacturer: Boston	

Note: Report NO.:ATE20120668

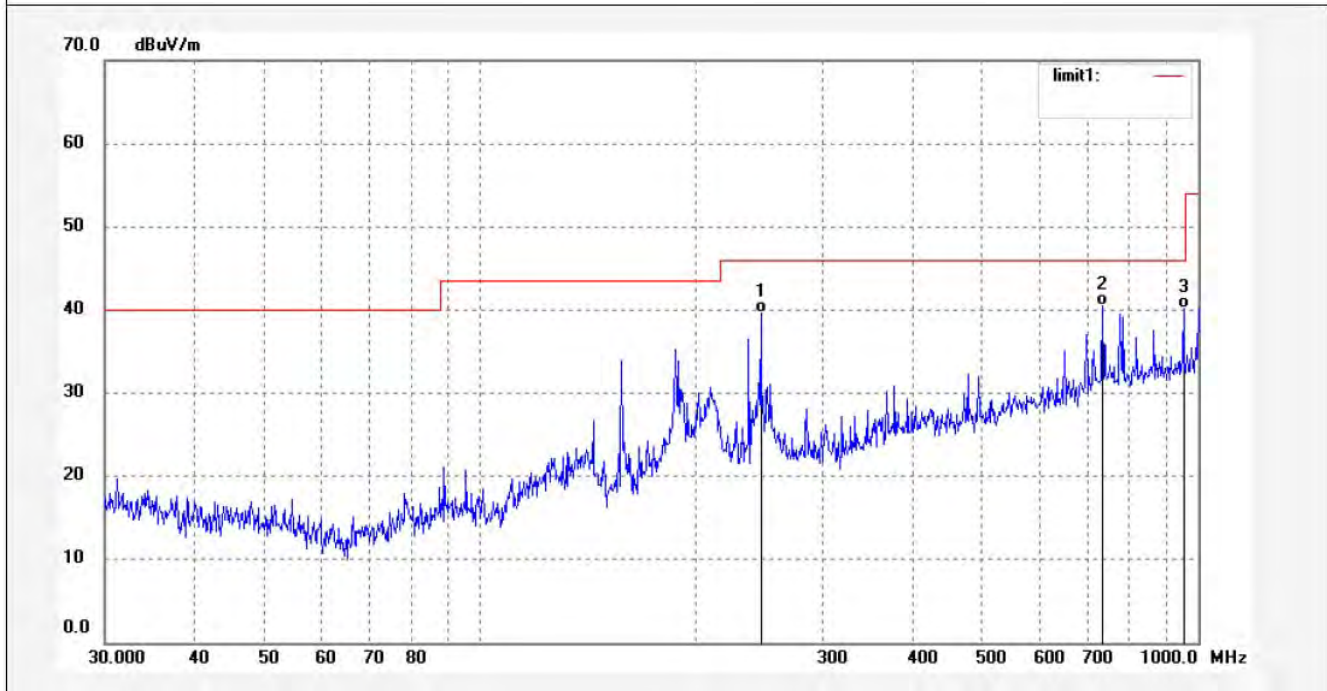

No.	Freq. (MHz)	Reading (dBuV/m)	Factor (dB)	Result (dBuV/m)	Limit (dBuV/m)	Margin (dB)	Detector	Height (cm)	Degree (deg.)	Remark
1	246.1238	22.39	17.19	39.58	46.00	-6.42	QP			
2	736.6209	12.99	27.47	40.46	46.00	-5.54	QP			
3	955.3509	10.45	29.63	40.08	46.00	-5.92	QP			



ACCURATE TECHNOLOGY CO., LTD.

F1,Bldg,A,Changyuan New Material Port Keyuan Rd,
Science & Industry Park,Nanshan Shenzhen,P.R.China

Site: 966 chamber
Tel:+86-0755-26503290
Fax:+86-0755-26503396

Job No.: Bob #1650	Polarization: Vertical
Standard: FCC Class B 3M Radiated	Power Source: AC 120V/60Hz
Test item: Radiation Test	Date: 12/07/28/
Temp.(C)/Hum.(%) 24 C / 48 %	Time: 10/43/12
EUT: MC200Air	Engineer Signature:
Mode: TX Channel 6 (802.11g)	Distance: 3m
Model: MC200Air	
Manufacturer: Boston	

Note: Report NO.:ATE20120668

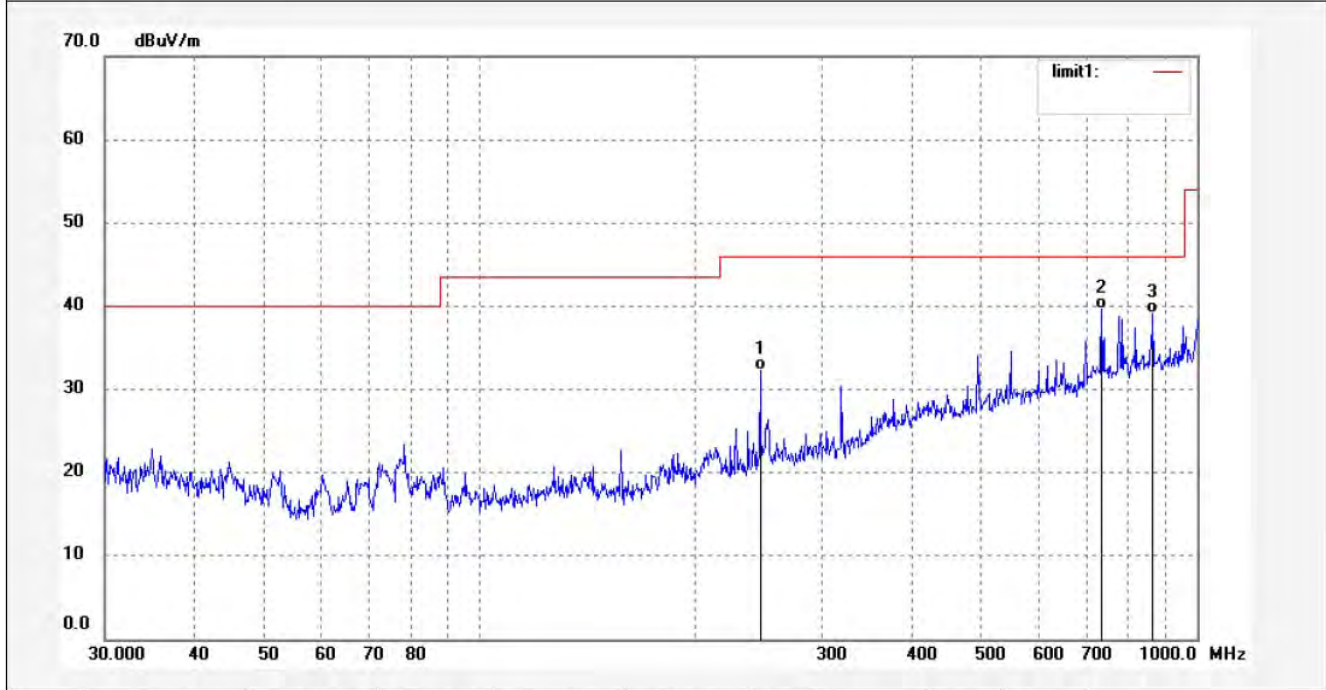

No.	Freq. (MHz)	Reading (dBuV/m)	Factor (dB)	Result (dBuV/m)	Limit (dBuV/m)	Margin (dB)	Detector	Height (cm)	Degree (deg.)	Remark
1	246.1238	15.04	17.19	32.23	46.00	-13.77	QP			
2	736.6209	12.25	27.47	39.72	46.00	-6.28	QP			
3	868.8860	10.43	28.63	39.06	46.00	-6.94	QP			



ACCURATE TECHNOLOGY CO., LTD.

F1,Bldg,A,Changyuan New Material Port Keyuan Rd,
Science & Industry Park,Nanshan Shenzhen,P.R.China

Site: 966 chamber
Tel:+86-0755-26503290
Fax:+86-0755-26503396

Job No.: Bob #1608	Polarization: Horizontal
Standard: FCC Class B 3M Radiated	Power Source: AC 120V/60Hz
Test item: Radiation Test	Date: 12/07/28/
Temp.(C)/Hum.(%) 24 C / 48 %	Time: 9/00/45
EUT: MC200Air	Engineer Signature:
Mode: TX Channel 6 (802.11g)	Distance: 3m
Model: MC200Air	
Manufacturer: Boston	

Note: Report NO.:ATE20120668

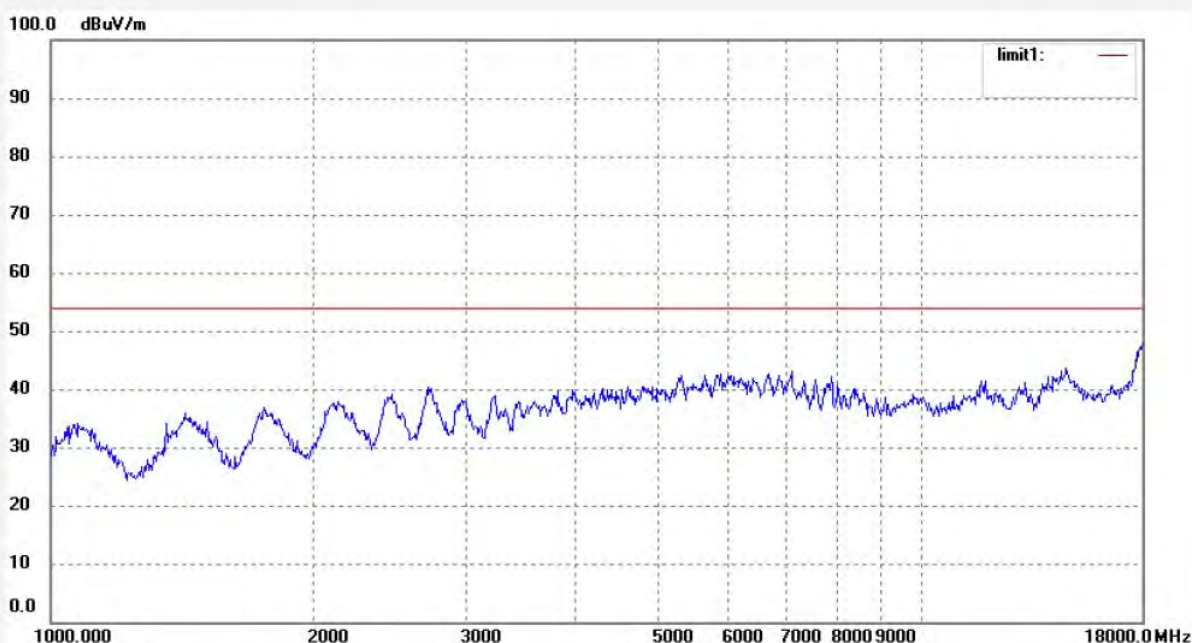

No.	Freq. (MHz)	Reading (dBuV/m)	Factor (dB)	Result (dBuV/m)	Limit (dBuV/m)	Margin (dB)	Detector	Height (cm)	Degree (deg.)	Remark
-----	-------------	------------------	-------------	-----------------	----------------	-------------	----------	-------------	---------------	--------



ACCURATE TECHNOLOGY CO., LTD.

F1,Bldg,A,Changyuan New Material Port Keyuan Rd,
Science & Industry Park,Nanshan Shenzhen,P.R.China

Site: 966 chamber
Tel:+86-0755-26503290
Fax:+86-0755-26503396

Job No.: Bob #1609
Standard: FCC Class B 3M Radiated
Test item: Radiation Test
Temp.(C)/Hum.(%) 24 C / 48 %
EUT: MC200Air
Mode: TX Channel 6 (802.11g)
Model: MC200Air
Manufacturer: Boston

Polarization: Vertical
Power Source: AC 120V/60Hz
Date: 12/07/28/
Time: 9/02/15
Engineer Signature:
Distance: 3m

Note: Report NO.:ATE20120668

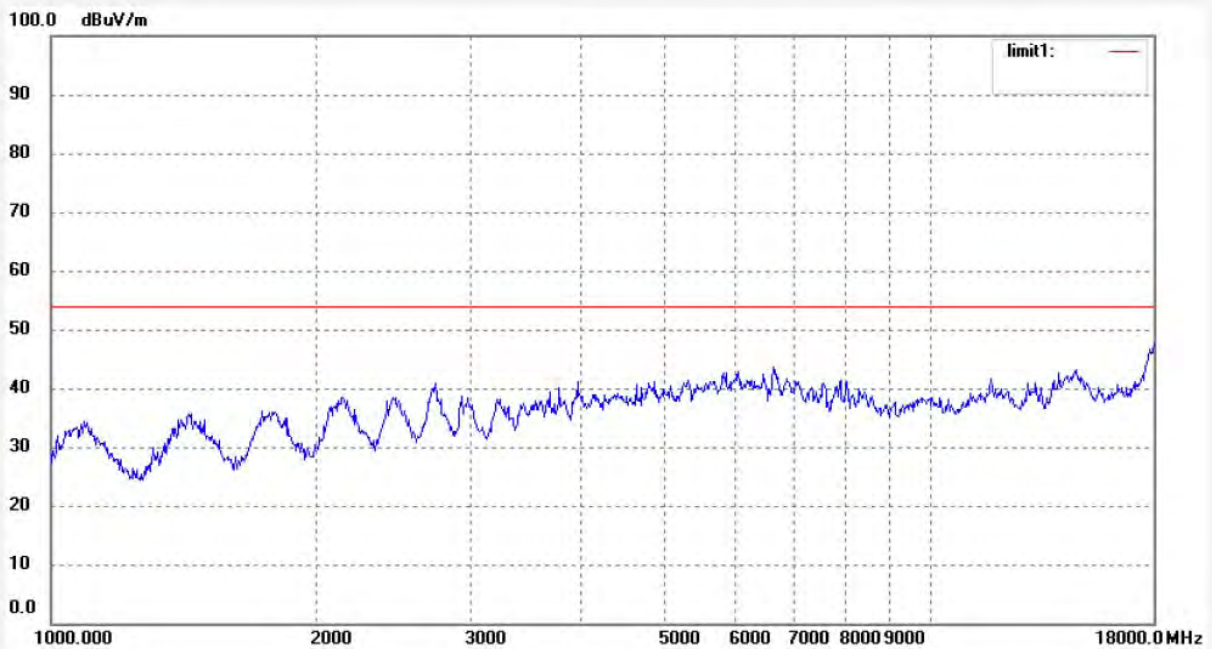

No.	Freq. (MHz)	Reading (dBuV/m)	Factor (dB)	Result (dBuV/m)	Limit (dBuV/m)	Margin (dB)	Detector	Height (cm)	Degree (deg.)	Remark
-----	-------------	------------------	-------------	-----------------	----------------	-------------	----------	-------------	---------------	--------



ACCURATE TECHNOLOGY CO., LTD.

F1,Bldg,A,Changyuan New Material Port Keyuan Rd,
Science & Industry Park,Nanshan Shenzhen,P.R.China

Site: 966 chamber
Tel:+86-0755-26503290
Fax:+86-0755-26503396

Job No.: Bob #1678	Polarization: Horizontal
Standard: FCC Class B 3M Radiated	Power Source: AC 120V/60Hz
Test item: Radiation Test	Date: 12/07/28/
Temp.(C)/Hum.(%) 25 C / 50 %	Time: 11:38:38
EUT: MC200Air	Engineer Signature: Bob
Mode: TX Channel 6 (802.11g)	Distance: 3m
Model: MC200Air	
Manufacturer: Boston	

Note: Report No.:ATE20120668

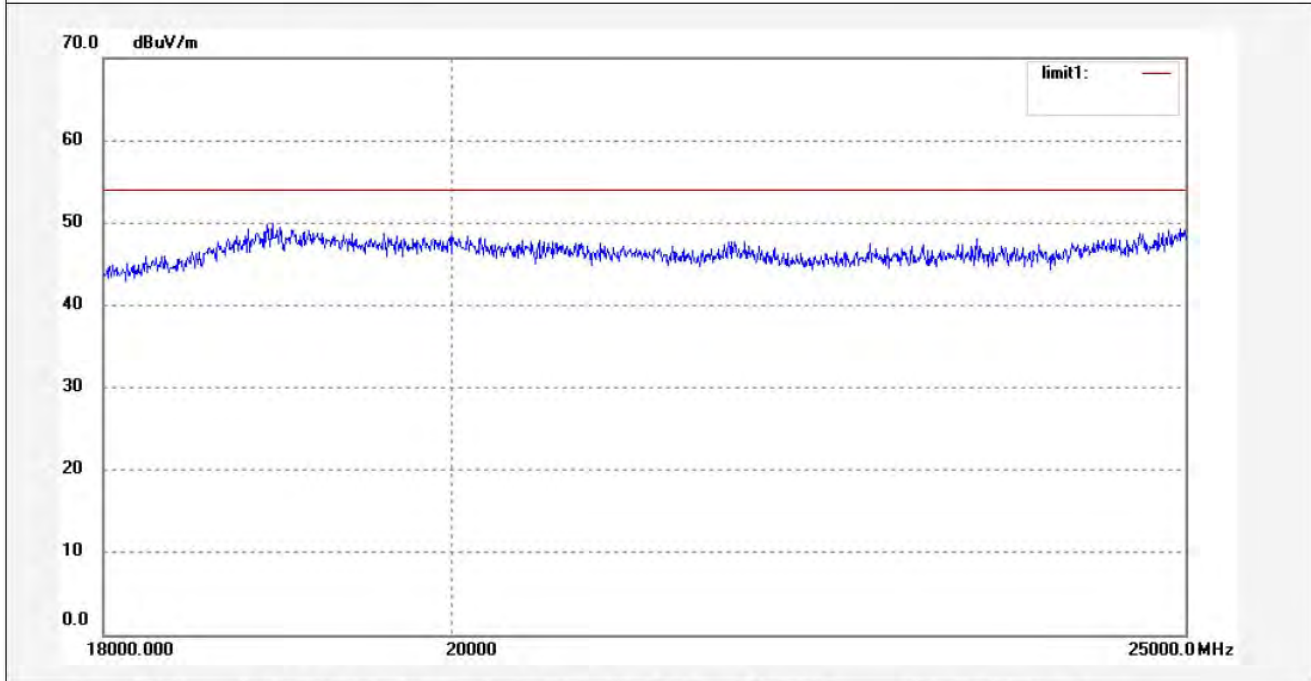

No.	Freq. (MHz)	Reading (dBuV/m)	Factor (dB)	Result (dBuV/m)	Limit (dBuV/m)	Margin (dB)	Detector	Height (cm)	Degree (deg.)	Remark
-----	-------------	------------------	-------------	-----------------	----------------	-------------	----------	-------------	---------------	--------



ACCURATE TECHNOLOGY CO., LTD.

F1,Bldg,A,Changyuan New Material Port Keyuan Rd,
Science & Industry Park,Nanshan Shenzhen,P.R.China

Site: 966 chamber
Tel:+86-0755-26503290
Fax:+86-0755-26503396

Job No.: Bob #1679
Standard: FCC Class B 3M Radiated
Test item: Radiation Test
Temp.(C)/Hum.(%) 25 C / 50 %
EUT: MC200Air
Mode: TX Channel 6 (802.11g)
Model: MC200Air
Manufacturer: Boston

Polarization: Vertical
Power Source: AC 120V/60Hz
Date: 12/07/28/
Time: 11:43:17
Engineer Signature: Bob
Distance: 3m

Note: Report No.:ATE20120668

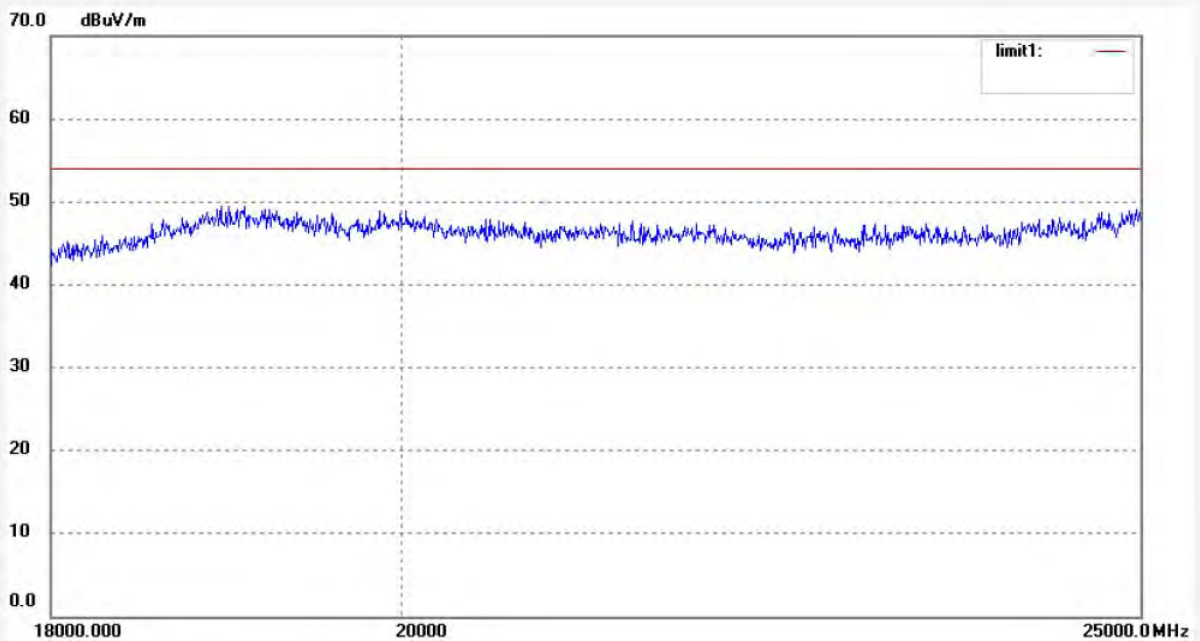

No.	Freq. (MHz)	Reading (dBuV/m)	Factor (dB)	Result (dBuV/m)	Limit (dBuV/m)	Margin (dB)	Detector	Height (cm)	Degree (deg.)	Remark
-----	-------------	------------------	-------------	-----------------	----------------	-------------	----------	-------------	---------------	--------



ACCURATE TECHNOLOGY CO., LTD.

F1,Bldg,A,Changyuan New Material Port Keyuan Rd,
Science & Industry Park,Nanshan Shenzhen,P.R.China

Site: 966 chamber
Tel:+86-0755-26503290
Fax:+86-0755-26503396

Job No.: Bob #1656
Standard: FCC Class B 3M Radiated
Test item: Radiation Test
Temp.(C)/Hum.(%) 24 C / 48 %
EUT: MC200Air
Mode: TX Channel 11 (802.11g)
Model: MC200Air
Manufacturer: Boston

Polarization: Horizontal
Power Source: AC 120V/60Hz
Date: 12/07/28/
Time: 11/01/54
Engineer Signature:
Distance: 3m

Note: Report NO.:ATE20120668

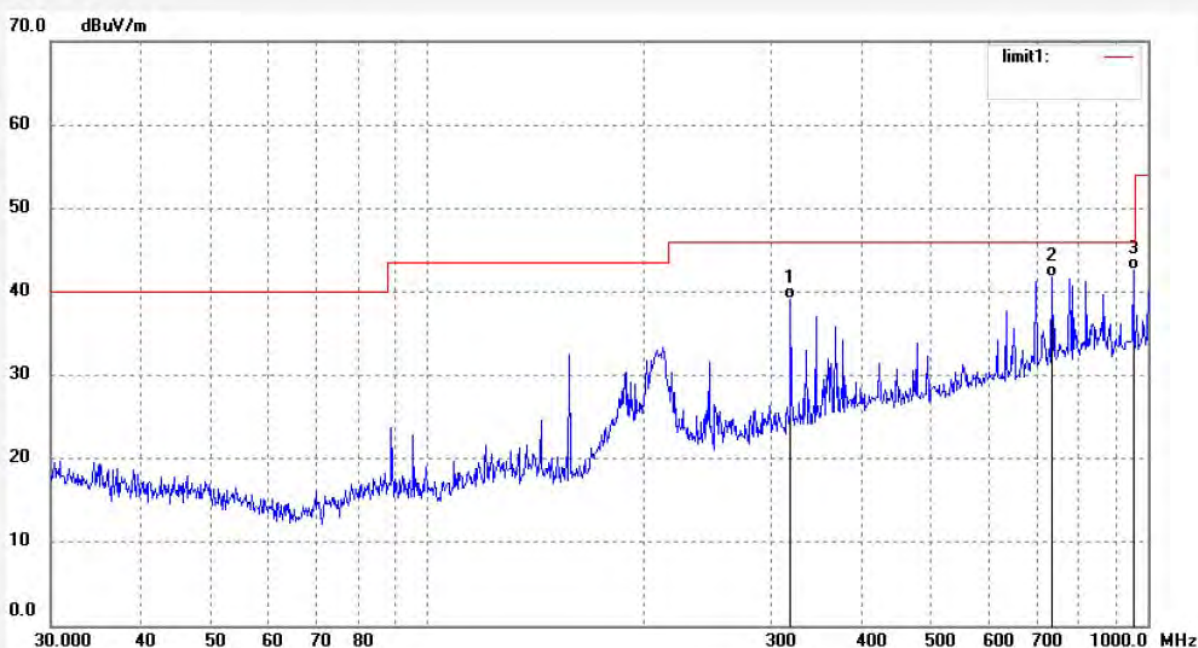

No.	Freq. (MHz)	Reading (dBuV/m)	Factor (dB)	Result (dBuV/m)	Limit (dBuV/m)	Margin (dB)	Detector	Height (cm)	Degree (deg.)	Remark
1	319.2071	19.75	19.31	39.06	46.00	-6.94	QP			
2	736.6209	14.23	27.47	41.70	46.00	-4.30	QP			
3	955.3509	12.99	29.63	42.62	46.00	-3.38	QP			



ACCURATE TECHNOLOGY CO., LTD.

F1,Bldg,A,Changyuan New Material Port Keyuan Rd,
Science & Industry Park,Nanshan Shenzhen,P.R.China

Site: 966 chamber
Tel:+86-0755-26503290
Fax:+86-0755-26503396

Job No.: Bob #1657	Polarization: Vertical
Standard: FCC Class B 3M Radiated	Power Source: AC 120V/60Hz
Test item: Radiation Test	Date: 12/07/28/
Temp.(C)/Hum.(%) 24 C / 48 %	Time: 11/04/38
EUT: MC200Air	Engineer Signature:
Mode: TX Channel 11 (802.11g)	Distance: 3m
Model: MC200Air	
Manufacturer: Boston	

Note: Report NO.:ATE20120668

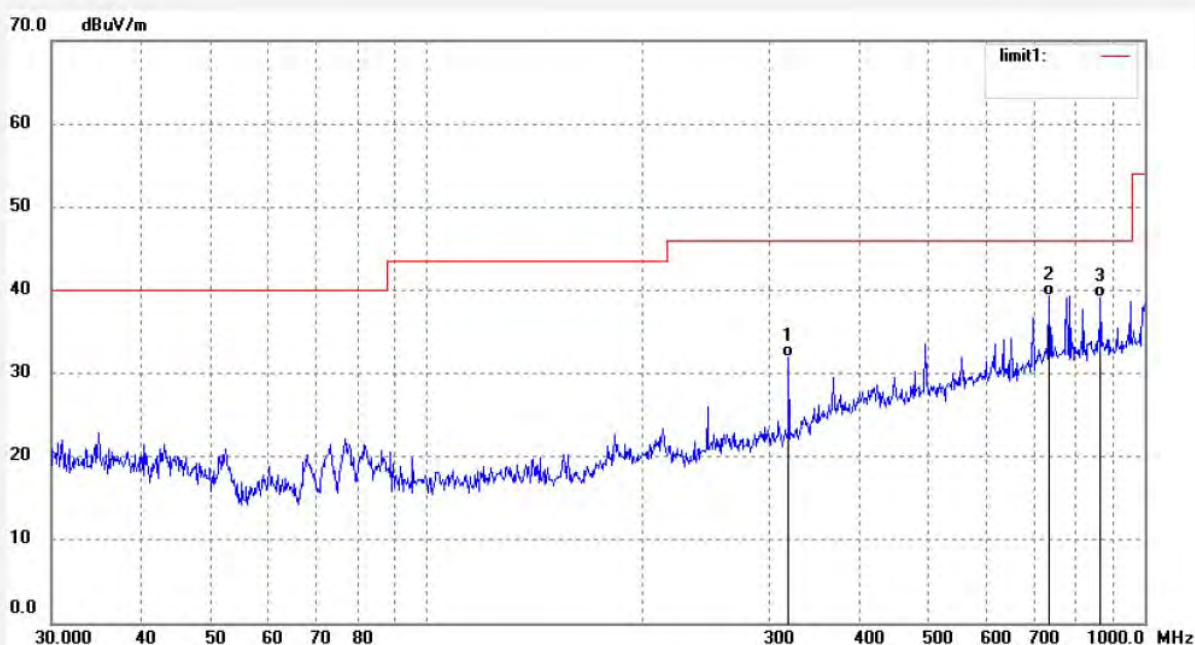

No.	Freq. (MHz)	Reading (dBuV/m)	Factor (dB)	Result (dBuV/m)	Limit (dBuV/m)	Margin (dB)	Detector	Height (cm)	Degree (deg.)	Remark
1	319.2071	12.64	19.31	31.95	46.00	-14.05	QP			
2	736.6209	11.88	27.47	39.35	46.00	-6.65	QP			
3	868.8860	10.48	28.63	39.11	46.00	-6.89	QP			



ACCURATE TECHNOLOGY CO., LTD.

F1,Bldg.A,Changyuan New Material Port Keyuan Rd,
Science & Industry Park,Nanshan Shenzhen,P.R.China

Site: 966 chamber
Tel:+86-0755-26503290
Fax:+86-0755-26503396

Job No.: Bob #1612	Polarization: Horizontal
Standard: FCC Class B 3M Radiated	Power Source: AC 120V/60Hz
Test item: Radiation Test	Date: 12/07/28/
Temp.(C)/Hum.(%) 24 C / 48 %	Time: 9/06/52
EUT: MC200Air	Engineer Signature:
Mode: TX Channel 11 (802.11g)	Distance: 3m
Model: MC200Air	
Manufacturer: Boston	

Note: Report NO.:ATE20120668

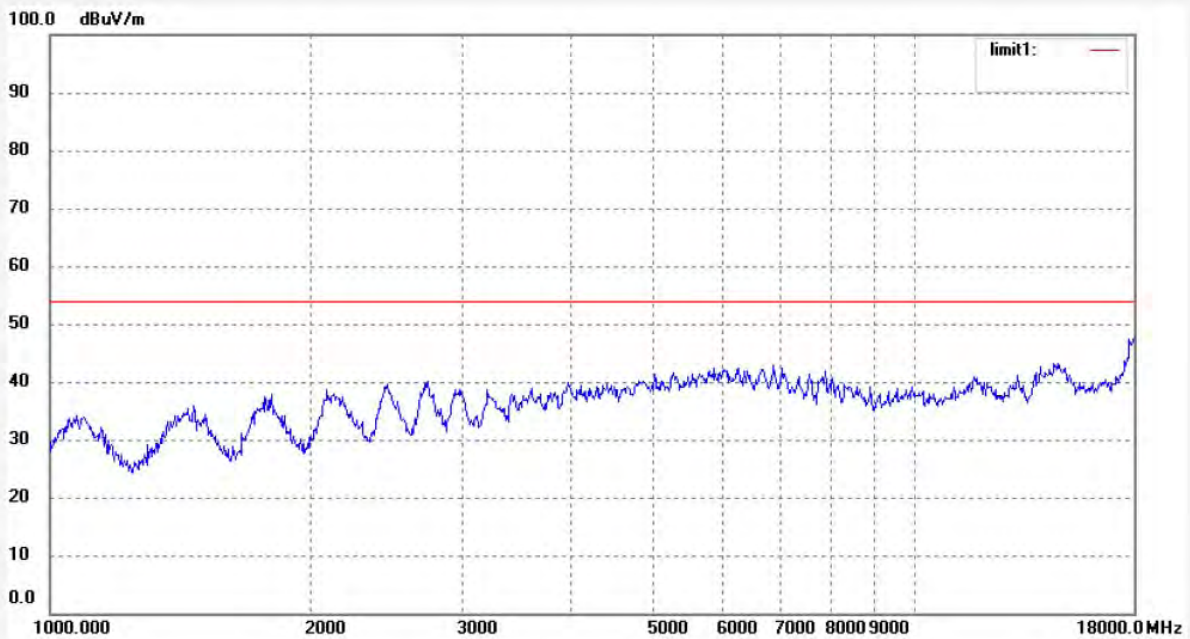

No.	Freq. (MHz)	Reading (dBuV/m)	Factor (dB)	Result (dBuV/m)	Limit (dBuV/m)	Margin (dB)	Detector	Height (cm)	Degree (deg.)	Remark
-----	-------------	------------------	-------------	-----------------	----------------	-------------	----------	-------------	---------------	--------



ACCURATE TECHNOLOGY CO., LTD.

F1,Bldg,A,Changyuan New Material Port Keyuan Rd,
Science & Industry Park,Nanshan Shenzhen,P.R.China

Site: 966 chamber
Tel:+86-0755-26503290
Fax:+86-0755-26503396

Job No.: Bob #1613	Polarization: Vertical
Standard: FCC Class B 3M Radiated	Power Source: AC 120V/60Hz
Test item: Radiation Test	Date: 12/07/28/
Temp.(C)/Hum.(%) 24 C / 48 %	Time: 9/08/37
EUT: MC200Air	Engineer Signature:
Mode: TX Channel 11 (802.11g)	Distance: 3m
Model: MC200Air	
Manufacturer: Boston	

Note: Report NO.:ATE20120668

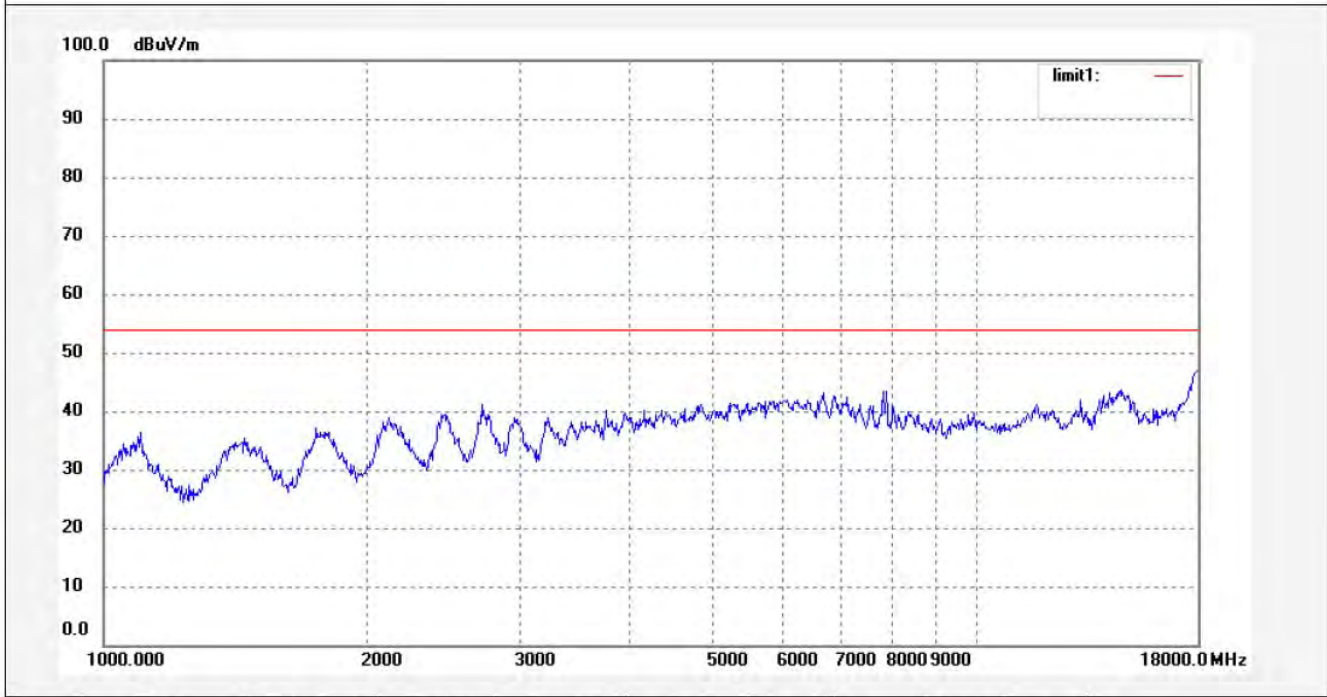

No.	Freq. (MHz)	Reading (dBuV/m)	Factor (dB)	Result (dBuV/m)	Limit (dBuV/m)	Margin (dB)	Detector	Height (cm)	Degree (deg.)	Remark
-----	-------------	------------------	-------------	-----------------	----------------	-------------	----------	-------------	---------------	--------



ACCURATE TECHNOLOGY CO., LTD.

F1,Bldg.A,Changyuan New Material Port Keyuan Rd,
Science & Industry Park,Nanshan Shenzhen,P.R.China

Site: 966 chamber
Tel:+86-0755-26503290
Fax:+86-0755-26503396

Job No.: Bob #1681	Polarization: Horizontal
Standard: FCC Class B 3M Radiated	Power Source: AC 120V/60Hz
Test item: Radiation Test	Date: 12/07/28/
Temp.(C)/Hum.(%) 25 C / 50 %	Time: 11:50:47
EUT: MC200Air	Engineer Signature: Bob
Mode: TX Channel 11 (802.11g)	Distance: 3m
Model: MC200Air	
Manufacturer: Boston	

Note: Report No.:ATE20120668

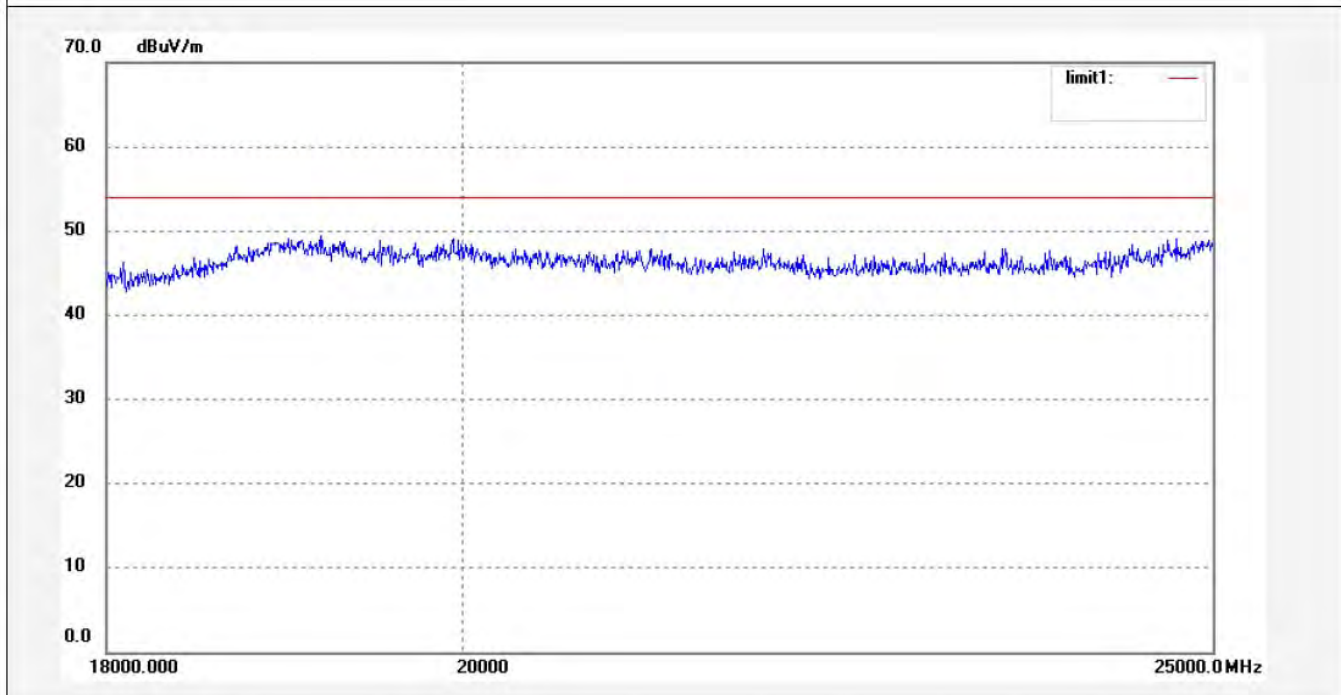

No.	Freq. (MHz)	Reading (dBuV/m)	Factor (dB)	Result (dBuV/m)	Limit (dBuV/m)	Margin (dB)	Detector	Height (cm)	Degree (deg.)	Remark
-----	-------------	------------------	-------------	-----------------	----------------	-------------	----------	-------------	---------------	--------



ACCURATE TECHNOLOGY CO., LTD.

F1,Bldg,A,Changyuan New Material Port Keyuan Rd,
Science & Industry Park,Nanshan Shenzhen,P.R.China

Site: 966 chamber
Tel:+86-0755-26503290
Fax:+86-0755-26503396

Job No.: Bob #1680	Polarization: Vertical
Standard: FCC Class B 3M Radiated	Power Source: AC 120V/60Hz
Test item: Radiation Test	Date: 12/07/28/
Temp.(C)/Hum.(%) 25 C / 50 %	Time: 11:47:55
EUT: MC200Air	Engineer Signature: Bob
Mode: TX Channel 11 (802.11g)	Distance: 3m
Model: MC200Air	
Manufacturer: Boston	

Note: Report No.:ATE20120668

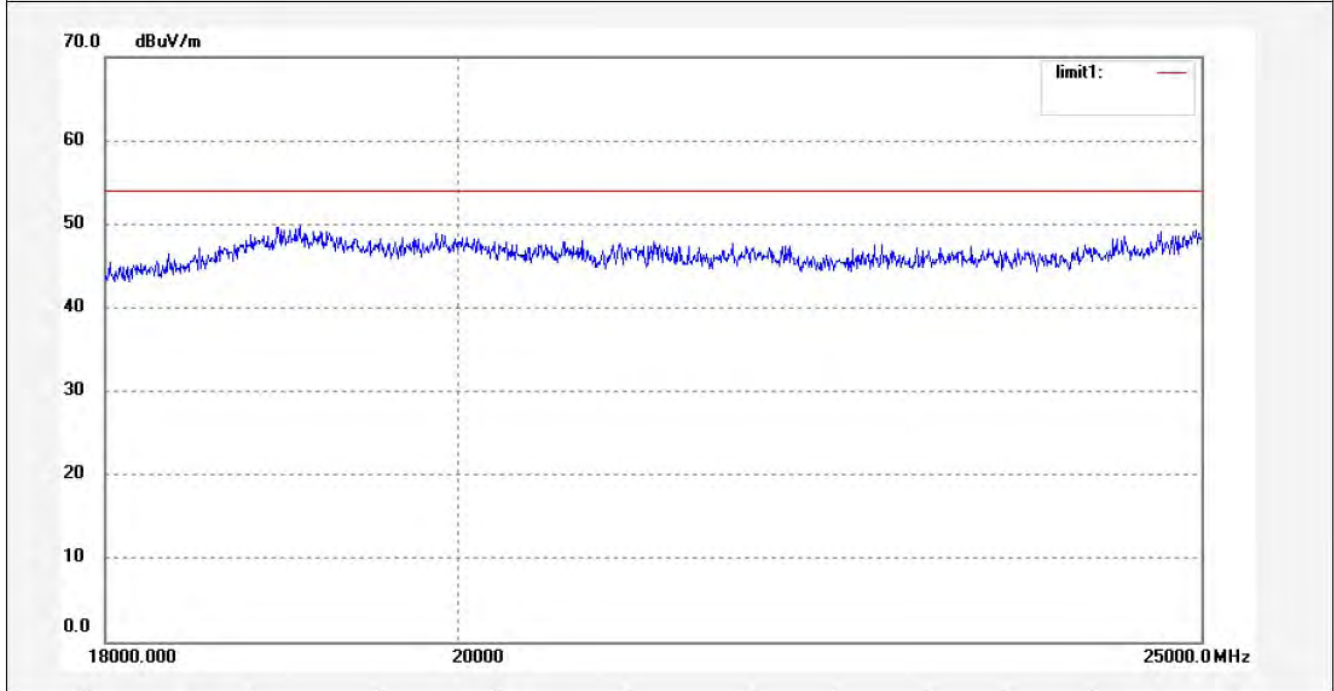

No.	Freq. (MHz)	Reading (dBuV/m)	Factor (dB)	Result (dBuV/m)	Limit (dBuV/m)	Margin (dB)	Detector	Height (cm)	Degree (deg.)	Remark
-----	-------------	------------------	-------------	-----------------	----------------	-------------	----------	-------------	---------------	--------

10. CONDUCTED SPURIOUS EMISSION COMPLIANCE TEST

10.1. Block Diagram of Test Setup

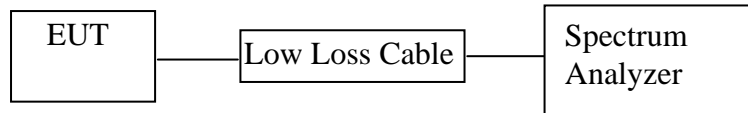

(EUT: MC200Air)

10.2. The Requirement For Section 15.247(d)

Section 15.247(d): In any 100 kHz bandwidth outside the frequency band in which the spread spectrum or digitally modulated intentional radiator is operating, the radio frequency power that is produced by the intentional radiator shall be at least 20 dB below that in the 100 kHz bandwidth within the band that contains the highest level of the desired power, based on either an RF conducted or a radiated measurement, provided the transmitter demonstrates compliance with the peak conducted power limits. If the transmitter complies with the conducted power limits based on the use of RMS averaging over a time interval, as permitted under paragraph (b)(3) of this section, the attenuation required under this paragraph shall be 30 dB instead of 20 dB. Attenuation below the general limits specified in Section 15.209(a) is not required. In addition, radiated emissions which fall in the restricted bands, as defined in Section 15.205(a), must also comply with the radiated emission limits specified in Section 15.209(a).

10.3. EUT Configuration on Measurement

The following equipment is installed on the emission measurement to meet the commission requirements and operating regulations in a manner which tends to maximize its emission characteristics in normal application.

10.3.1. MC200Air (EUT)

Model Number	:	MC200Air
Serial Number	:	N/A
Manufacturer	:	Boston Acoustics, Inc.

10.4. Operating Condition of EUT

10.4.1. Setup the EUT and simulator as shown as Section 10.1.

10.4.2. Turn on the power of all equipment.

10.4.3. Let the EUT work in TX modes measure it. The transmit frequency are 2412-2462MHz. We select 2412MHz, 2437MHz, 2462MHz TX frequency to transmit.

10.5. Test Procedure

10.5.1. The transmitter output was connected to the spectrum analyzer via a low loss cable.

10.5.2. Set RBW of spectrum analyzer to 100kHz and VBW to 300kHz (below 1GHz).

Set RBW of spectrum analyzer to 1MHz and VBW to 3MHz (above 1GHz).

10.5.3. The Conducted Spurious Emission was measured and recorded.

10.6. Test Result

Pass.

The spectrum analyzer plots are attached as below.

TX 802.11b Channel Low 2412MHz (30MHz-1GHz)

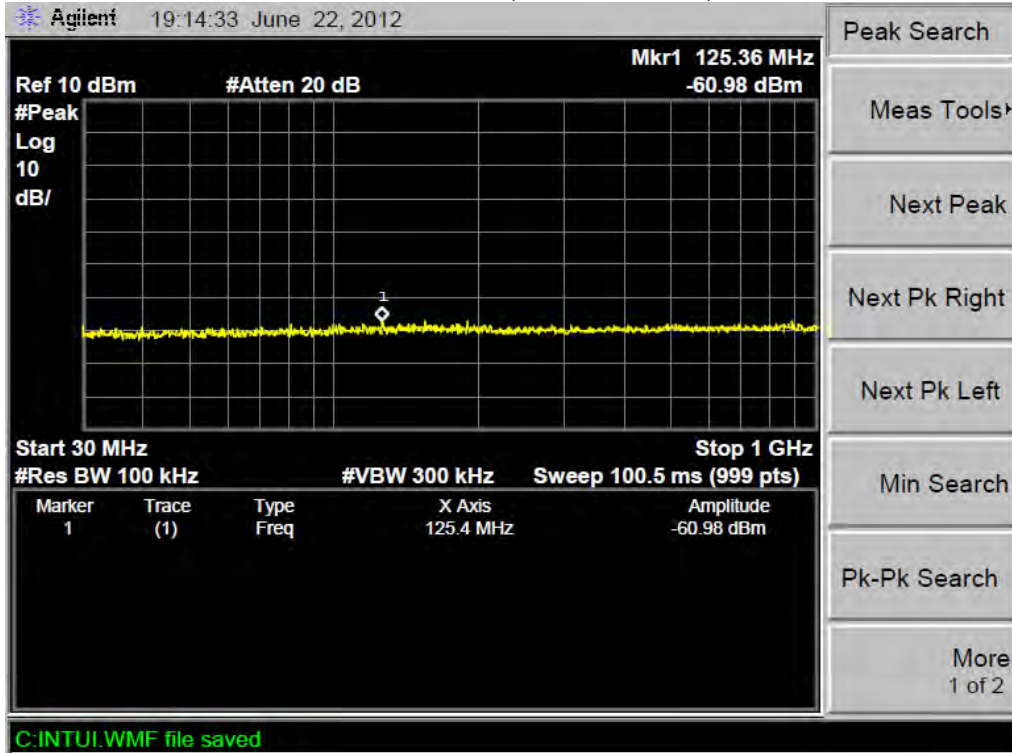

TX 802.11b Channel Low 2412MHz (1GHz-25GHz)

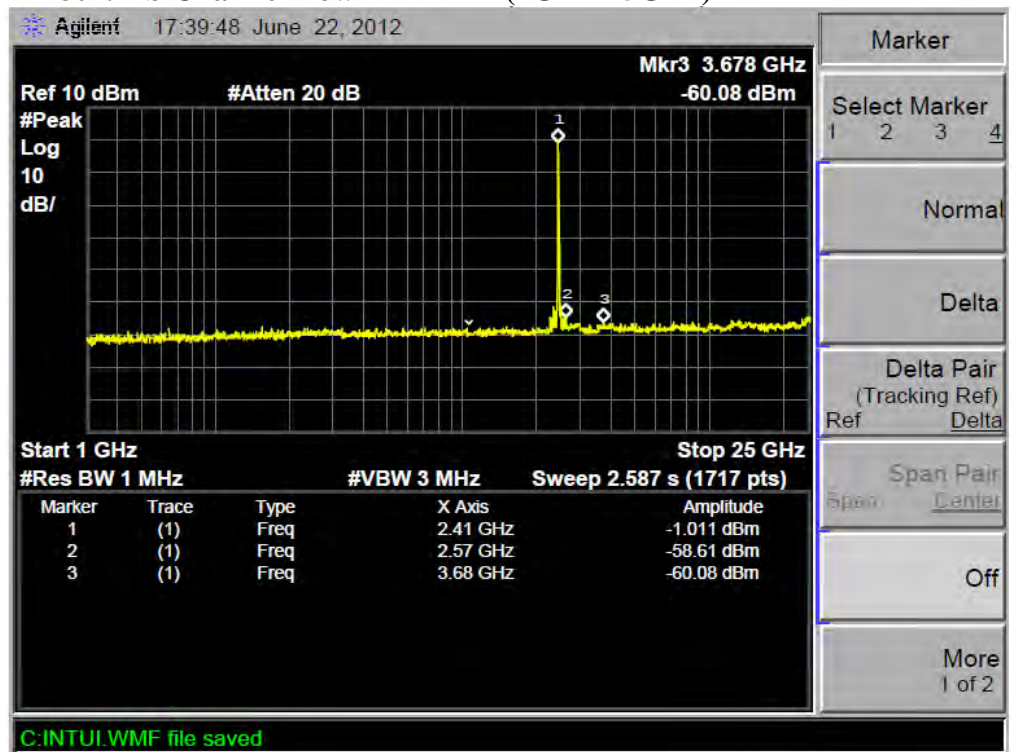

TX 802.11b Channel Middle 2437MHz (30MHz-1GHz)

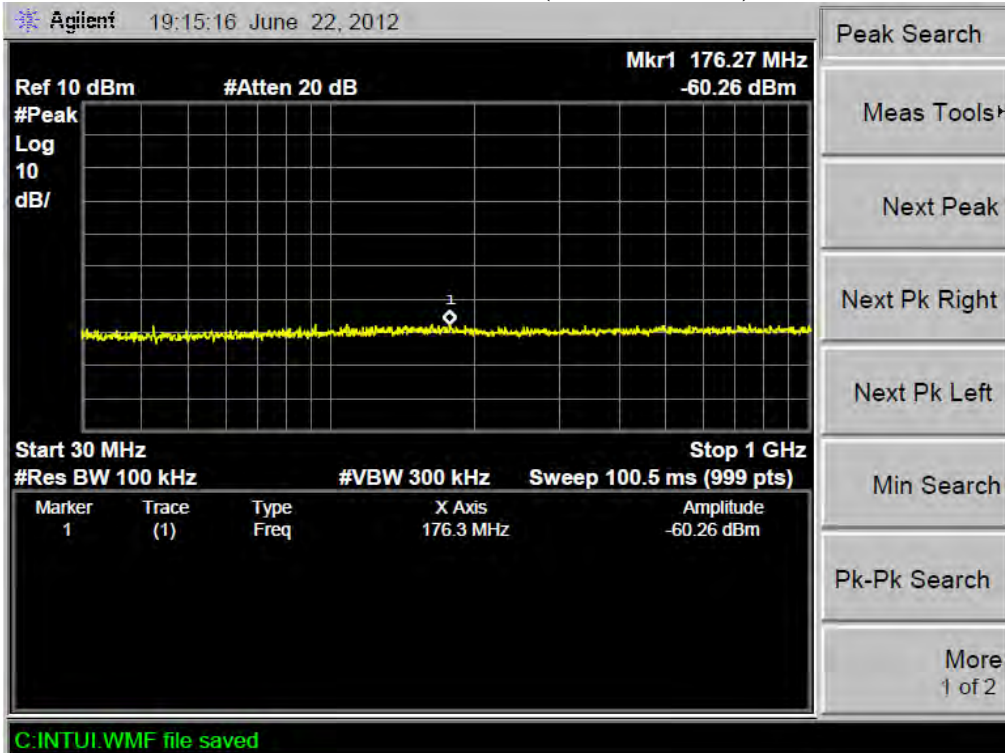

TX 802.11b Channel Middle 2437MHz (1GHz-25GHz)

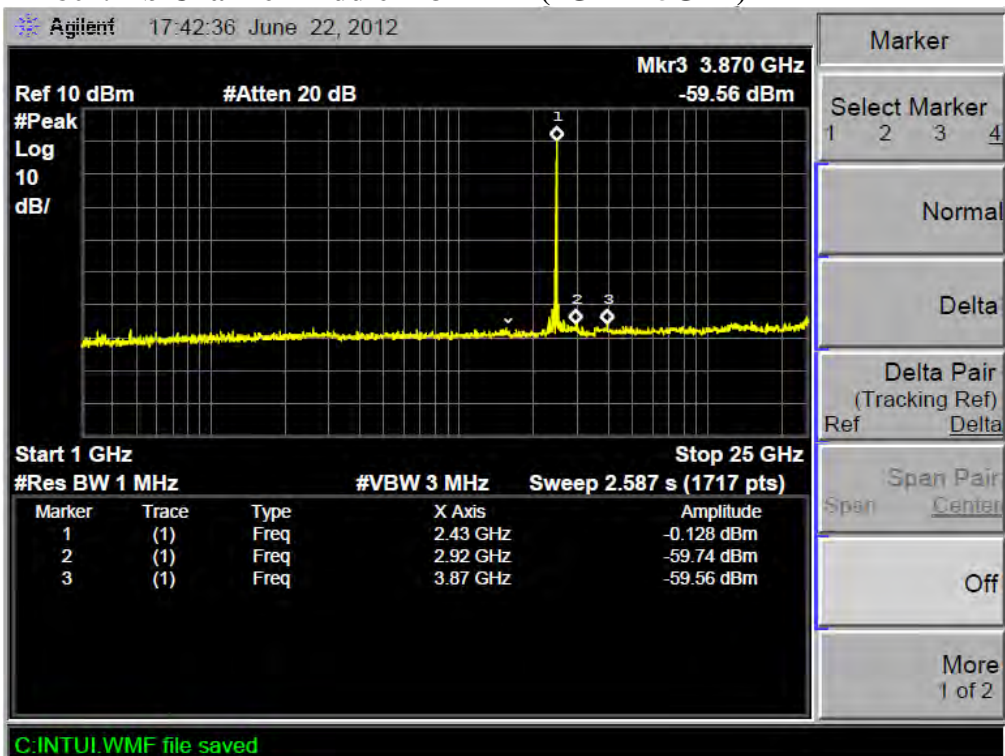

TX 802.11b Channel High 2462MHz (30MHz-1GHz)

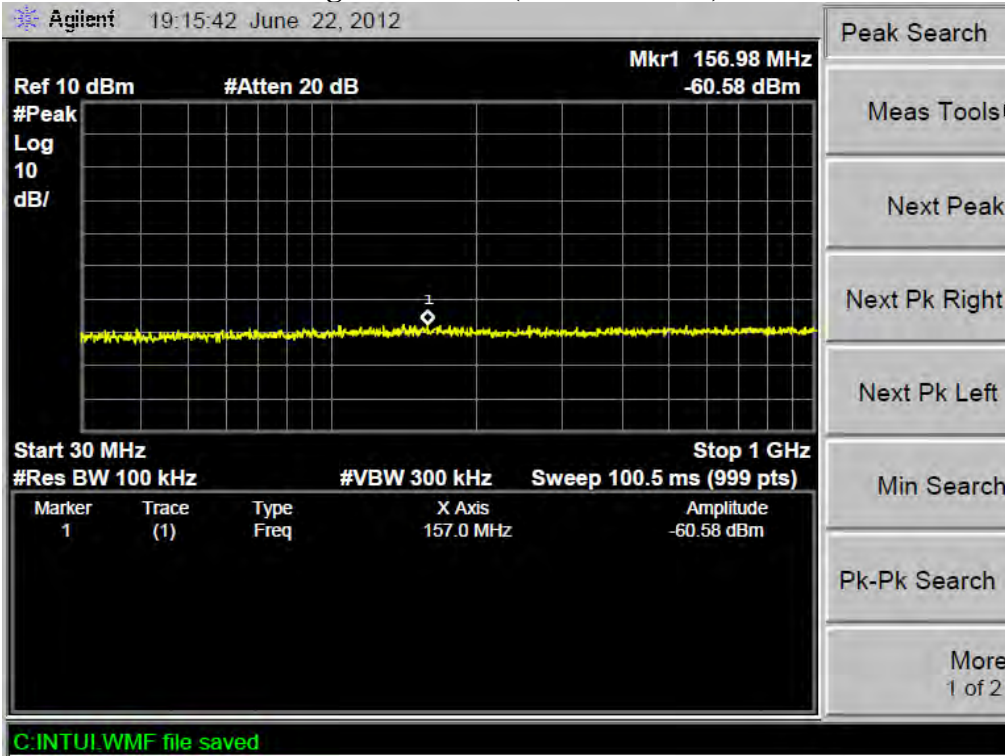

TX 802.11b Channel High 2462MHz (1GHz-25GHz)

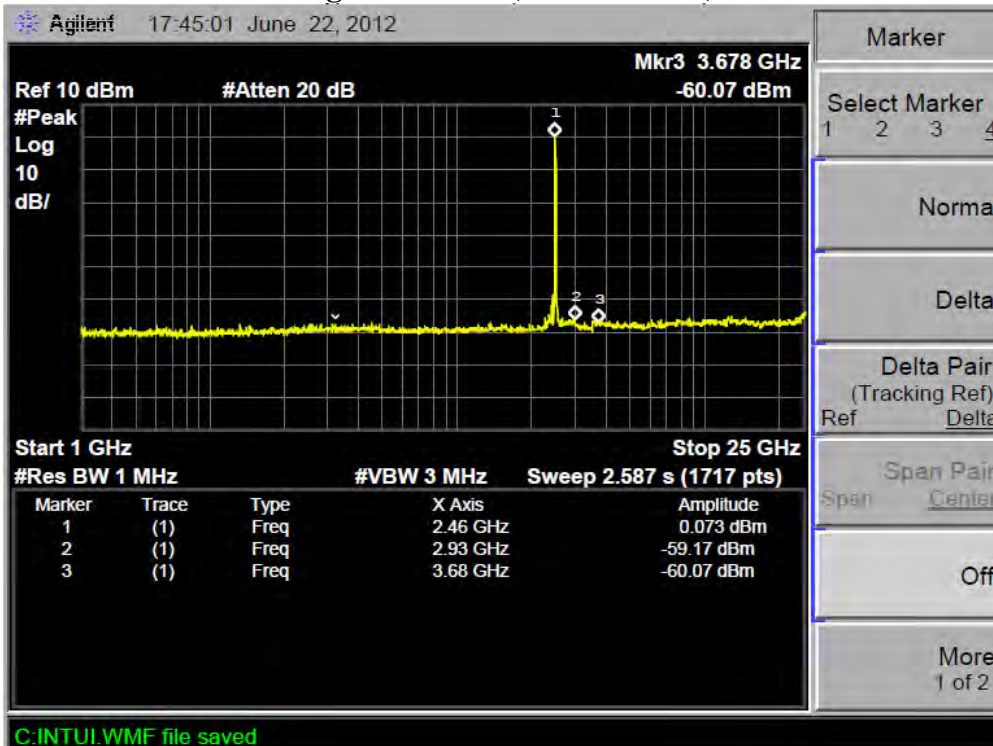

TX 802.11g Channel Low 2412MHz (30MHz-1GHz)

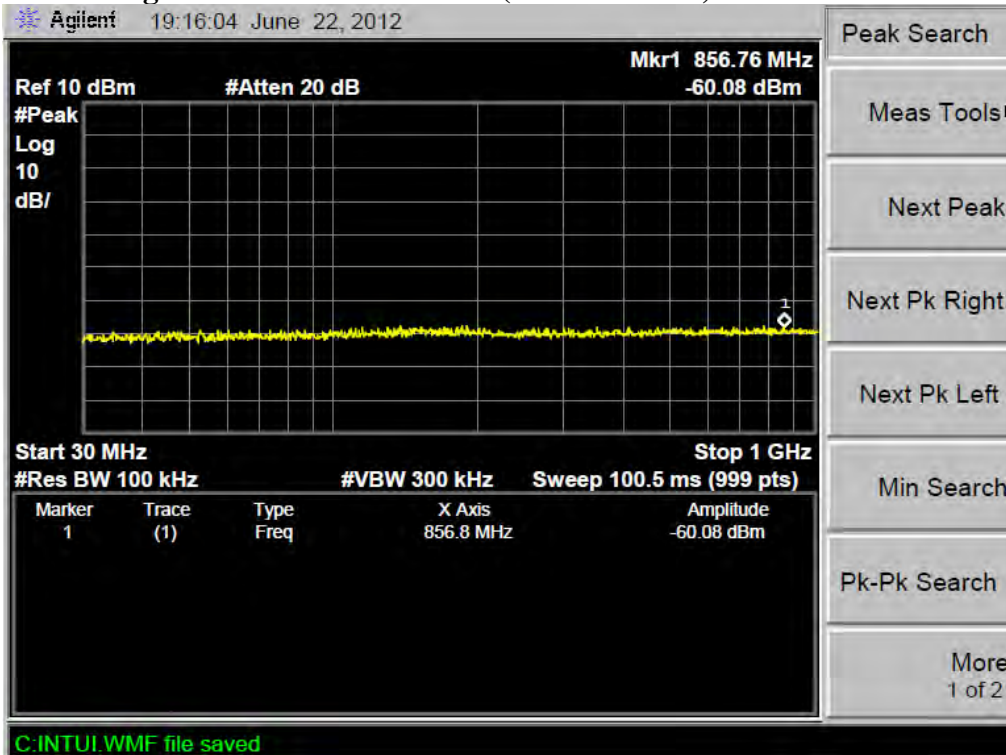

TX 802.11g Channel Low 2412MHz (1GHz-25GHz)

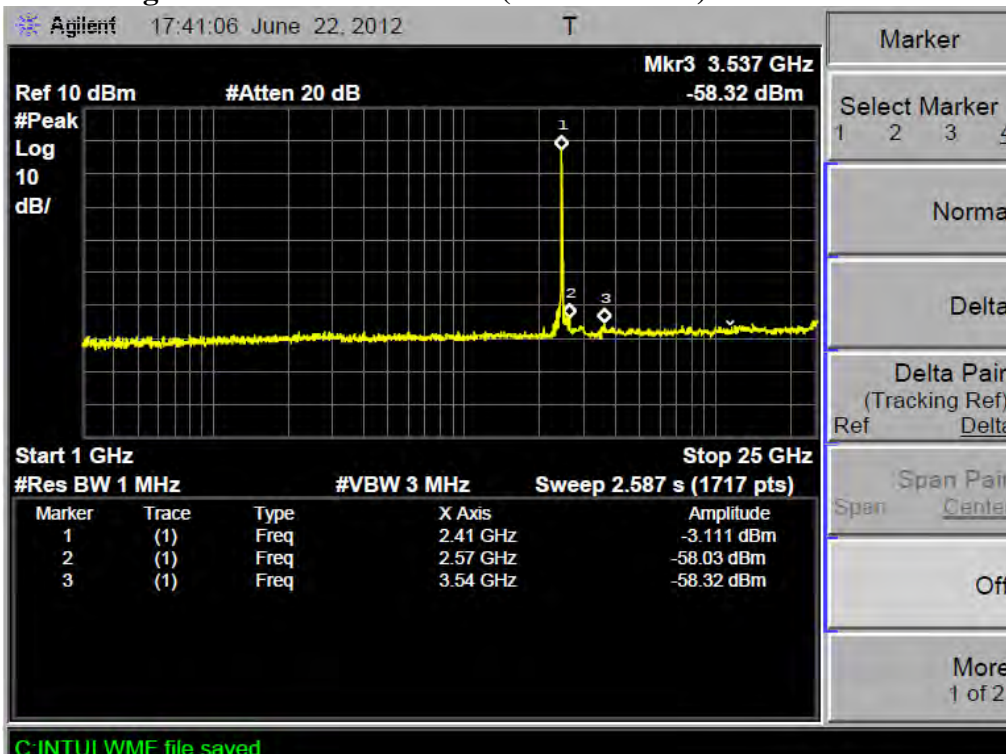

TX 802.11g Channel Middle 2437MHz (30MHz-1GHz)

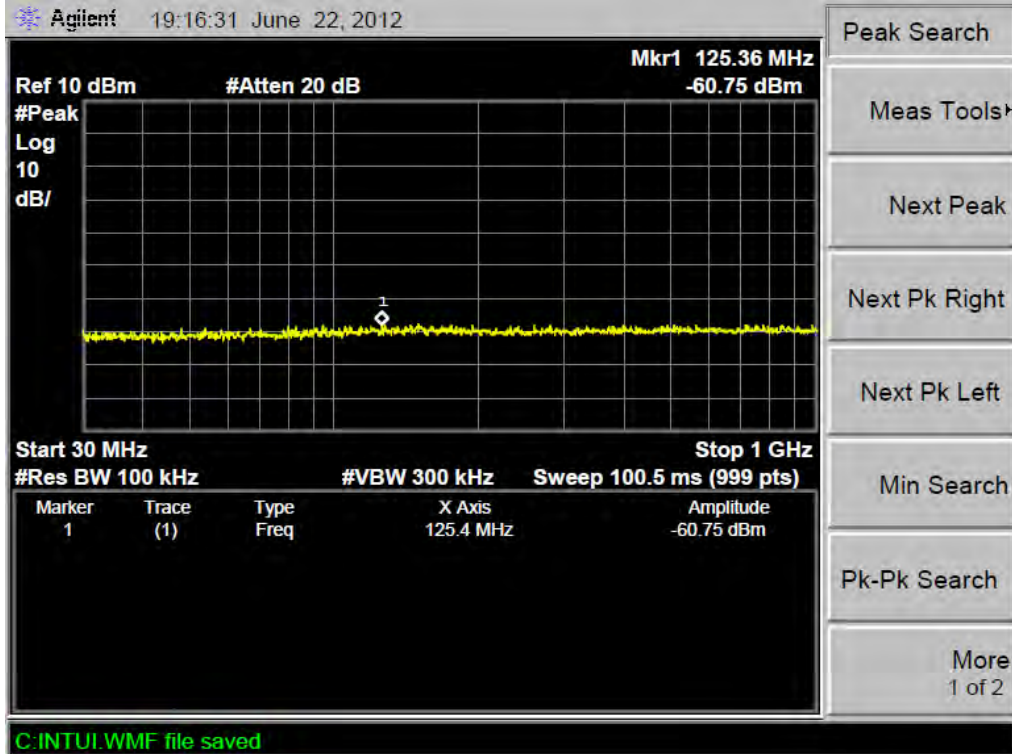

TX 802.11g Channel Middle 2437MHz (1GHz-25GHz)

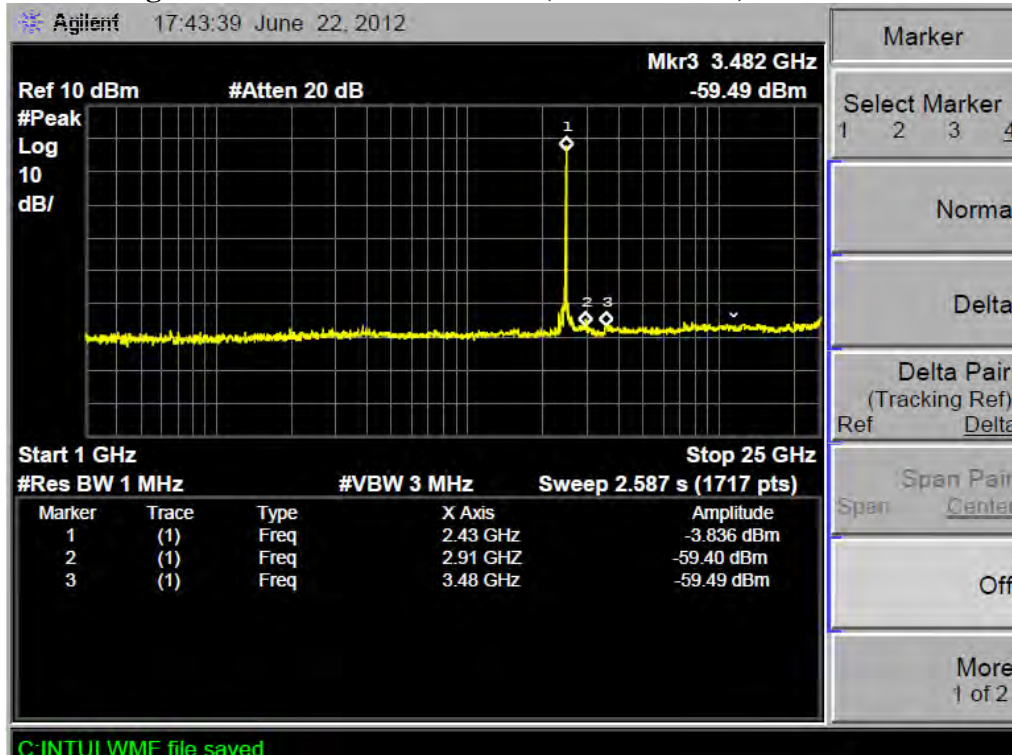

TX 802.11g Channel High 2462MHz (30MHz-1GHz)

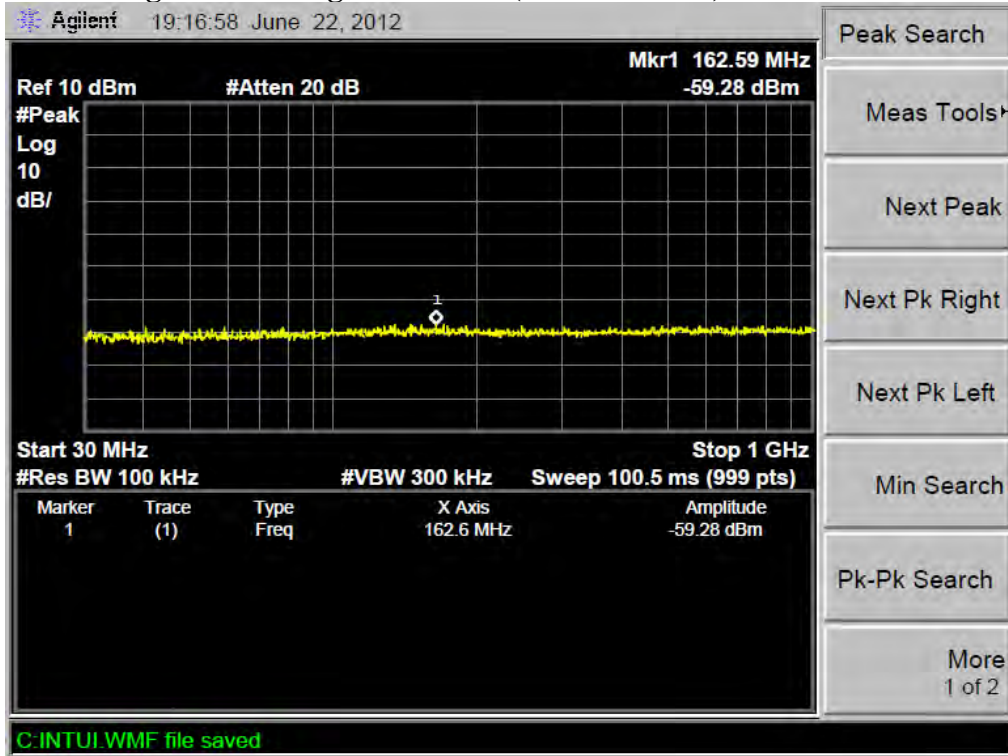

TX 802.11g Channel High 2462MHz (1GHz-25GHz)

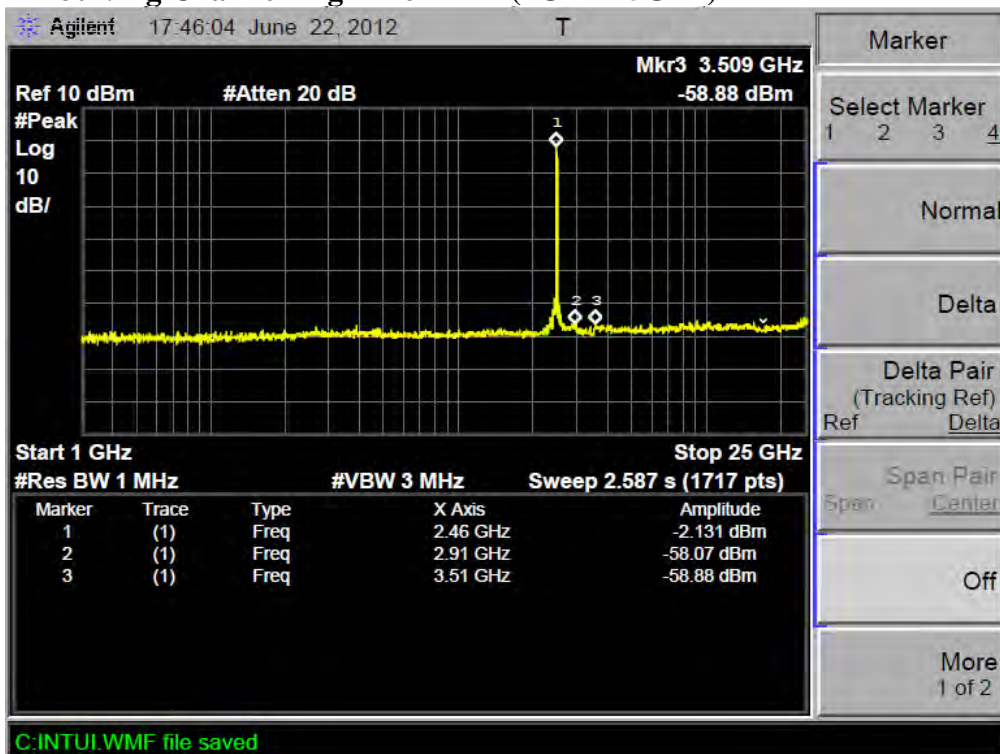

11.AC POWER LINE CONDUCTED EMISSION FOR FCC PART

15 SECTION 15.207(A)

11.1.Block Diagram of Test Setup

11.1.1.Block diagram of connection between the EUT and simulators

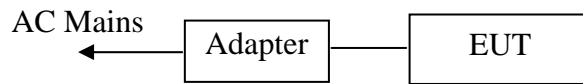

(EUT: MC200Air)

11.1.2.Shielding Room Test Setup Diagram

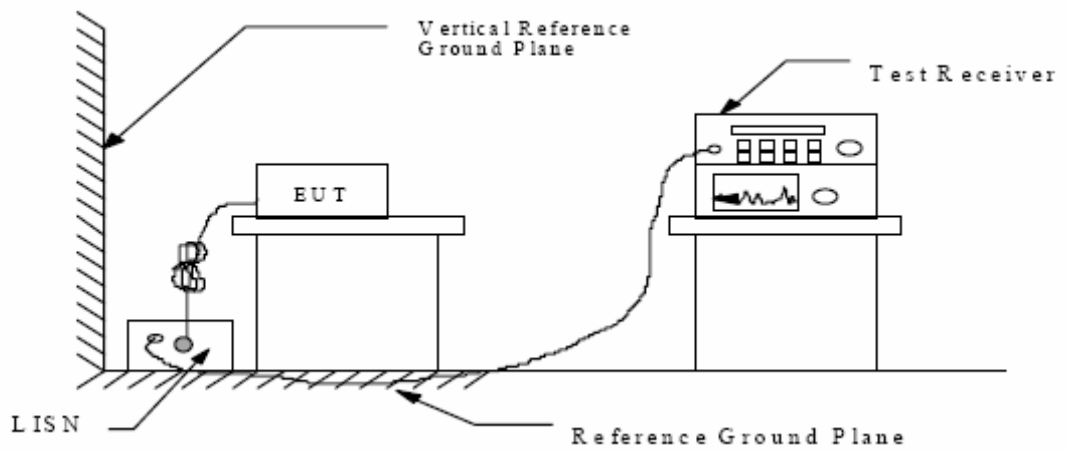

(EUT: MC200Air)

11.2.The Emission Limit

11.2.1.Conducted Emission Measurement Limits According to Section 15.207(a)

Frequency (MHz)	Limit dB(μV)	
	Quasi-peak Level	Average Level
0.15 - 0.50	66.0 – 56.0 *	56.0 – 46.0 *
0.50 - 5.00	56.0	46.0
5.00 - 30.00	60.0	50.0

* Decreases with the logarithm of the frequency.

11.3. Configuration of EUT on Measurement

The following equipment are installed on the Conducted Emission Measurement to meet the commission requirements and operating regulations in a manner which tends to maximize its emission characteristics in normal application.

11.3.1. MC200Air (EUT)

Model Number : MC200Air
Serial Number : N/A
Manufacturer : Boston Acoustics, Inc.

11.4. Operating Condition of EUT

11.4.1. Setup the EUT and simulator as shown as Section 11.1.

11.4.2. Turn on the power of all equipment.

11.4.3. Let the EUT work in Tx mode measure it.

11.5. Test Procedure

The EUT is put on the plane 0.8m high above the ground by insulating support and is connected to the power mains through a line impedance stabilization network (L.I.S.N.). This provides a 50ohm coupling impedance for the EUT system. Please refer the block diagram of the test setup and photographs. Both sides of AC lines are checked to find out the maximum conducted emission. In order to find the maximum emission levels, the relative positions of equipment and all of the interface cables shall be changed according to ANSI C63.4: 2003 on Conducted Emission Measurement.

The bandwidth of test receiver (R & S ESCS30) is set at 9kHz.

The frequency range from 150kHz to 30MHz is checked.

11.6. Power Line Conducted Emission Measurement Results

PASS.

The frequency range from 150kHz to 30MHz is checked.

Date of Test:	<u>June 25, 2012</u>	Temperature:	<u>25°C</u>
EUT:	<u>MC200Air</u>	Humidity:	<u>50%</u>
Model No.:	<u>MC200Air</u>	Power Supply:	<u>AC 120/60Hz</u>
Test Mode:	<u>Tx</u>	Test Engineer:	<u>Pei</u>

Frequency (MHz)	Result (dB μ V)	Limit (dB μ V)	Margin (dB)	Detector	Line
0.167071	40.50	65.1	-24.6	QP	Neutral
0.458702	32.20	56.7	-24.5	QP	
0.477384	37.50	56.4	-18.9	QP	
0.203167	21.30	53.5	-32.2	AV	
0.458702	25.50	46.7	-21.2	AV	
0.479294	29.90	45.4	-16.5	AV	
0.151807	38.90	65.9	-27.0	QP	Live
0.458702	32.40	56.7	-24.3	QP	
0.479294	38.30	56.4	-18.1	QP	
0.223595	17.30	52.7	-35.4	AV	
0.458702	23.10	46.7	-23.6	AV	
0.479294	29.30	46.4	-17.1	AV	

Emissions attenuated more than 20 dB below the permissible value are not reported.
The spectral diagrams are attached as below.

ACCURATE TECHNOLOGY CO.,LTD

CONDUCTED EMISSION STANDARD FCC PART15B

EUT: MC200Air M/N:MC200Air
 Manufacturer: Boston
 Operating Condition: TX
 Test Site: 1#Shielding Room
 Operator: Bob
 Test Specification: N 120V/60Hz
 Comment: Report NO.:ATE20120668
 Start of Test: 6/25/2012 / 6:50:25PM

SCAN TABLE: "V 150K-30MHz fin"

Short Description: _SUB_STD_VTERM2 1.70
 Start Stop Step Detector Meas. IF Transducer
 Frequency Frequency Width Time Bandw.
 150.0 kHz 30.0 MHz 0.8 % QuasiPeak 1.0 s 9 kHz NSLK8126 2008
 Average

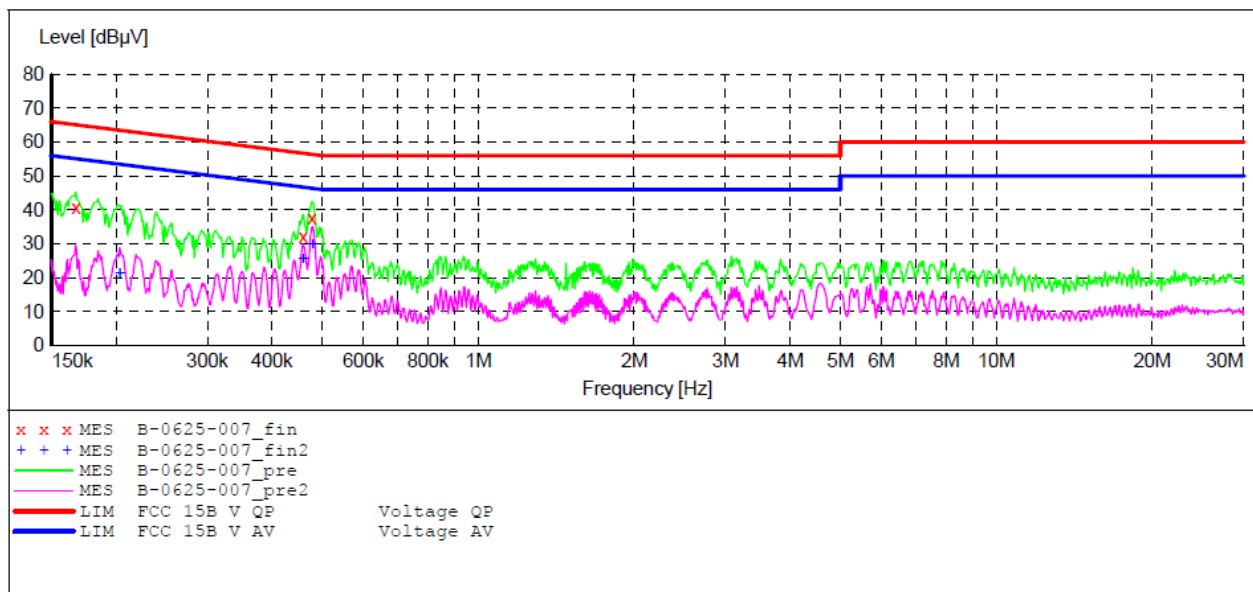

MEASUREMENT RESULT: "B-0625-007_fin"

6/25/2012 6:51PM

Frequency MHz	Level dBµV	Transd dB	Limit dBµV	Margin dB	Detector	Line	PE
0.167071	40.50	11.1	65.1	24.6	QP	N	GND
0.458702	32.20	11.9	56.7	24.5	QP	N	GND
0.477384	37.50	12.0	56.4	18.9	QP	N	GND

MEASUREMENT RESULT: "B-0625-007_fin2"

6/25/2012 6:51PM

Frequency MHz	Level dBµV	Transd dB	Limit dBµV	Margin dB	Detector	Line	PE
0.203167	21.30	11.3	53.5	32.2	AV	N	GND
0.458702	25.50	11.9	46.7	21.2	AV	N	GND
0.479294	29.90	12.0	46.4	16.5	AV	N	GND

ACCURATE TECHNOLOGY CO., LTD

CONDUCTED EMISSION STANDARD FCC PART15B

EUT: MC200Air M/N:MC200Air
 Manufacturer: Boston
 Operating Condition: TX
 Test Site: 1#Shielding Room
 Operator: Bob
 Test Specification: L 120V/60Hz
 Comment: Report NO.:ATE20120668
 Start of Test: 6/25/2012 / 6:52:06PM

SCAN TABLE: "V 150K-30MHz fin"

Short Description: _SUB_STD_VTERM2 1.70
 Start Stop Step Detector Meas. IF Transducer
 Frequency Frequency Width Time Bandw.
 150.0 kHz 30.0 MHz 0.8 % QuasiPeak 1.0 s 9 kHz NSLK8126 2008
 Average

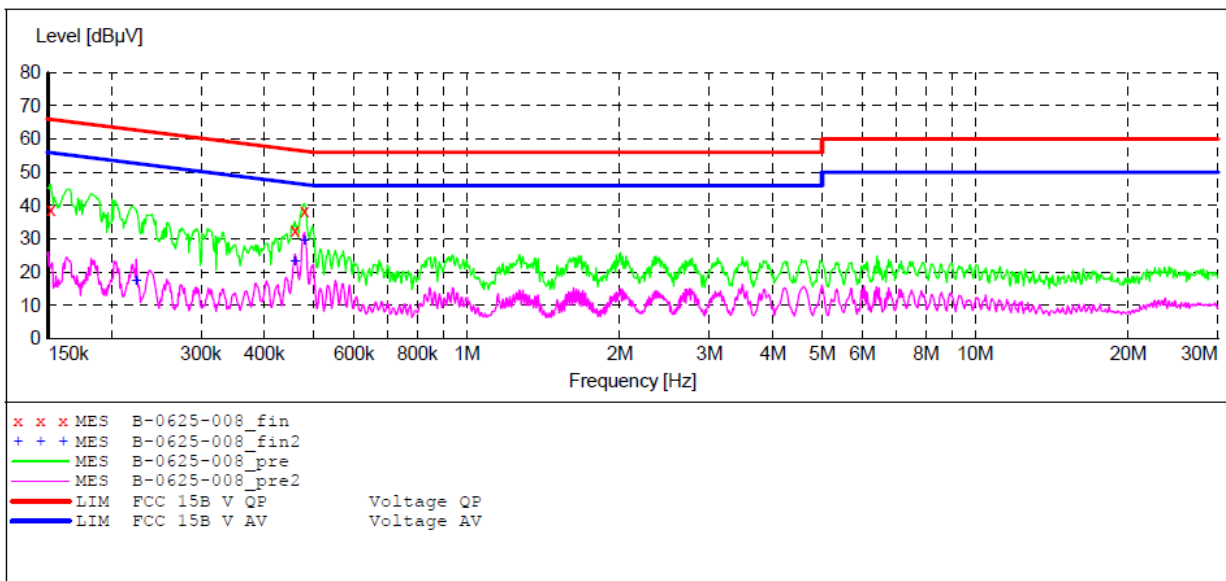

MEASUREMENT RESULT: "B-0625-008_fin"

6/25/2012 6:54PM

Frequency MHz	Level dBµV	Transd dB	Limit dBµV	Margin dB	Detector	Line	PE
0.151807	38.90	11.0	65.9	27.0	QP	L1	GND
0.458702	32.40	11.9	56.7	24.3	QP	L1	GND
0.479294	38.30	12.0	56.4	18.1	QP	L1	GND

MEASUREMENT RESULT: "B-0625-008_fin2"

6/25/2012 6:54PM

Frequency MHz	Level dBµV	Transd dB	Limit dBµV	Margin dB	Detector	Line	PE
0.223595	17.30	11.3	52.7	35.4	AV	L1	GND
0.458702	23.10	11.9	46.7	23.6	AV	L1	GND
0.479294	29.30	12.0	46.4	17.1	AV	L1	GND

12. ANTENNA REQUIREMENT

12.1. The Requirement

According to Section 15.203, an intentional radiator shall be designed to ensure that no antenna other than that furnished by the responsible party shall be used with the device.

12.2. Antenna Construction

Device is equipped with unique antenna, which isn't displaced by other antenna. Therefore, the equipment complies with the antenna requirement of Section 15.203.

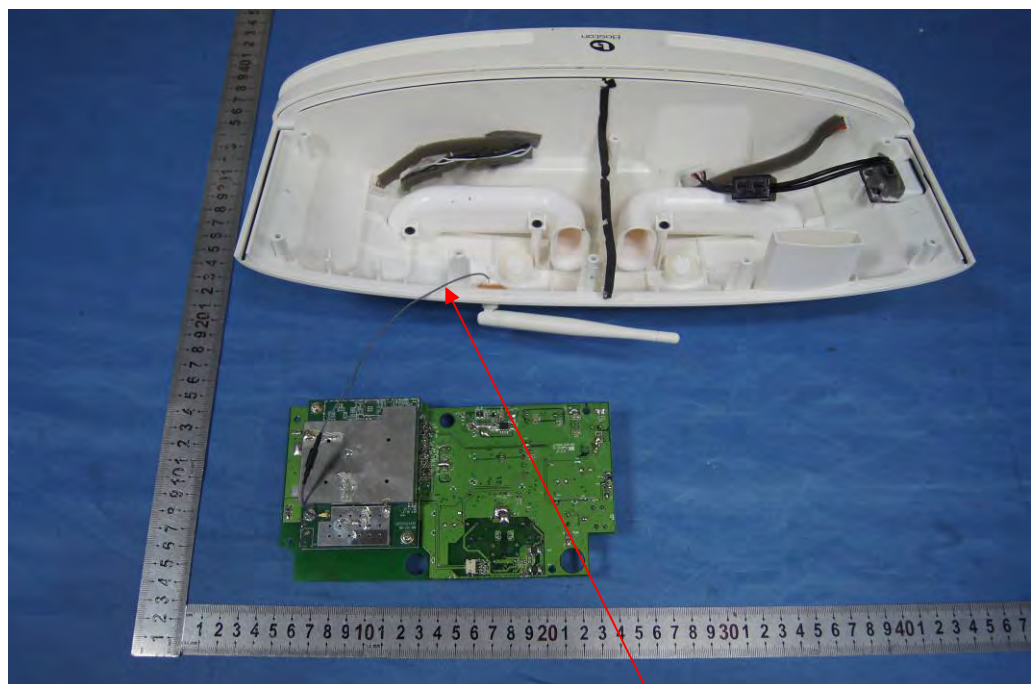

Antenna