

FCC CFR47 PART 90 SUBPART Z

Test Report

3.65 GHz Fixed Wireless Base Station Transceiver – 2x2 MIMO Configuration

Model Number: Quantum 2236

FCC ID: XN3-QUANTUM6636

IC: 8974A-QUANTUM6636

Report Number: 10PRO01719

Issue Date: 4 September 2010

Prepared for
PureWave Networks Inc.
2660-C Marine Way
Mountain View, CA 94043

Prepared by
T.N. Cokenias Consulting
P.O. Box 1086
El Granada CA 94018

Report Revision History

Revision No.	Description	Revised by	Date
-	Original issue	T.N. Cokenias	4 Sept 2010

TABLE OF CONTENTS

1. TEST AND TEST LOCATION INFORMATION	4
2. TEST METHODOLOGY	5
3. EQUIPMENT UNDER TEST	5
3.1. DESCRIPTION OF EUT	5
3.2. MAXIMUM OUTPUT POWER SETTINGS FOR TESTS.....	5
3.3. ANTENNA SELECTION AND EIRP LIMITS.....	6
3.4. SOFTWARE AND FIRMWARE.....	6
3.5. WORST-CASE CONFIGURATION AND MODE.....	6
3.6. DESCRIPTION OF TEST SETUP	7
3.7 Modifications to EUT.....	7
3.8 TEST AND MEASUREMENT EQUIPMENT.....	8
4. LIMITS AND RESULTS	9
4.1 ANTENNA PORT CHANNEL TESTS.....	9
4.1.1 -26 dB and 99% OCCUPIED BANDWIDTH.....	9
4.6.1.2 PEAK OUTPUT POWER	17
4.6.1.3 PEAK EIRP POWER DENSITY LIMIT	18
4.6.1.4 MAXIMUM PERMISSIBLE EXPOSURE.....	19
4.6.1.5 CONDUCTED SPURIOUS EMISSIONS.....	22
4.6.2 RADIATED EMISSIONS.....	41
4.6.2.1 TRANSMITTER RADIATED EMISSIONS ABOVE 1 GHZ HARMONICS AND SPURIOUS EMISSIONS.....	42
4.6.2.2 TRANSMITTER RADIATED EMISSIONS BELOW 1 GHZ SPURIOUS AND DIGITAL SECTION EMISSIONS	43
4.6.3 FREQUENCY STABILITY TEST.....	45

1. TEST AND TEST LOCATION INFORMATION

COMPANY NAME: PureWave Networks, Inc.
2660-C Marine Way
Mountain View, CA 94043

EUT DESCRIPTION: FCC Part 90Z Base Station
Frequency Range: 3650-3675MHz
WiMax 6x6 MIMO Configuration
Channel Bandwidths: 5 MHz, 10 MHz
Modulations: QPSK, 16QAM, 64QAM

FCC ID: XN3-QUANTUM6636
IC: 8974A-QUANTUM6636

MODEL: Quantum 2236

DATE TESTED: 22 June, 28-30 June, 8-13 July, 26 and 30 August 2010

Radiated and Occupied Bandwidth antenna port conducted tests were performed by

Compliance Certification Services
47173 Benicia Street
Fremont, CA 94538

Other antenna port and frequency stability tests were performed at

PureWave Networks, Inc.
2660-C Marine Way
Mountain View, CA 94043



T.N. Cokenias
Agent for PureWave Networks, Inc.

4 September 2010

2. TEST METHODOLOGY

The tests documented in this report were performed in accordance with EIA/TIA 603, FCC CFR 47 Part 2 and FCC CFR 47 Part 90Subpart Z.

3. EQUIPMENT UNDER TEST

3.1. DESCRIPTION OF EUT

The EUT is a WiMAX base station radio operating in the 3650-3675 MHz restricted contention-based protocol frequency band. Modulation is 802.16d/e in 5 MHz and 10 MHz channel bandwidths. The EUT is capable of operation in 2x2 MIMO and 6x6 MIMO modes. This report will cover only 2x2 MIMO operation measurements. A separate report covers 6x6 MIMO operation.

3.2. MAXIMUM OUTPUT POWER SETTINGS FOR TESTS

5 MHz EBW		QPSK	16QAM	64QAM
	(MHz)	(dBm)	(dBm)	(dBm)
Low	3652.5	28	28	28
Middle	3662.5	35	35	35
High	3672.5	29	29	29

10 MHz EBW		QPSK	16QAM	64QAM
	(MHz)	(dBm)	(dBm)	(dBm)
Low	3655	29	29	29
Middle	3662.5	36	36	36
High	3670	30	30	30

All other 5 MHz Channels: 35 dBm power setting

All other 10 MHz channels: 36 dBm power setting

3.3. ANTENNA SELECTION AND EIRP LIMITS

The licensee can select a variety of antenna types and gains from a variety of manufacturers in addition to PureWave Networks. It is the responsibility of the licensee to adjust transmitter output power such that the eirp limits specified in section 90.1321 (a) of the Rules are not exceeded:

90.1321(a) Base stations and fixed stations are limited to 25watts/25 MHz equivalent isotropic radiated power (EIRP). In any event the EIRP power density shall not exceed 1 watt in any on-megahertz slice of spectrum.

The antenna port output powers for this product are calculated based on the following typical installation parameters:

1. A minimum 6 dBi antenna for use with base stations,
2. 30m cable loss for TMC LMR-400 at 3.65 MHz = 8.3 dB
3. Effective antenna gain: $6 - 8.3 = -2.3$ dBi

The PureWave installation manual provides the installer guidance on how to calculate the maximum input power to the antenna so as to remain within the regulatory EIRP limits.

3.4. SOFTWARE AND FIRMWARE

The software controlling the EUT during testing was PureWave OS v1.1.1.

3.5. WORST-CASE CONFIGURATION AND MODE

Radiated and conducted emissions tests were performed for both 5 MHz and 10 MHz emission bandwidth channels. Testing was performed for all available modulations: QPSK, 16QAM and 64QAM.

Worst-case emissions for both emissions bandwidths are reported.

3.6. DESCRIPTION OF TEST SETUP

SETUP DIAGRAM FOR TESTS

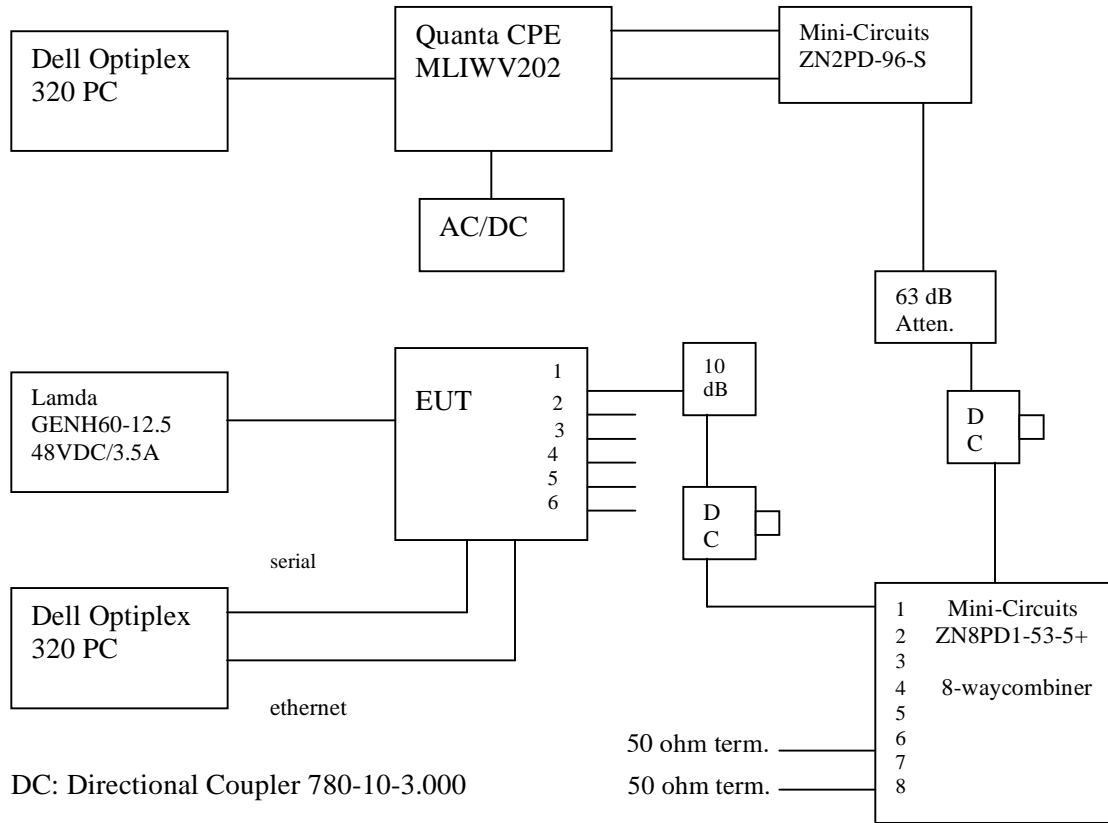

3.7 Modifications to EUT

None.

3.8 TEST AND MEASUREMENT EQUIPMENT

The following test and measurement equipment was utilized for the tests documented in this report

CCS: Radiated Emissions

TEST EQUIPMENT LIST				
Description	Manufacturer	Model	Asset Number	Cal Due
Spectrum Analyzer, 26.5 GHz	Agilent / HP	E4440A	C01179	08/24/10
Antenna, Bilog, 2 GHz	Sunol Sciences	JB1	C01011	07/14/10
Antenna, Horn, 18 GHz	EMCO	3115	C00945	07/29/10
Preamplifier, 1300 MHz	Agilent / HP	8447D	C00885	07/06/10
Preamplifier, 26.5 GHz	Agilent / HP	8449B	C01052	08/04/10

CCS: Antenna Port Conducted Emissions (Occupied Bandwidth)

TEST EQUIPMENT LIST				
Description	Manufacturer	Model	Asset/Serial Number	Cal Due
Spectrum Analyzer, 44 GHz	Agilent / HP	E4446A	C01069	01/05/11
Vector signal generator, 20GHz	Agilent / HP	E8267C	C01066	11/16/10

PureWave: Antenna Port Conducted Tests

Description	Manufacturer	Model	Asset/Serial Number	Cal Due
N9020A Signal Analyze	Agilent	N9020A	MY46472174	07/09/11

PureWave: Frequency Stability Test Equipment

TEST EQUIPMENT LIST				
Description	Manufacturer	Model	Asset Number	Cal Due
Wireless Networking Test Set	Agilent	N8300A	GB47350121	20Sept2010
Variable Voltage Source	Lambda	GENH60-12.5	27M4950F	N/A
Temperature Chamber	Associated Environmental Systems	ZBD-108	6381	N/A
Multi meter	GW Instek	GDM-8245	CH881834	N/A

4. LIMITS AND RESULTS

4.1 ANTENNA PORT CHANNEL TESTS

4.1.1 -26 dB and 99% OCCUPIED BANDWIDTH

REQUIREMENT

2.1049 Measurements required: Occupied bandwidth.

The occupied bandwidth, that is the frequency bandwidth such that, below its lower and above its upper frequency limits, the mean powers radiated are each equal to 0.5 percent of the total mean power radiated by a given emission shall be measured.

TEST PROCEDURE

The transmitter output is connected to a spectrum analyzer. The RBW is set to 1% to 3% of the 99% bandwidth. The VBW is set to 3 times the RBW. The sweep time is coupled. The internal OCC BW function of the spectrum analyzer was activated to display both 99% BW and -26 dB BW values.

TEST RESULTS

For each EBW and modulation, occupied bandwidth was measured for each chain. The values obtained were very similar chain by chain, within 2% of each other. The same can be said for the different modulations – for a given EBW, the measured value changed very little from modulation to modulation or from chain to chain.

Spectrum analyzer plots for all chains and all modulations at Low channel are presented below to document the fact that there are only small variations in value from chain to chain (B).

These values are summarized in the table below (A).

A. Occupied BW Summay

5MHz EBW QPSK

Channel	Frequency MHz	99% Occupied Bandwidth, MHz	-26 dB Bandwidth, MHz
Low	3652.5	4.5406	4.796
Middle	3662.5	4.5737	4.748
High	3672.5	4.5454	4.771

5MHz EBW 16QAM

Channel	Frequency MHz	99% Occupied Bandwidth, MHz	-26 dB Bandwidth, MHz
Low	3652.5	4.5601	4.743
Middle	3662.5	4.5411	4.740
High	3672.5	4.5371	4.745

5MHz EBW 64QAM

Channel	Frequency MHz	99% Occupied Bandwidth, MHz	-26 dB Bandwidth, MHz
Low	3652.5	4.5452	4.747
Middle	3662.5	4.547	4.788
High	3672.5	4.5473	4.743

10 MHz EBW QPSK

Channel	Frequency MHz	99% Occupied Bandwidth, MHz	-26 dB Bandwidth, MHz
Low	3655	9.0819	9.391
Middle	3662.5	9.1128	9.379
High	3670	9.1157	9.402

10 MHz EBW 16QAM

Channel	Frequency MHz	99% Occupied Bandwidth, MHz	-26 dB Bandwidth, MHz
Low	3655	9.0886	9.384
Middle	3662.5	9.0428	9.370
High	3670	9.1021	9.394

10 MHz EBW 64QAM

Channel	Frequency MHz	99% Occupied Bandwidth, MHz	-26 dB Bandwidth, MHz
Low	3655	9.0837	9.378
Middle	3662.5	9.0714	9.410
High	3670	9.0966	9.395

B. 5 MHz EBW, Low Channel QPSK

Chain 1

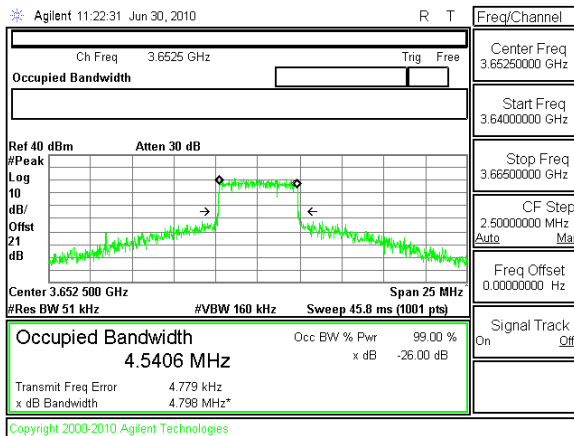

Chain 2

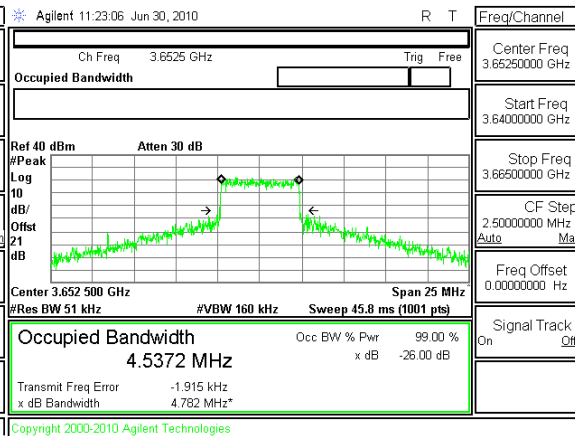

Chains 1-6, 5 MHz EBW, Mid Channel QPSK

Chain 1

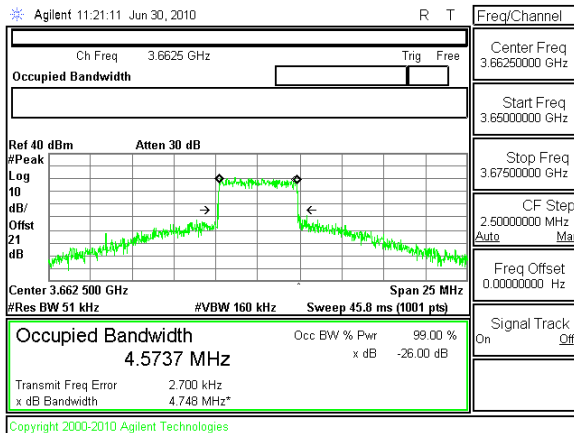

Chain 2

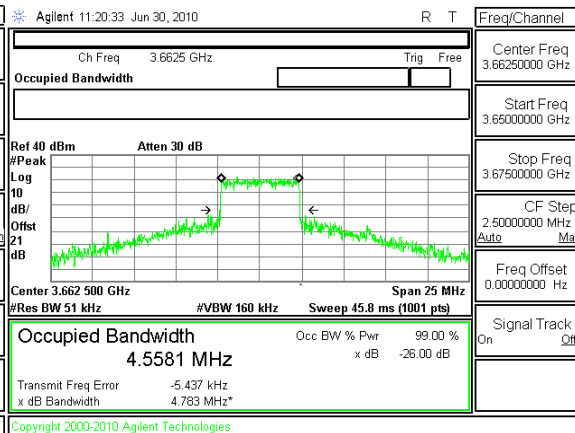

Chains 1-6, 5 MHz EBW, High Channel QPSK

Chain 1

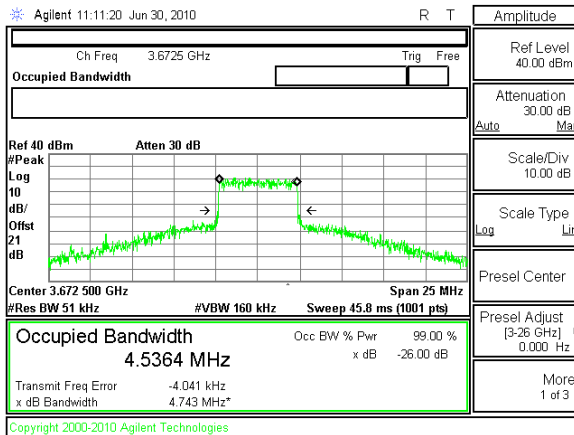

Chain 2

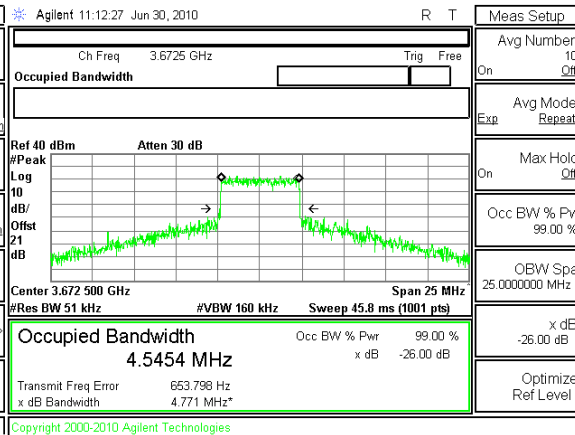

Highest OccBW: 4.5737 MHz

B. 5MHz EBW, Low Channel 16QAM

Chain 1

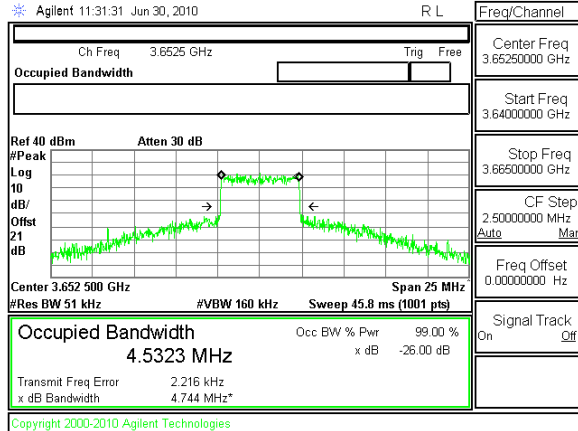

Chain 2

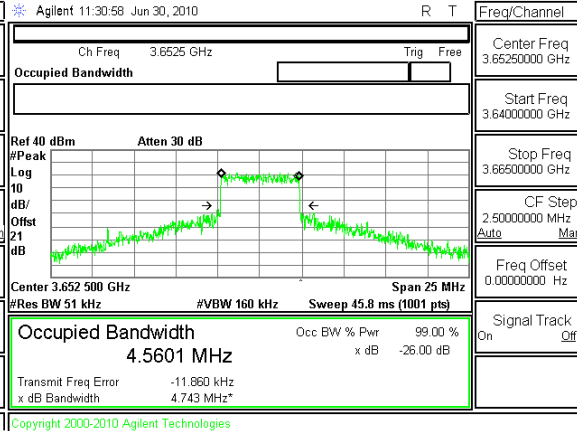

5MHz EBW, Mid Channel 16QAM

Chain 1

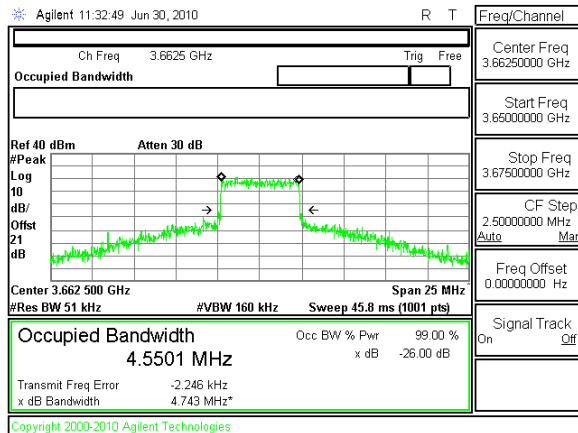

Chain 2

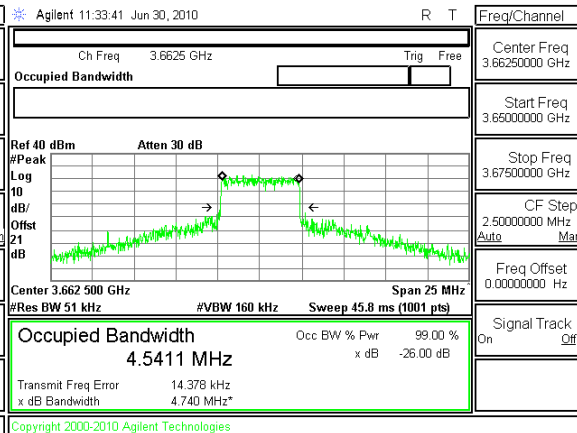

5MHz EBW, High Channel 16QAM

Chain 1

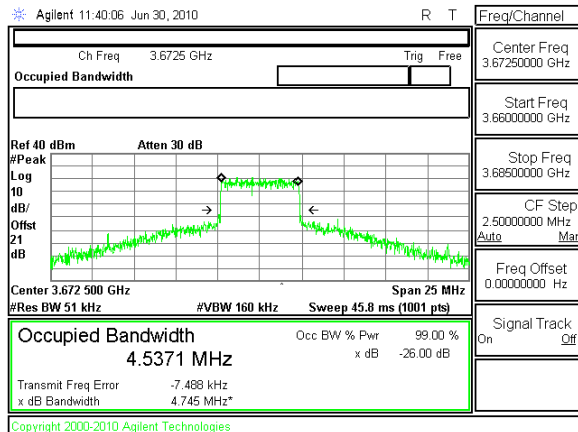

Chain 2

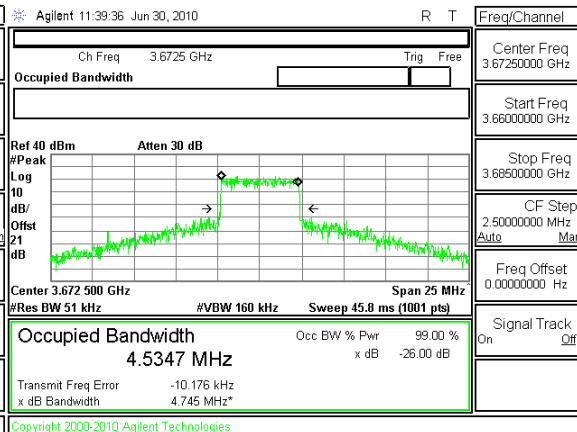

Highest OccBW: 4.5601 MHz

B. 5MHz EBW, Low Channel 64QAM

Chain 1

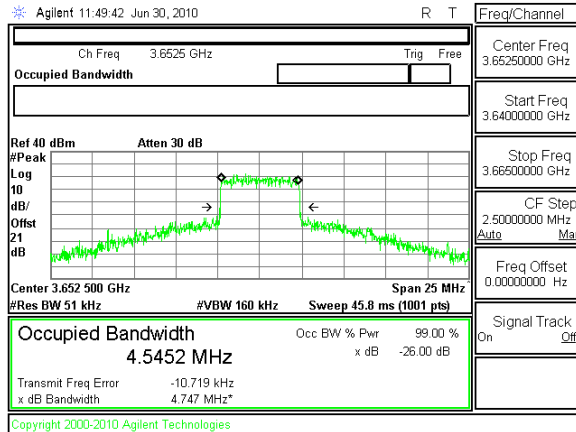

Chain 2

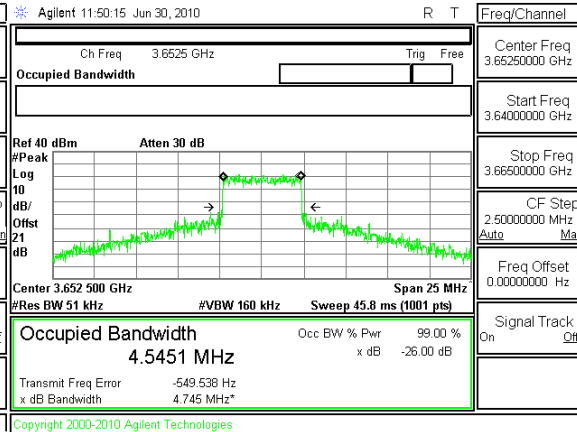

5MHz EBW, Mid Channel 64QAM

Chain 1

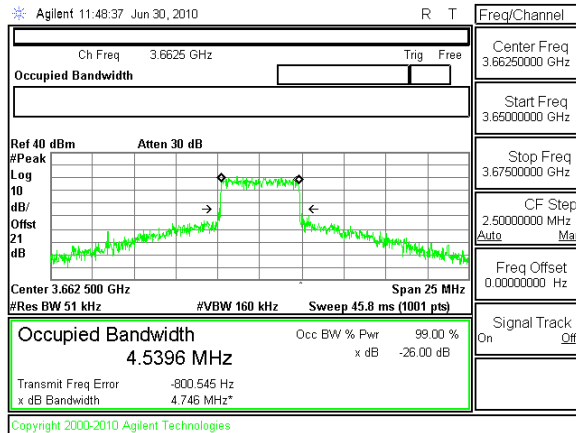

Chain 2

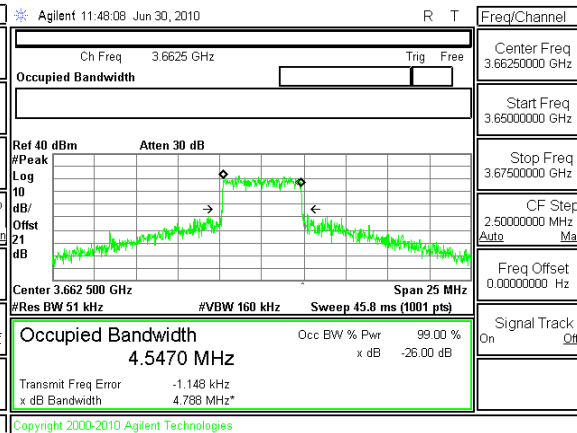

5MHz EBW, High Channel 64QAM

Chain 1

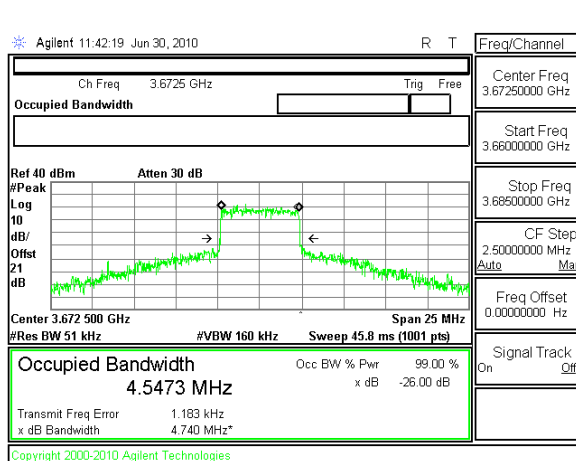

Chain

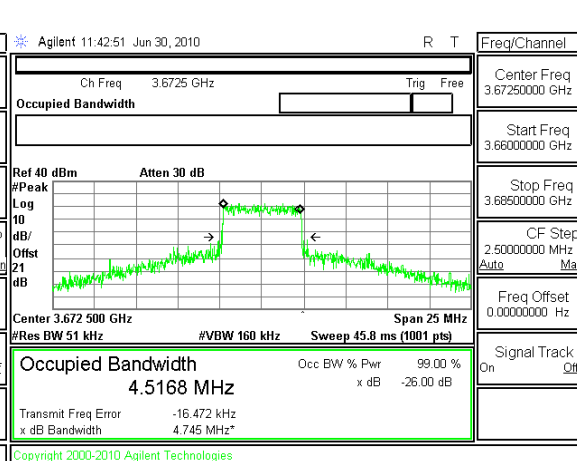

Highest OccBW: 4.5452 MHz

B. 10 MHz EBW, Low Channel QPSK

Chain 1

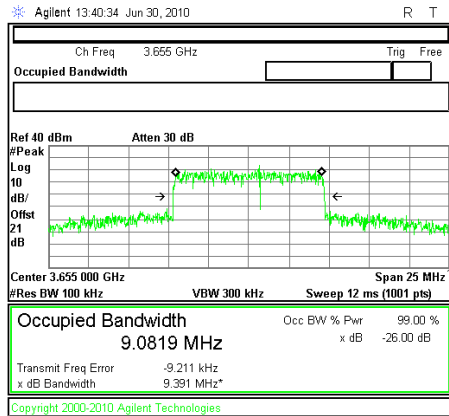

Chain 2

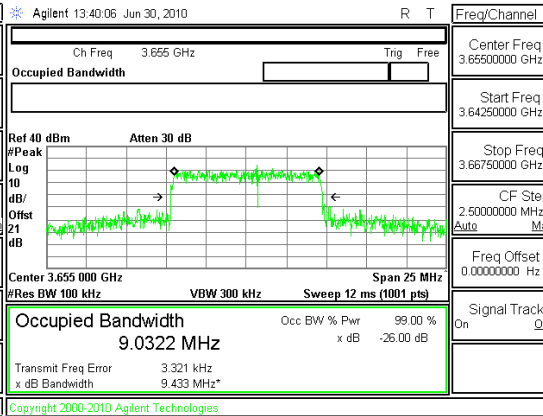

10MHz EBW, Mid Channel QPSK

Chain 1

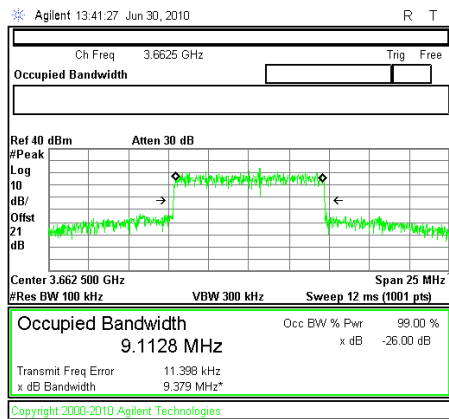

Chain 2

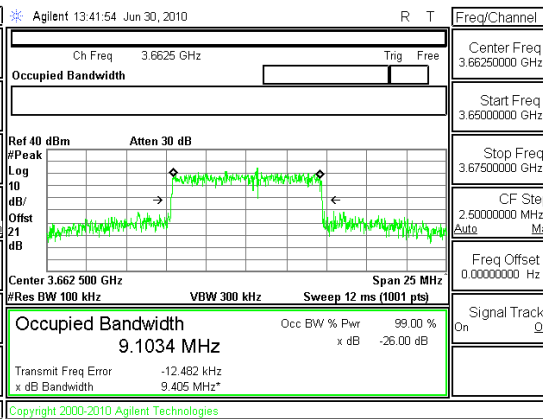

10MHz EBW, High Channel QPSK

Chain 1

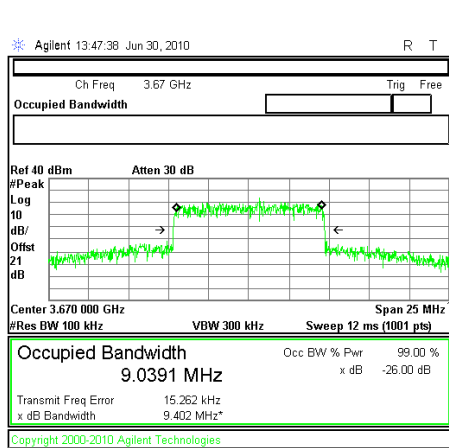

Chain

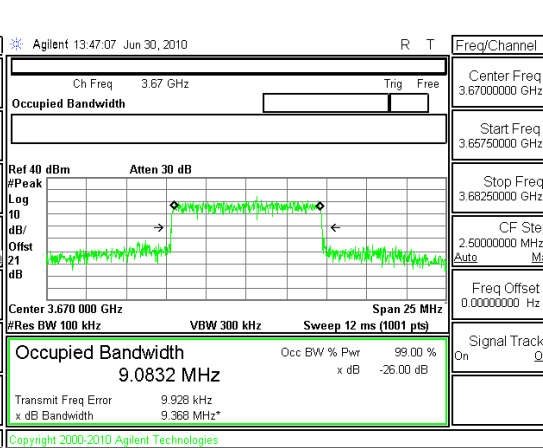

Highest OccBW: 9.1128 MHz

B. 10 MHz EBW, Low Channel 16QAM

Chain 1

Chain 2

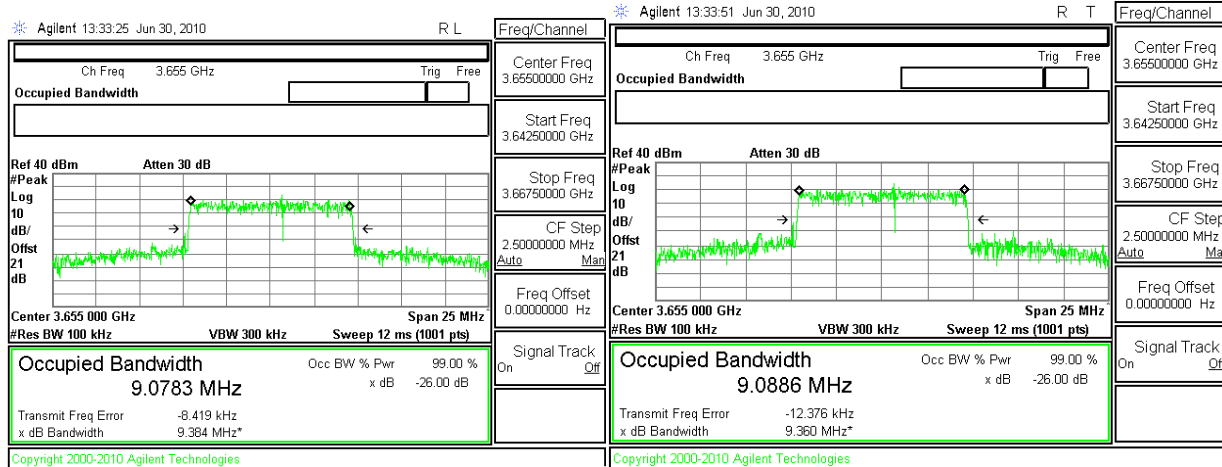

10MHz EBW, Mid Channel 16QAM

Chain 1

Chain 2



10MHz EBW, High Channel 16QAM

Chain 1

Chain

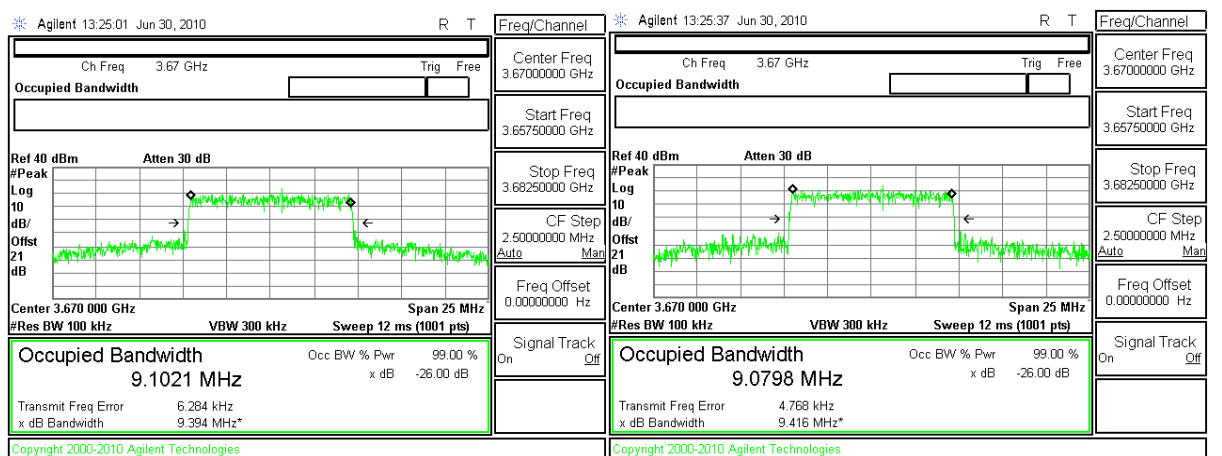

Highest OccBW: 9.1021 MHz

B. 10 MHz EBW, Low Channel 64QAM

Chain 1

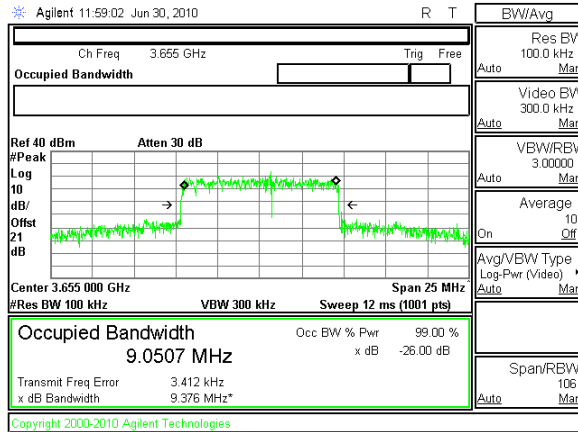

Chain 2

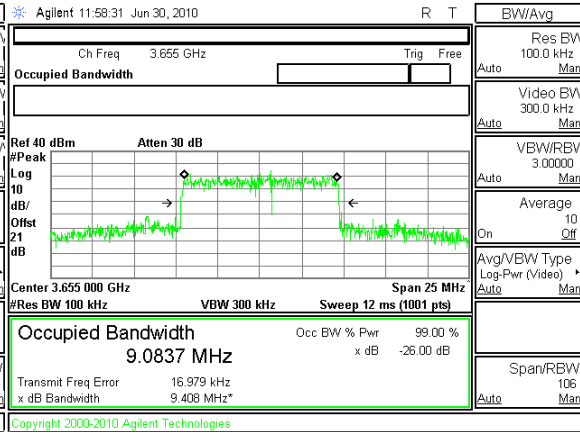

10MHz EBW, Mid Channel 64QAM

Chain 1

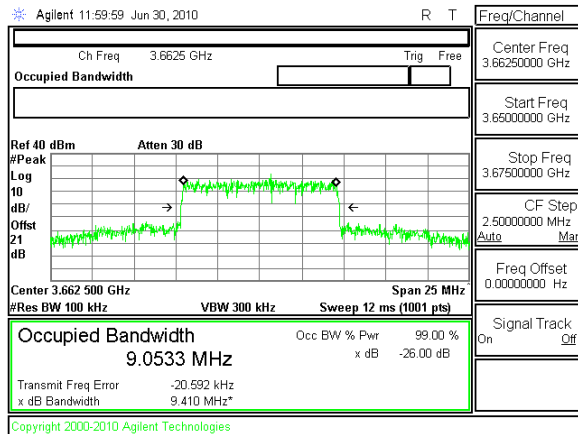

Chain 2

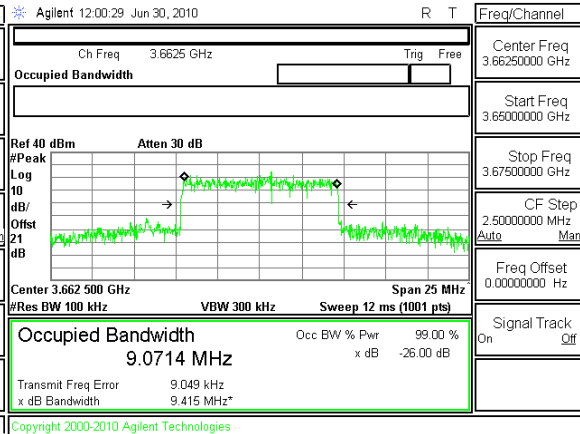

10MHz EBW, High Channel 64QAM

Chain 1

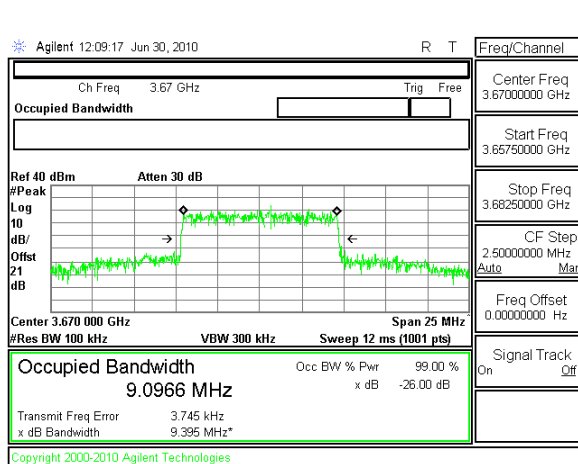

Chain

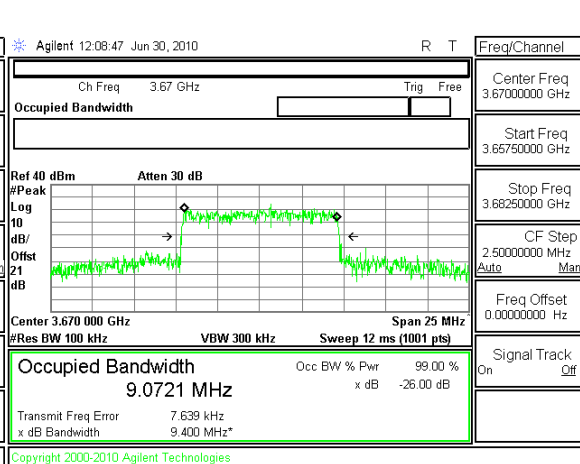

Highest OccBW: 9.0966 MHz

4.6.1.2 PEAK OUTPUT POWER

PEAK EIRP LIMIT

90.1321(a) Base stations and fixed stations are limited to 25watts/25 MHz equivalent isotropic radiated power (EIRP). In any event the EIRP power density shall not exceed 1 watt in any on-megahertz slice of spectrum.

The maximum permitted antenna port output powers for this product are calculated based on the following typical installation parameters:

- A minimum 6 dBi antenna for use with base stations,
- 30m cable loss for TMC LMR-400 at 3.65 MHz = 8.3 dB
- Effective antenna gain: 6 – 8.3 = -2.3 dBi

TEST PROCEDURE

Channel power measurements were made using the spectrum analyzer built-in function. The settings and procedures followed are found in FCC KDB document 965270 D01 Pwr Meas Part 90 Z Equipment v01.

Measurements were taken for each modulation and for each chain at Low, Mid, and High frequencies, and the results summed algebraically to determine total output power and EIRP.

Power output calculations are found in the spread sheet below. Spectrum analyzer plots of conducted antenna port channel power are located in Annex A of this report for reference.

Note: PSD and band edge emissions were limiting factors for output power.

PureWave Quantum 2236 Output Power
 FCC Part 90Z IC RSS-197

Single Element Minimum Antenna Gain = 6dBi
 Single Element Maximum Cable Loss = 8.3dB (e.g. 30 meters TMC LMR-400)
 Single Element Net Antenna Gain = 6dBi - 8.3dB = -2.3dBi

Specification Limit: EIRP 25Watts/25MHz Maximum, 1Watt/MHz Maximum. 5MHz Channel = 5Watts/5MHz, 10MHz Channel = 10Watts/10MHz

5 MHz QPSK	F, MHz	Chain 1	Chain 2	Total Output Power, Sum of Chains	Antenna Gain, dBi	Maximum Output EIRP dBm	Maximum Output EIRP, Watts	Specification Max EIRP, Watts/5MHz
Low Peak	3652.5	31.77	32.05	34.92	-2.30	32.62	1.829	5.00
Mid Peak	3662.5	31.56	32.44	35.03	-2.30	32.73	1.876	5.00
High Peak	3672.5	31.35	32.54	35.00	-2.30	32.70	1.860	5.00
10 MHz QPSK	F, MHz	Chain 1	Chain 2	Maximum Chain Output Power, dBm	Net Antenna Array Factor, dBi	Maximum Output Power dBm	Maximum Output Power, Watts	Specification Max EIRP, Watts/10MHz
Low Peak	3655	32.4	32.72	35.57	-2.30	33.27	2.125	10.00
Mid Peak	3662.5	32.25	32.84	35.57	-2.30	33.27	2.121	10.00
High Peak	3670	32.1	32.49	35.31	-2.30	33.01	2.000	10.00
5 MHz 16QAM	F, MHz	Chain 1	Chain 2	Maximum Chain Output Power, dBm	Net Antenna Array Factor, dBi	Maximum Output EIRP dBm	Maximum Output EIRP, Watts	Specification Max EIRP, Watts/5MHz
Low Peak	3652.5	31.38	31.69	34.55	-2.30	32.25	1.678	5.00
Mid Peak	3662.5	31.11	32.14	34.67	-2.30	32.37	1.724	5.00
High Peak	3672.5	31.01	32.24	34.68	-2.30	32.38	1.729	5.00
10 MHz 16QAM	F, MHz	Chain 1	Chain 2	Maximum Chain Output Power, dBm	Net Antenna Array Factor, dBi	Maximum Output Power dBm	Maximum Output Power, Watts	Specification Max EIRP, Watts/10MHz
Low Peak	3655	32.46	32.77	35.63	-2.30	33.33	2.152	10.00
Mid Peak	3662.5	32.21	32.33	35.28	-2.30	32.98	1.986	10.00
High Peak	3670	32.05	32.39	35.23	-2.30	32.93	1.965	10.00
5 MHz 64QAM	F, MHz	Chain 1	Chain 2	Maximum Chain Output Power, dBm	Net Antenna Array Factor, dBi	Maximum Output EIRP dBm	Maximum Output EIRP, Watts	Specification Max EIRP, Watts/5MHz
Low Peak	3652.5	31.43	31.94	34.70	-2.30	32.40	1.739	5.00
Mid Peak	3662.5	31.17	32.06	34.65	-2.30	32.35	1.717	5.00
High Peak	3672.5	31.07	32.3	34.74	-2.30	32.44	1.753	5.00
10 MHz 64QAM	F, MHz	Chain 1	Chain 2	Maximum Chain Output Power, dBm	Net Antenna Array Factor, dBi	Maximum Output Power dBm	Maximum Output Power, Watts	Specification Max EIRP, Watts/10MHz
Low Peak	3655	32.41	32.16	35.30	-2.30	33.00	1.994	10.00
Mid Peak	3662.5	32.2	32.3	35.26	-2.30	32.96	1.977	10.00
High Peak	3670	32	32.23	35.13	-2.30	32.83	1.917	10.00

4.6.1.3 PEAK EIRP POWER DENSITY LIMIT

90.1321(a) Base stations and fixed stations are limited to 25watts/25 MHz equivalent isotropic radiated power (EIRP). In any event the EIRP power density shall not exceed 1 watt in any on-megahertz slice of spectrum.

TEST PROCEDURE

Peak PSD measurements were made using the settings and procedures in FCC KDB document 965270 D01 Pwr Meas Part 90 Z Equipment v01.

Measurements were taken for each modulation and for each chain at Low, Mid, and High frequencies, and the results summed algebraically to determine total output power and EIRP.

Peak PSD EIRP calculations are found in the spread sheet below. Spectrum analyzer plots of conducted antenna port PSD measurements are located in Annex B of this report for reference.

Power settings for PSD were the same as for maximum power settings for power (35 dBm or 36 dBm).

PureWave Quantum 2236 PSD
 FCC Part 90Z IC RSS-197

Single Element Minimum Antenna Gain = 6dBi (e.g. Mobile Mark 6dBi Omni, ECO6-3500)
 Single Element Maximum Cable Loss = 8.3dB (e.g. 30 meters TMC LMR-400)
 Single Element Net Antenna Gain = 6dBi - 8.3dB = -2.3dBi

Specification Limit: EIRP 1Watt/MHz Maximum.

Modulation	F, MHz	Chain 1	Chain 2	Sum 6 Chains Output Power, dBm/MHz	Net Antenna Array Factor, dBi	Maximum Output EIRP dBm/MHz	Maximum Output EIRP Watts/MHz	Specification Max EIRP, Watts/MHz	
5 MHz QPSK	Low Peak	3652.5	28.38	28.76	31.61	-2.30	29.31	0.854	1.00
	Mid Peak	3662.5	28.03	28.875	31.48	-2.30	29.18	0.829	1.00
	High Peak	3672.5	27.785	28.922	31.40	-2.30	29.10	0.813	1.00
10 MHz QPSK	Low Peak	3655	27.05	26.41	29.75	-2.30	27.45	0.556	1.00
	Mid Peak	3662.5	27.2	26.56	29.90	-2.30	27.60	0.576	1.00
	High Peak	3670	26.208	26.951	29.61	-2.30	27.31	0.538	1.00
5 MHz 16QAM	Low Peak	3652.5	27.919	27.596	30.77	-2.30	28.47	0.703	1.00
	Mid Peak	3662.5	27.747	29.119	31.50	-2.30	29.20	0.831	1.00
	High Peak	3672.5	27.283	28.642	31.03	-2.30	28.73	0.746	1.00
10 MHz 16QAM	Low Peak	3655	26.387	26.835	29.63	-2.30	27.33	0.540	1.00
	Mid Peak	3662.5	26.451	26.473	29.47	-2.30	27.17	0.521	1.00
	High Peak	3670	26.462	26.991	29.74	-2.30	27.44	0.555	1.00
5 MHz 64QAM 27dBm Pset	Low Peak	3652.5	28.31	28.448	31.39	-2.30	29.09	0.811	1.00
	Mid Peak	3662.5	28.033	29.119	31.62	-2.30	29.32	0.855	1.00
	High Peak	3672.5	27.864	28.74	31.33	-2.30	29.03	0.801	1.00
10 MHz 64QAM	Low Peak	3655	27.293	26.835	30.08	-2.30	27.78	0.600	1.00
	Mid Peak	3662.5	26.418	26.775	29.61	-2.30	27.31	0.538	1.00
	High Peak	3670	26.848	26.951	29.91	-2.30	27.61	0.577	1.00

4.6.1.4 MAXIMUM PERMISSIBLE EXPOSURE

LIMITS

§1.1310 The criteria listed in Table 1 shall be used to evaluate the environmental impact of human exposure to radio-frequency (RF) radiation as specified in §1.1307(b), except in the case of portable devices which shall be evaluated according to the provisions of §2.1093 of this chapter.

TABLE 1—LIMITS FOR MAXIMUM PERMISSIBLE EXPOSURE (MPE)

Frequency range (MHz)	Electric field strength (V/m)	Magnetic field strength (A/m)	Power density (mW/cm ²)	Averaging time (minutes)
(A) Limits for Occupational/Controlled Exposures				
0.3–3.0	614	1.63	*(100)	6
3.0–30	1842/f	4.89/f	*(900/f ²)	6
30–300	61.4	0.163	1.0	6
300–1500	f/300	6
1500–100,000	5	6
(B) Limits for General Population/Uncontrolled Exposure				
0.3–1.34	614	1.63	*(100)	30
1.34–30	824/f	2.19/f	*(180/f ²)	30

TABLE 1—LIMITS FOR MAXIMUM PERMISSIBLE EXPOSURE (MPE)—Continued

Frequency range (MHz)	Electric field strength (V/m)	Magnetic field strength (A/m)	Power density (mW/cm ²)	Averaging time (minutes)
30–300	27.5	0.073	0.2	30
300–1500	f/1500	30
1500–100,000	1.0	30

f = frequency in MHz

* = Plane-wave equivalent power density

NOTE 1 TO TABLE 1: Occupational/controlled limits apply in situations in which persons are exposed as a consequence of their employment provided those persons are fully aware of the potential for exposure and can exercise control over their exposure. Limits for occupational/controlled exposure also apply in situations when an individual is transient through a location where occupational/controlled limits apply provided he or she is made aware of the potential for exposure.

NOTE 2 TO TABLE 1: General population/uncontrolled exposures apply in situations in which the general public may be exposed, or in which persons that are exposed as a consequence of their employment may not be fully aware of the potential for exposure or can not exercise control over their exposure.

CALCULATIONS

Given

$$E = \sqrt{(30 * P * G) / d}$$

and

$$S = E^2 / 3770$$

where

E = Field Strength in Volts/meter

P = Power in Watts

G = Numeric antenna gain

d = Distance in meters

S = Power Density in milliwatts/square centimeter

Combining equations and rearranging the terms to express the distance as a function of the remaining variables yields:

$$d = \sqrt{((30 * P * G) / (3770 * S))}$$

Changing to units of Power to mW and Distance to cm, using:

$$P \text{ (mW)} = P \text{ (W)} / 1000 \text{ and}$$

$$d \text{ (cm)} = 100 * d \text{ (m)}$$

yields

$$d = 100 * \sqrt{((30 * (P / 1000) * G) / (3770 * S))}$$

$$d = 0.282 * \sqrt{(P * G / S)}$$

where

d = distance in cm

P = Power in mW

G = Numeric antenna gain

S = Power Density in mW/cm²

Substituting the logarithmic form of power and gain using:

$$P \text{ (mW)} = 10^{(P \text{ (dBm)} / 10)} \text{ and}$$

$$G \text{ (numeric)} = 10^{(G \text{ (dBi)} / 10)}$$

yields

$$d = 0.282 * 10^{((P + G) / 20)} / \sqrt{S} \quad \text{Equation (1)}$$

where

d = MPE distance in cm

P = Power in dBm

G = Antenna Gain in dBi

S = Power Density Limit in mW/cm²

Equation (1) and the measured peak power is used to calculate the MPE distance.

LIMITS

From §1.1310 Table 1 (B), $S = 1.0 \text{ mW/cm}^2$

RESULTS

RF exposure considerations will be addressed by the licensee at the time of installation. The maximum eirp allowed under Part 90 for this product is 10 Watts/10 MHz channels, or 40 dBm EIRP. The MPE distance for 40 dBm eirp calculated below:

Power Density Limit (mW/cm²)	Output Power (dBm)	Antenna Gain (dBi)	MPE Distance (cm)
1.0	40.00	0.00	28.20

4.6.1.5 CONDUCTED SPURIOUS EMISSIONS

REQUIREMENT

2.1051 Measurements required: Spurious emissions at antenna terminals.

The radio frequency voltage or powers generated within the equipment and appearing on a spurious frequency shall be checked at the equipment output terminals when properly loaded with a suitable artificial antenna. Curves or equivalent data shall show the magnitude of each harmonic and other spurious emission that can be detected when the equipment is operated under the conditions specified in §2.1049 as appropriate. The magnitude of spurious emissions which are attenuated more than 20 dB below the permissible value need not be specified.

90.1323(a) Emission limits.

(a) The power of any emission outside a licensee's frequency band(s) of operation shall be attenuated below the transmitter power (P) within the licensed band(s) of operation, measured in watts, by at least $43 + 10 \log (P)$ dB. Compliance with this provision is based on the use of measurement instrumentation employing a resolution bandwidth of 1 MHz or less, but at least one percent of the emission bandwidth of the fundamental emission of the transmitter, provided the measured energy is integrated over a 1 MHz bandwidth.

TEST PROCEDURE

The transmitter outputs are connected to a spectrum analyzer using a combiner. At the Low and High channels, in the 1 MHz band immediately adjacent to the band edge, RBW=1% EBW, VBW=3xRBW. Elsewhere RBW = 1 MHz, VBW=3 MHz.

RESULTS

No non-compliance noted:

5 MHz QPSK CONDUCTED SPURIOUS, LOW CHANNEL 3652.5 MHz, P=27 dBm



Agilent 18:14:59 Aug 30, 2010

R T

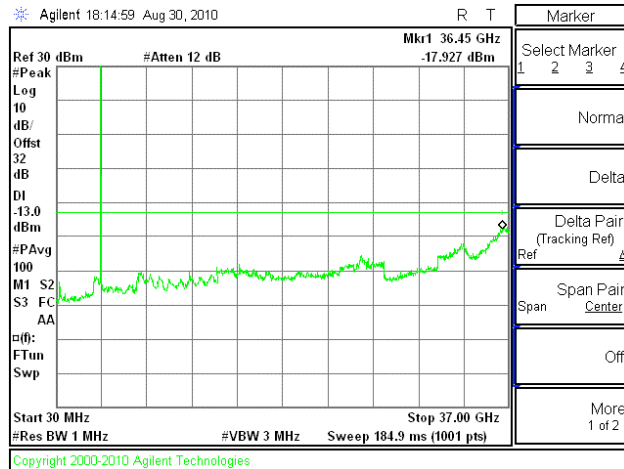

5 MHZ QPSK CONDUCTED SPURIOUS, MID CHANNEL, P=35 dBm

Agilent 18:24:38 Aug 30, 2010

R T

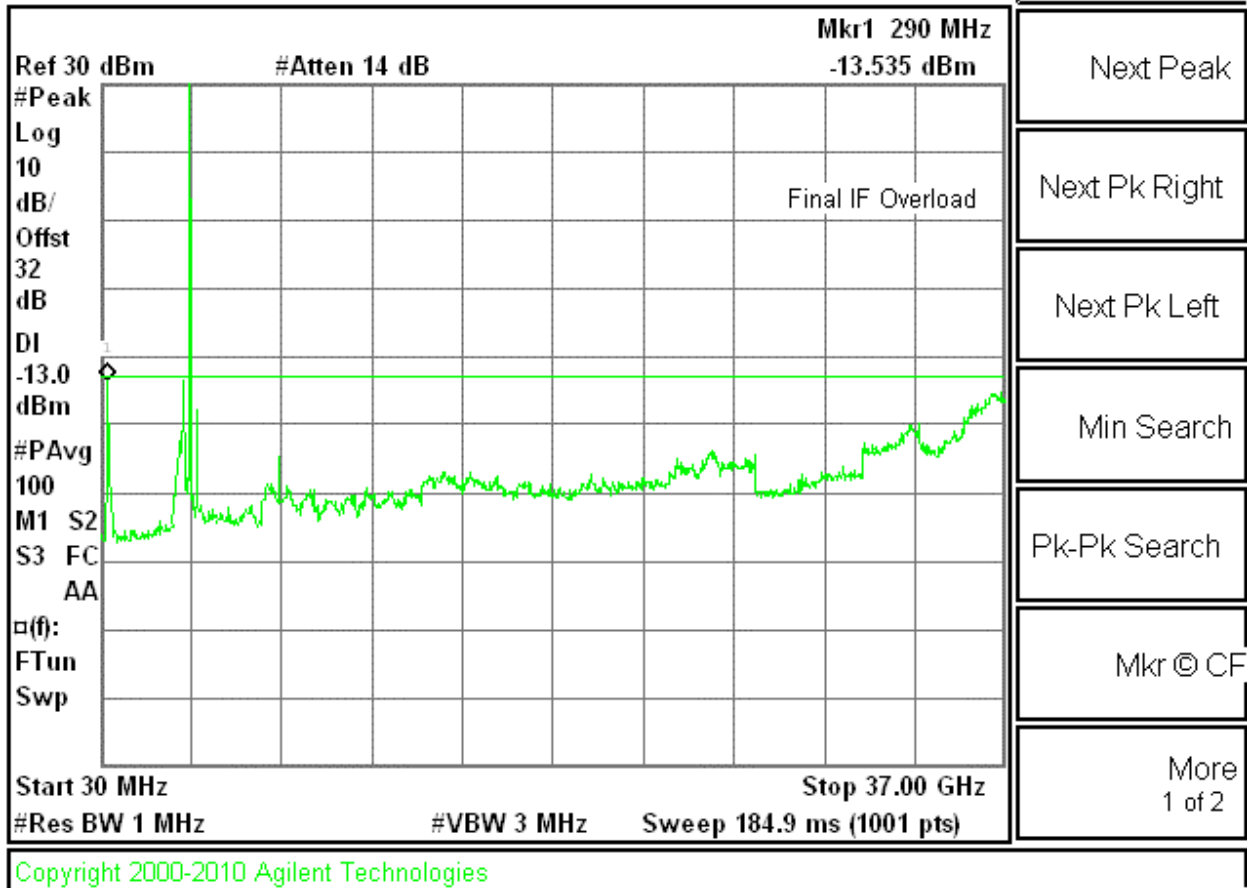

5 MHz QPSK CONDUCTED SPURIOUS, HIGH CHANNEL 3672.5 MHz, P=28

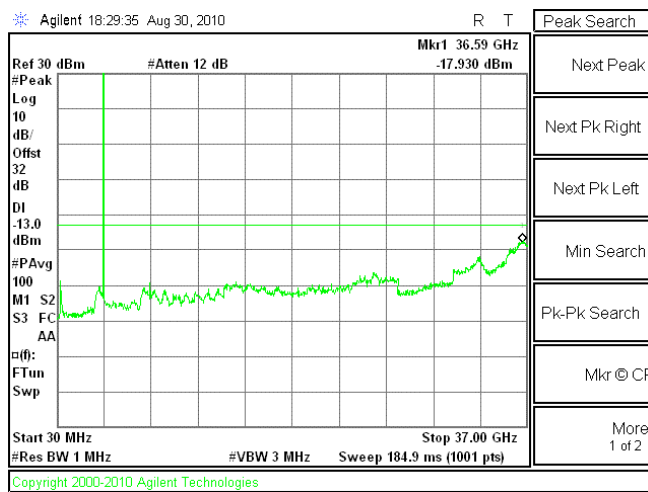
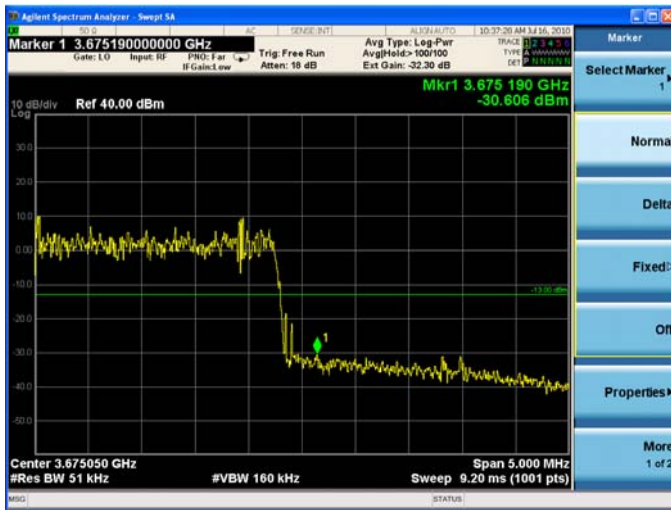

5 MHz 16QAM CONDUCTED SPURIOUS, LOW CHANNEL, P=27 dBm

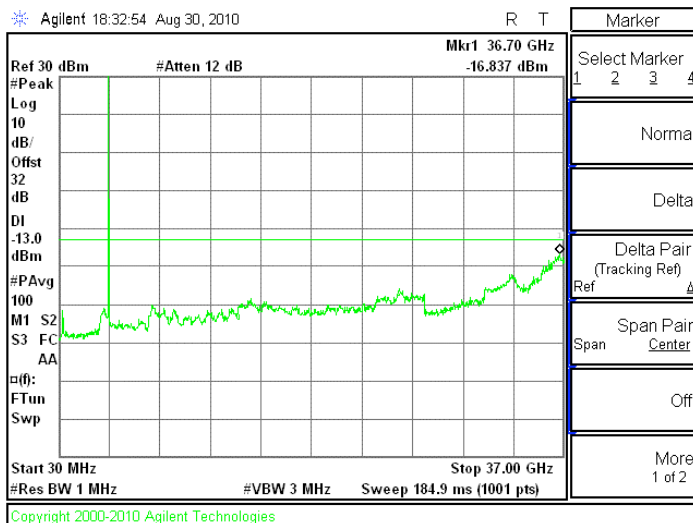
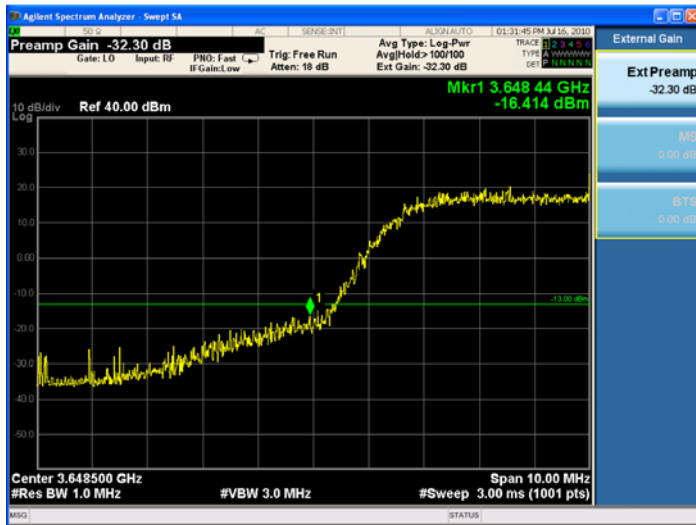

5 MHz 16QAM CONDUCTED SPURIOUS, MID CHANNEL, P=35 dBm

Agilent 18:37:48 Aug 30, 2010

R T

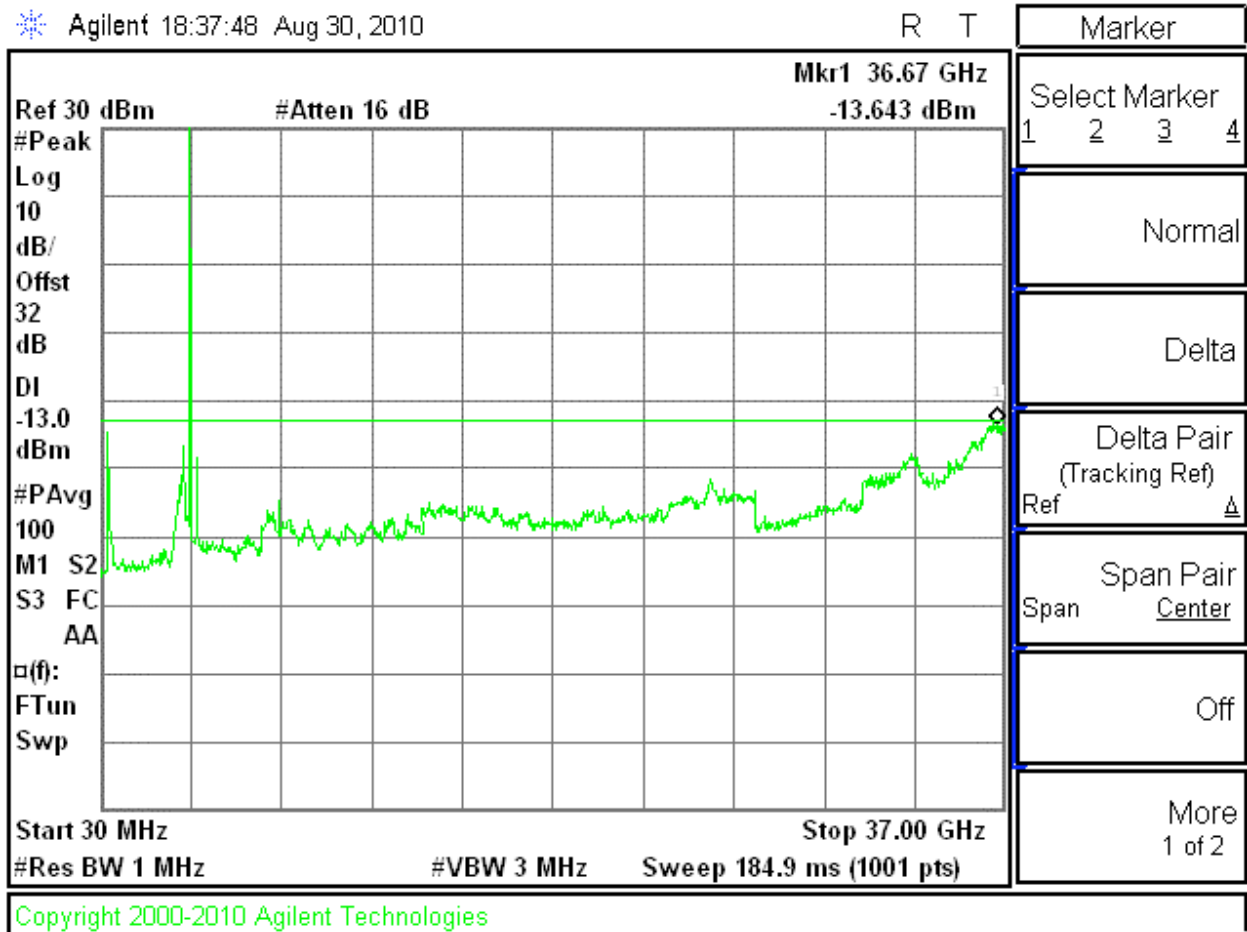

5 MHz 16QAM CONDUCTED SPURIOUS, 3672.5 MHz, HIGH CHANNEL, P=28

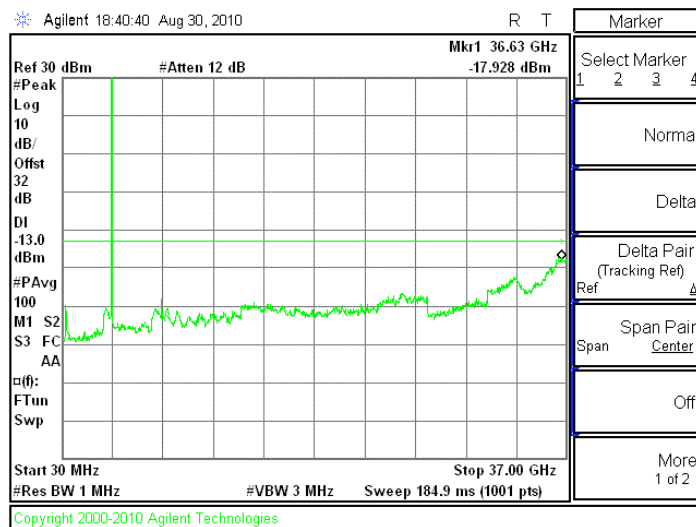
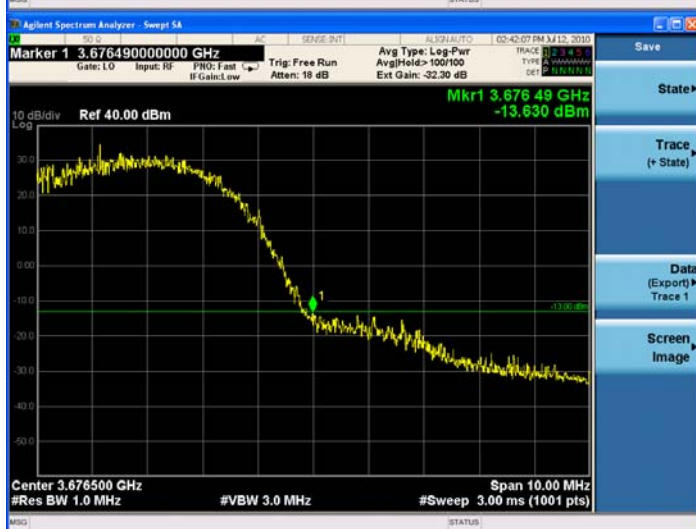

5 MHz 64QAM CONDUCTED SPURIOUS, 3652.5 MHz LOW CHANNEL, P=27 dBm

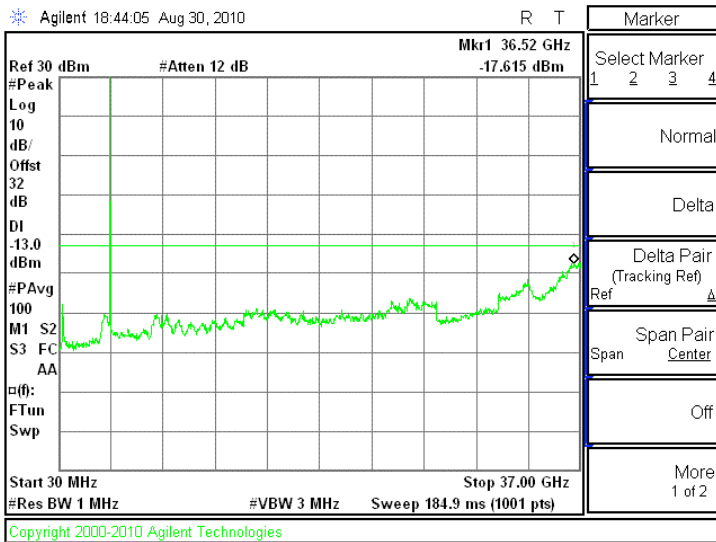

5 MHz 64QAM CONDUCTED SPURIOUS, MID CHANNEL, P=35 dBm

Agilent 18:48:56 Aug 30, 2010

R T

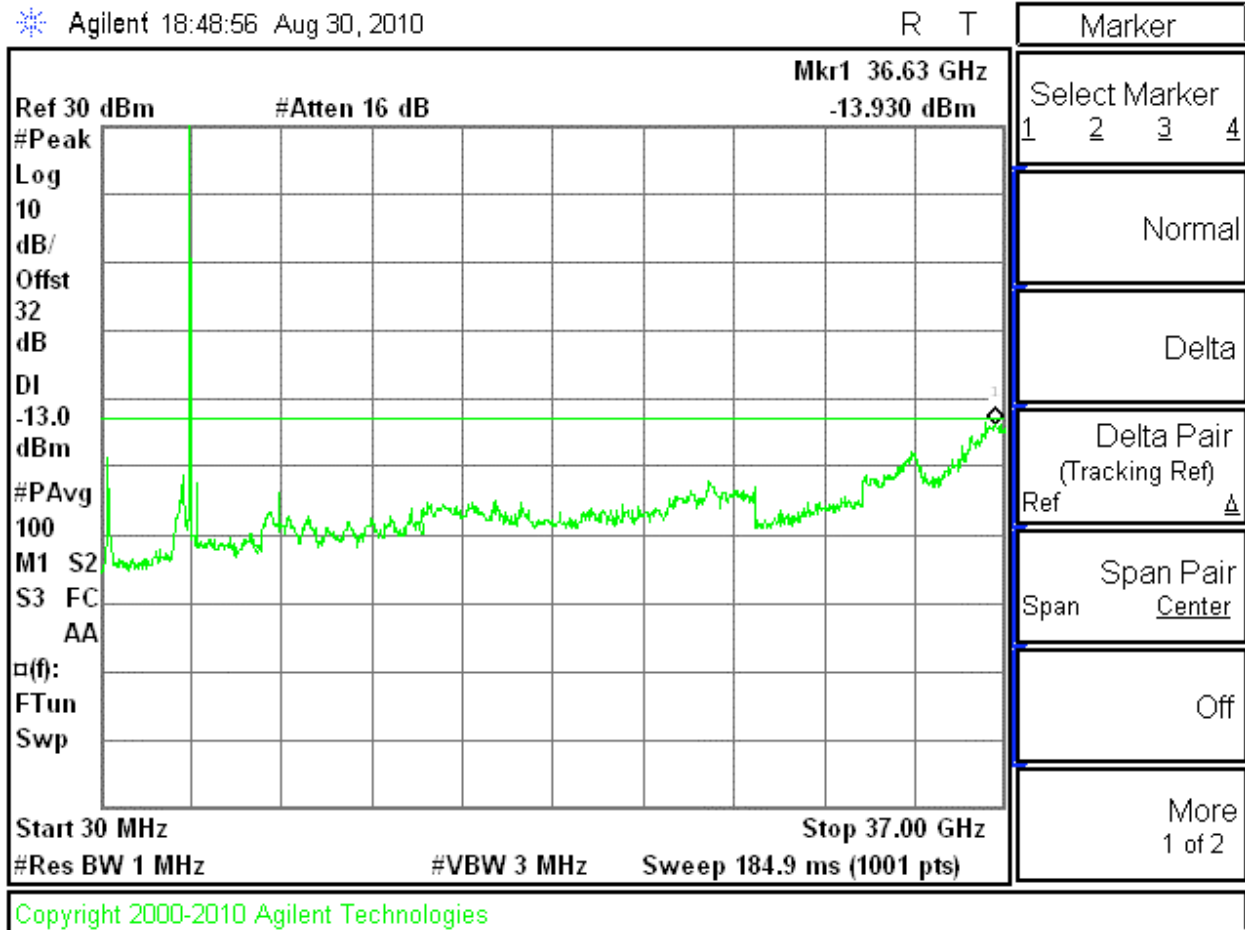

5 MHz 64QAM CONDUCTED SPURIOUS, 3672.5 MHz, HIGH CHANNEL, P=28 dBm

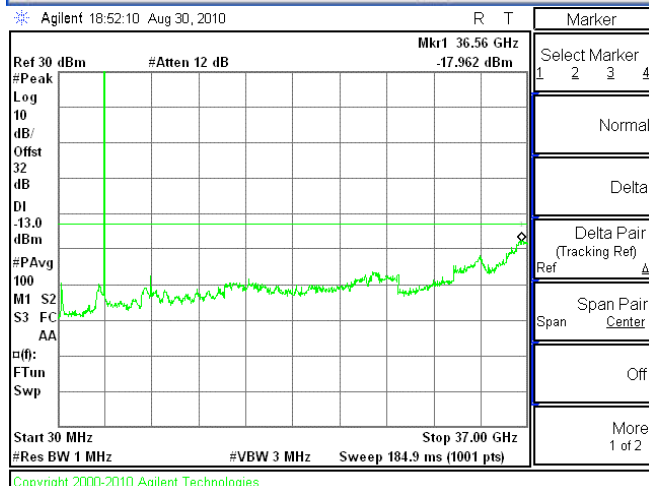

10 MHz QPSK CONDUCTED SPURIOUS, 3655 MHz, LOW CHANNEL, P=29

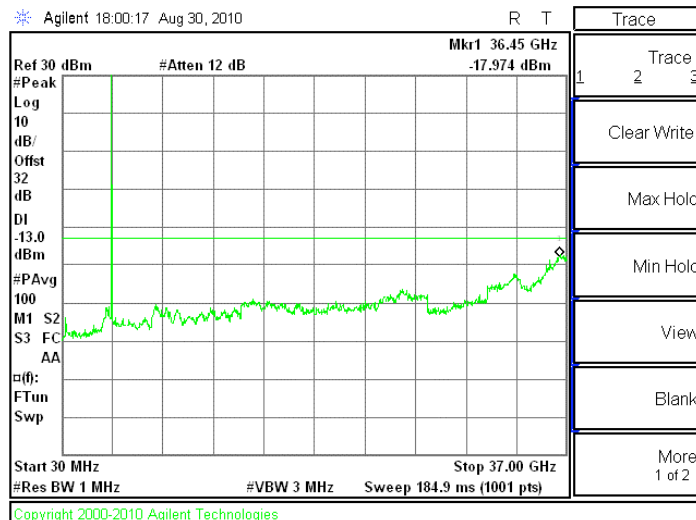
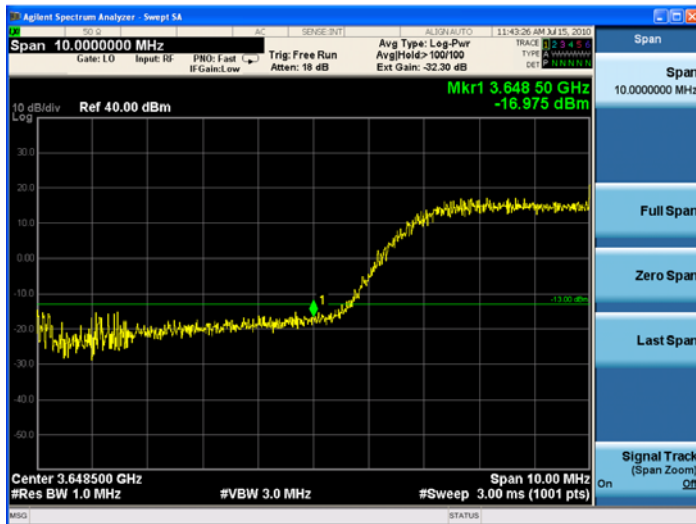

10 MHz QPSK CONDUCTED SPURIOUS, MID CHANNEL, P=36 dBm

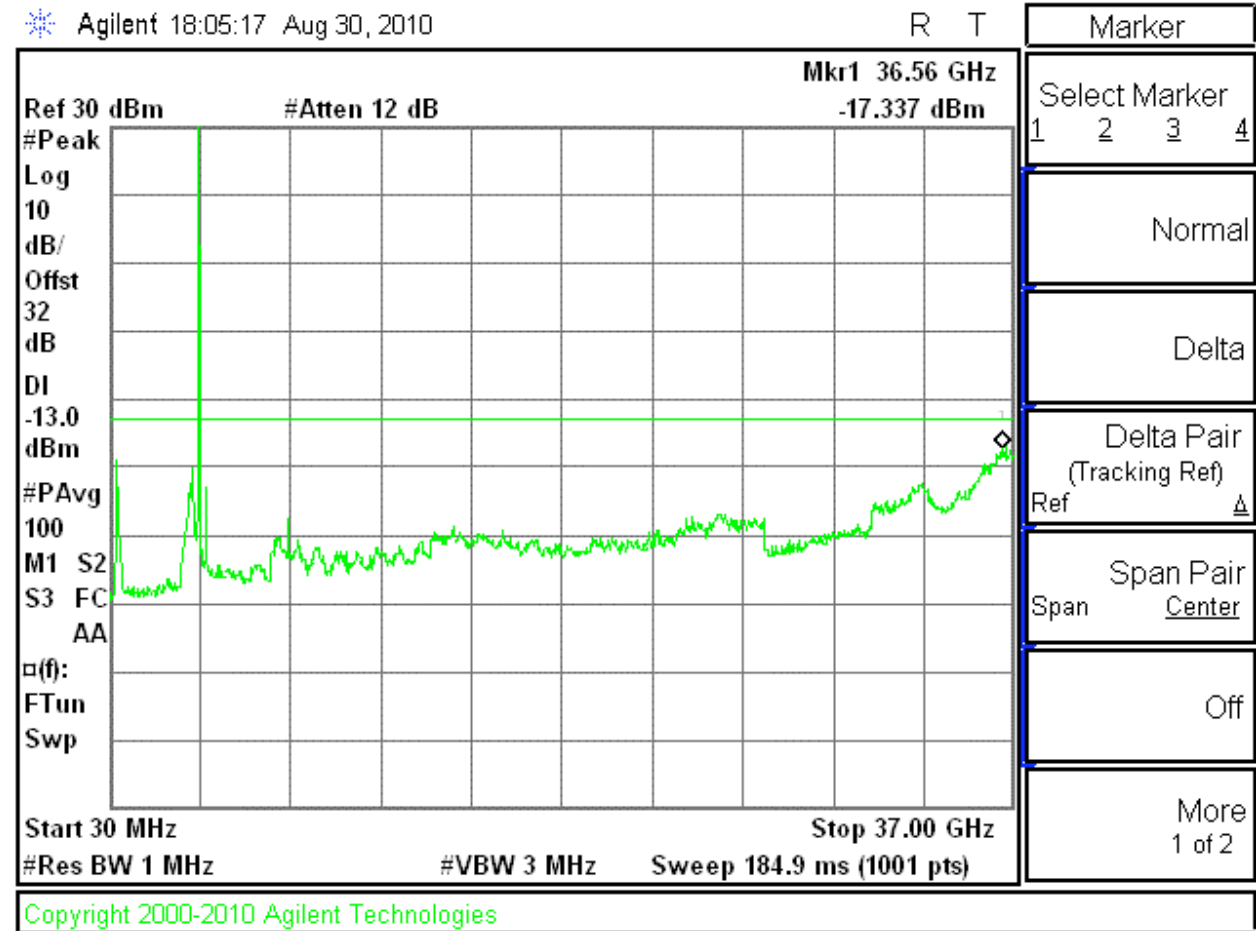

10 MHz QPSK CONDUCTED SPURIOUS, 3670 MHz, HIGH CHANNEL, P=30

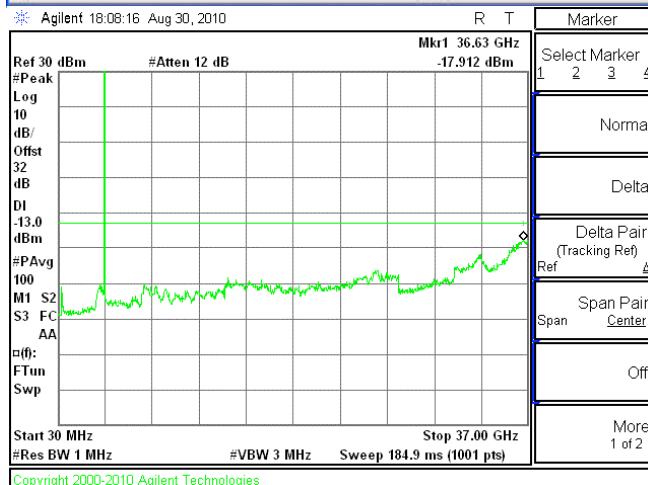
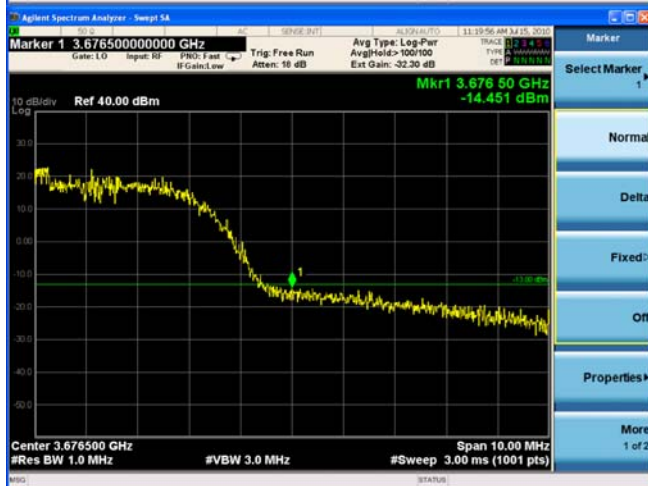
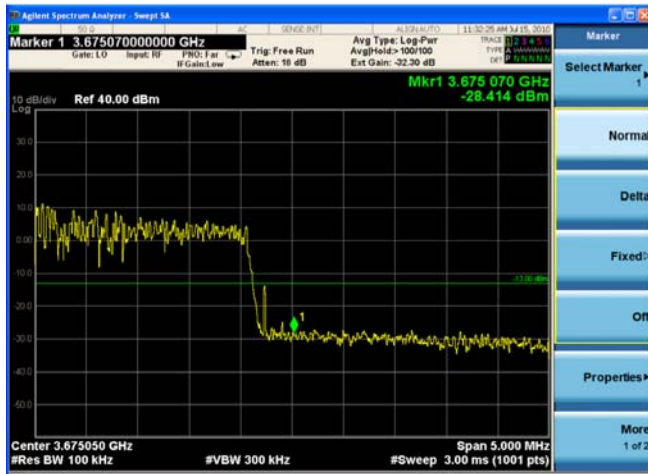

10 MHz 16QAM CONDUCTED SPURIOUS, 3655 MHz, LOW CHANNEL, P=29 dBm

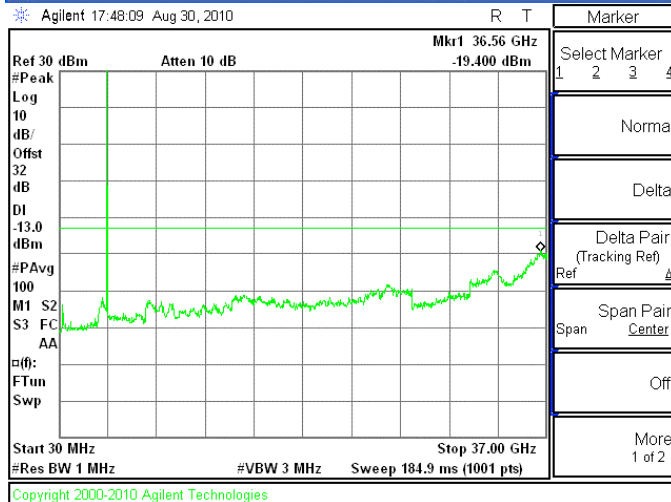
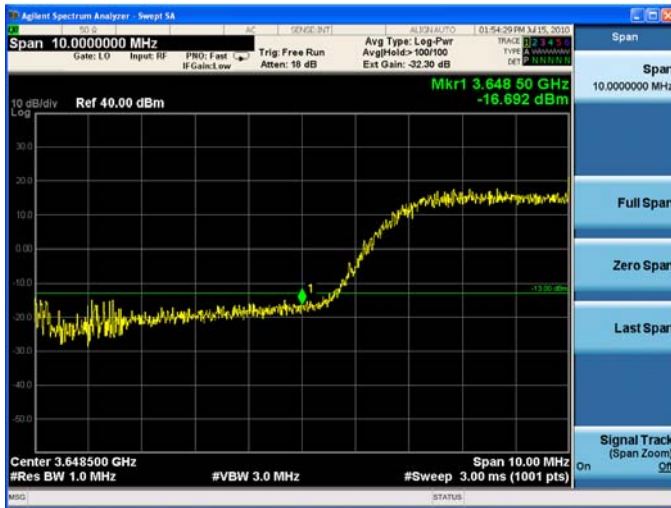
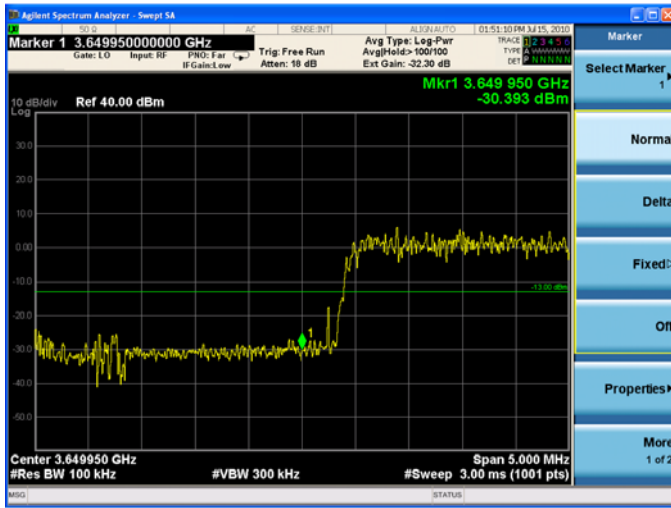

10 MHZ 16QAM CONDUCTED SPURIOUS, MID CHANNEL, P=36 dBm

Agilent 17:53:54 Aug 30, 2010

R T

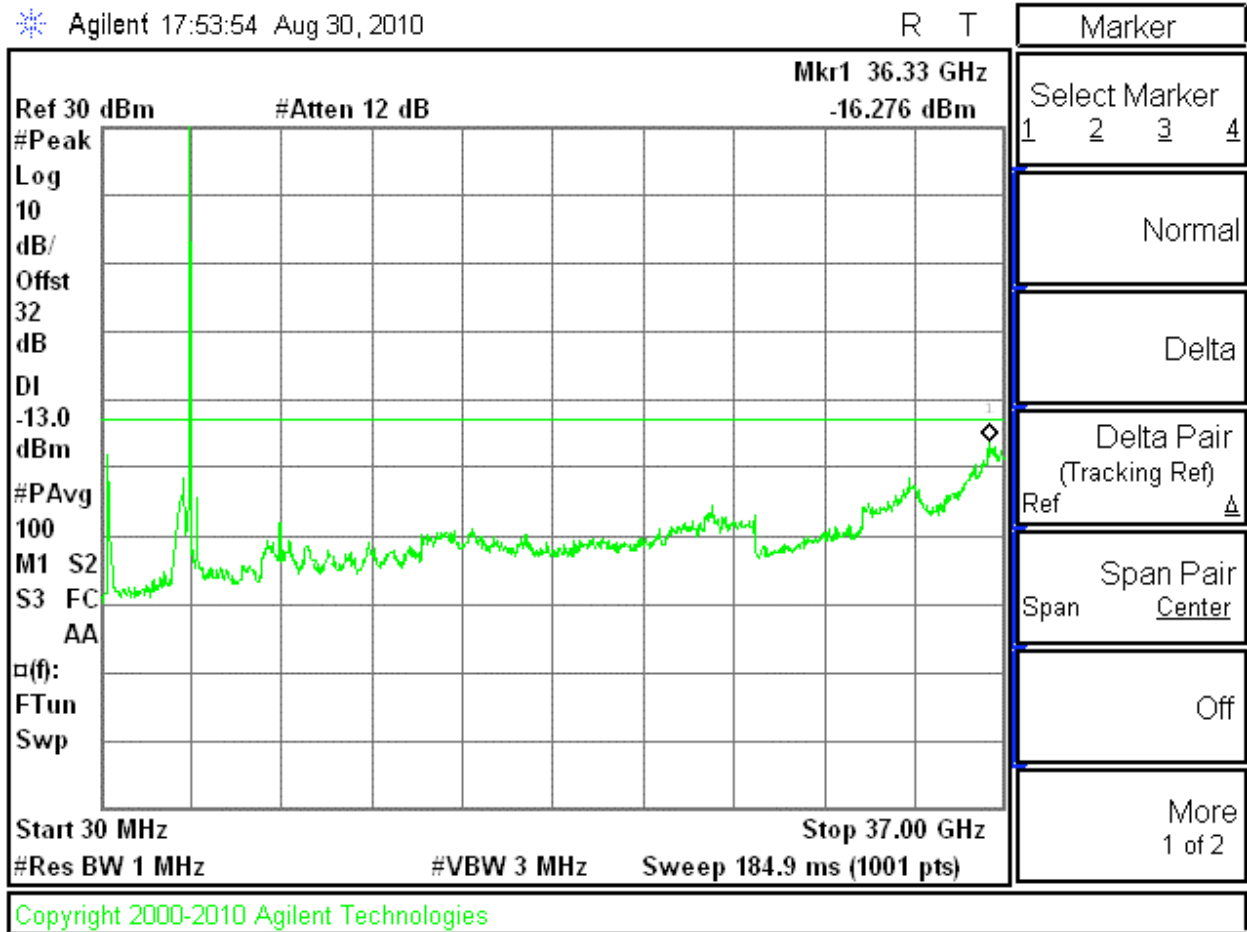

10 MHz 16QAM CONDUCTED SPURIOUS, 3670 MHz, HIGH CHANNEL, P=30

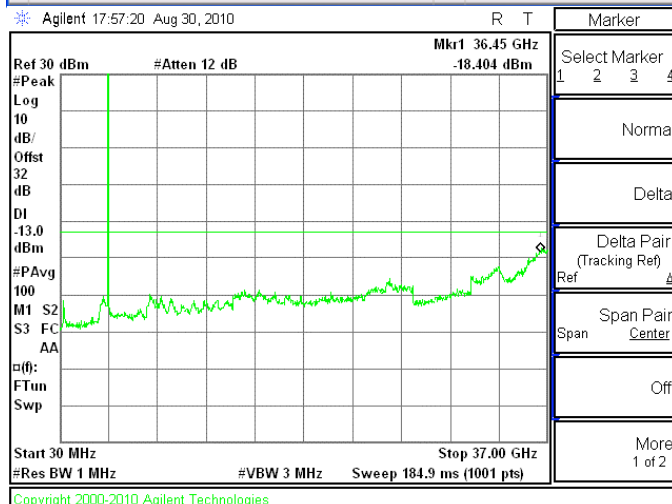
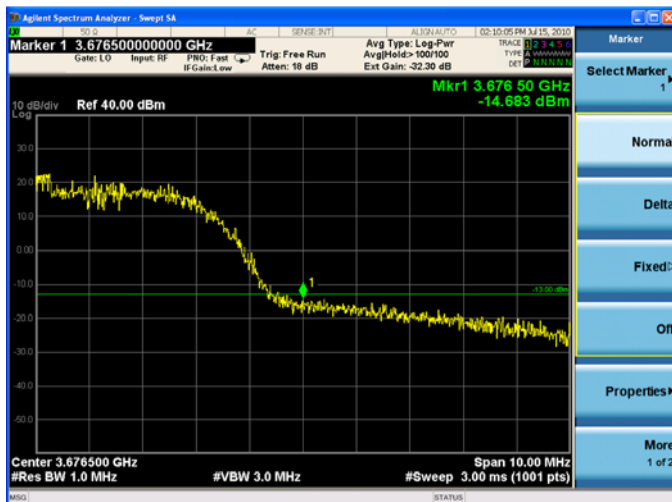

10 MHz 64QAM CONDUCTED SPURIOUS, 3655 MHz, LOW CHANNEL, P=29

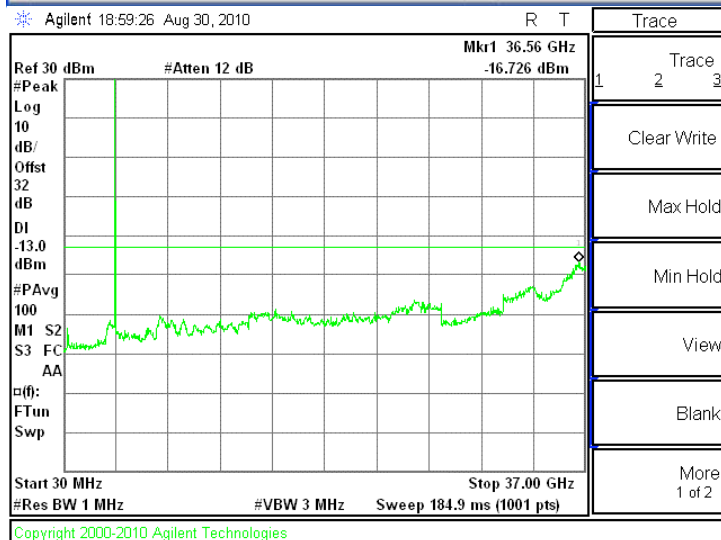
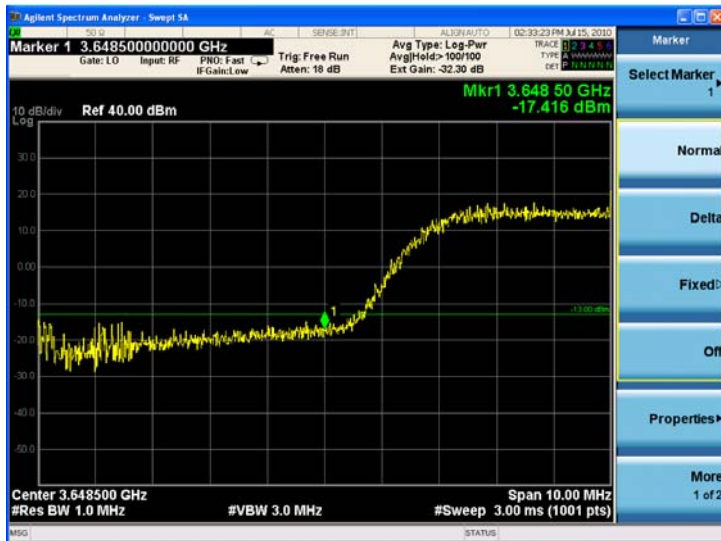

10 MHz 64QAM CONDUCTED SPURIOUS, MID CHANNEL, P=36 dBm

Agilent 19:05:47 Aug 30, 2010

R T

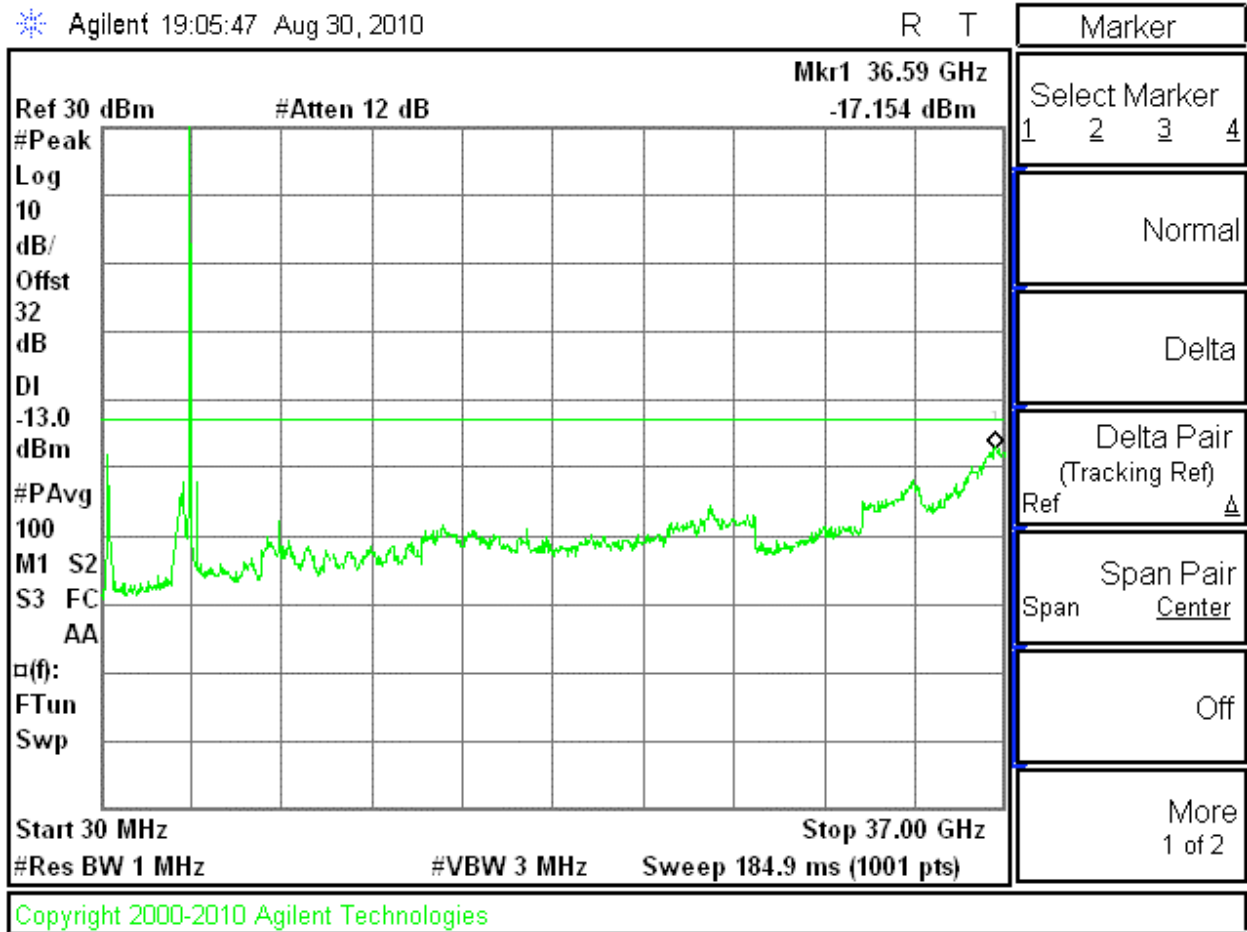

10 MHz 64QAM CONDUCTED SPURIOUS, HIGH CHANNEL, P=30

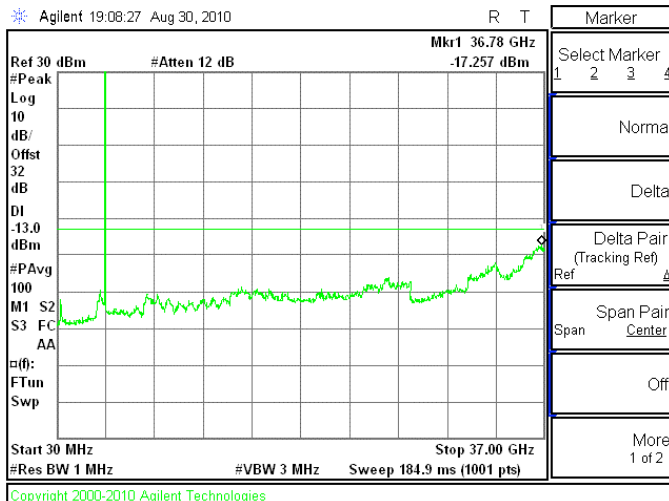

4.6.2 RADIATED EMISSIONS

REQUIREMENT

2.1053 Measurements required: Field strength of spurious radiation

Information submitted shall include the relative radiated power of each spurious emission with reference to the rated power output of the transmitter, assuming all emissions are radiated from half wave dipole antennas.

90.1323(a) Emission limits.

(a) The power of any emission outside a licensee's frequency band(s) of operation shall be attenuated below the transmitter power (P) within the licensed band(s) of operation, measured in watts, by at least $43 + 10 \log (P)$ dB. Compliance with this provision is based on the use of measurement instrumentation employing a resolution bandwidth of 1 MHz or less, but at least one percent of the emission bandwidth of the fundamental emission of the transmitter, provided the measured energy is integrated over a 1 MHz bandwidth.

TEST PROCEDURE

Testing was performed using the substitution method.

Power settings for all channels during tests: 5MHz channels: 35 dBm
10MHz channels: 36 dBm

1. The EUT is placed on a non-conducting table 80 cm above the ground plane. The antenna port was terminated with a resistive non-radiating 50 ohm termination.
2. The spectrum from 30 MHz to 37 GHz was investigated with the transmitter set to the lowest, middle, and highest channels in each 5 GHz band.
3. The frequency range of interest was monitored at a fixed antenna height and EUT azimuth. The EUT is rotated through 360 degrees to maximize emissions received. The antenna is scanned from 1 to 4 meters above the ground plane to further maximize the emission. Measurements are made with the antenna polarized in both the vertical and the horizontal positions.
4. The EUT was replaced by a signal generator and antenna. The signal generator was set to produce field strengths matching the levels obtained in step 3 above. The equivalent eirp was calculated from the signal generator output and antenna gain with respect to isotropic.

Note: For emissions below 1 GHz, the field strength of the emission is also compared against the EN55022 class A limits for digital devices

TEST RESULTS

Refer to plots and tabulated data below. All emissions below 1 GHz were at least 20 dB below -13 dBm limit and were determined to be from the digital section of the product.

For all modulations for 5/10 MHz bandwidths, worst-case emissions above 1 GHz are at least 24 dB below limits. Worst-case emissions were for 5 MHz QPSK, refer to spread sheet below.

4.6.2.2 TRANSMITTER RADIATED EMISSIONS BELOW 1 GHz SPURIOUS AND DIGITAL SECTION EMISSIONS

64 QAM5 MHz Channels (Worst case emissions)

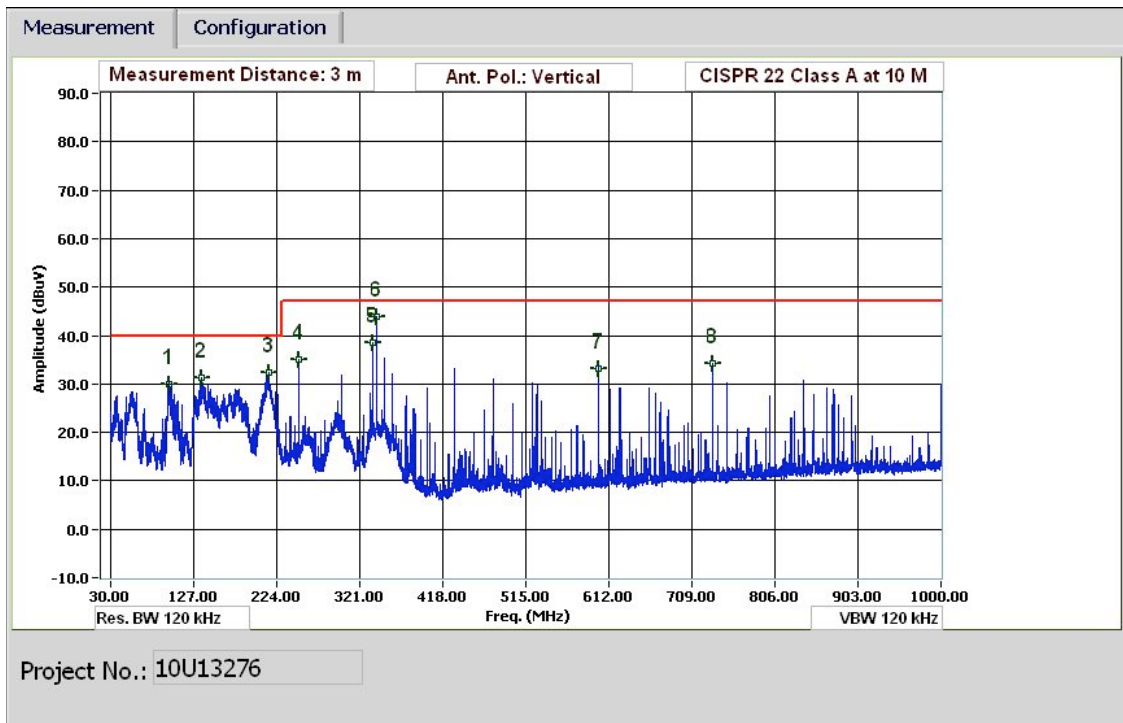
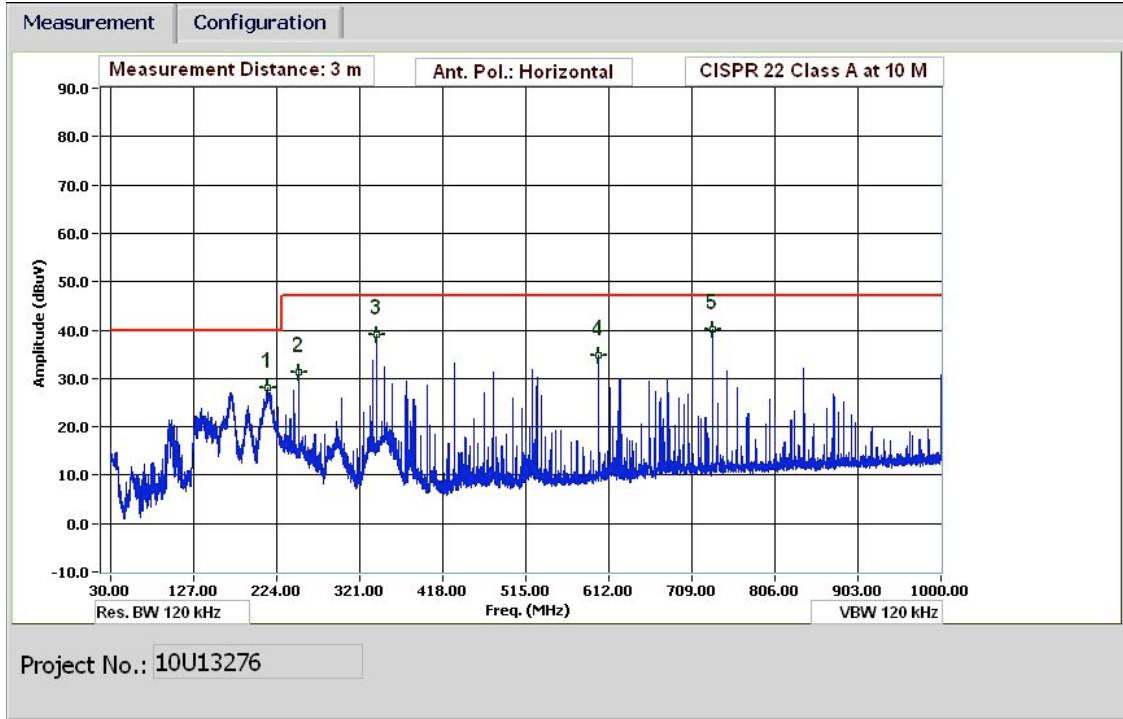

30-1000MHz Frequency Measurement
Compliance Certification Services, Fremont 5m Chamber

Test Engr: Thanh Nguyen
Date: 06/22/10
Project #: 10U13276
Company: PureWave Networks Inc.
EUT Description: 6X6 3.65GHz WIMAX Base Station
EUT M/N: Quantum 6600
Test Target: EN55022 Class A
Mode Oper: Tx 64QAM 5MHz BW, Low Ch 3652.5MHz

f	Measurement Frequency	Amp	Preamp Gain	Margin	Margin vs. Limit
Dist	Distance to Antenna	D Corr	Distance Correct to 3 meters		
Read	Analyzer Reading	Filter	Filter Insert Loss		
AF	Antenna Factor	Corr.	Calculated Field Strength		
CL	Cable Loss	Limit	Field Strength Limit		

f MHz	Dist (m)	Read dBuV	AF dB/m	CL dB	Amp dB	D Corr dB	Filter dB	Corr. dBuV/m	Limit dBuV/m	Margin dB	Ant. Pol. V/H	Det. P/A/QP
98.163	3.0	58.3	9.5	0.9	28.3	-10.5	0.0	29.9	40.0	-10.1	V	P
136.684	3.0	55.5	13.3	1.1	28.3	-10.5	0.0	31.2	40.0	-8.8	V	P
215.528	3.0	57.8	11.9	1.3	28.2	-10.5	0.0	32.4	40.0	-7.6	V	P
249.969	3.0	60.5	11.8	1.4	28.2	-10.5	0.0	35.0	47.0	-12.0	V	P
336.013	3.0	61.5	14.0	1.6	28.1	-10.5	0.0	38.6	47.0	-8.4	V	P
340.933	3.0	66.8	14.0	1.6	28.1	-10.5	0.0	43.9	47.0	-3.1	V	P
599.904	3.0	50.5	18.4	2.2	27.5	-10.5	0.0	33.1	47.0	-13.9	V	P
733.349	3.0	49.4	20.0	2.5	27.3	-10.5	0.0	34.3	47.0	-12.7	V	P
212.768	3.0	53.4	11.9	1.3	28.2	-10.5	0.0	28.0	40.0	-12.0	H	P
250.089	3.0	56.7	11.8	1.4	28.2	-10.5	0.0	31.2	47.0	-15.8	H	P
340.933	3.0	61.9	14.0	1.6	28.1	-10.5	0.0	39.0	47.0	-8.0	H	P
600.024	3.0	52.0	18.4	2.2	27.5	-10.5	0.0	34.7	47.0	-12.3	H	P
733.349	3.0	55.4	20.0	2.5	27.3	-10.5	0.0	40.2	47.0	-6.8	H	P

Rev. 1.27.09

Note: No other emissions were detected above the system noise floor.

4.6.3 FREQUENCY STABILITY TEST

REQUIREMENT

2.1055 Measurements required: Frequency stability

(a) The frequency stability shall be measured with variation of ambient temperature as follows:

(1) From -30° to $+50^{\circ}$ centigrade

(d) The frequency stability shall be measured with variation of primary supply voltage as follows:

(1) Vary primary supply voltage from 85 to 115 percent of the nominal value for other than hand carried battery equipment.

Test Set-up

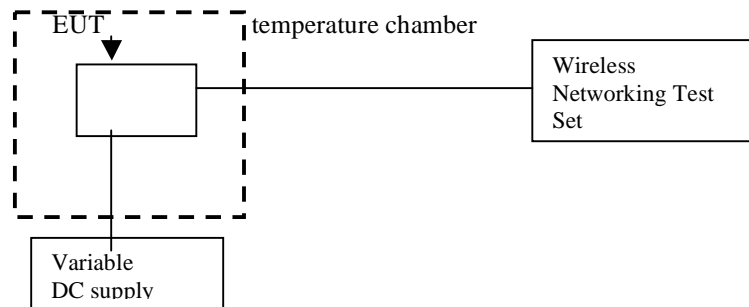

Test Procedures

1. Wireless Networking Test Set center frequency was set to 3662.5 MHz operating frequency. Frequency was measured at $+20^{\circ}\text{C}$ using Wireless Test Set frequency error function.
2. The transmitter was allowed to stabilize at every 10 degrees C from -30°C to $+50^{\circ}\text{C}$ and measurements were recorded at each temperature.

Test Results

Refer to table below. Frequency remains within 6.91 kHz throughout all required temperature and supply voltage variations. The fundamental emissions of the transmitter remain within the authorized bands of operation under all conditions of temperature and operating voltage

Quantum 6636 Frequency Accuracy Test Data

Center frequency = 3.6625GHz

-30C to + 50C in 10C steps

45 minute minimum soak time at each temperature between readings.

Frequency measured using Agilent MXA spectrum analyzer in VSA mode to demodulate WiMAX signal.

Temperature C	Measured Center Frequency kHz	Deviation from nominal @ 20C kHz
-30	3662494.63	-6.91
-20	3662495.5	-6.04
-10	3662496.81	-4.73
0	3662498.9	-2.64
10	3662500.258	-1.282
20	3662501.54	0
30	3662502.18	0.64
40	3662503.05	1.51
50	3662502.6	1.06

Frequency Variation with voltage @ 20C

Voltage	Measured Center Frequency kHz	Deviation from nominal @ -48VDC kHz
-40.8	3662501.54	0
-48	3662501.54	0
-55.2	3662501.51	-0.03

5. SETUP PHOTOS

ANTENNA PORT CONDUCTED RF MEASUREMENT SETUP

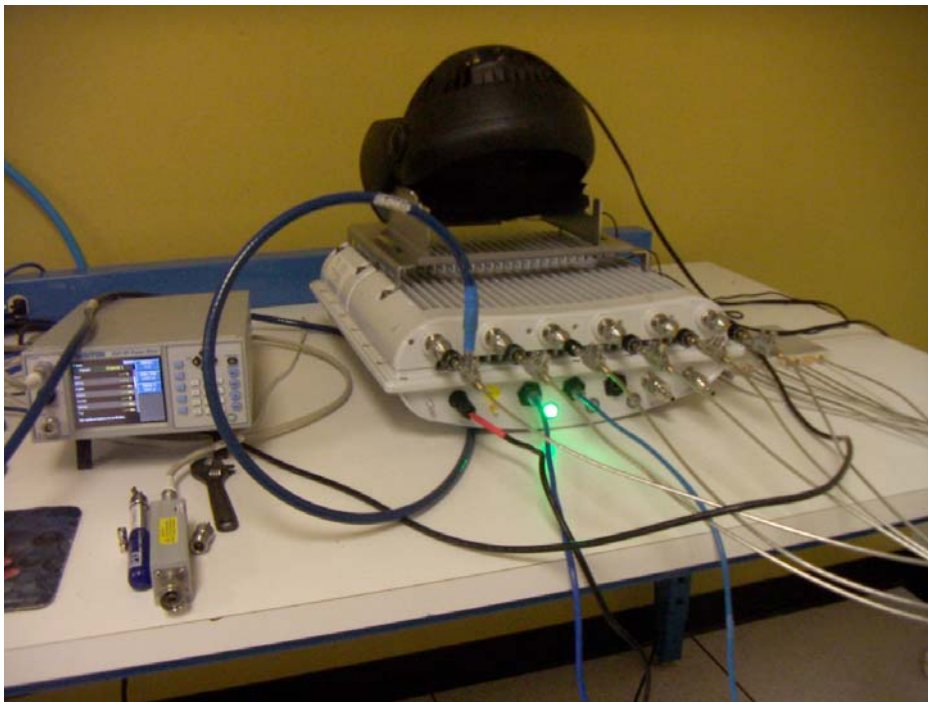

RADIATED RF MEASUREMENT SETUP

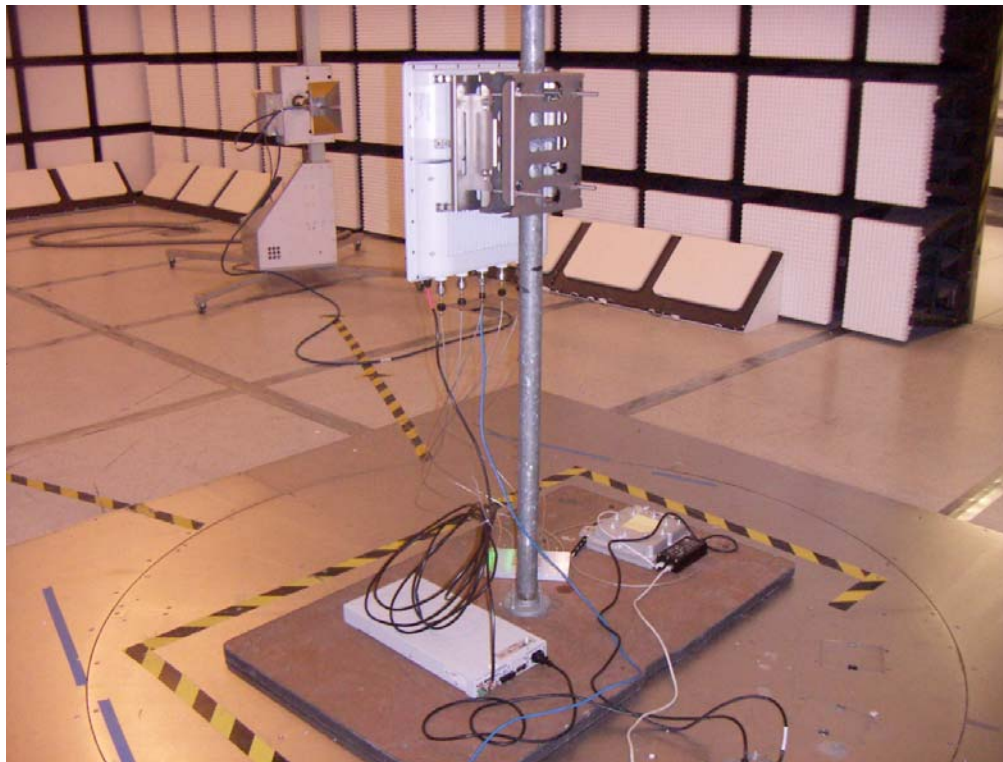
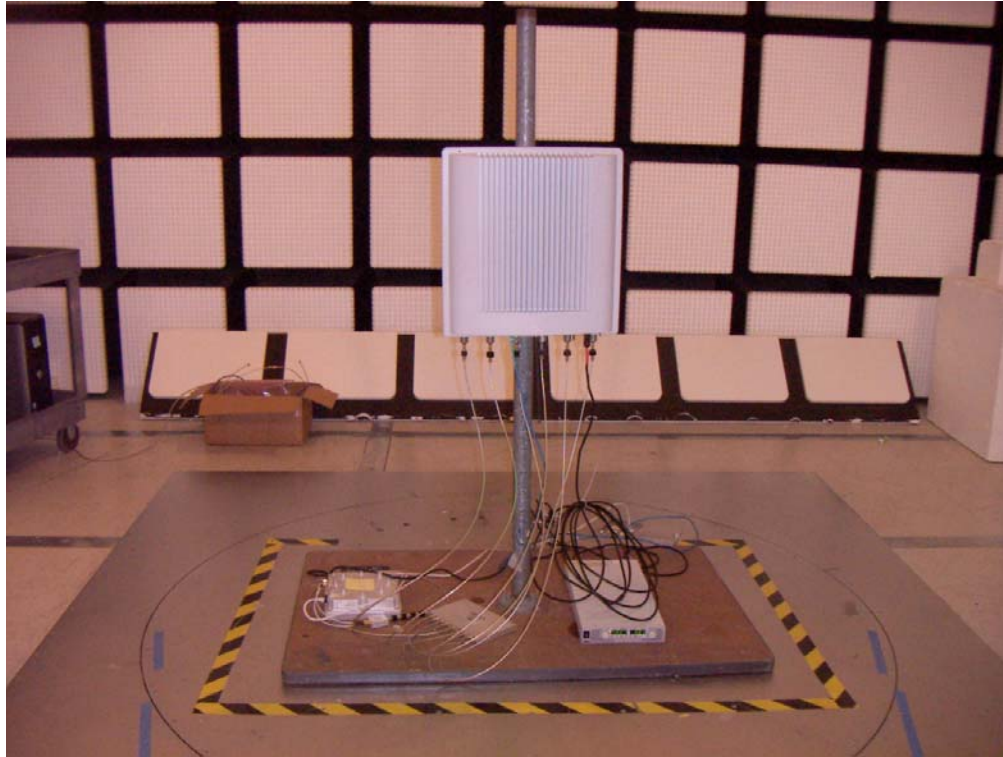

FREQUENCY STABILITY MEASUREMENT SETUP



END OF REPORT