



# FCC RF Test Report

**APPLICANT** : Quetel Wireless Solutions Co., Ltd.  
**EQUIPMENT** : 5G NR Module  
**BRAND NAME** : QUECTEL  
**MODEL NAME** : AG555Q-GL  
**FCC ID** : XMR2024AG555QGL  
**STANDARD** : 47 CFR Part 2, 27(F), 27(H), 27(N)  
**CLASSIFICATION** : PCS Licensed Transmitter (PCB)  
**TEST DATE(S)** : Jan. 31, 2024 ~ Apr. 11, 2024

We, Sporton International Inc. (Kunshan), would like to declare that the tested sample has been evaluated in accordance with the procedures given in ANSI C63.26-2015 and shown compliance with the applicable technical standards.

The test results in this report apply exclusively to the tested model / sample. Without written approval of Sporton International Inc. (Kunshan), the test report shall not be reproduced except in full.

Jason Jia

Approved by: Jason Jia



**Sporton International Inc. (Kunshan)**

**No. 1098, Pengxi North Road, Kunshan Economic Development Zone Jiangsu Province 215300  
People's Republic of China**



TABLE OF CONTENTS

REVISION HISTORY... 3
SUMMARY OF TEST RESULT ... 4
1 GENERAL DESCRIPTION ... 5
1.1 Applicant ... 5
1.2 Manufacturer ... 5
1.3 Product Feature of Equipment Under Test ... 5
1.4 Product Specification of Equipment Under Test ... 6
1.5 Modification of EUT ... 6
1.6 Maximum Conducted Power and Emission Designator ... 7
1.7 Testing Location ... 8
1.8 Test Software ... 8
1.9 Applicable Standards ... 8
2 TEST CONFIGURATION OF EQUIPMENT UNDER TEST ... 9
2.1 Test Mode ... 9
2.2 Connection Diagram of Test System ... 10
2.3 Support Unit used in test configuration and system ... 10
2.4 Measurement Results Explanation Example ... 11
2.5 Frequency List of Low/Middle/High Channels ... 11
3 CONDUCTED TEST ITEMS ... 13
3.1 Measuring Instruments ... 13
3.2 Test Setup ... 13
3.3 Test Result of Conducted Test ... 13
3.4 Conducted Output Power and ERP ... 14
3.5 Peak-to-Average Ratio ... 15
3.6 Occupied Bandwidth ... 16
3.7 Conducted Band Edge ... 17
3.8 Conducted Spurious Emission ... 18
3.9 Frequency Stability ... 19
4 RADIATED TEST ITEMS ... 20
4.1 Measuring Instruments ... 20
4.2 Test Setup ... 20
4.3 Test Result of Radiated Test ... 21
4.4 Radiated Spurious Emission ... 22
5 LIST OF MEASURING EQUIPMENT ... 23
6 MEASUREMENT UNCERTAINTY ... 24
APPENDIX A. TEST RESULTS OF CONDUCTED TEST
APPENDIX B. TEST RESULTS OF RADIATED TEST
APPENDIX C. TEST SETUP PHOTOGRAPHS



### REVISION HISTORY

REPORT NO.	VERSION	DESCRIPTION	ISSUED DATE
FG3D1801D	Rev. 01	Initial issue of report	Jun. 06, 2024



### SUMMARY OF TEST RESULT

Report Section	FCC Rule	Description	Limit	Result	Remark
3.4	§2.1046	Conducted Output Power	-	Report Only	-
	§27.50(b)(10) §27.50(c)(10)	Effective Radiated Power (Band 12) (Band 13) (Band 17) (Band 71)	ERP < 3 Watt		-
3.5	N/A	Peak-to-Average Ratio	<13 dB	PASS	-
3.6	§2.1049	Occupied Bandwidth	-	Report Only	-
3.7	§2.1051 §27.53(c)(2)(4) §27.53(g)	Conducted Band Edge Measurement (Band 12) (Band 13) (Band 17) (Band 71)	< 43+10log <sub>10</sub> (P[Watts])	PASS	-
3.8	§2.1051 §27.53(c)(2) §27.53(g)	Conducted Spurious Emission (Band 12) (Band 13) (Band 17) (Band 71)	< 43+10log <sub>10</sub> (P[Watts])	PASS	-
3.9	§2.1055 §27.54	Frequency Stability Temperature & Voltage	Within Authorized Band	PASS	-
4.4	§2.1053 §27.53(c)(2) §27.53(f) §27.53(g)	Radiated Spurious Emission (Band 12) (Band 13) (Band 17) (Band 71)	< 43+10log <sub>10</sub> (P[Watts])	PASS	Under limit 12.63 dB at 1568.00 MHz

**Conformity Assessment Condition:**

- The test results (PASS/FAIL) with all measurement uncertainty excluded are presented against the regulation limits or in accordance with the requirements stipulated by the applicant/manufacturer who shall bear all the risks of non-compliance that may potentially occur if measurement uncertainty is taken into account.
- The measurement uncertainty please refer to each test result in the section "Measurement Uncertainty"

**Disclaimer:**

The product specifications of the EUT presented in the test report that may affect the test assessments are declared by the manufacturer who shall take full responsibility for the authenticity.



# 1 General Description

## 1.1 Applicant

**Quectel Wireless Solutions Co., Ltd.**

Building 5, Shanghai Business Park Phase III (Area B), No.1016 Tianlin Road, Minhang District, Shanghai, 200233, China

## 1.2 Manufacturer

**Quectel Wireless Solutions Co., Ltd.**

Building 5, Shanghai Business Park Phase III (Area B), No.1016 Tianlin Road, Minhang District, Shanghai, 200233, China

## 1.3 Product Feature of Equipment Under Test

Product Feature	
Equipment	5G NR Module
Brand Name	QUECTEL
Model Name	AG555Q-GL
FCC ID	XMR2024AG555QGL
IMEI Code	Conducted: 868637060025178/868637060023777 Radiation: 868637060025087
HW Version	R1.0
SW Version	BYA555QGLABR01A01M8G_OCPU
EUT Stage	Identical Prototype



### 1.4 Product Specification of Equipment Under Test

Standards-related Product Specification	
<b>Tx Frequency</b>	LTE Band 12 : 699 MHz ~ 716 MHz LTE Band 13 : 777 MHz ~ 787 MHz LTE Band 17 : 704 MHz ~ 716 MHz LTE Band 71: 663 MHz ~ 698 MHz
<b>Rx Frequency</b>	LTE Band 12 : 729 MHz ~ 746 MHz LTE Band 13 : 746 MHz ~ 756 MHz LTE Band 17 : 734 MHz ~ 746 MHz LTE Band 71: 617 MHz ~ 652 MHz
<b>Bandwidth</b>	LTE Band 12 : 1.4MHz / 3MHz / 5MHz / 10MHz LTE Band 13 : 5MHz / 10MHz LTE Band 17 : 5MHz / 10MHz LTE Band 71 : 5MHz / 10MHz / 15MHz / 20MHz
<b>Maximum Output Power to Antenna</b>	LTE Band 12 : 23.47 dBm LTE Band 13 : 23.76 dBm LTE Band 17 : 24.15 dBm LTE Band 71 : 23.45 dBm
<b>Antenna Gain</b>	LTE Band 12 : -0.2 dBi LTE Band 13 : 1.54 dBi LTE Band 17 : -0.2 dBi LTE Band 71 : 1.22 dBi
<b>Type of Modulation</b>	QPSK / 16QAM / 64QAM / 256QAM

**Note:** The device supports two PAs for LTE Band 12/13/71: main PA and other PA. Both the PA are full tested, the maximum power of main PA is higher than the other PA, therefore, we chose higher power of main PA to calculate the ERP and show in the report.

### 1.5 Modification of EUT

No modifications are made to the EUT during all test items.



### 1.6 Maximum Conducted Power and Emission Designator

LTE Band 12		QPSK		16QAM/64QAM/256QAM	
BW (MHz)	Frequency Range (MHz)	Maximum Conducted power (W)	Emission Designator (99%OBW)	Maximum Conducted power (W)	Emission Designator (99%OBW)
1.4	699.7 ~ 715.3	0.2148	1M09G7D	0.1871	1M10W7D
3	700.5 ~ 714.5	0.2153	2M72G7D	0.1897	2M72W7D
5	701.5 ~ 713.5	0.2163	4M49G7D	0.1936	4M49W7D
10	704.0 ~ 711.0	0.2223	9M07G7D	0.1972	8M99W7D
LTE Band 13		QPSK		16QAM/64QAM/256QAM	
BW (MHz)	Frequency Range (MHz)	Maximum Conducted power (W)	Emission Designator (99%OBW)	Maximum Conducted power (W)	Emission Designator (99%OBW)
5	779.5 ~ 784.5	0.2366	4M50G7D	0.2089	4M49W7D
10	782.0	0.2377	9M01G7D	0.2178	9M01W7D
LTE Band 17		QPSK		16QAM/64QAM/256QAM	
BW (MHz)	Frequency Range (MHz)	Maximum Conducted power (W)	Emission Designator (99%OBW)	Maximum Conducted power (W)	Emission Designator (99%OBW)
5	706.5 ~ 713.5	0.2564	4M49G7D	0.2208	4M49W7D
10	709.0 ~ 711.0	0.2600	9M07G7D	0.2323	8M99W7D
LTE Band 71		QPSK		16QAM/64QAM/256QAM	
BW (MHz)	Frequency Range (MHz)	Maximum Conducted power (W)	Emission Designator (99%OBW)	Maximum Conducted power (W)	Emission Designator (99%OBW)
5	665.5 ~ 695.5	0.2178	4M50G7D	0.1879	4M50W7D
10	668.0 ~ 693.0	0.2213	9M01G7D	0.1884	8M99W7D
15	670.5 ~ 690.5	0.2198	13M5G7D	0.1884	13M5W7D
20	673.0 ~ 688.0	0.2213	17M9G7D	0.1888	17M9W7D

**Note:**

1. LTE Band 12 overlaps the entire frequency range of LTE Band 17. Therefore, the test results provided in this report covers Band 12 as well as Band 17.
2. All modulations have been tested, and only the worst test results of PSK & QAM are shown in the report.



### 1.7 Testing Location

Sporton International Inc. (Kunshan) is accredited to ISO/IEC 17025:2017 by American Association for Laboratory Accreditation with Certificate Number 5145.02.

<b>Test Firm</b>	Sporton International Inc. (Kunshan)		
<b>Test Site Location</b>	No. 1098, Pengxi North Road, Kunshan Economic Development Zone Jiangsu Province 215300 People's Republic of China TEL : +86-512-57900158		
<b>Test Site No.</b>	<b>Sporton Site No.</b>	<b>FCC Designation No.</b>	<b>FCC Test Firm Registration No.</b>
	03CH04-KS TH01-KS	CN1257	314309

### 1.8 Test Software

Item	Site	Manufacture	Name	Version
1.	TH01-KS	SPORTON	FCC LTE_Ver2.0 Auto_china_210503	2.0
2.	03CH04-KS	AUDIX	E3	210616

### 1.9 Applicable Standards

According to the specifications of the manufacturer, the EUT must comply with the requirements of the following standards:

- ♦ 47 CFR Part 2, 27(H), 27(F), 27(N)
- ♦ ANSI C63.26-2015
- ♦ FCC KDB 971168 D01 Power Meas License Digital Systems v03r01
- ♦ FCC KDB 412172 D01 Determining ERP and EIRP v01r01

**Remark:**

1. All test items were verified and recorded according to the standards and without any deviation during the test.
2. This EUT has also been tested and complied with the requirements of FCC Part 15, Subpart B, recorded in a separate test report.





## 2 Test Configuration of Equipment Under Test

### 2.1 Test Mode

Antenna port conducted and radiated test items listed below are performed according to KDB 971168 D01 Power Meas License Digital Systems v03r01 with maximum output power.

Radiated measurements are performed by rotating the EUT in three different orthogonal test planes to find the maximum emission.

Test Items	Band	Bandwidth (MHz)						Modulation				RB #			Test Channel		
		1.4	3	5	10	15	20	QPSK	16QAM	64QAM	256QAM	1	Half	Full	L	M	H
Max. Output Power	12	v	v	v	v	-	-	v	v	v	v	v		v	v	v	v
	13	-	-	v	v	-	-	v	v	v	v	v		v	v	v	v
	17	-	-	v	v	-	-	v	v	v	v	v		v	v	v	v
	71	-	-	v	v	v	v	v	v	v	v	v		v	v	v	v
Peak-to-Average Ratio	12				v	-	-	v	v	v	v			v		v	
	13	-	-		v	-	-	v	v	v	v			v		v	
	71	-	-				v	v	v	v	v			v		v	
26dB and 99% Bandwidth	12	v	v	v	v	-	-	v	v					v		v	
	13	-	-	v	v	-	-	v	v					v		v	
	71	-	-	v	v	v	v	v	v					v		v	
Conducted Band Edge	12	v	v	v	v	-	-	v	v	v	v	v		v	v		v
	13	-	-	v	v	-	-	v	v	v	v	v		v	v		v
	71	-	-	v	v	v	v	v	v	v	v	v		v	v		v
Conducted Spurious Emission	12	v	v	v	v	-	-	v				v			v	v	v
	13	-	-	v	v	-	-	v				v			v	v	v
	71	-	-	v	v	v	v	v				v			v	v	v
Frequency Stability	12				v	-	-	v						v		v	
	13	-	-		v	-	-	v						v		v	
	71	-	-		v			v						v		v	
E.R.P	12	v	v	v	v	-	-	v	v	v	v	v			v	v	v
	13	-	-	v	v	-	-	v	v	v	v	v			v	v	v
	17	-	-	v	v	-	-	v	v	v	v	v			v	v	v
	71	-	-	v	v	v	v	v	v	v	v	v			v	v	v
Radiated Spurious Emission	12	Worst Case												v	v	v	
	13	Worst Case												v	v	v	
	71	Worst Case												v	v	v	
Note	<ol style="list-style-type: none"> <li>The mark "v" means that this configuration is chosen for testing</li> <li>The mark "-" means that this bandwidth is not supported.</li> <li>The device is investigated from 30MHz to 10 times of fundamental signal for radiated spurious emission test under different RB size/offset and modulations in exploratory test. Subsequently, only the worst case emissions are reported.</li> <li>LTE Band 12 overlaps the entire frequency range of LTE Band 17. Therefore, the test results provided in this report covers Band 12 as well as Band 17.</li> </ol>																

## 2.2 Connection Diagram of Test System

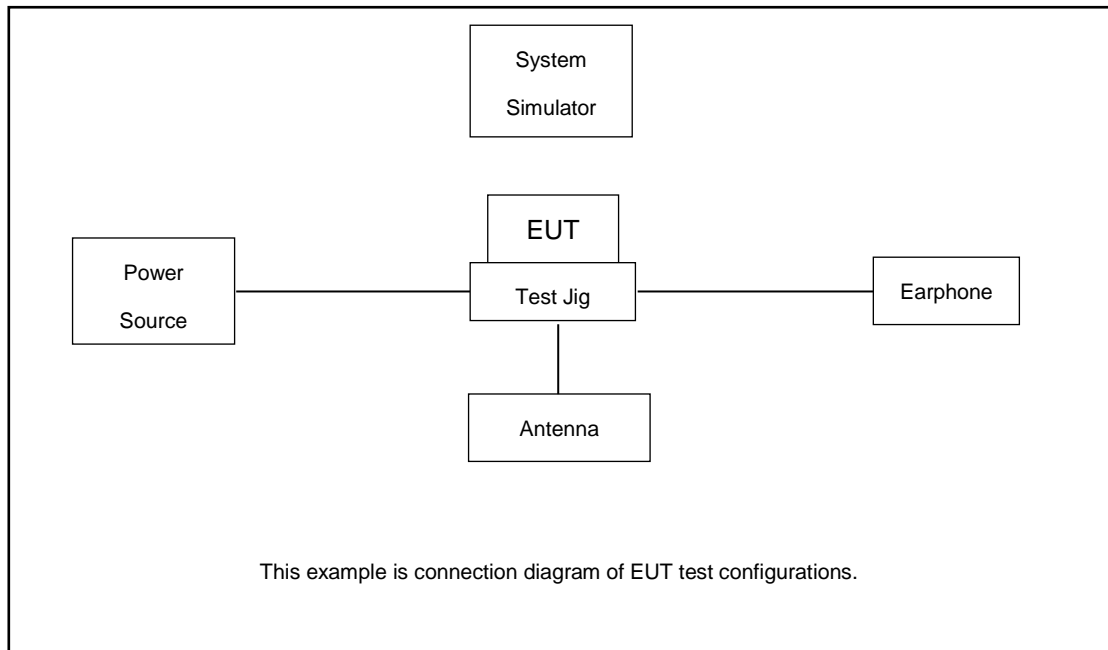

## 2.3 Support Unit used in test configuration and system

Item	Equipment	Trade Name	Model No.	FCC ID	Data Cable	Power Cord
1.	Power Supply	GWINSTEK	PSS-2002	N/A	N/A	Unshielded, 1.8 m
2.	Base Station	Anritsu	MT8820/8821	N/A	N/A	Unshielded, 1.8 m
3.	Test jig	N/A	N/A	N/A	N/A	N/A
4.	Antenna	N/A	N/A	N/A	N/A	N/A
5.	Adapter	N/A	N/A	N/A	N/A	N/A
6.	Earphone	N/A	N/A	N/A	N/A	N/A



## 2.4 Measurement Results Explanation Example

### For all conducted test items:

The offset level is set in the spectrum analyzer to compensate the RF cable loss between EUT conducted output port and spectrum analyzer. With the offset compensation, the spectrum analyzer reading level is exactly the EUT RF output level.

The spectrum analyzer offset is derived from RF cable loss.

$$\text{Offset} = \text{RF cable loss.}$$

Following shows an offset computation example with cable loss 4.3 dB.

Example :

$$\begin{aligned} \text{Offset(dB)} &= \text{RF cable loss(dB)}. \\ &= 4.3 \text{ (dB)} \end{aligned}$$

## 2.5 Frequency List of Low/Middle/High Channels

LTE Band 12 Channel and Frequency List				
BW [MHz]	Channel/Frequency(MHz)	Lowest	Middle	Highest
10	Channel	23060	23095	23130
	Frequency	704	707.5	711
5	Channel	23035	23095	23155
	Frequency	701.5	707.5	713.5
3	Channel	23025	23095	23165
	Frequency	700.5	707.5	714.5
1.4	Channel	23017	23095	23173
	Frequency	699.7	707.5	715.3

LTE Band 13 Channel and Frequency List				
BW [MHz]	Channel/Frequency(MHz)	Lowest	Middle	Highest
10	Channel	-	23230	-
	Frequency	-	782	-
5	Channel	23205	23230	23255
	Frequency	779.5	782	784.5



LTE Band 17 Channel and Frequency List				
BW [MHz]	Channel/Frequency(MHz)	Lowest	Middle	Highest
10	Channel	23780	23790	23800
	Frequency	709	710	711
5	Channel	23755	23790	23825
	Frequency	706.5	710	713.5

LTE Band 71 Channel and Frequency List				
BW [MHz]	Channel/Frequency(MHz)	Lowest	Middle	Highest
20	Channel	133222	133322	133372
	Frequency	673.0	680.5	688.0
15	Channel	133197	133297	133397
	Frequency	670.5	680.5	690.5
10	Channel	133172	133272	133422
	Frequency	668.0	678.0	693.0
5	Channel	133147	133247	133447
	Frequency	665.5	675.5	695.5

### 3 Conducted Test Items

#### 3.1 Measuring Instruments

See list of measuring instruments of this test report.

#### 3.2 Test Setup

##### 3.2.1 Conducted Output Power

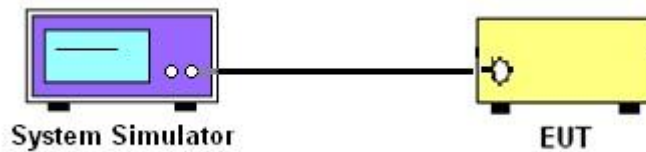

##### 3.2.2 Peak-to-Average Ratio, Occupied Bandwidth ,Conducted Band-Edge and Conducted Spurious Emission

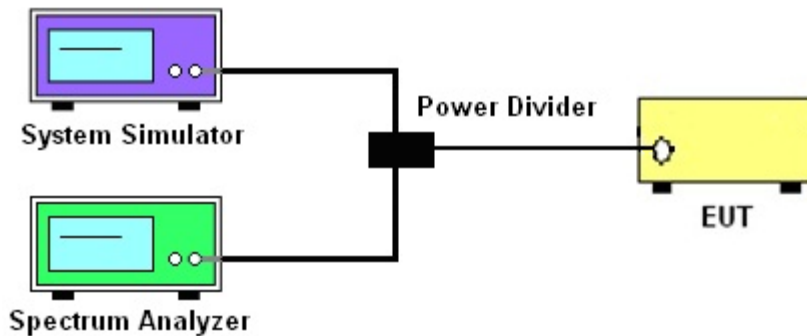

##### 3.2.3 Frequency Stability

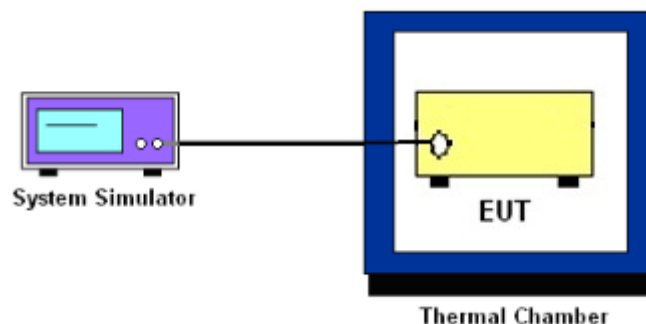

### 3.3 Test Result of Conducted Test

Please refer to Appendix A.



### 3.4 Conducted Output Power and ERP

#### 3.4.1 Description of the Conducted Output Power Measurement and ERP Measurement

A system simulator was used to establish communication with the EUT. Its parameters were set to force the EUT transmitting at maximum output power. The measured power in the radio frequency on the transmitter output terminals shall be reported.

The ERP of mobile transmitters must not exceed 3 Watts for LTE Band 12, Band 13 and Band 17 and Band 71.

According to KDB 412172 D01 Power Approach,

$EIRP = P_T + G_T - L_C$ ,  $ERP = EIRP - 2.15$ , where

$P_T$  = transmitter output power in dBm

$G_T$  = gain of the transmitting antenna in dBi

$L_C$  = signal attenuation in the connecting cable between the transmitter and antenna in dB

#### 3.4.2 Test Procedures

1. The testing follows ANSI C63.26 Section 5.2
2. The transmitter output port was connected to the system simulator.
3. Set EUT at maximum power through the system simulator.
4. Select lowest, middle, and highest channels for each band and different modulation.
5. Measure and record the power level from the system simulator.



## **3.5 Peak-to-Average Ratio**

### **3.5.1 Description of the PAR Measurement**

Power Complementary Cumulative Distribution Function (CCDF) curves provide a means for characterizing the power peaks of a digitally modulated signal on a statistical basis. A CCDF curve depicts the probability of the peak signal amplitude exceeding the average power level. Most contemporary measurement instrumentation include the capability to produce CCDF curves for an input signal provided that the instrument's resolution bandwidth can be set wide enough to accommodate the entire input signal bandwidth. In measuring transmissions in this band using an average power technique, the peak-to-average ratio (PAR) of the transmission may not exceed 13 dB.

### **3.5.2 Test Procedures**

1. The testing follows ANSI C63.26 Section 5.2.3.4 (CCDF).
2. The EUT was connected to spectrum and system simulator via a power divider.
3. Set the CCDF (Complementary Cumulative Distribution Function) option in spectrum analyzer.
4. The highest RF powers were measured and recorded the maximum PAPR level associated with a probability of 0.1 %.
5. Record the deviation as Peak to Average Ratio.



### 3.6 Occupied Bandwidth

#### 3.6.1 Description of Occupied Bandwidth Measurement

The occupied bandwidth is the width of a frequency band such that, below the lower and above the upper frequency limits, the mean powers emitted are each equal to a specified percentage 0.5% of the total mean transmitted power.

The 26 dB emission bandwidth is defined as the frequency range between two points, one above and one below the carrier frequency, at which the spectral density of the emission is attenuated 26 dB below the maximum in-band spectral density of the modulated signal. Spectral density (power per unit bandwidth) is to be measured with a detector of resolution bandwidth equal to approximately 1.0% of the emission bandwidth.

#### 3.6.2 Test Procedures

1. The testing follows ANSI C63.26 Section 5.4
2. The EUT was connected to spectrum analyzer and system simulator via a power divider.
3. The spectrum analyzer center frequency is set to the nominal EUT channel center frequency. The span range for the spectrum analyzer shall be between two and five times the anticipated OBW.
4. The nominal resolution bandwidth (RBW) shall be in the range of 1 to 5 % of the anticipated OBW, and the VBW shall be at least 3 times the RBW.
5. Set the detection mode to peak, and the trace mode to max hold.
6. Determine the reference value: Set the EUT to transmit a modulated signal. Allow the trace to stabilize. Set the spectrum analyzer marker to the highest level of the displayed trace.  
(this is the reference value)
7. Determine the “-26 dB down amplitude” as equal to (Reference Value – X).
8. Place two markers, one at the lowest and the other at the highest frequency of the envelope of the spectral display such that each marker is at or slightly below the “-X dB down amplitude” determined in step 6. If a marker is below this “-X dB down amplitude” value it shall be placed as close as possible to this value. The OBW is the positive frequency difference between the two markers.
9. Use the 99 % power bandwidth function of the spectrum analyzer and report the measured bandwidth.





## 3.7 Conducted Band Edge

### 3.7.1 Description of Conducted Band Edge Measurement

27.53 (c)

For operations in the 776-788 MHz band, the FCC limit is  $43 + 10\log_{10}(P[\text{Watts}])$  dB below the transmitter power P(Watts) in a 100 kHz bandwidth. However, in the 100 kHz bands immediately outside and adjacent to the frequency block, a resolution bandwidth of at least 30 kHz may be employed. In addition, the power of any unwanted emissions in any 6.25 kHz bandwidth for all frequencies between 763-775 MHz and 793-806 MHz shall be attenuated below the transmitter power, P (dBW), by at least  $65 + 10 \log_{10} p(\text{watts})$ , dB, for mobile and portable equipment.

27.53 (g)

For operations in the 600MHz band and 698 -746 MHz band, the FCC limit is  $43 + 10\log_{10}(P[\text{Watts}])$  dB below the transmitter power P(Watts) in a 100 kHz bandwidth. However, in the 100 kilohertz bands immediately outside and adjacent to a licensee's frequency block, a resolution bandwidth of at least 30 kHz may be employed.

### 3.7.2 Test Procedures

1. The testing follows ANSI C63.26 section 5.7
2. The EUT was connected to spectrum analyzer and system simulator via a power divider.
3. The band edges of low and high channels for the highest RF powers were measured.
4. Set RBW  $\geq$  1% EBW in the 1MHz band immediately outside and adjacent to the band edge.
5. Beyond the 1 MHz band from the band edge, RBW=1MHz was used
6. Set spectrum analyzer with RMS detector.
7. The RF fundamental frequency should be excluded against the limit line in the operating frequency band.
8. Checked that all the results comply with the emission limit line.

Example:

The limit line is derived from  $43 + 10\log(P)$ dB below the transmitter power P(Watts)  
 $= P(W) - [43 + 10\log(P)]$  (dB)  
 $= [30 + 10\log(P)]$  (dBm) -  $[43 + 10\log(P)]$  (dB) = -13dBm.

9. When using the integration method, the starting frequency of the integration shall be centered at one-half of the RBW away from the band edge.



### 3.8 Conducted Spurious Emission

#### 3.8.1 Description of Conducted Spurious Emission Measurement

The power of any emission outside of the authorized operating frequency ranges must be lower than the transmitter power (P) by a factor of at least  $43 + 10 \log (P)$  dB.

It is measured by means of a calibrated spectrum analyzer and scanned from 30 MHz up to a frequency including its 10<sup>th</sup> harmonic.

#### 3.8.2 Test Procedures

1. The testing follows ANSI C63.26 section 5.7
2. The EUT was connected to spectrum analyzer and system simulator via a power divider.
3. The RF output of EUT was connected to the spectrum analyzer by RF cable and attenuator. The path loss was compensated to the results for each measurement.
4. The middle channel for the highest RF power within the transmitting frequency was measured.
5. The conducted spurious emission for the whole frequency range was taken.
6. Make the measurement with the spectrum analyzer's RBW = 1MHz, VBW = 3MHz.
7. Set spectrum analyzer with RMS detector.
8. Taking the record of maximum spurious emission.
9. The RF fundamental frequency should be excluded against the limit line in the operating frequency band.
10. The limit line is derived from  $43 + 10\log(P)$ dB below the transmitter power P(Watts)  
= P(W)- [43 + 10log(P)] (dB)  
= [30 + 10log(P)] (dBm) - [43 + 10log(P)] (dB)  
= -13dBm.



## 3.9 Frequency Stability

### 3.9.1 Description of Frequency Stability Measurement

The frequency stability shall be measured by variation of ambient temperature and variation of primary supply voltage to ensure that the fundamental emission stays within the authorized frequency block. The frequency stability of the transmitter shall be maintained within  $\pm 0.00025\%$  ( $\pm 2.5\text{ppm}$ ) of the center frequency.

### 3.9.2 Test Procedures for Temperature Variation

1. The testing follows ANSI C63.26 section 5.6.4
2. The EUT was set up in the thermal chamber and connected with the system simulator.
3. With power OFF, the temperature was decreased to  $-30^{\circ}\text{C}$  and the EUT was stabilized before testing. Power was applied and the maximum change in frequency was recorded within one minute.
4. With power OFF, the temperature was raised in  $10^{\circ}\text{C}$  step up to  $50^{\circ}\text{C}$ . The EUT was stabilized at each step for at least half an hour. Power was applied and the maximum frequency change was recorded within one minute.

### 3.9.3 Test Procedures for Voltage Variation

1. The testing follows ANSI C63.26 section 5.6.5
2. The EUT was placed in a temperature chamber at  $20\pm 5^{\circ}\text{C}$  and connected with the system simulator.
3. The power supply voltage to the EUT was varied from 85% to 115% of the nominal value for other than hand carried battery equipment.
4. For hand carried, battery powered equipment, reduce the primary ac or dc supply voltage to the battery operating end point, which shall be specified by the manufacturer.
5. The variation in frequency was measured for the worst case.

## 4 Radiated Test Items

### 4.1 Measuring Instruments

See list of measuring instruments of this test report.

### 4.2 Test Setup

#### 4.2.1 For radiated test below 30MHz

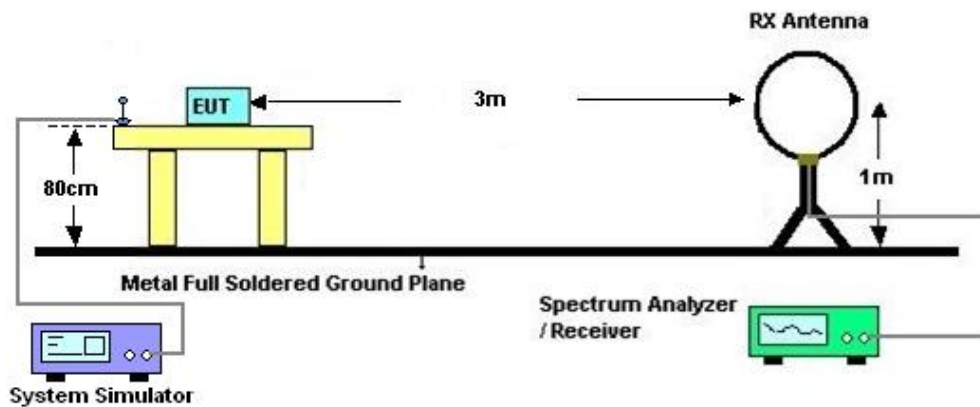

#### 4.2.2 For radiated test from 30MHz to 1GHz

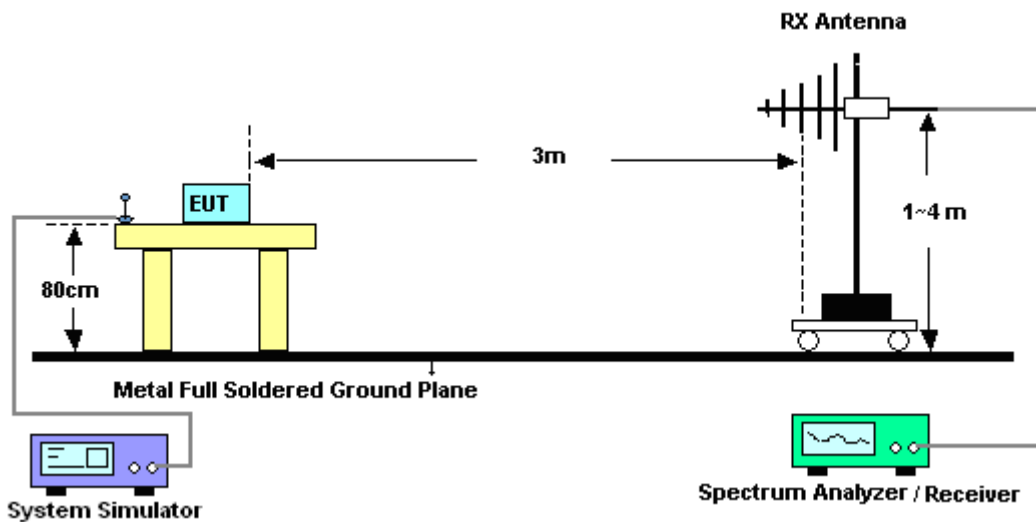

### 4.2.3 For radiated test above 1GHz

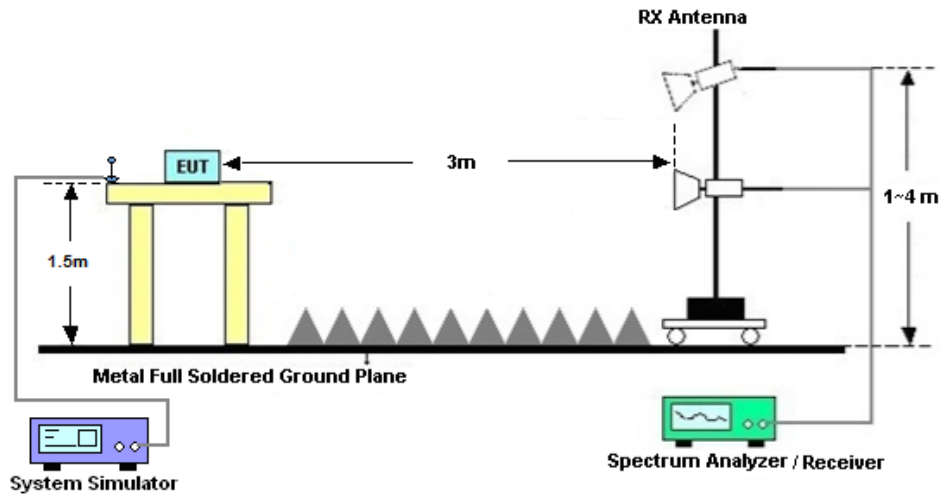

### 4.3 Test Result of Radiated Test

The low frequency, which started from 9 kHz to 30MHz, was pre-scanned and the result which was 20dB lower than the limit line was not reported.

Please refer to Appendix B.



## 4.4 Radiated Spurious Emission

### 4.4.1 Description of Radiated Spurious Emission

The radiated spurious emission was measured by substitution method according to ANSI C63.26. The power of any emission outside of the authorized operating frequency ranges must be attenuated below the transmitter power (P) by a factor of at least  $43 + 10 \log (P)$  dB.

For LTE Band 13

For operations in the 746-758 MHz, 775-788 MHz, and 805-806 MHz bands, emissions in the band 1559-1610 MHz shall be limited to  $-70$  dBW/MHz equivalent isotropically radiated power (EIRP) for wideband signals, and  $-80$  dBW EIRP for discrete emissions of less than 700 Hz bandwidth.

The spectrum is scanned from 30 MHz up to a frequency including its 10th harmonic.

### 4.4.2 Test Procedures

1. The testing follows ANSI C63.26 Section 5.5
2. The EUT was placed on a turntable with 0.8 meter height for frequency below 1GHz and 1.5 meter height for frequency above 1GHz respectively above ground.
3. The EUT was set 3 meters from the receiving antenna mounted on the antenna tower.
4. The table was rotated 360 degrees to determine the position of the highest spurious emission.
5. The height of the receiving antenna is varied between 1m to 4m to search the maximum spurious emission for both horizontal and vertical polarizations.
6. During the measurement, the system simulator parameters were set to force the EUT transmitting at maximum output power.
7. Make the measurement with the spectrum analyzer's RBW = 1MHz, VBW = 3MHz, taking the record of maximum spurious emission.
8. A horn antenna was substituted in place of the EUT and was driven by a signal generator.
9. Tune the output power of signal generator to the same emission level with EUT maximum spurious emission.
10.  $EIRP \text{ (dBm)} = S.G. \text{ Power} - Tx \text{ Cable Loss} + Tx \text{ Antenna Gain}$
11.  $ERP \text{ (dBm)} = EIRP - 2.15$
12. The RF fundamental frequency should be excluded against the limit line in the operating frequency band.

The limit line is derived from  $43 + 10\log(P)$ dB below the transmitter power P(Watts)  
 $= P(W) - [43 + 10\log(P)] \text{ (dB)}$   
 $= [30 + 10\log(P)] \text{ (dBm)} - [43 + 10\log(P)] \text{ (dB)}$   
 $= -13\text{dBm}.$



## 5 List of Measuring Equipment

Instrument	Manufacturer	Model No.	Serial No.	Characteristics	Calibration Date	Test Date	Due Date	Remark
Spectrum Analyzer	R&S	FSV40	101040	10Hz~40GHz	Oct. 11, 2023	Jan. 31, 2024~Apr. 11, 2024	Oct. 10, 2024	Conducted (TH01-KS)
Power divider	STI	STI08-0055	-	0.5~40GHz	NCR	Jan. 31, 2024~Apr. 11, 2024	NCR	Conducted (TH01-KS)
Temperature & humidity chamber	Hongzhan	LP-150U	H2014011440	-40~+150°C 20%~95%RH	Jul. 06, 2023	Jan. 31, 2024~Apr. 11, 2024	Jul. 05, 2024	Conducted (TH01-KS)
EXA Spectrum Analyzer	Keysight	N9010B	MY57471079	10Hz-44G,MAX 30dB	Oct. 10, 2023	Mar. 10, 2024	Oct. 09, 2024	Radiation (03CH04-KS)
Loop Antenna	R&S	HFH2-Z2E	101125	9kHz~30MHz	Sep. 11, 2023	Mar. 10, 2024	Sep. 10, 2024	Radiation (03CH04-KS)
Bilog Antenna	TeseQ	CBL6111D	49922	30MHz-1GHz	Apr. 09, 2023	Mar. 10, 2024	Apr. 08, 2024	Radiation (03CH04-KS)
Double Ridge Horn Antenna	ETS-Lindgren	3117	00251694	1GHz~18GHz	Jul. 12, 2023	Mar. 10, 2024	Jul. 11, 2024	Radiation (03CH04-KS)
SHF-EHF Horn	Com-power	AH-840	101070	18GHz~40GHz	Jan. 05, 2024	Mar. 10, 2024	Jan. 04, 2025	Radiation (03CH04-KS)
Amplifier	SONOMA	310N	380827	9KHz-1GHz	Jul. 06, 2023	Mar. 10, 2024	Jul. 05, 2024	Radiation (03CH04-KS)
Amplifier	MITEQ	EM18G40G GA	060728	18~40GHz	Jan. 05, 2024	Mar. 10, 2024	Jan. 04, 2025	Radiation (03CH04-KS)
high gain Amplifier	EM	EM01G18G A	060840	1Ghz-18Ghz	Oct. 10, 2023	Mar. 10, 2024	Oct. 09, 2024	Radiation (03CH04-KS)
Amplifier	Agilent	8449B	3008A02370	1Ghz-18Ghz	Oct. 10, 2023	Mar. 10, 2024	Oct. 09, 2024	Radiation (03CH04-KS)
AC Power Source	Chroma	61601	F104090004	N/A	NCR	Mar. 10, 2024	NCR	Radiation (03CH04-KS)
Turn Table	ChamPro	EM 1000-T	060762-T	0~360 degree	NCR	Mar. 10, 2024	NCR	Radiation (03CH04-KS)
Antenna Mast	ChamPro	EM 1000-A	060762-A	1 m~4 m	NCR	Mar. 10, 2024	NCR	Radiation (03CH04-KS)

NCR: No Calibration Required



## 6 Measurement Uncertainty

The measurement uncertainties shown below were calculated in accordance with the requirements of ANSI 63.26-2015. All the measurement uncertainty value were shown with a coverage K=2 to indicate 95% level of confidence. The measurement data show herein meets or exceeds the CISPR measurement uncertainty values specified in CISPR 16-4-2 and can be compared directly to specified limit to determine compliance.

### Uncertainty of Conducted Measurement

Test Item	Uncertainty
Conducted Spurious Emission & Bandedge	±2.26 dB
Occupied Channel Bandwidth	±0.1%
Conducted Power	±0.46 dB
Peak to Average Ratio	±0.46 dB
Frequency Stability	±0.4 Hz

### Uncertainty of Radiated Emission Measurement (30 MHz ~ 1000 MHz)

Measuring Uncertainty for a Level of Confidence of 95% (U = 2Uc(y))	3.82dB
---	--------

### Uncertainty of Radiated Emission Measurement (1 GHz ~ 18 GHz)

Measuring Uncertainty for a Level of Confidence of 95% (U = 2Uc(y))	3.56dB
---	--------

### Uncertainty of Radiated Emission Measurement (18 GHz ~ 40 GHz)

Measuring Uncertainty for a Level of Confidence of 95% (U = 2Uc(y))	3.54dB
---	--------

----- THE END -----





## Appendix A. Test Results of Conducted Test

Test Engineer :	Smile Wang	Temperature :	22~23°C
		Relative Humidity :	40~42%

### Conducted Output Power(Average power) and ERP

#### LTE Band 12:

BW [MHz]	Modulation	RB Size	RB Offset	Power Low Ch. / Freq.	Power Middle Ch. / Freq.	Power High Ch. / Freq.	ERP(W)		
Channel				23060	23095	23130			
Frequency (MHz)				704	707.5	711	L	M	H
10	QPSK	1	0	23.35	23.41	23.47	0.1259	0.1276	0.1294
10	QPSK	1	49	23.29	23.32	23.34	0.1242	0.1250	0.1256
10	QPSK	50	0	20.55	22.54	22.52	0.0661	0.1045	0.1040
10	16QAM	1	0	22.80	22.82	22.95	0.1109	0.1114	0.1148
10	64QAM	1	0	21.40	21.57	21.43	0.0804	0.0836	0.0809
10	256QAM	1	0	18.62	18.59	18.79	0.0424	0.0421	0.0441
Channel				23035	23095	23155	ERP(W)		
Frequency (MHz)				701.5	707.5	713.5	L	M	H
5	QPSK	1	0	23.28	23.35	23.32	0.1239	0.1259	0.1250
5	16QAM	1	0	22.59	22.87	22.49	0.1057	0.1127	0.1033
Channel				23025	23095	23165	ERP(W)		
Frequency (MHz)				700.5	707.5	714.5	L	M	H
3	QPSK	1	0	23.29	23.33	23.28	0.1242	0.1253	0.1239
3	16QAM	1	0	22.68	22.78	22.63	0.1079	0.1104	0.1067
Channel				23017	23095	23173	ERP(W)		
Frequency (MHz)				699.7	707.5	715.3	L	M	H
1.4	QPSK	1	0	23.24	23.31	23.32	0.1227	0.1247	0.1250
1.4	16QAM	1	0	22.59	22.63	22.72	0.1057	0.1067	0.1089

#### LTE Band 13:

BW [MHz]	Modulation	RB Size	RB Offset	Power Low Ch. / Freq.	Power Middle Ch. / Freq.	Power High Ch. / Freq.	ERP(W)		
Channel				23230					
Frequency (MHz)				782				M	
10	QPSK	1	0		23.76			0.2065	
10	QPSK	1	49		23.71			0.2042	
10	QPSK	50	0		22.94			0.1710	
10	16QAM	1	0		23.38			0.1892	
10	64QAM	1	0		21.52			0.1233	
10	256QAM	1	0		18.79			0.0658	
Channel				23205	23230	23255	ERP(W)		
Frequency (MHz)				779.5	782	784.5	L	M	H
5	QPSK	1	0	23.74	23.72	23.70	0.2056	0.2046	0.2037
5	16QAM	1	0	23.01	23.12	23.20	0.1738	0.1782	0.1816



LTE Band 17:

BW [MHz]	Modulation	RB Size	RB Offset	Power Low Ch. / Freq.	Power Middle Ch. / Freq.	Power High Ch. / Freq.	ERP(W)		
Channel				23780	23790	23800			
Frequency (MHz)				709	710	711	L	M	H
10	QPSK	1	0	24.10	24.15	24.08	0.1496	0.1514	0.1489
10	QPSK	1	49	23.98	23.90	23.84	0.1455	0.1429	0.1409
10	QPSK	50	0	23.12	23.17	23.17	0.1194	0.1208	0.1208
10	16QAM	1	0	23.62	23.54	23.66	0.1340	0.1315	0.1352
10	64QAM	1	0	21.59	21.48	21.74	0.0839	0.0818	0.0869
10	256QAM	1	0	19.11	19.24	19.18	0.0474	0.0489	0.0482
Channel				23755	23790	23825	ERP(W)		
Frequency (MHz)				706.5	710	713.5	L	M	H
5	QPSK	1	0	24.06	24.09	24.01	0.1483	0.1493	0.1466
5	16QAM	1	0	23.37	23.43	23.44	0.1265	0.1282	0.1285

LTE Band 71:

BW [MHz]	Modulation	RB Size	RB Offset	Power Low Ch. / Freq.	Power Middle Ch. / Freq.	Power High Ch. / Freq.	ERP(W)		
Channel				133222	133322	133372			
Frequency (MHz)				673	683	688	L	M	H
20	QPSK	1	0	23.45	23.34	23.42	0.1786	0.1742	0.1774
20	QPSK	1	99	23.17	23.06	23.03	0.1675	0.1633	0.1622
20	QPSK	100	0	22.47	22.31	22.40	0.1426	0.1374	0.1403
20	16QAM	1	0	22.59	22.76	22.69	0.1466	0.1524	0.1500
20	64QAM	1	0	21.63	21.66	21.62	0.1175	0.1183	0.1172
20	256QAM	1	0	18.58	18.57	18.47	0.0582	0.0581	0.0568
Channel				133197	133297	133397	EIRP(W)		
Frequency (MHz)				670.5	680.5	690.5	L	M	H
15	QPSK	1	0	23.42	23.32	23.42	0.1774	0.1734	0.1774
15	16QAM	1	0	22.75	22.74	22.58	0.1521	0.1517	0.1462
Channel				133172	133272	133422	EIRP(W)		
Frequency (MHz)				668	678	693	L	M	H
10	QPSK	1	0	23.45	23.36	23.33	0.1786	0.1750	0.1738
10	16QAM	1	0	22.73	22.75	22.58	0.1514	0.1521	0.1462
Channel				133147	133247	133447	EIRP(W)		
Frequency (MHz)				665.5	675.5	695.5	L	M	H
5	QPSK	1	0	23.38	23.34	23.38	0.1758	0.1742	0.1758
5	16QAM	1	0	22.73	22.74	22.36	0.1514	0.1517	0.1390



# LTE Band 12 (Main PA)

## Peak-to-Average Ratio

Mode	LTE Band 12 / 10MHz				
Mod.	QPSK	16QAM	64QAM	256QAM	Limit: 13dB
RB Size	Full RB	Full RB	Full RB	Full RB	Result
Middle CH	4.84	5.74	6.32	6.29	PASS

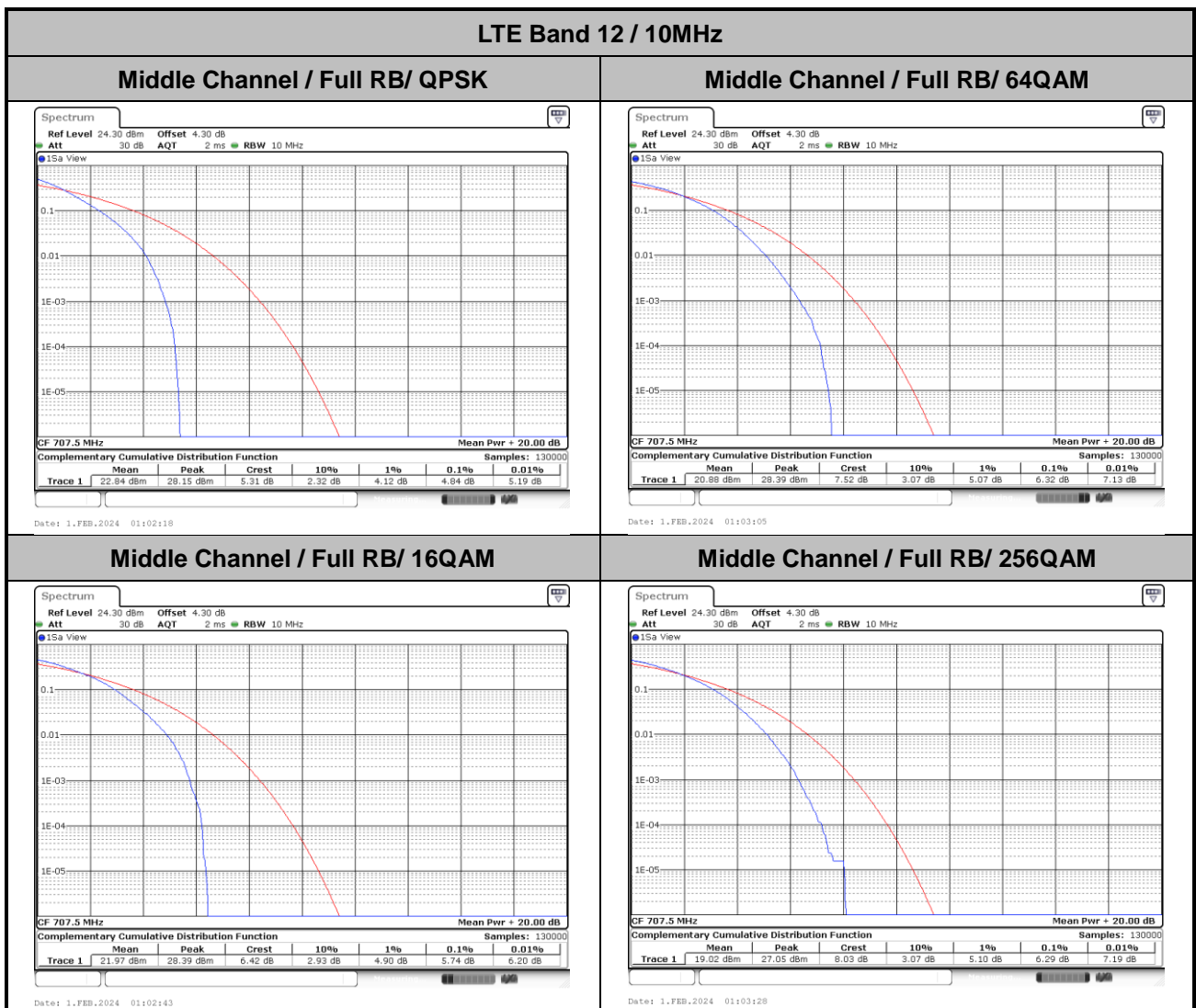



**26dB Bandwidth**

Mode	LTE Band 12 : 26dB BW(MHz)	
<b>BW</b>	<b>1.4MHz</b>	
<b>Mod.</b>	<b>QPSK</b>	<b>16QAM</b>
<b>Middle CH</b>	1.23	1.23
<b>BW</b>	<b>3MHz</b>	
<b>Mod.</b>	<b>QPSK</b>	<b>16QAM</b>
<b>Middle CH</b>	3.03	3.05
<b>BW</b>	<b>5MHz</b>	
<b>Mod.</b>	<b>QPSK</b>	<b>16QAM</b>
<b>Middle CH</b>	4.93	4.86
<b>BW</b>	<b>10MHz</b>	
<b>Mod.</b>	<b>QPSK</b>	<b>16QAM</b>
<b>Middle CH</b>	9.69	9.87

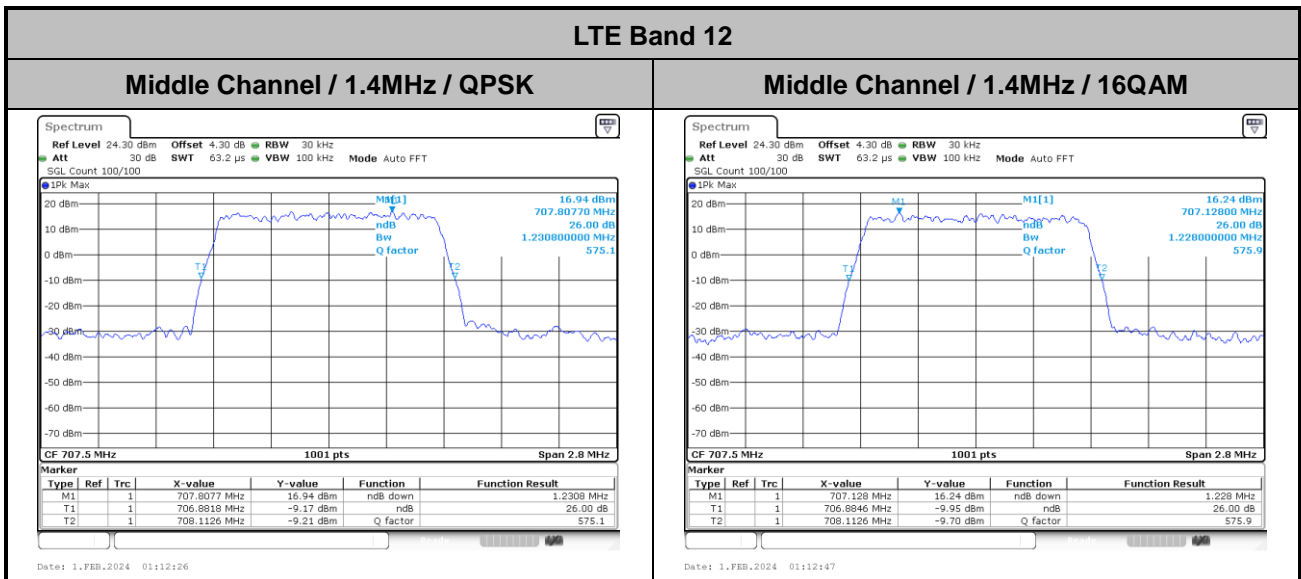



LTE Band 12

Middle Channel / 3MHz / QPSK

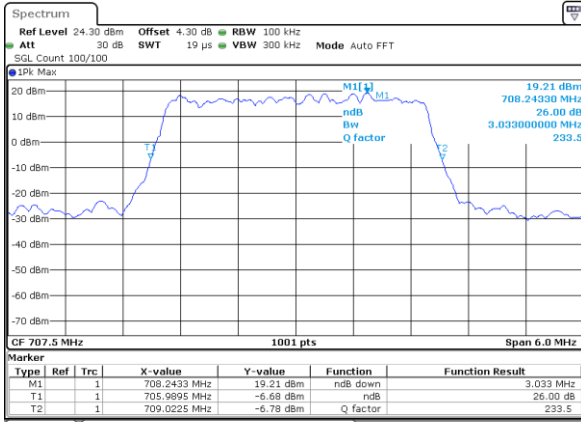

Date: 1.FEB.2024 01:07:19

Middle Channel / 3MHz / 16QAM

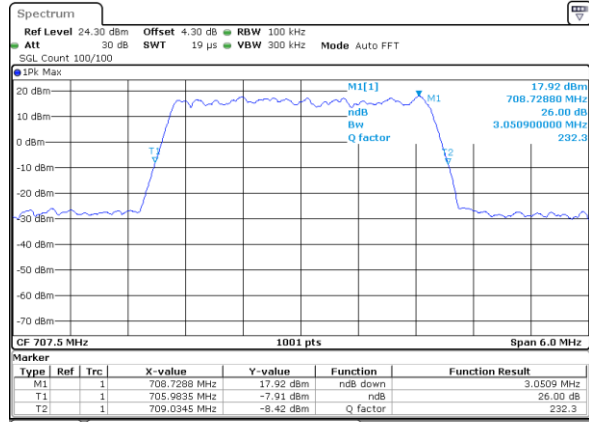

Date: 1.FEB.2024 01:07:40

LTE Band 12

Middle Channel / 5MHz / QPSK

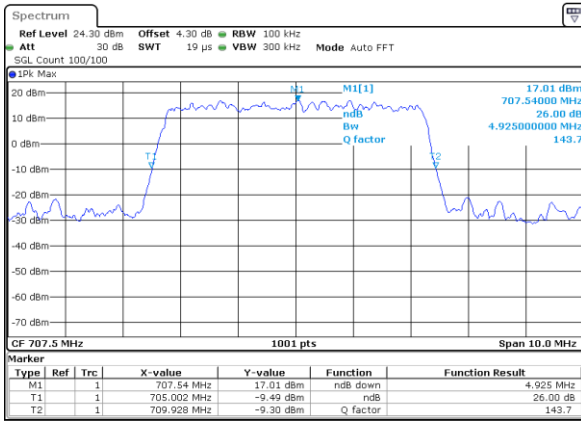

Date: 1.FEB.2024 01:05:54

Middle Channel / 5MHz / 16QAM

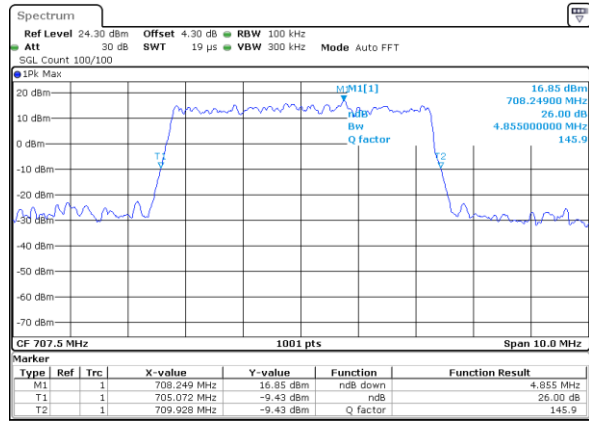

Date: 1.FEB.2024 01:06:15

LTE Band 12

Middle Channel / 10MHz / QPSK

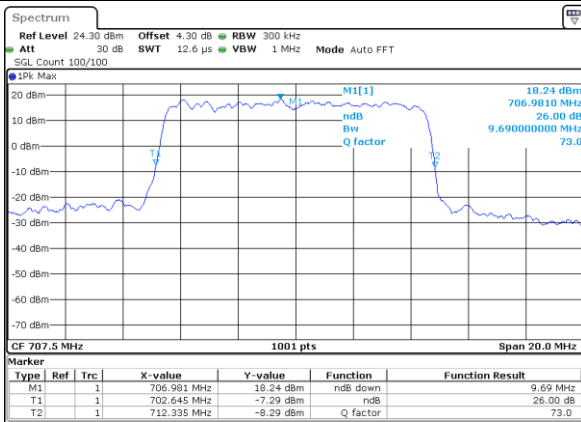

Date: 1.FEB.2024 01:04:51

Middle Channel / 10MHz / 16QAM

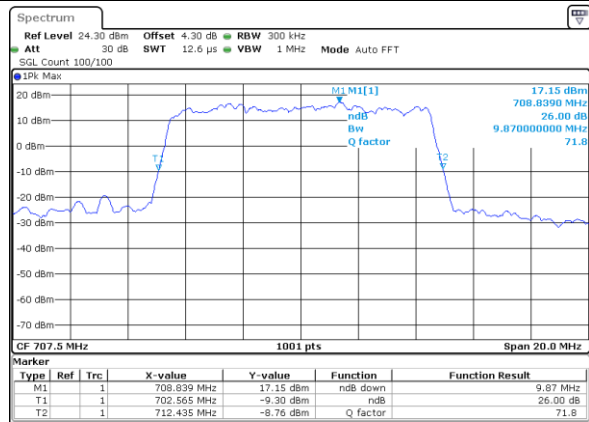

Date: 1.FEB.2024 01:05:12



# Occupied Bandwidth

Mode	LTE Band 12 : 99%OBW(MHz)	
<b>BW</b>	<b>1.4MHz</b>	
<b>Mod.</b>	<b>QPSK</b>	<b>16QAM</b>
<b>Middle CH</b>	1.09	1.09
<b>BW</b>	<b>3MHz</b>	
<b>Mod.</b>	<b>QPSK</b>	<b>16QAM</b>
<b>Middle CH</b>	2.72	2.70
<b>BW</b>	<b>5MHz</b>	
<b>Mod.</b>	<b>QPSK</b>	<b>16QAM</b>
<b>Middle CH</b>	4.48	4.49
<b>BW</b>	<b>10MHz</b>	
<b>Mod.</b>	<b>QPSK</b>	<b>16QAM</b>
<b>Middle CH</b>	9.01	8.99

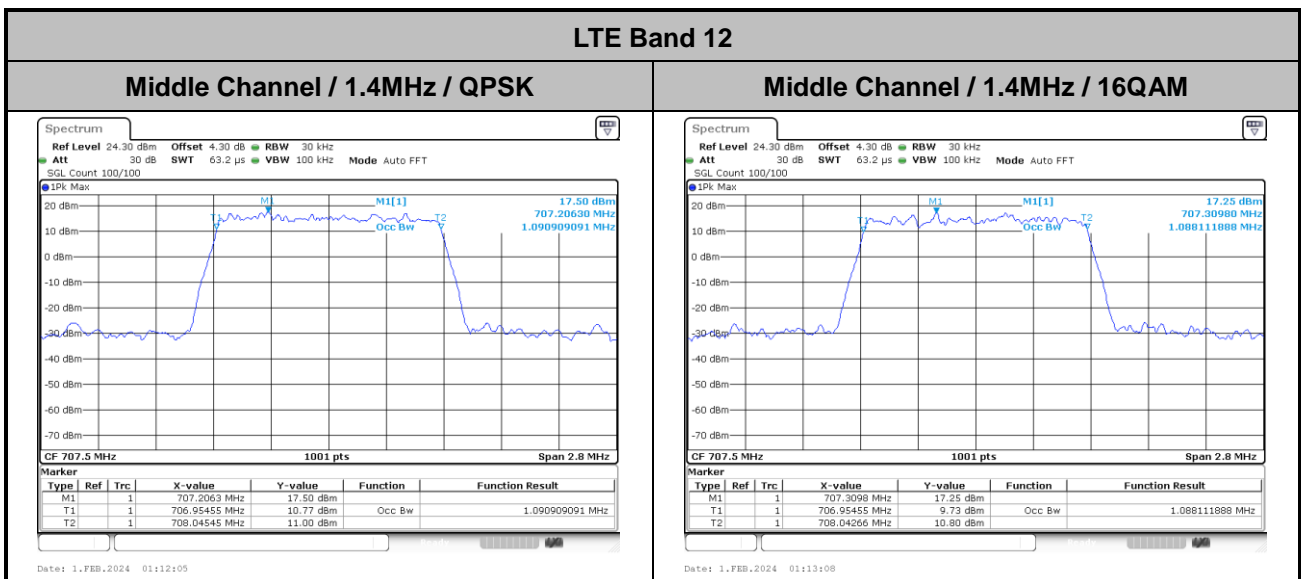



LTE Band 12

Middle Channel / 3MHz / QPSK

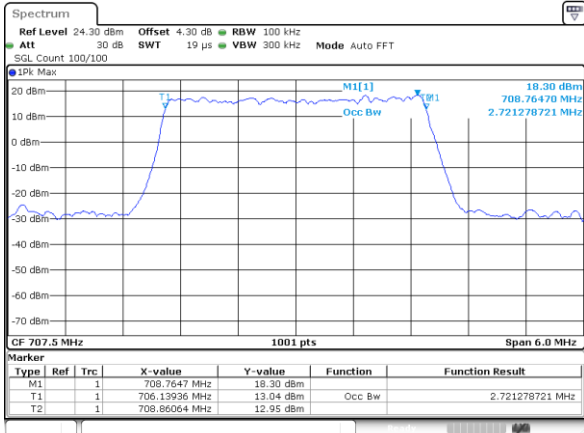

Date: 1.FEB.2024 01:06:58

Middle Channel / 3MHz / 16QAM

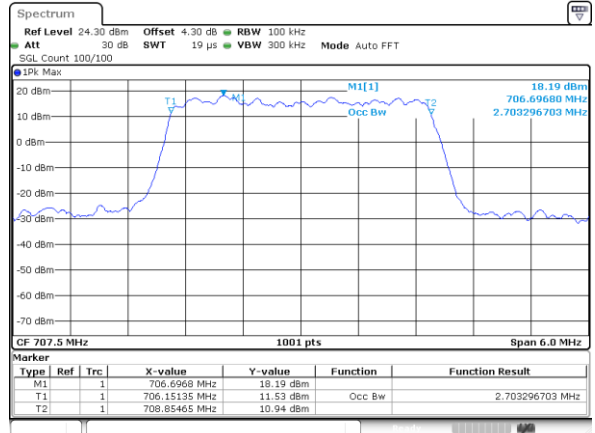

Date: 1.FEB.2024 01:08:01

LTE Band 12

Middle Channel / 5MHz / QPSK

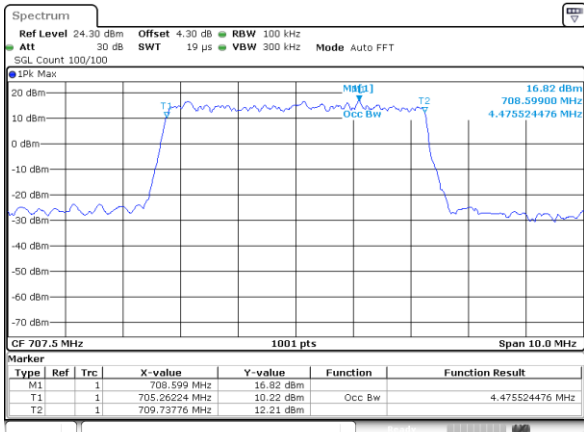

Date: 1.FEB.2024 01:05:34

Middle Channel / 5MHz / 16QAM

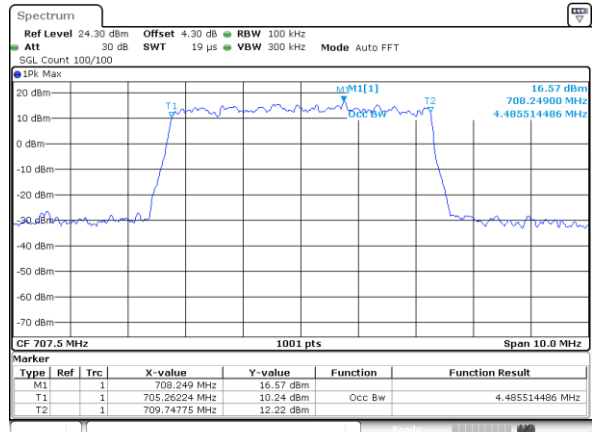

Date: 1.FEB.2024 01:06:36

LTE Band 12

Middle Channel / 10MHz / QPSK

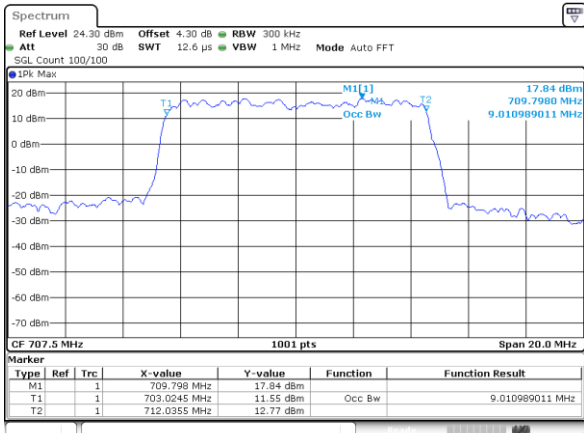

Date: 1.FEB.2024 01:04:09

Middle Channel / 10MHz / 16QAM

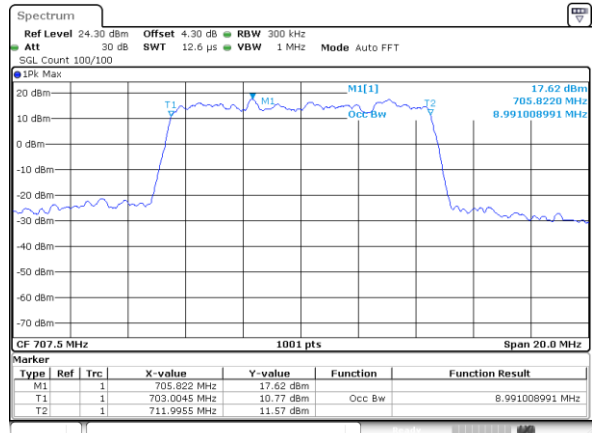

Date: 1.FEB.2024 01:04:30



# Conducted Band Edge

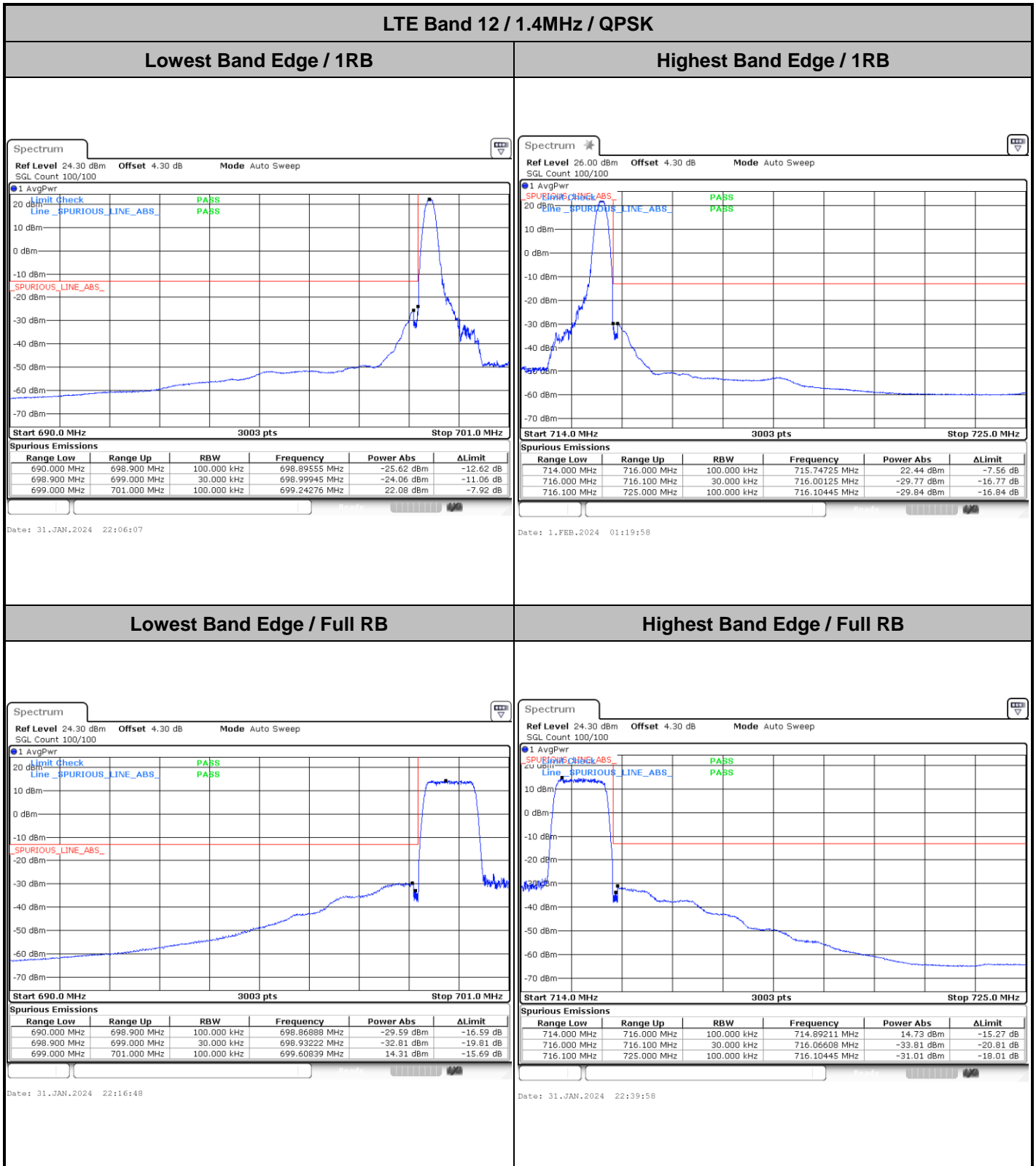





LTE Band 12 / 1.4MHz / 16QAM

Lowest Band Edge / 1 RB

Highest Band Edge / 1 RB

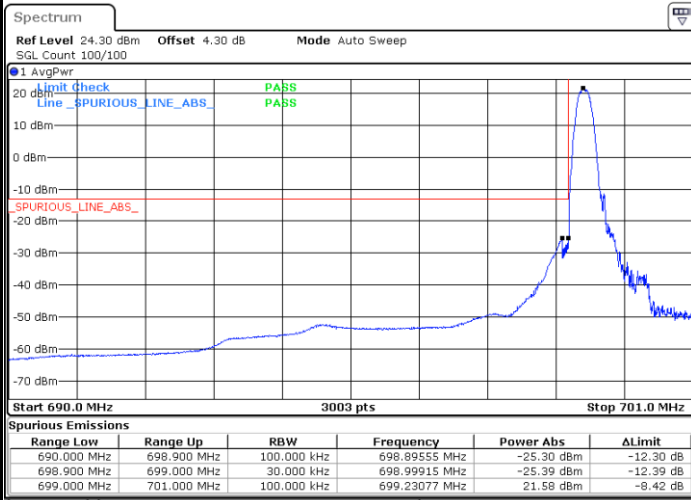

Date: 31.JAN.2024 22:33:16

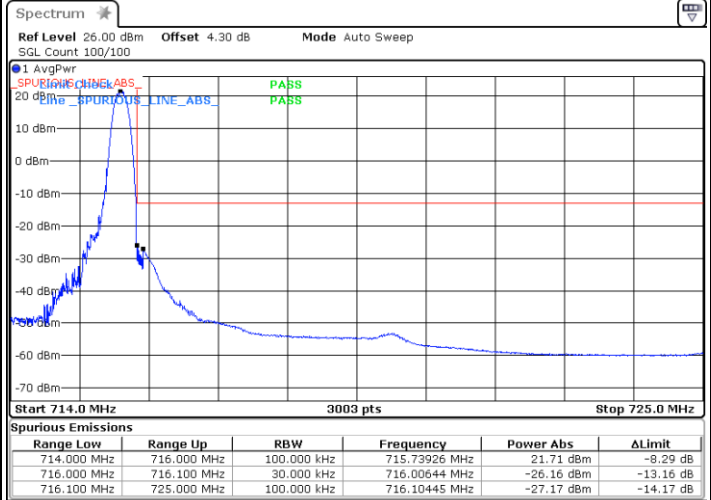

Date: 1.FEB.2024 01:21:43

Lowest Band Edge / Full RB

Highest Band Edge / Full RB

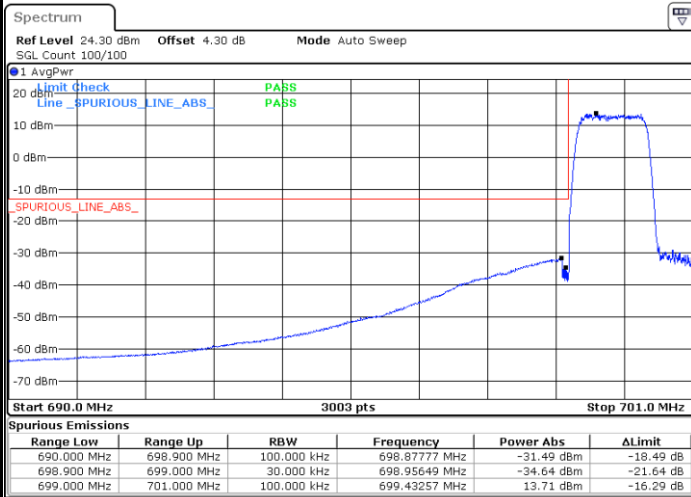

Date: 31.JAN.2024 22:15:28

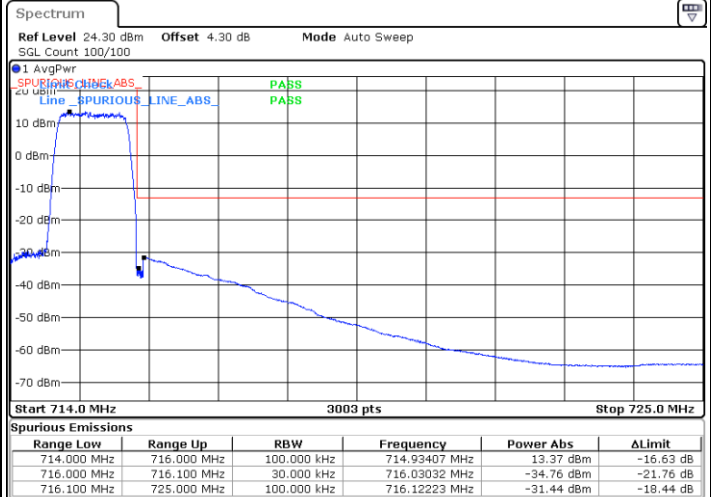

Date: 31.JAN.2024 22:38:38



LTE Band 12 / 1.4MHz / 64QAM

Lowest Band Edge / 1 RB

Highest Band Edge / 1 RB

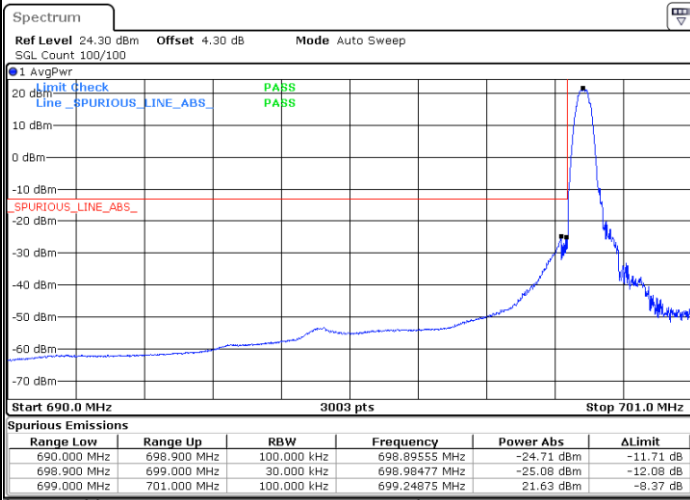

Date: 31.JAN.2024 22:08:48

Date: 31.JAN.2024 22:24:53

Lowest Band Edge / Full RB

Highest Band Edge / Full RB

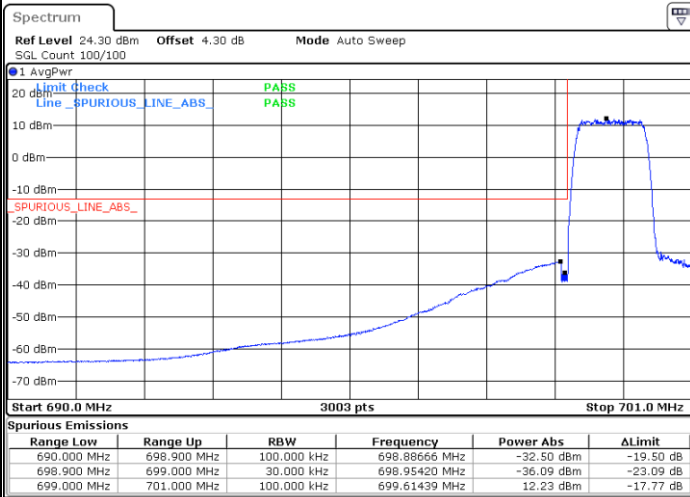

Date: 31.JAN.2024 22:14:08

Date: 31.JAN.2024 22:37:18



LTE Band 12 / 1.4MHz / 256QAM

Lowest Band Edge / 1 RB

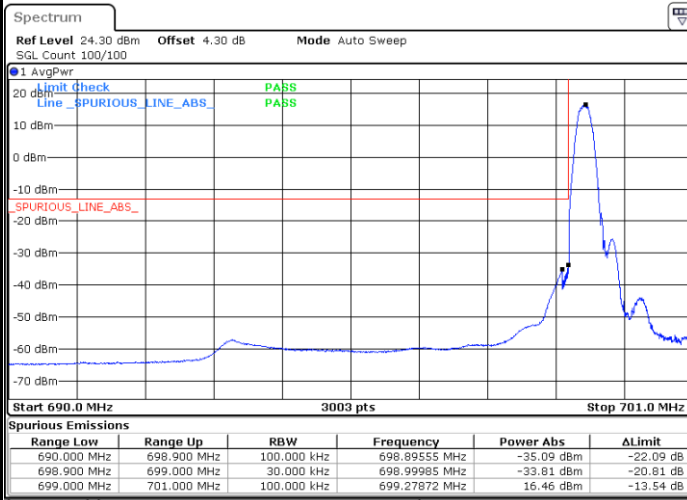

Date: 31.JAN.2024 22:10:11

Highest Band Edge / 1 RB

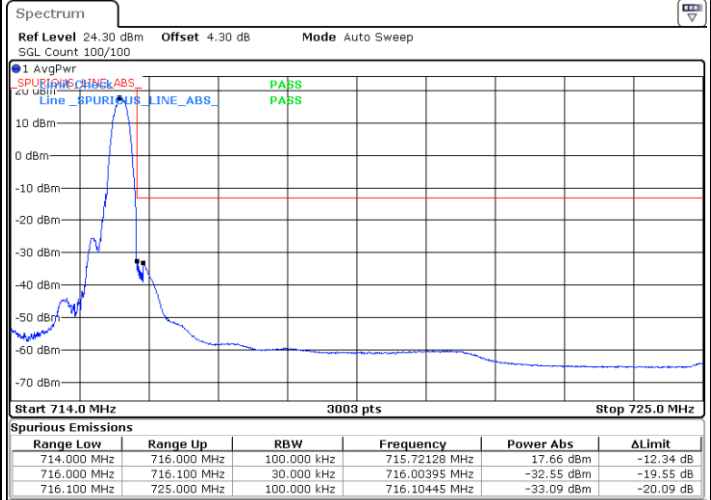

Date: 31.JAN.2024 22:26:13

Lowest Band Edge / Full RB

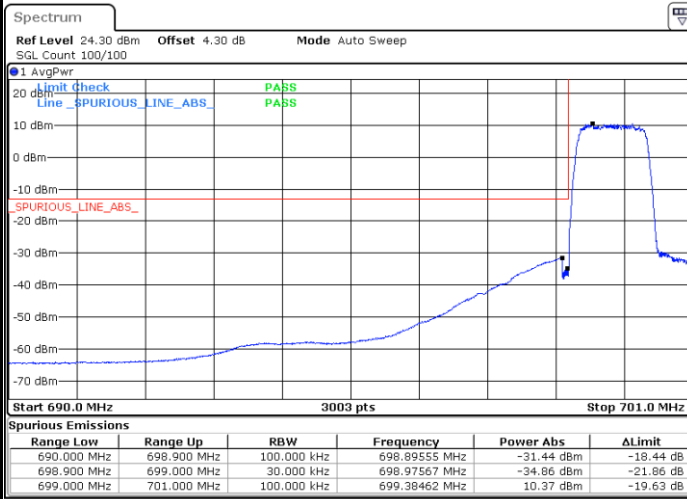

Date: 31.JAN.2024 22:12:48

Highest Band Edge / Full RB

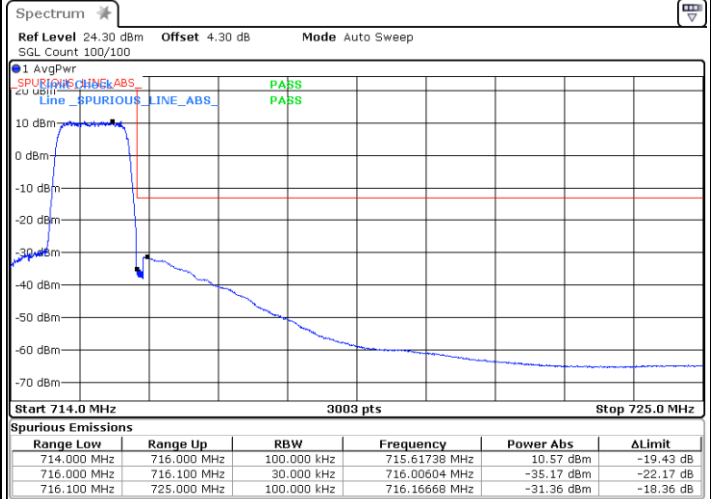

Date: 31.JAN.2024 22:35:54



LTE Band 12 / 3MHz / QPSK

Lowest Band Edge / 1RB

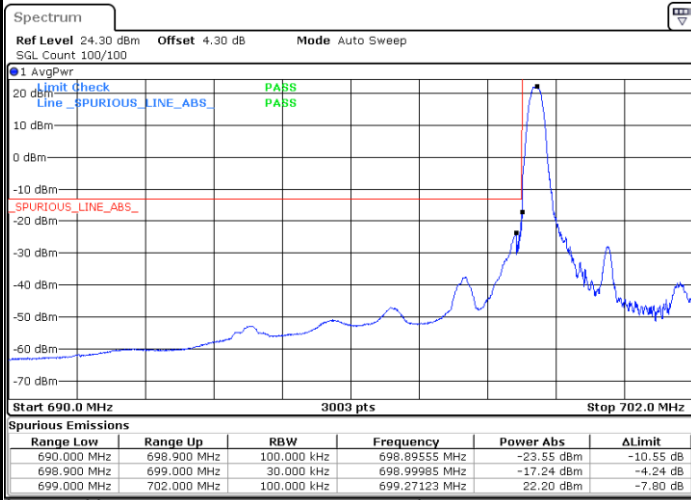

Date: 31.JAN.2024 22:43:22

Highest Band Edge / 1 RB

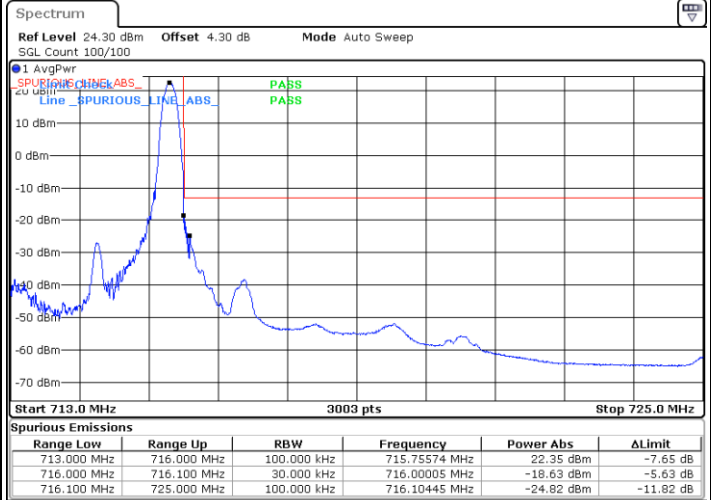

Date: 31.JAN.2024 23:04:28

Lowest Band Edge / Full RB

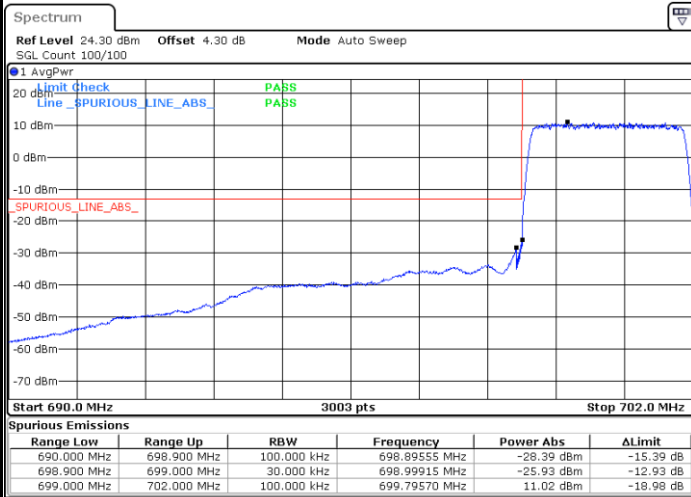

Date: 31.JAN.2024 22:59:04

Highest Band Edge / Full RB

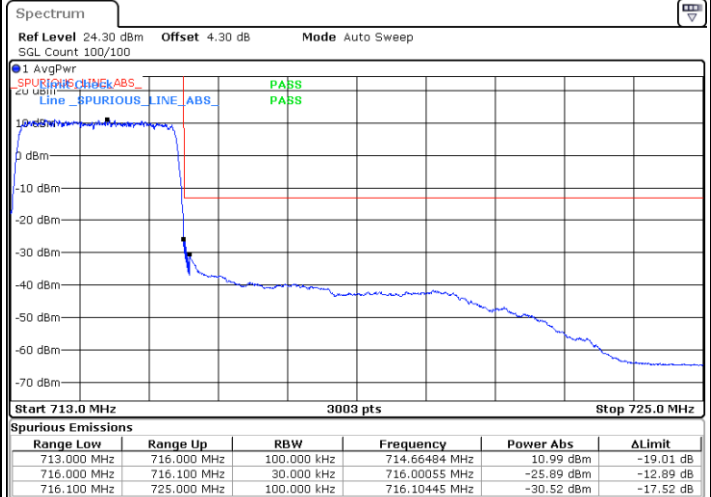

Date: 31.JAN.2024 23:18:17



LTE Band 12 / 3MHz / 16QAM

Lowest Band Edge / 1 RB

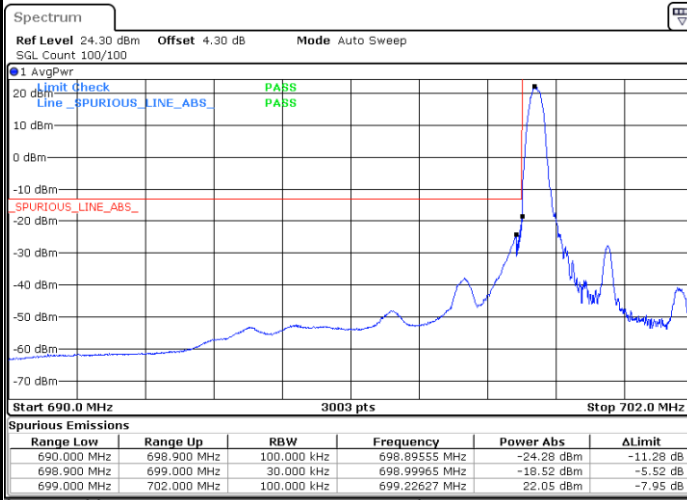

Date: 31.JAN.2024 22:44:43

Highest Band Edge / 1 RB

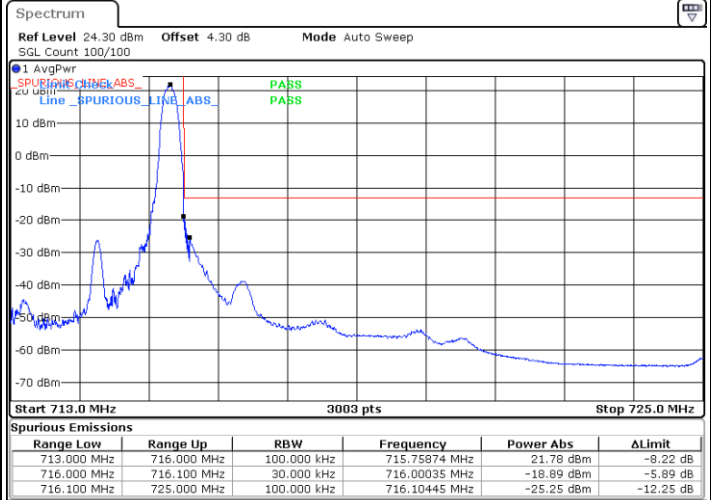

Date: 31.JAN.2024 23:05:48

Lowest Band Edge / Full RB

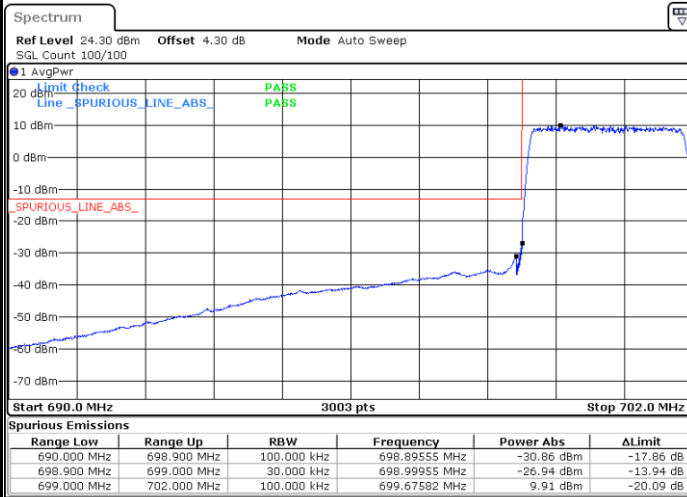

Date: 31.JAN.2024 22:57:43

Highest Band Edge / Full RB



Date: 31.JAN.2024 23:16:57



LTE Band 12 / 3MHz / 64QAM

Lowest Band Edge / 1 RB

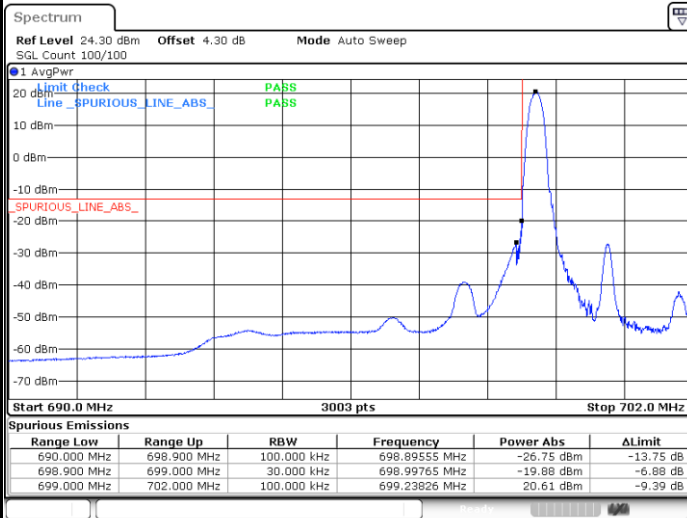

Date: 31.JAN.2024 22:46:03

Highest Band Edge / 1 RB

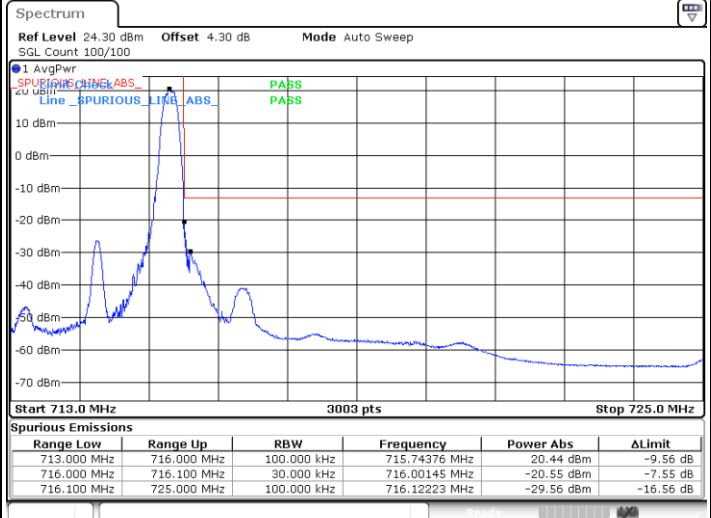

Date: 31.JAN.2024 23:07:09

Lowest Band Edge / Full RB

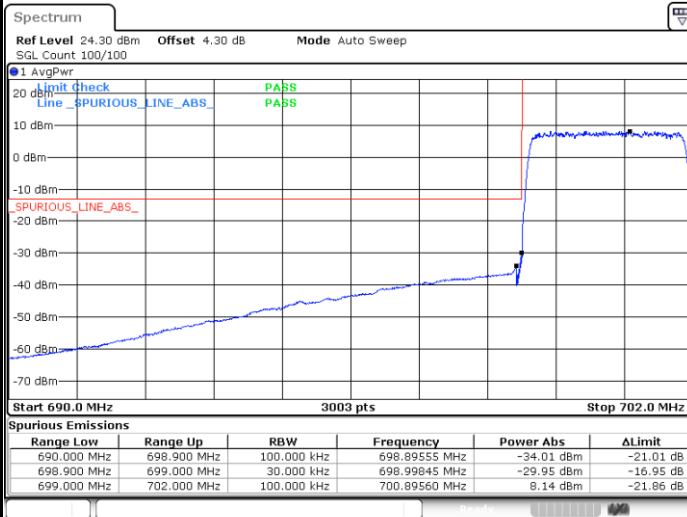

Date: 31.JAN.2024 22:56:23

Highest Band Edge / Full RB

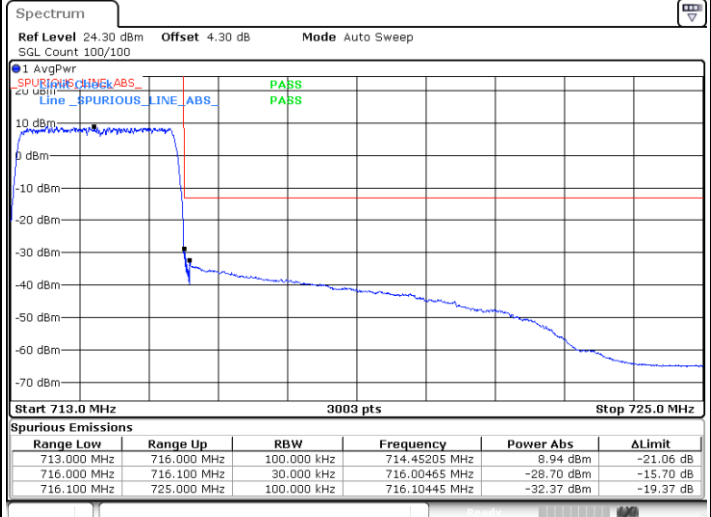

Date: 31.JAN.2024 23:15:36



LTE Band 12 / 3MHz / 256QAM

Lowest Band Edge / 1 RB

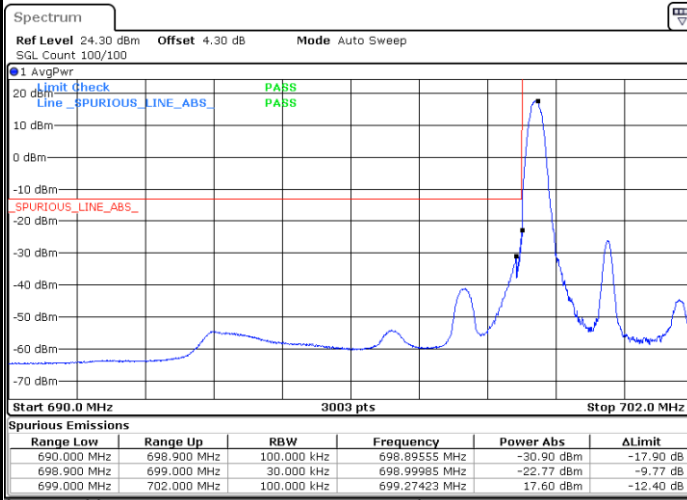

Date: 31.JAN.2024 22:47:24

Highest Band Edge / 1 RB

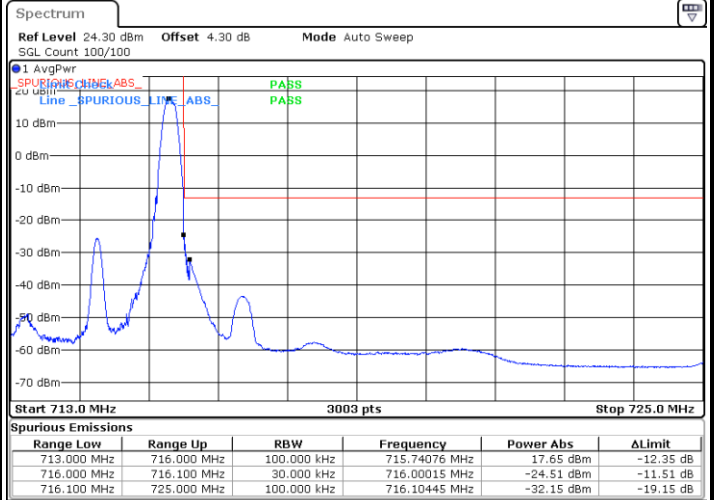

Date: 31.JAN.2024 23:08:29

Lowest Band Edge / Full RB

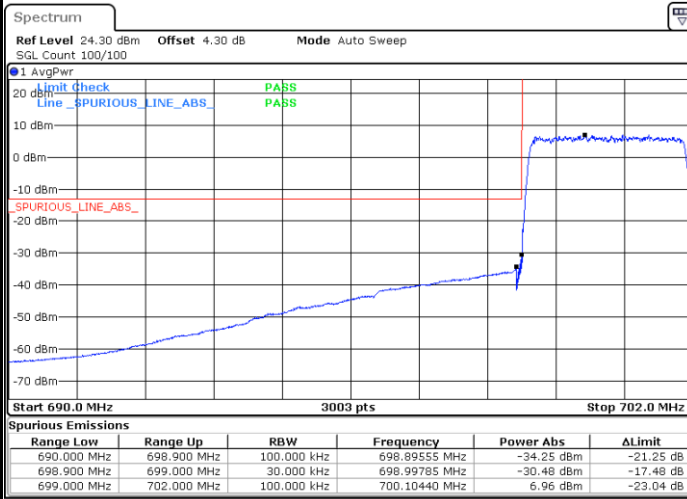

Date: 31.JAN.2024 22:53:59

Highest Band Edge / Full RB

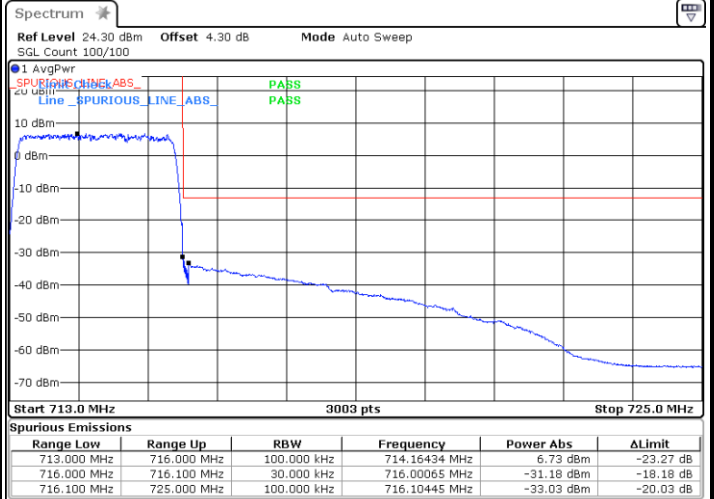

Date: 1.FEB.2024 01:27:28



LTE Band 12 / 5MHz / QPSK

Lowest Band Edge / 1 RB

Highest Band Edge / 1 RB

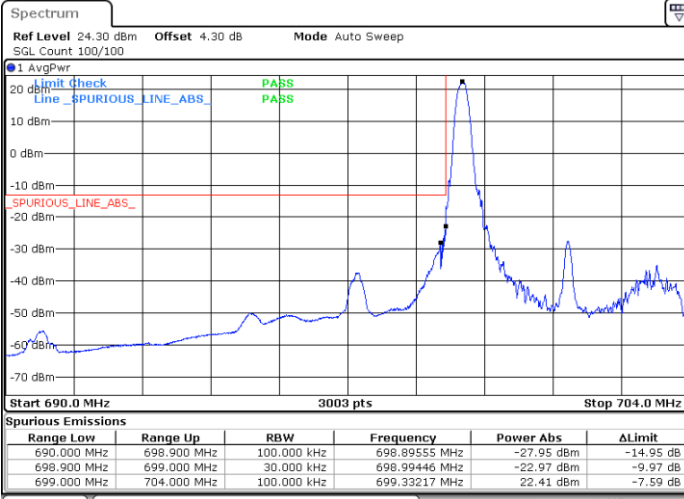

Date: 31.JAN.2024 23:21:40

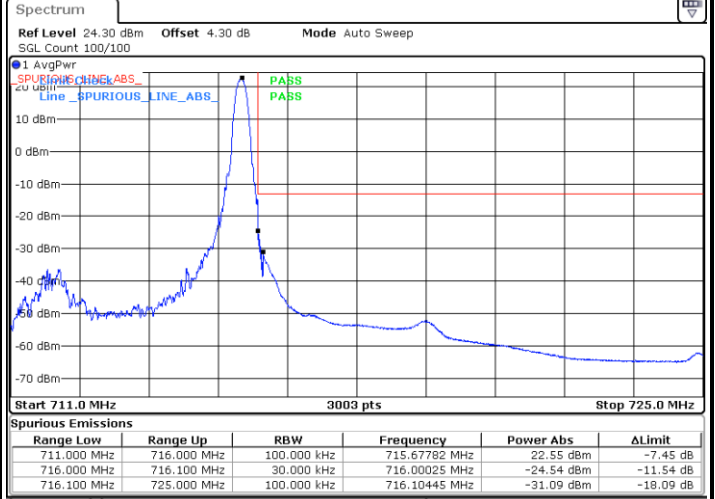

Date: 31.JAN.2024 23:36:32

Lowest Band Edge / Full RB

Highest Band Edge / Full RB

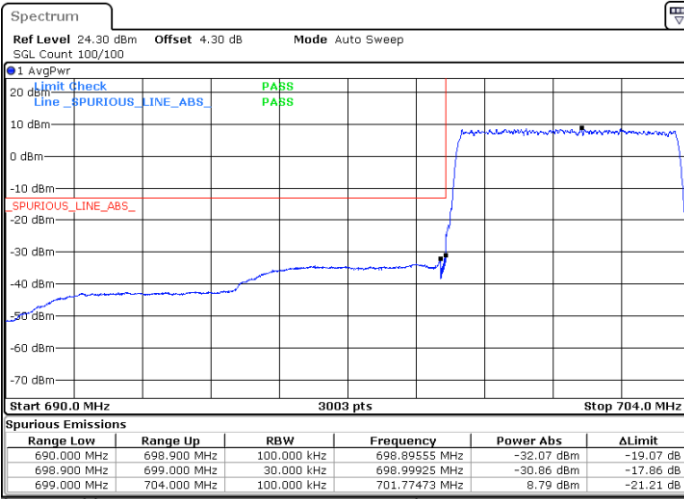

Date: 31.JAN.2024 23:31:08

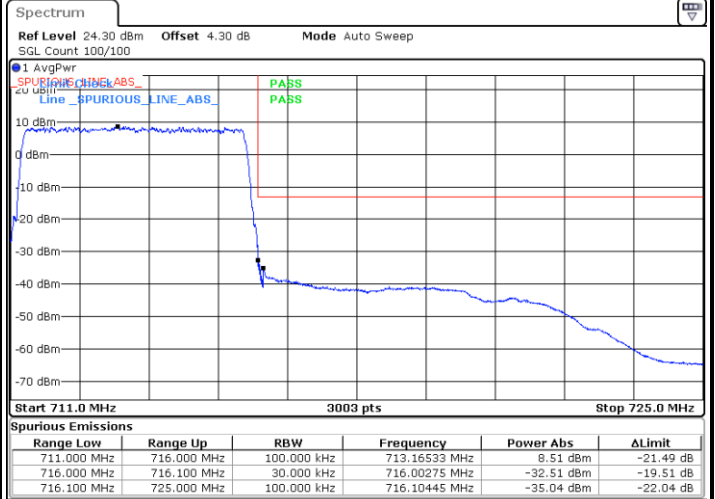

Date: 31.JAN.2024 23:45:10





LTE Band 12 / 5MHz / 16QAM

Lowest Band Edge / 1RB

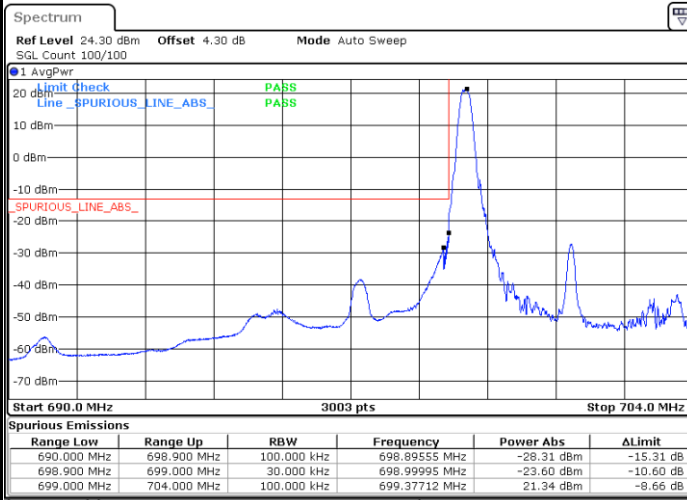

Date: 31.JAN.2024 23:23:00

Highest Band Edge / 1 RB

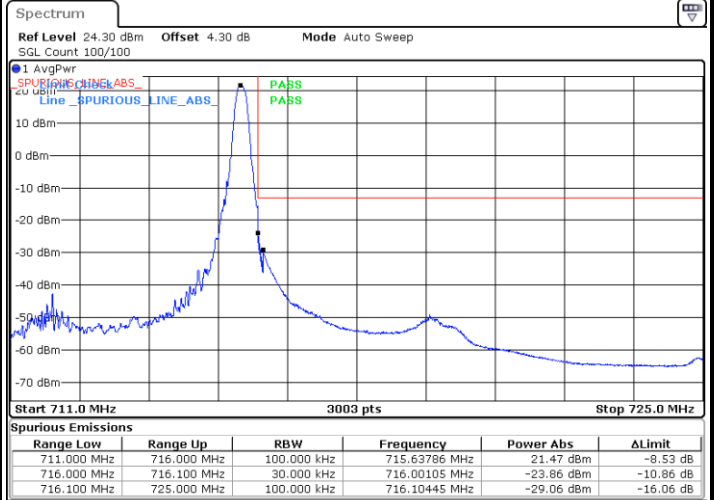

Date: 31.JAN.2024 23:37:52

Lowest Band Edge / Full RB

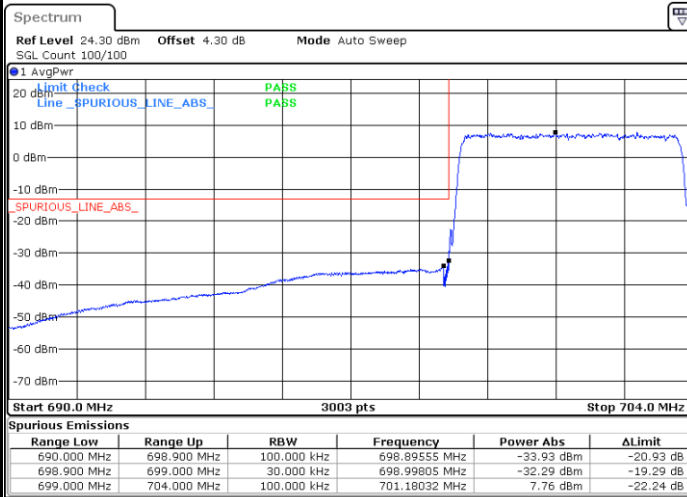

Date: 31.JAN.2024 23:29:48

Highest Band Edge / Full RB



Date: 31.JAN.2024 23:44:00



LTE Band 12 / 5MHz / 64QAM

Lowest Band Edge / 1RB

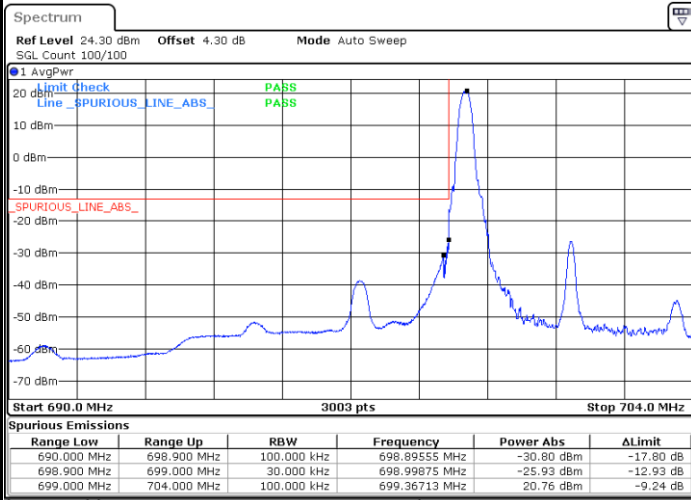

Date: 31.JAN.2024 23:24:21

Highest Band Edge / 1 RB

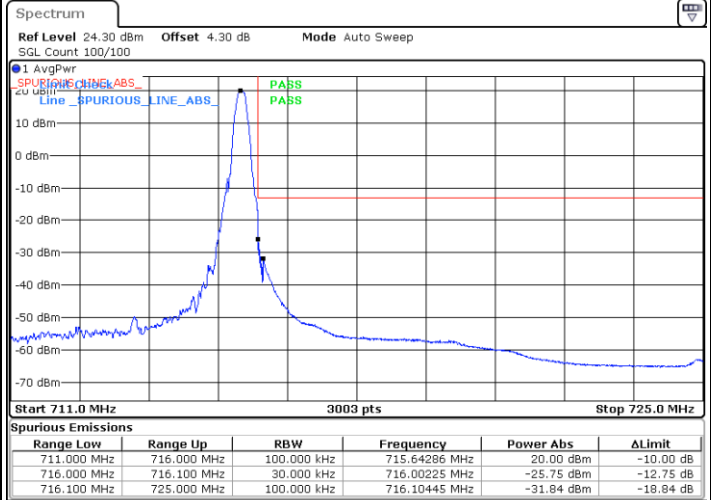

Date: 31.JAN.2024 23:39:13

Lowest Band Edge / Full RB

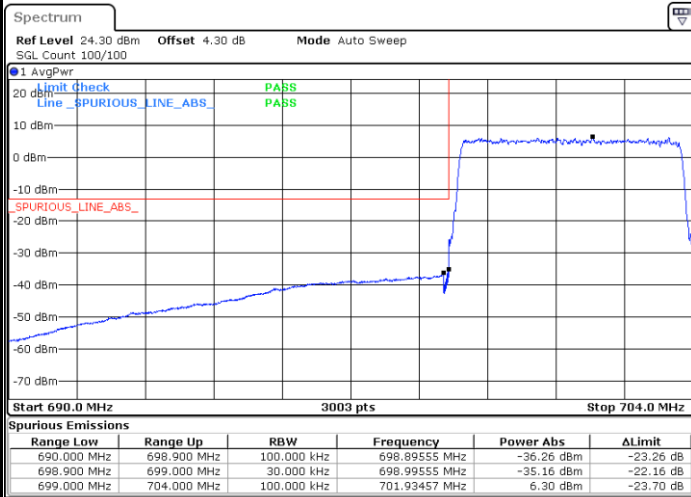

Date: 31.JAN.2024 23:28:27

Highest Band Edge / Full RB



Date: 31.JAN.2024 23:42:50



LTE Band 12 / 5MHz / 256QAM

Lowest Band Edge / 1RB

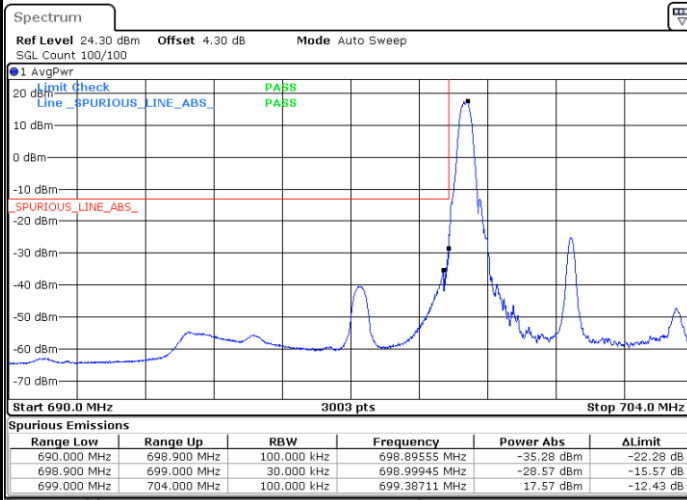

Date: 31.JAN.2024 23:25:41

Highest Band Edge / 1 RB

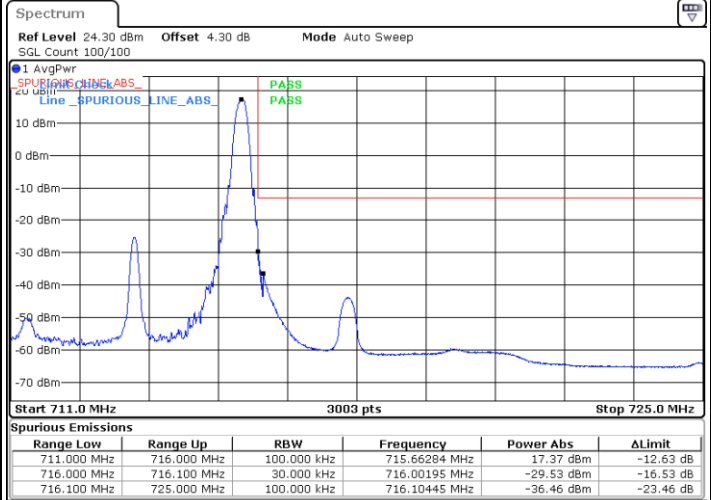

Date: 31.JAN.2024 23:40:23

Lowest Band Edge / Full RB

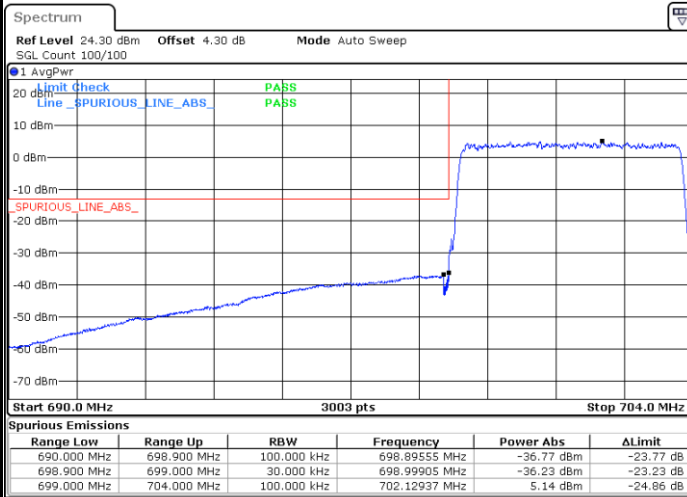

Date: 31.JAN.2024 23:27:04

Highest Band Edge / Full RB

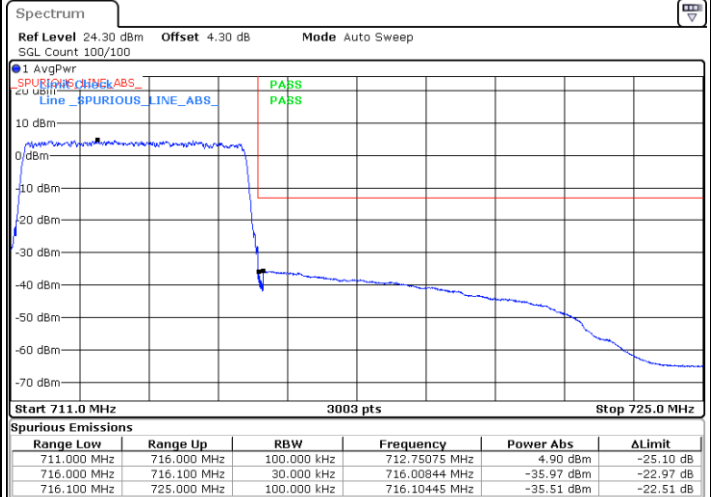

Date: 31.JAN.2024 23:41:36



LTE Band 12 / 10MHz / QPSK

Lowest Band Edge / 1 RB

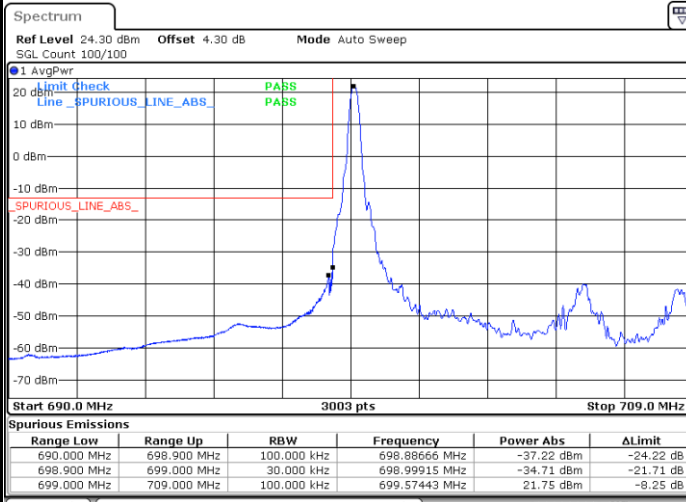

Date: 31.JAN.2024 23:48:23

Highest Band Edge / 1 RB

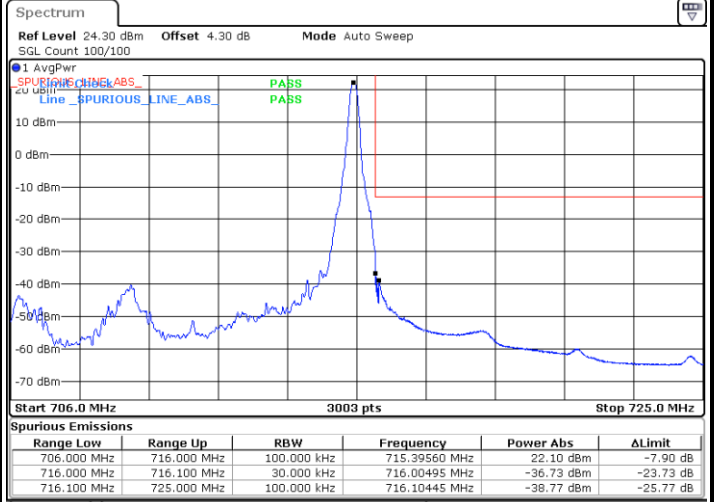

Date: 1.FEB.2024 00:53:38

Lowest Band Edge / Full RB

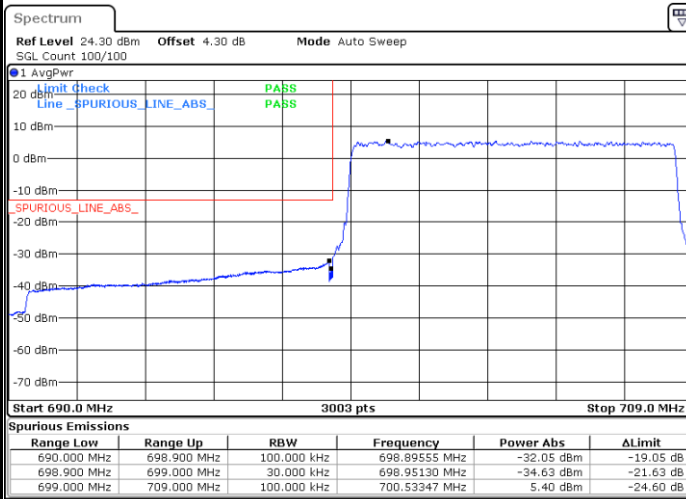

Date: 1.FEB.2024 00:48:24

Highest Band Edge / Full RB

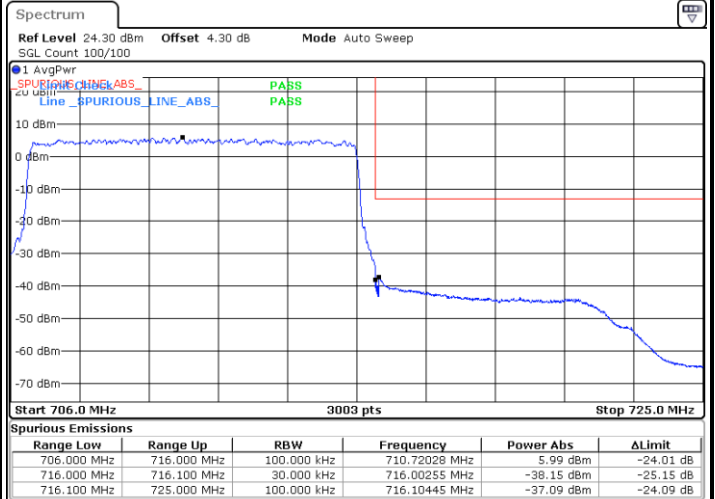

Date: 1.FEB.2024 01:01:55



LTE Band 12 / 10MHz / 16QAM

Lowest Band Edge / 1 RB

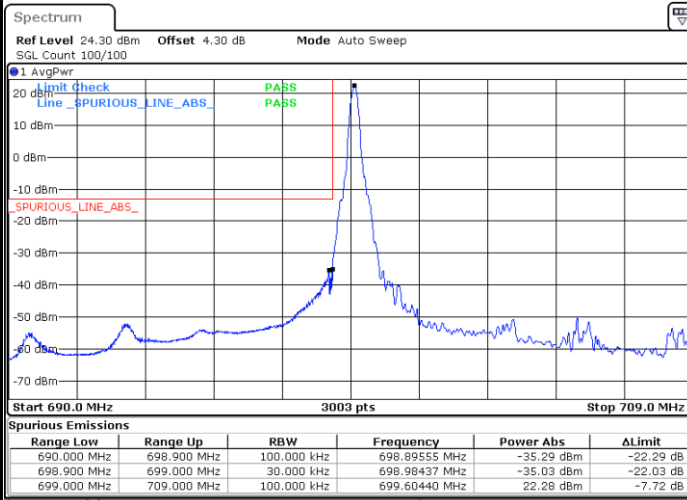

Date: 31.JAN.2024 23:49:34

Highest Band Edge / 1 RB

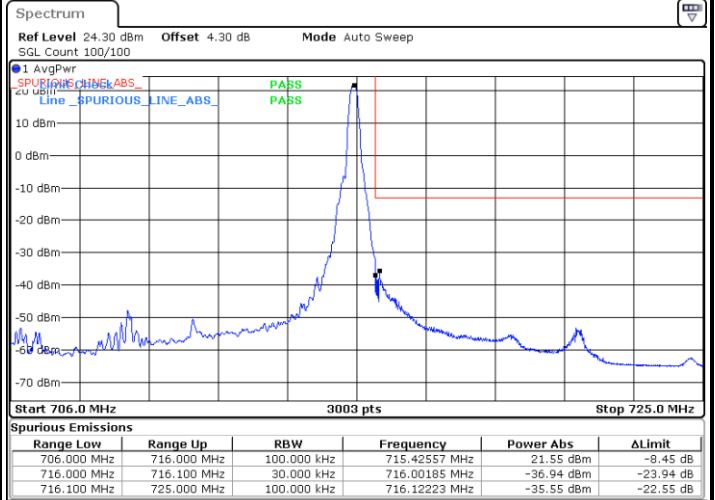

Date: 1.FEB.2024 00:54:49

Lowest Band Edge / Full RB

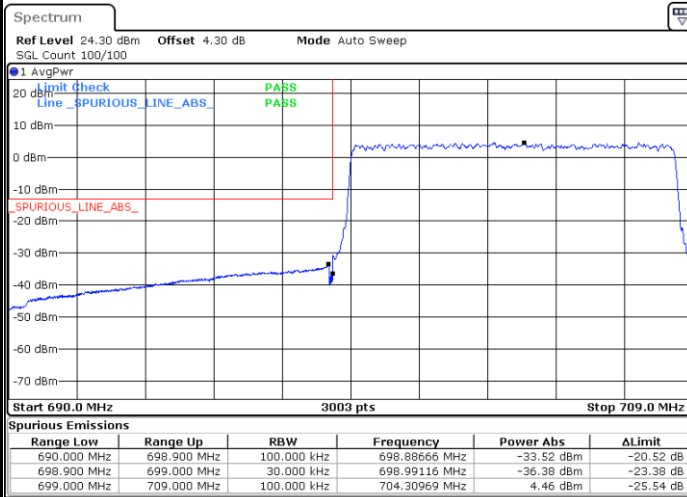

Date: 1.FEB.2024 00:47:14

Highest Band Edge / Full RB

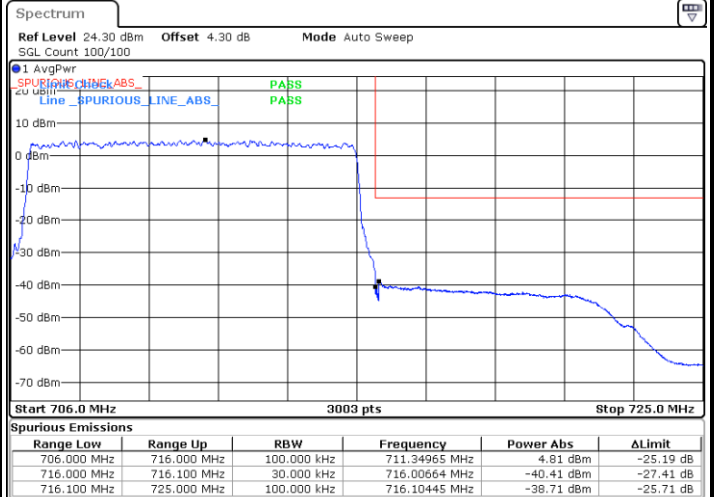

Date: 1.FEB.2024 01:00:45



LTE Band 12 / 10MHz / 64QAM

Lowest Band Edge / 1 RB

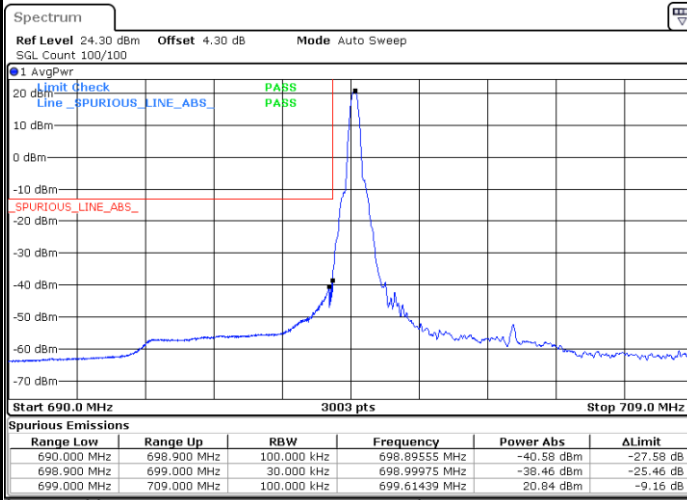

Date: 31.JAN.2024 23:50:44

Highest Band Edge / 1 RB

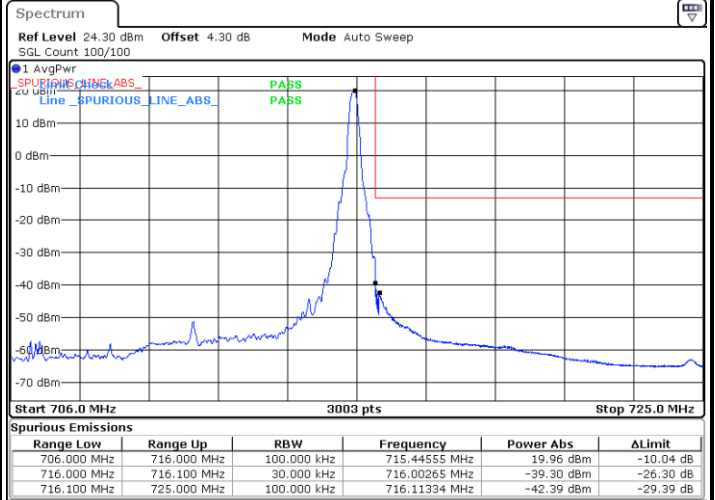

Date: 1.FEB.2024 00:55:59

Lowest Band Edge / Full RB

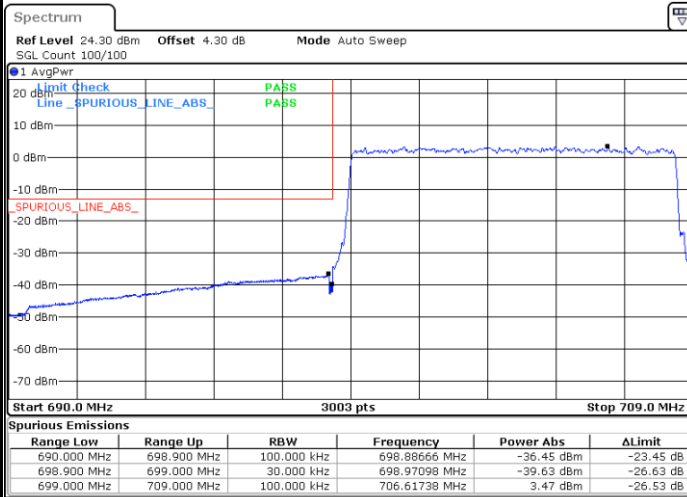

Date: 1.FEB.2024 00:46:04

Highest Band Edge / Full RB

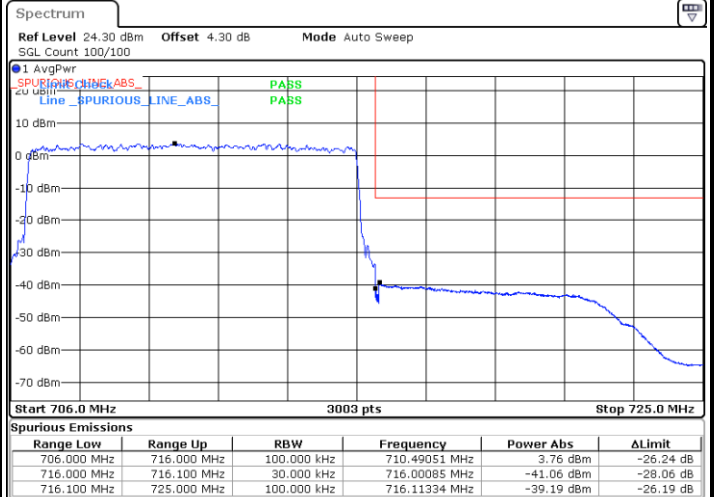

Date: 1.FEB.2024 00:59:35



LTE Band 12 / 10MHz / 256QAM

Lowest Band Edge / 1 RB

Highest Band Edge / 1 RB

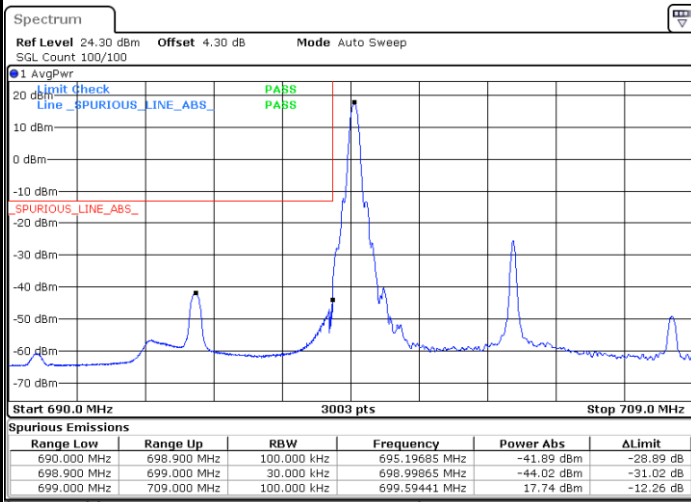

Date: 31.JAN.2024 23:51:55

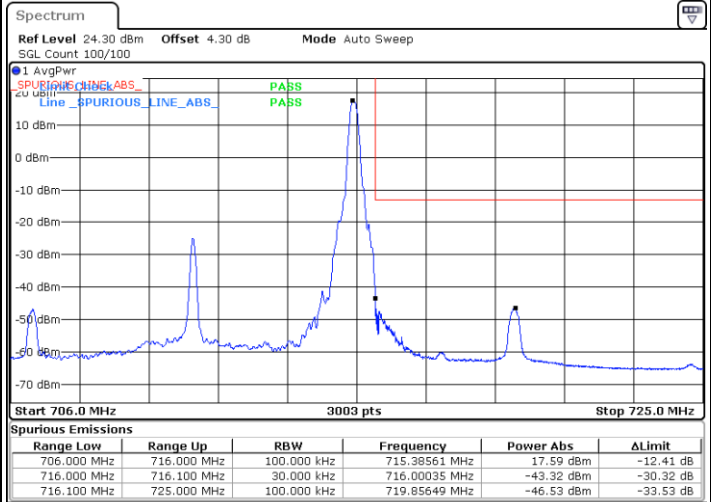

Date: 1.FEB.2024 00:57:09

Lowest Band Edge / Full RB

Highest Band Edge / Full RB

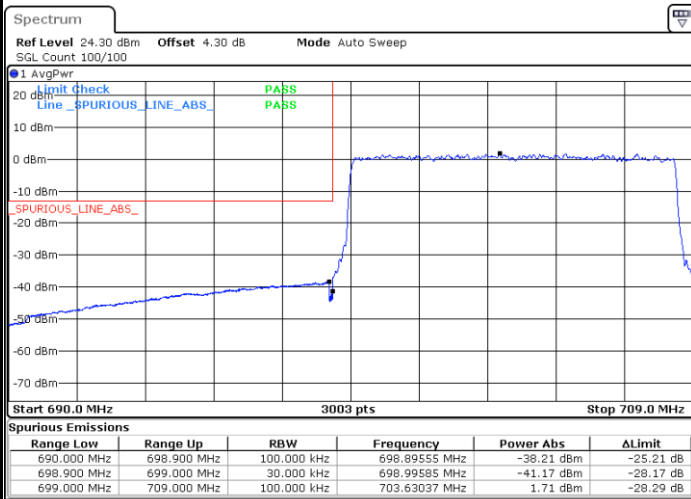

Date: 1.FEB.2024 01:32:40

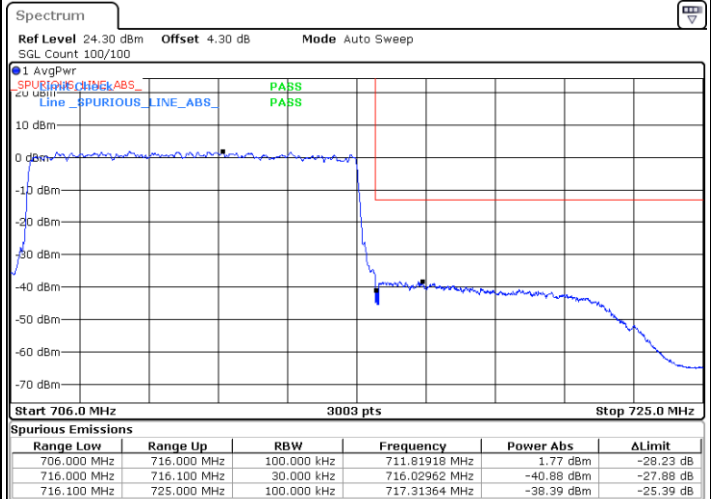

Date: 1.FEB.2024 00:58:22



# Conducted Spurious Emission

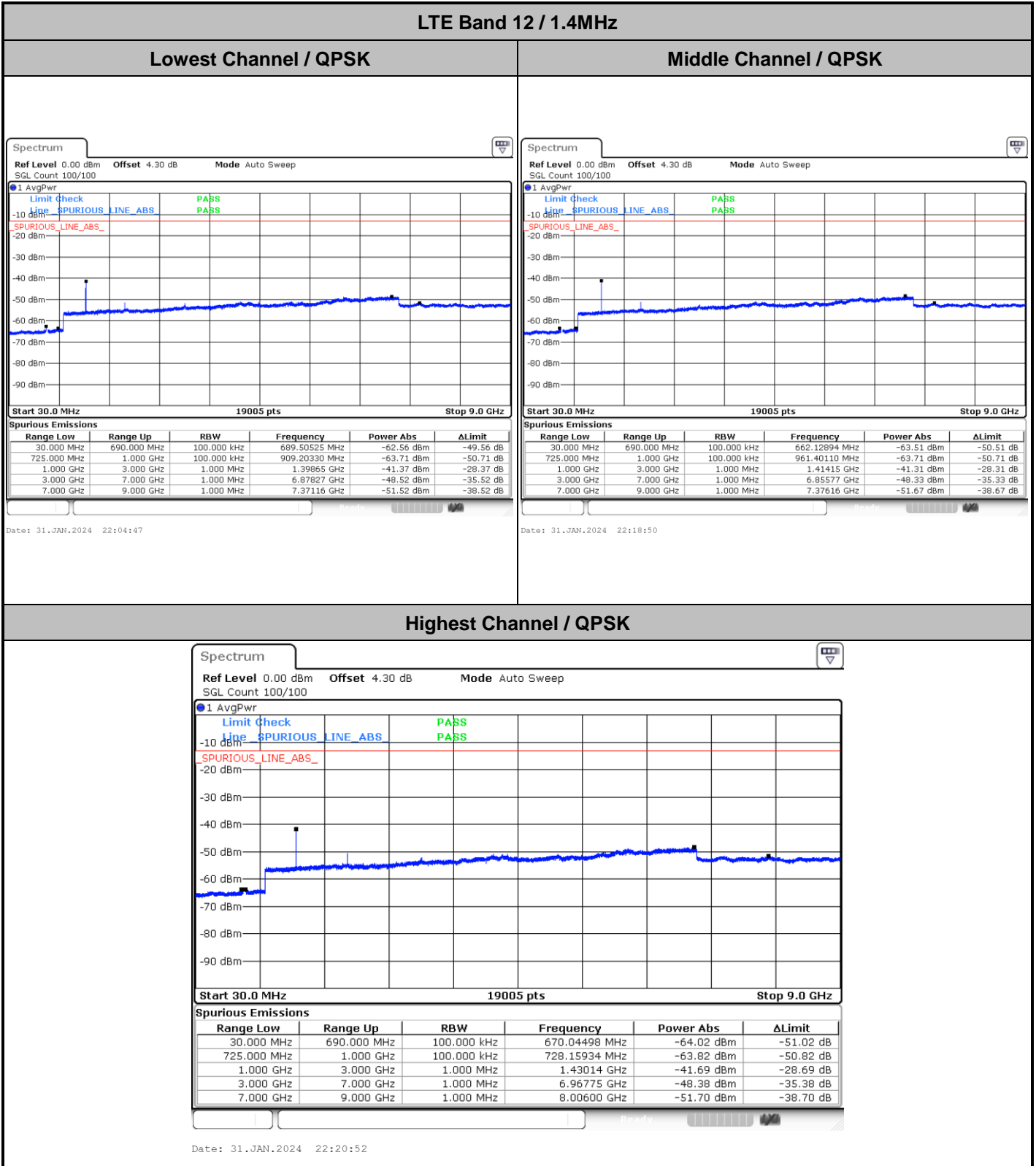





LTE Band 12 / 3MHz

Lowest Channel / QPSK

Middle Channel / QPSK

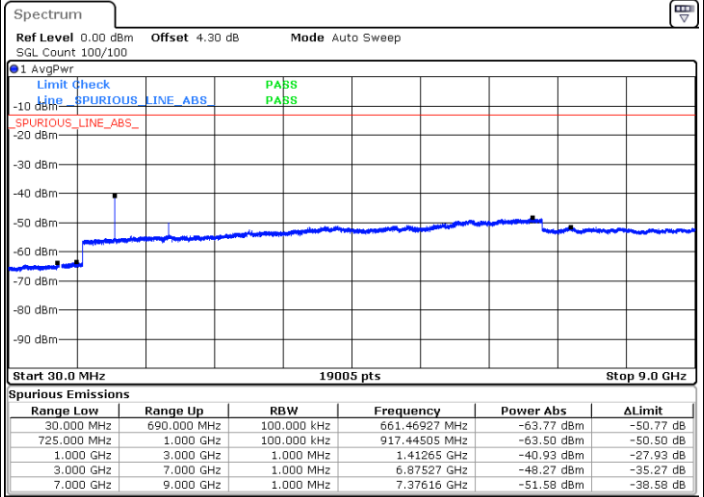
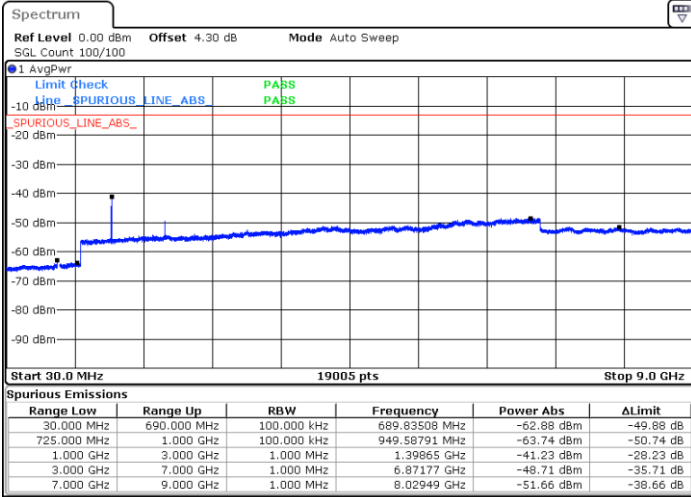

Date: 31.JAN.2024 22:42:02

Date: 31.JAN.2024 23:01:06

Highest Channel / QPSK

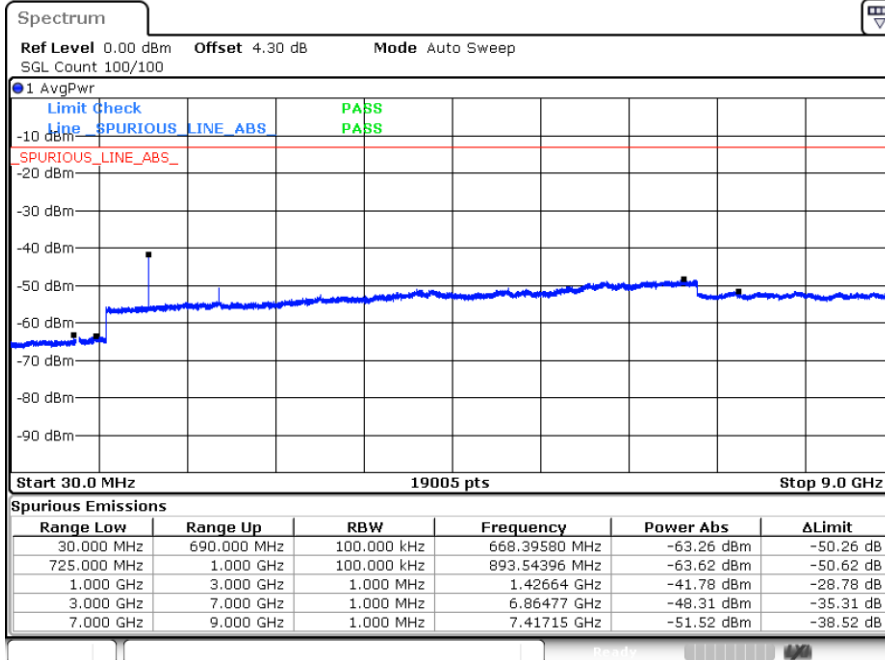

Date: 31.JAN.2024 23:03:07



LTE Band 12 / 5MHz

Lowest Channel / QPSK

Middle Channel / QPSK

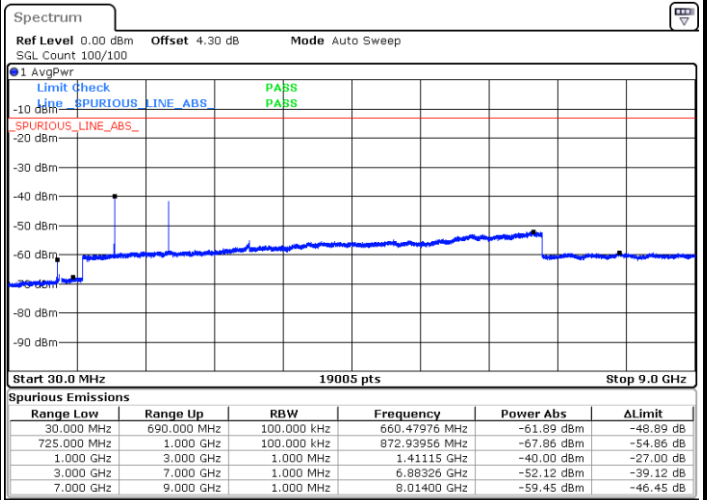
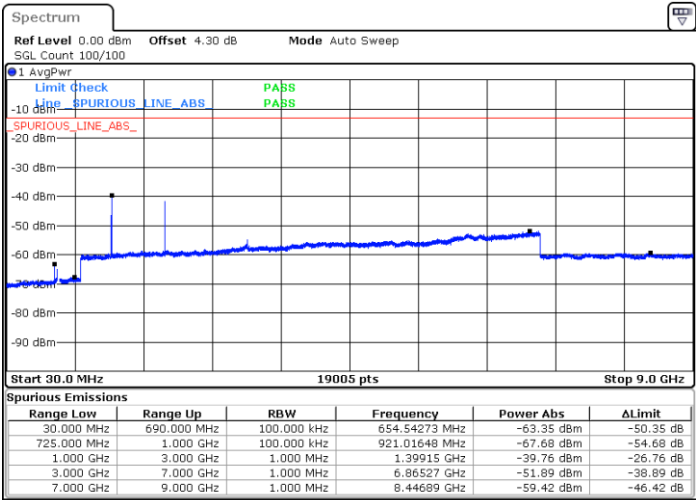

Date: 31.JAN.2024 23:20:20

Date: 31.JAN.2024 23:33:10

Highest Channel / QPSK

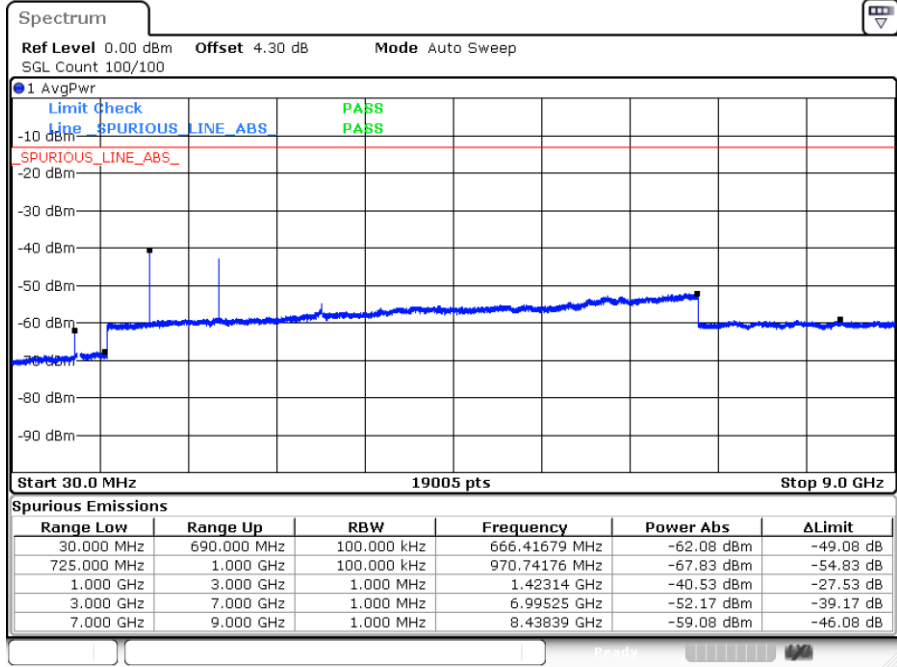

Date: 31.JAN.2024 23:35:12



LTE Band 12 / 10MHz

Lowest Channel / QPSK

Middle Channel / QPSK

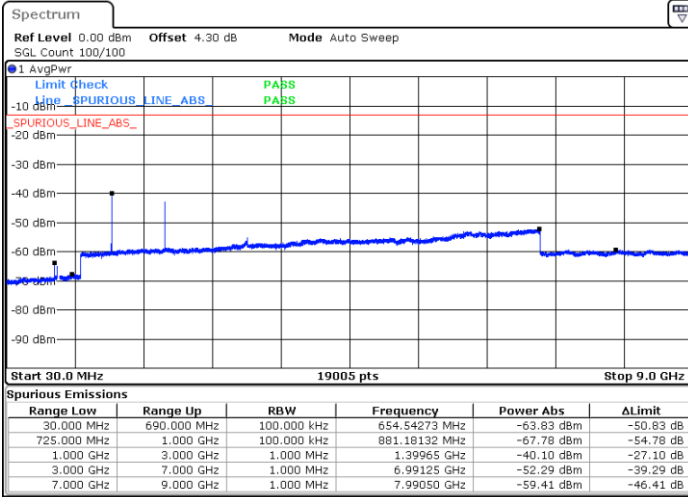

Date: 31.JAN.2024 23:47:13

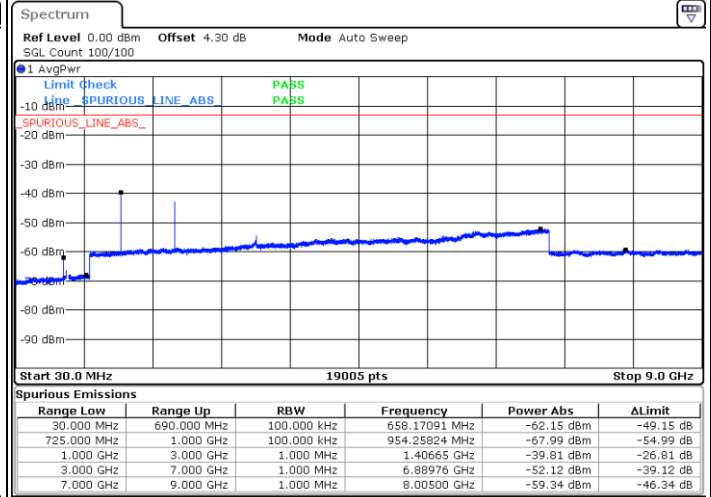

Date: 1.FEB.2024 00:50:26

Highest Channel / QPSK

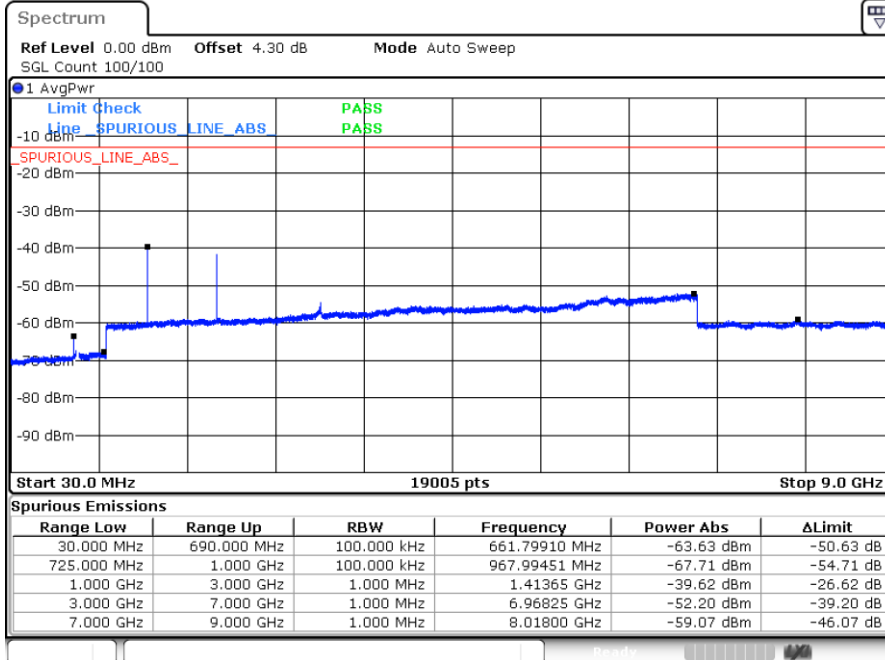

Date: 1.FEB.2024 00:52:28



### Frequency Stability

Test Conditions		LTE Band 12 (QPSK) / Middle Channel	Limit
Temperature (°C)	Voltage (Volt)	BW 10MHz	Note 2.
		Deviation (ppm)	Result
50	Normal Voltage	0.0032	PASS
40	Normal Voltage	0.0015	
30	Normal Voltage	0.0013	
20(Ref.)	Normal Voltage	0.0000	
10	Normal Voltage	0.0002	
0	Normal Voltage	0.0048	
-10	Normal Voltage	0.0026	
-20	Normal Voltage	0.0029	
-30	Normal Voltage	0.0053	
20	Maximum Voltage	0.0011	
20	Normal Voltage	0.0005	
20	Minimum Voltage	0.0017	

**Note:**

1. Normal Voltage =3.8 V. ; Minimum Voltage =3.3 V. ; Maximum Voltage =4.3 V.
2. Note: The frequency fundamental emissions stay within the authorized frequency block.