

Report No.: SEWA2303000041RG06

Rev.: 01

Page: 1 of 104

TEST REPORT

Application No: SEWA2303000041RG
Applicant: Quectel Wireless Solutions Co., Ltd.
Address of Applicant: Building 5, Shanghai Business Park Phase III (Area B), No.1016 Tianlin Road, Minhang District, Shanghai 200233, China
Manufacturer: Quectel Wireless Solutions Co., Ltd.
Address of Manufacturer: Building 5, Shanghai Business Park Phase III (Area B), No.1016 Tianlin Road, Minhang District, Shanghai 200233, China
EUT Description: Smart Module
Model No.: SG560D-WF
Trade Mark: Quectel
FCC ID: XMR2023SG560DWF
Standards: FCC 47 CFR Part 2, Subpart J
 FCC 47 CFR Part 15, Subpart E
Date of Receipt: 2023/04/06
Date of Test: 2023/04/10 to 2023/05/24
Date of Issue: 2023/05/24

| | |
|----------------------|---------------|
| Test Result : | PASS * |
|----------------------|---------------|

* In the configuration tested, the EUT detailed in this report complied with the standards specified above.

Authorized Signature:

Panta Sun
Wireless Laboratory Manager



Unless otherwise agreed in writing, this document is issued by the Company subject to its General Conditions of Service printed overleaf, available on request or accessible at <http://www.sgs.com/en/Terms-and-Conditions.aspx> and, for electronic format documents, subject to Terms and Conditions for Electronic Documents at <http://www.sgs.com/en/Terms-and-Conditions/Terms-e-Documents.aspx>. Attention is drawn to the limitation of liability, indemnification and jurisdiction issues defined therein. Any holder of this document is advised that information contained hereon reflects the Company's findings at the time of its intervention only and within the limits of Client's instructions, if any. The Company's sole responsibility is to its Client and this document does not exonerate parties to a transaction from exercising all their rights and obligations under the transaction documents. This document cannot be reproduced except in full, without prior written approval of the Company. Any unauthorized alteration, forgery or falsification of the content or appearance of this document is unlawful and offenders may be prosecuted to the fullest extent of the law. Unless otherwise stated the results shown in this test report refer only to the sample(s) tested and such sample(s) are retained for 30 days only.
 Attention: To check the authenticity of testing /inspection report & certificate, please contact us at telephone: (86-755) 8307 1443, or email: QN.Doccheck@sgs.com

South of No. 6 Plant, No. 1, Runsheng Road, Suzhou Industrial Park, Suzhou Area, China (Jiangsu) Pilot Free Trade Zone 215000 t (86-512) 62992980 www.sgs.com.cn
 中国·苏州·中国(江苏)自由贸易试验区苏州片区苏州工业园区润胜路1号的6号厂房南楼 邮编: 215000 t (86-512) 62992980 sgs.china@sgs.com

1 Version

| Revision Record | | | | |
|-----------------|---------|------------|----------|----------|
| Version | Chapter | Date | Modifier | Remark |
| 01 | | 2023/05/24 | | Original |

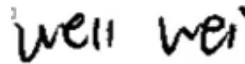
| | | |
|--------------------|--|--|
| Prepared By | |  <hr/> (Ives Cheng) / Test Engineer |
| Checked By | |  <hr/> (Well Wei) / Reviewer |



Unless otherwise agreed in writing, this document is issued by the Company subject to its General Conditions of Service printed overleaf, available on request or accessible at <http://www.sgs.com/en/Terms-and-Conditions.aspx> and, for electronic format documents, subject to Terms and Conditions for Electronic Documents at <http://www.sgs.com/en/Terms-and-Conditions/Terms-e-Document.aspx>. Attention is drawn to the limitation of liability, indemnification and jurisdiction issues defined therein. Any holder of this document is advised that information contained hereon reflects the Company's findings at the time of its intervention only and within the limits of Client's instructions, if any. The Company's sole responsibility is to its Client and this document does not exonerate parties to a transaction from exercising all their rights and obligations under the transaction documents. This document cannot be reproduced except in full, without prior written approval of the Company. Any unauthorized alteration, forgery or falsification of the content or appearance of this document is unlawful and offenders may be prosecuted to the fullest extent of the law. Unless otherwise stated the results shown in this test report refer only to the sample(s) tested and such sample(s) are retained for 30 days only.

Attention: To check the authenticity of testing / inspection report & certificate, please contact us at telephone: (86-755) 8307 1443, or email: QN.Doccheck@sgs.com

South of No. 6 Plant, No. 1, Runsheng Road, Suzhou Industrial Park, Suzhou Area, China (Jiangsu) Pilot Free Trade Zone 215000 t (86-512) 62992980 www.sgs.com.cn
 中国·苏州·中国(江苏)自由贸易试验区苏州片区苏州工业园区润胜路1号的6号厂房南楼 邮编: 215000 t (86-512) 62992980 sgs.china@sgs.com

2 Test Summary

| Test Item | Band ^[1] | FCC rules No. | Test Requirements | Test Result | Result | | | | | | | | | | | | | | | | | | | | | | |
|---|--|---------------|---|------------------------|-------------------------------|----------------------|---------|--|---------|--|---------|-----------|-------|----------------------|--------------------|---------------------------------|------------|-------------------|------------|-----------------------------------|------------|---------------------------|--|---------------------------|---|------------|------|
| Dynamic Frequency Selection | Band II-A Band II-C | 15.407 | <p>DFS Detection Thresholds:</p> <table border="1"> <thead> <tr> <th>Maximum Transmit Power</th> <th>Value (See Notes 1, 2, and 3)</th> </tr> </thead> <tbody> <tr> <td>EIRP ≥ 200 milliwatt</td> <td>-64 dBm</td> </tr> <tr> <td>EIRP < 200 milliwatt and power spectral density < 10 dBm/MHz</td> <td>-62 dBm</td> </tr> <tr> <td>EIRP < 200 milliwatt that do not meet the power spectral density requirement</td> <td>-64 dBm</td> </tr> </tbody> </table> <p>Note 1: This is the level at the input of the receiver assuming a 0 dBi receive antenna. Note 2: Throughout these test procedures an additional 1 dB has been added to the amplitude of the test transmission waveforms to account for variations in measurement equipment. This will ensure that the test signal is at or above the detection threshold level to trigger a DFS response. Note 3: EIRP is based on the highest antenna gain. For MIMO devices refer to KDB Publication 662911 D01.</p> <p>DFS Response Requirement:</p> <table border="1"> <thead> <tr> <th>Parameter</th> <th>Value</th> </tr> </thead> <tbody> <tr> <td>Non-occupancy period</td> <td>Minimum 30 minutes</td> </tr> <tr> <td>Channel Availability Check Time</td> <td>60 seconds</td> </tr> <tr> <td>Channel Move Time</td> <td>10 seconds</td> </tr> <tr> <td>Channel Closing Transmission Time</td> <td>See Note 1</td> </tr> <tr> <td>U-NII Detection Bandwidth</td> <td>200 milliseconds + an aggregate of 60 milliseconds over remaining 10 second period. See Notes 1 and 2.</td> </tr> <tr> <td>U-NII Detection Bandwidth</td> <td>Minimum 100% of the U-NII 99% transmission power bandwidth. See Note 3.</td> </tr> </tbody> </table> <p>Note 1: Channel Move Time and the Channel Closing Transmission Time should be performed with Radar Type 0. The measurement tuning begins at the end of the Radar Type 0 burst. Note 2: The Channel Closing Transmission Time is comprised of 200 milliseconds starting at the beginning of the Channel Move Time plus any additional intermittent control signals required to facilitate a Channel move (an aggregate of 60 milliseconds) during the remainder of the 10 second period. The aggregate duration of control signals will not count quiet periods in between transmissions. Note 3: During the U-NII Detection Bandwidth detection test, radar type 0 should be used. For each frequency step the minimum percentage of detection is 90 percent. Measurements are performed with no data traffic.</p> | Maximum Transmit Power | Value (See Notes 1, 2, and 3) | EIRP ≥ 200 milliwatt | -64 dBm | EIRP < 200 milliwatt and power spectral density < 10 dBm/MHz | -62 dBm | EIRP < 200 milliwatt that do not meet the power spectral density requirement | -64 dBm | Parameter | Value | Non-occupancy period | Minimum 30 minutes | Channel Availability Check Time | 60 seconds | Channel Move Time | 10 seconds | Channel Closing Transmission Time | See Note 1 | U-NII Detection Bandwidth | 200 milliseconds + an aggregate of 60 milliseconds over remaining 10 second period. See Notes 1 and 2. | U-NII Detection Bandwidth | Minimum 100% of the U-NII 99% transmission power bandwidth. See Note 3. | Clause 4.1 | PASS |
| Maximum Transmit Power | Value (See Notes 1, 2, and 3) | | | | | | | | | | | | | | | | | | | | | | | | | | |
| EIRP ≥ 200 milliwatt | -64 dBm | | | | | | | | | | | | | | | | | | | | | | | | | | |
| EIRP < 200 milliwatt and power spectral density < 10 dBm/MHz | -62 dBm | | | | | | | | | | | | | | | | | | | | | | | | | | |
| EIRP < 200 milliwatt that do not meet the power spectral density requirement | -64 dBm | | | | | | | | | | | | | | | | | | | | | | | | | | |
| Parameter | Value | | | | | | | | | | | | | | | | | | | | | | | | | | |
| Non-occupancy period | Minimum 30 minutes | | | | | | | | | | | | | | | | | | | | | | | | | | |
| Channel Availability Check Time | 60 seconds | | | | | | | | | | | | | | | | | | | | | | | | | | |
| Channel Move Time | 10 seconds | | | | | | | | | | | | | | | | | | | | | | | | | | |
| Channel Closing Transmission Time | See Note 1 | | | | | | | | | | | | | | | | | | | | | | | | | | |
| U-NII Detection Bandwidth | 200 milliseconds + an aggregate of 60 milliseconds over remaining 10 second period. See Notes 1 and 2. | | | | | | | | | | | | | | | | | | | | | | | | | | |
| U-NII Detection Bandwidth | Minimum 100% of the U-NII 99% transmission power bandwidth. See Note 3. | | | | | | | | | | | | | | | | | | | | | | | | | | |
| <p>Note 1: Band II-A: 5250-5350MHz Band II-C: 5470-5725MHz</p> | | | | | | | | | | | | | | | | | | | | | | | | | | | |



Unless otherwise agreed in writing, this document is issued by the Company subject to its General Conditions of Service printed overleaf, available on request or accessible at <http://www.sgs.com/en/Terms-and-Conditions.aspx> and, for electronic format documents, subject to Terms and Conditions for Electronic Documents at <http://www.sgs.com/en/Terms-and-Conditions/Terms-e-Documents.aspx>. Attention is drawn to the limitation of liability, indemnification and jurisdiction issues defined therein. Any holder of this document is advised that information contained hereon reflects the Company's findings at the time of its intervention only and within the limits of Client's instructions, if any. The Company's sole responsibility is to its Client and this document does not exonerate parties to a transaction from exercising all their rights and obligations under the transaction documents. This document cannot be reproduced except in full, without prior written approval of the Company. Any unauthorized alteration, forgery or falsification of the content or appearance of this document is unlawful and offenders may be prosecuted to the fullest extent of the law. Unless otherwise stated the results shown in this test report refer only to the sample(s) tested and such sample(s) are retained for 30 days only.

Attention: To check the authenticity of testing / inspection report & certificate, please contact us at telephone: (86-755) 8307 1443, or email: QN.Doccheck@sgs.com

Contents

| | | |
|--------|---|----|
| 1 | Version | 2 |
| 2 | Test Summary | 3 |
| 3 | General Information | 5 |
| 3.1 | Details of Client | 5 |
| 3.2 | Test Location | 5 |
| 3.3 | Test Facility | 5 |
| 3.4 | General Description of EUT | 6 |
| 3.5 | Test Environment and Mode | 8 |
| 3.6 | Description of Support Units | 8 |
| 3.7 | Worst-case configuration and mode | 8 |
| 4 | Test results and Measurement Data | 9 |
| 4.1 | Dynamic Frequency Selection | 9 |
| 4.1.1 | DFS Measurement Configuration | 9 |
| 4.1.2 | DFS Threshold level | 9 |
| 4.1.3 | Power-on cycle | 9 |
| 4.1.4 | User Access Restrctions | 9 |
| 4.1.5 | Channel Loading/Data Streaming | 9 |
| 4.1.6 | Conducted Setup of Calibration of DFS Detection Threshold Level | 10 |
| 4.1.7 | Test Setup | 10 |
| 4.1.8 | Test Procedures | 11 |
| 4.1.9 | Applicability of DFS Requirements Prior to Use of a Channel | 18 |
| 4.1.10 | Applicability of DFS Requirements During Normal Operation | 18 |
| 4.1.11 | DFS Detection Thresholds | 19 |
| 4.1.12 | Response Requirements | 19 |
| 4.1.13 | Short Pulse Radar Test Waveforms | 20 |
| 4.1.14 | Long Pulse Radar Test Waveform | 22 |
| 4.1.15 | Frequency Hopping Radar Test Waveform | 22 |
| 5 | Measurement Uncertainty (95% confidence levels, k=2) | 23 |
| 6 | Equipment List | 24 |
| 7 | Photographs - Setup Photos | 25 |



Unless otherwise agreed in writing, this document is issued by the Company subject to its General Conditions of Service printed overleaf, available on request or accessible at <http://www.sgs.com/en/Terms-and-Conditions.aspx> and, for electronic format documents, subject to Terms and Conditions for Electronic Documents at <http://www.sgs.com/en/Terms-and-Conditions/Terms-e-Document.aspx>. Attention is drawn to the limitation of liability, indemnification and jurisdiction issues defined therein. Any holder of this document is advised that information contained herein reflects the Company's findings at the time of its intervention only and within the limits of Client's instructions, if any. The Company's sole responsibility is to its Client and this document does not exonerate parties to a transaction from exercising all their rights and obligations under the transaction documents. This document cannot be reproduced except in full, without prior written approval of the Company. Any unauthorized alteration, forgery or falsification of the content or appearance of this document is unlawful and offenders may be prosecuted to the fullest extent of the law. Unless otherwise stated the results shown in this test report refer only to the sample(s) tested and such sample(s) are retained for 30 days only.

Attention: To check the authenticity of testing /inspection report & certificate, please contact us at telephone: (86-755) 8307 1443, or email: QN.Doccheck@sgs.com

3 General Information

3.1 Details of Client

| | |
|--------------------------|---|
| Applicant: | Quectel Wireless Solutions Co., Ltd. |
| Address of Applicant: | Building 5, Shanghai Business Park Phase III (Area B), No.1016 Tianlin Road, Minhang District, Shanghai 200233, China |
| Manufacturer: | Quectel Wireless Solutions Co., Ltd. |
| Address of Manufacturer: | Building 5, Shanghai Business Park Phase III (Area B), No.1016 Tianlin Road, Minhang District, Shanghai 200233, China |

3.2 Test Location

| | |
|----------------|--|
| Company: | SGS-CSTC Standards Technical Services (Suzhou) Co., Ltd. |
| Address: | South of No. 6 Plant, No. 1, Runsheng Road, Suzhou Industrial Park, Suzhou Area, China (Jiangsu) Pilot Free Trade Zone |
| Post code: | 215000 |
| Test engineer: | Ives Cheng |

3.3 Test Facility

The test facility is recognized, certified, or accredited by the following organizations:

• **A2LA (Certificate No. 6336.01)**

SGS-CSTC STANDARDS TECHNICAL SERVICES (SUZHOU) CO., LTD. is accredited by the American Association for Laboratory Accreditation(A2LA). Certificate No. 6336.01.

• **Innovation, Science and Economic Development Canada**

SGS-CSTC STANDARDS TECHNICAL SERVICES (SUZHOU) CO., LTD. has been recognized by ISED as an accredited testing laboratory.

CAB identifier: CN0120.

IC#: 27594.

• **FCC –Designation Number: CN1312**

SGS-CSTC STANDARDS TECHNICAL SERVICES (SUZHOU) CO., LTD. has been recognized as an accredited testing laboratory.

Designation Number: CN1312.

Test Firm Registration Number: 717327



Unless otherwise agreed in writing, this document is issued by the Company subject to its General Conditions of Service printed overleaf, available on request or accessible at <http://www.sgs.com/en/Terms-and-Conditions.aspx> and, for electronic format documents, subject to Terms and Conditions for Electronic Documents at <http://www.sgs.com/en/Terms-and-Conditions/Terms-e-Documents.aspx>. Attention is drawn to the limitation of liability, indemnification and jurisdiction issues defined therein. Any holder of this document is advised that information contained hereon reflects the Company's findings at the time of its intervention only and within the limits of Client's instructions, if any. The Company's sole responsibility is to its Client and this document does not exonerate parties to a transaction from exercising all their rights and obligations under the transaction documents. This document cannot be reproduced except in full, without prior written approval of the Company. Any unauthorized alteration, forgery or falsification of the content or appearance of this document is unlawful and offenders may be prosecuted to the fullest extent of the law. Unless otherwise stated the results shown in this test report refer only to the sample(s) tested and such sample(s) are retained for 30 days only.

Attention: To check the authenticity of testing /inspection report & certificate, please contact us at telephone: (86-755) 8307 1443, or email: QN.Doccheck@sgs.com

South of No. 6 Plant, No. 1, Runsheng Road, Suzhou Industrial Park, Suzhou Area, China (Jiangsu) Pilot Free Trade Zone 215000 t (86-512) 62992980 www.sgs.com.cn
 中国·苏州·中国(江苏)自由贸易试验区苏州片区苏州工业园区润胜路1号的6号厂房南楼 邮编: 215000 t (86-512) 62992980 sgs.china@sgs.com

3.4 General Description of EUT

| | | |
|----------------------|---|--|
| EUT Description: | Smart Module | |
| Model No.: | SG560D-WF | |
| Trade Mark: | Quectel | |
| Hardware Version: | R1.0 | |
| Software Version: | SG560DWFPAR02A03 | |
| SN: | E1Q23CD11000024 | |
| WLAN Mode Supported: | 802.11a: | 20 MHz channel bandwidth |
| | 802.11n: | 20 MHz / 40 MHz channel bandwidth |
| | 802.11ac: | 20 MHz / 40 MHz / 80 MHz channel bandwidth |
| | 802.11ax: | 20 MHz / 40 MHz / 80 MHz / 160 MHz channel bandwidth |
| Operation Frequency: | 5250MHz to 5350MHz | |
| | 5470MHz to 5725MHz | |
| Modulation Type: | 802.11a: | OFDM (BPSK, QPSK, 16QAM, 64QAM) |
| | 802.11n: | OFDM (BPSK, QPSK, 16QAM, 64QAM) |
| | 802.11ac: | OFDM (BPSK, QPSK, 16QAM, 64QAM, 256QAM) |
| | 802.11ax: | OFDM/OFDMA (BPSK, QPSK, 16QAM, 64QAM, 256QAM, 1024QAM) |
| Channel Spacing: | 20MHz: | 802.11a/n(HT20)/ac(VHT20)/ax(HE20) |
| | 40MHz: | 802.11n(HT40)/ac(VHT40)/ax(HE40) |
| | 80MHz: | 802.11ac(VHT80)/ax(HE80) |
| | 160MHz: | 802.11ax(HE160) |
| Antenna Type: | External Antenna | |
| Antenna Gain: | 5250MHz to 5350MHz: -0.19dBi (Ant0); -0.19dBi (Ant1); | |
| | 5470MHz to 5725MHz: 1.28dBi (Ant0); 1.28dBi (Ant1); | |
| Smart System: | Note: The antenna gain are derived from the gain information report provided by the manufacturer. | |
| | <input checked="" type="checkbox"/> SISO | 802.11a/n/ac/ax |
| | <input checked="" type="checkbox"/> MIMO | 802.11n/ac/ax: 2Tx & 2Rx |
| DFS Function: | <input checked="" type="checkbox"/> Diversity | 802.11a: 2Tx & 2Rx |
| | <input checked="" type="checkbox"/> Master | |
| | <input type="checkbox"/> Slave with radar detection | <input type="checkbox"/> Slave without radar detection |
| RF Cable: | 1.5dB | |
| Remark: | As above information is provided and confirmed by the applicant. SGS is not liable to the accuracy, suitability, reliability or/and integrity of the information. | |



Unless otherwise agreed in writing, this document is issued by the Company subject to its General Conditions of Service printed overleaf, available on request or accessible at <http://www.sgs.com/en/Terms-and-Conditions.aspx> and, for electronic format documents, subject to Terms and Conditions for Electronic Documents at <http://www.sgs.com/en/Terms-and-Conditions/Terms-and-Conditions-for-Electronic-Format-Documents.aspx>. Attention is drawn to the limitation of liability, indemnification and jurisdiction issues defined therein. Any holder of this document is advised that information contained hereon reflects the Company's findings at the time of its intervention only and within the limits of Client's instructions, if any. The Company's sole responsibility is to its Client and this document does not exonerate parties to a transaction from exercising all their rights and obligations under the transaction documents. This document cannot be reproduced except in full, without prior written approval of the Company. Any unauthorized alteration, forgery or falsification of the content or appearance of this document is unlawful and offenders may be prosecuted to the fullest extent of the law. Unless otherwise stated the results shown in this test report refer only to the sample(s) tested and such sample(s) are retained for 30 days only.

Attention: To check the authenticity of testing /inspection report & certificate, please contact us at telephone: (86-755) 8307 1443, or email: QN.Doccheck@sgs.com

South of No. 6 Plant, No. 1, Runsheng Road, Suzhou Industrial Park, Suzhou Area, China (Jiangsu) Pilot Free Trade Zone 215000 t (86-512) 62992980 www.sgs.com.cn
 中国·苏州·中国(江苏)自由贸易试验区苏州片区苏州工业园区润胜路1号的6号厂房南楼 邮编: 215000 t (86-512) 62992980 sgs.china@sgs.com

Remark:

In FCC 15.31, for each band in which the device can be operated with the device operating at the number of frequencies in each band specified in the following table, and the selected channel to perform the test as below:

| Frequency range over which device operates | Number of Measurement Frequencies Required | Location of Measurement Frequency in Band of Operation |
|--|--|--|
| 1 MHz or less | 1 | centre |
| 1 MHz to 10 MHz | 2 | 1 near high end, 1 near low end |
| Greater than 10 MHz | 3 | 1 near high end, 1 near centre |

For UNII Band II-A:

| Mode | Channel | Frequency(MHz) |
|----------------------------|---------------------|----------------|
| IEEE 802.11a/n/ac/ax 20MHz | The Lowest channel | 5260 |
| | The Middle channel | 5280 |
| | The Highest channel | 5320 |
| IEEE 802.11n/ac/ax 40MHz | The Lowest channel | 5270 |
| | The Highest channel | 5310 |
| IEEE 802.11ac/ax 80MHz | The Middle channel | 5290 |
| IEEE 802.11ax 160MHz | The Middle channel | 5250 |

For UNII Band II-C:

| Mode | Channel | Frequency(MHz) |
|----------------------------|---------------------|----------------|
| IEEE 802.11a/n/ac/ax 20MHz | The Lowest channel | 5500 |
| | The Middle channel | 5580 |
| | The Highest channel | 5700 |
| IEEE 802.11n/ac/ax 40MHz | The Lowest channel | 5510 |
| | The Middle channel | 5550 |
| | The Highest channel | 5670 |
| IEEE 802.11ac/ax 80MHz | The Lowest channel | 5530 |
| | The Highest channel | 5610 |
| IEEE 802.11ax 160MHz | The Middle channel | 5570 |



Unless otherwise agreed in writing, this document is issued by the Company subject to its General Conditions of Service printed overleaf, available on request or accessible at <http://www.sgs.com/en/Terms-and-Conditions.aspx> and, for electronic format documents, subject to Terms and Conditions for Electronic Documents at <http://www.sgs.com/en/Terms-and-Conditions/Terms-e-Documents.aspx>. Attention is drawn to the limitation of liability, indemnification and jurisdiction issues defined therein. Any holder of this document is advised that information contained hereon reflects the Company's findings at the time of its intervention only and within the limits of Client's instructions, if any. The Company's sole responsibility is to its Client and this document does not exonerate parties to a transaction from exercising all their rights and obligations under the transaction documents. This document cannot be reproduced except in full, without prior written approval of the Company. Any unauthorized alteration, forgery or falsification of the content or appearance of this document is unlawful and offenders may be prosecuted to the fullest extent of the law. Unless otherwise stated the results shown in this test report refer only to the sample(s) tested and such sample(s) are retained for 30 days only.

Attention: To check the authenticity of testing /inspection report & certificate, please contact us at telephone: (86-755) 8307 1443, or email: QN.Doccheck@sgs.com

South of No. 6 Plant, No. 1, Runsheng Road, Suzhou Industrial Park, Suzhou Area, China (Jiangsu) Pilot Free Trade Zone 215000 t (86-512) 62992980 www.sgsgroup.com.cn
 中国·苏州·中国(江苏)自由贸易试验区苏州片区苏州工业园区润胜路1号的6号厂房南楼 邮编: 215000 t (86-512) 62992980 sgs.china@sgs.com

3.5 Test Environment and Mode

| | | |
|---|--|-------------------|
| Environment Parameter | 101.0 kPa Selected Values During Tests | |
| Relative Humidity | 44-46 % RH Ambient | |
| Value | Temperature(°C) | Voltage(V) |
| NTNV | 22~23 | 4 |
| Remark: NV: Normal Voltage NT: Normal Temperature | | |

3.6 Description of Support Units

| Description | Manufacturer | Model No. |
|--|---|--------------------------------------|
| Router | ASUS | GT-AXE11000 (FCC ID MSQ-RTAXJF00) |
| SMART-5G-EVB-KIT* | Quectel | Q1-C0129 |
| Adapter* | DongGuan City GangQi Electronic Co.,Ltd | CQ36-120300-AX |
| Remark: the information with "*" are provided by client. | | |

3.7 Worst-case configuration and mode

Low data rate was used to test on antenna port conducted tests and radiated spurious emissions since it has the highest maximum power. Following are the worst-case data rates set for test:

| Modulation Type | SISO - Data Rate | CDD/MIMO - Data Rate |
|-------------------|------------------|----------------------|
| 802.11a | 6 Mbps | 12 Mbps |
| 802.11n (HT 20) | MCS0 (6.5 Mbps) | MCS0 (13 Mbps) |
| 802.11n (HT 40) | MCS0 (13.5 Mbps) | MCS0 (27 Mbps) |
| 802.11ac (VHT 20) | MCS0 (6.5 Mbps) | MCS0 (13 Mbps) |
| 802.11ac (VHT 40) | MCS0 (13.5 Mbps) | MCS0 (27 Mbps) |
| 802.11ac (VHT 80) | MCS0 (29.3 Mbps) | MCS0 (58.5 Mbps) |
| 802.11ax (HE 20) | MCS0 (8 Mbps) | MCS0 (16 Mbps) |
| 802.11ax (HE 40) | MCS0 (16 Mbps) | MCS0 (32 Mbps) |
| 802.11ax (HE 80) | MCS0 (34 Mbps) | MCS0 (68 Mbps) |
| 802.11ax (HE 160) | MCS0 (68 Mbps) | MCS0 (136 Mbps) |



Unless otherwise agreed in writing, this document is issued by the Company subject to its General Conditions of Service printed overleaf, available on request or accessible at <http://www.sgs.com/en/Terms-and-Conditions.aspx> and, for electronic format documents, subject to Terms and Conditions for Electronic Documents at <http://www.sgs.com/en/Terms-and-Conditions/Terms-e-Documents.aspx>. Attention is drawn to the limitation of liability, indemnification and jurisdiction issues defined therein. Any holder of this document is advised that information contained herein reflects the Company's findings at the time of its intervention only and within the limits of Client's instructions, if any. The Company's sole responsibility is to its Client and this document does not exonerate parties to a transaction from exercising all their rights and obligations under the transaction documents. This document cannot be reproduced except in full, without prior written approval of the Company. Any unauthorized alteration, forgery or falsification of the content or appearance of this document is unlawful and offenders may be prosecuted to the fullest extent of the law. Unless otherwise stated the results shown in this test report refer only to the sample(s) tested and such sample(s) are retained for 30 days only.

Attention: To check the authenticity of testing /inspection report & certificate, please contact us at telephone: (86-755) 8307 1443, or email: QN.Doccheck@sgs.com

South of No. 6 Plant, No. 1, Runsheng Road, Suzhou Industrial Park, Suzhou Area, China (Jiangsu) Pilot Free Trade Zone 215000 t (86-512) 62992980 www.sgs.com.cn
 中国·苏州·中国(江苏)自由贸易试验区苏州片区苏州工业园区润胜路1号的6号厂房南楼 邮编: 215000 t (86-512) 62992980 sgs.china@sgs.com

4 Test results and Measurement Data

4.1 Dynamic Frequency Selection

4.1.1 DFS Measurement Configuration

| | |
|----------------|---|
| Test Condition | Conducted Measurement Use 50Ohms to connect cable/connector calibration and testing, Use wifi0 port for testing. Refer to Section 4.1.7 for test connection. |
|----------------|---|

4.1.2 DFS Threshold level

| | |
|--|--|
| DFS Threshold level:(-60.72)dBm | <input checked="" type="checkbox"/> At the antenna connector <input type="checkbox"/> In front of the antenna |
| The Interference Radar Detection Threshold Level is: (Band II-C: -62dBm + 1.28dBi + 0dB = -60.72dBm) That had been taken into account the output power range and antenna gain. | |

4.1.3 Power-on cycle

| |
|---|
| The time required for the Master Device and/or Client Device to complete its power-on cycle(37S). |
|---|

4.1.4 User Access Restrctions

| |
|---|
| DFS Controls(Hardware or software) related to radar detection are NOT accessible to the user. Manufacturer statement confirming that information regarding the parameters of the detected Radar Waveforms is not available to the end user. |
|---|

4.1.5 Channel Loading/Data Streaming

| | |
|-------------------------------------|--|
| <input type="checkbox"/> | The dara file(MPEG-4) has been transmitting in a streaming mode. |
| <input checked="" type="checkbox"/> | Softeware to ping the client is permitted to simuate data transfer with random ping intervals. |
| <input checked="" type="checkbox"/> | Minimum channel loading of approximately 17%. |
| <input type="checkbox"/> | Unicast protocol has been used. |



Unless otherwise agreed in writing, this document is issued by the Company subject to its General Conditions of Service printed overleaf, available on request or accessible at <http://www.sgs.com/en/Terms-and-Conditions.aspx> and, for electronic format documents, subject to Terms and Conditions for Electronic Documents at <http://www.sgs.com/en/Terms-and-Conditions/Terms-e-Document.aspx>. Attention is drawn to the limitation of liability, indemnification and jurisdiction issues defined therein. Any holder of this document is advised that information contained hereon reflects the Company's findings at the time of its intervention only and within the limits of Client's instructions, if any. The Company's sole responsibility is to its Client and this document does not exonerate parties to a transaction from exercising all their rights and obligations under the transaction documents. This document cannot be reproduced except in full, without prior written approval of the Company. Any unauthorized alteration, forgery or falsification of the content or appearance of this document is unlawful and offenders may be prosecuted to the fullest extent of the law. Unless otherwise stated the results shown in this test report refer only to the sample(s) tested and such sample(s) are retained for 30 days only.

Attention: To check the authenticity of testing /inspection report & certificate, please contact us at telephone: (86-755) 8307 1443, or email: QN.Doccheck@sgs.com

South of No. 6 Plant, No. 1, Runsheng Road, Suzhou Industrial Park, Suzhou Area, China (Jiangsu) Pilot Free Trade Zone 215000 t (86-512) 62992980 www.sgsgroup.com.cn
 中国·苏州·中国(江苏)自由贸易试验区苏州片区苏州工业园区润胜路1号的6号厂房南楼 邮编: 215000 t (86-512) 62992980 sgs.china@sgs.com

4.1.6 Conducted Setup of Calibration of DFS Detection Threshold Level



4.1.7 Test Setup

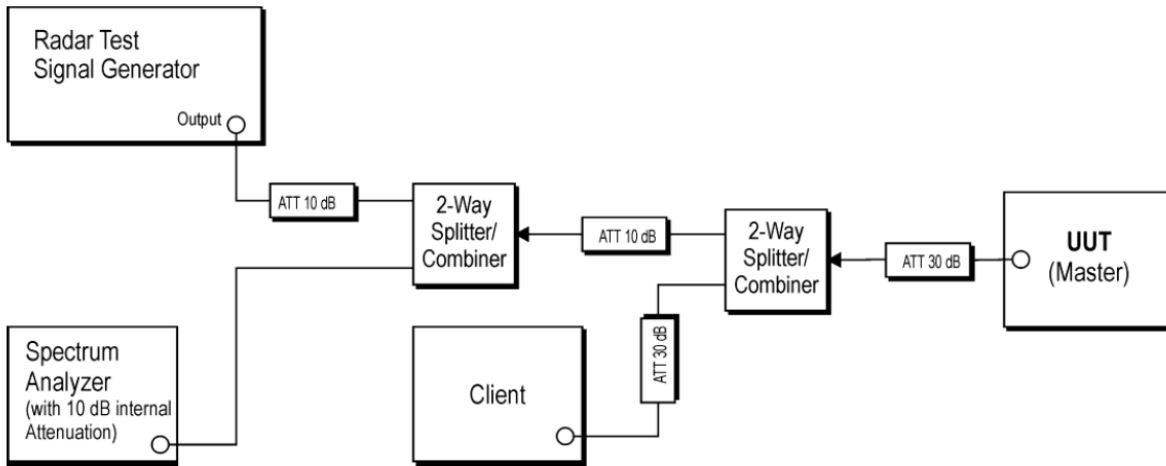

Unless otherwise agreed in writing, this document is issued by the Company subject to its General Conditions of Service printed overleaf, available on request or accessible at <http://www.sgs.com/en/Terms-and-Conditions.aspx> and, for electronic format documents, subject to Terms and Conditions for Electronic Documents at <http://www.sgs.com/en/Terms-and-Conditions/Terms-e-Documents.aspx>. Attention is drawn to the limitation of liability, indemnification and jurisdiction issues defined therein. Any holder of this document is advised that information contained hereon reflects the Company's findings at the time of its intervention only and within the limits of Client's instructions, if any. The Company's sole responsibility is to its Client and this document does not exonerate parties to a transaction from exercising all their rights and obligations under the transaction documents. This document cannot be reproduced except in full, without prior written approval of the Company. Any unauthorized alteration, forgery or falsification of the content or appearance of this document is unlawful and offenders may be prosecuted to the fullest extent of the law. Unless otherwise stated the results shown in this test report refer only to the sample(s) tested and such sample(s) are retained for 30 days only.

Attention: To check the authenticity of testing /inspection report & certificate, please contact us at telephone: (86-755) 8307 1443, or email: CN.Doccheck@sgs.com

South of No. 6 Plant, No. 1, Runsheng Road, Suzhou Industrial Park, Suzhou Area, China (Jiangsu) Pilot Free Trade Zone 215000 t (86-512) 62992980 www.sgs.com.cn
 中国·苏州·中国 (江苏) 自由贸易试验区苏州片区苏州工业园区润胜路1号的6号厂房南楼 邮编: 215000 t (86-512) 62992980 sgs.china@sgs.com

4.1.8 Test Procedures

4.1.8.1 U-NII Detection Bandwidth

Adjust the equipment to produce a single *Burst* of any one of the Short Pulse Radar Types 0 – 4 in **Table 5** at the center frequency of the UUT *Operating Channel* at the specified *DFS Detection Threshold* level found in **Table 3**.

Set the UUT up as a standalone device (no associated Client or Master, as appropriate) and no traffic. Frame based systems will be set to a talk/listen ratio reflecting the worst case (maximum) that is user configurable during this test.

Generate a single radar *Burst*, and note the response of the UUT. Repeat for a minimum of 10 trials. The UUT must detect the *Radar Waveform* within the DFS band using the specified *U-NII Detection Bandwidth* criterion shown in **Table 4**. In cases where the channel bandwidth may exceed past the DFS band edge on specific channels (i.e., 802.11ac or wideband frame based systems) select a channel that has the entire emission bandwidth within the DFS band. If this is not possible, test the detection BW to the DFS band edge. Starting at the center frequency of the UUT operating *Channel*, increase the radar frequency in 5 MHz steps, repeating the above test sequence, until the detection rate falls below the *U-NII Detection Bandwidth* criterion specified in **Table 4**. Repeat this measurement in 1MHz steps at frequencies 5 MHz below where the detection rate begins to fall. Record the highest frequency (denote as FH) at which detection is greater than or equal to the *U-NII Detection Bandwidth* criterion. Recording the detection rate at frequencies above FH is not required to demonstrate compliance.

Starting at the center frequency of the UUT operating *Channel*, decrease the radar frequency in 5 MHz steps, repeating the above test sequence, until the detection rate falls below the *U-NII Detection Bandwidth* criterion specified in **Table 4**. Repeat this measurement in 1MHz steps at frequencies 5 MHz above where the detection rate begins to fall. Record the lowest frequency (denote as FL) at which detection is greater than or equal to the *U-NII Detection Bandwidth* criterion. Recording the detection rate at frequencies below FL is not required to demonstrate compliance.

The *U-NII Detection Bandwidth* is calculated as follows:

$$U-NII\ Detection\ Bandwidth = FH - FL$$

The *U-NII Detection Bandwidth* must meet the *U-NII Detection Bandwidth* criterion specified in **Table 4**.

Otherwise, the UUT does not comply with DFS requirements. This is essential to ensure that the UUT is capable of detecting *Radar Waveforms* across the same frequency spectrum that contains the significant energy from the system. In the case that the *U-NII Detection Bandwidth* is greater than or equal to the 99 percent power bandwidth for the measured FH and FL, the test can be truncated and the *U-NII Detection Bandwidth* can be reported as the measured FH and FL.

4.1.8.2 Performance Requirements Check

The following tests must be performed for U-NII device certification: Initial *Channel Startup Check* with a radar *Burst* at start of *Channel Availability Check* and with a radar *Burst* at end of *Channel Availability Check*; *In-Service Monitoring*; and the 30 minute *Non-Occupancy Period*.

4.1.8.3 Initial Channel Availability Check Time

The Initial *Channel Availability Check Time* tests that the UUT does not emit beacon, control, or data signals on the test *Channel* until the power-up sequence has been completed and the U-NII device checks for *Radar Waveforms* for one minute on the test *Channel*. This test does not use any *Radar Waveforms* and only needs to be performed one time.

a) The U-NII devices will be powered on and be instructed to operate on the appropriate U-NII *Channel* that must incorporate DFS functions. At the same time the UUT is powered on, the spectrum analyzer will be set to zero span mode with a 3 MHz RBW and 3 MHz VBW on the *Channel* occupied by the radar (Chr) with a 2.5 minute sweep time. The spectrum analyzer's sweep will be started at the same time power is applied to the U-NII device.

b) The UUT should not transmit any beacon or data transmissions until at least 1 minute after the completion of the power-on cycle.



Unless otherwise agreed in writing, this document is issued by the Company subject to its General Conditions of Service printed overleaf, available on request or accessible at <http://www.sgs.com/en/Terms-and-Conditions.aspx> and, for electronic format documents, subject to Terms and Conditions for Electronic Documents at <http://www.sgs.com/en/Terms-and-Conditions/Terms-e-Documents.aspx>. Attention is drawn to the limitation of liability, indemnification and jurisdiction issues defined therein. Any holder of this document is advised that information contained herein reflects the Company's findings at the time of its intervention only and within the limits of Client's instructions, if any. The Company's sole responsibility is to its Client and this document does not exonerate parties to a transaction from exercising all their rights and obligations under the transaction documents. This document cannot be reproduced except in full, without prior written approval of the Company. Any unauthorized alteration, forgery or falsification of the content or appearance of this document is unlawful and offenders may be prosecuted to the fullest extent of the law. Unless otherwise stated the results shown in this test report refer only to the sample(s) tested and such sample(s) are retained for 30 days only.

Attention: To check the authenticity of testing /inspection report & certificate, please contact us at telephone: (86-755) 8307 1443, or email: QN.Doccheck@sgs.com

South of No. 6 Plant, No. 1, Runsheng Road, Suzhou Industrial Park, Suzhou Area, China (Jiangsu) Pilot Free Trade Zone 215000

t (86-512) 62992980 www.sgsgroup.com.cn

中国·苏州·中国（江苏）自由贸易试验区苏州片区苏州工业园区润胜路1号的6号厂房南座 邮编：215000

t (86-512) 62992980 sgs.china@sgs.com

c) Confirm that the UUT initiates transmission on the channel

This measurement can be used to determine the length of the power-on cycle if it is not supplied by the manufacturer. If the spectrum analyzer sweep is started at the same time the UUT is powered on and the UUT does not begin transmissions until it has completed the cycle, the power-on time can be determined by comparing the two times.

4.1.8.4 Radar Burst at the Beginning of the Channel Availability Check Time

The steps below define the procedure to verify successful radar detection on the test *Channel* during a period equal to the *Channel Availability Check Time* and avoidance of operation on that *Channel* when a *Radar Burst* with a level equal to the *DFS Detection Threshold* + 1 dB occurs at the beginning of the *Channel Availability Check Time*. This is illustrated in **Figure 15**.

- a) The *Radar Waveform* generator and UUT are connected using the applicable test setup described in the sections on configuration for Conducted Tests (7.2) or Radiated Tests (7.3) and the power of the UUT is switched off.
- b) The UUT is powered on at T_0 . T_1 denotes the instant when the UUT has completed its power-up sequence (T_{power_up}). The *Channel Availability Check Time* commences on *Chr* at instant T_1 and will end no sooner than $T_1 + T_{ch_avail_check}$.
- c) A single *Burst* of one of the Short Pulse Radar Types 0-4 will commence within a 6 second window starting at T_1 . An additional 1 dB is added to the radar test signal to ensure it is at or above the *DFS Detection Threshold*, accounting for equipment variations/errors.
- d) Visual indication or measured results on the UUT of successful detection of the radar *Burst* will be recorded and reported. Observation of *Chr* for UUT emissions will continue for 2.5 minutes after the radar *Burst* has been generated.
- e) Verify that during the 2.5 minute measurement window no UUT transmissions occurred on *Chr*. The *Channel Availability Check* results will be recorded.

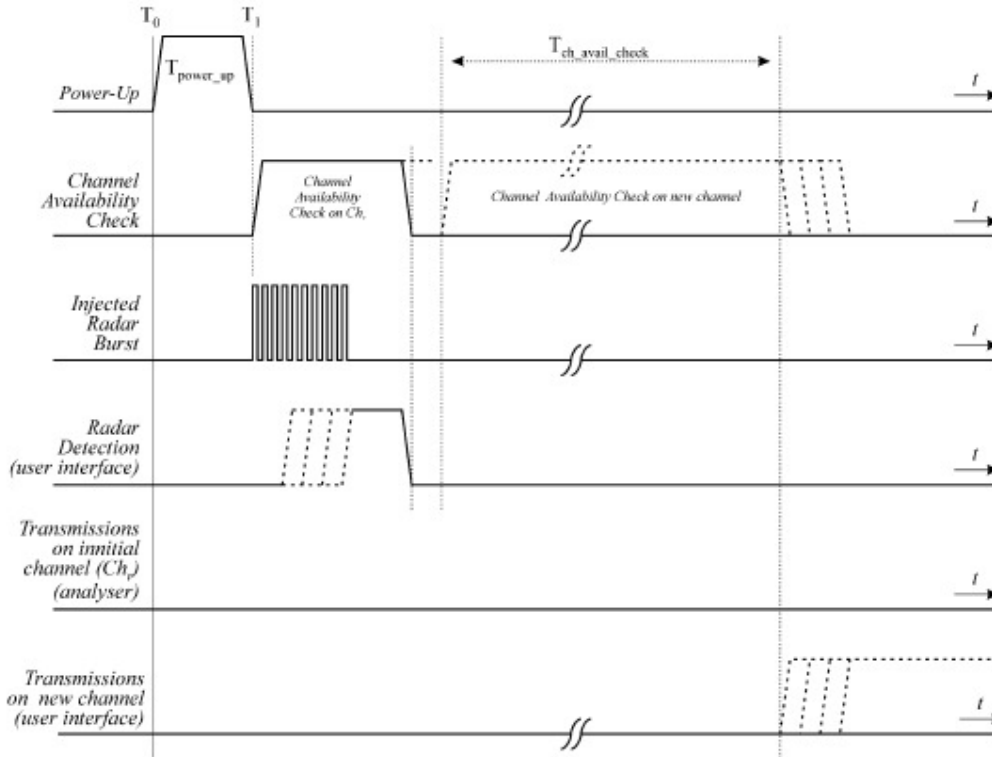

Figure 15: Example of timing for radar testing at the beginning of the Channel Availability Check Time



Unless otherwise agreed in writing, this document is issued by the Company subject to its General Conditions of Service printed overleaf, available on request or accessible at <http://www.sgs.com/en/Terms-and-Conditions.aspx> and, for electronic format documents, subject to Terms and Conditions for Electronic Documents at <http://www.sgs.com/en/Terms-and-Conditions/Terms-e-Documents.aspx>. Attention is drawn to the limitation of liability, indemnification and jurisdiction issues defined therein. Any holder of this document is advised that information contained hereon reflects the Company's findings at the time of its intervention only and within the limits of Client's instructions, if any. The Company's sole responsibility is to its Client and this document does not exonerate parties to a transaction from exercising all their rights and obligations under the transaction documents. This document cannot be reproduced except in full, without prior written approval of the Company. Any unauthorized alteration, forgery or falsification of the content or appearance of this document is unlawful and offenders may be prosecuted to the fullest extent of the law. Unless otherwise stated the results shown in this test report refer only to the sample(s) tested and such sample(s) are retained for 30 days only.

Attention: To check the authenticity of testing /inspection report & certificate, please contact us at telephone: (86-755) 8307 1443, or email: QN.Doccheck@sgs.com

South of No. 6 Plant, No. 1, Runsheng Road, Suzhou Industrial Park, Suzhou Area, China (Jiangsu) Pilot Free Trade Zone 215000 t (86-512) 62992980 www.sgs.com.cn
 中国·苏州·中国(江苏)自由贸易试验区苏州片区苏州工业园区润胜路1号的6号厂房南楼 邮编: 215000 t (86-512) 62992980 sgs.china@sgs.com

4.1.8.5 Radar Burst at the End of the Channel Availability Check Time

The steps below define the procedure to verify successful radar detection on the test *Channel* during a period equal to the *Channel Availability Check Time* and avoidance of operation on that *Channel* when a radar *Burst* with a level equal to the *DFS Detection Threshold* + 1dB occurs at the end of the *Channel Availability Check Time*. This is illustrated in **Figure 16**.

- a) The *Radar Waveform* generator and UUT are connected using the applicable test setup described in the sections for Conducted Tests (7.2) or Radiated Tests (7.3) and the power of the UUT is switched off.
- b) The UUT is powered on at T0. T1 denotes the instant when the UUT has completed its power-up sequence (T_{power_up}). The *Channel Availability Check Time* commences on Chr at instant T1 and will end no sooner than T1 + Tch_{avail_check}.
- c) A single *Burst* of one of the Short Pulse Radar Types 0-4 will commence within a 6 second window starting at T1 + 54 seconds. An additional 1 dB is added to the radar test signal to ensure it is at or above the *DFS Detection Threshold*, accounting for equipment variations/errors.
- d) Visual indication or measured results on the UUT of successful detection of the radar *Burst* will be recorded and reported. Observation of Chr for UUT emissions will continue for 2.5 minutes after the radar *Burst* has been generated.
- e) Verify that during the 2.5 minute measurement window no UUT transmissions occurred on Chr. The *Channel Availability Check* results will be recorded.

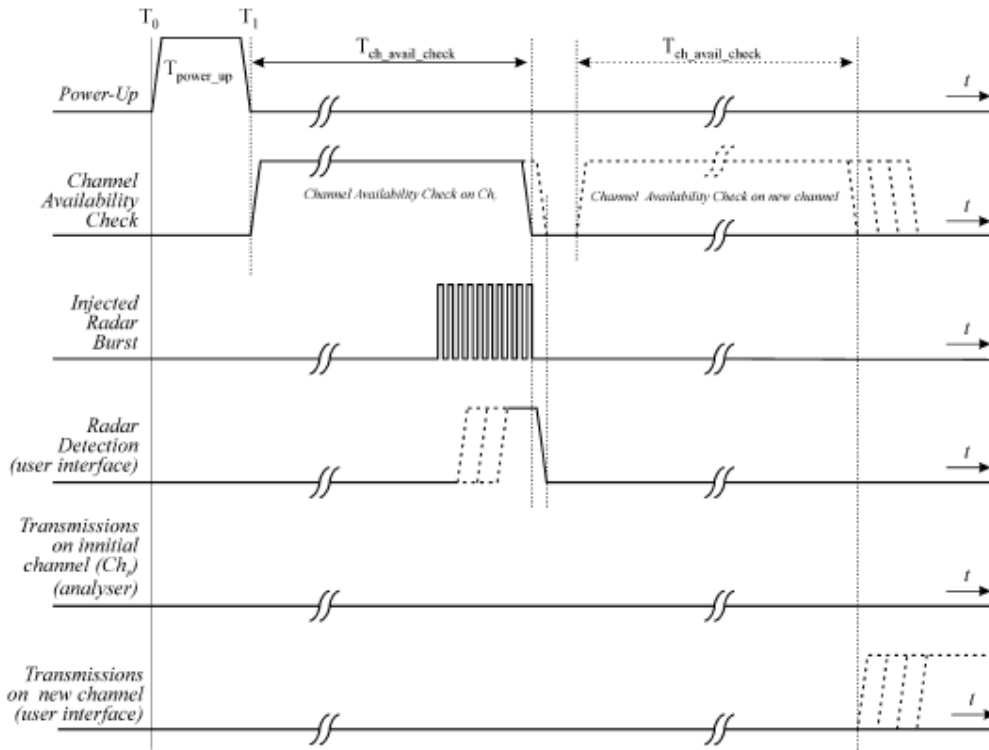

Figure 16: Example of timing for radar testing towards the end of the Channel Availability Check Time

4.1.8.6 In-Service Monitoring for Channel Move Time, Channel Closing Transmission Time and Non-Occupancy Period

These tests define how the following DFS parameters are verified during *In-Service Monitoring*;

- *Channel Closing Transmission Time*
- *Channel Move Time*
- *Non-Occupancy Period*



Unless otherwise agreed in writing, this document is issued by the Company subject to its General Conditions of Service printed overleaf, available on request or accessible at <http://www.sgs.com/en/Terms-and-Conditions.aspx> and, for electronic format documents, subject to Terms and Conditions for Electronic Documents at <http://www.sgs.com/en/Terms-and-Conditions/Terms-e-Documents.aspx>. Attention is drawn to the limitation of liability, indemnification and jurisdiction issues defined therein. Any holder of this document is advised that information contained hereon reflects the Company's findings at the time of its intervention only and within the limits of Client's instructions, if any. The Company's sole responsibility is to its Client and this document does not exonerate parties to a transaction from exercising all their rights and obligations under the transaction documents. This document cannot be reproduced except in full, without prior written approval of the Company. Any unauthorized alteration, forgery or falsification of the content or appearance of this document is unlawful and offenders may be prosecuted to the fullest extent of the law. Unless otherwise stated the results shown in this test report refer only to the sample(s) tested and such sample(s) are retained for 30 days only.

Attention: To check the authenticity of testing /inspection report & certificate, please contact us at telephone: (86-755) 8307 1443, or email: QN.Doccheck@sgs.com

The steps below define the procedure to determine the above mentioned parameters when a radar *Burst* with a level equal to the *DFS Detection Threshold* + 1dB is generated on the *Operating Channel* of the U-NII device (*In- Service Monitoring*).

- a) One frequency will be chosen from the *Operating Channels* of the UUT within the 5250-5350 MHz or 5470-5725 MHz bands. For 802.11 devices, the test frequency must contain control signals. This can be verified by disabling channel loading and monitoring the spectrum analyzer. If no control signals are detected, another frequency must be selected within the emission bandwidth where control signals are detected.
- b) In case the UUT is a U-NII device operating as a *Client Device* (with or without DFS), a U-NII device operating as a *Master Device* will be used to allow the UUT (Client device) to *Associate* with the *Master Device*. In case the UUT is a *Master Device*, a U-NII device operating as a *Client Device* will be used and it is assumed that the Client will *Associate* with the UUT (Master). In both cases for conducted tests, the *Radar Waveform* generator will be connected to the *Master Device*. For radiated tests, the emissions of the *Radar Waveform* generator will be directed towards the *Master Device*. If the *Master Device* has antenna gain, the main beam of the antenna will be directed toward the radar emitter. Vertical polarization is used for testing.
- c) Stream the channel loading test file from the *Master Device* to the *Client Device* on the test *Channel* for the entire period of the test.
- d) At time T_0 the *Radar Waveform* generator sends a *Burst* of pulses for one of the Radar Type 0 in **Table 5** at levels defined in **Table 3**, on the *Operating Channel*. An additional 1 dB is added to the radar test signal to ensure it is at or above the *DFS Detection Threshold*, accounting for equipment variations/errors.
- e) Observe the transmissions of the UUT at the end of the radar *Burst* on the *Operating Channel* for duration greater than 10 seconds. Measure and record the transmissions from the UUT during the observation time (*Channel Move Time*). Measure and record the *Channel Closing Transmission Time* if radar detection occurs. **Figure 17** illustrates *Channel Closing Transmission Time*.
- f) When operating as a *Master Device*, monitor the UUT for more than 30 minutes following instant T_2 to verify that the UUT does not resume any transmissions on this *Channel*. Perform this test once and record the measurement result.
- g) In case the UUT is a U-NII device operating as a *Client Device* with *In-Service Monitoring*, perform steps a) to f).

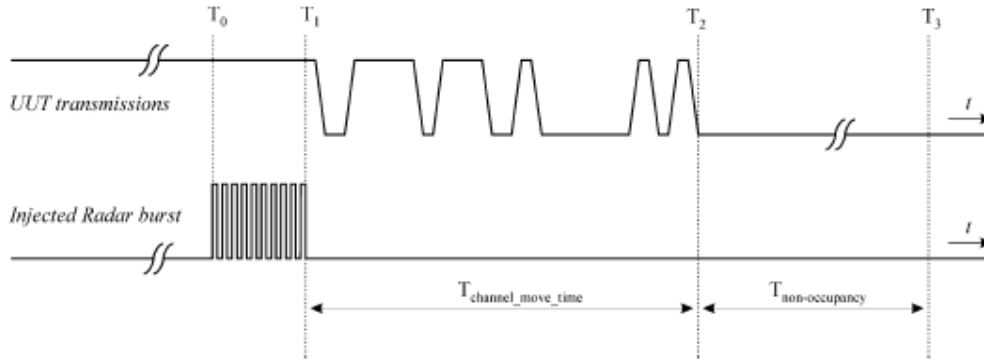

Figure 17: Example of Channel Closing Transmission Time & Channel Closing Time

4.1.8.7 Statistical Performance Check

The steps below define the procedure to determine the minimum percentage of successful detection requirements found in **Tables 5-7** when a radar burst with a level equal to the *DFS Detection Threshold* + 1dB is generated on the *Operating Channel* of the U-NII device (*In- Service Monitoring*).

- a) One frequency will be chosen from the *Operating Channels* of the UUT within the 5250-5350 MHz or 5470-5725 MHz bands.
- b) In case the UUT is a U-NII device operating as a *Client Device* (with or without Radar Detection), a U-NII device operating as a *Master Device* will be used to allow the UUT (Client device) to *Associate* with the *Master Device*. In case the UUT is a *Master Device*, a U-NII device operating as a *Client Device* will be used and it is assumed that the Client will *Associate* with the UUT (Master). In both cases for conducted tests, the



Unless otherwise agreed in writing, this document is issued by the Company subject to its General Conditions of Service printed overleaf, available on request or accessible at <http://www.sgs.com/en/Terms-and-Conditions.aspx> and, for electronic format documents, subject to Terms and Conditions for Electronic Documents at <http://www.sgs.com/en/Terms-and-Conditions/Terms-e-Documents.aspx>. Attention is drawn to the limitation of liability, indemnification and jurisdiction issues defined therein. Any holder of this document is advised that information contained herein reflects the Company's findings at the time of its intervention only and within the limits of Client's instructions, if any. The Company's sole responsibility is to its Client and this document does not exonerate parties to a transaction from exercising all their rights and obligations under the transaction documents. This document cannot be reproduced except in full, without prior written approval of the Company. Any unauthorized alteration, forgery or falsification of the content or appearance of this document is unlawful and offenders may be prosecuted to the fullest extent of the law. Unless otherwise stated the results shown in this test report refer only to the sample(s) tested and such sample(s) are retained for 30 days only.

Attention: To check the authenticity of testing /inspection report & certificate, please contact us at telephone: (86-755) 8307 1443, or email: QN.Doccheck@sgs.com

South of No. 6 Plant, No. 1, Runsheng Road, Suzhou Industrial Park, Suzhou Area, China (Jiangsu) Pilot Free Trade Zone 215000 t (86-512) 62992980 www.sgs.com.cn
 中国·苏州·中国(江苏)自由贸易试验区苏州片区苏州工业园区润胜路1号的6号厂房南楼 邮编: 215000 t (86-512) 62992980 sgs.china@sgs.com

Radar Waveform generator will be connected to the *Master Device*. For radiated tests, the emissions of the *Radar Waveform* generator will be directed towards the *Master Device*. If the *Master Device* has antenna gain, the main beam of the antenna will be directed toward the radar emitter. Vertical polarization is used for testing.

- c) Stream the channel loading test file from the *Master Device* to the Client Device on the test *Channel* for the entire period of the test.
- d) At time T0 the *Radar Waveform* generator sends the individual waveform for each of the Radar Types 1- 6 in **Tables 5-7**, at levels defined in **Table 3**, on the *Operating Channel*. An additional 1 dB is added to the radar test signal to ensure it is at or above the *DFS Detection Threshold*, accounting for equipment variations/errors.
- e) Observe the transmissions of the UUT at the end of the Burst on the *Operating Channel* for duration greater than 10 seconds for Radar Type 0 to ensure detection occurs.
- f) Observe the transmissions of the UUT at the end of the Burst on the *Operating Channel* for duration greater than 22 seconds for Long Pulse Radar Type 5 to ensure detection occurs.
- g) In case the UUT is a U-NII device operating as a *Client Device* with *In-Service Monitoring*, perform steps a) to f).

4.1.8.8 Short Pulse Radar Test

Once the performance requirements check is complete, statistical data will be gathered, to determine the ability of the device to detect the radar test waveforms (Short Pulse Radar Types 1-4) found in **Table 5**. The device can utilize a test mode to demonstrate when detection occurs to prevent the need to reset the device between trials. The percentage of successful detection is calculated by:

$$\frac{\text{TotalWaveformDetections}}{\text{TotalWaveformTrials}} \times 100 = \text{Percentage of Successful Detection Radar Waveform } N = PdN$$

In addition an aggregate minimum percentage of successful detection across all Short Pulse Radar Types 1-4 is required and is calculated as follows:

$$\frac{Pd1 + Pd2 + Pd3 + Pd4}{4}$$

The minimum number of trails, minimum percentage of successful detection and the aggregate minimum percentage of successful detection are found in **Table 5**.

4.1.8.9 Long Pulse Radar Test

Statistical data will be gathered to determine the ability of the device to detect the Long Pulse Radar Type 5 found in **Table 6**. The device can utilize a test mode to demonstrate when detection occurs to prevent the need to reset the device between trials.

Three subsets of trials will be performed with a minimum of ten trials per subset. The subset of trials differ in where the Long Pulse Type 5 Signal is tuned in frequency:

- a) the *Channel* center frequency (Figure 18);
- b) tuned frequencies such that 90% of the Long Pulse Type 5 frequency modulation is within the low edge of the UUT *Occupied Bandwidth* (Figure 19); and
- c) tuned frequencies such that 90% of the Long Pulse Type 5 frequency modulation is within the high edge of the UUT *Occupied Bandwidth* (Figure 20).



Unless otherwise agreed in writing, this document is issued by the Company subject to its General Conditions of Service printed overleaf, available on request or accessible at <http://www.sgs.com/en/Terms-and-Conditions.aspx> and, for electronic format documents, subject to Terms and Conditions for Electronic Documents at <http://www.sgs.com/en/Terms-and-Conditions/Terms-e-Document.aspx>. Attention is drawn to the limitation of liability, indemnification and jurisdiction issues defined therein. Any holder of this document is advised that information contained hereon reflects the Company's findings at the time of its intervention only and within the limits of Client's instructions, if any. The Company's sole responsibility is to its Client and this document does not exonerate parties to a transaction from exercising all their rights and obligations under the transaction documents. This document cannot be reproduced except in full, without prior written approval of the Company. Any unauthorized alteration, forgery or falsification of the content or appearance of this document is unlawful and offenders may be prosecuted to the fullest extent of the law. Unless otherwise stated the results shown in this test report refer only to the sample(s) tested and such sample(s) are retained for 30 days only.

Attention: To check the authenticity of testing /inspection report & certificate, please contact us at telephone: (86-755) 8307 1443, or email: QN.Doccheck@sgs.com

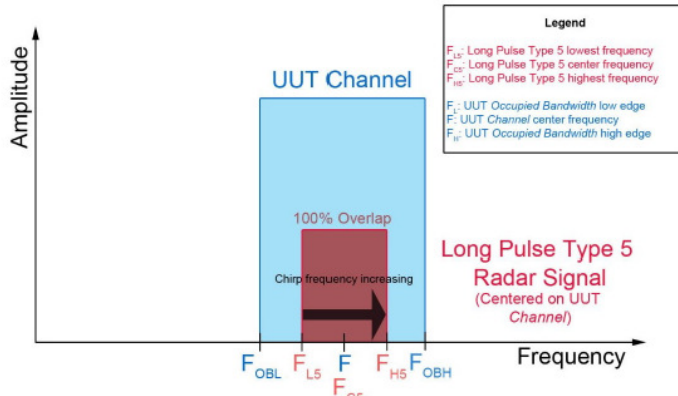

Figure 18: Example of the Relationship Between Long Pulse Type 5 Signal and the U-NII channel when the Signal is Tuned to the UUT Channel Center Frequency

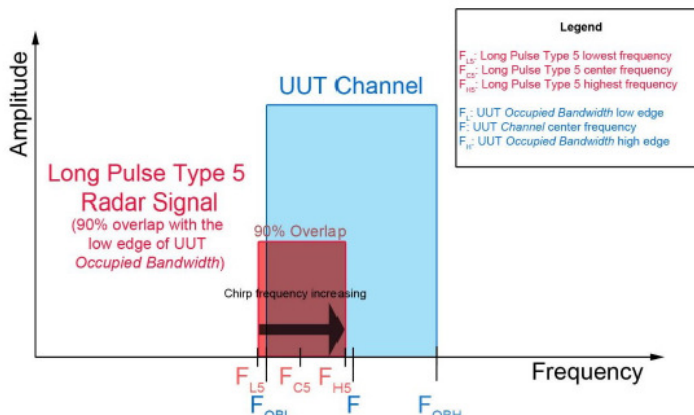

Figure 19: Example of the Relationship Between Long Pulse Type 5 Signal and the U-NII channel when the Signal is Tuned so that 90% of the Radar Signal Overlaps with the Low Edge of the UUT Occupied Bandwidth

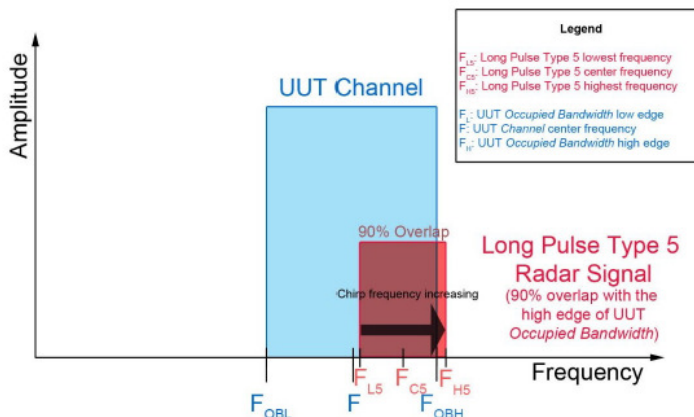

Figure 20: Example of the Relationship Between Long Pulse Type 5 Signal and the U-NII channel when the Signal is Tuned so that 90% of the Radar Signal Overlaps with the High Edge of the UUT Occupied Bandwidth

For subset case 1: the center frequency of the signal generator will remain fixed at the center of the UUT Channel.



Unless otherwise agreed in writing, this document is issued by the Company subject to its General Conditions of Service printed overleaf, available on request or accessible at <http://www.sgs.com/en/Terms-and-Conditions.aspx> and, for electronic format documents, subject to Terms and Conditions for Electronic Documents at <http://www.sgs.com/en/Terms-and-Conditions/Terms-e-Documents.aspx>. Attention is drawn to the limitation of liability, indemnification and jurisdiction issues defined therein. Any holder of this document is advised that information contained hereon reflects the Company's findings at the time of its intervention only and within the limits of Client's instructions, if any. The Company's sole responsibility is to its Client and this document does not exonerate parties to a transaction from exercising all their rights and obligations under the transaction documents. This document cannot be reproduced except in full, without prior written approval of the Company. Any unauthorized alteration, forgery or falsification of the content or appearance of this document is unlawful and offenders may be prosecuted to the fullest extent of the law. Unless otherwise stated the results shown in this test report refer only to the sample(s) tested and such sample(s) are retained for 30 days only.
 Attention: To check the authenticity of testing /inspection report & certificate, please contact us at telephone: (86-755) 8307 1443, or email: QI.Doccheck@sgs.com
 South of No. 6 Plant, No. 1, Runsheng Road, Suzhou Industrial Park, Suzhou Area, China (Jiangsu) Pilot Free Trade Zone 215000 t (86-512) 62992980 www.sgs.com.cn
 中国·苏州·中国 (江苏) 自由贸易试验区苏州片区苏州工业园区润胜路1号的6号厂房南楼 邮编: 215000 t (86-512) 62992980 sgs.china@sgs.com

For subset case 2: to retain 90% frequency overlap between the radar signal and the UUT *Occupied Bandwidth*, the center frequency of the signal generator will vary for each of the ten trials in subset case 2. The center frequency of the signal generator for each trial is calculated by:

$$FL + (0.4 * \text{Chirp Width [in MHz]})$$

For subset case 3: to retain 90% frequency overlap between the radar signal and the UUT *Occupied Bandwidth*, the center frequency of the signal generator will vary for each of the ten trials in subset case 3. The center frequency of the signal generator for each trial is calculated by:

$$FH - (0.4 * \text{Chirp Width [in MHz]})$$

The percentage of successful detection is calculated by dividing the sum of the detections for the three subsets by the sum of trials for the three subsets:

$$\frac{\text{TotalWaveformDetections}}{\text{TotalWaveformTrials}} \times 100$$

4.1.8.10 Frequency Hopping Radar Test

Statistical data will be gathered to determine the ability of the device to detect the Frequency Hopping radar test signal (radar type 6) found in **Table 7**. The device can utilize a test mode to demonstrate when detection occurs to prevent the need to reset the device between trial runs. The probability of successful detection is calculated by:

$$\frac{\text{TotalWaveformDetections}}{\text{TotalWaveformTrials}} \times 100$$



Unless otherwise agreed in writing, this document is issued by the Company subject to its General Conditions of Service printed overleaf, available on request or accessible at <http://www.sgs.com/en/Terms-and-Conditions.aspx> and, for electronic format documents, subject to Terms and Conditions for Electronic Documents at <http://www.sgs.com/en/Terms-and-Conditions/Terms-e-Document.aspx>. Attention is drawn to the limitation of liability, indemnification and jurisdiction issues defined therein. Any holder of this document is advised that information contained hereon reflects the Company's findings at the time of its intervention only and within the limits of Client's instructions, if any. The Company's sole responsibility is to its Client and this document does not exonerate parties to a transaction from exercising all their rights and obligations under the transaction documents. This document cannot be reproduced except in full, without prior written approval of the Company. Any unauthorized alteration, forgery or falsification of the content or appearance of this document is unlawful and offenders may be prosecuted to the fullest extent of the law. Unless otherwise stated the results shown in this test report refer only to the sample(s) tested and such sample(s) are retained for 30 days only.
Attention: To check the authenticity of testing /inspection report & certificate, please contact us at telephone: (86-755) 8307 1443, or email: CN.Doccheck@sgs.com

4.1.9 Applicability of DFS Requirements Prior to Use of a Channel

| Requirement | DFS Operational mode | | |
|---------------------------------|----------------------|--------------------------------|-----------------------------|
| | Master | Client Without Radar Detection | Client With Radar Detection |
| Non-Occupancy Period | Yes | Not required | Yes |
| DFS Detection Threshold | Yes | Not required | Yes |
| Channel Availability Check Time | Yes | Not required | Not required |
| U-NII Detection Bandwidth | Yes | Not required | Yes |

4.1.10 Applicability of DFS Requirements During Normal Operation

| Requirement | DFS Operational mode | |
|---------------------------------|--|--------------------------------|
| | Master Device or Client with Radar Detection | Client Without Radar Detection |
| DFS Detection Threshold | Yes | Not required |
| Channel Availability Check Time | Yes | Yes |
| Channel Move Time | Yes | Yes |
| U-NII Detection Bandwidth | Yes | Not required |

| Additional requirements for devices with multiple bandwidth modes | Master Device or Client with Radar Detection | Client Without Radar Detection |
|---|--|--|
| U-NII Detection Bandwidth and Statistical Performance Check | All BW modes must be tested | Not required |
| Channel Move Time and Channel Closing Transmission Time | Test using widest BW mode available | Test using the widest BW mode available for the link |
| All other tests | Any single BW mode | Not required |

Note: Frequencies selected for statistical performance check (Section 7.8.4) should include several frequencies within the radar detection bandwidth and frequencies near the edge of the radar detection bandwidth. For 802.11 devices it is suggested to select frequencies in each of the bonded 20 MHz channels and the channel center frequency.



Unless otherwise agreed in writing, this document is issued by the Company subject to its General Conditions of Service printed overleaf, available on request or accessible at <http://www.sgs.com/en/Terms-and-Conditions.aspx> and, for electronic format documents, subject to Terms and Conditions for Electronic Documents at <http://www.sgs.com/en/Terms-and-Conditions/Terms-e-Documents.aspx>. Attention is drawn to the limitation of liability, indemnification and jurisdiction issues defined therein. Any holder of this document is advised that information contained herein reflects the Company's findings at the time of its intervention only and within the limits of Client's instructions, if any. The Company's sole responsibility is to its Client and this document does not exonerate parties to a transaction from exercising all their rights and obligations under the transaction documents. This document cannot be reproduced except in full, without prior written approval of the Company. Any unauthorized alteration, forgery or falsification of the content or appearance of this document is unlawful and offenders may be prosecuted to the fullest extent of the law. Unless otherwise stated the results shown in this test report refer only to the sample(s) tested and such sample(s) are retained for 30 days only.

Attention: To check the authenticity of testing / inspection report & certificate, please contact us at telephone: (86-755) 8307 1443, or email: CN.Doccheck@sgs.com

South of No. 6 Plant, No. 1, Runsheng Road, Suzhou Industrial Park, Suzhou Area, China (Jiangsu) Pilot Free Trade Zone 215000 t (86-512) 62992980 www.sgs.com.cn
 中国·苏州·中国(江苏)自由贸易试验区苏州片区苏州工业园区润胜路1号的6号厂房南楼 邮编: 215000 t (86-512) 62992980 sgs.china@sgs.com

4.1.11 DFS Detection Thresholds

| Maximum Transmit Power | Value (See Notes 1, 2, and 3) |
|--|-------------------------------|
| EIRP ≥ 200 milliwatt | -64 dBm |
| EIRP < 200 milliwatt and power spectral density < 10 dBm/MHz | -62 dBm |
| EIRP < 200 milliwatt that do not meet the power spectral density requirement | -64 dBm |

Note 1: This is the level at the input of the receiver assuming a 0 dBi receive antenna.

Note 2: Throughout these test procedures an additional 1 dB has been added to the amplitude of the test transmission waveforms to account for variations in measurement equipment. This will ensure that the test signal is at or above the detection threshold level to trigger a DFS response.

Note3: EIRP is based on the highest antenna gain. For MIMO devices refer to KDB Publication 662911 D01.

4.1.12 Response Requirements

| Parameter | Value |
|-----------------------------------|--|
| Non-occupancy period | Minimum 30 minutes |
| Channel Availability Check Time | 60 seconds |
| Channel Move Time | 10 seconds See Note 1. |
| Channel Closing Transmission Time | 200 milliseconds + an aggregate of 60 milliseconds over remaining 10 second period. See Notes 1 and 2. |
| U-NII Detection Bandwidth | Minimum 100% of the U-NII 99% transmission power bandwidth. See Note 3. |

Note 1: Channel Move Time and the Channel Closing Transmission Time should be performed with Radar Type 0. The measurement timing begins at the end of the Radar Type 0 burst.

Note 2: The Channel Closing Transmission Time is comprised of 200 milliseconds starting at the beginning of the Channel Move Time plus any additional intermittent control signals required to facilitate a Channel move (an aggregate of 60 milliseconds) during the remainder of the 10 second period. The aggregate duration of control signals will not count quiet periods in between transmissions.

Note 3: During the U-NII Detection Bandwidth detection test, radar type 0 should be used. For each frequency step the minimum percentage of detection is 90 percent. Measurements are performed with no data traffic.



Unless otherwise agreed in writing, this document is issued by the Company subject to its General Conditions of Service printed overleaf, available on request or accessible at <http://www.sgs.com/en/Terms-and-Conditions.aspx> and, for electronic format documents, subject to Terms and Conditions for Electronic Documents at <http://www.sgs.com/en/Terms-and-Conditions/Terms-e-Documents.aspx>. Attention is drawn to the limitation of liability, indemnification and jurisdiction issues defined therein. Any holder of this document is advised that information contained hereon reflects the Company's findings at the time of its intervention only and within the limits of Client's instructions, if any. The Company's sole responsibility is to its Client and this document does not exonerate parties to a transaction from exercising all their rights and obligations under the transaction documents. This document cannot be reproduced except in full, without prior written approval of the Company. Any unauthorized alteration, forgery or falsification of the content or appearance of this document is unlawful and offenders may be prosecuted to the fullest extent of the law. Unless otherwise stated the results shown in this test report refer only to the sample(s) tested and such sample(s) are retained for 30 days only.

Attention: To check the authenticity of testing /inspection report & certificate, please contact us at telephone: (86-755) 8307 1443, or email: CN.Doccheck@sgs.com

4.1.13 Short Pulse Radar Test Waveforms

| Radar Type | Pulse Width (µsec) | PRI(µsec) | Number of Pulses | Minimum Percentage of Successful Detection | Minimum Number of Trials |
|--|--------------------|---|--|--|--------------------------|
| 0 | 1 | 1428 | 18 | See Note 1 | See Note 1 |
| 1 | 1 | Test A: 15 unique PRI values randomly selected from the list of 23 PRI values in Table 5a | Roundup $\left\{ \left(\frac{1}{360} \right) \cdot \left(\frac{19 \cdot 10^6}{PRI_{\mu sec}} \right) \right\}$ | 60% | 30 |
| | | Test B: 15 unique PRI values randomly selected within the range of 518-3066 µsec, with a minimum increment of 1 µsec, excluding PRI values selected in Test A | | | |
| 2 | 1-5 | 150-230 | 23-29 | 60% | 30 |
| 3 | 6-10 | 200-500 | 16-18 | 60% | 30 |
| 4 | 11-20 | 200-500 | 12-16 | 60% | 30 |
| Aggregate (Radar Types 1-4) | | | | 80% | 120 |
| Note 1: Short Pulse Radar Type 0 should be used for the detection bandwidth test, channel move time, and channel closing time tests. | | | | | |

A minimum of 30 unique waveforms are required for each of the Short Pulse Radar Types 2 through 4. If more than 30 waveforms are used for Short Pulse Radar Types 2 through 4, then each additional waveform must also be unique and not repeated from the previous waveforms. If more than 30 waveforms are used for Short Pulse Radar Type 1, then each additional waveform is generated with Test B and must also be unique and not repeated from the previous waveforms in Tests A or B.

For example if in Short Pulse Radar Type 1 Test B a PRI of 3066 µsec is selected, the number of pulses

would be $6 \cdot 1 \cdot 19 \cdot 10 \cdot \text{Roundup} \left\{ \left(\frac{1}{360} \right) \cdot \left(\frac{19 \cdot 10^6}{3066} \right) \right\} \text{Round up } \{17.2\} = 18.$



Unless otherwise agreed in writing, this document is issued by the Company subject to its General Conditions of Service printed overleaf, available on request or accessible at <http://www.sgs.com/en/Terms-and-Conditions.aspx> and, for electronic format documents, subject to Terms and Conditions for Electronic Documents at <http://www.sgs.com/en/Terms-and-Conditions/Terms-e-Documents.aspx>. Attention is drawn to the limitation of liability, indemnification and jurisdiction issues defined therein. Any holder of this document is advised that information contained herein reflects the Company's findings at the time of its intervention only and within the limits of Client's instructions, if any. The Company's sole responsibility is to its Client and this document does not exonerate parties to a transaction from exercising all their rights and obligations under the transaction documents. This document cannot be reproduced except in full, without prior written approval of the Company. Any unauthorized alteration, forgery or falsification of the content or appearance of this document is unlawful and offenders may be prosecuted to the fullest extent of the law. Unless otherwise stated the results shown in this test report refer only to the sample(s) tested and such sample(s) are retained for 30 days only.
 Attention: To check the authenticity of testing /inspection report & certificate, please contact us at telephone: (86-755) 8307 1443, or email: QN.Doccheck@sgs.com

South of No. 6 Plant, No. 1, Runsheng Road, Suzhou Industrial Park, Suzhou Area, China (Jiangsu) Pilot Free Trade Zone 215000 t (86-512) 62992980 www.sgs.com.cn
 中国·苏州·中国 (江苏) 自由贸易试验区苏州片区苏州工业园区润胜路1号的6号厂房南楼 邮编: 215000 t (86-512) 62992980 sgs.china@sgs.com

Table 5a - Pulse Repetition Intervals Values for Test A

| Pulse Repetition Frequency Number | Pulse Repetition Frequency (Pulses Per Second) | Pulse Repetition Interval (Microseconds) |
|-----------------------------------|--|--|
| 1 | 1930.5 | 518 |
| 2 | 1858.7 | 538 |
| 3 | 1792.1 | 558 |
| 4 | 1730.1 | 578 |
| 5 | 1672.2 | 598 |
| 6 | 1618.1 | 618 |
| 7 | 1567.4 | 638 |
| 8 | 1519.8 | 658 |
| 9 | 1474.9 | 678 |
| 10 | 1432.7 | 698 |
| 11 | 1392.8 | 718 |
| 12 | 1355 | 738 |
| 13 | 1319.3 | 758 |
| 14 | 1285.3 | 778 |
| 15 | 1253.1 | 798 |
| 16 | 1222.5 | 818 |
| 17 | 1193.3 | 838 |
| 18 | 1165.6 | 858 |
| 19 | 1139 | 878 |
| 20 | 1113.6 | 898 |
| 21 | 1089.3 | 918 |
| 22 | 1066.1 | 938 |
| 23 | 326.2 | 3066 |

The aggregate is the average of the percentage of successful detections of Short Pulse Radar Types 1-4. For example, the following table indicates how to compute the aggregate of percentage of successful detections.

| Radar Type | Number of Trials | Number of Successful Detections | Minimum Percentage of Successful Detection |
|---|------------------|---------------------------------|--|
| 1 | 35 | 29 | 82.9% |
| 2 | 30 | 18 | 60% |
| 3 | 30 | 27 | 90% |
| 4 | 50 | 44 | 88% |
| Aggregate (82.9% + 60% + 90% + 88%)/4 = 80.2% | | | |



Unless otherwise agreed in writing, this document is issued by the Company subject to its General Conditions of Service printed overleaf, available on request or accessible at <http://www.sgs.com/en/Terms-and-Conditions.aspx> and, for electronic format documents, subject to Terms and Conditions for Electronic Documents at <http://www.sgs.com/en/Terms-and-Conditions/Terms-e-Documents.aspx>. Attention is drawn to the limitation of liability, indemnification and jurisdiction issues defined therein. Any holder of this document is advised that information contained herein reflects the Company's findings at the time of its intervention only and within the limits of Client's instructions, if any. The Company's sole responsibility is to its Client and this document does not exonerate parties to a transaction from exercising all their rights and obligations under the transaction documents. This document cannot be reproduced except in full, without prior written approval of the Company. Any unauthorized alteration, forgery or falsification of the content or appearance of this document is unlawful and offenders may be prosecuted to the fullest extent of the law. Unless otherwise stated the results shown in this test report refer only to the sample(s) tested and such sample(s) are retained for 30 days only.

Attention: To check the authenticity of testing / inspection report & certificate, please contact us at telephone: (86-755) 8307 1443, or email: QN.Doccheck@sgs.com
 South of No. 6 Plant, No. 1, Runsheng Road, Suzhou Industrial Park, Suzhou Area, China (Jiangsu) Pilot Free Trade Zone 215000 t (86-512) 62992980 www.sgs.com.cn
 中国·苏州·中国 (江苏) 自由贸易试验区苏州片区苏州工业园区润胜路1号的6号厂房南楼 邮编: 215000 t (86-512) 62992980 sgs.china@sgs.com

4.1.14 Long Pulse Radar Test Waveform

| Radar Type | Pulse Width (μsec) | Chirp Width (MHz) | PRI (μsec) | Number of Pulses per Burst | Number of Bursts | Minimum Percentage of Successful Detection | Minimum Number of Trials |
|------------|--------------------|-------------------|------------|----------------------------|------------------|--|--------------------------|
| 5 | 50-100 | 5-20 | 1000-2000 | 1-3 | 8-20 | 80% | 30 |

Each waveform is defined as follows:

- 1) The transmission period for the Long Pulse Radar test signal is 12 seconds.
- 2) There are a total of 8 to 20 Bursts in the 12 second period, with the number of Bursts being randomly chosen. This number is Burst Count.
- 3) Each Burst consists of 1 to 3 pulses, with the number of pulses being randomly chosen. Each Burst within the 12 second sequence may have a different number of pulses.
- 4) The pulse width is between 50 and 100 microseconds, with the pulse width being randomly chosen. Each pulse within a Burst will have the same pulse width. Pulses in different Bursts may have different pulse widths.
- 5) Each pulse has a linear frequency modulated chirp between 5 and 20 MHz, with the chirp width being randomly chosen. Each pulse within a transmission period will have the same chirp width. The chirp is centered on the pulse. For example, with a radar frequency of 5300 MHz and a 20 MHz chirped signal, the chirp starts at 5290 MHz and ends at 5310 MHz.
- 6) If more than one pulse is present in a Burst, the time between the pulses will be between 1000 and 2000 microseconds, with the time being randomly chosen. If three pulses are present in a Burst, the random time interval between the first and second pulses is chosen independently of the random time interval between the second and third pulses.
- 7) The 12 second transmission period is divided into even intervals. The number of intervals is equal to Burst Count. Each interval is of length $(12,000,000 / \text{Burst Count})$ microseconds. Each interval contains one Burst. The start time for the Burst, relative to the beginning of the interval, is between 1 and $[(12,000,000 / \text{Burst Count}) - (\text{Total Burst Length}) + (\text{One Random PRI Interval})]$ microseconds, with the start time being randomly chosen. The step interval for the start time is 1 microsecond. The start time for each Burst is chosen randomly.

4.1.15 Frequency Hopping Radar Test Waveform

| Radar Type | Pulse Width (μsec) | Chirp Width (MHz) | PRI (μsec) | Number of Pulses per Burst | Number of Bursts | Minimum Percentage of Successful Detection | Minimum Number of Trials |
|------------|--------------------|-------------------|------------|----------------------------|------------------|--|--------------------------|
| 6 | 1 | 333 | 9 | 0.333 | 300 | 70% | 30 |

For the Frequency Hopping Radar Type, the same Burst parameters are used for each waveform. The hopping sequence is different for each waveform and a 100-length segment is selected from the hopping sequence defined by the following algorithm: If a segment does not contain at least 1 frequency within the U-NII Detection Bandwidth of the UUT, then that segment is not used.

The detailed test data see: **Appendix**



Unless otherwise agreed in writing, this document is issued by the Company subject to its General Conditions of Service printed overleaf, available on request or accessible at <http://www.sgs.com/en/Terms-and-Conditions.aspx> and, for electronic format documents, subject to Terms and Conditions for Electronic Documents at <http://www.sgs.com/en/Terms-and-Conditions/Terms-e-Documents.aspx>. Attention is drawn to the limitation of liability, indemnification and jurisdiction issues defined therein. Any holder of this document is advised that information contained hereon reflects the Company's findings at the time of its intervention only and within the limits of Client's instructions, if any. The Company's sole responsibility is to its Client and this document does not exonerate parties to a transaction from exercising all their rights and obligations under the transaction documents. This document cannot be reproduced except in full, without prior written approval of the Company. Any unauthorized alteration, forgery or falsification of the content or appearance of this document is unlawful and offenders may be prosecuted to the fullest extent of the law. Unless otherwise stated the results shown in this test report refer only to the sample(s) tested and such sample(s) are retained for 30 days only.

Attention: To check the authenticity of testing / inspection report & certificate, please contact us at telephone: (86-755) 8307 1443, or email: QN.Doccheck@sgs.com

South of No. 6 Plant, No. 1, Runsheng Road, Suzhou Industrial Park, Suzhou Area, China (Jiangsu) Pilot Free Trade Zone 215000 t (86-512) 62992980 www.sgs.com.cn
 中国·苏州·中国(江苏)自由贸易试验区苏州片区苏州工业园区润胜路1号的6号厂房南楼 邮编: 215000 t (86-512) 62992980 sgs.china@sgs.com

5 Measurement Uncertainty (95% confidence levels, k=2)

| No. | Item | Measurement Uncertainty |
|---|-----------------|-------------------------|
| 1 | Radio Frequency | ±1.0 % |
| Remark: The U_{lab} (lab Uncertainty) is less than $U_{CISPR/ETSI}$ (CISPR/ETSI Uncertainty), so the test results – compliance is deemed to occur if no measured disturbance level exceeds the disturbance limit; – non-compliance is deemed to occur if any measured disturbance level exceeds the disturbance limit. | | |



Unless otherwise agreed in writing, this document is issued by the Company subject to its General Conditions of Service printed overleaf, available on request or accessible at <http://www.sgs.com/en/Terms-and-Conditions.aspx> and, for electronic format documents, subject to Terms and Conditions for Electronic Documents at <http://www.sgs.com/en/Terms-and-Conditions/Terms-e-Documents.aspx>. Attention is drawn to the limitation of liability, indemnification and jurisdiction issues defined therein. Any holder of this document is advised that information contained herein reflects the Company's findings at the time of its intervention only and within the limits of Client's instructions, if any. The Company's sole responsibility is to its Client and this document does not exonerate parties to a transaction from exercising all their rights and obligations under the transaction documents. This document cannot be reproduced except in full, without prior written approval of the Company. Any unauthorized alteration, forgery or falsification of the content or appearance of this document is unlawful and offenders may be prosecuted to the fullest extent of the law. Unless otherwise stated the results shown in this test report refer only to the sample(s) tested and such sample(s) are retained for 30 days only.

Attention: To check the authenticity of testing /inspection report & certificate, please contact us at telephone: (86-755) 8307 1443, or email: QN.Doccheck@sgs.com

6 Equipment List

| RF Test Equipment | | | | | |
|-------------------------------------|----------------|------------------------------|---------------|---------------------------|------------------------------|
| Test Equipment | Manufacturer | Model No. | Inventory No. | Cal. date (yyyy/mm/dd) | Cal.Due date (yyyy/mm/dd) |
| Shielding Room | Brilliant-emc | N/A | SUWI-04-01-06 | 2021/05/08 | 2024/05/07 |
| Temperature and humidity meter | MingGao | TH101B | SUWI-01-01-07 | 2023/02/06 | 2024/02/05 |
| Signal Analyzer | ROHDE& SCHWARZ | FSV3030 | SUWI-01-02-02 | 2022/05/17 | 2023/05/16 |
| | | | | 2023/05/11 | 2024/05/10 |
| Measurement Software | Tonscend | JS1120-3 Test System V3.1.55 | SUWI-02-09-09 | NCR | NCR |
| Signal Analyzer | ROHDE& SCHWARZ | FSW43 | SUWI-01-02-04 | 2022/05/28 | 2023/05/27 |
| Wideband Radio Communication Tester | ROHDE& SCHWARZ | CMW500 | SUWI-01-16-05 | 2023/02/06 | 2024/02/05 |
| DC Power Supply | HYELEC | HY3005B | SUWI-01-18-01 | 2023/02/06 | 2024/02/05 |
| Power meter | Anritsu | ML2495A | SUWI-01-31-01 | 2022/11/23 | 2023/11/22 |
| Pulse power sensor | Anritsu | MA2411B | SUWI-01-32-01 | 2022/11/23 | 2023/11/22 |
| MXG Vector signal genitor | KEYSIGHT | N5182B | SUWI-01-38-01 | 2023/02/06 | 2024/02/05 |
| Temperature Chamber | ESPEC | SU-242 | SUWI-01-13-01 | 2023/02/06 | 2024/02/05 |
| Signal Generator | ROHDE&SCHWARZ | SMM100A | SN:101716 | 2023/02/22 | 2024/02/21 |



Unless otherwise agreed in writing, this document is issued by the Company subject to its General Conditions of Service printed overleaf, available on request or accessible at <http://www.sgs.com/en/Terms-and-Conditions.aspx> and, for electronic format documents, subject to Terms and Conditions for Electronic Documents at <http://www.sgs.com/en/Terms-and-Conditions/Terms-e-Documents.aspx>. Attention is drawn to the limitation of liability, indemnification and jurisdiction issues defined therein. Any holder of this document is advised that information contained hereon reflects the Company's findings at the time of its intervention only and within the limits of Client's instructions, if any. The Company's sole responsibility is to its Client and this document does not exonerate parties to a transaction from exercising all their rights and obligations under the transaction documents. This document cannot be reproduced except in full, without prior written approval of the Company. Any unauthorized alteration, forgery or falsification of the content or appearance of this document is unlawful and offenders may be prosecuted to the fullest extent of the law. Unless otherwise stated the results shown in this test report refer only to the sample(s) tested and such sample(s) are retained for 30 days only.

Attention: To check the authenticity of testing /inspection report & certificate, please contact us at telephone: (86-755) 8307 1443, or email: QN.Doccheck@sgs.com

7 Photographs - Setup Photos

Refer to Appendix A.2 WLAN Setup Photos.



Unless otherwise agreed in writing, this document is issued by the Company subject to its General Conditions of Service printed overleaf, available on request or accessible at <http://www.sgs.com/en/Terms-and-Conditions.aspx> and, for electronic format documents, subject to Terms and Conditions for Electronic Documents at <http://www.sgs.com/en/Terms-and-Conditions/Terms-e-Documents.aspx>. Attention is drawn to the limitation of liability, indemnification and jurisdiction issues defined therein. Any holder of this document is advised that information contained hereon reflects the Company's findings at the time of its intervention only and within the limits of Client's instructions, if any. The Company's sole responsibility is to its Client and this document does not exonerate parties to a transaction from exercising all their rights and obligations under the transaction documents. This document cannot be reproduced except in full, without prior written approval of the Company. Any unauthorized alteration, forgery or falsification of the content or appearance of this document is unlawful and offenders may be prosecuted to the fullest extent of the law. Unless otherwise stated the results shown in this test report refer only to the sample(s) tested and such sample(s) are retained for 30 days only.

Attention: To check the authenticity of testing /inspection report & certificate, please contact us at telephone: (86-755) 8307 1443, or email: CN.Doccheck@sgs.com



Report No.: SEWA2303000041RG06
Rev.: 01
Page: 26 of 104

Appendix



Unless otherwise agreed in writing, this document is issued by the Company subject to its General Conditions of Service printed overleaf, available on request or accessible at <http://www.sgs.com/en/Terms-and-Conditions.aspx> and, for electronic format documents, subject to Terms and Conditions for Electronic Documents at <http://www.sgs.com/en/Terms-and-Conditions/Terms-e-Documents.aspx>. Attention is drawn to the limitation of liability, indemnification and jurisdiction issues defined therein. Any holder of this document is advised that information contained hereon reflects the Company's findings at the time of its intervention only and within the limits of Client's instructions, if any. The Company's sole responsibility is to its Client and this document does not exonerate parties to a transaction from exercising all their rights and obligations under the transaction documents. This document cannot be reproduced except in full, without prior written approval of the Company. Any unauthorized alteration, forgery or falsification of the content or appearance of this document is unlawful and offenders may be prosecuted to the fullest extent of the law. Unless otherwise stated the results shown in this test report refer only to the sample(s) tested and such sample(s) are retained for 30 days only.

Attention: To check the authenticity of testing /inspection report & certificate, please contact us at telephone: (86-755) 8307 1443, or email: QN.Doccheck@sgs.com
South of No. 6 Plant, No. 1, Runsheng Road, Suzhou Industrial Park, Suzhou Area, China (Jiangsu) Pilot Free Trade Zone 215000 t (86-512) 62992980 www.sgs.com.cn
中国·苏州·中国(江苏)自由贸易试验区苏州片区苏州工业园区润胜路1号的6号厂房南楼 邮编: 215000 t (86-512) 62992980 sgs.china@sgs.com

**DFS Detection Thresholds
Test Result**

| TestMode | Frequency[dbm] | Radar Type | Result | Gain | Limit[dbm] | Verdict |
|-------------|----------------|------------|--------|------|------------|---------|
| 11ax160MIMO | 5570 | Type0 | -60.98 | 1.28 | -60.72 | PASS |
| | | Type1 | -60.98 | 1.28 | -60.72 | PASS |
| | | Type2 | -60.91 | 1.28 | -60.72 | PASS |
| | | Type3 | -60.83 | 1.28 | -60.72 | PASS |
| | | Type4 | -60.84 | 1.28 | -60.72 | PASS |
| | | Type5 | -60.94 | 1.28 | -60.72 | PASS |
| | | Type6 | -61.13 | 1.28 | -60.72 | PASS |



Unless otherwise agreed in writing, this document is issued by the Company subject to its General Conditions of Service printed overleaf, available on request or accessible at <http://www.sgs.com/en/Terms-and-Conditions.aspx> and, for electronic format documents, subject to Terms and Conditions for Electronic Documents at <http://www.sgs.com/en/Terms-and-Conditions/Terms-e-Documents.aspx>. Attention is drawn to the limitation of liability, indemnification and jurisdiction issues defined therein. Any holder of this document is advised that information contained hereon reflects the Company's findings at the time of its intervention only and within the limits of Client's instructions, if any. The Company's sole responsibility is to its Client and this document does not exonerate parties to a transaction from exercising all their rights and obligations under the transaction documents. This document cannot be reproduced except in full, without prior written approval of the Company. Any unauthorized alteration, forgery or falsification of the content or appearance of this document is unlawful and offenders may be prosecuted to the fullest extent of the law. Unless otherwise stated the results shown in this test report refer only to the sample(s) tested and such sample(s) are retained for 30 days only.

Attention: To check the authenticity of testing /inspection report & certificate, please contact us at telephone: (86-755) 8307 1443, or email: QN.Doccheck@sgs.com

Test Graphs

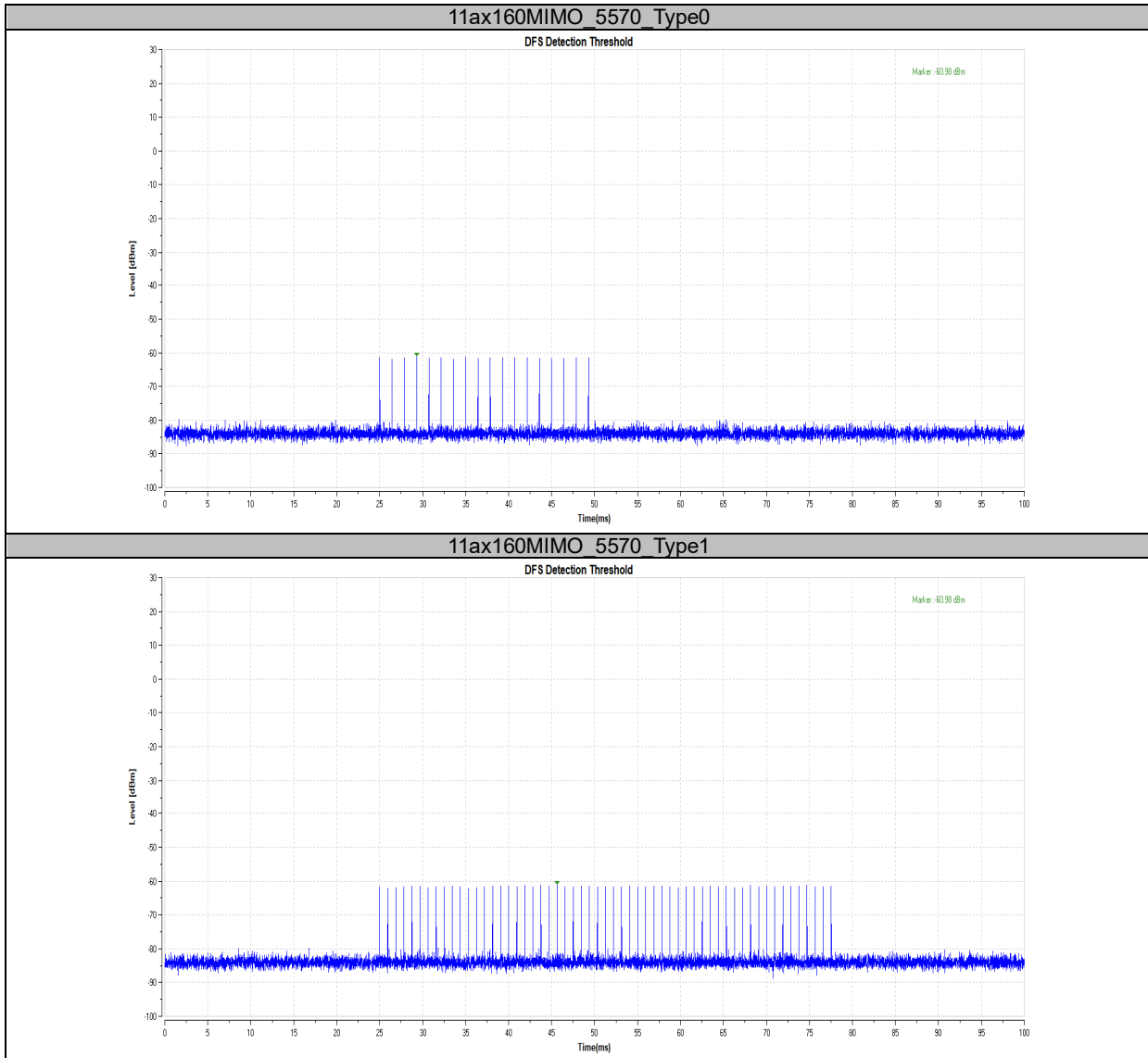

Unless otherwise agreed in writing, this document is issued by the Company subject to its General Conditions of Service printed overleaf, available on request or accessible at <http://www.sgs.com/en/Terms-and-Conditions.aspx> and, for electronic format documents, subject to Terms and Conditions for Electronic Documents at <http://www.sgs.com/en/Terms-and-Conditions/Terms-e-Documents.aspx>. Attention is drawn to the limitation of liability, indemnification and jurisdiction issues defined therein. Any holder of this document is advised that information contained hereon reflects the Company's findings at the time of its intervention only and within the limits of Client's instructions, if any. The Company's sole responsibility is to its Client and this document does not exonerate parties to a transaction from exercising all their rights and obligations under the transaction documents. This document cannot be reproduced except in full, without prior written approval of the Company. Any unauthorized alteration, forgery or falsification of the content or appearance of this document is unlawful and offenders may be prosecuted to the fullest extent of the law. Unless otherwise stated the results shown in this test report refer only to the sample(s) tested and such sample(s) are retained for 30 days only.

Attention: To check the authenticity of testing /inspection report & certificate, please contact us at telephone: (86-755) 8307 1443, or email: QN.Doccheck@sgs.com

| | | | |
|--|------------|---------------------|--|
| South of No. 6 Plant, No. 1, Runsheng Road, Suzhou Industrial Park, Suzhou Area, China (Jiangsu) Pilot Free Trade Zone | 215000 | t (86-512) 62992980 | www.sgs.com |
| 中国·苏州·中国 (江苏) 自由贸易试验区苏州片区苏州工业园区润胜路1号的6号厂房南面 | 邮编: 215000 | t (86-512) 62992980 | sgs.china@sgs.com |

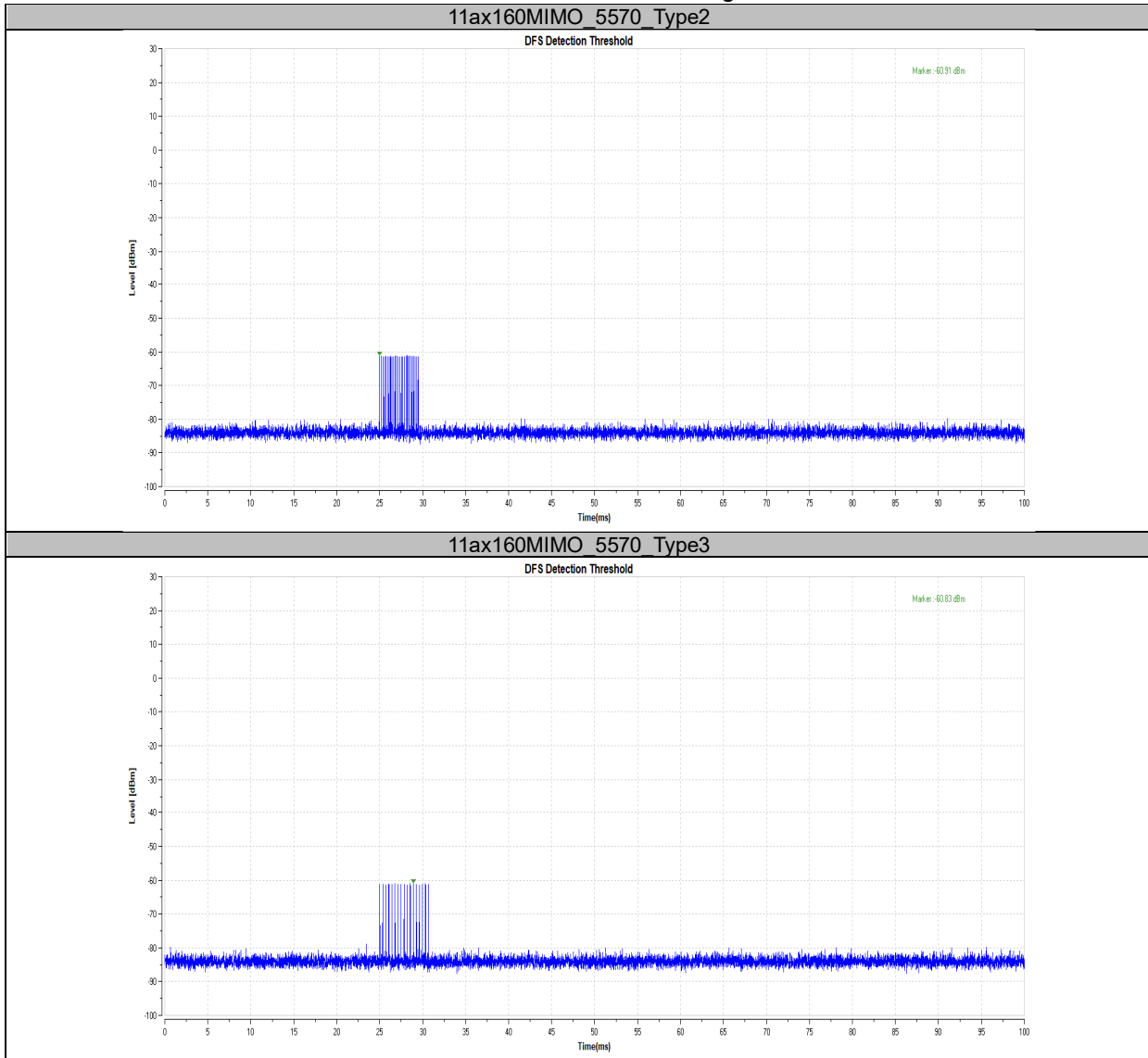

Unless otherwise agreed in writing, this document is issued by the Company subject to its General Conditions of Service printed overleaf, available on request or accessible at <http://www.sgs.com/en/Terms-and-Conditions.aspx> and, for electronic format documents, subject to Terms and Conditions for Electronic Documents at <http://www.sgs.com/en/Terms-and-Conditions/Terms-e-Documents.aspx>. Attention is drawn to the limitation of liability, indemnification and jurisdiction issues defined therein. Any holder of this document is advised that information contained hereon reflects the Company's findings at the time of its intervention only and within the limits of Client's instructions, if any. The Company's sole responsibility is to its Client and this document does not exonerate parties to a transaction from exercising all their rights and obligations under the transaction documents. This document cannot be reproduced except in full, without prior written approval of the Company. Any unauthorized alteration, forgery or falsification of the content or appearance of this document is unlawful and offenders may be prosecuted to the fullest extent of the law. Unless otherwise stated the results shown in this test report refer only to the sample(s) tested and such sample(s) are retained for 30 days only.

Attention: To check the authenticity of testing /inspection report & certificate, please contact us at telephone: (86-755) 8307 1443, or email: QN.Doccheck@sgs.com

South of No. 6 Plant, No. 1, Runsheng Road, Suzhou Industrial Park, Suzhou Area, China (Jiangsu) Pilot Free Trade Zone 215000 t (86-512) 62992980 www.sgs.com.cn
 中国·苏州·中国 (江苏) 自由贸易试验区苏州片区苏州工业园区润胜路1号的6号厂房南楼 邮编: 215000 t (86-512) 62992980 sgs.china@sgs.com

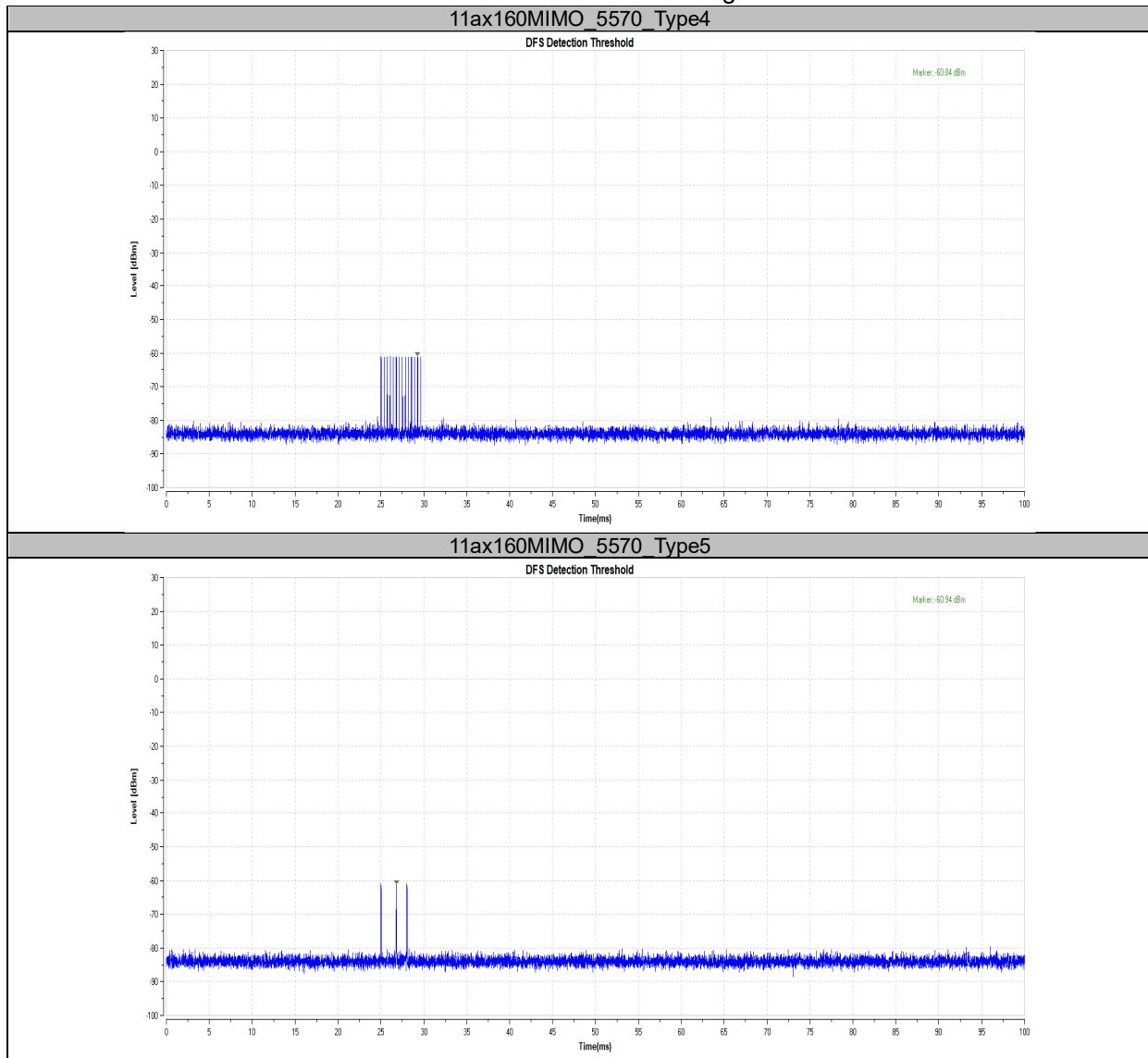

Unless otherwise agreed in writing, this document is issued by the Company subject to its General Conditions of Service printed overleaf, available on request or accessible at <http://www.sgs.com/en/Terms-and-Conditions.aspx> and, for electronic format documents, subject to Terms and Conditions for Electronic Documents at <http://www.sgs.com/en/Terms-and-Conditions/Terms-e-Documents.aspx>. Attention is drawn to the limitation of liability, indemnification and jurisdiction issues defined therein. Any holder of this document is advised that information contained hereon reflects the Company's findings at the time of its intervention only and within the limits of Client's instructions, if any. The Company's sole responsibility is to its Client and this document does not exonerate parties to a transaction from exercising all their rights and obligations under the transaction documents. This document cannot be reproduced except in full, without prior written approval of the Company. Any unauthorized alteration, forgery or falsification of the content or appearance of this document is unlawful and offenders may be prosecuted to the fullest extent of the law. Unless otherwise stated the results shown in this test report refer only to the sample(s) tested and such sample(s) are retained for 30 days only.

Attention: To check the authenticity of testing /inspection report & certificate, please contact us at telephone: (86-755) 8307 1443, or email: QN.Doccheck@sgs.com

South of No. 6 Plant, No. 1, Runsheng Road, Suzhou Industrial Park, Suzhou Area, China (Jiangsu) Pilot Free Trade Zone 215000 t (86-512) 62992980 www.sgsgroup.com.cn
 中国·苏州·中国 (江苏) 自由贸易试验区苏州片区苏州工业园区润胜路1号的6号厂房南楼 邮编: 215000 t (86-512) 62992980 sgs.china@sgs.com

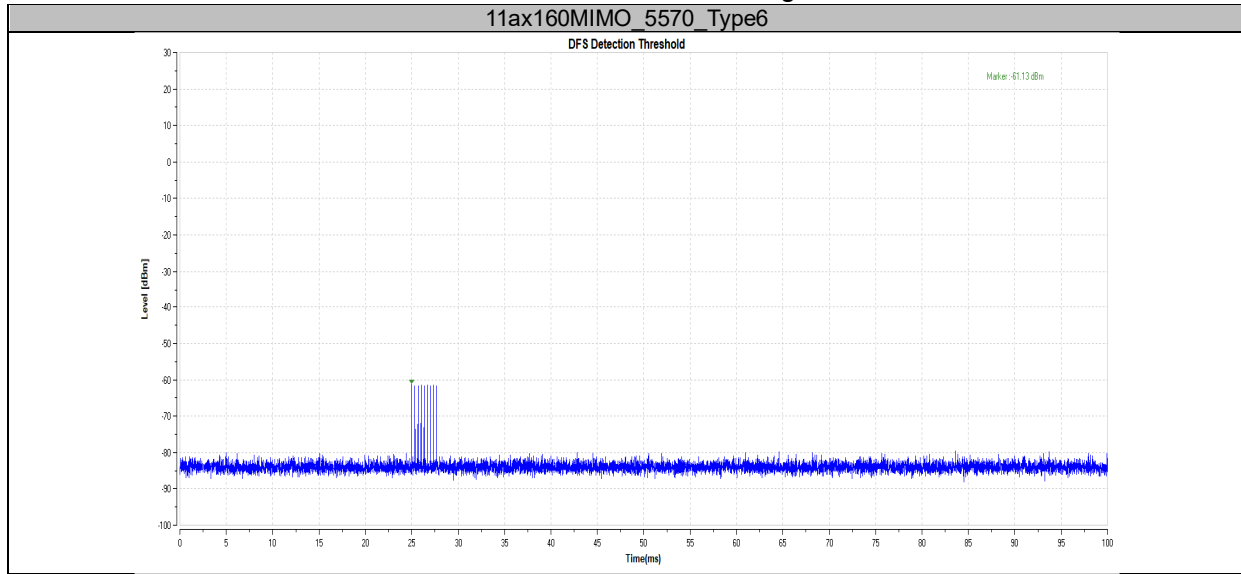

Unless otherwise agreed in writing, this document is issued by the Company subject to its General Conditions of Service printed overleaf, available on request or accessible at <http://www.sgs.com/en/Terms-and-Conditions.aspx> and, for electronic format documents, subject to Terms and Conditions for Electronic Documents at <http://www.sgs.com/en/Terms-and-Conditions/Terms-e-Documents.aspx>. Attention is drawn to the limitation of liability, indemnification and jurisdiction issues defined therein. Any holder of this document is advised that information contained hereon reflects the Company's findings at the time of its intervention only and within the limits of Client's instructions, if any. The Company's sole responsibility is to its Client and this document does not exonerate parties to a transaction from exercising all their rights and obligations under the transaction documents. This document cannot be reproduced except in full, without prior written approval of the Company. Any unauthorized alteration, forgery or falsification of the content or appearance of this document is unlawful and offenders may be prosecuted to the fullest extent of the law. Unless otherwise stated the results shown in this test report refer only to the sample(s) tested and such sample(s) are retained for 30 days only.

Attention: To check the authenticity of testing /inspection report & certificate, please contact us at telephone: (86-755) 8307 1443, or email: CN.Doccheck@sgs.com



Data Traffic Plot Test Graphs

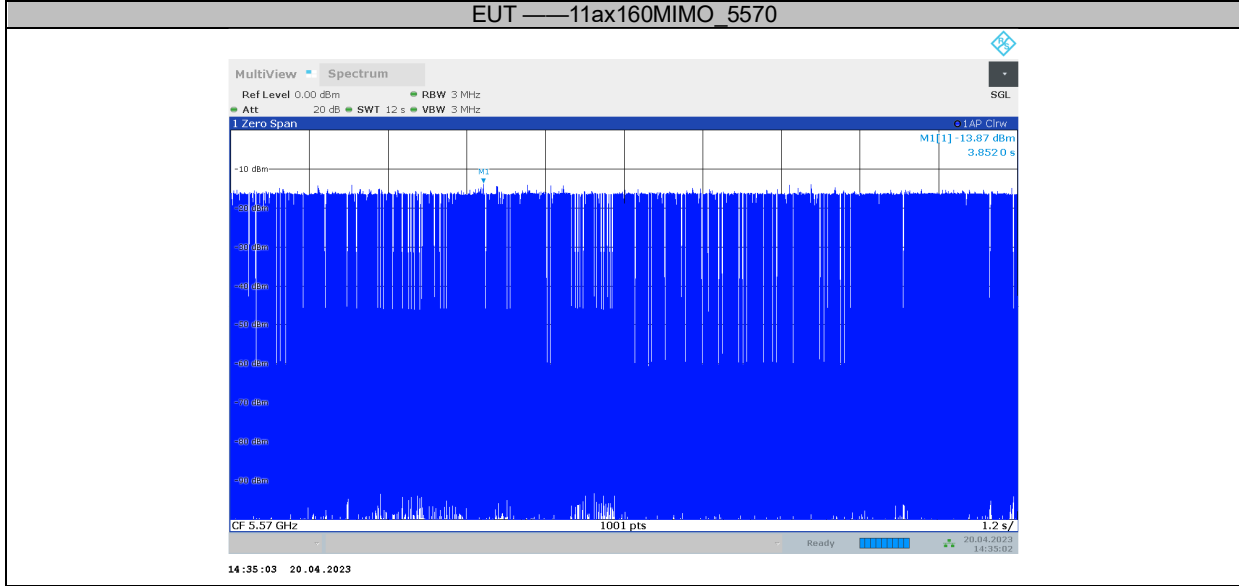

Unless otherwise agreed in writing, this document is issued by the Company subject to its General Conditions of Service printed overleaf, available on request or accessible at <http://www.sgs.com/en/Terms-and-Conditions.aspx> and, for electronic format documents, subject to Terms and Conditions for Electronic Documents at <http://www.sgs.com/en/Terms-and-Conditions/Terms-e-Documents.aspx>. Attention is drawn to the limitation of liability, indemnification and jurisdiction issues defined therein. Any holder of this document is advised that information contained hereon reflects the Company's findings at the time of its intervention only and within the limits of Client's instructions, if any. The Company's sole responsibility is to its Client and this document does not exonerate parties to a transaction from exercising all their rights and obligations under the transaction documents. This document cannot be reproduced except in full, without prior written approval of the Company. Any unauthorized alteration, forgery or falsification of the content or appearance of this document is unlawful and offenders may be prosecuted to the fullest extent of the law. Unless otherwise stated the results shown in this test report refer only to the sample(s) tested and such sample(s) are retained for 30 days only.

Attention: To check the authenticity of testing /inspection report & certificate, please contact us at telephone: (86-755) 8307 1443, or email: QN.Doccheck@sgs.com

| | | | |
|--|------------|---------------------|--|
| South of No. 6 Plant, No. 1, Runsheng Road, Suzhou Industrial Park, Suzhou Area, China (Jiangsu) Pilot Free Trade Zone | 215000 | t (86-512) 62992980 | www.sgs.com |
| 中国·苏州·中国(江苏)自由贸易试验区苏州片区苏州工业园区润胜路1号的6号厂房南面 | 邮编: 215000 | t (86-512) 62992980 | sgs.china@sgs.com |

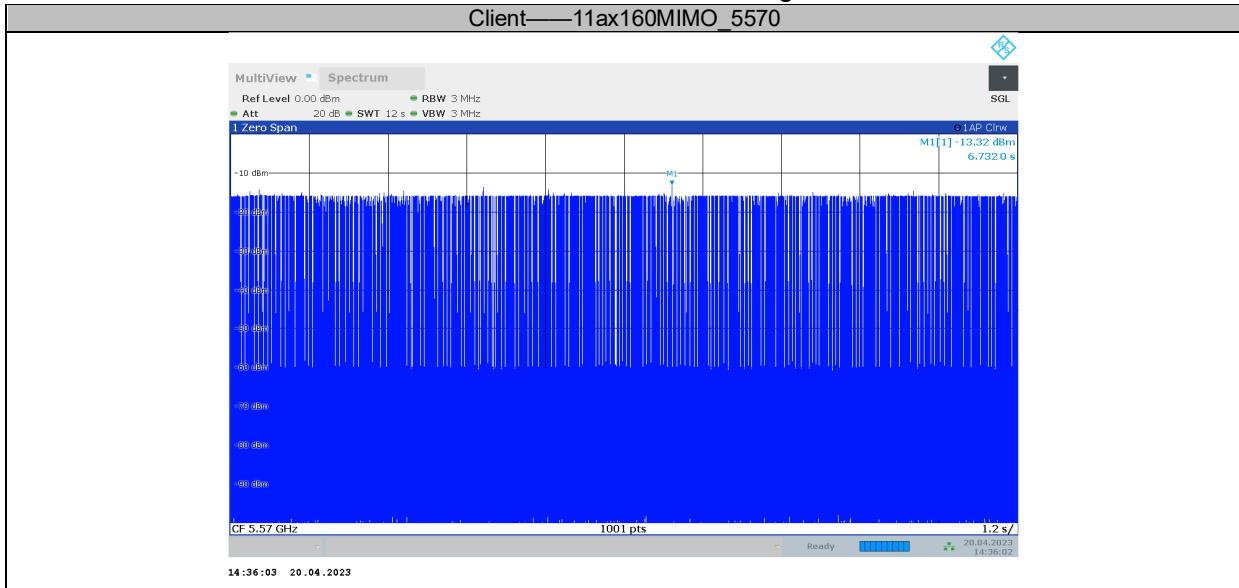

Unless otherwise agreed in writing, this document is issued by the Company subject to its General Conditions of Service printed overleaf, available on request or accessible at <http://www.sgs.com/en/Terms-and-Conditions.aspx> and, for electronic format documents, subject to Terms and Conditions for Electronic Documents at <http://www.sgs.com/en/Terms-and-Conditions/Terms-e-Documents.aspx>. Attention is drawn to the limitation of liability, indemnification and jurisdiction issues defined therein. Any holder of this document is advised that information contained hereon reflects the Company's findings at the time of its intervention only and within the limits of Client's instructions, if any. The Company's sole responsibility is to its Client and this document does not exonerate parties to a transaction from exercising all their rights and obligations under the transaction documents. This document cannot be reproduced except in full, without prior written approval of the Company. Any unauthorized alteration, forgery or falsification of the content or appearance of this document is unlawful and offenders may be prosecuted to the fullest extent of the law. Unless otherwise stated the results shown in this test report refer only to the sample(s) tested and such sample(s) are retained for 30 days only.

Attention: To check the authenticity of testing /inspection report & certificate, please contact us at telephone: (86-755) 8307 1443, or email: QN.Doccheck@sgs.com

South of No. 6 Plant, No. 1, Runsheng Road, Suzhou Industrial Park, Suzhou Area, China (Jiangsu) Pilot Free Trade Zone 215000 t (86-512) 62992980 www.sgsgroup.com.cn
 中国·苏州·中国(江苏)自由贸易试验区苏州片区苏州工业园区润胜路1号的6号厂房南楼 邮编: 215000 t (86-512) 62992980 sgs.china@sgs.com

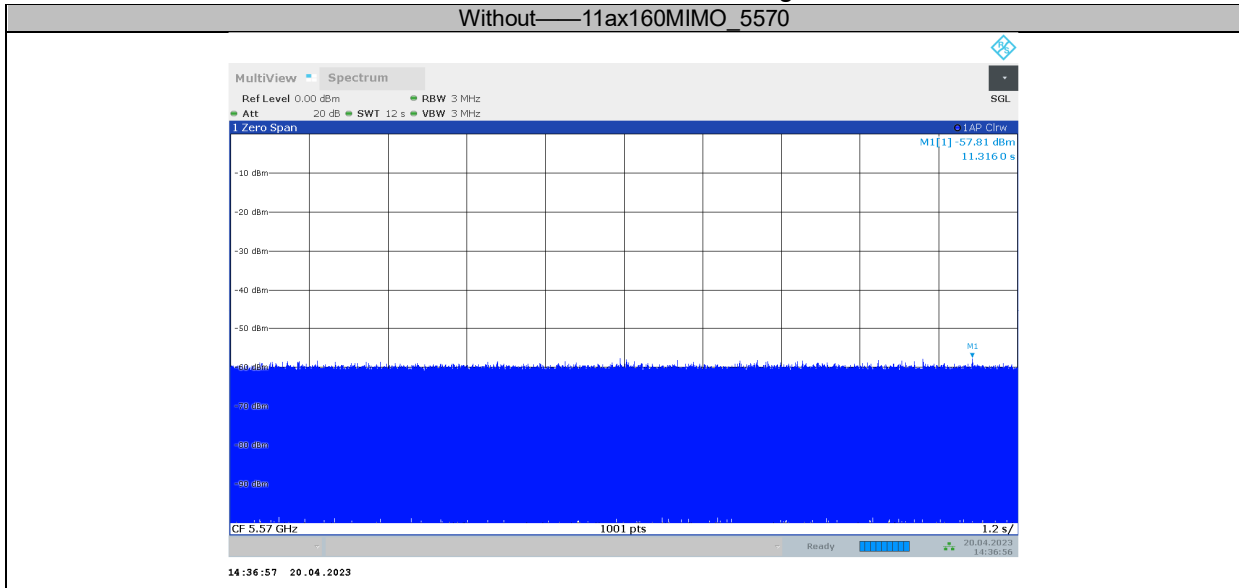

Unless otherwise agreed in writing, this document is issued by the Company subject to its General Conditions of Service printed overleaf, available on request or accessible at <http://www.sgs.com/en/Terms-and-Conditions.aspx> and, for electronic format documents, subject to Terms and Conditions for Electronic Documents at <http://www.sgs.com/en/Terms-and-Conditions/Terms-e-Documents.aspx>. Attention is drawn to the limitation of liability, indemnification and jurisdiction issues defined therein. Any holder of this document is advised that information contained hereon reflects the Company's findings at the time of its intervention only and within the limits of Client's instructions, if any. The Company's sole responsibility is to its Client and this document does not exonerate parties to a transaction from exercising all their rights and obligations under the transaction documents. This document cannot be reproduced except in full, without prior written approval of the Company. Any unauthorized alteration, forgery or falsification of the content or appearance of this document is unlawful and offenders may be prosecuted to the fullest extent of the law. Unless otherwise stated the results shown in this test report refer only to the sample(s) tested and such sample(s) are retained for 30 days only.

Attention: To check the authenticity of testing /inspection report & certificate, please contact us at telephone: (86-755) 8307 1443, or email: QN.Doccheck@sgs.com

South of No. 6 Plant, No. 1, Runsheng Road, Suzhou Industrial Park, Suzhou Area, China (Jiangsu) Pilot Free Trade Zone 215000 t (86-512) 62992980 www.sgsgroup.com.cn
 中国·苏州·中国(江苏)自由贸易试验区苏州片区苏州工业园区润胜路1号的6号厂房南楼 邮编: 215000 t (86-512) 62992980 sgs.china@sgs.com



Report No.: SEWA2303000041RG06
Rev.: 01
Page: 35 of 104

Channel Loading Test Result

| TestMode | Frequency[MHz] | Result | Limit [%] | Verdict |
|-------------|----------------|--------|-----------|---------|
| 11ax160MIMO | 5570 | 35.61 | 17 | PASS |



Unless otherwise agreed in writing, this document is issued by the Company subject to its General Conditions of Service printed overleaf, available on request or accessible at <http://www.sgs.com/en/Terms-and-Conditions.aspx> and, for electronic format documents, subject to Terms and Conditions for Electronic Documents at <http://www.sgs.com/en/Terms-and-Conditions/Terms-e-Documents.aspx>. Attention is drawn to the limitation of liability, indemnification and jurisdiction issues defined therein. Any holder of this document is advised that information contained herein reflects the Company's findings at the time of its intervention only and within the limits of Client's instructions, if any. The Company's sole responsibility is to its Client and this document does not exonerate parties to a transaction from exercising all their rights and obligations under the transaction documents. This document cannot be reproduced except in full, without prior written approval of the Company. Any unauthorized alteration, forgery or falsification of the content or appearance of this document is unlawful and offenders may be prosecuted to the fullest extent of the law. Unless otherwise stated the results shown in this test report refer only to the sample(s) tested and such sample(s) are retained for 30 days only.

Attention: To check the authenticity of testing /inspection report & certificate, please contact us at telephone: (86-755) 8307 1443, or email: CN.Doccheck@sgs.com

Test Graphs

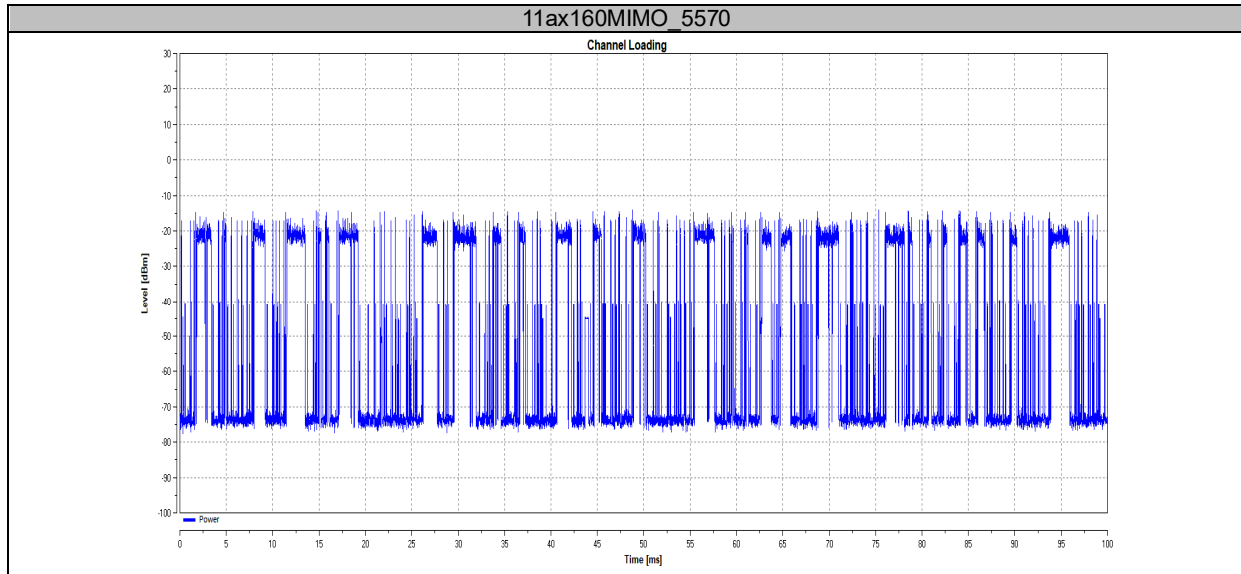

Unless otherwise agreed in writing, this document is issued by the Company subject to its General Conditions of Service printed overleaf, available on request or accessible at <http://www.sgs.com/en/Terms-and-Conditions.aspx> and, for electronic format documents, subject to Terms and Conditions for Electronic Documents at <http://www.sgs.com/en/Terms-and-Conditions/Terms-e-Documents.aspx>. Attention is drawn to the limitation of liability, indemnification and jurisdiction issues defined therein. Any holder of this document is advised that information contained herein reflects the Company's findings at the time of its intervention only and within the limits of Client's instructions, if any. The Company's sole responsibility is to its Client and this document does not exonerate parties to a transaction from exercising all their rights and obligations under the transaction documents. This document cannot be reproduced except in full, without prior written approval of the Company. Any unauthorized alteration, forgery or falsification of the content or appearance of this document is unlawful and offenders may be prosecuted to the fullest extent of the law. Unless otherwise stated the results shown in this test report refer only to the sample(s) tested and such sample(s) are retained for 30 days only.

Attention: To check the authenticity of testing /inspection report & certificate, please contact us at telephone: (86-755) 8307 1443, or email: QN.Doccheck@sgs.com

| | | | |
|--|------------|---------------------|--|
| South of No. 6 Plant, No. 1, Runsheng Road, Suzhou Industrial Park, Suzhou Area, China (Jiangsu) Pilot Free Trade Zone | 215000 | t (86-512) 62992980 | www.sgs.com |
| 中国·苏州·中国 (江苏) 自由贸易试验区苏州片区苏州工业园区润胜路1号的6号厂房南面 | 邮编: 215000 | t (86-512) 62992980 | sgs.china@sgs.com |

Channel Availability Check Time Test Result

| TestMode | Frequency[MHz] | Result | Verdict |
|-------------|----------------|----------------|---------|
| 11ax160MIMO | 5570 | See test Graph | PASS |

| TestMode | Frequency[MHz] | Result | Verdict |
|-------------|----------------|----------------|---------|
| 11ax160MIMO | 5570 | See test Graph | PASS |

| TestMode | Frequency[MHz] | Result | Verdict |
|-------------|----------------|----------------|---------|
| 11ax160MIMO | 5570 | See test Graph | PASS |



Unless otherwise agreed in writing, this document is issued by the Company subject to its General Conditions of Service printed overleaf, available on request or accessible at <http://www.sgs.com/en/Terms-and-Conditions.aspx> and, for electronic format documents, subject to Terms and Conditions for Electronic Documents at <http://www.sgs.com/en/Terms-and-Conditions/Terms-e-Documents.aspx>. Attention is drawn to the limitation of liability, indemnification and jurisdiction issues defined therein. Any holder of this document is advised that information contained herein reflects the Company's findings at the time of its intervention only and within the limits of Client's instructions, if any. The Company's sole responsibility is to its Client and this document does not exonerate parties to a transaction from exercising all their rights and obligations under the transaction documents. This document cannot be reproduced except in full, without prior written approval of the Company. Any unauthorized alteration, forgery or falsification of the content or appearance of this document is unlawful and offenders may be prosecuted to the fullest extent of the law. Unless otherwise stated the results shown in this test report refer only to the sample(s) tested and such sample(s) are retained for 30 days only.

Attention: To check the authenticity of testing /inspection report & certificate, please contact us at telephone: (86-755) 8307 1443, or email: CN.Doccheck@sgs.com

South of No. 6 Plant, No. 1, Runsheng Road, Suzhou Industrial Park, Suzhou Area, China (Jiangsu) Pilot Free Trade Zone 215000 t (86-512) 62992980 www.sgsgroup.com.cn
 中国·苏州·中国(江苏)自由贸易试验区苏州片区苏州工业园区润胜路1号的6号厂房南楼 邮编: 215000 t (86-512) 62992980 sgs.china@sgs.com



Test Graphs

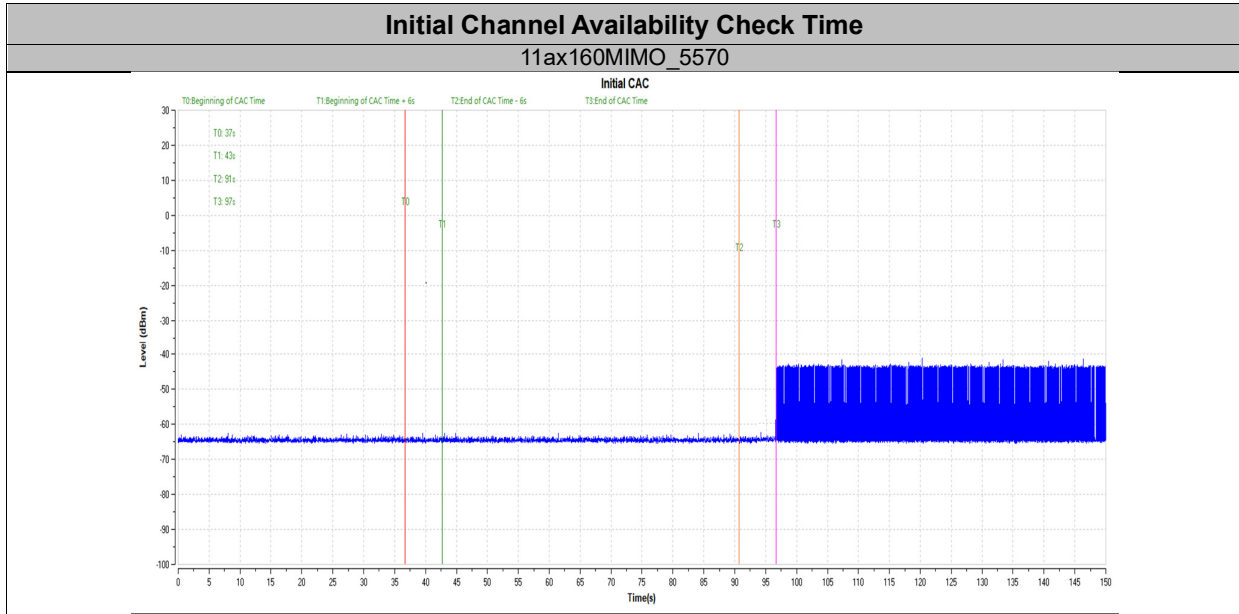

Unless otherwise agreed in writing, this document is issued by the Company subject to its General Conditions of Service printed overleaf, available on request or accessible at <http://www.sgs.com/en/Terms-and-Conditions.aspx> and, for electronic format documents, subject to Terms and Conditions for Electronic Documents at <http://www.sgs.com/en/Terms-and-Conditions/Terms-e-Documents.aspx>. Attention is drawn to the limitation of liability, indemnification and jurisdiction issues defined therein. Any holder of this document is advised that information contained hereon reflects the Company's findings at the time of its intervention only and within the limits of Client's instructions, if any. The Company's sole responsibility is to its Client and this document does not exonerate parties to a transaction from exercising all their rights and obligations under the transaction documents. This document cannot be reproduced except in full, without prior written approval of the Company. Any unauthorized alteration, forgery or falsification of the content or appearance of this document is unlawful and offenders may be prosecuted to the fullest extent of the law. Unless otherwise stated the results shown in this test report refer only to the sample(s) tested and such sample(s) are retained for 30 days only.

Attention: To check the authenticity of testing /inspection report & certificate, please contact us at telephone: (86-755) 8307 1443, or email: QN.Doccheck@sgs.com

South of No. 6 Plant, No. 1, Runsheng Road, Suzhou Industrial Park, Suzhou Area, China (Jiangsu) Pilot Free Trade Zone 215000 t (86-512) 62992980 www.sgs.com.cn
中国·苏州·中国(江苏)自由贸易试验区苏州片区苏州工业园区润胜路1号的6号厂房南楼 邮编: 215000 t (86-512) 62992980 sgs.china@sgs.com



Beginning of Channel Availability Check Time

11ax160MIMO_5570

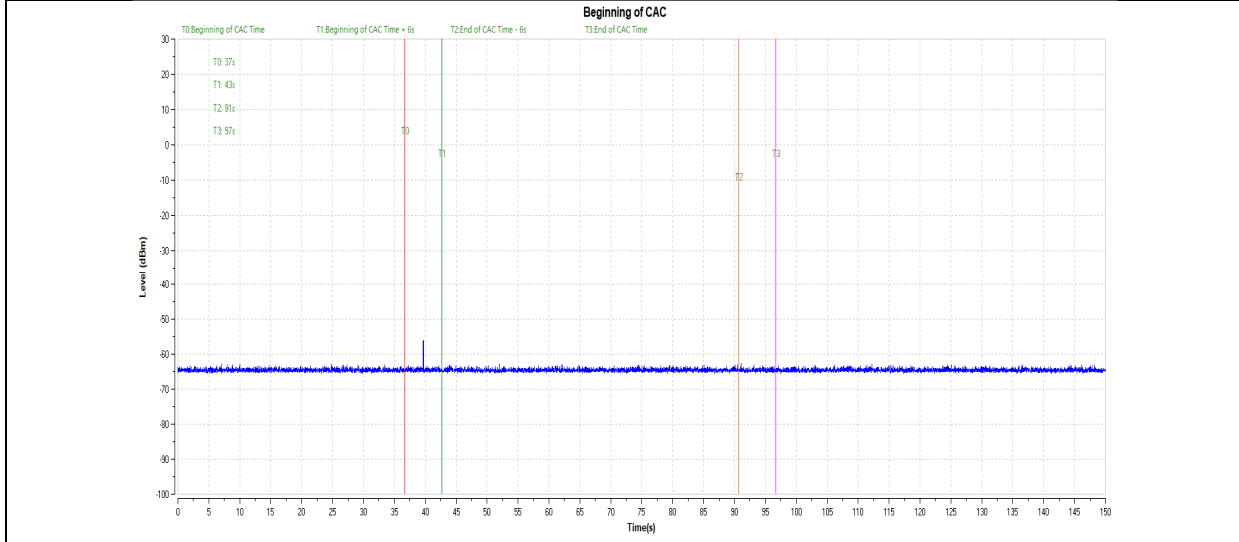

Unless otherwise agreed in writing, this document is issued by the Company subject to its General Conditions of Service printed overleaf, available on request or accessible at <http://www.sgs.com/en/Terms-and-Conditions.aspx> and, for electronic format documents, subject to Terms and Conditions for Electronic Documents at <http://www.sgs.com/en/Terms-and-Conditions/Terms-e-Documents.aspx>. Attention is drawn to the limitation of liability, indemnification and jurisdiction issues defined therein. Any holder of this document is advised that information contained hereon reflects the Company's findings at the time of its intervention only and within the limits of Client's instructions, if any. The Company's sole responsibility is to its Client and this document does not exonerate parties to a transaction from exercising all their rights and obligations under the transaction documents. This document cannot be reproduced except in full, without prior written approval of the Company. Any unauthorized alteration, forgery or falsification of the content or appearance of this document is unlawful and offenders may be prosecuted to the fullest extent of the law. Unless otherwise stated the results shown in this test report refer only to the sample(s) tested and such sample(s) are retained for 30 days only.

Attention: To check the authenticity of testing /inspection report & certificate, please contact us at telephone: (86-755) 8307 1443, or email: CN.Doccheck@sgs.com

| | | | |
|--|------------|---------------------|--|
| South of No. 6 Plant, No. 1, Runsheng Road, Suzhou Industrial Park, Suzhou Area, China (Jiangsu) Pilot Free Trade Zone | 215000 | t (86-512) 62992980 | www.sgs.com |
| 中国·苏州·中国(江苏)自由贸易试验区苏州片区苏州工业园区润胜路1号的6号厂房南楼 | 邮编: 215000 | t (86-512) 62992980 | sgs.china@sgs.com |

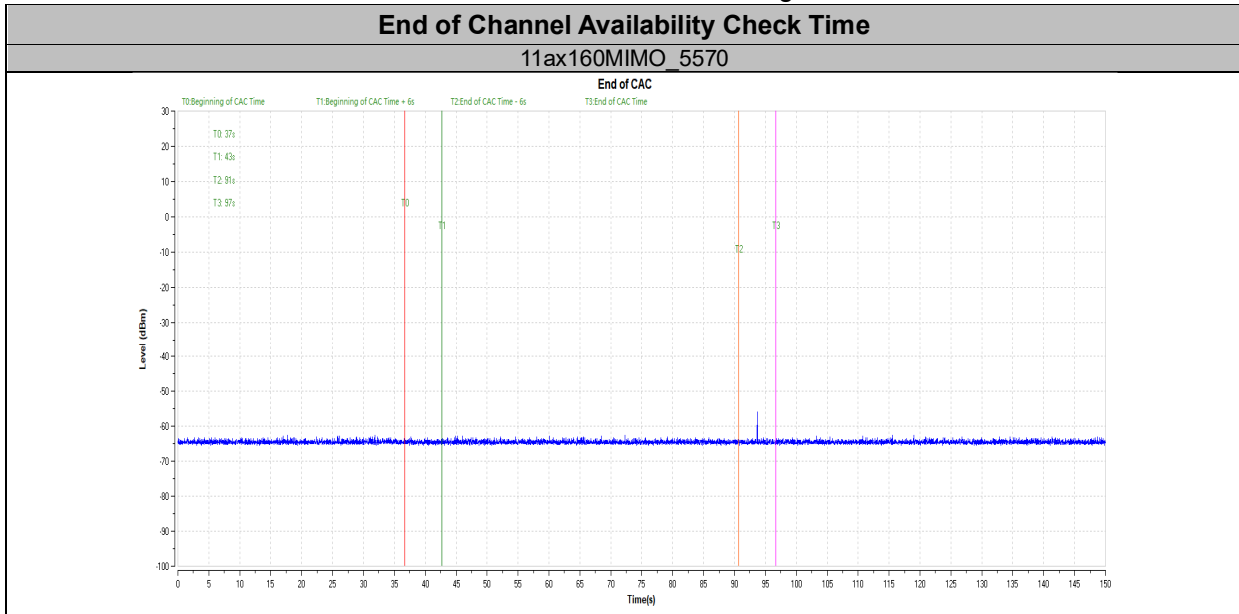

Unless otherwise agreed in writing, this document is issued by the Company subject to its General Conditions of Service printed overleaf, available on request or accessible at <http://www.sgs.com/en/Terms-and-Conditions.aspx> and, for electronic format documents, subject to Terms and Conditions for Electronic Documents at <http://www.sgs.com/en/Terms-and-Conditions/Terms-e-Documents.aspx>. Attention is drawn to the limitation of liability, indemnification and jurisdiction issues defined therein. Any holder of this document is advised that information contained hereon reflects the Company's findings at the time of its intervention only and within the limits of Client's instructions, if any. The Company's sole responsibility is to its Client and this document does not exonerate parties to a transaction from exercising all their rights and obligations under the transaction documents. This document cannot be reproduced except in full, without prior written approval of the Company. Any unauthorized alteration, forgery or falsification of the content or appearance of this document is unlawful and offenders may be prosecuted to the fullest extent of the law. Unless otherwise stated the results shown in this test report refer only to the sample(s) tested and such sample(s) are retained for 30 days only.

Attention: To check the authenticity of testing /inspection report & certificate, please contact us at telephone: (86-755) 8307 1443, or email: CN.Doccheck@sgs.com

| | | | |
|--|------------|---------------------|--|
| South of No. 6 Plant, No. 1, Runsheng Road, Suzhou Industrial Park, Suzhou Area, China (Jiangsu) Pilot Free Trade Zone | 215000 | t (86-512) 62992980 | www.sgs.com |
| 中国·苏州·中国(江苏)自由贸易试验区苏州片区苏州工业园区润胜路1号的6号厂房南楼 | 邮编: 215000 | t (86-512) 62992980 | sgs.china@sgs.com |

Channel Move Time and Channel Closing Transmission Time Test Result

| TestMode | Frequency[MHz] | CCTT[ms] | Limit[ms] | CMT[ms] | Limit[ms] | Verdict |
|-------------|----------------|----------|-----------|---------|-----------|---------|
| 11ax160MIMO | 5570 | 200+13 | 200+60 | 998.1 | 10000 | PASS |



Unless otherwise agreed in writing, this document is issued by the Company subject to its General Conditions of Service printed overleaf, available on request or accessible at <http://www.sgs.com/en/Terms-and-Conditions.aspx> and, for electronic format documents, subject to Terms and Conditions for Electronic Documents at <http://www.sgs.com/en/Terms-and-Conditions/Terms-e-Documents.aspx>. Attention is drawn to the limitation of liability, indemnification and jurisdiction issues defined therein. Any holder of this document is advised that information contained herein reflects the Company's findings at the time of its intervention only and within the limits of Client's instructions, if any. The Company's sole responsibility is to its Client and this document does not exonerate parties to a transaction from exercising all their rights and obligations under the transaction documents. This document cannot be reproduced except in full, without prior written approval of the Company. Any unauthorized alteration, forgery or falsification of the content or appearance of this document is unlawful and offenders may be prosecuted to the fullest extent of the law. Unless otherwise stated the results shown in this test report refer only to the sample(s) tested and such sample(s) are retained for 30 days only.

Attention: To check the authenticity of testing /inspection report & certificate, please contact us at telephone: (86-755) 8307 1443, or email: CN.Doccheck@sgs.com

South of No. 6 Plant, No. 1, Runsheng Road, Suzhou Industrial Park, Suzhou Area, China (Jiangsu) Pilot Free Trade Zone 215000 t (86-512) 62992980 www.sgs.com.cn
 中国·苏州·中国(江苏)自由贸易试验区苏州片区苏州工业园区润胜路1号的6号厂房南楼 邮编: 215000 t (86-512) 62992980 sgs.china@sgs.com

Test Graphs

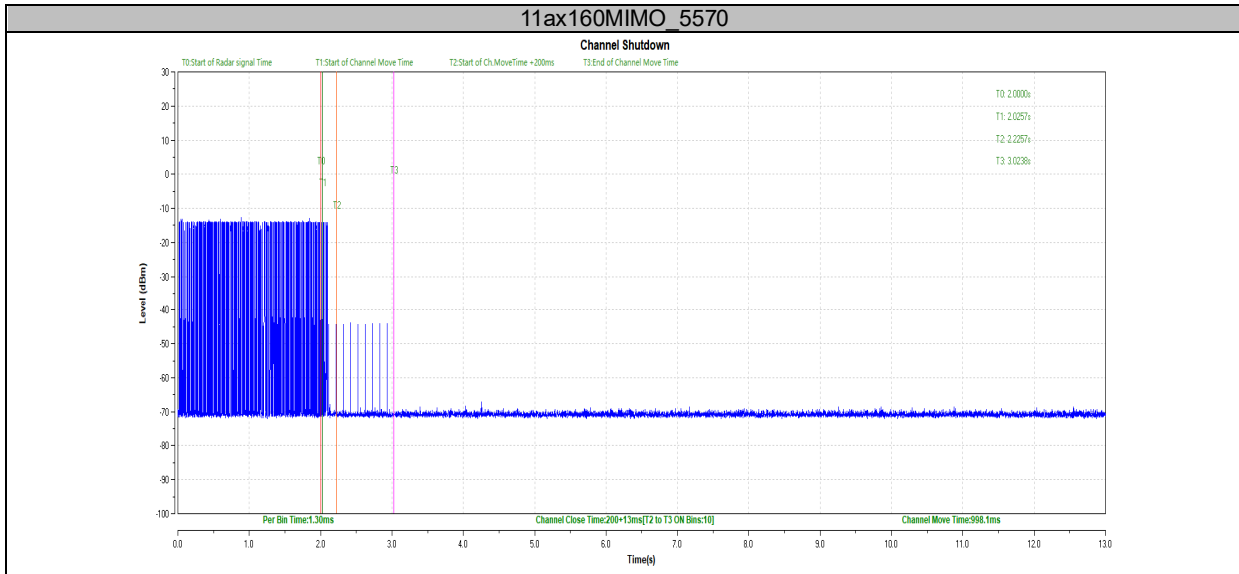

Unless otherwise agreed in writing, this document is issued by the Company subject to its General Conditions of Service printed overleaf, available on request or accessible at <http://www.sgs.com/en/Terms-and-Conditions.aspx> and, for electronic format documents, subject to Terms and Conditions for Electronic Documents at <http://www.sgs.com/en/Terms-and-Conditions/Terms-e-Documents.aspx>. Attention is drawn to the limitation of liability, indemnification and jurisdiction issues defined therein. Any holder of this document is advised that information contained hereon reflects the Company's findings at the time of its intervention only and within the limits of Client's instructions, if any. The Company's sole responsibility is to its Client and this document does not exonerate parties to a transaction from exercising all their rights and obligations under the transaction documents. This document cannot be reproduced except in full, without prior written approval of the Company. Any unauthorized alteration, forgery or falsification of the content or appearance of this document is unlawful and offenders may be prosecuted to the fullest extent of the law. Unless otherwise stated the results shown in this test report refer only to the sample(s) tested and such sample(s) are retained for 30 days only.

Attention: To check the authenticity of testing /inspection report & certificate, please contact us at telephone: (86-755) 8307 1443, or email: CN.Doccheck@sgs.com

South of No. 6 Plant, No. 1, Runsheng Road, Suzhou Industrial Park, Suzhou Area, China (Jiangsu) Pilot Free Trade Zone 215000 t (86-512) 62992980 www.sgs.com.cn
 中国·苏州·中国(江苏)自由贸易试验区苏州片区苏州工业园区润胜路1号的6号厂房南楼 邮编: 215000 t (86-512) 62992980 sgs.china@sgs.com

Non-Occupancy Period

Test Result

| TestMode | Frequency[MHz] | Result | Limit[s] | Verdict |
|-------------|----------------|----------------|----------|---------|
| 11ax160MIMO | 5570 | see test graph | ≥1800 | PASS |



Unless otherwise agreed in writing, this document is issued by the Company subject to its General Conditions of Service printed overleaf, available on request or accessible at <http://www.sgs.com/en/Terms-and-Conditions.aspx> and, for electronic format documents, subject to Terms and Conditions for Electronic Documents at <http://www.sgs.com/en/Terms-and-Conditions/Terms-e-Documents.aspx>. Attention is drawn to the limitation of liability, indemnification and jurisdiction issues defined therein. Any holder of this document is advised that information contained herein reflects the Company's findings at the time of its intervention only and within the limits of Client's instructions, if any. The Company's sole responsibility is to its Client and this document does not exonerate parties to a transaction from exercising all their rights and obligations under the transaction documents. This document cannot be reproduced except in full, without prior written approval of the Company. Any unauthorized alteration, forgery or falsification of the content or appearance of this document is unlawful and offenders may be prosecuted to the fullest extent of the law. Unless otherwise stated the results shown in this test report refer only to the sample(s) tested and such sample(s) are retained for 30 days only.

Attention: To check the authenticity of testing /inspection report & certificate, please contact us at telephone: (86-755) 8307 1443, or email: CN.Doccheck@sgs.com

Test Graphs

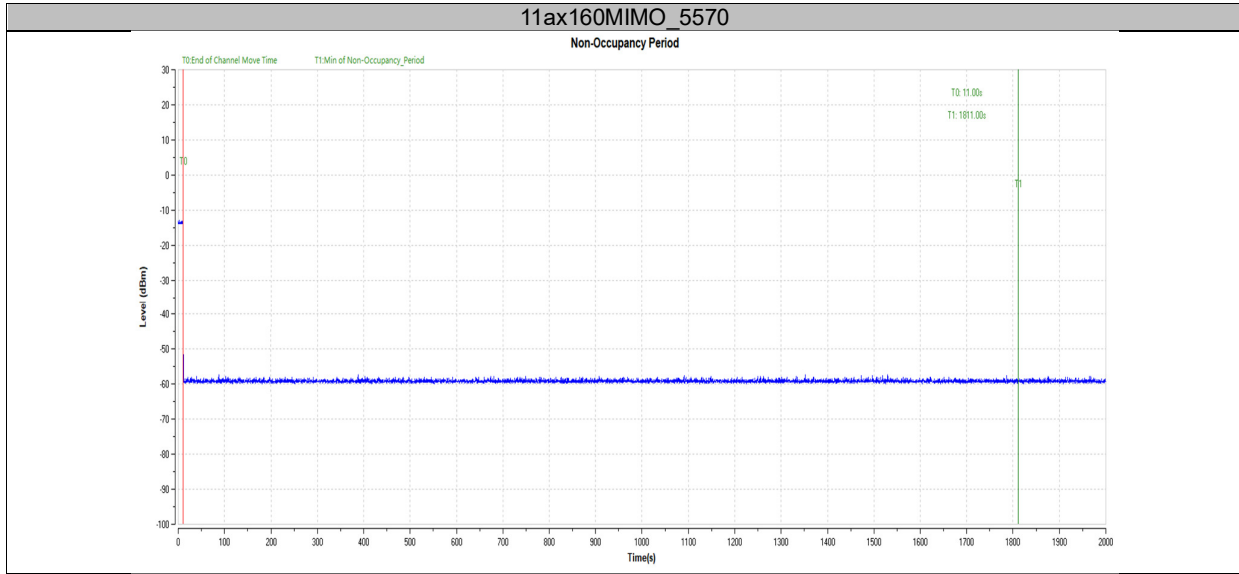

Unless otherwise agreed in writing, this document is issued by the Company subject to its General Conditions of Service printed overleaf, available on request or accessible at <http://www.sgs.com/en/Terms-and-Conditions.aspx> and, for electronic format documents, subject to Terms and Conditions for Electronic Documents at <http://www.sgs.com/en/Terms-and-Conditions/Terms-e-Documents.aspx>. Attention is drawn to the limitation of liability, indemnification and jurisdiction issues defined therein. Any holder of this document is advised that information contained hereon reflects the Company's findings at the time of its intervention only and within the limits of Client's instructions, if any. The Company's sole responsibility is to its Client and this document does not exonerate parties to a transaction from exercising all their rights and obligations under the transaction documents. This document cannot be reproduced except in full, without prior written approval of the Company. Any unauthorized alteration, forgery or falsification of the content or appearance of this document is unlawful and offenders may be prosecuted to the fullest extent of the law. Unless otherwise stated the results shown in this test report refer only to the sample(s) tested and such sample(s) are retained for 30 days only.

Attention: To check the authenticity of testing /inspection report & certificate, please contact us at telephone: (86-755) 8307 1443, or email: CN.Doccheck@sgs.com

| | | | |
|--|------------|---------------------|--|
| South of No. 6 Plant, No. 1, Runsheng Road, Suzhou Industrial Park, Suzhou Area, China (Jiangsu) Pilot Free Trade Zone | 215000 | t (86-512) 62992980 | www.sgs.com |
| 中国·苏州·中国 (江苏) 自由贸易试验区苏州片区苏州工业园区润胜路1号的6号厂房南面 | 邮编: 215000 | t (86-512) 62992980 | sgs.china@sgs.com |

U-NII Detection Bandwidth

Test Result

| TestMode | Frequency[MHz] | FL[MHz] | FH[MHz] | Detection Bandwidth [MHz] | OCB [MHz] | Ratio [%] | Limit [%] | Verdict |
|-------------|----------------|---------|---------|---------------------------|-----------|-----------|-----------|---------|
| 11ax20MIMO | 5500 | 5490 | 5510 | 20 | 18.353 | 108.97 | ≥100 | PASS |
| 11ax40MIMO | 5510 | 5490 | 5530 | 40 | 37.745 | 105.97 | ≥100 | PASS |
| 11ax80MIMO | 5530 | 5490 | 5570 | 80 | 76.812 | 104.15 | ≥100 | PASS |
| 11ax160MIMO | 5570 | 5490 | 5650 | 160 | 159.000 | 100.62 | ≥100 | PASS |



Unless otherwise agreed in writing, this document is issued by the Company subject to its General Conditions of Service printed overleaf, available on request or accessible at <http://www.sgs.com/en/Terms-and-Conditions.aspx> and, for electronic format documents, subject to Terms and Conditions for Electronic Documents at <http://www.sgs.com/en/Terms-and-Conditions/Terms-e-Documents.aspx>. Attention is drawn to the limitation of liability, indemnification and jurisdiction issues defined therein. Any holder of this document is advised that information contained hereon reflects the Company's findings at the time of its intervention only and within the limits of Client's instructions, if any. The Company's sole responsibility is to its Client and this document does not exonerate parties to a transaction from exercising all their rights and obligations under the transaction documents. This document cannot be reproduced except in full, without prior written approval of the Company. Any unauthorized alteration, forgery or falsification of the content or appearance of this document is unlawful and offenders may be prosecuted to the fullest extent of the law. Unless otherwise stated the results shown in this test report refer only to the sample(s) tested and such sample(s) are retained for 30 days only.

Attention: To check the authenticity of testing /inspection report & certificate, please contact us at telephone: (86-755) 8307 1443, or email: QN.Doccheck@sgs.com

| Test Mode | Frequency [MHz] | Radar Freq. | Trial 1 | Trial 2 | Trial 3 | Trial 4 | Trial 5 | Trial 6 | Trial 7 | Trial 8 | Trial 9 | Trial 10 | Ratio (%) | |
|-------------|-----------------|-------------|---------|---------|---------|---------|---------|---------|---------|---------|---------|----------|-----------|-----|
| 11ax20MIMO | 5500 | 5489 | 0 | 1 | 0 | 0 | 0 | 0 | 0 | 0 | 0 | 0 | 10 | |
| | | 5490 | 1 | 1 | 1 | 1 | 1 | 1 | 1 | 1 | 1 | 1 | 1 | 100 |
| | | 5495 | 1 | 1 | 1 | 1 | 1 | 1 | 1 | 1 | 1 | 1 | 1 | 100 |
| | | 5500 | 1 | 1 | 1 | 1 | 1 | 1 | 1 | 1 | 1 | 1 | 1 | 100 |
| | | 5505 | 1 | 1 | 1 | 1 | 1 | 1 | 1 | 1 | 1 | 1 | 1 | 100 |
| | | 5510 | 1 | 1 | 1 | 1 | 1 | 1 | 1 | 1 | 1 | 1 | 1 | 100 |
| | | 5511 | 0 | 0 | 0 | 0 | 0 | 0 | 0 | 0 | 0 | 0 | 0 | 0 |
| 111ax40MIMO | 5510 | 5489 | 0 | 0 | 0 | 0 | 0 | 0 | 0 | 0 | 0 | 0 | 0 | |
| | | 5490 | 1 | 1 | 1 | 1 | 1 | 1 | 1 | 1 | 1 | 1 | 1 | 100 |
| | | 5495 | 1 | 1 | 1 | 1 | 1 | 1 | 1 | 1 | 1 | 1 | 1 | 100 |
| | | 5500 | 1 | 1 | 1 | 1 | 1 | 1 | 1 | 1 | 1 | 1 | 1 | 100 |
| | | 5505 | 1 | 1 | 1 | 1 | 1 | 1 | 1 | 1 | 1 | 1 | 1 | 100 |
| | | 5510 | 1 | 1 | 1 | 1 | 1 | 1 | 1 | 1 | 1 | 1 | 1 | 100 |
| | | 5515 | 1 | 1 | 1 | 1 | 1 | 1 | 1 | 1 | 1 | 1 | 1 | 100 |
| | | 5520 | 1 | 1 | 1 | 1 | 1 | 1 | 1 | 1 | 1 | 1 | 1 | 100 |
| | | 5525 | 1 | 1 | 1 | 1 | 1 | 1 | 1 | 1 | 1 | 1 | 1 | 100 |
| | | 5530 | 1 | 1 | 1 | 1 | 1 | 1 | 1 | 1 | 1 | 1 | 1 | 100 |
| 5531 | 0 | 0 | 0 | 0 | 0 | 0 | 0 | 0 | 0 | 0 | 0 | 0 | | |
| 11ax80MIMO | 5530 | 5489 | 0 | 0 | 0 | 0 | 0 | 0 | 0 | 0 | 0 | 0 | 0 | |
| | | 5490 | 1 | 1 | 1 | 1 | 1 | 1 | 1 | 1 | 1 | 1 | 1 | 100 |
| | | 5495 | 1 | 1 | 1 | 1 | 1 | 1 | 1 | 1 | 1 | 1 | 1 | 100 |
| | | 5500 | 1 | 1 | 1 | 1 | 1 | 1 | 1 | 1 | 1 | 1 | 1 | 100 |
| | | 5505 | 1 | 1 | 1 | 1 | 1 | 1 | 1 | 1 | 1 | 1 | 1 | 100 |
| | | 5510 | 1 | 1 | 1 | 1 | 1 | 1 | 1 | 1 | 1 | 1 | 1 | 100 |
| | | 5515 | 1 | 1 | 1 | 1 | 1 | 1 | 1 | 1 | 1 | 1 | 1 | 100 |
| | | 5520 | 1 | 1 | 1 | 1 | 1 | 1 | 1 | 1 | 1 | 1 | 1 | 100 |
| | | 5525 | 1 | 1 | 1 | 1 | 1 | 1 | 1 | 1 | 1 | 1 | 1 | 100 |
| | | 5530 | 1 | 1 | 1 | 1 | 1 | 1 | 1 | 1 | 1 | 1 | 1 | 100 |
| | | 5535 | 1 | 1 | 1 | 1 | 1 | 1 | 1 | 1 | 1 | 1 | 1 | 100 |
| | | 5540 | 1 | 1 | 1 | 1 | 1 | 1 | 1 | 1 | 1 | 1 | 1 | 100 |
| | | 5545 | 1 | 1 | 1 | 1 | 1 | 1 | 1 | 1 | 1 | 1 | 1 | 100 |
| | | 5550 | 1 | 1 | 1 | 1 | 1 | 1 | 1 | 1 | 1 | 1 | 1 | 100 |
| | | 5555 | 1 | 1 | 1 | 1 | 1 | 1 | 1 | 1 | 1 | 1 | 1 | 100 |
| | | 5560 | 1 | 1 | 1 | 1 | 1 | 1 | 1 | 1 | 1 | 1 | 1 | 100 |
| | | 5565 | 1 | 1 | 1 | 1 | 1 | 1 | 1 | 1 | 1 | 1 | 1 | 100 |
| 5570 | 1 | 1 | 1 | 1 | 1 | 1 | 1 | 1 | 1 | 1 | 1 | 100 | | |
| 5571 | 0 | 0 | 0 | 0 | 0 | 0 | 0 | 0 | 0 | 0 | 0 | 0 | | |
| 11ax160MIMO | 5570 | 5489 | 0 | 0 | 0 | 0 | 0 | 0 | 0 | 0 | 0 | 0 | 0 | |
| | | 5490 | 1 | 1 | 1 | 1 | 1 | 1 | 1 | 1 | 1 | 1 | 1 | 100 |
| | | 5495 | 1 | 1 | 1 | 1 | 1 | 1 | 1 | 1 | 1 | 1 | 1 | 100 |
| | | 5500 | 1 | 1 | 1 | 1 | 1 | 1 | 1 | 1 | 1 | 1 | 1 | 100 |
| | | 5505 | 1 | 1 | 1 | 1 | 1 | 1 | 1 | 1 | 1 | 1 | 1 | 100 |
| | | 5510 | 1 | 1 | 1 | 1 | 1 | 1 | 1 | 1 | 1 | 1 | 1 | 100 |
| | | 5515 | 1 | 1 | 1 | 1 | 1 | 1 | 1 | 1 | 1 | 1 | 1 | 100 |
| | | 5520 | 1 | 1 | 1 | 1 | 1 | 1 | 1 | 1 | 1 | 1 | 1 | 100 |
| | | 5525 | 1 | 1 | 1 | 1 | 1 | 1 | 1 | 1 | 1 | 1 | 1 | 100 |
| | | 5530 | 1 | 1 | 1 | 1 | 1 | 1 | 1 | 1 | 1 | 1 | 1 | 100 |
| | | 5535 | 1 | 1 | 1 | 1 | 1 | 1 | 1 | 1 | 1 | 1 | 1 | 100 |
| | | 5540 | 1 | 1 | 1 | 1 | 1 | 1 | 1 | 1 | 1 | 1 | 1 | 100 |
| | | 5545 | 1 | 1 | 1 | 1 | 1 | 1 | 1 | 1 | 1 | 1 | 1 | 100 |
| | | 5550 | 1 | 1 | 1 | 1 | 1 | 1 | 1 | 1 | 1 | 1 | 1 | 100 |
| | | 5555 | 1 | 1 | 1 | 1 | 1 | 1 | 1 | 1 | 1 | 1 | 1 | 100 |
| | | 5560 | 1 | 1 | 1 | 1 | 1 | 1 | 1 | 1 | 1 | 1 | 1 | 100 |
| | | 5565 | 1 | 1 | 1 | 1 | 1 | 1 | 1 | 1 | 1 | 1 | 1 | 100 |
| 5570 | 1 | 1 | 1 | 1 | 1 | 1 | 1 | 1 | 1 | 1 | 1 | 100 | | |



Unless otherwise agreed in writing, this document is issued by the Company subject to its General Conditions of Service printed overleaf, available on request or accessible at <http://www.sgs.com/en/Terms-and-Conditions.aspx> and, for electronic format documents, subject to Terms and Conditions for Electronic Documents at <http://www.sgs.com/en/Terms-and-Conditions/Terms-e-Documents.aspx>. Attention is drawn to the limitation of liability, indemnification and jurisdiction issues defined therein. Any holder of this document is advised that information contained hereon reflects the Company's findings at the time of its intervention only and within the limits of Client's instructions, if any. The Company's sole responsibility is to its Client and this document does not exonerate parties to a transaction from exercising all their rights and obligations under the transaction documents. This document cannot be reproduced except in full, without prior written approval of the Company. Any unauthorized alteration, forgery or falsification of the content or appearance of this document is unlawful and offenders may be prosecuted to the fullest extent of the law. Unless otherwise stated the results shown in this test report refer only to the sample(s) tested and such sample(s) are retained for 30 days only.

Attention: To check the authenticity of testing / inspection report & certificate, please contact us at telephone: (86-755) 8307 1443, or email: CN.Doccheck@sgs.com

SGS-CSTC Standards Technical Services (Suzhou) Co., Ltd.
Wireless Laboratory

South of No. 6 Plant, No. 1, Runsheng Road, Suzhou Industrial Park, Suzhou Area, China (Jiangsu) Pilot Free Trade Zone 215000 t (86-512) 62992980 www.sgs.com.cn
中国·苏州·中国(江苏)自由贸易试验区苏州片区苏州工业园区润胜路1号的6号厂房南楼 邮编: 215000 t (86-512) 62992980 sgs.china@sgs.com



Report No.: SEWA2303000041RG06

Rev.: 01

Page: 47 of 104

| | | | | | | | | | | | | |
|--|--|------|---|---|---|---|---|---|---|---|---|-----|
| | | 5575 | 1 | 1 | 1 | 1 | 1 | 1 | 1 | 1 | 1 | 100 |
| | | 5580 | 1 | 1 | 1 | 1 | 1 | 1 | 1 | 1 | 1 | 100 |
| | | 5585 | 1 | 1 | 1 | 1 | 1 | 1 | 1 | 1 | 1 | 100 |
| | | 5590 | 1 | 1 | 1 | 1 | 1 | 1 | 1 | 1 | 1 | 100 |
| | | 5595 | 1 | 1 | 1 | 1 | 1 | 1 | 1 | 1 | 1 | 100 |
| | | 5600 | 1 | 1 | 1 | 1 | 1 | 1 | 1 | 1 | 1 | 100 |
| | | 5605 | 1 | 1 | 1 | 1 | 1 | 1 | 1 | 1 | 1 | 100 |
| | | 5610 | 1 | 1 | 1 | 1 | 1 | 1 | 1 | 1 | 1 | 100 |
| | | 5615 | 1 | 1 | 1 | 1 | 1 | 1 | 1 | 1 | 1 | 100 |
| | | 5620 | 1 | 1 | 1 | 1 | 1 | 1 | 1 | 1 | 1 | 100 |
| | | 5625 | 1 | 1 | 1 | 1 | 1 | 1 | 1 | 1 | 1 | 100 |
| | | 5630 | 1 | 1 | 1 | 1 | 1 | 1 | 1 | 1 | 1 | 100 |
| | | 5635 | 1 | 1 | 1 | 1 | 1 | 1 | 1 | 1 | 1 | 100 |
| | | 5640 | 1 | 1 | 1 | 1 | 1 | 1 | 1 | 1 | 1 | 100 |
| | | 5645 | 1 | 1 | 1 | 1 | 1 | 1 | 1 | 1 | 1 | 100 |
| | | 5650 | 1 | 1 | 1 | 1 | 1 | 1 | 1 | 1 | 1 | 100 |
| | | 5651 | 0 | 0 | 0 | 0 | 0 | 0 | 0 | 0 | 0 | 0 |



Unless otherwise agreed in writing, this document is issued by the Company subject to its General Conditions of Service printed overleaf, available on request or accessible at <http://www.sgs.com/en/Terms-and-Conditions.aspx> and, for electronic format documents, subject to Terms and Conditions for Electronic Documents at <http://www.sgs.com/en/Terms-and-Conditions/Terms-e-Documents.aspx>. Attention is drawn to the limitation of liability, indemnification and jurisdiction issues defined therein. Any holder of this document is advised that information contained hereon reflects the Company's findings at the time of its intervention only and within the limits of Client's instructions, if any. The Company's sole responsibility is to its Client and this document does not exonerate parties to a transaction from exercising all their rights and obligations under the transaction documents. This document cannot be reproduced except in full, without prior written approval of the Company. Any unauthorized alteration, forgery or falsification of the content or appearance of this document is unlawful and offenders may be prosecuted to the fullest extent of the law. Unless otherwise stated the results shown in this test report refer only to the sample(s) tested and such sample(s) are retained for 30 days only.

Attention: To check the authenticity of testing/inspection report & certificate, please contact us at telephone: (86-755) 8307 1443, or email: CN.Doccheck@sgs.com

Test Graphs

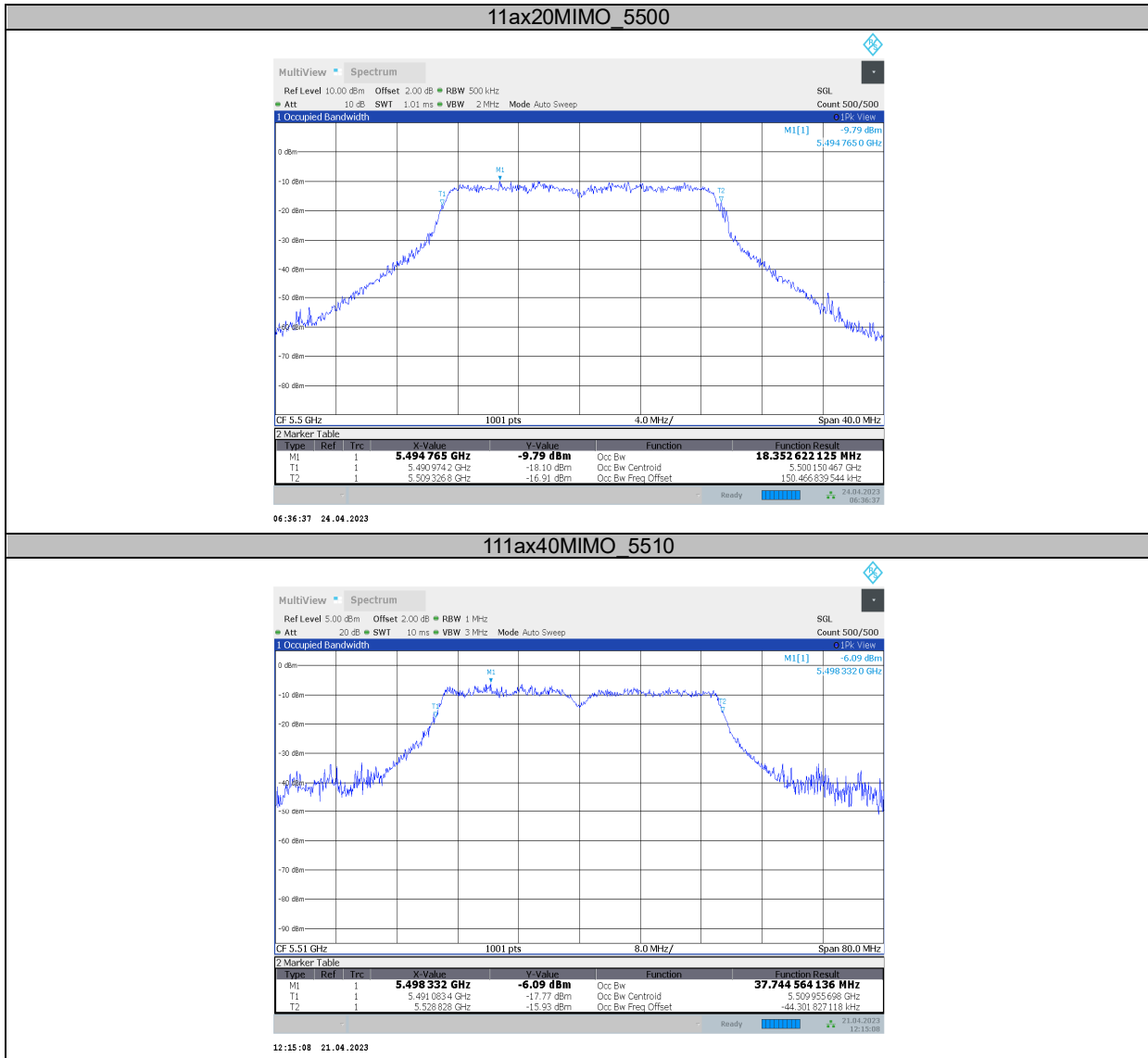

Unless otherwise agreed in writing, this document is issued by the Company subject to its General Conditions of Service printed overleaf, available on request or accessible at <http://www.sgs.com/en/Terms-and-Conditions.aspx> and, for electronic format documents, subject to Terms and Conditions for Electronic Documents at <http://www.sgs.com/en/Terms-and-Conditions/Terms-e-Documents.aspx>. Attention is drawn to the limitation of liability, indemnification and jurisdiction issues defined therein. Any holder of this document is advised that information contained hereon reflects the Company's findings at the time of its intervention only and within the limits of Client's instructions, if any. The Company's sole responsibility is to its Client and this document does not exonerate parties to a transaction from exercising all their rights and obligations under the transaction documents. This document cannot be reproduced except in full, without prior written approval of the Company. Any unauthorized alteration, forgery or falsification of the content or appearance of this document is unlawful and offenders may be prosecuted to the fullest extent of the law. Unless otherwise stated the results shown in this test report refer only to the sample(s) tested and such sample(s) are retained for 30 days only.

Attention: To check the authenticity of testing /inspection report & certificate, please contact us at telephone: (86-755) 8307 1443, or email: QN.Doccheck@sgs.com

South of No. 6 Plant, No. 1, Runsheng Road, Suzhou Industrial Park, Suzhou Area, China (Jiangsu) Pilot Free Trade Zone 215000 t (86-512) 62992980 www.sgs.com.cn
 中国·苏州·中国（江苏）自由贸易试验区苏州片区苏州工业园区润胜路1号的6号厂房南楼 邮编：215000 t (86-512) 62992980 sgs.china@sgs.com

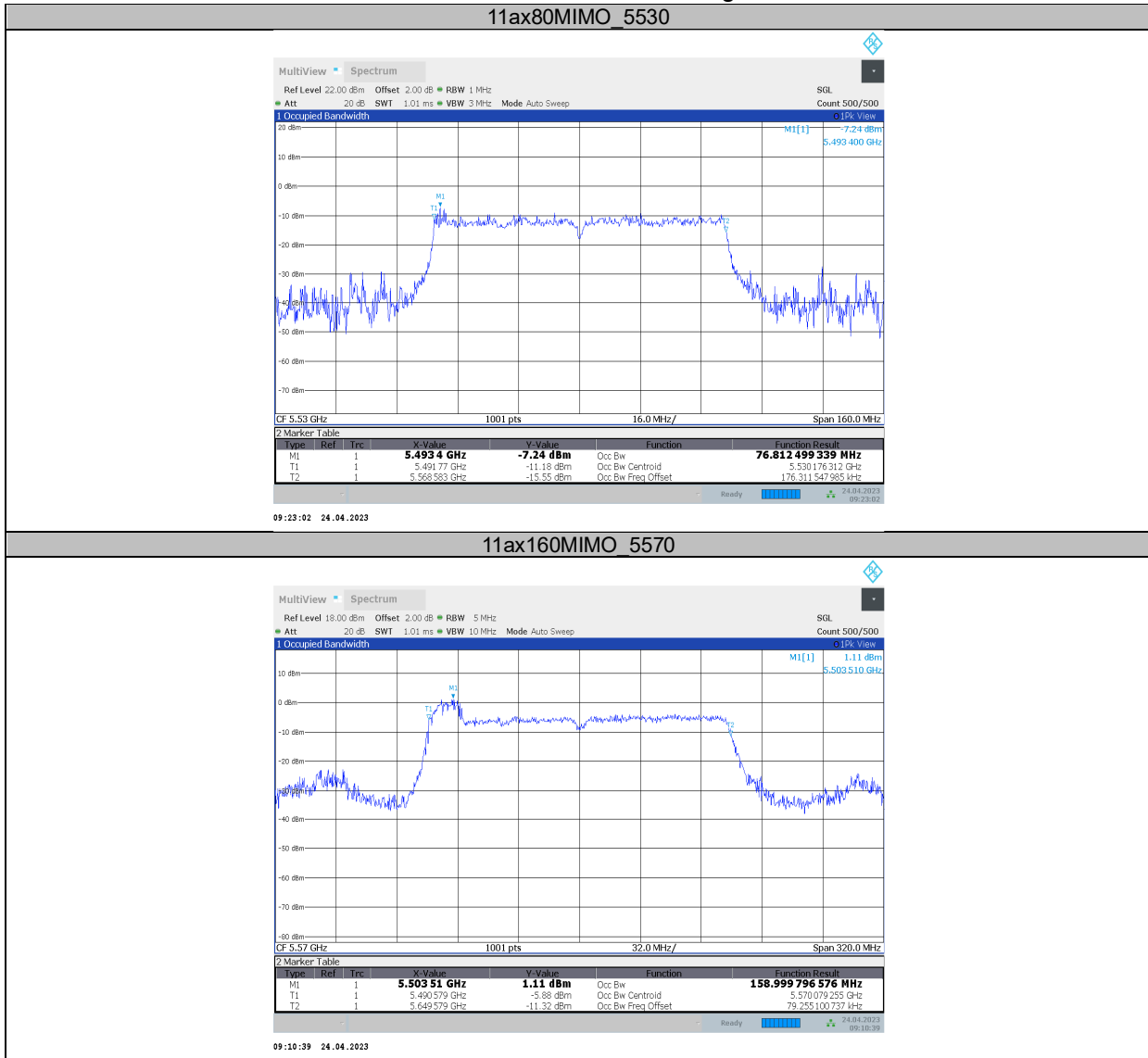

Unless otherwise agreed in writing, this document is issued by the Company subject to its General Conditions of Service printed overleaf, available on request or accessible at <http://www.sgs.com/en/Terms-and-Conditions.aspx> and, for electronic format documents, subject to Terms and Conditions for Electronic Documents at <http://www.sgs.com/en/Terms-and-Conditions/Terms-e-Documents.aspx>. Attention is drawn to the limitation of liability, indemnification and jurisdiction issues defined therein. Any holder of this document is advised that information contained herein reflects the Company's findings at the time of its intervention only and within the limits of Client's instructions, if any. The Company's sole responsibility is to its Client and this document does not exonerate parties to a transaction from exercising all their rights and obligations under the transaction documents. This document cannot be reproduced except in full, without prior written approval of the Company. Any unauthorized alteration, forgery or falsification of the content or appearance of this document is unlawful and offenders may be prosecuted to the fullest extent of the law. Unless otherwise stated the results shown in this test report refer only to the sample(s) tested and such sample(s) are retained for 30 days only.

Attention: To check the authenticity of testing /inspection report & certificate, please contact us at telephone: (86-755) 8307 1443, or email: QN.Doccheck@sgs.com

South of No. 6 Plant, No. 1, Runsheng Road, Suzhou Industrial Park, Suzhou Area, China (Jiangsu) Pilot Free Trade Zone 215000 t (86-512) 62992980 www.sgs.com.cn
 中国·苏州·中国（江苏）自由贸易试验区苏州片区苏州工业园区润胜路1号的6号厂房南楼 邮编：215000 t (86-512) 62992980 sgs.china@sgs.com

Statistical Performance check

Test Result

| TestMode | Frequency[MHz] | Radar Type | Pass Times | Fail Times | Probability (%) | Limit (%) | Verdict |
|-------------|----------------|------------|------------|------------|-----------------|-----------|---------|
| 11ax20MIMO | 5500 | Type1 | 29 | 1 | 96.67 | 60 | PASS |
| | | Type2 | 27 | 3 | 90.00 | 60 | PASS |
| | | Type3 | 27 | 3 | 90.00 | 60 | PASS |
| | | Type4 | 27 | 3 | 90.00 | 60 | PASS |
| | | Type 1-4 | --- | --- | 91.67 | 80 | PASS |
| | | Type5 | 30 | 0 | 100.00 | 80 | PASS |
| 111ax40MIMO | 5510 | Type1 | 30 | 0 | 100.00 | 60 | PASS |
| | | Type2 | 29 | 1 | 96.67 | 60 | PASS |
| | | Type3 | 29 | 1 | 96.67 | 60 | PASS |
| | | Type4 | 29 | 1 | 96.67 | 60 | PASS |
| | | Type 1-4 | --- | --- | 97.50 | 80 | PASS |
| | | Type5 | 29 | 1 | 96.67 | 80 | PASS |
| 11ax80MIMO | 5530 | Type1 | 27 | 3 | 90.00 | 60 | PASS |
| | | Type2 | 25 | 5 | 83.33 | 60 | PASS |
| | | Type3 | 28 | 2 | 93.33 | 60 | PASS |
| | | Type4 | 29 | 1 | 96.67 | 60 | PASS |
| | | Type 1-4 | --- | --- | 90.83 | 80 | PASS |
| | | Type5 | 27 | 3 | 90.00 | 80 | PASS |
| 11ax160MIMO | 5570 | Type1 | 28 | 2 | 93.33 | 60 | PASS |
| | | Type2 | 27 | 3 | 90.00 | 60 | PASS |
| | | Type3 | 28 | 2 | 93.33 | 60 | PASS |
| | | Type4 | 28 | 2 | 93.33 | 60 | PASS |
| | | Type 1-4 | --- | --- | 92.50 | 80 | PASS |
| | | Type5 | 27 | 3 | 90.00 | 80 | PASS |
| | | Type6 | 26 | 4 | 86.67 | 70 | PASS |



Unless otherwise agreed in writing, this document is issued by the Company subject to its General Conditions of Service printed overleaf, available on request or accessible at <http://www.sgs.com/en/Terms-and-Conditions.aspx> and, for electronic format documents, subject to Terms and Conditions for Electronic Documents at <http://www.sgs.com/en/Terms-and-Conditions/Terms-e-Documents.aspx>. Attention is drawn to the limitation of liability, indemnification and jurisdiction issues defined therein. Any holder of this document is advised that information contained hereon reflects the Company's findings at the time of its intervention only and within the limits of Client's instructions, if any. The Company's sole responsibility is to its Client and this document does not exonerate parties to a transaction from exercising all their rights and obligations under the transaction documents. This document cannot be reproduced except in full, without prior written approval of the Company. Any unauthorized alteration, forgery or falsification of the content or appearance of this document is unlawful and offenders may be prosecuted to the fullest extent of the law. Unless otherwise stated the results shown in this test report refer only to the sample(s) tested and such sample(s) are retained for 30 days only.

Attention: To check the authenticity of testing /inspection report & certificate, please contact us at telephone: (86-755) 8307 1443, or email: QN.Doccheck@sgs.com

| TestMode | Frequency[MHz] | Radar Type | Trial ID | Pulse width(μs) | PRI(μs) | Pulses per Burst | Detection (1: Yes; 0: No) |
|------------|----------------|------------|----------|-----------------|---------|------------------|---------------------------|
| 11ax20MIMO | 5500 | Type1 | 0 | 1.0 | 938.0 | 57 | 1 |
| | | Type1 | 1 | 1.0 | 698.0 | 76 | 1 |
| | | Type1 | 2 | 1.0 | 618.0 | 86 | 0 |
| | | Type1 | 3 | 1.0 | 538.0 | 99 | 1 |
| | | Type1 | 4 | 1.0 | 878.0 | 61 | 1 |
| | | Type1 | 5 | 1.0 | 3066.0 | 18 | 1 |
| | | Type1 | 6 | 1.0 | 638.0 | 83 | 1 |
| | | Type1 | 7 | 1.0 | 918.0 | 58 | 1 |
| | | Type1 | 8 | 1.0 | 838.0 | 63 | 1 |
| | | Type1 | 9 | 1.0 | 858.0 | 62 | 1 |
| | | Type1 | 10 | 1.0 | 798.0 | 67 | 1 |
| | | Type1 | 11 | 1.0 | 718.0 | 74 | 1 |
| | | Type1 | 12 | 1.0 | 578.0 | 92 | 1 |
| | | Type1 | 13 | 1.0 | 598.0 | 89 | 1 |
| | | Type1 | 14 | 1.0 | 558.0 | 95 | 1 |
| | | Type1 | 15 | 1.0 | 2536.0 | 21 | 1 |
| | | Type1 | 16 | 1.0 | 966.0 | 55 | 1 |
| | | Type1 | 17 | 1.0 | 827.0 | 64 | 1 |
| | | Type1 | 18 | 1.0 | 2501.0 | 22 | 1 |
| | | Type1 | 19 | 1.0 | 2595.0 | 21 | 1 |
| | | Type1 | 20 | 1.0 | 1114.0 | 48 | 1 |
| | | Type1 | 21 | 1.0 | 1302.0 | 41 | 1 |
| | | Type1 | 22 | 1.0 | 3045.0 | 18 | 1 |
| | | Type1 | 23 | 1.0 | 1624.0 | 33 | 1 |
| | | Type1 | 24 | 1.0 | 2878.0 | 19 | 1 |
| | | Type1 | 25 | 1.0 | 1027.0 | 52 | 1 |
| | | Type1 | 26 | 1.0 | 2485.0 | 22 | 1 |
| | | Type1 | 27 | 1.0 | 1600.0 | 33 | 1 |
| | | Type1 | 28 | 1.0 | 1172.0 | 46 | 1 |
| | | Type1 | 29 | 1.0 | 1177.0 | 45 | 1 |
| | | Type2 | 0 | 3.2 | 179.0 | 26 | 1 |
| | | Type2 | 1 | 1.1 | 207.0 | 23 | 1 |
| | | Type2 | 2 | 2.1 | 230.0 | 24 | 1 |
| | | Type2 | 3 | 4.8 | 200.0 | 29 | 1 |
| | | Type2 | 4 | 3.9 | 214.0 | 28 | 1 |
| | | Type2 | 5 | 2.9 | 222.0 | 26 | 0 |
| | | Type2 | 6 | 3.2 | 204.0 | 26 | 0 |
| | | Type2 | 7 | 2.5 | 192.0 | 25 | 1 |
| | | Type2 | 8 | 3.1 | 164.0 | 26 | 1 |
| | | Type2 | 9 | 1.2 | 156.0 | 23 | 1 |
| | | Type2 | 10 | 3.9 | 210.0 | 27 | 1 |
| | | Type2 | 11 | 4.6 | 201.0 | 29 | 1 |
| | | Type2 | 12 | 3.2 | 162.0 | 26 | 1 |
| Type2 | 13 | 2.2 | 197.0 | 25 | 1 | | |
| Type2 | 14 | 4.5 | 163.0 | 29 | 1 | | |
| Type2 | 15 | 3.0 | 203.0 | 26 | 1 | | |
| Type2 | 16 | 5.0 | 168.0 | 29 | 1 | | |
| Type2 | 17 | 2.4 | 217.0 | 25 | 1 | | |
| Type2 | 18 | 2.9 | 191.0 | 26 | 1 | | |
| Type2 | 19 | 2.3 | 166.0 | 25 | 1 | | |
| Type2 | 20 | 3.7 | 150.0 | 27 | 1 | | |
| Type2 | 21 | 2.2 | 176.0 | 25 | 1 | | |
| Type2 | 22 | 4.9 | 195.0 | 29 | 1 | | |
| Type2 | 23 | 2.9 | 202.0 | 26 | 1 | | |



Unless otherwise agreed in writing, this document is issued by the Company subject to its General Conditions of Service printed overleaf, available on request or accessible at <http://www.sgs.com/en/Terms-and-Conditions.aspx> and, for electronic format documents, subject to Terms and Conditions for Electronic Documents at <http://www.sgs.com/en/Terms-and-Conditions/Terms-e-Documents.aspx>. Attention is drawn to the limitation of liability, indemnification and jurisdiction issues defined therein. Any holder of this document is advised that information contained hereon reflects the Company's findings at the time of its intervention only and within the limits of Client's instructions, if any. The Company's sole responsibility is to its Client and this document does not exonerate parties to a transaction from exercising all their rights and obligations under the transaction documents. This document cannot be reproduced except in full, without prior written approval of the Company. Any unauthorized alteration, forgery or falsification of the content or appearance of this document is unlawful and offenders may be prosecuted to the fullest extent of the law. Unless otherwise stated the results shown in this test report refer only to the sample(s) tested and such sample(s) are retained for 30 days only.

Attention: To check the authenticity of testing /inspection report & certificate, please contact us at telephone: (86-755) 8307 1443, or email: QN.Doccheck@sgs.com

South of No. 6 Plant, No. 1, Runsheng Road, Suzhou Industrial Park, Suzhou Area, China (Jiangsu) Pilot Free Trade Zone 215000 t (86-512) 62992980 www.sgs.com.cn
 中国·苏州·中国(江苏)自由贸易试验区苏州片区苏州工业园区润胜路1号的6号厂房南楼 邮编: 215000 t (86-512) 62992980 sgs.china@sgs.com

| | | | | | |
|-------|----|------|-------|----|---|
| Type2 | 24 | 2.5 | 178.0 | 25 | 0 |
| Type2 | 25 | 1.1 | 206.0 | 23 | 1 |
| Type2 | 26 | 3.8 | 155.0 | 27 | 1 |
| Type2 | 27 | 4.7 | 157.0 | 29 | 1 |
| Type2 | 28 | 2.4 | 224.0 | 25 | 1 |
| Type2 | 29 | 4.2 | 159.0 | 28 | 1 |
| Type3 | 0 | 8.2 | 355.0 | 17 | 1 |
| Type3 | 1 | 6.1 | 487.0 | 16 | 1 |
| Type3 | 2 | 7.1 | 344.0 | 16 | 1 |
| Type3 | 3 | 9.8 | 288.0 | 18 | 1 |
| Type3 | 4 | 8.9 | 230.0 | 18 | 1 |
| Type3 | 5 | 7.9 | 432.0 | 17 | 0 |
| Type3 | 6 | 8.2 | 207.0 | 17 | 1 |
| Type3 | 7 | 7.5 | 443.0 | 17 | 1 |
| Type3 | 8 | 8.1 | 439.0 | 17 | 0 |
| Type3 | 9 | 6.2 | 223.0 | 16 | 1 |
| Type3 | 10 | 8.9 | 208.0 | 18 | 1 |
| Type3 | 11 | 9.6 | 463.0 | 18 | 1 |
| Type3 | 12 | 8.2 | 441.0 | 17 | 1 |
| Type3 | 13 | 7.2 | 323.0 | 16 | 1 |
| Type3 | 14 | 9.5 | 297.0 | 18 | 0 |
| Type3 | 15 | 8.0 | 412.0 | 17 | 1 |
| Type3 | 16 | 10.0 | 324.0 | 18 | 1 |
| Type3 | 17 | 7.4 | 271.0 | 17 | 1 |
| Type3 | 18 | 7.9 | 349.0 | 17 | 1 |
| Type3 | 19 | 7.3 | 409.0 | 16 | 1 |
| Type3 | 20 | 8.7 | 373.0 | 18 | 1 |
| Type3 | 21 | 7.2 | 254.0 | 16 | 1 |
| Type3 | 22 | 9.9 | 274.0 | 18 | 1 |
| Type3 | 23 | 7.9 | 278.0 | 17 | 1 |
| Type3 | 24 | 7.5 | 317.0 | 17 | 1 |
| Type3 | 25 | 6.1 | 260.0 | 16 | 1 |
| Type3 | 26 | 8.8 | 211.0 | 18 | 1 |
| Type3 | 27 | 9.7 | 272.0 | 18 | 1 |
| Type3 | 28 | 7.4 | 264.0 | 17 | 1 |
| Type3 | 29 | 9.2 | 284.0 | 18 | 1 |
| Type4 | 0 | 16.0 | 355.0 | 14 | 1 |
| Type4 | 1 | 11.3 | 487.0 | 12 | 1 |
| Type4 | 2 | 13.5 | 344.0 | 13 | 0 |
| Type4 | 3 | 19.4 | 288.0 | 16 | 1 |
| Type4 | 4 | 17.5 | 230.0 | 15 | 1 |
| Type4 | 5 | 15.3 | 432.0 | 14 | 1 |
| Type4 | 6 | 15.9 | 207.0 | 14 | 1 |
| Type4 | 7 | 14.3 | 443.0 | 13 | 1 |
| Type4 | 8 | 15.8 | 439.0 | 14 | 1 |
| Type4 | 9 | 11.5 | 223.0 | 12 | 1 |
| Type4 | 10 | 17.4 | 208.0 | 15 | 1 |
| Type4 | 11 | 19.0 | 463.0 | 16 | 0 |
| Type4 | 12 | 16.0 | 441.0 | 14 | 1 |
| Type4 | 13 | 13.8 | 323.0 | 13 | 1 |
| Type4 | 14 | 18.9 | 297.0 | 16 | 0 |
| Type4 | 15 | 15.5 | 412.0 | 14 | 1 |
| Type4 | 16 | 19.9 | 324.0 | 16 | 1 |
| Type4 | 17 | 14.1 | 271.0 | 13 | 1 |
| Type4 | 18 | 15.2 | 349.0 | 14 | 1 |
| Type4 | 19 | 13.8 | 409.0 | 13 | 1 |
| Type4 | 20 | 17.1 | 373.0 | 15 | 1 |



Unless otherwise agreed in writing, this document is issued by the Company subject to its General Conditions of Service printed overleaf, available on request or accessible at <http://www.sgs.com/en/Terms-and-Conditions.aspx> and, for electronic format documents, subject to Terms and Conditions for Electronic Documents at <http://www.sgs.com/en/Terms-and-Conditions/Terms-e-Documents.aspx>. Attention is drawn to the limitation of liability, indemnification and jurisdiction issues defined therein. Any holder of this document is advised that information contained hereon reflects the Company's findings at the time of its intervention only and within the limits of Client's instructions, if any. The Company's sole responsibility is to its Client and this document does not exonerate parties to a transaction from exercising all their rights and obligations under the transaction documents. This document cannot be reproduced except in full, without prior written approval of the Company. Any unauthorized alteration, forgery or falsification of the content or appearance of this document is unlawful and offenders may be prosecuted to the fullest extent of the law. Unless otherwise stated the results shown in this test report refer only to the sample(s) tested and such sample(s) are retained for 30 days only.

Attention: To check the authenticity of testing / inspection report & certificate, please contact us at telephone: (86-755) 8307 1443, or email: Q.N.Doche@sgs.com

| | | | | | | | |
|-------------|------|-------|-------|------|--------|----|---|
| | | Type4 | 21 | 13.8 | 254.0 | 13 | 1 |
| | | Type4 | 22 | 19.8 | 274.0 | 16 | 1 |
| | | Type4 | 23 | 15.3 | 278.0 | 14 | 1 |
| | | Type4 | 24 | 14.5 | 317.0 | 13 | 1 |
| | | Type4 | 25 | 11.3 | 260.0 | 12 | 1 |
| | | Type4 | 26 | 17.3 | 211.0 | 15 | 1 |
| | | Type4 | 27 | 19.2 | 272.0 | 16 | 1 |
| | | Type4 | 28 | 14.2 | 264.0 | 13 | 1 |
| | | Type4 | 29 | 18.2 | 284.0 | 15 | 1 |
| 111ax40MIMO | 5510 | Type1 | 0 | 1.0 | 938.0 | 57 | 1 |
| | | Type1 | 1 | 1.0 | 698.0 | 76 | 1 |
| | | Type1 | 2 | 1.0 | 618.0 | 86 | 1 |
| | | Type1 | 3 | 1.0 | 538.0 | 99 | 1 |
| | | Type1 | 4 | 1.0 | 878.0 | 61 | 1 |
| | | Type1 | 5 | 1.0 | 3066.0 | 18 | 1 |
| | | Type1 | 6 | 1.0 | 638.0 | 83 | 1 |
| | | Type1 | 7 | 1.0 | 918.0 | 58 | 1 |
| | | Type1 | 8 | 1.0 | 838.0 | 63 | 1 |
| | | Type1 | 9 | 1.0 | 858.0 | 62 | 1 |
| | | Type1 | 10 | 1.0 | 798.0 | 67 | 1 |
| | | Type1 | 11 | 1.0 | 718.0 | 74 | 1 |
| | | Type1 | 12 | 1.0 | 578.0 | 92 | 1 |
| | | Type1 | 13 | 1.0 | 598.0 | 89 | 1 |
| | | Type1 | 14 | 1.0 | 558.0 | 95 | 1 |
| | | Type1 | 15 | 1.0 | 2536.0 | 21 | 1 |
| | | Type1 | 16 | 1.0 | 966.0 | 55 | 1 |
| | | Type1 | 17 | 1.0 | 827.0 | 64 | 1 |
| | | Type1 | 18 | 1.0 | 2501.0 | 22 | 1 |
| | | Type1 | 19 | 1.0 | 2595.0 | 21 | 1 |
| | | Type1 | 20 | 1.0 | 1114.0 | 48 | 1 |
| | | Type1 | 21 | 1.0 | 1302.0 | 41 | 1 |
| | | Type1 | 22 | 1.0 | 3045.0 | 18 | 1 |
| | | Type1 | 23 | 1.0 | 1624.0 | 33 | 1 |
| | | Type1 | 24 | 1.0 | 2878.0 | 19 | 1 |
| | | Type1 | 25 | 1.0 | 1027.0 | 52 | 1 |
| | | Type1 | 26 | 1.0 | 2485.0 | 22 | 1 |
| | | Type1 | 27 | 1.0 | 1600.0 | 33 | 1 |
| | | Type1 | 28 | 1.0 | 1172.0 | 46 | 1 |
| | | Type1 | 29 | 1.0 | 1177.0 | 45 | 1 |
| | | Type2 | 0 | 3.2 | 179.0 | 26 | 1 |
| | | Type2 | 1 | 1.1 | 207.0 | 23 | 1 |
| | | Type2 | 2 | 2.1 | 230.0 | 24 | 1 |
| | | Type2 | 3 | 4.8 | 200.0 | 29 | 0 |
| | | Type2 | 4 | 3.9 | 214.0 | 28 | 1 |
| | | Type2 | 5 | 2.9 | 222.0 | 26 | 1 |
| | | Type2 | 6 | 3.2 | 204.0 | 26 | 1 |
| | | Type2 | 7 | 2.5 | 192.0 | 25 | 1 |
| | | Type2 | 8 | 3.1 | 164.0 | 26 | 1 |
| | | Type2 | 9 | 1.2 | 156.0 | 23 | 1 |
| Type2 | 10 | 3.9 | 210.0 | 27 | 1 | | |
| Type2 | 11 | 4.6 | 201.0 | 29 | 1 | | |
| Type2 | 12 | 3.2 | 162.0 | 26 | 1 | | |
| Type2 | 13 | 2.2 | 197.0 | 25 | 1 | | |
| Type2 | 14 | 4.5 | 163.0 | 29 | 1 | | |
| Type2 | 15 | 3.0 | 203.0 | 26 | 1 | | |
| Type2 | 16 | 5.0 | 168.0 | 29 | 1 | | |
| Type2 | 17 | 2.4 | 217.0 | 25 | 1 | | |



Unless otherwise agreed in writing, this document is issued by the Company subject to its General Conditions of Service printed overleaf, available on request or accessible at <http://www.sgs.com/en/Terms-and-Conditions.aspx> and, for electronic format documents, subject to Terms and Conditions for Electronic Documents at <http://www.sgs.com/en/Terms-and-Conditions/Terms-e-Documents.aspx>. Attention is drawn to the limitation of liability, indemnification and jurisdiction issues defined therein. Any holder of this document is advised that information contained herein reflects the Company's findings at the time of its intervention only and within the limits of Client's instructions, if any. The Company's sole responsibility is to its Client and this document does not exonerate parties to a transaction from exercising all their rights and obligations under the transaction documents. This document cannot be reproduced except in full, without prior written approval of the Company. Any unauthorized alteration, forgery or falsification of the content or appearance of this document is unlawful and offenders may be prosecuted to the fullest extent of the law. Unless otherwise stated the results shown in this test report refer only to the sample(s) tested and such sample(s) are retained for 30 days only.

Attention: To check the authenticity of testing/inspection report & certificate, please contact us at telephone: (86-755) 8307 1443, or email: QN.Doche@sgs.com

| | | | | | |
|-------|----|------|-------|----|---|
| Type2 | 18 | 2.9 | 191.0 | 26 | 1 |
| Type2 | 19 | 2.3 | 166.0 | 25 | 1 |
| Type2 | 20 | 3.7 | 150.0 | 27 | 1 |
| Type2 | 21 | 2.2 | 176.0 | 25 | 1 |
| Type2 | 22 | 4.9 | 195.0 | 29 | 1 |
| Type2 | 23 | 2.9 | 202.0 | 26 | 1 |
| Type2 | 24 | 2.5 | 178.0 | 25 | 1 |
| Type2 | 25 | 1.1 | 206.0 | 23 | 1 |
| Type2 | 26 | 3.8 | 155.0 | 27 | 1 |
| Type2 | 27 | 4.7 | 157.0 | 29 | 1 |
| Type2 | 28 | 2.4 | 224.0 | 25 | 1 |
| Type2 | 29 | 4.2 | 159.0 | 28 | 1 |
| Type3 | 0 | 8.2 | 355.0 | 17 | 1 |
| Type3 | 1 | 6.1 | 487.0 | 16 | 1 |
| Type3 | 2 | 7.1 | 344.0 | 16 | 1 |
| Type3 | 3 | 9.8 | 288.0 | 18 | 1 |
| Type3 | 4 | 8.9 | 230.0 | 18 | 1 |
| Type3 | 5 | 7.9 | 432.0 | 17 | 1 |
| Type3 | 6 | 8.2 | 207.0 | 17 | 1 |
| Type3 | 7 | 7.5 | 443.0 | 17 | 1 |
| Type3 | 8 | 8.1 | 439.0 | 17 | 1 |
| Type3 | 9 | 6.2 | 223.0 | 16 | 1 |
| Type3 | 10 | 8.9 | 208.0 | 18 | 0 |
| Type3 | 11 | 9.6 | 463.0 | 18 | 1 |
| Type3 | 12 | 8.2 | 441.0 | 17 | 1 |
| Type3 | 13 | 7.2 | 323.0 | 16 | 1 |
| Type3 | 14 | 9.5 | 297.0 | 18 | 1 |
| Type3 | 15 | 8.0 | 412.0 | 17 | 1 |
| Type3 | 16 | 10.0 | 324.0 | 18 | 1 |
| Type3 | 17 | 7.4 | 271.0 | 17 | 1 |
| Type3 | 18 | 7.9 | 349.0 | 17 | 1 |
| Type3 | 19 | 7.3 | 409.0 | 16 | 1 |
| Type3 | 20 | 8.7 | 373.0 | 18 | 1 |
| Type3 | 21 | 7.2 | 254.0 | 16 | 1 |
| Type3 | 22 | 9.9 | 274.0 | 18 | 1 |
| Type3 | 23 | 7.9 | 278.0 | 17 | 1 |
| Type3 | 24 | 7.5 | 317.0 | 17 | 1 |
| Type3 | 25 | 6.1 | 260.0 | 16 | 1 |
| Type3 | 26 | 8.8 | 211.0 | 18 | 1 |
| Type3 | 27 | 9.7 | 272.0 | 18 | 1 |
| Type3 | 28 | 7.4 | 264.0 | 17 | 1 |
| Type3 | 29 | 9.2 | 284.0 | 18 | 1 |
| Type4 | 0 | 16.0 | 355.0 | 14 | 1 |
| Type4 | 1 | 11.3 | 487.0 | 12 | 1 |
| Type4 | 2 | 13.5 | 344.0 | 13 | 1 |
| Type4 | 3 | 19.4 | 288.0 | 16 | 1 |
| Type4 | 4 | 17.5 | 230.0 | 15 | 1 |
| Type4 | 5 | 15.3 | 432.0 | 14 | 1 |
| Type4 | 6 | 15.9 | 207.0 | 14 | 1 |
| Type4 | 7 | 14.3 | 443.0 | 13 | 1 |
| Type4 | 8 | 15.8 | 439.0 | 14 | 0 |
| Type4 | 9 | 11.5 | 223.0 | 12 | 1 |
| Type4 | 10 | 17.4 | 208.0 | 15 | 1 |
| Type4 | 11 | 19.0 | 463.0 | 16 | 1 |
| Type4 | 12 | 16.0 | 441.0 | 14 | 1 |
| Type4 | 13 | 13.8 | 323.0 | 13 | 1 |
| Type4 | 14 | 18.9 | 297.0 | 16 | 1 |



Unless otherwise agreed in writing, this document is issued by the Company subject to its General Conditions of Service printed overleaf, available on request or accessible at <http://www.sgs.com/en/Terms-and-Conditions.aspx> and, for electronic format documents, subject to Terms and Conditions for Electronic Documents at <http://www.sgs.com/en/Terms-and-Conditions/Terms-e-Documents.aspx>. Attention is drawn to the limitation of liability, indemnification and jurisdiction issues defined therein. Any holder of this document is advised that information contained herein reflects the Company's findings at the time of its intervention only and within the limits of Client's instructions, if any. The Company's sole responsibility is to its Client and this document does not exonerate parties to a transaction from exercising all their rights and obligations under the transaction documents. This document cannot be reproduced except in full, without prior written approval of the Company. Any unauthorized alteration, forgery or falsification of the content or appearance of this document is unlawful and offenders may be prosecuted to the fullest extent of the law. Unless otherwise stated the results shown in this test report refer only to the sample(s) tested and such sample(s) are retained for 30 days only.

Attention: To check the authenticity of testing/inspection report & certificate, please contact us at telephone: (86-755) 8307 1443, or email: Q.N.Doche@sgs.com

| | | | | | | | |
|------------|------|-------|-------|------|--------|----|---|
| | | Type4 | 15 | 15.5 | 412.0 | 14 | 1 |
| | | Type4 | 16 | 19.9 | 324.0 | 16 | 1 |
| | | Type4 | 17 | 14.1 | 271.0 | 13 | 1 |
| | | Type4 | 18 | 15.2 | 349.0 | 14 | 1 |
| | | Type4 | 19 | 13.8 | 409.0 | 13 | 1 |
| | | Type4 | 20 | 17.1 | 373.0 | 15 | 1 |
| | | Type4 | 21 | 13.8 | 254.0 | 13 | 1 |
| | | Type4 | 22 | 19.8 | 274.0 | 16 | 1 |
| | | Type4 | 23 | 15.3 | 278.0 | 14 | 1 |
| | | Type4 | 24 | 14.5 | 317.0 | 13 | 1 |
| | | Type4 | 25 | 11.3 | 260.0 | 12 | 1 |
| | | Type4 | 26 | 17.3 | 211.0 | 15 | 1 |
| | | Type4 | 27 | 19.2 | 272.0 | 16 | 1 |
| | | Type4 | 28 | 14.2 | 264.0 | 13 | 1 |
| | | Type4 | 29 | 18.2 | 284.0 | 15 | 1 |
| 11ax80MIMO | 5530 | Type1 | 0 | 1.0 | 938.0 | 57 | 1 |
| | | Type1 | 1 | 1.0 | 698.0 | 76 | 1 |
| | | Type1 | 2 | 1.0 | 618.0 | 86 | 1 |
| | | Type1 | 3 | 1.0 | 538.0 | 99 | 1 |
| | | Type1 | 4 | 1.0 | 878.0 | 61 | 1 |
| | | Type1 | 5 | 1.0 | 3066.0 | 18 | 1 |
| | | Type1 | 6 | 1.0 | 638.0 | 83 | 1 |
| | | Type1 | 7 | 1.0 | 918.0 | 58 | 1 |
| | | Type1 | 8 | 1.0 | 838.0 | 63 | 0 |
| | | Type1 | 9 | 1.0 | 858.0 | 62 | 1 |
| | | Type1 | 10 | 1.0 | 798.0 | 67 | 1 |
| | | Type1 | 11 | 1.0 | 718.0 | 74 | 1 |
| | | Type1 | 12 | 1.0 | 578.0 | 92 | 1 |
| | | Type1 | 13 | 1.0 | 598.0 | 89 | 1 |
| | | Type1 | 14 | 1.0 | 558.0 | 95 | 0 |
| | | Type1 | 15 | 1.0 | 2536.0 | 21 | 1 |
| | | Type1 | 16 | 1.0 | 966.0 | 55 | 1 |
| | | Type1 | 17 | 1.0 | 827.0 | 64 | 1 |
| | | Type1 | 18 | 1.0 | 2501.0 | 22 | 0 |
| | | Type1 | 19 | 1.0 | 2595.0 | 21 | 1 |
| | | Type1 | 20 | 1.0 | 1114.0 | 48 | 1 |
| | | Type1 | 21 | 1.0 | 1302.0 | 41 | 1 |
| | | Type1 | 22 | 1.0 | 3045.0 | 18 | 1 |
| | | Type1 | 23 | 1.0 | 1624.0 | 33 | 1 |
| | | Type1 | 24 | 1.0 | 2878.0 | 19 | 1 |
| | | Type1 | 25 | 1.0 | 1027.0 | 52 | 1 |
| | | Type1 | 26 | 1.0 | 2485.0 | 22 | 1 |
| | | Type1 | 27 | 1.0 | 1600.0 | 33 | 1 |
| | | Type1 | 28 | 1.0 | 1172.0 | 46 | 1 |
| | | Type1 | 29 | 1.0 | 1177.0 | 45 | 1 |
| | | Type2 | 0 | 3.2 | 179.0 | 26 | 1 |
| | | Type2 | 1 | 1.1 | 207.0 | 23 | 1 |
| | | Type2 | 2 | 2.1 | 230.0 | 24 | 0 |
| | | Type2 | 3 | 4.8 | 200.0 | 29 | 1 |
| | | Type2 | 4 | 3.9 | 214.0 | 28 | 1 |
| | | Type2 | 5 | 2.9 | 222.0 | 26 | 1 |
| Type2 | 6 | 3.2 | 204.0 | 26 | 1 | | |
| Type2 | 7 | 2.5 | 192.0 | 25 | 1 | | |
| Type2 | 8 | 3.1 | 164.0 | 26 | 1 | | |
| Type2 | 9 | 1.2 | 156.0 | 23 | 1 | | |
| Type2 | 10 | 3.9 | 210.0 | 27 | 1 | | |
| Type2 | 11 | 4.6 | 201.0 | 29 | 1 | | |



Unless otherwise agreed in writing, this document is issued by the Company subject to its General Conditions of Service printed overleaf, available on request or accessible at <http://www.sgs.com/en/Terms-and-Conditions.aspx> and, for electronic format documents, subject to Terms and Conditions for Electronic Documents at <http://www.sgs.com/en/Terms-and-Conditions/Terms-e-Documents.aspx>. Attention is drawn to the limitation of liability, indemnification and jurisdiction issues defined therein. Any holder of this document is advised that information contained herein reflects the Company's findings at the time of its intervention only and within the limits of Client's instructions, if any. The Company's sole responsibility is to its Client and this document does not exonerate parties to a transaction from exercising all their rights and obligations under the transaction documents. This document cannot be reproduced except in full, without prior written approval of the Company. Any unauthorized alteration, forgery or falsification of the content or appearance of this document is unlawful and offenders may be prosecuted to the fullest extent of the law. Unless otherwise stated the results shown in this test report refer only to the sample(s) tested and such sample(s) are retained for 30 days only.

Attention: To check the authenticity of testing / inspection report & certificate, please contact us at telephone: (86-755) 8307 1443, or email: Q.N.Doche@sgs.com

| | | | | | |
|-------|----|------|-------|----|---|
| Type2 | 12 | 3.2 | 162.0 | 26 | 1 |
| Type2 | 13 | 2.2 | 197.0 | 25 | 1 |
| Type2 | 14 | 4.5 | 163.0 | 29 | 1 |
| Type2 | 15 | 3.0 | 203.0 | 26 | 1 |
| Type2 | 16 | 5.0 | 168.0 | 29 | 1 |
| Type2 | 17 | 2.4 | 217.0 | 25 | 1 |
| Type2 | 18 | 2.9 | 191.0 | 26 | 1 |
| Type2 | 19 | 2.3 | 166.0 | 25 | 0 |
| Type2 | 20 | 3.7 | 150.0 | 27 | 1 |
| Type2 | 21 | 2.2 | 176.0 | 25 | 0 |
| Type2 | 22 | 4.9 | 195.0 | 29 | 1 |
| Type2 | 23 | 2.9 | 202.0 | 26 | 1 |
| Type2 | 24 | 2.5 | 178.0 | 25 | 0 |
| Type2 | 25 | 1.1 | 206.0 | 23 | 1 |
| Type2 | 26 | 3.8 | 155.0 | 27 | 1 |
| Type2 | 27 | 4.7 | 157.0 | 29 | 0 |
| Type2 | 28 | 2.4 | 224.0 | 25 | 1 |
| Type2 | 29 | 4.2 | 159.0 | 28 | 1 |
| Type3 | 0 | 8.2 | 355.0 | 17 | 1 |
| Type3 | 1 | 6.1 | 487.0 | 16 | 1 |
| Type3 | 2 | 7.1 | 344.0 | 16 | 1 |
| Type3 | 3 | 9.8 | 288.0 | 18 | 1 |
| Type3 | 4 | 8.9 | 230.0 | 18 | 1 |
| Type3 | 5 | 7.9 | 432.0 | 17 | 1 |
| Type3 | 6 | 8.2 | 207.0 | 17 | 1 |
| Type3 | 7 | 7.5 | 443.0 | 17 | 1 |
| Type3 | 8 | 8.1 | 439.0 | 17 | 1 |
| Type3 | 9 | 6.2 | 223.0 | 16 | 1 |
| Type3 | 10 | 8.9 | 208.0 | 18 | 1 |
| Type3 | 11 | 9.6 | 463.0 | 18 | 1 |
| Type3 | 12 | 8.2 | 441.0 | 17 | 1 |
| Type3 | 13 | 7.2 | 323.0 | 16 | 1 |
| Type3 | 14 | 9.5 | 297.0 | 18 | 1 |
| Type3 | 15 | 8.0 | 412.0 | 17 | 1 |
| Type3 | 16 | 10.0 | 324.0 | 18 | 1 |
| Type3 | 17 | 7.4 | 271.0 | 17 | 1 |
| Type3 | 18 | 7.9 | 349.0 | 17 | 1 |
| Type3 | 19 | 7.3 | 409.0 | 16 | 1 |
| Type3 | 20 | 8.7 | 373.0 | 18 | 1 |
| Type3 | 21 | 7.2 | 254.0 | 16 | 1 |
| Type3 | 22 | 9.9 | 274.0 | 18 | 0 |
| Type3 | 23 | 7.9 | 278.0 | 17 | 1 |
| Type3 | 24 | 7.5 | 317.0 | 17 | 0 |
| Type3 | 25 | 6.1 | 260.0 | 16 | 1 |
| Type3 | 26 | 8.8 | 211.0 | 18 | 1 |
| Type3 | 27 | 9.7 | 272.0 | 18 | 1 |
| Type3 | 28 | 7.4 | 264.0 | 17 | 1 |
| Type3 | 29 | 9.2 | 284.0 | 18 | 1 |
| Type4 | 0 | 16.0 | 355.0 | 14 | 1 |
| Type4 | 1 | 11.3 | 487.0 | 12 | 1 |
| Type4 | 2 | 13.5 | 344.0 | 13 | 1 |
| Type4 | 3 | 19.4 | 288.0 | 16 | 1 |
| Type4 | 4 | 17.5 | 230.0 | 15 | 1 |
| Type4 | 5 | 15.3 | 432.0 | 14 | 1 |
| Type4 | 6 | 15.9 | 207.0 | 14 | 1 |
| Type4 | 7 | 14.3 | 443.0 | 13 | 1 |
| Type4 | 8 | 15.8 | 439.0 | 14 | 1 |



Unless otherwise agreed in writing, this document is issued by the Company subject to its General Conditions of Service printed overleaf, available on request or accessible at <http://www.sgs.com/en/Terms-and-Conditions.aspx> and, for electronic format documents, subject to Terms and Conditions for Electronic Documents at <http://www.sgs.com/en/Terms-and-Conditions/Terms-e-Documents.aspx>. Attention is drawn to the limitation of liability, indemnification and jurisdiction issues defined therein. Any holder of this document is advised that information contained herein reflects the Company's findings at the time of its intervention only and within the limits of Client's instructions, if any. The Company's sole responsibility is to its Client and this document does not exonerate parties to a transaction from exercising all their rights and obligations under the transaction documents. This document cannot be reproduced except in full, without prior written approval of the Company. Any unauthorized alteration, forgery or falsification of the content or appearance of this document is unlawful and offenders may be prosecuted to the fullest extent of the law. Unless otherwise stated the results shown in this test report refer only to the sample(s) tested and such sample(s) are retained for 30 days only.

Attention: To check the authenticity of testing / inspection report & certificate, please contact us at telephone: (86-755) 8307 1443, or email: CN_Doche@sgs.com

| | | | | | | | |
|-------------|------|-------|-------|------|--------|----|---|
| | | Type4 | 9 | 11.5 | 223.0 | 12 | 1 |
| | | Type4 | 10 | 17.4 | 208.0 | 15 | 1 |
| | | Type4 | 11 | 19.0 | 463.0 | 16 | 0 |
| | | Type4 | 12 | 16.0 | 441.0 | 14 | 1 |
| | | Type4 | 13 | 13.8 | 323.0 | 13 | 1 |
| | | Type4 | 14 | 18.9 | 297.0 | 16 | 1 |
| | | Type4 | 15 | 15.5 | 412.0 | 14 | 1 |
| | | Type4 | 16 | 19.9 | 324.0 | 16 | 1 |
| | | Type4 | 17 | 14.1 | 271.0 | 13 | 1 |
| | | Type4 | 18 | 15.2 | 349.0 | 14 | 1 |
| | | Type4 | 19 | 13.8 | 409.0 | 13 | 1 |
| | | Type4 | 20 | 17.1 | 373.0 | 15 | 1 |
| | | Type4 | 21 | 13.8 | 254.0 | 13 | 1 |
| | | Type4 | 22 | 19.8 | 274.0 | 16 | 1 |
| | | Type4 | 23 | 15.3 | 278.0 | 14 | 1 |
| | | Type4 | 24 | 14.5 | 317.0 | 13 | 1 |
| | | Type4 | 25 | 11.3 | 260.0 | 12 | 1 |
| | | Type4 | 26 | 17.3 | 211.0 | 15 | 1 |
| | | Type4 | 27 | 19.2 | 272.0 | 16 | 1 |
| | | Type4 | 28 | 14.2 | 264.0 | 13 | 1 |
| | | Type4 | 29 | 18.2 | 284.0 | 15 | 1 |
| 11ax160MIMO | 5570 | Type1 | 0 | 1.0 | 938.0 | 57 | 1 |
| | | Type1 | 1 | 1.0 | 698.0 | 76 | 1 |
| | | Type1 | 2 | 1.0 | 618.0 | 86 | 1 |
| | | Type1 | 3 | 1.0 | 538.0 | 99 | 1 |
| | | Type1 | 4 | 1.0 | 878.0 | 61 | 1 |
| | | Type1 | 5 | 1.0 | 3066.0 | 18 | 1 |
| | | Type1 | 6 | 1.0 | 638.0 | 83 | 1 |
| | | Type1 | 7 | 1.0 | 918.0 | 58 | 1 |
| | | Type1 | 8 | 1.0 | 838.0 | 63 | 1 |
| | | Type1 | 9 | 1.0 | 858.0 | 62 | 1 |
| | | Type1 | 10 | 1.0 | 798.0 | 67 | 0 |
| | | Type1 | 11 | 1.0 | 718.0 | 74 | 1 |
| | | Type1 | 12 | 1.0 | 578.0 | 92 | 1 |
| | | Type1 | 13 | 1.0 | 598.0 | 89 | 0 |
| | | Type1 | 14 | 1.0 | 558.0 | 95 | 1 |
| | | Type1 | 15 | 1.0 | 2536.0 | 21 | 1 |
| | | Type1 | 16 | 1.0 | 966.0 | 55 | 1 |
| | | Type1 | 17 | 1.0 | 827.0 | 64 | 1 |
| | | Type1 | 18 | 1.0 | 2501.0 | 22 | 1 |
| | | Type1 | 19 | 1.0 | 2595.0 | 21 | 1 |
| | | Type1 | 20 | 1.0 | 1114.0 | 48 | 1 |
| | | Type1 | 21 | 1.0 | 1302.0 | 41 | 1 |
| | | Type1 | 22 | 1.0 | 3045.0 | 18 | 1 |
| | | Type1 | 23 | 1.0 | 1624.0 | 33 | 1 |
| | | Type1 | 24 | 1.0 | 2878.0 | 19 | 1 |
| | | Type1 | 25 | 1.0 | 1027.0 | 52 | 1 |
| | | Type1 | 26 | 1.0 | 2485.0 | 22 | 1 |
| | | Type1 | 27 | 1.0 | 1600.0 | 33 | 1 |
| | | Type1 | 28 | 1.0 | 1172.0 | 46 | 1 |
| | | Type1 | 29 | 1.0 | 1177.0 | 45 | 1 |
| | | Type2 | 0 | 3.2 | 179.0 | 26 | 1 |
| | | Type2 | 1 | 1.1 | 207.0 | 23 | 1 |
| Type2 | 2 | 2.1 | 230.0 | 24 | 1 | | |
| Type2 | 3 | 4.8 | 200.0 | 29 | 1 | | |
| Type2 | 4 | 3.9 | 214.0 | 28 | 1 | | |
| Type2 | 5 | 2.9 | 222.0 | 26 | 1 | | |



Unless otherwise agreed in writing, this document is issued by the Company subject to its General Conditions of Service printed overleaf, available on request or accessible at <http://www.sgs.com/en/Terms-and-Conditions.aspx> and, for electronic format documents, subject to Terms and Conditions for Electronic Documents at <http://www.sgs.com/en/Terms-and-Conditions/Terms-e-Documents.aspx>. Attention is drawn to the limitation of liability, indemnification and jurisdiction issues defined therein. Any holder of this document is advised that information contained hereon reflects the Company's findings at the time of its intervention only and within the limits of Client's instructions, if any. The Company's sole responsibility is to its Client and this document does not exonerate parties to a transaction from exercising all their rights and obligations under the transaction documents. This document cannot be reproduced except in full, without prior written approval of the Company. Any unauthorized alteration, forgery or falsification of the content or appearance of this document is unlawful and offenders may be prosecuted to the fullest extent of the law. Unless otherwise stated the results shown in this test report refer only to the sample(s) tested and such sample(s) are retained for 30 days only.

Attention: To check the authenticity of testing / inspection report & certificate, please contact us at telephone: (86-755) 8307 1443, or email: QN.Doche@sgs.com

| | | | | | |
|-------|----|------|-------|----|---|
| Type2 | 6 | 3.2 | 204.0 | 26 | 1 |
| Type2 | 7 | 2.5 | 192.0 | 25 | 1 |
| Type2 | 8 | 3.1 | 164.0 | 26 | 1 |
| Type2 | 9 | 1.2 | 156.0 | 23 | 1 |
| Type2 | 10 | 3.9 | 210.0 | 27 | 1 |
| Type2 | 11 | 4.6 | 201.0 | 29 | 1 |
| Type2 | 12 | 3.2 | 162.0 | 26 | 1 |
| Type2 | 13 | 2.2 | 197.0 | 25 | 0 |
| Type2 | 14 | 4.5 | 163.0 | 29 | 1 |
| Type2 | 15 | 3.0 | 203.0 | 26 | 1 |
| Type2 | 16 | 5.0 | 168.0 | 29 | 1 |
| Type2 | 17 | 2.4 | 217.0 | 25 | 1 |
| Type2 | 18 | 2.9 | 191.0 | 26 | 0 |
| Type2 | 19 | 2.3 | 166.0 | 25 | 1 |
| Type2 | 20 | 3.7 | 150.0 | 27 | 1 |
| Type2 | 21 | 2.2 | 176.0 | 25 | 1 |
| Type2 | 22 | 4.9 | 195.0 | 29 | 1 |
| Type2 | 23 | 2.9 | 202.0 | 26 | 1 |
| Type2 | 24 | 2.5 | 178.0 | 25 | 1 |
| Type2 | 25 | 1.1 | 206.0 | 23 | 1 |
| Type2 | 26 | 3.8 | 155.0 | 27 | 1 |
| Type2 | 27 | 4.7 | 157.0 | 29 | 1 |
| Type2 | 28 | 2.4 | 224.0 | 25 | 1 |
| Type2 | 29 | 4.2 | 159.0 | 28 | 0 |
| Type3 | 0 | 8.2 | 355.0 | 17 | 1 |
| Type3 | 1 | 6.1 | 487.0 | 16 | 1 |
| Type3 | 2 | 7.1 | 344.0 | 16 | 1 |
| Type3 | 3 | 9.8 | 288.0 | 18 | 1 |
| Type3 | 4 | 8.9 | 230.0 | 18 | 1 |
| Type3 | 5 | 7.9 | 432.0 | 17 | 1 |
| Type3 | 6 | 8.2 | 207.0 | 17 | 1 |
| Type3 | 7 | 7.5 | 443.0 | 17 | 1 |
| Type3 | 8 | 8.1 | 439.0 | 17 | 1 |
| Type3 | 9 | 6.2 | 223.0 | 16 | 1 |
| Type3 | 10 | 8.9 | 208.0 | 18 | 0 |
| Type3 | 11 | 9.6 | 463.0 | 18 | 1 |
| Type3 | 12 | 8.2 | 441.0 | 17 | 1 |
| Type3 | 13 | 7.2 | 323.0 | 16 | 1 |
| Type3 | 14 | 9.5 | 297.0 | 18 | 1 |
| Type3 | 15 | 8.0 | 412.0 | 17 | 1 |
| Type3 | 16 | 10.0 | 324.0 | 18 | 1 |
| Type3 | 17 | 7.4 | 271.0 | 17 | 1 |
| Type3 | 18 | 7.9 | 349.0 | 17 | 1 |
| Type3 | 19 | 7.3 | 409.0 | 16 | 1 |
| Type3 | 20 | 8.7 | 373.0 | 18 | 1 |
| Type3 | 21 | 7.2 | 254.0 | 16 | 0 |
| Type3 | 22 | 9.9 | 274.0 | 18 | 1 |
| Type3 | 23 | 7.9 | 278.0 | 17 | 1 |
| Type3 | 24 | 7.5 | 317.0 | 17 | 1 |
| Type3 | 25 | 6.1 | 260.0 | 16 | 1 |
| Type3 | 26 | 8.8 | 211.0 | 18 | 1 |
| Type3 | 27 | 9.7 | 272.0 | 18 | 1 |
| Type3 | 28 | 7.4 | 264.0 | 17 | 1 |
| Type3 | 29 | 9.2 | 284.0 | 18 | 1 |
| Type4 | 0 | 16.0 | 355.0 | 14 | 1 |
| Type4 | 1 | 11.3 | 487.0 | 12 | 1 |
| Type4 | 2 | 13.5 | 344.0 | 13 | 1 |



Unless otherwise agreed in writing, this document is issued by the Company subject to its General Conditions of Service printed overleaf, available on request or accessible at <http://www.sgs.com/en/Terms-and-Conditions.aspx> and, for electronic format documents, subject to Terms and Conditions for Electronic Documents at <http://www.sgs.com/en/Terms-and-Conditions/Terms-e-Documents.aspx>. Attention is drawn to the limitation of liability, indemnification and jurisdiction issues defined therein. Any holder of this document is advised that information contained hereon reflects the Company's findings at the time of its intervention only and within the limits of Client's instructions, if any. The Company's sole responsibility is to its Client and this document does not exonerate parties to a transaction from exercising all their rights and obligations under the transaction documents. This document cannot be reproduced except in full, without prior written approval of the Company. Any unauthorized alteration, forgery or falsification of the content or appearance of this document is unlawful and offenders may be prosecuted to the fullest extent of the law. Unless otherwise stated the results shown in this test report refer only to the sample(s) tested and such sample(s) are retained for 30 days only.

Attention: To check the authenticity of testing /inspection report & certificate, please contact us at telephone: (86-755) 8307 1443, or email: Q.N.Dochehe@sgs.com

| | | | | | |
|-------|----|------|-------|----|---|
| Type4 | 3 | 19.4 | 288.0 | 16 | 1 |
| Type4 | 4 | 17.5 | 230.0 | 15 | 1 |
| Type4 | 5 | 15.3 | 432.0 | 14 | 1 |
| Type4 | 6 | 15.9 | 207.0 | 14 | 0 |
| Type4 | 7 | 14.3 | 443.0 | 13 | 1 |
| Type4 | 8 | 15.8 | 439.0 | 14 | 1 |
| Type4 | 9 | 11.5 | 223.0 | 12 | 1 |
| Type4 | 10 | 17.4 | 208.0 | 15 | 1 |
| Type4 | 11 | 19.0 | 463.0 | 16 | 1 |
| Type4 | 12 | 16.0 | 441.0 | 14 | 1 |
| Type4 | 13 | 13.8 | 323.0 | 13 | 1 |
| Type4 | 14 | 18.9 | 297.0 | 16 | 1 |
| Type4 | 15 | 15.5 | 412.0 | 14 | 1 |
| Type4 | 16 | 19.9 | 324.0 | 16 | 1 |
| Type4 | 17 | 14.1 | 271.0 | 13 | 1 |
| Type4 | 18 | 15.2 | 349.0 | 14 | 1 |
| Type4 | 19 | 13.8 | 409.0 | 13 | 1 |
| Type4 | 20 | 17.1 | 373.0 | 15 | 1 |
| Type4 | 21 | 13.8 | 254.0 | 13 | 1 |
| Type4 | 22 | 19.8 | 274.0 | 16 | 1 |
| Type4 | 23 | 15.3 | 278.0 | 14 | 0 |
| Type4 | 24 | 14.5 | 317.0 | 13 | 1 |
| Type4 | 25 | 11.3 | 260.0 | 12 | 1 |
| Type4 | 26 | 17.3 | 211.0 | 15 | 1 |
| Type4 | 27 | 19.2 | 272.0 | 16 | 1 |
| Type4 | 28 | 14.2 | 264.0 | 13 | 1 |
| Type4 | 29 | 18.2 | 284.0 | 15 | 1 |



Unless otherwise agreed in writing, this document is issued by the Company subject to its General Conditions of Service printed overleaf, available on request or accessible at <http://www.sgs.com/en/Terms-and-Conditions.aspx> and, for electronic format documents, subject to Terms and Conditions for Electronic Documents at <http://www.sgs.com/en/Terms-and-Conditions/Terms-e-Documents.aspx>. Attention is drawn to the limitation of liability, indemnification and jurisdiction issues defined therein. Any holder of this document is advised that information contained hereon reflects the Company's findings at the time of its intervention only and within the limits of Client's instructions, if any. The Company's sole responsibility is to its Client and this document does not exonerate parties to a transaction from exercising all their rights and obligations under the transaction documents. This document cannot be reproduced except in full, without prior written approval of the Company. Any unauthorized alteration, forgery or falsification of the content or appearance of this document is unlawful and offenders may be prosecuted to the fullest extent of the law. Unless otherwise stated the results shown in this test report refer only to the sample(s) tested and such sample(s) are retained for 30 days only.

Attention: To check the authenticity of testing /inspection report & certificate, please contact us at telephone: (86-755) 8307 1443, or email: CN.Doccheck@sgs.com

South of No. 6 Plant, No. 1, Runsheng Road, Suzhou Industrial Park, Suzhou Area, China (Jiangsu) Pilot Free Trade Zone 215000 t (86-512) 62992980 www.sgs.com
 中国·苏州·中国 (江苏) 自由贸易试验区苏州片区苏州工业园区润胜路1号的6号厂房南楼 邮编: 215000 t (86-512) 62992980 sgs.china@sgs.com

| @FCC_RLAN_DFS_SPC_Radar_T5_SP2_Tr0@ | | | | | | | | | | | |
|-------------------------------------|---------|------------|----------|----------|-------------------|-------------------|------------------|------------------|-----------|-----------|-----------|
| TestMode | Channel | Radar Type | Trial ID | Burst ID | Burst Offset (μs) | Chirp Width (MHz) | Number Of Pulses | Pulse Width (μs) | PRI1 (μs) | PRI2 (μs) | PRI3 (μs) |
| 11ax20MIMO | 5500 | Type5 | 0 | 0 | 636185.0 | 13 | 2 | 77.8 | 1665.0 | 1477.0 | --- |
| 11ax20MIMO | 5500 | Type5 | 0 | 1 | 32674.0 | 13 | 1 | 51.9 | 1074.0 | --- | --- |
| 11ax20MIMO | 5500 | Type5 | 0 | 2 | 226294.0 | 13 | 1 | 63.8 | 1584.0 | --- | --- |
| 11ax20MIMO | 5500 | Type5 | 0 | 3 | 417976.0 | 13 | 3 | 96.6 | 1682.0 | 1786.0 | 1843.0 |
| 11ax20MIMO | 5500 | Type5 | 0 | 4 | 611152.0 | 13 | 3 | 85.9 | 1795.0 | 1215.0 | 1729.0 |
| 11ax20MIMO | 5500 | Type5 | 0 | 5 | 8789.0 | 13 | 2 | 73.7 | 1198.0 | 1549.0 | --- |
| 11ax20MIMO | 5500 | Type5 | 0 | 6 | 201917.0 | 13 | 2 | 77.2 | 1837.0 | 1819.0 | --- |
| 11ax20MIMO | 5500 | Type5 | 0 | 7 | 395530.0 | 13 | 2 | 68.4 | 1587.0 | 1114.0 | --- |
| 11ax20MIMO | 5500 | Type5 | 0 | 8 | 588564.0 | 13 | 2 | 76.7 | 2000.0 | 1155.0 | --- |
| 11ax20MIMO | 5500 | Type5 | 0 | 9 | 783794.0 | 13 | 1 | 53.2 | 1147.0 | --- | --- |
| 11ax20MIMO | 5500 | Type5 | 0 | 10 | 177933.0 | 13 | 3 | 85.7 | 1433.0 | 1695.0 | 1394.0 |
| 11ax20MIMO | 5500 | Type5 | 0 | 11 | 370624.0 | 13 | 3 | 94.3 | 1670.0 | 1426.0 | 1935.0 |
| 11ax20MIMO | 5500 | Type5 | 0 | 12 | 564893.0 | 13 | 2 | 77.6 | 1294.0 | 1671.0 | --- |
| 11ax20MIMO | 5500 | Type5 | 0 | 13 | 759583.0 | 13 | 1 | 65.7 | 1512.0 | --- | --- |
| 11ax20MIMO | 5500 | Type5 | 0 | 14 | 154262.0 | 13 | 3 | 93.5 | 1444.0 | 1130.0 | 1468.0 |
| 11ax40MIMO | 5510 | Type5 | 0 | 0 | 636185.0 | 13 | 2 | 77.8 | 1665.0 | 1477.0 | --- |
| 11ax40MIMO | 5510 | Type5 | 0 | 1 | 32674.0 | 13 | 1 | 51.9 | 1074.0 | --- | --- |
| 11ax40MIMO | 5510 | Type5 | 0 | 2 | 226294.0 | 13 | 1 | 63.8 | 1584.0 | --- | --- |
| 11ax40MIMO | 5510 | Type5 | 0 | 3 | 417976.0 | 13 | 3 | 96.6 | 1682.0 | 1786.0 | 1843.0 |
| 11ax40MIMO | 5510 | Type5 | 0 | 4 | 611152.0 | 13 | 3 | 85.9 | 1795.0 | 1215.0 | 1729.0 |
| 11ax40MIMO | 5510 | Type5 | 0 | 5 | 8789.0 | 13 | 2 | 73.7 | 1198.0 | 1549.0 | --- |
| 11ax40MIMO | 5510 | Type5 | 0 | 6 | 201917.0 | 13 | 2 | 77.2 | 1837.0 | 1819.0 | --- |
| 11ax40MIMO | 5510 | Type5 | 0 | 7 | 395530.0 | 13 | 2 | 68.4 | 1587.0 | 1114.0 | --- |
| 11ax40MIMO | 5510 | Type5 | 0 | 8 | 588564.0 | 13 | 2 | 76.7 | 2000.0 | 1155.0 | --- |
| 11ax40MIMO | 5510 | Type5 | 0 | 9 | 783794.0 | 13 | 1 | 53.2 | 1147.0 | --- | --- |
| 11ax40MIMO | 5510 | Type5 | 0 | 10 | 177933.0 | 13 | 3 | 85.7 | 1433.0 | 1695.0 | 1394.0 |
| 11ax40MIMO | 5510 | Type5 | 0 | 11 | 370624.0 | 13 | 3 | 94.3 | 1670.0 | 1426.0 | 1935.0 |
| 11ax40MIMO | 5510 | Type5 | 0 | 12 | 564893.0 | 13 | 2 | 77.6 | 1294.0 | 1671.0 | --- |
| 11ax40MIMO | 5510 | Type5 | 0 | 13 | 759583.0 | 13 | 1 | 65.7 | 1512.0 | --- | --- |
| 11ax40MIMO | 5510 | Type5 | 0 | 14 | 154262.0 | 13 | 3 | 93.5 | 1444.0 | 1130.0 | 1468.0 |
| 11ax80MIMO | 5530 | Type5 | 0 | 0 | 636185.0 | 13 | 2 | 77.8 | 1665.0 | 1477.0 | --- |
| 11ax80MIMO | 5530 | Type5 | 0 | 1 | 32674.0 | 13 | 1 | 51.9 | 1074.0 | --- | --- |
| 1AX80MIMO | 5530 | Type5 | 0 | 2 | 226294.0 | 13 | 1 | 63.8 | 1584.0 | --- | --- |
| 1AX80MIMO | 5530 | Type5 | 0 | 3 | 417976.0 | 13 | 3 | 96.6 | 1682.0 | 1786.0 | 1843.0 |
| 1AX80MIMO | 5530 | Type5 | 0 | 4 | 611152.0 | 13 | 3 | 85.9 | 1795.0 | 1215.0 | 1729.0 |
| 1AX80MIMO | 5530 | Type5 | 0 | 5 | 8789.0 | 13 | 2 | 73.7 | 1198.0 | 1549.0 | --- |
| 1AX80MIMO | 5530 | Type5 | 0 | 6 | 201917.0 | 13 | 2 | 77.2 | 1837.0 | 1819.0 | --- |
| 1AX80MIMO | 5530 | Type5 | 0 | 7 | 395530.0 | 13 | 2 | 68.4 | 1587.0 | 1114.0 | --- |
| 1AX80MIMO | 5530 | Type5 | 0 | 8 | 588564.0 | 13 | 2 | 76.7 | 2000.0 | 1155.0 | --- |
| 1AX80MIMO | 5530 | Type5 | 0 | 9 | 783794.0 | 13 | 1 | 53.2 | 1147.0 | --- | --- |
| 1AX80MIMO | 5530 | Type5 | 0 | 10 | 177933.0 | 13 | 3 | 85.7 | 1433.0 | 1695.0 | 1394.0 |
| 1AX80MIMO | 5530 | Type5 | 0 | 11 | 370624.0 | 13 | 3 | 94.3 | 1670.0 | 1426.0 | 1935.0 |
| 1AX80MIMO | 5530 | Type5 | 0 | 12 | 564893.0 | 13 | 2 | 77.6 | 1294.0 | 1671.0 | --- |
| 1AX80MIMO | 5530 | Type5 | 0 | 13 | 759583.0 | 13 | 1 | 65.7 | 1512.0 | --- | --- |
| 1AX80MIMO | 5530 | Type5 | 0 | 14 | 154262.0 | 13 | 3 | 93.5 | 1444.0 | 1130.0 | 1468.0 |
| 11ax160MIMO | 5570 | Type5 | 0 | 0 | 636185.0 | 13 | 2 | 77.8 | 1665.0 | 1477.0 | --- |
| 11ax160MIMO | 5570 | Type5 | 0 | 1 | 32674.0 | 13 | 1 | 51.9 | 1074.0 | --- | --- |
| 11ax160MIMO | 5570 | Type5 | 0 | 2 | 226294.0 | 13 | 1 | 63.8 | 1584.0 | --- | --- |
| 11ax160MIMO | 5570 | Type5 | 0 | 3 | 417976.0 | 13 | 3 | 96.6 | 1682.0 | 1786.0 | 1843.0 |
| 11ax160MIMO | 5570 | Type5 | 0 | 4 | 611152.0 | 13 | 3 | 85.9 | 1795.0 | 1215.0 | 1729.0 |
| 11ax160MIMO | 5570 | Type5 | 0 | 5 | 8789.0 | 13 | 2 | 73.7 | 1198.0 | 1549.0 | --- |
| 11ax160MIMO | 5570 | Type5 | 0 | 6 | 201917.0 | 13 | 2 | 77.2 | 1837.0 | 1819.0 | --- |
| 11ax160MIMO | 5570 | Type5 | 0 | 7 | 395530.0 | 13 | 2 | 68.4 | 1587.0 | 1114.0 | --- |
| 11ax160MIMO | 5570 | Type5 | 0 | 8 | 588564.0 | 13 | 2 | 76.7 | 2000.0 | 1155.0 | --- |
| 11ax160MIMO | 5570 | Type5 | 0 | 9 | 783794.0 | 13 | 1 | 53.2 | 1147.0 | --- | --- |
| 11ax160MIMO | 5570 | Type5 | 0 | 10 | 177933.0 | 13 | 3 | 85.7 | 1433.0 | 1695.0 | 1394.0 |



Unless otherwise agreed in writing, this document is issued by the Company subject to its General Conditions of Service printed overleaf, available on request or accessible at <http://www.sgs.com/en/Terms-and-Conditions.aspx> and, for electronic format documents, subject to Terms and Conditions for Electronic Documents at <http://www.sgs.com/en/Terms-and-Conditions/Terms-e-Documents.aspx>. Attention is drawn to the limitation of liability, indemnification and jurisdiction issues defined therein. Any holder of this document is advised that information contained hereon reflects the Company's findings at the time of its intervention only and within the limits of Client's instructions, if any. The Company's sole responsibility is to its Client and this document does not exonerate parties to a transaction from exercising all their rights and obligations under the transaction documents. This document cannot be reproduced except in full, without prior written approval of the Company. Any unauthorized alteration, forgery or falsification of the content or appearance of this document is unlawful and offenders may be prosecuted to the fullest extent of the law. Unless otherwise stated the results shown in this test report refer only to the sample(s) tested and such sample(s) are retained for 30 days only.

Attention: To check the authenticity of testing/inspection report & certificate, please contact us at telephone: (86-755) 8307 1443, or email: QN.Doccheck@sgs.com

South of No. 6 Plant, No. 1, Runsheng Road, Suzhou Industrial Park, Suzhou Area, China (Jiangsu) Pilot Free Trade Zone 215000 t (86-512) 62992980 www.sgsqgroup.com.cn
 中国·苏州·中国（江苏）自由贸易试验区苏州片区苏州工业园区润胜路1号的6号厂房南座 邮编：215000 t (86-512) 62992980 sgs.china@sgs.com

| | | | | | | | | | | | |
|-------------|------|-------|---|----|----------|----|---|------|--------|--------|--------|
| 11ax160MIMO | 5570 | Type5 | 0 | 11 | 370624.0 | 13 | 3 | 94.3 | 1670.0 | 1426.0 | 1935.0 |
| 11ax160MIMO | 5570 | Type5 | 0 | 12 | 564893.0 | 13 | 2 | 77.6 | 1294.0 | 1671.0 | --- |
| 11ax160MIMO | 5570 | Type5 | 0 | 13 | 759583.0 | 13 | 1 | 65.7 | 1512.0 | --- | --- |
| 11ax160MIMO | 5570 | Type5 | 0 | 14 | 154262.0 | 13 | 3 | 93.5 | 1444.0 | 1130.0 | 1468.0 |

| @FCC_RLAN_DFS_SPC_Radar_T5_SP2_Tr1@ | | | | | | | | | | | |
|-------------------------------------|---------|------------|----------|----------|-------------------|-------------------|------------------|------------------|-----------|-----------|-----------|
| TestMode | Channel | Radar Type | Trial ID | Burst ID | Burst Offset (μs) | Chirp Width (MHz) | Number Of Pulses | Pulse Width (μs) | PRI1 (μs) | PRI2 (μs) | PRI3 (μs) |
| 11ax20MIMO | 5500 | Type5 | 1 | 0 | 653020.0 | 5 | 2 | 75.0 | 1880.0 | 1527.0 | --- |
| 11ax20MIMO | 5500 | Type5 | 1 | 1 | 1015643.0 | 5 | 3 | 99.4 | 1401.0 | 1262.0 | 1257.0 |
| 11ax20MIMO | 5500 | Type5 | 1 | 2 | 1379398.0 | 5 | 2 | 67.4 | 1531.0 | 1403.0 | --- |
| 11ax20MIMO | 5500 | Type5 | 1 | 3 | 245489.0 | 5 | 2 | 73.6 | 1449.0 | 1041.0 | --- |
| 11ax20MIMO | 5500 | Type5 | 1 | 4 | 609113.0 | 5 | 1 | 65.9 | 1432.0 | --- | --- |
| 11ax20MIMO | 5500 | Type5 | 1 | 5 | 970852.0 | 5 | 3 | 83.8 | 1356.0 | 1292.0 | 1419.0 |
| 11ax20MIMO | 5500 | Type5 | 1 | 6 | 1335913.0 | 5 | 1 | 65.5 | 1543.0 | --- | --- |
| 11ax20MIMO | 5500 | Type5 | 1 | 7 | 200406.0 | 5 | 3 | 98.6 | 1548.0 | 1796.0 | 1728.0 |
| 11ax40MIMO | 5510 | Type5 | 1 | 0 | 653020.0 | 5 | 2 | 75.0 | 1880.0 | 1527.0 | --- |
| 11ax40MIMO | 5510 | Type5 | 1 | 1 | 1015643.0 | 5 | 3 | 99.4 | 1401.0 | 1262.0 | 1257.0 |
| 11ax40MIMO | 5510 | Type5 | 1 | 2 | 1379398.0 | 5 | 2 | 67.4 | 1531.0 | 1403.0 | --- |
| 11ax40MIMO | 5510 | Type5 | 1 | 3 | 245489.0 | 5 | 2 | 73.6 | 1449.0 | 1041.0 | --- |
| 11ax40MIMO | 5510 | Type5 | 1 | 4 | 609113.0 | 5 | 1 | 65.9 | 1432.0 | --- | --- |
| 11ax40MIMO | 5510 | Type5 | 1 | 5 | 970852.0 | 5 | 3 | 83.8 | 1356.0 | 1292.0 | 1419.0 |
| 11ax40MIMO | 5510 | Type5 | 1 | 6 | 1335913.0 | 5 | 1 | 65.5 | 1543.0 | --- | --- |
| 11ax40MIMO | 5510 | Type5 | 1 | 7 | 200406.0 | 5 | 3 | 98.6 | 1548.0 | 1796.0 | 1728.0 |
| 11ax80MIMO | 5530 | Type5 | 1 | 0 | 653020.0 | 5 | 2 | 75.0 | 1880.0 | 1527.0 | --- |
| 11ax80MIMO | 5530 | Type5 | 1 | 1 | 1015643.0 | 5 | 3 | 99.4 | 1401.0 | 1262.0 | 1257.0 |
| 11ax80MIMO | 5530 | Type5 | 1 | 2 | 1379398.0 | 5 | 2 | 67.4 | 1531.0 | 1403.0 | --- |
| 11ax80MIMO | 5530 | Type5 | 1 | 3 | 245489.0 | 5 | 2 | 73.6 | 1449.0 | 1041.0 | --- |
| 11ax80MIMO | 5530 | Type5 | 1 | 4 | 609113.0 | 5 | 1 | 65.9 | 1432.0 | --- | --- |
| 11ax80MIMO | 5530 | Type5 | 1 | 5 | 970852.0 | 5 | 3 | 83.8 | 1356.0 | 1292.0 | 1419.0 |
| 11ax80MIMO | 5530 | Type5 | 1 | 6 | 1335913.0 | 5 | 1 | 65.5 | 1543.0 | --- | --- |
| 11ax80MIMO | 5530 | Type5 | 1 | 7 | 200406.0 | 5 | 3 | 98.6 | 1548.0 | 1796.0 | 1728.0 |
| 11ax160MIMO | 5570 | Type5 | 1 | 0 | 653020.0 | 5 | 2 | 75.0 | 1880.0 | 1527.0 | --- |
| 11ax160MIMO | 5570 | Type5 | 1 | 1 | 1015643.0 | 5 | 3 | 99.4 | 1401.0 | 1262.0 | 1257.0 |
| 11ax160MIMO | 5570 | Type5 | 1 | 2 | 1379398.0 | 5 | 2 | 67.4 | 1531.0 | 1403.0 | --- |
| 11ax160MIMO | 5570 | Type5 | 1 | 3 | 245489.0 | 5 | 2 | 73.6 | 1449.0 | 1041.0 | --- |
| 11ax160MIMO | 5570 | Type5 | 1 | 4 | 609113.0 | 5 | 1 | 65.9 | 1432.0 | --- | --- |
| 11ax160MIMO | 5570 | Type5 | 1 | 5 | 970852.0 | 5 | 3 | 83.8 | 1356.0 | 1292.0 | 1419.0 |
| 11ax160MIMO | 5570 | Type5 | 1 | 6 | 1335913.0 | 5 | 1 | 65.5 | 1543.0 | --- | --- |
| 11ax160MIMO | 5570 | Type5 | 1 | 7 | 200406.0 | 5 | 3 | 98.6 | 1548.0 | 1796.0 | 1728.0 |



Unless otherwise agreed in writing, this document is issued by the Company subject to its General Conditions of Service printed overleaf, available on request or accessible at <http://www.sgs.com/en/Terms-and-Conditions.aspx> and, for electronic format documents, subject to Terms and Conditions for Electronic Documents at <http://www.sgs.com/en/Terms-and-Conditions/Terms-e-Documents.aspx>. Attention is drawn to the limitation of liability, indemnification and jurisdiction issues defined therein. Any holder of this document is advised that information contained hereon reflects the Company's findings at the time of its intervention only and within the limits of Client's instructions, if any. The Company's sole responsibility is to its Client and this document does not exonerate parties to a transaction from exercising all their rights and obligations under the transaction documents. This document cannot be reproduced except in full, without prior written approval of the Company. Any unauthorized alteration, forgery or falsification of the content or appearance of this document is unlawful and offenders may be prosecuted to the fullest extent of the law. Unless otherwise stated the results shown in this test report refer only to the sample(s) tested and such sample(s) are retained for 30 days only.

Attention: To check the authenticity of testing / inspection report & certificate, please contact us at telephone: (86-755) 8307 1443, or email: Q.N.Doccheck@sgs.com

SGS-CSTC Standards Technical Services (Suzhou) Co., Ltd.
Wireless Laboratories

South of No. 6 Plant, No. 1, Runsheng Road, Suzhou Industrial Park, Suzhou Area, China (Jiangsu) Pilot Free Trade Zone 215000 t (86-512) 62992980 www.sgs.com.cn
中国·苏州·中国(江苏)自由贸易试验区苏州片区苏州工业园区润胜路1号的6号厂房南楼 邮编: 215000 t (86-512) 62992980 sgs.china@sgs.com

| @FCC_RLAN_DFS_SPC_Radar_T5_SP2_Tr2@ | | | | | | | | | | | |
|-------------------------------------|---------|------------|----------|----------|-------------------|-------------------|------------------|------------------|-----------|-----------|-----------|
| TestMode | Channel | Radar Type | Trial ID | Burst ID | Burst Offset (μs) | Chirp Width (MHz) | Number Of Pulses | Pulse Width (μs) | PRI1 (μs) | PRI2 (μs) | PRI3 (μs) |
| 11ax20MIMO | 5500 | Type5 | 2 | 0 | 409565.0 | 9 | 2 | 73.8 | 1806.0 | 1538.0 | --- |
| 11ax20MIMO | 5500 | Type5 | 2 | 1 | 673692.0 | 9 | 2 | 69.5 | 1117.0 | 1649.0 | --- |
| 11ax20MIMO | 5500 | Type5 | 2 | 2 | 938562.0 | 9 | 1 | 51.9 | 1651.0 | --- | --- |
| 11ax20MIMO | 5500 | Type5 | 2 | 3 | 113209.0 | 9 | 3 | 84.6 | 1976.0 | 1032.0 | 1271.0 |
| 11ax20MIMO | 5500 | Type5 | 2 | 4 | 376726.0 | 9 | 3 | 95.4 | 1060.0 | 1903.0 | 1388.0 |
| 11ax20MIMO | 5500 | Type5 | 2 | 5 | 641212.0 | 9 | 2 | 68.0 | 1368.0 | 1351.0 | --- |
| 11ax20MIMO | 5500 | Type5 | 2 | 6 | 903714.0 | 9 | 3 | 89.6 | 1338.0 | 1514.0 | 1573.0 |
| 11ax20MIMO | 5500 | Type5 | 2 | 7 | 80863.0 | 9 | 2 | 81.9 | 1022.0 | 1689.0 | --- |
| 11ax20MIMO | 5500 | Type5 | 2 | 8 | 344067.0 | 9 | 3 | 88.3 | 1810.0 | 1330.0 | 1838.0 |
| 11ax20MIMO | 5500 | Type5 | 2 | 9 | 609331.0 | 9 | 1 | 53.7 | 1597.0 | --- | --- |
| 11ax20MIMO | 5500 | Type5 | 2 | 10 | 871542.0 | 9 | 3 | 91.3 | 1961.0 | 1106.0 | 1001.0 |
| 11ax40MIMO | 5510 | Type5 | 2 | 0 | 409565.0 | 9 | 2 | 73.8 | 1806.0 | 1538.0 | --- |
| 11ax40MIMO | 5510 | Type5 | 2 | 1 | 673692.0 | 9 | 2 | 69.5 | 1117.0 | 1649.0 | --- |
| 11ax40MIMO | 5510 | Type5 | 2 | 2 | 938562.0 | 9 | 1 | 51.9 | 1651.0 | --- | --- |
| 11ax40MIMO | 5510 | Type5 | 2 | 3 | 113209.0 | 9 | 3 | 84.6 | 1976.0 | 1032.0 | 1271.0 |
| 11ax40MIMO | 5510 | Type5 | 2 | 4 | 376726.0 | 9 | 3 | 95.4 | 1060.0 | 1903.0 | 1388.0 |
| 11ax40MIMO | 5510 | Type5 | 2 | 5 | 641212.0 | 9 | 2 | 68.0 | 1368.0 | 1351.0 | --- |
| 11ax40MIMO | 5510 | Type5 | 2 | 6 | 903714.0 | 9 | 3 | 89.6 | 1338.0 | 1514.0 | 1573.0 |
| 11ax40MIMO | 5510 | Type5 | 2 | 7 | 80863.0 | 9 | 2 | 81.9 | 1022.0 | 1689.0 | --- |
| 11ax40MIMO | 5510 | Type5 | 2 | 8 | 344067.0 | 9 | 3 | 88.3 | 1810.0 | 1330.0 | 1838.0 |
| 11ax40MIMO | 5510 | Type5 | 2 | 9 | 609331.0 | 9 | 1 | 53.7 | 1597.0 | --- | --- |
| 11ax40MIMO | 5510 | Type5 | 2 | 10 | 871542.0 | 9 | 3 | 91.3 | 1961.0 | 1106.0 | 1001.0 |
| 11ax80MIMO | 5530 | Type5 | 2 | 0 | 409565.0 | 9 | 2 | 73.8 | 1806.0 | 1538.0 | --- |
| 11ax80MIMO | 5530 | Type5 | 2 | 1 | 673692.0 | 9 | 2 | 69.5 | 1117.0 | 1649.0 | --- |
| 11ax80MIMO | 5530 | Type5 | 2 | 2 | 938562.0 | 9 | 1 | 51.9 | 1651.0 | --- | --- |
| 11ax80MIMO | 5530 | Type5 | 2 | 3 | 113209.0 | 9 | 3 | 84.6 | 1976.0 | 1032.0 | 1271.0 |
| 11ax80MIMO | 5530 | Type5 | 2 | 4 | 376726.0 | 9 | 3 | 95.4 | 1060.0 | 1903.0 | 1388.0 |
| 11ax80MIMO | 5530 | Type5 | 2 | 5 | 641212.0 | 9 | 2 | 68.0 | 1368.0 | 1351.0 | --- |
| 11ax80MIMO | 5530 | Type5 | 2 | 6 | 903714.0 | 9 | 3 | 89.6 | 1338.0 | 1514.0 | 1573.0 |
| 11ax80MIMO | 5530 | Type5 | 2 | 7 | 80863.0 | 9 | 2 | 81.9 | 1022.0 | 1689.0 | --- |
| 11ax80MIMO | 5530 | Type5 | 2 | 8 | 344067.0 | 9 | 3 | 88.3 | 1810.0 | 1330.0 | 1838.0 |
| 11ax80MIMO | 5530 | Type5 | 2 | 9 | 609331.0 | 9 | 1 | 53.7 | 1597.0 | --- | --- |
| 11ax80MIMO | 5530 | Type5 | 2 | 10 | 871542.0 | 9 | 3 | 91.3 | 1961.0 | 1106.0 | 1001.0 |
| 11ax160MIMO | 5570 | Type5 | 2 | 0 | 409565.0 | 9 | 2 | 73.8 | 1806.0 | 1538.0 | --- |
| 11ax160MIMO | 5570 | Type5 | 2 | 1 | 673692.0 | 9 | 2 | 69.5 | 1117.0 | 1649.0 | --- |
| 11ax160MIMO | 5570 | Type5 | 2 | 2 | 938562.0 | 9 | 1 | 51.9 | 1651.0 | --- | --- |
| 11ax160MIMO | 5570 | Type5 | 2 | 3 | 113209.0 | 9 | 3 | 84.6 | 1976.0 | 1032.0 | 1271.0 |
| 11ax160MIMO | 5570 | Type5 | 2 | 4 | 376726.0 | 9 | 3 | 95.4 | 1060.0 | 1903.0 | 1388.0 |
| 11ax160MIMO | 5570 | Type5 | 2 | 5 | 641212.0 | 9 | 2 | 68.0 | 1368.0 | 1351.0 | --- |
| 11ax160MIMO | 5570 | Type5 | 2 | 6 | 903714.0 | 9 | 3 | 89.6 | 1338.0 | 1514.0 | 1573.0 |
| 11ax160MIMO | 5570 | Type5 | 2 | 7 | 80863.0 | 9 | 2 | 81.9 | 1022.0 | 1689.0 | --- |
| 11ax160MIMO | 5570 | Type5 | 2 | 8 | 344067.0 | 9 | 3 | 88.3 | 1810.0 | 1330.0 | 1838.0 |
| 11ax160MIMO | 5570 | Type5 | 2 | 9 | 609331.0 | 9 | 1 | 53.7 | 1597.0 | --- | --- |
| 11ax160MIMO | 5570 | Type5 | 2 | 10 | 871542.0 | 9 | 3 | 91.3 | 1961.0 | 1106.0 | 1001.0 |



Unless otherwise agreed in writing, this document is issued by the Company subject to its General Conditions of Service printed overleaf, available on request or accessible at <http://www.sgs.com/en/Terms-and-Conditions.aspx> and, for electronic format documents, subject to Terms and Conditions for Electronic Documents at <http://www.sgs.com/en/Terms-and-Conditions/Terms-e-Documents.aspx>. Attention is drawn to the limitation of liability, indemnification and jurisdiction issues defined therein. Any holder of this document is advised that information contained herein reflects the Company's findings at the time of its intervention only and within the limits of Client's instructions, if any. The Company's sole responsibility is to its Client and this document does not exonerate parties to a transaction from exercising all their rights and obligations under the transaction documents. This document cannot be reproduced except in full, without prior written approval of the Company. Any unauthorized alteration, forgery or falsification of the content or appearance of this document is unlawful and offenders may be prosecuted to the fullest extent of the law. Unless otherwise stated the results shown in this test report refer only to the sample(s) tested and such sample(s) are retained for 30 days only.

Attention: To check the authenticity of testing /inspection report & certificate, please contact us at telephone: (86-755) 8307 1443, or email: QN.Doccheck@sgs.com

South of No. 6 Plant, No. 1, Runsheng Road, Suzhou Industrial Park, Suzhou Area, China (Jiangsu) Pilot Free Trade Zone 215000 t (86-512) 62992980 www.sgsgroup.com.cn
 中国·苏州·中国(江苏)自由贸易试验区苏州片区苏州工业园区润胜路1号的6号厂房南楼 邮编: 215000 t (86-512) 62992980 sgs.china@sgs.com

| @FCC_RLAN_DFS_SPC_Radar_T5_SP2_Tr3@ | | | | | | | | | | | |
|-------------------------------------|---------|------------|----------|----------|-------------------|-------------------|------------------|------------------|-----------|-----------|-----------|
| TestMode | Channel | Radar Type | Trial ID | Burst ID | Burst Offset (μs) | Chirp Width (MHz) | Number Of Pulses | Pulse Width (μs) | PRI1 (μs) | PRI2 (μs) | PRI3 (μs) |
| 11ax20MIMO | 5500 | Type5 | 3 | 0 | 26541.0 | 19 | 2 | 68.1 | 1339.0 | 1355.0 | --- |
| 11ax20MIMO | 5500 | Type5 | 3 | 1 | 171821.0 | 19 | 1 | 58.7 | 1251.0 | --- | --- |
| 11ax20MIMO | 5500 | Type5 | 3 | 2 | 316229.0 | 19 | 2 | 75.3 | 1136.0 | 1640.0 | --- |
| 11ax20MIMO | 5500 | Type5 | 3 | 3 | 461864.0 | 19 | 1 | 56.4 | 1753.0 | --- | --- |
| 11ax20MIMO | 5500 | Type5 | 3 | 4 | 8677.0 | 19 | 3 | 99.7 | 1196.0 | 1708.0 | 1159.0 |
| 11ax20MIMO | 5500 | Type5 | 3 | 5 | 153995.0 | 19 | 1 | 57.7 | 1013.0 | --- | --- |
| 11ax20MIMO | 5500 | Type5 | 3 | 6 | 299238.0 | 19 | 1 | 59.5 | 1072.0 | --- | --- |
| 11ax20MIMO | 5500 | Type5 | 3 | 7 | 443177.0 | 19 | 2 | 80.0 | 1482.0 | 1369.0 | --- |
| 11ax20MIMO | 5500 | Type5 | 3 | 8 | 587671.0 | 19 | 2 | 82.0 | 1993.0 | 1197.0 | --- |
| 11ax20MIMO | 5500 | Type5 | 3 | 9 | 135674.0 | 19 | 2 | 82.8 | 1883.0 | 1005.0 | --- |
| 11ax20MIMO | 5500 | Type5 | 3 | 10 | 279928.0 | 19 | 3 | 88.0 | 1061.0 | 1928.0 | 1101.0 |
| 11ax20MIMO | 5500 | Type5 | 3 | 11 | 424279.0 | 19 | 3 | 93.2 | 1207.0 | 1907.0 | 1223.0 |
| 11ax20MIMO | 5500 | Type5 | 3 | 12 | 570132.0 | 19 | 2 | 70.4 | 1526.0 | 1360.0 | --- |
| 11ax20MIMO | 5500 | Type5 | 3 | 13 | 117439.0 | 19 | 3 | 95.3 | 1171.0 | 1955.0 | 1775.0 |
| 11ax20MIMO | 5500 | Type5 | 3 | 14 | 262502.0 | 19 | 2 | 81.9 | 1690.0 | 1545.0 | --- |
| 11ax20MIMO | 5500 | Type5 | 3 | 15 | 406573.0 | 19 | 3 | 98.5 | 1975.0 | 1169.0 | 1062.0 |
| 11ax20MIMO | 5500 | Type5 | 3 | 16 | 553328.0 | 19 | 1 | 65.0 | 1767.0 | --- | --- |
| 11ax20MIMO | 5500 | Type5 | 3 | 17 | 99799.0 | 19 | 3 | 85.4 | 1011.0 | 1637.0 | 1425.0 |
| 11ax20MIMO | 5500 | Type5 | 3 | 18 | 244095.0 | 19 | 3 | 91.6 | 1878.0 | 1445.0 | 1325.0 |
| 11ax20MIMO | 5500 | Type5 | 3 | 19 | 390012.0 | 19 | 2 | 67.3 | 1091.0 | 1218.0 | --- |
| 11ax40MIMO | 5510 | Type5 | 3 | 0 | 26541.0 | 19 | 2 | 68.1 | 1339.0 | 1355.0 | --- |
| 11ax40MIMO | 5510 | Type5 | 3 | 1 | 171821.0 | 19 | 1 | 58.7 | 1251.0 | --- | --- |
| 11ax40MIMO | 5510 | Type5 | 3 | 2 | 316229.0 | 19 | 2 | 75.3 | 1136.0 | 1640.0 | --- |
| 11ax40MIMO | 5510 | Type5 | 3 | 3 | 461864.0 | 19 | 1 | 56.4 | 1753.0 | --- | --- |
| 11ax40MIMO | 5510 | Type5 | 3 | 4 | 8677.0 | 19 | 3 | 99.7 | 1196.0 | 1708.0 | 1159.0 |
| 11ax40MIMO | 5510 | Type5 | 3 | 5 | 153995.0 | 19 | 1 | 57.7 | 1013.0 | --- | --- |
| 11ax40MIMO | 5510 | Type5 | 3 | 6 | 299238.0 | 19 | 1 | 59.5 | 1072.0 | --- | --- |
| 11ax40MIMO | 5510 | Type5 | 3 | 7 | 443177.0 | 19 | 2 | 80.0 | 1482.0 | 1369.0 | --- |
| 11ax40MIMO | 5510 | Type5 | 3 | 8 | 587671.0 | 19 | 2 | 82.0 | 1993.0 | 1197.0 | --- |
| 11ax40MIMO | 5510 | Type5 | 3 | 9 | 135674.0 | 19 | 2 | 82.8 | 1883.0 | 1005.0 | --- |
| 11ax40MIMO | 5510 | Type5 | 3 | 10 | 279928.0 | 19 | 3 | 88.0 | 1061.0 | 1928.0 | 1101.0 |
| 11ax40MIMO | 5510 | Type5 | 3 | 11 | 424279.0 | 19 | 3 | 93.2 | 1207.0 | 1907.0 | 1223.0 |
| 11ax40MIMO | 5510 | Type5 | 3 | 12 | 570132.0 | 19 | 2 | 70.4 | 1526.0 | 1360.0 | --- |
| 11ax40MIMO | 5510 | Type5 | 3 | 13 | 117439.0 | 19 | 3 | 95.3 | 1171.0 | 1955.0 | 1775.0 |
| 11ax40MIMO | 5510 | Type5 | 3 | 14 | 262502.0 | 19 | 2 | 81.9 | 1690.0 | 1545.0 | --- |
| 11ax40MIMO | 5510 | Type5 | 3 | 15 | 406573.0 | 19 | 3 | 98.5 | 1975.0 | 1169.0 | 1062.0 |
| 11ax40MIMO | 5510 | Type5 | 3 | 16 | 553328.0 | 19 | 1 | 65.0 | 1767.0 | --- | --- |
| 11ax40MIMO | 5510 | Type5 | 3 | 17 | 99799.0 | 19 | 3 | 85.4 | 1011.0 | 1637.0 | 1425.0 |
| 11ax40MIMO | 5510 | Type5 | 3 | 18 | 244095.0 | 19 | 3 | 91.6 | 1878.0 | 1445.0 | 1325.0 |
| 11ax40MIMO | 5510 | Type5 | 3 | 19 | 390012.0 | 19 | 2 | 67.3 | 1091.0 | 1218.0 | --- |
| 11ax80MIMO | 5530 | Type5 | 3 | 0 | 26541.0 | 19 | 2 | 68.1 | 1339.0 | 1355.0 | --- |
| 11ax80MIMO | 5530 | Type5 | 3 | 1 | 171821.0 | 19 | 1 | 58.7 | 1251.0 | --- | --- |
| 11ax80MIMO | 5530 | Type5 | 3 | 2 | 316229.0 | 19 | 2 | 75.3 | 1136.0 | 1640.0 | --- |
| 11ax80MIMO | 5530 | Type5 | 3 | 3 | 461864.0 | 19 | 1 | 56.4 | 1753.0 | --- | --- |
| 11ax80MIMO | 5530 | Type5 | 3 | 4 | 8677.0 | 19 | 3 | 99.7 | 1196.0 | 1708.0 | 1159.0 |
| 11ax80MIMO | 5530 | Type5 | 3 | 5 | 153995.0 | 19 | 1 | 57.7 | 1013.0 | --- | --- |
| 11ax80MIMO | 5530 | Type5 | 3 | 6 | 299238.0 | 19 | 1 | 59.5 | 1072.0 | --- | --- |
| 11ax80MIMO | 5530 | Type5 | 3 | 7 | 443177.0 | 19 | 2 | 80.0 | 1482.0 | 1369.0 | --- |
| 11ax80MIMO | 5530 | Type5 | 3 | 8 | 587671.0 | 19 | 2 | 82.0 | 1993.0 | 1197.0 | --- |
| 11ax80MIMO | 5530 | Type5 | 3 | 9 | 135674.0 | 19 | 2 | 82.8 | 1883.0 | 1005.0 | --- |
| 11ax80MIMO | 5530 | Type5 | 3 | 10 | 279928.0 | 19 | 3 | 88.0 | 1061.0 | 1928.0 | 1101.0 |
| 11ax80MIMO | 5530 | Type5 | 3 | 11 | 424279.0 | 19 | 3 | 93.2 | 1207.0 | 1907.0 | 1223.0 |
| 11ax80MIMO | 5530 | Type5 | 3 | 12 | 570132.0 | 19 | 2 | 70.4 | 1526.0 | 1360.0 | --- |
| 11ax80MIMO | 5530 | Type5 | 3 | 13 | 117439.0 | 19 | 3 | 95.3 | 1171.0 | 1955.0 | 1775.0 |
| 11ax80MIMO | 5530 | Type5 | 3 | 14 | 262502.0 | 19 | 2 | 81.9 | 1690.0 | 1545.0 | --- |
| 11ax80MIMO | 5530 | Type5 | 3 | 15 | 406573.0 | 19 | 3 | 98.5 | 1975.0 | 1169.0 | 1062.0 |
| 11ax80MIMO | 5530 | Type5 | 3 | 16 | 553328.0 | 19 | 1 | 65.0 | 1767.0 | --- | --- |



Unless otherwise agreed in writing, this document is issued by the Company subject to its General Conditions of Service printed overleaf, available on request or accessible at <http://www.sgs.com/en/Terms-and-Conditions.aspx> and, for electronic format documents, subject to Terms and Conditions for Electronic Documents at <http://www.sgs.com/en/Terms-and-Conditions/Terms-e-Documents.aspx>. Attention is drawn to the limitation of liability, indemnification and jurisdiction issues defined therein. Any holder of this document is advised that information contained hereon reflects the Company's findings at the time of its intervention only and within the limits of Client's instructions, if any. The Company's sole responsibility is to its Client and this document does not exonerate parties to a transaction from exercising all their rights and obligations under the transaction documents. This document cannot be reproduced except in full, without prior written approval of the Company. Any unauthorized alteration, forgery or falsification of the content or appearance of this document is unlawful and offenders may be prosecuted to the fullest extent of the law. Unless otherwise stated the results shown in this test report refer only to the sample(s) tested and such sample(s) are retained for 30 days only.

Attention: To check the authenticity of testing/inspection report & certificate, please contact us at telephone: (86-755) 8307 1443, or email: QN.Doccheck@sgs.com
 South of No. 6 Plant, No. 1, Runsheng Road, Suzhou Industrial Park, Suzhou Area, China (Jiangsu) Pilot Free Trade Zone 215000 t (86-512) 62992980 www.sgsqgroup.com.cn
 中国·苏州·中国（江苏）自由贸易试验区苏州片区苏州工业园区润胜路1号的6号厂房南楼 邮编：215000 t (86-512) 62992980 sgs.china@sgs.com

| | | | | | | | | | | | |
|-------------|------|-------|---|----|----------|----|---|------|--------|--------|--------|
| 11ax80MIMO | 5530 | Type5 | 3 | 17 | 99799.0 | 19 | 3 | 85.4 | 1011.0 | 1637.0 | 1425.0 |
| 11ax80MIMO | 5530 | Type5 | 3 | 18 | 244095.0 | 19 | 3 | 91.6 | 1878.0 | 1445.0 | 1325.0 |
| 11ax80MIMO | 5530 | Type5 | 3 | 19 | 390012.0 | 19 | 2 | 67.3 | 1091.0 | 1218.0 | --- |
| 11ax160MIMO | 5570 | Type5 | 3 | 0 | 26541.0 | 19 | 2 | 68.1 | 1339.0 | 1355.0 | --- |
| 11ax160MIMO | 5570 | Type5 | 3 | 1 | 171821.0 | 19 | 1 | 58.7 | 1251.0 | --- | --- |
| 11ax160MIMO | 5570 | Type5 | 3 | 2 | 316229.0 | 19 | 2 | 75.3 | 1136.0 | 1640.0 | --- |
| 11ax160MIMO | 5570 | Type5 | 3 | 3 | 461864.0 | 19 | 1 | 56.4 | 1753.0 | --- | --- |
| 11ax160MIMO | 5570 | Type5 | 3 | 4 | 8677.0 | 19 | 3 | 99.7 | 1196.0 | 1708.0 | 1159.0 |
| 11ax160MIMO | 5570 | Type5 | 3 | 5 | 153995.0 | 19 | 1 | 57.7 | 1013.0 | --- | --- |
| 11ax160MIMO | 5570 | Type5 | 3 | 6 | 299238.0 | 19 | 1 | 59.5 | 1072.0 | --- | --- |
| 11ax160MIMO | 5570 | Type5 | 3 | 7 | 443177.0 | 19 | 2 | 80.0 | 1482.0 | 1369.0 | --- |
| 11ax160MIMO | 5570 | Type5 | 3 | 8 | 587671.0 | 19 | 2 | 82.0 | 1993.0 | 1197.0 | --- |
| 11ax160MIMO | 5570 | Type5 | 3 | 9 | 135674.0 | 19 | 2 | 82.8 | 1883.0 | 1005.0 | --- |
| 11ax160MIMO | 5570 | Type5 | 3 | 10 | 279928.0 | 19 | 3 | 88.0 | 1061.0 | 1928.0 | 1101.0 |
| 11ax160MIMO | 5570 | Type5 | 3 | 11 | 424279.0 | 19 | 3 | 93.2 | 1207.0 | 1907.0 | 1223.0 |
| 11ax160MIMO | 5570 | Type5 | 3 | 12 | 570132.0 | 19 | 2 | 70.4 | 1526.0 | 1360.0 | --- |
| 11ax160MIMO | 5570 | Type5 | 3 | 13 | 117439.0 | 19 | 3 | 95.3 | 1171.0 | 1955.0 | 1775.0 |
| 11ax160MIMO | 5570 | Type5 | 3 | 14 | 262502.0 | 19 | 2 | 81.9 | 1690.0 | 1545.0 | --- |
| 11ax160MIMO | 5570 | Type5 | 3 | 15 | 406573.0 | 19 | 3 | 98.5 | 1975.0 | 1169.0 | 1062.0 |
| 11ax160MIMO | 5570 | Type5 | 3 | 16 | 553328.0 | 19 | 1 | 65.0 | 1767.0 | --- | --- |
| 11ax160MIMO | 5570 | Type5 | 3 | 17 | 99799.0 | 19 | 3 | 85.4 | 1011.0 | 1637.0 | 1425.0 |
| 11ax160MIMO | 5570 | Type5 | 3 | 18 | 244095.0 | 19 | 3 | 91.6 | 1878.0 | 1445.0 | 1325.0 |
| 11ax160MIMO | 5570 | Type5 | 3 | 19 | 390012.0 | 19 | 2 | 67.3 | 1091.0 | 1218.0 | --- |



Unless otherwise agreed in writing, this document is issued by the Company subject to its General Conditions of Service printed overleaf, available on request or accessible at <http://www.sgs.com/en/Terms-and-Conditions.aspx> and, for electronic format documents, subject to Terms and Conditions for Electronic Documents at <http://www.sgs.com/en/Terms-and-Conditions/Terms-e-Documents.aspx>. Attention is drawn to the limitation of liability, indemnification and jurisdiction issues defined therein. Any holder of this document is advised that information contained hereon reflects the Company's findings at the time of its intervention only and within the limits of Client's instructions, if any. The Company's sole responsibility is to its Client and this document does not exonerate parties to a transaction from exercising all their rights and obligations under the transaction documents. This document cannot be reproduced except in full, without prior written approval of the Company. Any unauthorized alteration, forgery or falsification of the content or appearance of this document is unlawful and offenders may be prosecuted to the fullest extent of the law. Unless otherwise stated the results shown in this test report refer only to the sample(s) tested and such sample(s) are retained for 30 days only.

Attention: To check the authenticity of testing /inspection report & certificate, please contact us at telephone: (86-755) 8307 1443, or email: CN.Doccheck@sgs.com

| @FCC_RLAN_DFS_SPC_Radar_T5_SP2_Tr4@ | | | | | | | | | | | |
|-------------------------------------|---------|------------|----------|----------|-------------------|-------------------|------------------|------------------|-----------|-----------|-----------|
| TestMode | Channel | Radar Type | Trial ID | Burst ID | Burst Offset (μs) | Chirp Width (MHz) | Number Of Pulses | Pulse Width (μs) | PRI1 (μs) | PRI2 (μs) | PRI3 (μs) |
| 11ax20MIMO | 5500 | Type5 | 4 | 0 | 629614.0 | 16 | 2 | 67.9 | 1320.0 | 1133.0 | --- |
| 11ax20MIMO | 5500 | Type5 | 4 | 1 | 96856.0 | 16 | 1 | 62.3 | 1957.0 | --- | --- |
| 11ax20MIMO | 5500 | Type5 | 4 | 2 | 267719.0 | 16 | 1 | 53.3 | 1592.0 | --- | --- |
| 11ax20MIMO | 5500 | Type5 | 4 | 3 | 436784.0 | 16 | 3 | 90.0 | 1900.0 | 1153.0 | 1346.0 |
| 11ax20MIMO | 5500 | Type5 | 4 | 4 | 608289.0 | 16 | 2 | 77.1 | 1166.0 | 1646.0 | --- |
| 11ax20MIMO | 5500 | Type5 | 4 | 5 | 75610.0 | 16 | 3 | 83.9 | 1278.0 | 1232.0 | 1459.0 |
| 11ax20MIMO | 5500 | Type5 | 4 | 6 | 245638.0 | 16 | 3 | 89.1 | 1240.0 | 1384.0 | 1939.0 |
| 11ax20MIMO | 5500 | Type5 | 4 | 7 | 416355.0 | 16 | 2 | 81.8 | 1833.0 | 1676.0 | --- |
| 11ax20MIMO | 5500 | Type5 | 4 | 8 | 588736.0 | 16 | 1 | 50.3 | 1075.0 | --- | --- |
| 11ax20MIMO | 5500 | Type5 | 4 | 9 | 54571.0 | 16 | 3 | 87.1 | 1116.0 | 1996.0 | 1756.0 |
| 11ax20MIMO | 5500 | Type5 | 4 | 10 | 225175.0 | 16 | 2 | 71.3 | 1225.0 | 1815.0 | --- |
| 11ax20MIMO | 5500 | Type5 | 4 | 11 | 394825.0 | 16 | 3 | 97.5 | 1884.0 | 1465.0 | 1132.0 |
| 11ax20MIMO | 5500 | Type5 | 4 | 12 | 565361.0 | 16 | 3 | 90.6 | 1561.0 | 1040.0 | 1354.0 |
| 11ax20MIMO | 5500 | Type5 | 4 | 13 | 33643.0 | 16 | 3 | 86.3 | 1596.0 | 1183.0 | 1792.0 |
| 11ax20MIMO | 5500 | Type5 | 4 | 14 | 203957.0 | 16 | 3 | 97.6 | 1365.0 | 1073.0 | 1361.0 |
| 11ax20MIMO | 5500 | Type5 | 4 | 15 | 373812.0 | 16 | 3 | 84.7 | 1021.0 | 1718.0 | 1854.0 |
| 11ax20MIMO | 5500 | Type5 | 4 | 16 | 544060.0 | 16 | 3 | 99.7 | 1150.0 | 1244.0 | 1988.0 |
| 11ax40MIMO | 5510 | Type5 | 4 | 0 | 629614.0 | 16 | 2 | 67.9 | 1320.0 | 1133.0 | --- |
| 11ax40MIMO | 5510 | Type5 | 4 | 1 | 96856.0 | 16 | 1 | 62.3 | 1957.0 | --- | --- |
| 11ax40MIMO | 5510 | Type5 | 4 | 2 | 267719.0 | 16 | 1 | 53.3 | 1592.0 | --- | --- |
| 11ax40MIMO | 5510 | Type5 | 4 | 3 | 436784.0 | 16 | 3 | 90.0 | 1900.0 | 1153.0 | 1346.0 |
| 11ax40MIMO | 5510 | Type5 | 4 | 4 | 608289.0 | 16 | 2 | 77.1 | 1166.0 | 1646.0 | --- |
| 11ax40MIMO | 5510 | Type5 | 4 | 5 | 75610.0 | 16 | 3 | 83.9 | 1278.0 | 1232.0 | 1459.0 |
| 11ax40MIMO | 5510 | Type5 | 4 | 6 | 245638.0 | 16 | 3 | 89.1 | 1240.0 | 1384.0 | 1939.0 |
| 11ax40MIMO | 5510 | Type5 | 4 | 7 | 416355.0 | 16 | 2 | 81.8 | 1833.0 | 1676.0 | --- |
| 11ax40MIMO | 5510 | Type5 | 4 | 8 | 588736.0 | 16 | 1 | 50.3 | 1075.0 | --- | --- |
| 11ax40MIMO | 5510 | Type5 | 4 | 9 | 54571.0 | 16 | 3 | 87.1 | 1116.0 | 1996.0 | 1756.0 |
| 11ax40MIMO | 5510 | Type5 | 4 | 10 | 225175.0 | 16 | 2 | 71.3 | 1225.0 | 1815.0 | --- |
| 11ax40MIMO | 5510 | Type5 | 4 | 11 | 394825.0 | 16 | 3 | 97.5 | 1884.0 | 1465.0 | 1132.0 |
| 11ax40MIMO | 5510 | Type5 | 4 | 12 | 565361.0 | 16 | 3 | 90.6 | 1561.0 | 1040.0 | 1354.0 |
| 11ax40MIMO | 5510 | Type5 | 4 | 13 | 33643.0 | 16 | 3 | 86.3 | 1596.0 | 1183.0 | 1792.0 |
| 11ax40MIMO | 5510 | Type5 | 4 | 14 | 203957.0 | 16 | 3 | 97.6 | 1365.0 | 1073.0 | 1361.0 |
| 11ax40MIMO | 5510 | Type5 | 4 | 15 | 373812.0 | 16 | 3 | 84.7 | 1021.0 | 1718.0 | 1854.0 |
| 11ax40MIMO | 5510 | Type5 | 4 | 16 | 544060.0 | 16 | 3 | 99.7 | 1150.0 | 1244.0 | 1988.0 |
| 11ax80MIMO | 5530 | Type5 | 4 | 0 | 629614.0 | 16 | 2 | 67.9 | 1320.0 | 1133.0 | --- |
| 11ax80MIMO | 5530 | Type5 | 4 | 1 | 96856.0 | 16 | 1 | 62.3 | 1957.0 | --- | --- |
| 11ax80MIMO | 5530 | Type5 | 4 | 2 | 267719.0 | 16 | 1 | 53.3 | 1592.0 | --- | --- |
| 11ax80MIMO | 5530 | Type5 | 4 | 3 | 436784.0 | 16 | 3 | 90.0 | 1900.0 | 1153.0 | 1346.0 |
| 11ax80MIMO | 5530 | Type5 | 4 | 4 | 608289.0 | 16 | 2 | 77.1 | 1166.0 | 1646.0 | --- |
| 11ax80MIMO | 5530 | Type5 | 4 | 5 | 75610.0 | 16 | 3 | 83.9 | 1278.0 | 1232.0 | 1459.0 |
| 11ax80MIMO | 5530 | Type5 | 4 | 6 | 245638.0 | 16 | 3 | 89.1 | 1240.0 | 1384.0 | 1939.0 |
| 11ax80MIMO | 5530 | Type5 | 4 | 7 | 416355.0 | 16 | 2 | 81.8 | 1833.0 | 1676.0 | --- |
| 11ax80MIMO | 5530 | Type5 | 4 | 8 | 588736.0 | 16 | 1 | 50.3 | 1075.0 | --- | --- |
| 11ax80MIMO | 5530 | Type5 | 4 | 9 | 54571.0 | 16 | 3 | 87.1 | 1116.0 | 1996.0 | 1756.0 |
| 11ax80MIMO | 5530 | Type5 | 4 | 10 | 225175.0 | 16 | 2 | 71.3 | 1225.0 | 1815.0 | --- |
| 11ax80MIMO | 5530 | Type5 | 4 | 11 | 394825.0 | 16 | 3 | 97.5 | 1884.0 | 1465.0 | 1132.0 |
| 11ax80MIMO | 5530 | Type5 | 4 | 12 | 565361.0 | 16 | 3 | 90.6 | 1561.0 | 1040.0 | 1354.0 |
| 11ax80MIMO | 5530 | Type5 | 4 | 13 | 33643.0 | 16 | 3 | 86.3 | 1596.0 | 1183.0 | 1792.0 |
| 11ax80MIMO | 5530 | Type5 | 4 | 14 | 203957.0 | 16 | 3 | 97.6 | 1365.0 | 1073.0 | 1361.0 |
| 11ax80MIMO | 5530 | Type5 | 4 | 15 | 373812.0 | 16 | 3 | 84.7 | 1021.0 | 1718.0 | 1854.0 |
| 11ax80MIMO | 5530 | Type5 | 4 | 16 | 544060.0 | 16 | 3 | 99.7 | 1150.0 | 1244.0 | 1988.0 |
| 11ax160MIMO | 5570 | Type5 | 4 | 0 | 629614.0 | 16 | 2 | 67.9 | 1320.0 | 1133.0 | --- |
| 11ax160MIMO | 5570 | Type5 | 4 | 1 | 96856.0 | 16 | 1 | 62.3 | 1957.0 | --- | --- |
| 11ax160MIMO | 5570 | Type5 | 4 | 2 | 267719.0 | 16 | 1 | 53.3 | 1592.0 | --- | --- |
| 11ax160MIMO | 5570 | Type5 | 4 | 3 | 436784.0 | 16 | 3 | 90.0 | 1900.0 | 1153.0 | 1346.0 |
| 11ax160MIMO | 5570 | Type5 | 4 | 4 | 608289.0 | 16 | 2 | 77.1 | 1166.0 | 1646.0 | --- |
| 11ax160MIMO | 5570 | Type5 | 4 | 5 | 75610.0 | 16 | 3 | 83.9 | 1278.0 | 1232.0 | 1459.0 |



Unless otherwise agreed in writing, this document is issued by the Company subject to its General Conditions of Service printed overleaf, available on request or accessible at <http://www.sgs.com/en/Terms-and-Conditions.aspx> and, for electronic format documents, subject to Terms and Conditions for Electronic Documents at <http://www.sgs.com/en/Terms-and-Conditions/Terms-e-Documents.aspx>. Attention is drawn to the limitation of liability, indemnification and jurisdiction issues defined therein. Any holder of this document is advised that information contained hereon reflects the Company's findings at the time of its intervention only and within the limits of Client's instructions, if any. The Company's sole responsibility is to its Client and this document does not exonerate parties to a transaction from exercising all their rights and obligations under the transaction documents. This document cannot be reproduced except in full, without prior written approval of the Company. Any unauthorized alteration, forgery or falsification of the content or appearance of this document is unlawful and offenders may be prosecuted to the fullest extent of the law. Unless otherwise stated the results shown in this report refer only to the sample(s) tested and such sample(s) are retained for 30 days only.

Attention: To check the authenticity of testing/inspection report & certificate, please contact us at telephone: (86-755) 8307 1443, or email: QN.Doccheck@sgs.com

Report No.: SEWA2303000041RG06

Rev.: 01

Page: 66 of 104

| | | | | | | | | | | | |
|-------------|------|-------|---|----|----------|----|---|------|--------|--------|--------|
| 11ax160MIMO | 5570 | Type5 | 4 | 6 | 245638.0 | 16 | 3 | 89.1 | 1240.0 | 1384.0 | 1939.0 |
| 11ax160MIMO | 5570 | Type5 | 4 | 7 | 416355.0 | 16 | 2 | 81.8 | 1833.0 | 1676.0 | --- |
| 11ax160MIMO | 5570 | Type5 | 4 | 8 | 588736.0 | 16 | 1 | 50.3 | 1075.0 | --- | --- |
| 11ax160MIMO | 5570 | Type5 | 4 | 9 | 54571.0 | 16 | 3 | 87.1 | 1116.0 | 1996.0 | 1756.0 |
| 11ax160MIMO | 5570 | Type5 | 4 | 10 | 225175.0 | 16 | 2 | 71.3 | 1225.0 | 1815.0 | --- |
| 11ax160MIMO | 5570 | Type5 | 4 | 11 | 394825.0 | 16 | 3 | 97.5 | 1884.0 | 1465.0 | 1132.0 |
| 11ax160MIMO | 5570 | Type5 | 4 | 12 | 565361.0 | 16 | 3 | 90.6 | 1561.0 | 1040.0 | 1354.0 |
| 11ax160MIMO | 5570 | Type5 | 4 | 13 | 33643.0 | 16 | 3 | 86.3 | 1596.0 | 1183.0 | 1792.0 |
| 11ax160MIMO | 5570 | Type5 | 4 | 14 | 203957.0 | 16 | 3 | 97.6 | 1365.0 | 1073.0 | 1361.0 |
| 11ax160MIMO | 5570 | Type5 | 4 | 15 | 373812.0 | 16 | 3 | 84.7 | 1021.0 | 1718.0 | 1854.0 |
| 11ax160MIMO | 5570 | Type5 | 4 | 16 | 544060.0 | 16 | 3 | 99.7 | 1150.0 | 1244.0 | 1988.0 |



Unless otherwise agreed in writing, this document is issued by the Company subject to its General Conditions of Service printed overleaf, available on request or accessible at <http://www.sgs.com/en/Terms-and-Conditions.aspx> and, for electronic format documents, subject to Terms and Conditions for Electronic Documents at <http://www.sgs.com/en/Terms-and-Conditions/Terms-e-Documents.aspx>. Attention is drawn to the limitation of liability, indemnification and jurisdiction issues defined therein. Any holder of this document is advised that information contained hereon reflects the Company's findings at the time of its intervention only and within the limits of Client's instructions, if any. The Company's sole responsibility is to its Client and this document does not exonerate parties to a transaction from exercising all their rights and obligations under the transaction documents. This document cannot be reproduced except in full, without prior written approval of the Company. Any unauthorized alteration, forgery or falsification of the content or appearance of this document is unlawful and offenders may be prosecuted to the fullest extent of the law. Unless otherwise stated the results shown in this test report refer only to the sample(s) tested and such sample(s) are retained for 30 days only.

Attention: To check the authenticity of testing /inspection report & certificate, please contact us at telephone: (86-755) 8307 1443, or email: CN.Doccheck@sgs.com

| @FCC_RLAN_DFS_SPC_Radar_T5_SP2_Tr5@ | | | | | | | | | | | |
|-------------------------------------|---------|------------|----------|----------|-------------------|-------------------|------------------|------------------|-----------|-----------|-----------|
| TestMode | Channel | Radar Type | Trial ID | Burst ID | Burst Offset (μs) | Chirp Width (MHz) | Number Of Pulses | Pulse Width (μs) | PRI1 (μs) | PRI2 (μs) | PRI3 (μs) |
| 11ax20MIMO | 5500 | Type5 | 5 | 0 | 15438.0 | 12 | 3 | 92.9 | 1085.0 | 1564.0 | 1407.0 |
| 11ax20MIMO | 5500 | Type5 | 5 | 1 | 222486.0 | 12 | 2 | 67.7 | 1744.0 | 1747.0 | --- |
| 11ax20MIMO | 5500 | Type5 | 5 | 2 | 430731.0 | 12 | 1 | 65.8 | 1092.0 | --- | --- |
| 11ax20MIMO | 5500 | Type5 | 5 | 3 | 637784.0 | 12 | 1 | 56.3 | 1851.0 | --- | --- |
| 11ax20MIMO | 5500 | Type5 | 5 | 4 | 845342.0 | 12 | 1 | 53.7 | 1727.0 | --- | --- |
| 11ax20MIMO | 5500 | Type5 | 5 | 5 | 196720.0 | 12 | 3 | 83.5 | 1679.0 | 1930.0 | 1025.0 |
| 11ax20MIMO | 5500 | Type5 | 5 | 6 | 404955.0 | 12 | 1 | 65.8 | 1519.0 | --- | --- |
| 11ax20MIMO | 5500 | Type5 | 5 | 7 | 610711.0 | 12 | 3 | 85.9 | 1134.0 | 1034.0 | 1808.0 |
| 11ax20MIMO | 5500 | Type5 | 5 | 8 | 818057.0 | 12 | 2 | 76.3 | 1606.0 | 1926.0 | --- |
| 11ax20MIMO | 5500 | Type5 | 5 | 9 | 171459.0 | 12 | 2 | 81.5 | 1891.0 | 1714.0 | --- |
| 11ax20MIMO | 5500 | Type5 | 5 | 10 | 377969.0 | 12 | 3 | 89.4 | 1310.0 | 1594.0 | 1827.0 |
| 11ax20MIMO | 5500 | Type5 | 5 | 11 | 586875.0 | 12 | 1 | 63.4 | 1568.0 | --- | --- |
| 11ax20MIMO | 5500 | Type5 | 5 | 12 | 792834.0 | 12 | 2 | 69.6 | 1307.0 | 1925.0 | --- |
| 11ax20MIMO | 5500 | Type5 | 5 | 13 | 146044.0 | 12 | 2 | 74.5 | 1264.0 | 1846.0 | --- |
| 11ax40MIMO | 5510 | Type5 | 5 | 0 | 15438.0 | 12 | 3 | 92.9 | 1085.0 | 1564.0 | 1407.0 |
| 11ax40MIMO | 5510 | Type5 | 5 | 1 | 222486.0 | 12 | 2 | 67.7 | 1744.0 | 1747.0 | --- |
| 11ax40MIMO | 5510 | Type5 | 5 | 2 | 430731.0 | 12 | 1 | 65.8 | 1092.0 | --- | --- |
| 11ax40MIMO | 5510 | Type5 | 5 | 3 | 637784.0 | 12 | 1 | 56.3 | 1851.0 | --- | --- |
| 11ax40MIMO | 5510 | Type5 | 5 | 4 | 845342.0 | 12 | 1 | 53.7 | 1727.0 | --- | --- |
| 11ax40MIMO | 5510 | Type5 | 5 | 5 | 196720.0 | 12 | 3 | 83.5 | 1679.0 | 1930.0 | 1025.0 |
| 11ax40MIMO | 5510 | Type5 | 5 | 6 | 404955.0 | 12 | 1 | 65.8 | 1519.0 | --- | --- |
| 11ax40MIMO | 5510 | Type5 | 5 | 7 | 610711.0 | 12 | 3 | 85.9 | 1134.0 | 1034.0 | 1808.0 |
| 11ax40MIMO | 5510 | Type5 | 5 | 8 | 818057.0 | 12 | 2 | 76.3 | 1606.0 | 1926.0 | --- |
| 11ax40MIMO | 5510 | Type5 | 5 | 9 | 171459.0 | 12 | 2 | 81.5 | 1891.0 | 1714.0 | --- |
| 11ax40MIMO | 5510 | Type5 | 5 | 10 | 377969.0 | 12 | 3 | 89.4 | 1310.0 | 1594.0 | 1827.0 |
| 11ax40MIMO | 5510 | Type5 | 5 | 11 | 586875.0 | 12 | 1 | 63.4 | 1568.0 | --- | --- |
| 11ax40MIMO | 5510 | Type5 | 5 | 12 | 792834.0 | 12 | 2 | 69.6 | 1307.0 | 1925.0 | --- |
| 11ax40MIMO | 5510 | Type5 | 5 | 13 | 146044.0 | 12 | 2 | 74.5 | 1264.0 | 1846.0 | --- |
| 11ax80MIMO | 5530 | Type5 | 5 | 0 | 15438.0 | 12 | 3 | 92.9 | 1085.0 | 1564.0 | 1407.0 |
| 11ax80MIMO | 5530 | Type5 | 5 | 1 | 222486.0 | 12 | 2 | 67.7 | 1744.0 | 1747.0 | --- |
| 11ax80MIMO | 5530 | Type5 | 5 | 2 | 430731.0 | 12 | 1 | 65.8 | 1092.0 | --- | --- |
| 11ax80MIMO | 5530 | Type5 | 5 | 3 | 637784.0 | 12 | 1 | 56.3 | 1851.0 | --- | --- |
| 11ax80MIMO | 5530 | Type5 | 5 | 4 | 845342.0 | 12 | 1 | 53.7 | 1727.0 | --- | --- |
| 11ax80MIMO | 5530 | Type5 | 5 | 5 | 196720.0 | 12 | 3 | 83.5 | 1679.0 | 1930.0 | 1025.0 |
| 11ax80MIMO | 5530 | Type5 | 5 | 6 | 404955.0 | 12 | 1 | 65.8 | 1519.0 | --- | --- |
| 11ax80MIMO | 5530 | Type5 | 5 | 7 | 610711.0 | 12 | 3 | 85.9 | 1134.0 | 1034.0 | 1808.0 |
| 11ax80MIMO | 5530 | Type5 | 5 | 8 | 818057.0 | 12 | 2 | 76.3 | 1606.0 | 1926.0 | --- |
| 11ax80MIMO | 5530 | Type5 | 5 | 9 | 171459.0 | 12 | 2 | 81.5 | 1891.0 | 1714.0 | --- |
| 11ax80MIMO | 5530 | Type5 | 5 | 10 | 377969.0 | 12 | 3 | 89.4 | 1310.0 | 1594.0 | 1827.0 |
| 11ax80MIMO | 5530 | Type5 | 5 | 11 | 586875.0 | 12 | 1 | 63.4 | 1568.0 | --- | --- |
| 11ax80MIMO | 5530 | Type5 | 5 | 12 | 792834.0 | 12 | 2 | 69.6 | 1307.0 | 1925.0 | --- |
| 11ax80MIMO | 5530 | Type5 | 5 | 13 | 146044.0 | 12 | 2 | 74.5 | 1264.0 | 1846.0 | --- |
| 11ax160MIMO | 5570 | Type5 | 5 | 0 | 15438.0 | 12 | 3 | 92.9 | 1085.0 | 1564.0 | 1407.0 |
| 11ax160MIMO | 5570 | Type5 | 5 | 1 | 222486.0 | 12 | 2 | 67.7 | 1744.0 | 1747.0 | --- |
| 11ax160MIMO | 5570 | Type5 | 5 | 2 | 430731.0 | 12 | 1 | 65.8 | 1092.0 | --- | --- |
| 11ax160MIMO | 5570 | Type5 | 5 | 3 | 637784.0 | 12 | 1 | 56.3 | 1851.0 | --- | --- |
| 11ax160MIMO | 5570 | Type5 | 5 | 4 | 845342.0 | 12 | 1 | 53.7 | 1727.0 | --- | --- |
| 11ax160MIMO | 5570 | Type5 | 5 | 5 | 196720.0 | 12 | 3 | 83.5 | 1679.0 | 1930.0 | 1025.0 |
| 11ax160MIMO | 5570 | Type5 | 5 | 6 | 404955.0 | 12 | 1 | 65.8 | 1519.0 | --- | --- |
| 11ax160MIMO | 5570 | Type5 | 5 | 7 | 610711.0 | 12 | 3 | 85.9 | 1134.0 | 1034.0 | 1808.0 |
| 11ax160MIMO | 5570 | Type5 | 5 | 8 | 818057.0 | 12 | 2 | 76.3 | 1606.0 | 1926.0 | --- |
| 11ax160MIMO | 5570 | Type5 | 5 | 9 | 171459.0 | 12 | 2 | 81.5 | 1891.0 | 1714.0 | --- |
| 11ax160MIMO | 5570 | Type5 | 5 | 10 | 377969.0 | 12 | 3 | 89.4 | 1310.0 | 1594.0 | 1827.0 |
| 11ax160MIMO | 5570 | Type5 | 5 | 11 | 586875.0 | 12 | 1 | 63.4 | 1568.0 | --- | --- |
| 11ax160MIMO | 5570 | Type5 | 5 | 12 | 792834.0 | 12 | 2 | 69.6 | 1307.0 | 1925.0 | --- |
| 11ax160MIMO | 5570 | Type5 | 5 | 13 | 146044.0 | 12 | 2 | 74.5 | 1264.0 | 1846.0 | --- |



Unless otherwise agreed in writing, this document is issued by the Company subject to its General Conditions of Service printed overleaf, available on request or accessible at <http://www.sgs.com/en/Terms-and-Conditions.aspx> and, for electronic format documents, subject to Terms and Conditions for Electronic Documents at <http://www.sgs.com/en/Terms-and-Conditions/Terms-e-Documents.aspx>. Attention is drawn to the limitation of liability, indemnification and jurisdiction issues defined therein. Any holder of this document is advised that information contained hereon reflects the Company's findings at the time of its intervention only and within the limits of Client's instructions, if any. The Company's sole responsibility is to its Client and this document does not exonerate parties to a transaction from exercising all their rights and obligations under the transaction documents. This document cannot be reproduced except in full, without prior written approval of the Company. Any unauthorized alteration, forgery or falsification of the content or appearance of this document is unlawful and offenders may be prosecuted to the fullest extent of the law. Unless otherwise stated the results shown in this test report refer only to the sample(s) tested and such sample(s) are retained for 30 days only.

Attention: To check the authenticity of testing/inspection report & certificate, please contact us at telephone: (86-755) 8307 1443, or email: CN.Doccheck@sgs.com
 South of No. 6 Plant, No. 1, Runsheng Road, Suzhou Industrial Park, Suzhou Area, China (Jiangsu) Pilot Free Trade Zone 215000 t (86-512) 62992980 www.sgs.com.cn
 中国·苏州·中国（江苏）自由贸易试验区苏州片区苏州工业园区润胜路1号的6号厂房南楼 邮编：215000 t (86-512) 62992980 sgs.china@sgs.com

| @FCC_RLAN_DFS_SPC_Radar_T5_SP2_Tr6@ | | | | | | | | | | | |
|-------------------------------------|---------|------------|----------|----------|-------------------|-------------------|------------------|------------------|-----------|-----------|-----------|
| TestMode | Channel | Radar Type | Trial ID | Burst ID | Burst Offset (μs) | Chirp Width (MHz) | Number Of Pulses | Pulse Width (μs) | PRI1 (μs) | PRI2 (μs) | PRI3 (μs) |
| 11ax20MIMO | 5500 | Type5 | 6 | 0 | 329022.0 | 13 | 3 | 96.6 | 1182.0 | 1609.0 | 1581.0 |
| 11ax20MIMO | 5500 | Type5 | 6 | 1 | 521718.0 | 13 | 3 | 96.7 | 1829.0 | 1799.0 | 1154.0 |
| 11ax20MIMO | 5500 | Type5 | 6 | 2 | 714222.0 | 13 | 3 | 86.5 | 1923.0 | 1396.0 | 1865.0 |
| 11ax20MIMO | 5500 | Type5 | 6 | 3 | 112450.0 | 13 | 2 | 73.3 | 1908.0 | 1318.0 | --- |
| 11ax20MIMO | 5500 | Type5 | 6 | 4 | 306283.0 | 13 | 1 | 55.8 | 1688.0 | --- | --- |
| 11ax20MIMO | 5500 | Type5 | 6 | 5 | 500239.0 | 13 | 1 | 55.4 | 1145.0 | --- | --- |
| 11ax20MIMO | 5500 | Type5 | 6 | 6 | 690932.0 | 13 | 3 | 85.3 | 1336.0 | 1504.0 | 1820.0 |
| 11ax20MIMO | 5500 | Type5 | 6 | 7 | 88645.0 | 13 | 2 | 79.4 | 1344.0 | 1893.0 | --- |
| 11ax20MIMO | 5500 | Type5 | 6 | 8 | 282508.0 | 13 | 1 | 65.7 | 1476.0 | --- | --- |
| 11ax20MIMO | 5500 | Type5 | 6 | 9 | 475842.0 | 13 | 2 | 68.6 | 1008.0 | 1028.0 | --- |
| 11ax20MIMO | 5500 | Type5 | 6 | 10 | 667887.0 | 13 | 2 | 77.7 | 1972.0 | 1835.0 | --- |
| 11ax20MIMO | 5500 | Type5 | 6 | 11 | 64845.0 | 13 | 2 | 79.6 | 1882.0 | 1331.0 | --- |
| 11ax20MIMO | 5500 | Type5 | 6 | 12 | 257755.0 | 13 | 3 | 94.9 | 1830.0 | 1070.0 | 1349.0 |
| 11ax20MIMO | 5500 | Type5 | 6 | 13 | 452335.0 | 13 | 1 | 61.4 | 1451.0 | --- | --- |
| 11ax20MIMO | 5500 | Type5 | 6 | 14 | 643395.0 | 13 | 3 | 90.6 | 1233.0 | 1562.0 | 1887.0 |
| 11ax40MIMO | 5510 | Type5 | 6 | 0 | 329022.0 | 13 | 3 | 96.6 | 1182.0 | 1609.0 | 1581.0 |
| 11ax40MIMO | 5510 | Type5 | 6 | 1 | 521718.0 | 13 | 3 | 96.7 | 1829.0 | 1799.0 | 1154.0 |
| 11ax40MIMO | 5510 | Type5 | 6 | 2 | 714222.0 | 13 | 3 | 86.5 | 1923.0 | 1396.0 | 1865.0 |
| 11ax40MIMO | 5510 | Type5 | 6 | 3 | 112450.0 | 13 | 2 | 73.3 | 1908.0 | 1318.0 | --- |
| 11ax40MIMO | 5510 | Type5 | 6 | 4 | 306283.0 | 13 | 1 | 55.8 | 1688.0 | --- | --- |
| 11ax40MIMO | 5510 | Type5 | 6 | 5 | 500239.0 | 13 | 1 | 55.4 | 1145.0 | --- | --- |
| 11ax40MIMO | 5510 | Type5 | 6 | 6 | 690932.0 | 13 | 3 | 85.3 | 1336.0 | 1504.0 | 1820.0 |
| 11ax40MIMO | 5510 | Type5 | 6 | 7 | 88645.0 | 13 | 2 | 79.4 | 1344.0 | 1893.0 | --- |
| 11ax40MIMO | 5510 | Type5 | 6 | 8 | 282508.0 | 13 | 1 | 65.7 | 1476.0 | --- | --- |
| 11ax40MIMO | 5510 | Type5 | 6 | 9 | 475842.0 | 13 | 2 | 68.6 | 1008.0 | 1028.0 | --- |
| 11ax40MIMO | 5510 | Type5 | 6 | 10 | 667887.0 | 13 | 2 | 77.7 | 1972.0 | 1835.0 | --- |
| 11ax40MIMO | 5510 | Type5 | 6 | 11 | 64845.0 | 13 | 2 | 79.6 | 1882.0 | 1331.0 | --- |
| 11ax40MIMO | 5510 | Type5 | 6 | 12 | 257755.0 | 13 | 3 | 94.9 | 1830.0 | 1070.0 | 1349.0 |
| 11ax40MIMO | 5510 | Type5 | 6 | 13 | 452335.0 | 13 | 1 | 61.4 | 1451.0 | --- | --- |
| 11ax40MIMO | 5510 | Type5 | 6 | 14 | 643395.0 | 13 | 3 | 90.6 | 1233.0 | 1562.0 | 1887.0 |
| 11ax80MIMO | 5530 | Type5 | 6 | 0 | 329022.0 | 13 | 3 | 96.6 | 1182.0 | 1609.0 | 1581.0 |
| 11ax80MIMO | 5530 | Type5 | 6 | 1 | 521718.0 | 13 | 3 | 96.7 | 1829.0 | 1799.0 | 1154.0 |
| 11ax80MIMO | 5530 | Type5 | 6 | 2 | 714222.0 | 13 | 3 | 86.5 | 1923.0 | 1396.0 | 1865.0 |
| 11ax80MIMO | 5530 | Type5 | 6 | 3 | 112450.0 | 13 | 2 | 73.3 | 1908.0 | 1318.0 | --- |
| 11ax80MIMO | 5530 | Type5 | 6 | 4 | 306283.0 | 13 | 1 | 55.8 | 1688.0 | --- | --- |
| 11ax80MIMO | 5530 | Type5 | 6 | 5 | 500239.0 | 13 | 1 | 55.4 | 1145.0 | --- | --- |
| 11ax80MIMO | 5530 | Type5 | 6 | 6 | 690932.0 | 13 | 3 | 85.3 | 1336.0 | 1504.0 | 1820.0 |
| 11ax80MIMO | 5530 | Type5 | 6 | 7 | 88645.0 | 13 | 2 | 79.4 | 1344.0 | 1893.0 | --- |
| 11ax80MIMO | 5530 | Type5 | 6 | 8 | 282508.0 | 13 | 1 | 65.7 | 1476.0 | --- | --- |
| 11ax80MIMO | 5530 | Type5 | 6 | 9 | 475842.0 | 13 | 2 | 68.6 | 1008.0 | 1028.0 | --- |
| 11ax80MIMO | 5530 | Type5 | 6 | 10 | 667887.0 | 13 | 2 | 77.7 | 1972.0 | 1835.0 | --- |
| 11ax80MIMO | 5530 | Type5 | 6 | 11 | 64845.0 | 13 | 2 | 79.6 | 1882.0 | 1331.0 | --- |
| 11ax80MIMO | 5530 | Type5 | 6 | 12 | 257755.0 | 13 | 3 | 94.9 | 1830.0 | 1070.0 | 1349.0 |
| 11ax80MIMO | 5530 | Type5 | 6 | 13 | 452335.0 | 13 | 1 | 61.4 | 1451.0 | --- | --- |
| 11ax80MIMO | 5530 | Type5 | 6 | 14 | 643395.0 | 13 | 3 | 90.6 | 1233.0 | 1562.0 | 1887.0 |
| 11ax160MIMO | 5570 | Type5 | 6 | 0 | 329022.0 | 13 | 3 | 96.6 | 1182.0 | 1609.0 | 1581.0 |
| 11ax160MIMO | 5570 | Type5 | 6 | 1 | 521718.0 | 13 | 3 | 96.7 | 1829.0 | 1799.0 | 1154.0 |
| 11ax160MIMO | 5570 | Type5 | 6 | 2 | 714222.0 | 13 | 3 | 86.5 | 1923.0 | 1396.0 | 1865.0 |
| 11ax160MIMO | 5570 | Type5 | 6 | 3 | 112450.0 | 13 | 2 | 73.3 | 1908.0 | 1318.0 | --- |
| 11ax160MIMO | 5570 | Type5 | 6 | 4 | 306283.0 | 13 | 1 | 55.8 | 1688.0 | --- | --- |
| 11ax160MIMO | 5570 | Type5 | 6 | 5 | 500239.0 | 13 | 1 | 55.4 | 1145.0 | --- | --- |
| 11ax160MIMO | 5570 | Type5 | 6 | 6 | 690932.0 | 13 | 3 | 85.3 | 1336.0 | 1504.0 | 1820.0 |
| 11ax160MIMO | 5570 | Type5 | 6 | 7 | 88645.0 | 13 | 2 | 79.4 | 1344.0 | 1893.0 | --- |
| 11ax160MIMO | 5570 | Type5 | 6 | 8 | 282508.0 | 13 | 1 | 65.7 | 1476.0 | --- | --- |
| 11ax160MIMO | 5570 | Type5 | 6 | 9 | 475842.0 | 13 | 2 | 68.6 | 1008.0 | 1028.0 | --- |
| 11ax160MIMO | 5570 | Type5 | 6 | 10 | 667887.0 | 13 | 2 | 77.7 | 1972.0 | 1835.0 | --- |
| 11ax160MIMO | 5570 | Type5 | 6 | 11 | 64845.0 | 13 | 2 | 79.6 | 1882.0 | 1331.0 | --- |
| 11ax160MIMO | 5570 | Type5 | 6 | 12 | 257755.0 | 13 | 3 | 94.9 | 1830.0 | 1070.0 | 1349.0 |



Unless otherwise agreed in writing, this document is issued by the Company subject to its General Conditions of Service printed overleaf, available on request or accessible at <http://www.sgs.com/en/Terms-and-Conditions.aspx> and, for electronic format documents, subject to Terms and Conditions for Electronic Documents at <http://www.sgs.com/en/Terms-and-Conditions/Terms-e-Documents.aspx>. Attention is drawn to the limitation of liability, indemnification and jurisdiction issues defined therein. Any holder of this document is advised that information contained hereon reflects the Company's findings only and within the limits of Client's instructions, if any. The Company's sole responsibility is to its Client and this document does not exonerate parties to a transaction from exercising all their rights and obligations under the transaction documents. This document cannot be reproduced except in full, without prior written approval of the Company. Any unauthorized alteration, forgery or falsification of the content or appearance of this document is unlawful and offenders may be prosecuted to the fullest extent of the law. Unless otherwise stated the results shown in this test report refer only to the sample(s) tested and such sample(s) are retained for 30 days only.

Attention: To check the authenticity of testing/inspection report & certificate, please contact us at telephone: (86-755) 8307 1443, or email: QN.Doccheck@sgs.com
 South of No. 6 Plant, No. 1, Runsheng Road, Suzhou Industrial Park, Suzhou Area, China (Jiangsu) Pilot Free Trade Zone 215000 t (86-512) 62992980 www.sgsgroup.com.cn
 中国·苏州·中国（江苏）自由贸易试验区苏州片区苏州工业园区润胜路1号的6号厂房南楼 邮编：215000 t (86-512) 62992980 sgs.china@sgs.com



Report No.: SEWA2303000041RG06

Rev.: 01

Page: 69 of 104

| | | | | | | | | | | | |
|-------------|------|-------|---|----|----------|----|---|------|--------|--------|--------|
| 11ax160MIMO | 5570 | Type5 | 6 | 13 | 452335.0 | 13 | 1 | 61.4 | 1451.0 | --- | --- |
| 11ax160MIMO | 5570 | Type5 | 6 | 14 | 643395.0 | 13 | 3 | 90.6 | 1233.0 | 1562.0 | 1887.0 |



Unless otherwise agreed in writing, this document is issued by the Company subject to its General Conditions of Service printed overleaf, available on request or accessible at <http://www.sgs.com/en/Terms-and-Conditions.aspx> and, for electronic format documents, subject to Terms and Conditions for Electronic Documents at <http://www.sgs.com/en/Terms-and-Conditions/Terms-e-Documents.aspx>. Attention is drawn to the limitation of liability, indemnification and jurisdiction issues defined therein. Any holder of this document is advised that information contained hereon reflects the Company's findings at the time of its intervention only and within the limits of Client's instructions, if any. The Company's sole responsibility is to its Client and this document does not exonerate parties to a transaction from exercising all their rights and obligations under the transaction documents. This document cannot be reproduced except in full, without prior written approval of the Company. Any unauthorized alteration, forgery or falsification of the content or appearance of this document is unlawful and offenders may be prosecuted to the fullest extent of the law. Unless otherwise stated the results shown in this test report refer only to the sample(s) tested and such sample(s) are retained for 30 days only.

Attention: To check the authenticity of testing /inspection report & certificate, please contact us at telephone: (86-755) 8307 1443, or email: CN.Doccheck@sgs.com

| @FCC_RLAN_DFS_SPC_Radar_T5_SP2_Tr7@ | | | | | | | | | | | |
|-------------------------------------|---------|------------|----------|----------|-------------------|-------------------|------------------|------------------|-----------|-----------|-----------|
| TestMode | Channel | Radar Type | Trial ID | Burst ID | Burst Offset (μs) | Chirp Width (MHz) | Number Of Pulses | Pulse Width (μs) | PRI1 (μs) | PRI2 (μs) | PRI3 (μs) |
| 11ax20MIMO | 5500 | Type5 | 7 | 0 | 51446.0 | 10 | 1 | 52.6 | 1210.0 | --- | --- |
| 11ax20MIMO | 5500 | Type5 | 7 | 1 | 292696.0 | 10 | 3 | 84.1 | 1314.0 | 1725.0 | 1529.0 |
| 11ax20MIMO | 5500 | Type5 | 7 | 2 | 533989.0 | 10 | 3 | 97.7 | 1139.0 | 1868.0 | 1805.0 |
| 11ax20MIMO | 5500 | Type5 | 7 | 3 | 775564.0 | 10 | 3 | 97.3 | 1341.0 | 1446.0 | 1755.0 |
| 11ax20MIMO | 5500 | Type5 | 7 | 4 | 21542.0 | 10 | 3 | 98.8 | 1544.0 | 1386.0 | 1302.0 |
| 11ax20MIMO | 5500 | Type5 | 7 | 5 | 263385.0 | 10 | 2 | 72.2 | 1771.0 | 1184.0 | --- |
| 11ax20MIMO | 5500 | Type5 | 7 | 6 | 505581.0 | 10 | 2 | 67.6 | 1175.0 | 1027.0 | --- |
| 11ax20MIMO | 5500 | Type5 | 7 | 7 | 747058.0 | 10 | 2 | 75.7 | 1026.0 | 1871.0 | --- |
| 11ax20MIMO | 5500 | Type5 | 7 | 8 | 989976.0 | 10 | 1 | 60.9 | 1798.0 | --- | --- |
| 11ax20MIMO | 5500 | Type5 | 7 | 9 | 234024.0 | 10 | 1 | 64.2 | 1138.0 | --- | --- |
| 11ax20MIMO | 5500 | Type5 | 7 | 10 | 475207.0 | 10 | 2 | 78.8 | 1784.0 | 1604.0 | --- |
| 11ax20MIMO | 5500 | Type5 | 7 | 11 | 715825.0 | 10 | 3 | 87.5 | 1511.0 | 1712.0 | 1683.0 |
| 11ax40MIMO | 5510 | Type5 | 7 | 0 | 51446.0 | 10 | 1 | 52.6 | 1210.0 | --- | --- |
| 11ax40MIMO | 5510 | Type5 | 7 | 1 | 292696.0 | 10 | 3 | 84.1 | 1314.0 | 1725.0 | 1529.0 |
| 11ax40MIMO | 5510 | Type5 | 7 | 2 | 533989.0 | 10 | 3 | 97.7 | 1139.0 | 1868.0 | 1805.0 |
| 11ax40MIMO | 5510 | Type5 | 7 | 3 | 775564.0 | 10 | 3 | 97.3 | 1341.0 | 1446.0 | 1755.0 |
| 11ax40MIMO | 5510 | Type5 | 7 | 4 | 21542.0 | 10 | 3 | 98.8 | 1544.0 | 1386.0 | 1302.0 |
| 11ax40MIMO | 5510 | Type5 | 7 | 5 | 263385.0 | 10 | 2 | 72.2 | 1771.0 | 1184.0 | --- |
| 11ax40MIMO | 5510 | Type5 | 7 | 6 | 505581.0 | 10 | 2 | 67.6 | 1175.0 | 1027.0 | --- |
| 11ax40MIMO | 5510 | Type5 | 7 | 7 | 747058.0 | 10 | 2 | 75.7 | 1026.0 | 1871.0 | --- |
| 11ax40MIMO | 5510 | Type5 | 7 | 8 | 989976.0 | 10 | 1 | 60.9 | 1798.0 | --- | --- |
| 11ax40MIMO | 5510 | Type5 | 7 | 9 | 234024.0 | 10 | 1 | 64.2 | 1138.0 | --- | --- |
| 11ax40MIMO | 5510 | Type5 | 7 | 10 | 475207.0 | 10 | 2 | 78.8 | 1784.0 | 1604.0 | --- |
| 11ax40MIMO | 5510 | Type5 | 7 | 11 | 715825.0 | 10 | 3 | 87.5 | 1511.0 | 1712.0 | 1683.0 |
| 11ax80MIMO | 5530 | Type5 | 7 | 0 | 51446.0 | 10 | 1 | 52.6 | 1210.0 | --- | --- |
| 11ax80MIMO | 5530 | Type5 | 7 | 1 | 292696.0 | 10 | 3 | 84.1 | 1314.0 | 1725.0 | 1529.0 |
| 11ax80MIMO | 5530 | Type5 | 7 | 2 | 533989.0 | 10 | 3 | 97.7 | 1139.0 | 1868.0 | 1805.0 |
| 11ax80MIMO | 5530 | Type5 | 7 | 3 | 775564.0 | 10 | 3 | 97.3 | 1341.0 | 1446.0 | 1755.0 |
| 11ax80MIMO | 5530 | Type5 | 7 | 4 | 21542.0 | 10 | 3 | 98.8 | 1544.0 | 1386.0 | 1302.0 |
| 11ax80MIMO | 5530 | Type5 | 7 | 5 | 263385.0 | 10 | 2 | 72.2 | 1771.0 | 1184.0 | --- |
| 11ax80MIMO | 5530 | Type5 | 7 | 6 | 505581.0 | 10 | 2 | 67.6 | 1175.0 | 1027.0 | --- |
| 11ax80MIMO | 5530 | Type5 | 7 | 7 | 747058.0 | 10 | 2 | 75.7 | 1026.0 | 1871.0 | --- |
| 11ax80MIMO | 5530 | Type5 | 7 | 8 | 989976.0 | 10 | 1 | 60.9 | 1798.0 | --- | --- |
| 11ax80MIMO | 5530 | Type5 | 7 | 9 | 234024.0 | 10 | 1 | 64.2 | 1138.0 | --- | --- |
| 11ax80MIMO | 5530 | Type5 | 7 | 10 | 475207.0 | 10 | 2 | 78.8 | 1784.0 | 1604.0 | --- |
| 11ax80MIMO | 5530 | Type5 | 7 | 11 | 715825.0 | 10 | 3 | 87.5 | 1511.0 | 1712.0 | 1683.0 |
| 11ax160MIMO | 5570 | Type5 | 7 | 0 | 51446.0 | 10 | 1 | 52.6 | 1210.0 | --- | --- |
| 11ax160MIMO | 5570 | Type5 | 7 | 1 | 292696.0 | 10 | 3 | 84.1 | 1314.0 | 1725.0 | 1529.0 |
| 11ax160MIMO | 5570 | Type5 | 7 | 2 | 533989.0 | 10 | 3 | 97.7 | 1139.0 | 1868.0 | 1805.0 |
| 11ax160MIMO | 5570 | Type5 | 7 | 3 | 775564.0 | 10 | 3 | 97.3 | 1341.0 | 1446.0 | 1755.0 |
| 11ax160MIMO | 5570 | Type5 | 7 | 4 | 21542.0 | 10 | 3 | 98.8 | 1544.0 | 1386.0 | 1302.0 |
| 11ax160MIMO | 5570 | Type5 | 7 | 5 | 263385.0 | 10 | 2 | 72.2 | 1771.0 | 1184.0 | --- |
| 11ax160MIMO | 5570 | Type5 | 7 | 6 | 505581.0 | 10 | 2 | 67.6 | 1175.0 | 1027.0 | --- |
| 11ax160MIMO | 5570 | Type5 | 7 | 7 | 747058.0 | 10 | 2 | 75.7 | 1026.0 | 1871.0 | --- |
| 11ax160MIMO | 5570 | Type5 | 7 | 8 | 989976.0 | 10 | 1 | 60.9 | 1798.0 | --- | --- |
| 11ax160MIMO | 5570 | Type5 | 7 | 9 | 234024.0 | 10 | 1 | 64.2 | 1138.0 | --- | --- |
| 11ax160MIMO | 5570 | Type5 | 7 | 10 | 475207.0 | 10 | 2 | 78.8 | 1784.0 | 1604.0 | --- |
| 11ax160MIMO | 5570 | Type5 | 7 | 11 | 715825.0 | 10 | 3 | 87.5 | 1511.0 | 1712.0 | 1683.0 |



Unless otherwise agreed in writing, this document is issued by the Company subject to its General Conditions of Service printed overleaf, available on request or accessible at <http://www.sgs.com/en/Terms-and-Conditions.aspx> and, for electronic format documents, subject to Terms and Conditions for Electronic Documents at <http://www.sgs.com/en/Terms-and-Conditions/Terms-e-Documents.aspx>. Attention is drawn to the limitation of liability, indemnification and jurisdiction issues defined therein. Any holder of this document is advised that information contained hereon reflects the Company's findings only and within the limits of Client's instructions, if any. The Company's sole responsibility is to its Client and this document does not exonerate parties to a transaction from exercising all their rights and obligations under the transaction documents. This document cannot be reproduced except in full, without prior written approval of the Company. Any unauthorized alteration, forgery or falsification of the content or appearance of this document is unlawful and offenders may be prosecuted to the fullest extent of the law. Unless otherwise stated the results shown in this test report refer only to the sample(s) tested and such sample(s) are retained for 30 days only.

Attention: To check the authenticity of testing /inspection report & certificate, please contact us at telephone: (86-755) 8307 1443, or email: QN.Doccheck@sgs.com

SGS-CSTC Standards Technical Services (Suzhou) Co., Ltd.
Wireless Laboratory

South of No. 6 Plant, No. 1, Runsheng Road, Suzhou Industrial Park, Suzhou Area, China (Jiangsu) Pilot Free Trade Zone 215000 t (86-512) 62992980 www.sgsgroup.com.cn
中国·苏州·中国(江苏)自由贸易试验区苏州片区苏州工业园区润胜路1号的6号厂房南楼 邮编: 215000 t (86-512) 62992980 sgs.china@sgs.com

| @FCC_RLAN_DFS_SPC_Radar_T5_SP2_Tr8@ | | | | | | | | | | | |
|-------------------------------------|---------|------------|----------|----------|-------------------|-------------------|------------------|------------------|-----------|-----------|-----------|
| TestMode | Channel | Radar Type | Trial ID | Burst ID | Burst Offset (μs) | Chirp Width (MHz) | Number Of Pulses | Pulse Width (μs) | PRI1 (μs) | PRI2 (μs) | PRI3 (μs) |
| 11ax20MIMO | 5500 | Type5 | 8 | 0 | 823112.0 | 13 | 1 | 54.1 | 1415.0 | --- | --- |
| 11ax20MIMO | 5500 | Type5 | 8 | 1 | 174965.0 | 13 | 1 | 50.7 | 1221.0 | --- | --- |
| 11ax20MIMO | 5500 | Type5 | 8 | 2 | 382216.0 | 13 | 1 | 52.3 | 1974.0 | --- | --- |
| 11ax20MIMO | 5500 | Type5 | 8 | 3 | 587395.0 | 13 | 3 | 99.8 | 1558.0 | 1696.0 | 1949.0 |
| 11ax20MIMO | 5500 | Type5 | 8 | 4 | 796897.0 | 13 | 2 | 68.4 | 1014.0 | 1099.0 | --- |
| 11ax20MIMO | 5500 | Type5 | 8 | 5 | 149042.0 | 13 | 2 | 80.8 | 1736.0 | 1505.0 | --- |
| 11ax20MIMO | 5500 | Type5 | 8 | 6 | 356750.0 | 13 | 1 | 62.5 | 1778.0 | --- | --- |
| 11ax20MIMO | 5500 | Type5 | 8 | 7 | 563824.0 | 13 | 2 | 74.8 | 1149.0 | 1204.0 | --- |
| 11ax20MIMO | 5500 | Type5 | 8 | 8 | 772314.0 | 13 | 1 | 50.8 | 1049.0 | --- | --- |
| 11ax20MIMO | 5500 | Type5 | 8 | 9 | 123796.0 | 13 | 1 | 54.0 | 1417.0 | --- | --- |
| 11ax20MIMO | 5500 | Type5 | 8 | 10 | 331215.0 | 13 | 1 | 63.0 | 1730.0 | --- | --- |
| 11ax20MIMO | 5500 | Type5 | 8 | 11 | 537402.0 | 13 | 3 | 91.8 | 1143.0 | 1270.0 | 1347.0 |
| 11ax20MIMO | 5500 | Type5 | 8 | 12 | 744805.0 | 13 | 2 | 79.3 | 1274.0 | 1992.0 | --- |
| 11ax20MIMO | 5500 | Type5 | 8 | 13 | 98172.0 | 13 | 1 | 64.3 | 1937.0 | --- | --- |
| 11ax40MIMO | 5510 | Type5 | 8 | 0 | 823112.0 | 13 | 1 | 54.1 | 1415.0 | --- | --- |
| 11ax40MIMO | 5510 | Type5 | 8 | 1 | 174965.0 | 13 | 1 | 50.7 | 1221.0 | --- | --- |
| 11ax40MIMO | 5510 | Type5 | 8 | 2 | 382216.0 | 13 | 1 | 52.3 | 1974.0 | --- | --- |
| 11ax40MIMO | 5510 | Type5 | 8 | 3 | 587395.0 | 13 | 3 | 99.8 | 1558.0 | 1696.0 | 1949.0 |
| 11ax40MIMO | 5510 | Type5 | 8 | 4 | 796897.0 | 13 | 2 | 68.4 | 1014.0 | 1099.0 | --- |
| 11ax40MIMO | 5510 | Type5 | 8 | 5 | 149042.0 | 13 | 2 | 80.8 | 1736.0 | 1505.0 | --- |
| 11ax40MIMO | 5510 | Type5 | 8 | 6 | 356750.0 | 13 | 1 | 62.5 | 1778.0 | --- | --- |
| 11ax40MIMO | 5510 | Type5 | 8 | 7 | 563824.0 | 13 | 2 | 74.8 | 1149.0 | 1204.0 | --- |
| 11ax40MIMO | 5510 | Type5 | 8 | 8 | 772314.0 | 13 | 1 | 50.8 | 1049.0 | --- | --- |
| 11ax40MIMO | 5510 | Type5 | 8 | 9 | 123796.0 | 13 | 1 | 54.0 | 1417.0 | --- | --- |
| 11ax40MIMO | 5510 | Type5 | 8 | 10 | 331215.0 | 13 | 1 | 63.0 | 1730.0 | --- | --- |
| 11ax40MIMO | 5510 | Type5 | 8 | 11 | 537402.0 | 13 | 3 | 91.8 | 1143.0 | 1270.0 | 1347.0 |
| 11ax40MIMO | 5510 | Type5 | 8 | 12 | 744805.0 | 13 | 2 | 79.3 | 1274.0 | 1992.0 | --- |
| 11ax40MIMO | 5510 | Type5 | 8 | 13 | 98172.0 | 13 | 1 | 64.3 | 1937.0 | --- | --- |
| 11ax80MIMO | 5530 | Type5 | 8 | 0 | 823112.0 | 13 | 1 | 54.1 | 1415.0 | --- | --- |
| 11ax80MIMO | 5530 | Type5 | 8 | 1 | 174965.0 | 13 | 1 | 50.7 | 1221.0 | --- | --- |
| 11ax80MIMO | 5530 | Type5 | 8 | 2 | 382216.0 | 13 | 1 | 52.3 | 1974.0 | --- | --- |
| 11ax80MIMO | 5530 | Type5 | 8 | 3 | 587395.0 | 13 | 3 | 99.8 | 1558.0 | 1696.0 | 1949.0 |
| 11ax80MIMO | 5530 | Type5 | 8 | 4 | 796897.0 | 13 | 2 | 68.4 | 1014.0 | 1099.0 | --- |
| 11ax80MIMO | 5530 | Type5 | 8 | 5 | 149042.0 | 13 | 2 | 80.8 | 1736.0 | 1505.0 | --- |
| 11ax80MIMO | 5530 | Type5 | 8 | 6 | 356750.0 | 13 | 1 | 62.5 | 1778.0 | --- | --- |
| 11ax80MIMO | 5530 | Type5 | 8 | 7 | 563824.0 | 13 | 2 | 74.8 | 1149.0 | 1204.0 | --- |
| 11ax80MIMO | 5530 | Type5 | 8 | 8 | 772314.0 | 13 | 1 | 50.8 | 1049.0 | --- | --- |
| 11ax80MIMO | 5530 | Type5 | 8 | 9 | 123796.0 | 13 | 1 | 54.0 | 1417.0 | --- | --- |
| 11ax80MIMO | 5530 | Type5 | 8 | 10 | 331215.0 | 13 | 1 | 63.0 | 1730.0 | --- | --- |
| 11ax80MIMO | 5530 | Type5 | 8 | 11 | 537402.0 | 13 | 3 | 91.8 | 1143.0 | 1270.0 | 1347.0 |
| 11ax80MIMO | 5530 | Type5 | 8 | 12 | 744805.0 | 13 | 2 | 79.3 | 1274.0 | 1992.0 | --- |
| 11ax80MIMO | 5530 | Type5 | 8 | 13 | 98172.0 | 13 | 1 | 64.3 | 1937.0 | --- | --- |
| 11ax160MIMO | 5570 | Type5 | 8 | 0 | 823112.0 | 13 | 1 | 54.1 | 1415.0 | --- | --- |
| 11ax160MIMO | 5570 | Type5 | 8 | 1 | 174965.0 | 13 | 1 | 50.7 | 1221.0 | --- | --- |
| 11ax160MIMO | 5570 | Type5 | 8 | 2 | 382216.0 | 13 | 1 | 52.3 | 1974.0 | --- | --- |
| 11ax160MIMO | 5570 | Type5 | 8 | 3 | 587395.0 | 13 | 3 | 99.8 | 1558.0 | 1696.0 | 1949.0 |
| 11ax160MIMO | 5570 | Type5 | 8 | 4 | 796897.0 | 13 | 2 | 68.4 | 1014.0 | 1099.0 | --- |
| 11ax160MIMO | 5570 | Type5 | 8 | 5 | 149042.0 | 13 | 2 | 80.8 | 1736.0 | 1505.0 | --- |
| 11ax160MIMO | 5570 | Type5 | 8 | 6 | 356750.0 | 13 | 1 | 62.5 | 1778.0 | --- | --- |
| 11ax160MIMO | 5570 | Type5 | 8 | 7 | 563824.0 | 13 | 2 | 74.8 | 1149.0 | 1204.0 | --- |
| 11ax160MIMO | 5570 | Type5 | 8 | 8 | 772314.0 | 13 | 1 | 50.8 | 1049.0 | --- | --- |
| 11ax160MIMO | 5570 | Type5 | 8 | 9 | 123796.0 | 13 | 1 | 54.0 | 1417.0 | --- | --- |
| 11ax160MIMO | 5570 | Type5 | 8 | 10 | 331215.0 | 13 | 1 | 63.0 | 1730.0 | --- | --- |
| 11ax160MIMO | 5570 | Type5 | 8 | 11 | 537402.0 | 13 | 3 | 91.8 | 1143.0 | 1270.0 | 1347.0 |
| 11ax160MIMO | 5570 | Type5 | 8 | 12 | 744805.0 | 13 | 2 | 79.3 | 1274.0 | 1992.0 | --- |
| 11ax160MIMO | 5570 | Type5 | 8 | 13 | 98172.0 | 13 | 1 | 64.3 | 1937.0 | --- | --- |



Unless otherwise agreed in writing, this document is issued by the Company subject to its General Conditions of Service printed overleaf, available on request or accessible at <http://www.sgs.com/en/Terms-and-Conditions.aspx> and, for electronic format documents, subject to Terms and Conditions for Electronic Documents at <http://www.sgs.com/en/Terms-and-Conditions/Terms-e-Documents.aspx>. Attention is drawn to the limitation of liability, indemnification and jurisdiction issues defined therein. Any holder of this document is advised that information contained hereon reflects the Company's findings at the time of its intervention only and within the limits of Client's instructions, if any. The Company's sole responsibility is to its Client and this document does not exonerate parties to a transaction from exercising all their rights and obligations under the transaction documents. This document cannot be reproduced except in full, without prior written approval of the Company. Any unauthorized alteration, forgery or falsification of the content or appearance of this document is unlawful and offenders may be prosecuted to the fullest extent of the law. Unless otherwise stated the results shown in this test report refer only to the sample(s) tested and such sample(s) are retained for 30 days only.

Attention: To check the authenticity of testing/inspection report & certificate, please contact us at telephone: (86-755) 8307 1443, or email: QN.Doccheck@sgs.com
 South of No. 6 Plant, No. 1, Runsheng Road, Suzhou Industrial Park, Suzhou Area, China (Jiangsu) Pilot Free Trade Zone 215000 t (86-512) 62992980 www.sgsgroup.com.cn
 中国·苏州·中国（江苏）自由贸易试验区苏州片区苏州工业园区润胜路1号的6号厂房南楼 邮编：215000 t (86-512) 62992980 sgs.china@sgs.com

| @FCC_RLAN_DFS_SPC_Radar_T5_SP2_Tr9@ | | | | | | | | | | | |
|-------------------------------------|---------|------------|----------|----------|-------------------|-------------------|------------------|------------------|-----------|-----------|-----------|
| TestMode | Channel | Radar Type | Trial ID | Burst ID | Burst Offset (μs) | Chirp Width (MHz) | Number Of Pulses | Pulse Width (μs) | PRI1 (μs) | PRI2 (μs) | PRI3 (μs) |
| 11ax20MIMO | 5500 | Type5 | 9 | 0 | 535615.0 | 6 | 1 | 63.4 | 1043.0 | --- | --- |
| 11ax20MIMO | 5500 | Type5 | 9 | 1 | 898668.0 | 6 | 1 | 52.0 | 1863.0 | --- | --- |
| 11ax20MIMO | 5500 | Type5 | 9 | 2 | 1259235.0 | 6 | 3 | 97.2 | 1973.0 | 1605.0 | 1583.0 |
| 11ax20MIMO | 5500 | Type5 | 9 | 3 | 127106.0 | 6 | 2 | 78.7 | 1466.0 | 1743.0 | --- |
| 11ax20MIMO | 5500 | Type5 | 9 | 4 | 490358.0 | 6 | 2 | 74.2 | 1280.0 | 1219.0 | --- |
| 11ax20MIMO | 5500 | Type5 | 9 | 5 | 852409.0 | 6 | 3 | 88.7 | 1293.0 | 1934.0 | 1273.0 |
| 11ax20MIMO | 5500 | Type5 | 9 | 6 | 1217152.0 | 6 | 1 | 54.3 | 1991.0 | --- | --- |
| 11ax20MIMO | 5500 | Type5 | 9 | 7 | 82296.0 | 6 | 3 | 95.4 | 1580.0 | 1555.0 | 1791.0 |
| 11ax40MIMO | 5510 | Type5 | 9 | 0 | 535615.0 | 6 | 1 | 63.4 | 1043.0 | --- | --- |
| 11ax40MIMO | 5510 | Type5 | 9 | 1 | 898668.0 | 6 | 1 | 52.0 | 1863.0 | --- | --- |
| 11ax40MIMO | 5510 | Type5 | 9 | 2 | 1259235.0 | 6 | 3 | 97.2 | 1973.0 | 1605.0 | 1583.0 |
| 11ax40MIMO | 5510 | Type5 | 9 | 3 | 127106.0 | 6 | 2 | 78.7 | 1466.0 | 1743.0 | --- |
| 11ax40MIMO | 5510 | Type5 | 9 | 4 | 490358.0 | 6 | 2 | 74.2 | 1280.0 | 1219.0 | --- |
| 11ax40MIMO | 5510 | Type5 | 9 | 5 | 852409.0 | 6 | 3 | 88.7 | 1293.0 | 1934.0 | 1273.0 |
| 11ax40MIMO | 5510 | Type5 | 9 | 6 | 1217152.0 | 6 | 1 | 54.3 | 1991.0 | --- | --- |
| 11ax40MIMO | 5510 | Type5 | 9 | 7 | 82296.0 | 6 | 3 | 95.4 | 1580.0 | 1555.0 | 1791.0 |
| 11ax80MIMO | 5530 | Type5 | 9 | 0 | 535615.0 | 6 | 1 | 63.4 | 1043.0 | --- | --- |
| 11ax80MIMO | 5530 | Type5 | 9 | 1 | 898668.0 | 6 | 1 | 52.0 | 1863.0 | --- | --- |
| 11ax80MIMO | 5530 | Type5 | 9 | 2 | 1259235.0 | 6 | 3 | 97.2 | 1973.0 | 1605.0 | 1583.0 |
| 11ax80MIMO | 5530 | Type5 | 9 | 3 | 127106.0 | 6 | 2 | 78.7 | 1466.0 | 1743.0 | --- |
| 11ax80MIMO | 5530 | Type5 | 9 | 4 | 490358.0 | 6 | 2 | 74.2 | 1280.0 | 1219.0 | --- |
| 11ax80MIMO | 5530 | Type5 | 9 | 5 | 852409.0 | 6 | 3 | 88.7 | 1293.0 | 1934.0 | 1273.0 |
| 11ax80MIMO | 5530 | Type5 | 9 | 6 | 1217152.0 | 6 | 1 | 54.3 | 1991.0 | --- | --- |
| 11ax80MIMO | 5530 | Type5 | 9 | 7 | 82296.0 | 6 | 3 | 95.4 | 1580.0 | 1555.0 | 1791.0 |
| 11ax160MIMO | 5570 | Type5 | 9 | 0 | 535615.0 | 6 | 1 | 63.4 | 1043.0 | --- | --- |
| 11ax160MIMO | 5570 | Type5 | 9 | 1 | 898668.0 | 6 | 1 | 52.0 | 1863.0 | --- | --- |
| 11ax160MIMO | 5570 | Type5 | 9 | 2 | 1259235.0 | 6 | 3 | 97.2 | 1973.0 | 1605.0 | 1583.0 |
| 11ax160MIMO | 5570 | Type5 | 9 | 3 | 127106.0 | 6 | 2 | 78.7 | 1466.0 | 1743.0 | --- |
| 11ax160MIMO | 5570 | Type5 | 9 | 4 | 490358.0 | 6 | 2 | 74.2 | 1280.0 | 1219.0 | --- |
| 11ax160MIMO | 5570 | Type5 | 9 | 5 | 852409.0 | 6 | 3 | 88.7 | 1293.0 | 1934.0 | 1273.0 |
| 11ax160MIMO | 5570 | Type5 | 9 | 6 | 1217152.0 | 6 | 1 | 54.3 | 1991.0 | --- | --- |
| 11ax160MIMO | 5570 | Type5 | 9 | 7 | 82296.0 | 6 | 3 | 95.4 | 1580.0 | 1555.0 | 1791.0 |



Unless otherwise agreed in writing, this document is issued by the Company subject to its General Conditions of Service printed overleaf, available on request or accessible at <http://www.sgs.com/en/Terms-and-Conditions.aspx> and, for electronic format documents, subject to Terms and Conditions for Electronic Documents at <http://www.sgs.com/en/Terms-and-Conditions/Terms-e-Documents.aspx>. Attention is drawn to the limitation of liability, indemnification and jurisdiction issues defined therein. Any holder of this document is advised that information contained hereon reflects the Company's findings at the time of its intervention only and within the limits of Client's instructions, if any. The Company's sole responsibility is to its Client and this document does not exonerate parties to a transaction from exercising all their rights and obligations under the transaction documents. This document cannot be reproduced except in full, without prior written approval of the Company. Any unauthorized alteration, forgery or falsification of the content or appearance of this document is unlawful and offenders may be prosecuted to the fullest extent of the law. Unless otherwise stated the results shown in this test report refer only to the sample(s) tested and such sample(s) are retained for 30 days only.

Attention: To check the authenticity of testing /inspection report & certificate, please contact us at telephone: (86-755) 8307 1443, or email: QN.Doccheck@sgs.com

South of No. 6 Plant, No. 1, Runsheng Road, Suzhou Industrial Park, Suzhou Area, China (Jiangsu) Pilot Free Trade Zone 215000 t (86-512) 62992980 www.sgs.com.cn
 中国·苏州·中国(江苏)自由贸易试验区苏州片区苏州工业园区润胜路1号的6号厂房南楼 邮编: 215000 t (86-512) 62992980 sgs.china@sgs.com

| @FCC_RLAN_DFS_SPC_Radar_T5_SP2_Tr10@ | | | | | | | | | | | |
|--------------------------------------|---------|------------|----------|----------|-------------------|-------------------|------------------|------------------|-----------|-----------|-----------|
| TestMode | Channel | Radar Type | Trial ID | Burst ID | Burst Offset (μs) | Chirp Width (MHz) | Number Of Pulses | Pulse Width (μs) | PRI1 (μs) | PRI2 (μs) | PRI3 (μs) |
| 11ax20MIMO | 5500 | Type5 | 10 | 0 | 209249.0 | 16 | 2 | 73.7 | 1208.0 | 1497.0 | --- |
| 11ax20MIMO | 5500 | Type5 | 10 | 1 | 378386.0 | 16 | 3 | 97.4 | 1942.0 | 1754.0 | 1613.0 |
| 11ax20MIMO | 5500 | Type5 | 10 | 2 | 548411.0 | 16 | 3 | 91.7 | 1999.0 | 1702.0 | 1462.0 |
| 11ax20MIMO | 5500 | Type5 | 10 | 3 | 17733.0 | 16 | 1 | 66.2 | 1393.0 | --- | --- |
| 11ax20MIMO | 5500 | Type5 | 10 | 4 | 187952.0 | 16 | 2 | 70.8 | 1968.0 | 1821.0 | --- |
| 11ax20MIMO | 5500 | Type5 | 10 | 5 | 359277.0 | 16 | 1 | 52.3 | 1740.0 | --- | --- |
| 11ax20MIMO | 5500 | Type5 | 10 | 6 | 528886.0 | 16 | 2 | 78.9 | 1308.0 | 1984.0 | --- |
| 11ax20MIMO | 5500 | Type5 | 10 | 7 | 700166.0 | 16 | 2 | 70.9 | 1050.0 | 1358.0 | --- |
| 11ax20MIMO | 5500 | Type5 | 10 | 8 | 167197.0 | 16 | 2 | 75.6 | 1437.0 | 1430.0 | --- |
| 11ax20MIMO | 5500 | Type5 | 10 | 9 | 338262.0 | 16 | 1 | 59.1 | 1697.0 | --- | --- |
| 11ax20MIMO | 5500 | Type5 | 10 | 10 | 508324.0 | 16 | 2 | 77.0 | 1397.0 | 1304.0 | --- |
| 11ax20MIMO | 5500 | Type5 | 10 | 11 | 678689.0 | 16 | 2 | 67.9 | 1803.0 | 1083.0 | --- |
| 11ax20MIMO | 5500 | Type5 | 10 | 12 | 146031.0 | 16 | 2 | 81.2 | 1720.0 | 1932.0 | --- |
| 11ax20MIMO | 5500 | Type5 | 10 | 13 | 316923.0 | 16 | 2 | 78.7 | 1247.0 | 1121.0 | --- |
| 11ax20MIMO | 5500 | Type5 | 10 | 14 | 488056.0 | 16 | 1 | 63.3 | 1634.0 | --- | --- |
| 11ax20MIMO | 5500 | Type5 | 10 | 15 | 657326.0 | 16 | 2 | 68.9 | 1849.0 | 1423.0 | --- |
| 11ax20MIMO | 5500 | Type5 | 10 | 16 | 125509.0 | 16 | 1 | 59.3 | 1093.0 | --- | --- |
| 11ax40MIMO | 5510 | Type5 | 10 | 0 | 209249.0 | 16 | 2 | 73.7 | 1208.0 | 1497.0 | --- |
| 11ax40MIMO | 5510 | Type5 | 10 | 1 | 378386.0 | 16 | 3 | 97.4 | 1942.0 | 1754.0 | 1613.0 |
| 11ax40MIMO | 5510 | Type5 | 10 | 2 | 548411.0 | 16 | 3 | 91.7 | 1999.0 | 1702.0 | 1462.0 |
| 11ax40MIMO | 5510 | Type5 | 10 | 3 | 17733.0 | 16 | 1 | 66.2 | 1393.0 | --- | --- |
| 11ax40MIMO | 5510 | Type5 | 10 | 4 | 187952.0 | 16 | 2 | 70.8 | 1968.0 | 1821.0 | --- |
| 11ax40MIMO | 5510 | Type5 | 10 | 5 | 359277.0 | 16 | 1 | 52.3 | 1740.0 | --- | --- |
| 11ax40MIMO | 5510 | Type5 | 10 | 6 | 528886.0 | 16 | 2 | 78.9 | 1308.0 | 1984.0 | --- |
| 11ax40MIMO | 5510 | Type5 | 10 | 7 | 700166.0 | 16 | 2 | 70.9 | 1050.0 | 1358.0 | --- |
| 11ax40MIMO | 5510 | Type5 | 10 | 8 | 167197.0 | 16 | 2 | 75.6 | 1437.0 | 1430.0 | --- |
| 11ax40MIMO | 5510 | Type5 | 10 | 9 | 338262.0 | 16 | 1 | 59.1 | 1697.0 | --- | --- |
| 11ax40MIMO | 5510 | Type5 | 10 | 10 | 508324.0 | 16 | 2 | 77.0 | 1397.0 | 1304.0 | --- |
| 11ax40MIMO | 5510 | Type5 | 10 | 11 | 678689.0 | 16 | 2 | 67.9 | 1803.0 | 1083.0 | --- |
| 11ax40MIMO | 5510 | Type5 | 10 | 12 | 146031.0 | 16 | 2 | 81.2 | 1720.0 | 1932.0 | --- |
| 11ax40MIMO | 5510 | Type5 | 10 | 13 | 316923.0 | 16 | 2 | 78.7 | 1247.0 | 1121.0 | --- |
| 11ax40MIMO | 5510 | Type5 | 10 | 14 | 488056.0 | 16 | 1 | 63.3 | 1634.0 | --- | --- |
| 11ax40MIMO | 5510 | Type5 | 10 | 15 | 657326.0 | 16 | 2 | 68.9 | 1849.0 | 1423.0 | --- |
| 11ax40MIMO | 5510 | Type5 | 10 | 16 | 125509.0 | 16 | 1 | 59.3 | 1093.0 | --- | --- |
| 11ax80MIMO | 5530 | Type5 | 10 | 0 | 209249.0 | 16 | 2 | 73.7 | 1208.0 | 1497.0 | --- |
| 11ax80MIMO | 5530 | Type5 | 10 | 1 | 378386.0 | 16 | 3 | 97.4 | 1942.0 | 1754.0 | 1613.0 |
| 11ax80MIMO | 5530 | Type5 | 10 | 2 | 548411.0 | 16 | 3 | 91.7 | 1999.0 | 1702.0 | 1462.0 |
| 11ax80MIMO | 5530 | Type5 | 10 | 3 | 17733.0 | 16 | 1 | 66.2 | 1393.0 | --- | --- |
| 11ax80MIMO | 5530 | Type5 | 10 | 4 | 187952.0 | 16 | 2 | 70.8 | 1968.0 | 1821.0 | --- |
| 11ax80MIMO | 5530 | Type5 | 10 | 5 | 359277.0 | 16 | 1 | 52.3 | 1740.0 | --- | --- |
| 11ax80MIMO | 5530 | Type5 | 10 | 6 | 528886.0 | 16 | 2 | 78.9 | 1308.0 | 1984.0 | --- |
| 11ax80MIMO | 5530 | Type5 | 10 | 7 | 700166.0 | 16 | 2 | 70.9 | 1050.0 | 1358.0 | --- |
| 11ax80MIMO | 5530 | Type5 | 10 | 8 | 167197.0 | 16 | 2 | 75.6 | 1437.0 | 1430.0 | --- |
| 11ax80MIMO | 5530 | Type5 | 10 | 9 | 338262.0 | 16 | 1 | 59.1 | 1697.0 | --- | --- |
| 11ax80MIMO | 5530 | Type5 | 10 | 10 | 508324.0 | 16 | 2 | 77.0 | 1397.0 | 1304.0 | --- |
| 11ax80MIMO | 5530 | Type5 | 10 | 11 | 678689.0 | 16 | 2 | 67.9 | 1803.0 | 1083.0 | --- |
| 11ax80MIMO | 5530 | Type5 | 10 | 12 | 146031.0 | 16 | 2 | 81.2 | 1720.0 | 1932.0 | --- |
| 11ax80MIMO | 5530 | Type5 | 10 | 13 | 316923.0 | 16 | 2 | 78.7 | 1247.0 | 1121.0 | --- |
| 11ax80MIMO | 5530 | Type5 | 10 | 14 | 488056.0 | 16 | 1 | 63.3 | 1634.0 | --- | --- |
| 11ax80MIMO | 5530 | Type5 | 10 | 15 | 657326.0 | 16 | 2 | 68.9 | 1849.0 | 1423.0 | --- |
| 11ax80MIMO | 5530 | Type5 | 10 | 16 | 125509.0 | 16 | 1 | 59.3 | 1093.0 | --- | --- |
| 11ax160MIMO | 5570 | Type5 | 10 | 0 | 209249.0 | 16 | 2 | 73.7 | 1208.0 | 1497.0 | --- |
| 11ax160MIMO | 5570 | Type5 | 10 | 1 | 378386.0 | 16 | 3 | 97.4 | 1942.0 | 1754.0 | 1613.0 |
| 11ax160MIMO | 5570 | Type5 | 10 | 2 | 548411.0 | 16 | 3 | 91.7 | 1999.0 | 1702.0 | 1462.0 |
| 11ax160MIMO | 5570 | Type5 | 10 | 3 | 17733.0 | 16 | 1 | 66.2 | 1393.0 | --- | --- |
| 11ax160MIMO | 5570 | Type5 | 10 | 4 | 187952.0 | 16 | 2 | 70.8 | 1968.0 | 1821.0 | --- |
| 11ax160MIMO | 5570 | Type5 | 10 | 5 | 359277.0 | 16 | 1 | 52.3 | 1740.0 | --- | --- |



Unless otherwise agreed in writing, this document is issued by the Company subject to its General Conditions of Service printed overleaf, available on request or accessible at <http://www.sgs.com/en/Terms-and-Conditions.aspx> and, for electronic format documents, subject to Terms and Conditions for Electronic Documents at <http://www.sgs.com/en/Terms-and-Conditions/Terms-e-Documents.aspx>. Attention is drawn to the limitation of liability, indemnification and jurisdiction issues defined therein. Any holder of this document is advised that information contained hereon reflects the Company's findings at the time of its intervention only and within the limits of Client's instructions, if any. The Company's sole responsibility is to its Client and this document does not exonerate parties to a transaction from exercising all their rights and obligations under the transaction documents. This document cannot be reproduced except in full, without prior written approval of the Company. Any unauthorized alteration, forgery or falsification of the content or appearance of this document is unlawful and offenders may be prosecuted to the fullest extent of the law. Unless otherwise stated the results shown in this report refer only to the sample(s) tested and such sample(s) are retained for 30 days only.

Attention: To check the authenticity of testing/inspection report & certificate, please contact us at telephone: (86-755) 8307 1443, or email: CN.Doccheck@sgs.com

Report No.: SEWA2303000041RG06

Rev.: 01

Page: 74 of 104

| | | | | | | | | | | | |
|-------------|------|-------|----|----|----------|----|---|------|--------|--------|-----|
| 11ax160MIMO | 5570 | Type5 | 10 | 6 | 528886.0 | 16 | 2 | 78.9 | 1308.0 | 1984.0 | --- |
| 11ax160MIMO | 5570 | Type5 | 10 | 7 | 700166.0 | 16 | 2 | 70.9 | 1050.0 | 1358.0 | --- |
| 11ax160MIMO | 5570 | Type5 | 10 | 8 | 167197.0 | 16 | 2 | 75.6 | 1437.0 | 1430.0 | --- |
| 11ax160MIMO | 5570 | Type5 | 10 | 9 | 338262.0 | 16 | 1 | 59.1 | 1697.0 | --- | --- |
| 11ax160MIMO | 5570 | Type5 | 10 | 10 | 508324.0 | 16 | 2 | 77.0 | 1397.0 | 1304.0 | --- |
| 11ax160MIMO | 5570 | Type5 | 10 | 11 | 678689.0 | 16 | 2 | 67.9 | 1803.0 | 1083.0 | --- |
| 11ax160MIMO | 5570 | Type5 | 10 | 12 | 146031.0 | 16 | 2 | 81.2 | 1720.0 | 1932.0 | --- |
| 11ax160MIMO | 5570 | Type5 | 10 | 13 | 316923.0 | 16 | 2 | 78.7 | 1247.0 | 1121.0 | --- |
| 11ax160MIMO | 5570 | Type5 | 10 | 14 | 488056.0 | 16 | 1 | 63.3 | 1634.0 | --- | --- |
| 11ax160MIMO | 5570 | Type5 | 10 | 15 | 657326.0 | 16 | 2 | 68.9 | 1849.0 | 1423.0 | --- |
| 11ax160MIMO | 5570 | Type5 | 10 | 16 | 125509.0 | 16 | 1 | 59.3 | 1093.0 | --- | --- |



Unless otherwise agreed in writing, this document is issued by the Company subject to its General Conditions of Service printed overleaf, available on request or accessible at <http://www.sgs.com/en/Terms-and-Conditions.aspx> and, for electronic format documents, subject to Terms and Conditions for Electronic Documents at <http://www.sgs.com/en/Terms-and-Conditions/Terms-e-Documents.aspx>. Attention is drawn to the limitation of liability, indemnification and jurisdiction issues defined therein. Any holder of this document is advised that information contained hereon reflects the Company's findings at the time of its intervention only and within the limits of Client's instructions, if any. The Company's sole responsibility is to its Client and this document does not exonerate parties to a transaction from exercising all their rights and obligations under the transaction documents. This document cannot be reproduced except in full, without prior written approval of the Company. Any unauthorized alteration, forgery or falsification of the content or appearance of this document is unlawful and offenders may be prosecuted to the fullest extent of the law. Unless otherwise stated the results shown in this test report refer only to the sample(s) tested and such sample(s) are retained for 30 days only.

Attention: To check the authenticity of testing /inspection report & certificate, please contact us at telephone: (86-755) 8307 1443, or email: CN.Doccheck@sgs.com

| @FCC_RLAN_DFS_SPC_Radar_T5_SP2_Tr11@ | | | | | | | | | | | |
|--------------------------------------|---------|------------|----------|----------|-------------------|-------------------|------------------|------------------|-----------|-----------|-----------|
| TestMode | Channel | Radar Type | Trial ID | Burst ID | Burst Offset (μs) | Chirp Width (MHz) | Number Of Pulses | Pulse Width (μs) | PRI1 (μs) | PRI2 (μs) | PRI3 (μs) |
| 11ax20MIMO | 5500 | Type5 | 11 | 0 | 263736.0 | 19 | 3 | 98.9 | 1381.0 | 1680.0 | 1488.0 |
| 11ax20MIMO | 5500 | Type5 | 11 | 1 | 416459.0 | 19 | 2 | 82.3 | 1716.0 | 1855.0 | --- |
| 11ax20MIMO | 5500 | Type5 | 11 | 2 | 567902.0 | 19 | 3 | 86.7 | 1211.0 | 1400.0 | 1919.0 |
| 11ax20MIMO | 5500 | Type5 | 11 | 3 | 92979.0 | 19 | 3 | 89.7 | 1861.0 | 1068.0 | 1282.0 |
| 11ax20MIMO | 5500 | Type5 | 11 | 4 | 245155.0 | 19 | 3 | 98.6 | 1507.0 | 1194.0 | 1461.0 |
| 11ax20MIMO | 5500 | Type5 | 11 | 5 | 397609.0 | 19 | 2 | 71.1 | 1921.0 | 1789.0 | --- |
| 11ax20MIMO | 5500 | Type5 | 11 | 6 | 551431.0 | 19 | 1 | 55.9 | 1947.0 | --- | --- |
| 11ax20MIMO | 5500 | Type5 | 11 | 7 | 74413.0 | 19 | 2 | 67.9 | 1350.0 | 1372.0 | --- |
| 11ax20MIMO | 5500 | Type5 | 11 | 8 | 226559.0 | 19 | 3 | 84.4 | 1203.0 | 1107.0 | 1443.0 |
| 11ax20MIMO | 5500 | Type5 | 11 | 9 | 380056.0 | 19 | 1 | 58.8 | 1715.0 | --- | --- |
| 11ax20MIMO | 5500 | Type5 | 11 | 10 | 533408.0 | 19 | 1 | 65.6 | 1017.0 | --- | --- |
| 11ax20MIMO | 5500 | Type5 | 11 | 11 | 55547.0 | 19 | 2 | 78.5 | 1911.0 | 1704.0 | --- |
| 11ax20MIMO | 5500 | Type5 | 11 | 12 | 207876.0 | 19 | 2 | 82.3 | 1845.0 | 1686.0 | --- |
| 11ax20MIMO | 5500 | Type5 | 11 | 13 | 359771.0 | 19 | 3 | 90.1 | 1938.0 | 1071.0 | 1266.0 |
| 11ax20MIMO | 5500 | Type5 | 11 | 14 | 511297.0 | 19 | 3 | 90.2 | 1989.0 | 1089.0 | 1950.0 |
| 11ax20MIMO | 5500 | Type5 | 11 | 15 | 36803.0 | 19 | 2 | 83.1 | 1943.0 | 1406.0 | --- |
| 11ax20MIMO | 5500 | Type5 | 11 | 16 | 189652.0 | 19 | 1 | 58.8 | 1742.0 | --- | --- |
| 11ax20MIMO | 5500 | Type5 | 11 | 17 | 341809.0 | 19 | 2 | 77.0 | 1187.0 | 1657.0 | --- |
| 11ax20MIMO | 5500 | Type5 | 11 | 18 | 495737.0 | 19 | 1 | 55.0 | 1012.0 | --- | --- |
| 11ax40MIMO | 5510 | Type5 | 11 | 0 | 263736.0 | 19 | 3 | 98.9 | 1381.0 | 1680.0 | 1488.0 |
| 11ax40MIMO | 5510 | Type5 | 11 | 1 | 416459.0 | 19 | 2 | 82.3 | 1716.0 | 1855.0 | --- |
| 11ax40MIMO | 5510 | Type5 | 11 | 2 | 567902.0 | 19 | 3 | 86.7 | 1211.0 | 1400.0 | 1919.0 |
| 11ax40MIMO | 5510 | Type5 | 11 | 3 | 92979.0 | 19 | 3 | 89.7 | 1861.0 | 1068.0 | 1282.0 |
| 11ax40MIMO | 5510 | Type5 | 11 | 4 | 245155.0 | 19 | 3 | 98.6 | 1507.0 | 1194.0 | 1461.0 |
| 11ax40MIMO | 5510 | Type5 | 11 | 5 | 397609.0 | 19 | 2 | 71.1 | 1921.0 | 1789.0 | --- |
| 11ax40MIMO | 5510 | Type5 | 11 | 6 | 551431.0 | 19 | 1 | 55.9 | 1947.0 | --- | --- |
| 11ax40MIMO | 5510 | Type5 | 11 | 7 | 74413.0 | 19 | 2 | 67.9 | 1350.0 | 1372.0 | --- |
| 11ax40MIMO | 5510 | Type5 | 11 | 8 | 226559.0 | 19 | 3 | 84.4 | 1203.0 | 1107.0 | 1443.0 |
| 11ax40MIMO | 5510 | Type5 | 11 | 9 | 380056.0 | 19 | 1 | 58.8 | 1715.0 | --- | --- |
| 11ax40MIMO | 5510 | Type5 | 11 | 10 | 533408.0 | 19 | 1 | 65.6 | 1017.0 | --- | --- |
| 11ax40MIMO | 5510 | Type5 | 11 | 11 | 55547.0 | 19 | 2 | 78.5 | 1911.0 | 1704.0 | --- |
| 11ax40MIMO | 5510 | Type5 | 11 | 12 | 207876.0 | 19 | 2 | 82.3 | 1845.0 | 1686.0 | --- |
| 11ax40MIMO | 5510 | Type5 | 11 | 13 | 359771.0 | 19 | 3 | 90.1 | 1938.0 | 1071.0 | 1266.0 |
| 11ax40MIMO | 5510 | Type5 | 11 | 14 | 511297.0 | 19 | 3 | 90.2 | 1989.0 | 1089.0 | 1950.0 |
| 11ax40MIMO | 5510 | Type5 | 11 | 15 | 36803.0 | 19 | 2 | 83.1 | 1943.0 | 1406.0 | --- |
| 11ax40MIMO | 5510 | Type5 | 11 | 16 | 189652.0 | 19 | 1 | 58.8 | 1742.0 | --- | --- |
| 11ax40MIMO | 5510 | Type5 | 11 | 17 | 341809.0 | 19 | 2 | 77.0 | 1187.0 | 1657.0 | --- |
| 11ax40MIMO | 5510 | Type5 | 11 | 18 | 495737.0 | 19 | 1 | 55.0 | 1012.0 | --- | --- |
| 11ax80MIMO | 5530 | Type5 | 11 | 0 | 263736.0 | 19 | 3 | 98.9 | 1381.0 | 1680.0 | 1488.0 |
| 11ax80MIMO | 5530 | Type5 | 11 | 1 | 416459.0 | 19 | 2 | 82.3 | 1716.0 | 1855.0 | --- |
| 11ax80MIMO | 5530 | Type5 | 11 | 2 | 567902.0 | 19 | 3 | 86.7 | 1211.0 | 1400.0 | 1919.0 |
| 11ax80MIMO | 5530 | Type5 | 11 | 3 | 92979.0 | 19 | 3 | 89.7 | 1861.0 | 1068.0 | 1282.0 |
| 11ax80MIMO | 5530 | Type5 | 11 | 4 | 245155.0 | 19 | 3 | 98.6 | 1507.0 | 1194.0 | 1461.0 |
| 11ax80MIMO | 5530 | Type5 | 11 | 5 | 397609.0 | 19 | 2 | 71.1 | 1921.0 | 1789.0 | --- |
| 11ax80MIMO | 5530 | Type5 | 11 | 6 | 551431.0 | 19 | 1 | 55.9 | 1947.0 | --- | --- |
| 11ax80MIMO | 5530 | Type5 | 11 | 7 | 74413.0 | 19 | 2 | 67.9 | 1350.0 | 1372.0 | --- |
| 11ax80MIMO | 5530 | Type5 | 11 | 8 | 226559.0 | 19 | 3 | 84.4 | 1203.0 | 1107.0 | 1443.0 |
| 11ax80MIMO | 5530 | Type5 | 11 | 9 | 380056.0 | 19 | 1 | 58.8 | 1715.0 | --- | --- |
| 11ax80MIMO | 5530 | Type5 | 11 | 10 | 533408.0 | 19 | 1 | 65.6 | 1017.0 | --- | --- |
| 11ax80MIMO | 5530 | Type5 | 11 | 11 | 55547.0 | 19 | 2 | 78.5 | 1911.0 | 1704.0 | --- |
| 11ax80MIMO | 5530 | Type5 | 11 | 12 | 207876.0 | 19 | 2 | 82.3 | 1845.0 | 1686.0 | --- |
| 11ax80MIMO | 5530 | Type5 | 11 | 13 | 359771.0 | 19 | 3 | 90.1 | 1938.0 | 1071.0 | 1266.0 |
| 11ax80MIMO | 5530 | Type5 | 11 | 14 | 511297.0 | 19 | 3 | 90.2 | 1989.0 | 1089.0 | 1950.0 |
| 11ax80MIMO | 5530 | Type5 | 11 | 15 | 36803.0 | 19 | 2 | 83.1 | 1943.0 | 1406.0 | --- |
| 11ax80MIMO | 5530 | Type5 | 11 | 16 | 189652.0 | 19 | 1 | 58.8 | 1742.0 | --- | --- |
| 11ax80MIMO | 5530 | Type5 | 11 | 17 | 341809.0 | 19 | 2 | 77.0 | 1187.0 | 1657.0 | --- |
| 11ax80MIMO | 5530 | Type5 | 11 | 18 | 495737.0 | 19 | 1 | 55.0 | 1012.0 | --- | --- |



Unless otherwise agreed in writing, this document is issued by the Company subject to its General Conditions of Service printed overleaf, available on request or accessible at <http://www.sgs.com/en/Terms-and-Conditions.aspx> and, for electronic format documents, subject to Terms and Conditions for Electronic Documents at <http://www.sgs.com/en/Terms-and-Conditions/Terms-e-Documents.aspx>. Attention is drawn to the limitation of liability, indemnification and jurisdiction issues defined therein. Any holder of this document is advised that information contained hereon reflects the Company's findings at the time of its intervention only and within the limits of Client's instructions, if any. The Company's sole responsibility is to its Client and this document does not exonerate parties to a transaction from exercising all their rights and obligations under the transaction documents. This document cannot be reproduced except in full, without prior written approval of the Company. Any unauthorized alteration, forgery or falsification of the content or appearance of this document is unlawful and offenders may be prosecuted to the fullest extent of the law. Unless otherwise stated the results shown in this test report refer only to the sample(s) tested and such sample(s) are retained for 30 days only.

Attention: To check the authenticity of testing/inspection report & certificate, please contact us at telephone: (86-755) 8307 1443, or email: QN.Doccheck@sgs.com



| | | | | | | | | | | | |
|-------------|------|-------|----|----|----------|----|---|------|--------|--------|--------|
| 11ax160MIMO | 5570 | Type5 | 11 | 0 | 263736.0 | 19 | 3 | 98.9 | 1381.0 | 1680.0 | 1488.0 |
| 11ax160MIMO | 5570 | Type5 | 11 | 1 | 416459.0 | 19 | 2 | 82.3 | 1716.0 | 1855.0 | --- |
| 11ax160MIMO | 5570 | Type5 | 11 | 2 | 567902.0 | 19 | 3 | 86.7 | 1211.0 | 1400.0 | 1919.0 |
| 11ax160MIMO | 5570 | Type5 | 11 | 3 | 92979.0 | 19 | 3 | 89.7 | 1861.0 | 1068.0 | 1282.0 |
| 11ax160MIMO | 5570 | Type5 | 11 | 4 | 245155.0 | 19 | 3 | 98.6 | 1507.0 | 1194.0 | 1461.0 |
| 11ax160MIMO | 5570 | Type5 | 11 | 5 | 397609.0 | 19 | 2 | 71.1 | 1921.0 | 1789.0 | --- |
| 11ax160MIMO | 5570 | Type5 | 11 | 6 | 551431.0 | 19 | 1 | 55.9 | 1947.0 | --- | --- |
| 11ax160MIMO | 5570 | Type5 | 11 | 7 | 74413.0 | 19 | 2 | 67.9 | 1350.0 | 1372.0 | --- |
| 11ax160MIMO | 5570 | Type5 | 11 | 8 | 226559.0 | 19 | 3 | 84.4 | 1203.0 | 1107.0 | 1443.0 |
| 11ax160MIMO | 5570 | Type5 | 11 | 9 | 380056.0 | 19 | 1 | 58.8 | 1715.0 | --- | --- |
| 11ax160MIMO | 5570 | Type5 | 11 | 10 | 533408.0 | 19 | 1 | 65.6 | 1017.0 | --- | --- |
| 11ax160MIMO | 5570 | Type5 | 11 | 11 | 55547.0 | 19 | 2 | 78.5 | 1911.0 | 1704.0 | --- |
| 11ax160MIMO | 5570 | Type5 | 11 | 12 | 207876.0 | 19 | 2 | 82.3 | 1845.0 | 1686.0 | --- |
| 11ax160MIMO | 5570 | Type5 | 11 | 13 | 359771.0 | 19 | 3 | 90.1 | 1938.0 | 1071.0 | 1266.0 |
| 11ax160MIMO | 5570 | Type5 | 11 | 14 | 511297.0 | 19 | 3 | 90.2 | 1989.0 | 1089.0 | 1950.0 |
| 11ax160MIMO | 5570 | Type5 | 11 | 15 | 36803.0 | 19 | 2 | 83.1 | 1943.0 | 1406.0 | --- |
| 11ax160MIMO | 5570 | Type5 | 11 | 16 | 189652.0 | 19 | 1 | 58.8 | 1742.0 | --- | --- |
| 11ax160MIMO | 5570 | Type5 | 11 | 17 | 341809.0 | 19 | 2 | 77.0 | 1187.0 | 1657.0 | --- |
| 11ax160MIMO | 5570 | Type5 | 11 | 18 | 495737.0 | 19 | 1 | 55.0 | 1012.0 | --- | --- |



Unless otherwise agreed in writing, this document is issued by the Company subject to its General Conditions of Service printed overleaf, available on request or accessible at <http://www.sgs.com/en/Terms-and-Conditions.aspx> and, for electronic format documents, subject to Terms and Conditions for Electronic Documents at <http://www.sgs.com/en/Terms-and-Conditions/Terms-e-Documents.aspx>. Attention is drawn to the limitation of liability, indemnification and jurisdiction issues defined therein. Any holder of this document is advised that information contained hereon reflects the Company's findings at the time of its intervention only and within the limits of Client's instructions, if any. The Company's sole responsibility is to its Client and this document does not exonerate parties to a transaction from exercising all their rights and obligations under the transaction documents. This document cannot be reproduced except in full, without prior written approval of the Company. Any unauthorized alteration, forgery or falsification of the content or appearance of this document is unlawful and offenders may be prosecuted to the fullest extent of the law. Unless otherwise stated the results shown in this test report refer only to the sample(s) tested and such sample(s) are retained for 30 days only.

Attention: To check the authenticity of testing /inspection report & certificate, please contact us at telephone: (86-755) 8307 1443, or email: CN.Doccheck@sgs.com

| @FCC_RLAN_DFS_SPC_Radar_T5_SP2_Tr12@ | | | | | | | | | | | |
|--------------------------------------|---------|------------|----------|----------|-------------------|-------------------|------------------|------------------|-----------|-----------|-----------|
| TestMode | Channel | Radar Type | Trial ID | Burst ID | Burst Offset (μs) | Chirp Width (MHz) | Number Of Pulses | Pulse Width (μs) | PRI1 (μs) | PRI2 (μs) | PRI3 (μs) |
| 11ax20MIMO | 5500 | Type5 | 12 | 0 | 22911.0 | 13 | 1 | 58.1 | 1929.0 | --- | --- |
| 11ax20MIMO | 5500 | Type5 | 12 | 1 | 216473.0 | 13 | 1 | 52.1 | 1910.0 | --- | --- |
| 11ax20MIMO | 5500 | Type5 | 12 | 2 | 410004.0 | 13 | 1 | 59.9 | 1971.0 | --- | --- |
| 11ax20MIMO | 5500 | Type5 | 12 | 3 | 603671.0 | 13 | 1 | 60.2 | 1812.0 | --- | --- |
| 11ax20MIMO | 5500 | Type5 | 12 | 4 | 794160.0 | 13 | 3 | 95.9 | 1399.0 | 1906.0 | 1608.0 |
| 11ax20MIMO | 5500 | Type5 | 12 | 5 | 192251.0 | 13 | 2 | 79.9 | 1626.0 | 1859.0 | --- |
| 11ax20MIMO | 5500 | Type5 | 12 | 6 | 385590.0 | 13 | 2 | 78.5 | 1238.0 | 1917.0 | --- |
| 11ax20MIMO | 5500 | Type5 | 12 | 7 | 579862.0 | 13 | 1 | 53.8 | 1763.0 | --- | --- |
| 11ax20MIMO | 5500 | Type5 | 12 | 8 | 773423.0 | 13 | 1 | 64.7 | 1800.0 | --- | --- |
| 11ax20MIMO | 5500 | Type5 | 12 | 9 | 168898.0 | 13 | 1 | 61.4 | 1390.0 | --- | --- |
| 11ax20MIMO | 5500 | Type5 | 12 | 10 | 361606.0 | 13 | 2 | 83.2 | 1692.0 | 1858.0 | --- |
| 11ax20MIMO | 5500 | Type5 | 12 | 11 | 553866.0 | 13 | 3 | 84.7 | 1533.0 | 1677.0 | 1638.0 |
| 11ax20MIMO | 5500 | Type5 | 12 | 12 | 747241.0 | 13 | 3 | 88.7 | 1703.0 | 1528.0 | 1058.0 |
| 11ax20MIMO | 5500 | Type5 | 12 | 13 | 144710.0 | 13 | 2 | 78.3 | 1258.0 | 1951.0 | --- |
| 11ax20MIMO | 5500 | Type5 | 12 | 14 | 337856.0 | 13 | 2 | 69.3 | 1731.0 | 1717.0 | --- |
| 11ax40MIMO | 5510 | Type5 | 12 | 0 | 22911.0 | 13 | 1 | 58.1 | 1929.0 | --- | --- |
| 11ax40MIMO | 5510 | Type5 | 12 | 1 | 216473.0 | 13 | 1 | 52.1 | 1910.0 | --- | --- |
| 11ax40MIMO | 5510 | Type5 | 12 | 2 | 410004.0 | 13 | 1 | 59.9 | 1971.0 | --- | --- |
| 11ax40MIMO | 5510 | Type5 | 12 | 3 | 603671.0 | 13 | 1 | 60.2 | 1812.0 | --- | --- |
| 11ax40MIMO | 5510 | Type5 | 12 | 4 | 794160.0 | 13 | 3 | 95.9 | 1399.0 | 1906.0 | 1608.0 |
| 11ax40MIMO | 5510 | Type5 | 12 | 5 | 192251.0 | 13 | 2 | 79.9 | 1626.0 | 1859.0 | --- |
| 11ax40MIMO | 5510 | Type5 | 12 | 6 | 385590.0 | 13 | 2 | 78.5 | 1238.0 | 1917.0 | --- |
| 11ax40MIMO | 5510 | Type5 | 12 | 7 | 579862.0 | 13 | 1 | 53.8 | 1763.0 | --- | --- |
| 11ax40MIMO | 5510 | Type5 | 12 | 8 | 773423.0 | 13 | 1 | 64.7 | 1800.0 | --- | --- |
| 11ax40MIMO | 5510 | Type5 | 12 | 9 | 168898.0 | 13 | 1 | 61.4 | 1390.0 | --- | --- |
| 11ax40MIMO | 5510 | Type5 | 12 | 10 | 361606.0 | 13 | 2 | 83.2 | 1692.0 | 1858.0 | --- |
| 11ax40MIMO | 5510 | Type5 | 12 | 11 | 553866.0 | 13 | 3 | 84.7 | 1533.0 | 1677.0 | 1638.0 |
| 11ax40MIMO | 5510 | Type5 | 12 | 12 | 747241.0 | 13 | 3 | 88.7 | 1703.0 | 1528.0 | 1058.0 |
| 11ax40MIMO | 5510 | Type5 | 12 | 13 | 144710.0 | 13 | 2 | 78.3 | 1258.0 | 1951.0 | --- |
| 11ax40MIMO | 5510 | Type5 | 12 | 14 | 337856.0 | 13 | 2 | 69.3 | 1731.0 | 1717.0 | --- |
| 11ax80MIMO | 5530 | Type5 | 12 | 0 | 22911.0 | 13 | 1 | 58.1 | 1929.0 | --- | --- |
| 11ax80MIMO | 5530 | Type5 | 12 | 1 | 216473.0 | 13 | 1 | 52.1 | 1910.0 | --- | --- |
| 11ax80MIMO | 5530 | Type5 | 12 | 2 | 410004.0 | 13 | 1 | 59.9 | 1971.0 | --- | --- |
| 11ax80MIMO | 5530 | Type5 | 12 | 3 | 603671.0 | 13 | 1 | 60.2 | 1812.0 | --- | --- |
| 11ax80MIMO | 5530 | Type5 | 12 | 4 | 794160.0 | 13 | 3 | 95.9 | 1399.0 | 1906.0 | 1608.0 |
| 11ax80MIMO | 5530 | Type5 | 12 | 5 | 192251.0 | 13 | 2 | 79.9 | 1626.0 | 1859.0 | --- |
| 11ax80MIMO | 5530 | Type5 | 12 | 6 | 385590.0 | 13 | 2 | 78.5 | 1238.0 | 1917.0 | --- |
| 11ax80MIMO | 5530 | Type5 | 12 | 7 | 579862.0 | 13 | 1 | 53.8 | 1763.0 | --- | --- |
| 11ax80MIMO | 5530 | Type5 | 12 | 8 | 773423.0 | 13 | 1 | 64.7 | 1800.0 | --- | --- |
| 11ax80MIMO | 5530 | Type5 | 12 | 9 | 168898.0 | 13 | 1 | 61.4 | 1390.0 | --- | --- |
| 11ax80MIMO | 5530 | Type5 | 12 | 10 | 361606.0 | 13 | 2 | 83.2 | 1692.0 | 1858.0 | --- |
| 11ax80MIMO | 5530 | Type5 | 12 | 11 | 553866.0 | 13 | 3 | 84.7 | 1533.0 | 1677.0 | 1638.0 |
| 11ax80MIMO | 5530 | Type5 | 12 | 12 | 747241.0 | 13 | 3 | 88.7 | 1703.0 | 1528.0 | 1058.0 |
| 11ax80MIMO | 5530 | Type5 | 12 | 13 | 144710.0 | 13 | 2 | 78.3 | 1258.0 | 1951.0 | --- |
| 11ax80MIMO | 5530 | Type5 | 12 | 14 | 337856.0 | 13 | 2 | 69.3 | 1731.0 | 1717.0 | --- |
| 11ax160MIMO | 5570 | Type5 | 12 | 0 | 22911.0 | 13 | 1 | 58.1 | 1929.0 | --- | --- |
| 11ax160MIMO | 5570 | Type5 | 12 | 1 | 216473.0 | 13 | 1 | 52.1 | 1910.0 | --- | --- |
| 11ax160MIMO | 5570 | Type5 | 12 | 2 | 410004.0 | 13 | 1 | 59.9 | 1971.0 | --- | --- |
| 11ax160MIMO | 5570 | Type5 | 12 | 3 | 603671.0 | 13 | 1 | 60.2 | 1812.0 | --- | --- |
| 11ax160MIMO | 5570 | Type5 | 12 | 4 | 794160.0 | 13 | 3 | 95.9 | 1399.0 | 1906.0 | 1608.0 |
| 11ax160MIMO | 5570 | Type5 | 12 | 5 | 192251.0 | 13 | 2 | 79.9 | 1626.0 | 1859.0 | --- |
| 11ax160MIMO | 5570 | Type5 | 12 | 6 | 385590.0 | 13 | 2 | 78.5 | 1238.0 | 1917.0 | --- |
| 11ax160MIMO | 5570 | Type5 | 12 | 7 | 579862.0 | 13 | 1 | 53.8 | 1763.0 | --- | --- |
| 11ax160MIMO | 5570 | Type5 | 12 | 8 | 773423.0 | 13 | 1 | 64.7 | 1800.0 | --- | --- |
| 11ax160MIMO | 5570 | Type5 | 12 | 9 | 168898.0 | 13 | 1 | 61.4 | 1390.0 | --- | --- |
| 11ax160MIMO | 5570 | Type5 | 12 | 10 | 361606.0 | 13 | 2 | 83.2 | 1692.0 | 1858.0 | --- |
| 11ax160MIMO | 5570 | Type5 | 12 | 11 | 553866.0 | 13 | 3 | 84.7 | 1533.0 | 1677.0 | 1638.0 |



Unless otherwise agreed in writing, this document is issued by the Company subject to its General Conditions of Service printed overleaf, available on request or accessible at <http://www.sgs.com/en/Terms-and-Conditions.aspx> and, for electronic format documents, subject to Terms and Conditions for Electronic Documents at <http://www.sgs.com/en/Terms-and-Conditions/Terms-e-Documents.aspx>. Attention is drawn to the limitation of liability, indemnification and jurisdiction issues defined therein. Any holder of this document is advised that information contained hereon reflects the Company's findings at the time of its intervention only and within the limits of Client's instructions, if any. The Company's sole responsibility is to its Client and this document does not exonerate parties to a transaction from exercising all their rights and obligations under the transaction documents. This document cannot be reproduced except in full, without prior written approval of the Company. Any unauthorized alteration, forgery or falsification of the content or appearance of this document is unlawful and offenders may be prosecuted to the fullest extent of the law. Unless otherwise stated the results shown in this report refer only to the sample(s) tested and such sample(s) are retained for 30 days only.

Attention: To check the authenticity of testing/inspection report & certificate, please contact us at telephone: (86-755) 8307 1443, or email: CN.Doccheck@sgs.com



Report No.: SEWA2303000041RG06

Rev.: 01

Page: 78 of 104

| | | | | | | | | | | | |
|-------------|------|-------|----|----|----------|----|---|------|--------|--------|--------|
| 11ax160MIMO | 5570 | Type5 | 12 | 12 | 747241.0 | 13 | 3 | 88.7 | 1703.0 | 1528.0 | 1058.0 |
| 11ax160MIMO | 5570 | Type5 | 12 | 13 | 144710.0 | 13 | 2 | 78.3 | 1258.0 | 1951.0 | --- |
| 11ax160MIMO | 5570 | Type5 | 12 | 14 | 337856.0 | 13 | 2 | 69.3 | 1731.0 | 1717.0 | --- |



Unless otherwise agreed in writing, this document is issued by the Company subject to its General Conditions of Service printed overleaf, available on request or accessible at <http://www.sgs.com/en/Terms-and-Conditions.aspx> and, for electronic format documents, subject to Terms and Conditions for Electronic Documents at <http://www.sgs.com/en/Terms-and-Conditions/Terms-e-Documents.aspx>. Attention is drawn to the limitation of liability, indemnification and jurisdiction issues defined therein. Any holder of this document is advised that information contained hereon reflects the Company's findings at the time of its intervention only and within the limits of Client's instructions, if any. The Company's sole responsibility is to its Client and this document does not exonerate parties to a transaction from exercising all their rights and obligations under the transaction documents. This document cannot be reproduced except in full, without prior written approval of the Company. Any unauthorized alteration, forgery or falsification of the content or appearance of this document is unlawful and offenders may be prosecuted to the fullest extent of the law. Unless otherwise stated the results shown in this test report refer only to the sample(s) tested and such sample(s) are retained for 30 days only.

Attention: To check the authenticity of testing /inspection report & certificate, please contact us at telephone: (86-755) 8307 1443, or email: CN.Doccheck@sgs.com

| @FCC_RLAN_DFS_SPC_Radar_T5_SP2_Tr13@ | | | | | | | | | | | |
|--------------------------------------|---------|------------|----------|----------|-------------------|-------------------|------------------|------------------|-----------|-----------|-----------|
| TestMode | Channel | Radar Type | Trial ID | Burst ID | Burst Offset (μs) | Chirp Width (MHz) | Number Of Pulses | Pulse Width (μs) | PRI1 (μs) | PRI2 (μs) | PRI3 (μs) |
| 11ax20MIMO | 5500 | Type5 | 13 | 0 | 664275.0 | 10 | 2 | 75.3 | 1994.0 | 1612.0 | --- |
| 11ax20MIMO | 5500 | Type5 | 13 | 1 | 907886.0 | 10 | 1 | 56.3 | 1456.0 | --- | --- |
| 11ax20MIMO | 5500 | Type5 | 13 | 2 | 151316.0 | 10 | 2 | 67.7 | 1617.0 | 1185.0 | --- |
| 11ax20MIMO | 5500 | Type5 | 13 | 3 | 393746.0 | 10 | 1 | 55.6 | 1337.0 | --- | --- |
| 11ax20MIMO | 5500 | Type5 | 13 | 4 | 635093.0 | 10 | 2 | 75.2 | 1421.0 | 1267.0 | --- |
| 11ax20MIMO | 5500 | Type5 | 13 | 5 | 876993.0 | 10 | 2 | 76.3 | 1359.0 | 1305.0 | --- |
| 11ax20MIMO | 5500 | Type5 | 13 | 6 | 121278.0 | 10 | 3 | 85.7 | 1547.0 | 1362.0 | 1924.0 |
| 11ax20MIMO | 5500 | Type5 | 13 | 7 | 362696.0 | 10 | 3 | 98.4 | 1873.0 | 1550.0 | 1249.0 |
| 11ax20MIMO | 5500 | Type5 | 13 | 8 | 604342.0 | 10 | 3 | 86.4 | 1779.0 | 1439.0 | 1046.0 |
| 11ax20MIMO | 5500 | Type5 | 13 | 9 | 846453.0 | 10 | 3 | 93.6 | 1059.0 | 1031.0 | 1452.0 |
| 11ax20MIMO | 5500 | Type5 | 13 | 10 | 91871.0 | 10 | 1 | 63.3 | 1328.0 | --- | --- |
| 11ax20MIMO | 5500 | Type5 | 13 | 11 | 333050.0 | 10 | 3 | 92.4 | 1412.0 | 1673.0 | 1322.0 |
| 11ax40MIMO | 5510 | Type5 | 13 | 0 | 664275.0 | 10 | 2 | 75.3 | 1994.0 | 1612.0 | --- |
| 11ax40MIMO | 5510 | Type5 | 13 | 1 | 907886.0 | 10 | 1 | 56.3 | 1456.0 | --- | --- |
| 11ax40MIMO | 5510 | Type5 | 13 | 2 | 151316.0 | 10 | 2 | 67.7 | 1617.0 | 1185.0 | --- |
| 11ax40MIMO | 5510 | Type5 | 13 | 3 | 393746.0 | 10 | 1 | 55.6 | 1337.0 | --- | --- |
| 11ax40MIMO | 5510 | Type5 | 13 | 4 | 635093.0 | 10 | 2 | 75.2 | 1421.0 | 1267.0 | --- |
| 11ax40MIMO | 5510 | Type5 | 13 | 5 | 876993.0 | 10 | 2 | 76.3 | 1359.0 | 1305.0 | --- |
| 11ax40MIMO | 5510 | Type5 | 13 | 6 | 121278.0 | 10 | 3 | 85.7 | 1547.0 | 1362.0 | 1924.0 |
| 11ax40MIMO | 5510 | Type5 | 13 | 7 | 362696.0 | 10 | 3 | 98.4 | 1873.0 | 1550.0 | 1249.0 |
| 11ax40MIMO | 5510 | Type5 | 13 | 8 | 604342.0 | 10 | 3 | 86.4 | 1779.0 | 1439.0 | 1046.0 |
| 11ax40MIMO | 5510 | Type5 | 13 | 9 | 846453.0 | 10 | 3 | 93.6 | 1059.0 | 1031.0 | 1452.0 |
| 11ax40MIMO | 5510 | Type5 | 13 | 10 | 91871.0 | 10 | 1 | 63.3 | 1328.0 | --- | --- |
| 11ax40MIMO | 5510 | Type5 | 13 | 11 | 333050.0 | 10 | 3 | 92.4 | 1412.0 | 1673.0 | 1322.0 |
| 11ax80MIMO | 5530 | Type5 | 13 | 0 | 664275.0 | 10 | 2 | 75.3 | 1994.0 | 1612.0 | --- |
| 11ax80MIMO | 5530 | Type5 | 13 | 1 | 907886.0 | 10 | 1 | 56.3 | 1456.0 | --- | --- |
| 11ax80MIMO | 5530 | Type5 | 13 | 2 | 151316.0 | 10 | 2 | 67.7 | 1617.0 | 1185.0 | --- |
| 11ax80MIMO | 5530 | Type5 | 13 | 3 | 393746.0 | 10 | 1 | 55.6 | 1337.0 | --- | --- |
| 11ax80MIMO | 5530 | Type5 | 13 | 4 | 635093.0 | 10 | 2 | 75.2 | 1421.0 | 1267.0 | --- |
| 11ax80MIMO | 5530 | Type5 | 13 | 5 | 876993.0 | 10 | 2 | 76.3 | 1359.0 | 1305.0 | --- |
| 11ax80MIMO | 5530 | Type5 | 13 | 6 | 121278.0 | 10 | 3 | 85.7 | 1547.0 | 1362.0 | 1924.0 |
| 11ax80MIMO | 5530 | Type5 | 13 | 7 | 362696.0 | 10 | 3 | 98.4 | 1873.0 | 1550.0 | 1249.0 |
| 11ax80MIMO | 5530 | Type5 | 13 | 8 | 604342.0 | 10 | 3 | 86.4 | 1779.0 | 1439.0 | 1046.0 |
| 11ax80MIMO | 5530 | Type5 | 13 | 9 | 846453.0 | 10 | 3 | 93.6 | 1059.0 | 1031.0 | 1452.0 |
| 11ax80MIMO | 5530 | Type5 | 13 | 10 | 91871.0 | 10 | 1 | 63.3 | 1328.0 | --- | --- |
| 11ax80MIMO | 5530 | Type5 | 13 | 11 | 333050.0 | 10 | 3 | 92.4 | 1412.0 | 1673.0 | 1322.0 |
| 11ax160MIMO | 5570 | Type5 | 13 | 0 | 664275.0 | 10 | 2 | 75.3 | 1994.0 | 1612.0 | --- |
| 11ax160MIMO | 5570 | Type5 | 13 | 1 | 907886.0 | 10 | 1 | 56.3 | 1456.0 | --- | --- |
| 11ax160MIMO | 5570 | Type5 | 13 | 2 | 151316.0 | 10 | 2 | 67.7 | 1617.0 | 1185.0 | --- |
| 11ax160MIMO | 5570 | Type5 | 13 | 3 | 393746.0 | 10 | 1 | 55.6 | 1337.0 | --- | --- |
| 11ax160MIMO | 5570 | Type5 | 13 | 4 | 635093.0 | 10 | 2 | 75.2 | 1421.0 | 1267.0 | --- |
| 11ax160MIMO | 5570 | Type5 | 13 | 5 | 876993.0 | 10 | 2 | 76.3 | 1359.0 | 1305.0 | --- |
| 11ax160MIMO | 5570 | Type5 | 13 | 6 | 121278.0 | 10 | 3 | 85.7 | 1547.0 | 1362.0 | 1924.0 |
| 11ax160MIMO | 5570 | Type5 | 13 | 7 | 362696.0 | 10 | 3 | 98.4 | 1873.0 | 1550.0 | 1249.0 |
| 11ax160MIMO | 5570 | Type5 | 13 | 8 | 604342.0 | 10 | 3 | 86.4 | 1779.0 | 1439.0 | 1046.0 |
| 11ax160MIMO | 5570 | Type5 | 13 | 9 | 846453.0 | 10 | 3 | 93.6 | 1059.0 | 1031.0 | 1452.0 |
| 11ax160MIMO | 5570 | Type5 | 13 | 10 | 91871.0 | 10 | 1 | 63.3 | 1328.0 | --- | --- |
| 11ax160MIMO | 5570 | Type5 | 13 | 11 | 333050.0 | 10 | 3 | 92.4 | 1412.0 | 1673.0 | 1322.0 |



Unless otherwise agreed in writing, this document is issued by the Company subject to its General Conditions of Service printed overleaf, available on request or accessible at <http://www.sgs.com/en/Terms-and-Conditions.aspx> and, for electronic format documents, subject to Terms and Conditions for Electronic Documents at <http://www.sgs.com/en/Terms-and-Conditions/Terms-e-Documents.aspx>. Attention is drawn to the limitation of liability, indemnification and jurisdiction issues defined therein. Any holder of this document is advised that information contained hereon reflects the Company's findings only and within the limits of Client's instructions, if any. The Company's sole responsibility is to its Client and this document does not exonerate parties to a transaction from exercising all their rights and obligations under the transaction documents. This document cannot be reproduced except in full, without prior written approval of the Company. Any unauthorized alteration, forgery or falsification of the content or appearance of this document is unlawful and offenders may be prosecuted to the fullest extent of the law. Unless otherwise stated the results shown in this test report refer only to the sample(s) tested and such sample(s) are retained for 30 days only.

Attention: To check the authenticity of testing /inspection report & certificate, please contact us at telephone: (86-755) 8307 1443, or email: QN.Doccheck@sgs.com

SGS-CSTC Standards Technical Services (Suzhou) Co., Ltd.
Wireless Laboratory

South of No. 6 Plant, No. 1, Runsheng Road, Suzhou Industrial Park, Suzhou Area, China (Jiangsu) Pilot Free Trade Zone 215000 t (86-512) 62992980 www.sgsgroup.com.cn
中国·苏州·中国(江苏)自由贸易试验区苏州片区苏州工业园区润胜路1号的6号厂房南楼 邮编: 215000 t (86-512) 62992980 sgs.china@sgs.com

| @FCC_RLAN_DFS_SPC_Radar_T5_SP2_Tr14@ | | | | | | | | | | | |
|--------------------------------------|---------|------------|----------|----------|-------------------|-------------------|------------------|------------------|-----------|-----------|-----------|
| TestMode | Channel | Radar Type | Trial ID | Burst ID | Burst Offset (μs) | Chirp Width (MHz) | Number Of Pulses | Pulse Width (μs) | PRI1 (μs) | PRI2 (μs) | PRI3 (μs) |
| 11ax20MIMO | 5500 | Type5 | 14 | 0 | 361323.0 | 18 | 3 | 93.3 | 1983.0 | 1912.0 | 1535.0 |
| 11ax20MIMO | 5500 | Type5 | 14 | 1 | 515261.0 | 18 | 2 | 69.1 | 1102.0 | 1794.0 | --- |
| 11ax20MIMO | 5500 | Type5 | 14 | 2 | 39025.0 | 18 | 3 | 86.9 | 1044.0 | 1152.0 | 1148.0 |
| 11ax20MIMO | 5500 | Type5 | 14 | 3 | 190900.0 | 18 | 3 | 84.9 | 1894.0 | 1948.0 | 1118.0 |
| 11ax20MIMO | 5500 | Type5 | 14 | 4 | 343941.0 | 18 | 2 | 72.3 | 1094.0 | 1916.0 | --- |
| 11ax20MIMO | 5500 | Type5 | 14 | 5 | 497624.0 | 18 | 1 | 51.7 | 1447.0 | --- | --- |
| 11ax20MIMO | 5500 | Type5 | 14 | 6 | 20319.0 | 18 | 1 | 58.3 | 1429.0 | --- | --- |
| 11ax20MIMO | 5500 | Type5 | 14 | 7 | 172999.0 | 18 | 1 | 60.8 | 1979.0 | --- | --- |
| 11ax20MIMO | 5500 | Type5 | 14 | 8 | 325872.0 | 18 | 1 | 57.1 | 1641.0 | --- | --- |
| 11ax20MIMO | 5500 | Type5 | 14 | 9 | 475841.0 | 18 | 3 | 88.9 | 1886.0 | 1964.0 | 1489.0 |
| 11ax20MIMO | 5500 | Type5 | 14 | 10 | 1489.0 | 18 | 2 | 72.0 | 1909.0 | 1297.0 | --- |
| 11ax20MIMO | 5500 | Type5 | 14 | 11 | 153647.0 | 18 | 3 | 90.9 | 1261.0 | 1566.0 | 1370.0 |
| 11ax20MIMO | 5500 | Type5 | 14 | 12 | 307096.0 | 18 | 1 | 59.8 | 1552.0 | --- | --- |
| 11ax20MIMO | 5500 | Type5 | 14 | 13 | 458804.0 | 18 | 2 | 70.0 | 1759.0 | 1291.0 | --- |
| 11ax20MIMO | 5500 | Type5 | 14 | 14 | 610798.0 | 18 | 2 | 67.2 | 1625.0 | 1881.0 | --- |
| 11ax20MIMO | 5500 | Type5 | 14 | 15 | 134759.0 | 18 | 3 | 91.2 | 1382.0 | 1832.0 | 1661.0 |
| 11ax20MIMO | 5500 | Type5 | 14 | 16 | 288306.0 | 18 | 1 | 56.5 | 1483.0 | --- | --- |
| 11ax20MIMO | 5500 | Type5 | 14 | 17 | 441296.0 | 18 | 1 | 51.2 | 1237.0 | --- | --- |
| 11ax20MIMO | 5500 | Type5 | 14 | 18 | 592780.0 | 18 | 2 | 74.1 | 1471.0 | 1245.0 | --- |
| 11ax40MIMO | 5510 | Type5 | 14 | 0 | 361323.0 | 18 | 3 | 93.3 | 1983.0 | 1912.0 | 1535.0 |
| 11ax40MIMO | 5510 | Type5 | 14 | 1 | 515261.0 | 18 | 2 | 69.1 | 1102.0 | 1794.0 | --- |
| 11ax40MIMO | 5510 | Type5 | 14 | 2 | 39025.0 | 18 | 3 | 86.9 | 1044.0 | 1152.0 | 1148.0 |
| 11ax40MIMO | 5510 | Type5 | 14 | 3 | 190900.0 | 18 | 3 | 84.9 | 1894.0 | 1948.0 | 1118.0 |
| 11ax40MIMO | 5510 | Type5 | 14 | 4 | 343941.0 | 18 | 2 | 72.3 | 1094.0 | 1916.0 | --- |
| 11ax40MIMO | 5510 | Type5 | 14 | 5 | 497624.0 | 18 | 1 | 51.7 | 1447.0 | --- | --- |
| 11ax40MIMO | 5510 | Type5 | 14 | 6 | 20319.0 | 18 | 1 | 58.3 | 1429.0 | --- | --- |
| 11ax40MIMO | 5510 | Type5 | 14 | 7 | 172999.0 | 18 | 1 | 60.8 | 1979.0 | --- | --- |
| 11ax40MIMO | 5510 | Type5 | 14 | 8 | 325872.0 | 18 | 1 | 57.1 | 1641.0 | --- | --- |
| 11ax40MIMO | 5510 | Type5 | 14 | 9 | 475841.0 | 18 | 3 | 88.9 | 1886.0 | 1964.0 | 1489.0 |
| 11ax40MIMO | 5510 | Type5 | 14 | 10 | 1489.0 | 18 | 2 | 72.0 | 1909.0 | 1297.0 | --- |
| 11ax40MIMO | 5510 | Type5 | 14 | 11 | 153647.0 | 18 | 3 | 90.9 | 1261.0 | 1566.0 | 1370.0 |
| 11ax40MIMO | 5510 | Type5 | 14 | 12 | 307096.0 | 18 | 1 | 59.8 | 1552.0 | --- | --- |
| 11ax40MIMO | 5510 | Type5 | 14 | 13 | 458804.0 | 18 | 2 | 70.0 | 1759.0 | 1291.0 | --- |
| 11ax40MIMO | 5510 | Type5 | 14 | 14 | 610798.0 | 18 | 2 | 67.2 | 1625.0 | 1881.0 | --- |
| 11ax40MIMO | 5510 | Type5 | 14 | 15 | 134759.0 | 18 | 3 | 91.2 | 1382.0 | 1832.0 | 1661.0 |
| 11ax40MIMO | 5510 | Type5 | 14 | 16 | 288306.0 | 18 | 1 | 56.5 | 1483.0 | --- | --- |
| 11ax40MIMO | 5510 | Type5 | 14 | 17 | 441296.0 | 18 | 1 | 51.2 | 1237.0 | --- | --- |
| 11ax40MIMO | 5510 | Type5 | 14 | 18 | 592780.0 | 18 | 2 | 74.1 | 1471.0 | 1245.0 | --- |
| 11ax80MIMO | 5530 | Type5 | 14 | 0 | 361323.0 | 18 | 3 | 93.3 | 1983.0 | 1912.0 | 1535.0 |
| 11ax80MIMO | 5530 | Type5 | 14 | 1 | 515261.0 | 18 | 2 | 69.1 | 1102.0 | 1794.0 | --- |
| 11ax80MIMO | 5530 | Type5 | 14 | 2 | 39025.0 | 18 | 3 | 86.9 | 1044.0 | 1152.0 | 1148.0 |
| 11ax80MIMO | 5530 | Type5 | 14 | 3 | 190900.0 | 18 | 3 | 84.9 | 1894.0 | 1948.0 | 1118.0 |
| 11ax80MIMO | 5530 | Type5 | 14 | 4 | 343941.0 | 18 | 2 | 72.3 | 1094.0 | 1916.0 | --- |
| 11ax80MIMO | 5530 | Type5 | 14 | 5 | 497624.0 | 18 | 1 | 51.7 | 1447.0 | --- | --- |
| 11ax80MIMO | 5530 | Type5 | 14 | 6 | 20319.0 | 18 | 1 | 58.3 | 1429.0 | --- | --- |
| 11ax80MIMO | 5530 | Type5 | 14 | 7 | 172999.0 | 18 | 1 | 60.8 | 1979.0 | --- | --- |
| 11ax80MIMO | 5530 | Type5 | 14 | 8 | 325872.0 | 18 | 1 | 57.1 | 1641.0 | --- | --- |
| 11ax80MIMO | 5530 | Type5 | 14 | 9 | 475841.0 | 18 | 3 | 88.9 | 1886.0 | 1964.0 | 1489.0 |
| 11ax80MIMO | 5530 | Type5 | 14 | 10 | 1489.0 | 18 | 2 | 72.0 | 1909.0 | 1297.0 | --- |
| 11ax80MIMO | 5530 | Type5 | 14 | 11 | 153647.0 | 18 | 3 | 90.9 | 1261.0 | 1566.0 | 1370.0 |
| 11ax80MIMO | 5530 | Type5 | 14 | 12 | 307096.0 | 18 | 1 | 59.8 | 1552.0 | --- | --- |
| 11ax80MIMO | 5530 | Type5 | 14 | 13 | 458804.0 | 18 | 2 | 70.0 | 1759.0 | 1291.0 | --- |
| 11ax80MIMO | 5530 | Type5 | 14 | 14 | 610798.0 | 18 | 2 | 67.2 | 1625.0 | 1881.0 | --- |
| 11ax80MIMO | 5530 | Type5 | 14 | 15 | 134759.0 | 18 | 3 | 91.2 | 1382.0 | 1832.0 | 1661.0 |
| 11ax80MIMO | 5530 | Type5 | 14 | 16 | 288306.0 | 18 | 1 | 56.5 | 1483.0 | --- | --- |
| 11ax80MIMO | 5530 | Type5 | 14 | 17 | 441296.0 | 18 | 1 | 51.2 | 1237.0 | --- | --- |
| 11ax80MIMO | 5530 | Type5 | 14 | 18 | 592780.0 | 18 | 2 | 74.1 | 1471.0 | 1245.0 | --- |



Unless otherwise agreed in writing, this document is issued by the Company subject to its General Conditions of Service printed overleaf, available on request or accessible at <http://www.sgs.com/en/Terms-and-Conditions.aspx> and, for electronic format documents, subject to Terms and Conditions for Electronic Documents at <http://www.sgs.com/en/Terms-and-Conditions/Terms-e-Documents.aspx>. Attention is drawn to the limitation of liability, indemnification and jurisdiction issues defined therein. Any holder of this document is advised that information contained hereon reflects the Company's findings at the time of its intervention only and within the limits of Client's instructions, if any. The Company's sole responsibility is to its Client and this document does not exonerate parties to a transaction from exercising all their rights and obligations under the transaction documents. This document cannot be reproduced except in full, without prior written approval of the Company. Any unauthorized alteration, forgery or falsification of the content or appearance of this document is unlawful and offenders may be prosecuted to the fullest extent of the law. Unless otherwise stated the results shown in this test report refer only to the sample(s) tested and such sample(s) are retained for 30 days only.

Attention: To check the authenticity of testing/inspection report & certificate, please contact us at telephone: (86-755) 8307 1443, or email: QN.Doccheck@sgs.com
 South of No. 6 Plant, No. 1, Runsheng Road, Suzhou Industrial Park, Suzhou Area, China (Jiangsu) Pilot Free Trade Zone 215000 t (86-512) 62992980 www.sgsgroup.com.cn
 中国·苏州·中国（江苏）自由贸易试验区苏州片区苏州工业园区润胜路1号的6号厂房南楼 邮编：215000 t (86-512) 62992980 sgs.china@sgs.com

| | | | | | | | | | | | |
|-------------|------|-------|----|----|----------|----|---|------|--------|--------|--------|
| 11ax160MIMO | 5570 | Type5 | 14 | 0 | 361323.0 | 18 | 3 | 93.3 | 1983.0 | 1912.0 | 1535.0 |
| 11ax160MIMO | 5570 | Type5 | 14 | 1 | 515261.0 | 18 | 2 | 69.1 | 1102.0 | 1794.0 | --- |
| 11ax160MIMO | 5570 | Type5 | 14 | 2 | 39025.0 | 18 | 3 | 86.9 | 1044.0 | 1152.0 | 1148.0 |
| 11ax160MIMO | 5570 | Type5 | 14 | 3 | 190900.0 | 18 | 3 | 84.9 | 1894.0 | 1948.0 | 1118.0 |
| 11ax160MIMO | 5570 | Type5 | 14 | 4 | 343941.0 | 18 | 2 | 72.3 | 1094.0 | 1916.0 | --- |
| 11ax160MIMO | 5570 | Type5 | 14 | 5 | 497624.0 | 18 | 1 | 51.7 | 1447.0 | --- | --- |
| 11ax160MIMO | 5570 | Type5 | 14 | 6 | 20319.0 | 18 | 1 | 58.3 | 1429.0 | --- | --- |
| 11ax160MIMO | 5570 | Type5 | 14 | 7 | 172999.0 | 18 | 1 | 60.8 | 1979.0 | --- | --- |
| 11ax160MIMO | 5570 | Type5 | 14 | 8 | 325872.0 | 18 | 1 | 57.1 | 1641.0 | --- | --- |
| 11ax160MIMO | 5570 | Type5 | 14 | 9 | 475841.0 | 18 | 3 | 88.9 | 1886.0 | 1964.0 | 1489.0 |
| 11ax160MIMO | 5570 | Type5 | 14 | 10 | 1489.0 | 18 | 2 | 72.0 | 1909.0 | 1297.0 | --- |
| 11ax160MIMO | 5570 | Type5 | 14 | 11 | 153647.0 | 18 | 3 | 90.9 | 1261.0 | 1566.0 | 1370.0 |
| 11ax160MIMO | 5570 | Type5 | 14 | 12 | 307096.0 | 18 | 1 | 59.8 | 1552.0 | --- | --- |
| 11ax160MIMO | 5570 | Type5 | 14 | 13 | 458804.0 | 18 | 2 | 70.0 | 1759.0 | 1291.0 | --- |
| 11ax160MIMO | 5570 | Type5 | 14 | 14 | 610798.0 | 18 | 2 | 67.2 | 1625.0 | 1881.0 | --- |
| 11ax160MIMO | 5570 | Type5 | 14 | 15 | 134759.0 | 18 | 3 | 91.2 | 1382.0 | 1832.0 | 1661.0 |
| 11ax160MIMO | 5570 | Type5 | 14 | 16 | 288306.0 | 18 | 1 | 56.5 | 1483.0 | --- | --- |
| 11ax160MIMO | 5570 | Type5 | 14 | 17 | 441296.0 | 18 | 1 | 51.2 | 1237.0 | --- | --- |
| 11ax160MIMO | 5570 | Type5 | 14 | 18 | 592780.0 | 18 | 2 | 74.1 | 1471.0 | 1245.0 | --- |



Unless otherwise agreed in writing, this document is issued by the Company subject to its General Conditions of Service printed overleaf, available on request or accessible at <http://www.sgs.com/en/Terms-and-Conditions.aspx> and, for electronic format documents, subject to Terms and Conditions for Electronic Documents at <http://www.sgs.com/en/Terms-and-Conditions/Terms-e-Documents.aspx>. Attention is drawn to the limitation of liability, indemnification and jurisdiction issues defined therein. Any holder of this document is advised that information contained hereon reflects the Company's findings at the time of its intervention only and within the limits of Client's instructions, if any. The Company's sole responsibility is to its Client and this document does not exonerate parties to a transaction from exercising all their rights and obligations under the transaction documents. This document cannot be reproduced except in full, without prior written approval of the Company. Any unauthorized alteration, forgery or falsification of the content or appearance of this document is unlawful and offenders may be prosecuted to the fullest extent of the law. Unless otherwise stated the results shown in this test report refer only to the sample(s) tested and such sample(s) are retained for 30 days only.

Attention: To check the authenticity of testing /inspection report & certificate, please contact us at telephone: (86-755) 8307 1443, or email: CN.Doccheck@sgs.com

| @FCC_RLAN_DFS_SPC_Radar_T5_SP2_Tr15@ | | | | | | | | | | | |
|--------------------------------------|---------|------------|----------|----------|-------------------|-------------------|------------------|------------------|-----------|-----------|-----------|
| TestMode | Channel | Radar Type | Trial ID | Burst ID | Burst Offset (μs) | Chirp Width (MHz) | Number Of Pulses | Pulse Width (μs) | PRI1 (μs) | PRI2 (μs) | PRI3 (μs) |
| 11ax20MIMO | 5500 | Type5 | 15 | 0 | 158286.0 | 12 | 2 | 76.9 | 1110.0 | 1140.0 | --- |
| 11ax20MIMO | 5500 | Type5 | 15 | 1 | 366024.0 | 12 | 1 | 50.2 | 1316.0 | --- | --- |
| 11ax20MIMO | 5500 | Type5 | 15 | 2 | 573452.0 | 12 | 1 | 62.9 | 1520.0 | --- | --- |
| 11ax20MIMO | 5500 | Type5 | 15 | 3 | 780619.0 | 12 | 1 | 64.7 | 1902.0 | --- | --- |
| 11ax20MIMO | 5500 | Type5 | 15 | 4 | 132455.0 | 12 | 3 | 83.8 | 1410.0 | 1097.0 | 1621.0 |
| 11ax20MIMO | 5500 | Type5 | 15 | 5 | 340207.0 | 12 | 1 | 65.4 | 1944.0 | --- | --- |
| 11ax20MIMO | 5500 | Type5 | 15 | 6 | 548208.0 | 12 | 1 | 53.2 | 1024.0 | --- | --- |
| 11ax20MIMO | 5500 | Type5 | 15 | 7 | 755333.0 | 12 | 1 | 51.7 | 1603.0 | --- | --- |
| 11ax20MIMO | 5500 | Type5 | 15 | 8 | 107117.0 | 12 | 2 | 78.7 | 1804.0 | 1168.0 | --- |
| 11ax20MIMO | 5500 | Type5 | 15 | 9 | 314500.0 | 12 | 2 | 72.4 | 1030.0 | 1343.0 | --- |
| 11ax20MIMO | 5500 | Type5 | 15 | 10 | 522447.0 | 12 | 1 | 53.8 | 1327.0 | --- | --- |
| 11ax20MIMO | 5500 | Type5 | 15 | 11 | 728517.0 | 12 | 2 | 73.6 | 1524.0 | 1553.0 | --- |
| 11ax20MIMO | 5500 | Type5 | 15 | 12 | 81611.0 | 12 | 2 | 66.7 | 1722.0 | 1122.0 | --- |
| 11ax20MIMO | 5500 | Type5 | 15 | 13 | 288948.0 | 12 | 2 | 82.5 | 1404.0 | 1019.0 | --- |
| 11ax40MIMO | 5510 | Type5 | 15 | 0 | 158286.0 | 12 | 2 | 76.9 | 1110.0 | 1140.0 | --- |
| 11ax40MIMO | 5510 | Type5 | 15 | 1 | 366024.0 | 12 | 1 | 50.2 | 1316.0 | --- | --- |
| 11ax40MIMO | 5510 | Type5 | 15 | 2 | 573452.0 | 12 | 1 | 62.9 | 1520.0 | --- | --- |
| 11ax40MIMO | 5510 | Type5 | 15 | 3 | 780619.0 | 12 | 1 | 64.7 | 1902.0 | --- | --- |
| 11ax40MIMO | 5510 | Type5 | 15 | 4 | 132455.0 | 12 | 3 | 83.8 | 1410.0 | 1097.0 | 1621.0 |
| 11ax40MIMO | 5510 | Type5 | 15 | 5 | 340207.0 | 12 | 1 | 65.4 | 1944.0 | --- | --- |
| 11ax40MIMO | 5510 | Type5 | 15 | 6 | 548208.0 | 12 | 1 | 53.2 | 1024.0 | --- | --- |
| 11ax40MIMO | 5510 | Type5 | 15 | 7 | 755333.0 | 12 | 1 | 51.7 | 1603.0 | --- | --- |
| 11ax40MIMO | 5510 | Type5 | 15 | 8 | 107117.0 | 12 | 2 | 78.7 | 1804.0 | 1168.0 | --- |
| 11ax40MIMO | 5510 | Type5 | 15 | 9 | 314500.0 | 12 | 2 | 72.4 | 1030.0 | 1343.0 | --- |
| 11ax40MIMO | 5510 | Type5 | 15 | 10 | 522447.0 | 12 | 1 | 53.8 | 1327.0 | --- | --- |
| 11ax40MIMO | 5510 | Type5 | 15 | 11 | 728517.0 | 12 | 2 | 73.6 | 1524.0 | 1553.0 | --- |
| 11ax40MIMO | 5510 | Type5 | 15 | 12 | 81611.0 | 12 | 2 | 66.7 | 1722.0 | 1122.0 | --- |
| 11ax40MIMO | 5510 | Type5 | 15 | 13 | 288948.0 | 12 | 2 | 82.5 | 1404.0 | 1019.0 | --- |
| 11ax80MIMO | 5530 | Type5 | 15 | 0 | 158286.0 | 12 | 2 | 76.9 | 1110.0 | 1140.0 | --- |
| 11ax80MIMO | 5530 | Type5 | 15 | 1 | 366024.0 | 12 | 1 | 50.2 | 1316.0 | --- | --- |
| 11ax80MIMO | 5530 | Type5 | 15 | 2 | 573452.0 | 12 | 1 | 62.9 | 1520.0 | --- | --- |
| 11ax80MIMO | 5530 | Type5 | 15 | 3 | 780619.0 | 12 | 1 | 64.7 | 1902.0 | --- | --- |
| 11ax80MIMO | 5530 | Type5 | 15 | 4 | 132455.0 | 12 | 3 | 83.8 | 1410.0 | 1097.0 | 1621.0 |
| 11ax80MIMO | 5530 | Type5 | 15 | 5 | 340207.0 | 12 | 1 | 65.4 | 1944.0 | --- | --- |
| 11ax80MIMO | 5530 | Type5 | 15 | 6 | 548208.0 | 12 | 1 | 53.2 | 1024.0 | --- | --- |
| 11ax80MIMO | 5530 | Type5 | 15 | 7 | 755333.0 | 12 | 1 | 51.7 | 1603.0 | --- | --- |
| 11ax80MIMO | 5530 | Type5 | 15 | 8 | 107117.0 | 12 | 2 | 78.7 | 1804.0 | 1168.0 | --- |
| 11ax80MIMO | 5530 | Type5 | 15 | 9 | 314500.0 | 12 | 2 | 72.4 | 1030.0 | 1343.0 | --- |
| 11ax80MIMO | 5530 | Type5 | 15 | 10 | 522447.0 | 12 | 1 | 53.8 | 1327.0 | --- | --- |
| 11ax80MIMO | 5530 | Type5 | 15 | 11 | 728517.0 | 12 | 2 | 73.6 | 1524.0 | 1553.0 | --- |
| 11ax80MIMO | 5530 | Type5 | 15 | 12 | 81611.0 | 12 | 2 | 66.7 | 1722.0 | 1122.0 | --- |
| 11ax80MIMO | 5530 | Type5 | 15 | 13 | 288948.0 | 12 | 2 | 82.5 | 1404.0 | 1019.0 | --- |
| 11ax160MIMO | 5570 | Type5 | 15 | 0 | 158286.0 | 12 | 2 | 76.9 | 1110.0 | 1140.0 | --- |
| 11ax160MIMO | 5570 | Type5 | 15 | 1 | 366024.0 | 12 | 1 | 50.2 | 1316.0 | --- | --- |
| 11ax160MIMO | 5570 | Type5 | 15 | 2 | 573452.0 | 12 | 1 | 62.9 | 1520.0 | --- | --- |
| 11ax160MIMO | 5570 | Type5 | 15 | 3 | 780619.0 | 12 | 1 | 64.7 | 1902.0 | --- | --- |
| 11ax160MIMO | 5570 | Type5 | 15 | 4 | 132455.0 | 12 | 3 | 83.8 | 1410.0 | 1097.0 | 1621.0 |
| 11ax160MIMO | 5570 | Type5 | 15 | 5 | 340207.0 | 12 | 1 | 65.4 | 1944.0 | --- | --- |
| 11ax160MIMO | 5570 | Type5 | 15 | 6 | 548208.0 | 12 | 1 | 53.2 | 1024.0 | --- | --- |
| 11ax160MIMO | 5570 | Type5 | 15 | 7 | 755333.0 | 12 | 1 | 51.7 | 1603.0 | --- | --- |
| 11ax160MIMO | 5570 | Type5 | 15 | 8 | 107117.0 | 12 | 2 | 78.7 | 1804.0 | 1168.0 | --- |
| 11ax160MIMO | 5570 | Type5 | 15 | 9 | 314500.0 | 12 | 2 | 72.4 | 1030.0 | 1343.0 | --- |
| 11ax160MIMO | 5570 | Type5 | 15 | 10 | 522447.0 | 12 | 1 | 53.8 | 1327.0 | --- | --- |
| 11ax160MIMO | 5570 | Type5 | 15 | 11 | 728517.0 | 12 | 2 | 73.6 | 1524.0 | 1553.0 | --- |
| 11ax160MIMO | 5570 | Type5 | 15 | 12 | 81611.0 | 12 | 2 | 66.7 | 1722.0 | 1122.0 | --- |
| 11ax160MIMO | 5570 | Type5 | 15 | 13 | 288948.0 | 12 | 2 | 82.5 | 1404.0 | 1019.0 | --- |



Unless otherwise agreed in writing, this document is issued by the Company subject to its General Conditions of Service printed overleaf, available on request or accessible at <http://www.sgs.com/en/Terms-and-Conditions.aspx> and, for electronic format documents, subject to Terms and Conditions for Electronic Documents at <http://www.sgs.com/en/Terms-and-Conditions/Terms-e-Documents.aspx>. Attention is drawn to the limitation of liability, indemnification and jurisdiction issues defined therein. Any holder of this document is advised that information contained hereon reflects the Company's findings at the time of its intervention only and within the limits of Client's instructions, if any. The Company's sole responsibility is to its Client and this document does not exonerate parties to a transaction from exercising all their rights and obligations under the transaction documents. This document cannot be reproduced except in full, without prior written approval of the Company. Any unauthorized alteration, forgery or falsification of the content or appearance of this document is unlawful and offenders may be prosecuted to the fullest extent of the law. Unless otherwise stated the results shown in this test report refer only to the sample(s) tested and such sample(s) are retained for 30 days only.

Attention: To check the authenticity of testing/inspection report & certificate, please contact us at telephone: (86-755) 8307 1443, or email: CN.Doccheck@sgs.com

South of No. 6 Plant, No. 1, Runsheng Road, Suzhou Industrial Park, Suzhou Area, China (Jiangsu) Pilot Free Trade Zone 215000 t (86-512) 62992980 www.sgsgroup.com.cn
 中国·苏州·中国（江苏）自由贸易试验区苏州片区苏州工业园区润胜路1号的6号厂房南楼 邮编：215000 t (86-512) 62992980 sgs.china@sgs.com

| @FCC_RLAN_DFS_SPC_Radar_T5_SP2_Tr16@ | | | | | | | | | | | |
|--------------------------------------|---------|------------|----------|----------|-------------------|-------------------|------------------|------------------|-----------|-----------|-----------|
| TestMode | Channel | Radar Type | Trial ID | Burst ID | Burst Offset (µs) | Chirp Width (MHz) | Number Of Pulses | Pulse Width (µs) | PRI1 (µs) | PRI2 (µs) | PRI3 (µs) |
| 11ax20MIMO | 5500 | Type5 | 16 | 0 | 345766.0 | 20 | 3 | 87.6 | 1565.0 | 1055.0 | 1840.0 |
| 11ax20MIMO | 5500 | Type5 | 16 | 1 | 490019.0 | 20 | 3 | 85.2 | 1735.0 | 1541.0 | 1408.0 |
| 11ax20MIMO | 5500 | Type5 | 16 | 2 | 39073.0 | 20 | 3 | 84.8 | 1534.0 | 1889.0 | 1463.0 |
| 11ax20MIMO | 5500 | Type5 | 16 | 3 | 183923.0 | 20 | 2 | 77.9 | 1749.0 | 1460.0 | --- |
| 11ax20MIMO | 5500 | Type5 | 16 | 4 | 328777.0 | 20 | 2 | 76.5 | 1518.0 | 1485.0 | --- |
| 11ax20MIMO | 5500 | Type5 | 16 | 5 | 474728.0 | 20 | 1 | 60.9 | 1540.0 | --- | --- |
| 11ax20MIMO | 5500 | Type5 | 16 | 6 | 21394.0 | 20 | 2 | 83.0 | 1080.0 | 1010.0 | --- |
| 11ax20MIMO | 5500 | Type5 | 16 | 7 | 165992.0 | 20 | 2 | 80.4 | 1824.0 | 1752.0 | --- |
| 11ax20MIMO | 5500 | Type5 | 16 | 8 | 310973.0 | 20 | 2 | 67.5 | 1764.0 | 1181.0 | --- |
| 11ax20MIMO | 5500 | Type5 | 16 | 9 | 456884.0 | 20 | 1 | 62.1 | 1495.0 | --- | --- |
| 11ax20MIMO | 5500 | Type5 | 16 | 10 | 3515.0 | 20 | 3 | 86.4 | 1773.0 | 1966.0 | 1263.0 |
| 11ax20MIMO | 5500 | Type5 | 16 | 11 | 147928.0 | 20 | 3 | 84.3 | 1593.0 | 1188.0 | 1788.0 |
| 11ax20MIMO | 5500 | Type5 | 16 | 12 | 293225.0 | 20 | 2 | 76.9 | 1226.0 | 1537.0 | --- |
| 11ax20MIMO | 5500 | Type5 | 16 | 13 | 436922.0 | 20 | 3 | 95.8 | 1192.0 | 1298.0 | 1844.0 |
| 11ax20MIMO | 5500 | Type5 | 16 | 14 | 584015.0 | 20 | 1 | 55.2 | 1644.0 | --- | --- |
| 11ax20MIMO | 5500 | Type5 | 16 | 15 | 130832.0 | 20 | 1 | 59.0 | 1402.0 | --- | --- |
| 11ax20MIMO | 5500 | Type5 | 16 | 16 | 274684.0 | 20 | 3 | 94.5 | 1296.0 | 1700.0 | 1283.0 |
| 11ax20MIMO | 5500 | Type5 | 16 | 17 | 418579.0 | 20 | 3 | 91.9 | 1970.0 | 1978.0 | 1165.0 |
| 11ax20MIMO | 5500 | Type5 | 16 | 18 | 563464.0 | 20 | 3 | 85.2 | 1732.0 | 1551.0 | 1189.0 |
| 11ax20MIMO | 5500 | Type5 | 16 | 19 | 112787.0 | 20 | 2 | 69.5 | 1038.0 | 1224.0 | --- |
| 11ax40MIMO | 5510 | Type5 | 16 | 0 | 345766.0 | 20 | 3 | 87.6 | 1565.0 | 1055.0 | 1840.0 |
| 11ax40MIMO | 5510 | Type5 | 16 | 1 | 490019.0 | 20 | 3 | 85.2 | 1735.0 | 1541.0 | 1408.0 |
| 11ax40MIMO | 5510 | Type5 | 16 | 2 | 39073.0 | 20 | 3 | 84.8 | 1534.0 | 1889.0 | 1463.0 |
| 11ax40MIMO | 5510 | Type5 | 16 | 3 | 183923.0 | 20 | 2 | 77.9 | 1749.0 | 1460.0 | --- |
| 11ax40MIMO | 5510 | Type5 | 16 | 4 | 328777.0 | 20 | 2 | 76.5 | 1518.0 | 1485.0 | --- |
| 11ax40MIMO | 5510 | Type5 | 16 | 5 | 474728.0 | 20 | 1 | 60.9 | 1540.0 | --- | --- |
| 11ax40MIMO | 5510 | Type5 | 16 | 6 | 21394.0 | 20 | 2 | 83.0 | 1080.0 | 1010.0 | --- |
| 11ax40MIMO | 5510 | Type5 | 16 | 7 | 165992.0 | 20 | 2 | 80.4 | 1824.0 | 1752.0 | --- |
| 11ax40MIMO | 5510 | Type5 | 16 | 8 | 310973.0 | 20 | 2 | 67.5 | 1764.0 | 1181.0 | --- |
| 11ax40MIMO | 5510 | Type5 | 16 | 9 | 456884.0 | 20 | 1 | 62.1 | 1495.0 | --- | --- |
| 11ax40MIMO | 5510 | Type5 | 16 | 10 | 3515.0 | 20 | 3 | 86.4 | 1773.0 | 1966.0 | 1263.0 |
| 11ax40MIMO | 5510 | Type5 | 16 | 11 | 147928.0 | 20 | 3 | 84.3 | 1593.0 | 1188.0 | 1788.0 |
| 11ax40MIMO | 5510 | Type5 | 16 | 12 | 293225.0 | 20 | 2 | 76.9 | 1226.0 | 1537.0 | --- |
| 11ax40MIMO | 5510 | Type5 | 16 | 13 | 436922.0 | 20 | 3 | 95.8 | 1192.0 | 1298.0 | 1844.0 |
| 11ax40MIMO | 5510 | Type5 | 16 | 14 | 584015.0 | 20 | 1 | 55.2 | 1644.0 | --- | --- |
| 11ax40MIMO | 5510 | Type5 | 16 | 15 | 130832.0 | 20 | 1 | 59.0 | 1402.0 | --- | --- |
| 11ax40MIMO | 5510 | Type5 | 16 | 16 | 274684.0 | 20 | 3 | 94.5 | 1296.0 | 1700.0 | 1283.0 |
| 11ax40MIMO | 5510 | Type5 | 16 | 17 | 418579.0 | 20 | 3 | 91.9 | 1970.0 | 1978.0 | 1165.0 |
| 11ax40MIMO | 5510 | Type5 | 16 | 18 | 563464.0 | 20 | 3 | 85.2 | 1732.0 | 1551.0 | 1189.0 |
| 11ax40MIMO | 5510 | Type5 | 16 | 19 | 112787.0 | 20 | 2 | 69.5 | 1038.0 | 1224.0 | --- |
| 11ax80MIMO | 5530 | Type5 | 16 | 0 | 345766.0 | 20 | 3 | 87.6 | 1565.0 | 1055.0 | 1840.0 |
| 11ax80MIMO | 5530 | Type5 | 16 | 1 | 490019.0 | 20 | 3 | 85.2 | 1735.0 | 1541.0 | 1408.0 |
| 11ax80MIMO | 5530 | Type5 | 16 | 2 | 39073.0 | 20 | 3 | 84.8 | 1534.0 | 1889.0 | 1463.0 |
| 11ax80MIMO | 5530 | Type5 | 16 | 3 | 183923.0 | 20 | 2 | 77.9 | 1749.0 | 1460.0 | --- |
| 11ax80MIMO | 5530 | Type5 | 16 | 4 | 328777.0 | 20 | 2 | 76.5 | 1518.0 | 1485.0 | --- |
| 11ax80MIMO | 5530 | Type5 | 16 | 5 | 474728.0 | 20 | 1 | 60.9 | 1540.0 | --- | --- |
| 11ax80MIMO | 5530 | Type5 | 16 | 6 | 21394.0 | 20 | 2 | 83.0 | 1080.0 | 1010.0 | --- |
| 11ax80MIMO | 5530 | Type5 | 16 | 7 | 165992.0 | 20 | 2 | 80.4 | 1824.0 | 1752.0 | --- |
| 11ax80MIMO | 5530 | Type5 | 16 | 8 | 310973.0 | 20 | 2 | 67.5 | 1764.0 | 1181.0 | --- |
| 11ax80MIMO | 5530 | Type5 | 16 | 9 | 456884.0 | 20 | 1 | 62.1 | 1495.0 | --- | --- |
| 11ax80MIMO | 5530 | Type5 | 16 | 10 | 3515.0 | 20 | 3 | 86.4 | 1773.0 | 1966.0 | 1263.0 |
| 11ax80MIMO | 5530 | Type5 | 16 | 11 | 147928.0 | 20 | 3 | 84.3 | 1593.0 | 1188.0 | 1788.0 |
| 11ax80MIMO | 5530 | Type5 | 16 | 12 | 293225.0 | 20 | 2 | 76.9 | 1226.0 | 1537.0 | --- |
| 11ax80MIMO | 5530 | Type5 | 16 | 13 | 436922.0 | 20 | 3 | 95.8 | 1192.0 | 1298.0 | 1844.0 |
| 11ax80MIMO | 5530 | Type5 | 16 | 14 | 584015.0 | 20 | 1 | 55.2 | 1644.0 | --- | --- |
| 11ax80MIMO | 5530 | Type5 | 16 | 15 | 130832.0 | 20 | 1 | 59.0 | 1402.0 | --- | --- |



Unless otherwise agreed in writing, this document is issued by the Company subject to its General Conditions of Service printed overleaf, available on request or accessible at <http://www.sgs.com/en/Terms-and-Conditions.aspx> and, for electronic format documents, subject to Terms and Conditions for Electronic Documents at <http://www.sgs.com/en/Terms-and-Conditions/Terms-e-Documents.aspx>. Attention is drawn to the limitation of liability, indemnification and jurisdiction issues defined therein. Any holder of this document is advised that information contained herein reflects the Company's findings at the time of its intervention only and within the limits of Client's instructions, if any. The Company's sole responsibility is to its Client and this document does not exonerate parties to a transaction from exercising all their rights and obligations under the transaction documents. This document cannot be reproduced except in full, without prior written approval of the Company. Any unauthorized alteration, forgery or falsification of the content or appearance of this document is unlawful and offenders may be prosecuted to the fullest extent of the law. Unless otherwise stated the results shown in this test report refer only to the sample(s) tested and such sample(s) are retained for 30 days only.

Attention: To check the authenticity of testing/inspection report & certificate, please contact us at telephone: (86-755) 8307 1443, or email: QN.Doccheck@sgs.com

South of No. 6 Plant, No. 1, Runsheng Road, Suzhou Industrial Park, Suzhou Area, China (Jiangsu) Pilot Free Trade Zone 215000 t (86-512) 62992980 www.sgs.com.cn
 中国·苏州·中国（江苏）自由贸易试验区苏州片区苏州工业园区润胜路1号的6号厂房南座 邮编：215000 t (86-512) 62992980 sgs.china@sgs.com

| | | | | | | | | | | | |
|-------------|------|-------|----|----|----------|----|---|------|--------|--------|--------|
| 11ax80MIMO | 5530 | Type5 | 16 | 16 | 274684.0 | 20 | 3 | 94.5 | 1296.0 | 1700.0 | 1283.0 |
| 11ax80MIMO | 5530 | Type5 | 16 | 17 | 418579.0 | 20 | 3 | 91.9 | 1970.0 | 1978.0 | 1165.0 |
| 11ax80MIMO | 5530 | Type5 | 16 | 18 | 563464.0 | 20 | 3 | 85.2 | 1732.0 | 1551.0 | 1189.0 |
| 11ax80MIMO | 5530 | Type5 | 16 | 19 | 112787.0 | 20 | 2 | 69.5 | 1038.0 | 1224.0 | --- |
| 11ax160MIMO | 5570 | Type5 | 16 | 0 | 345766.0 | 20 | 3 | 87.6 | 1565.0 | 1055.0 | 1840.0 |
| 11ax160MIMO | 5570 | Type5 | 16 | 1 | 490019.0 | 20 | 3 | 85.2 | 1735.0 | 1541.0 | 1408.0 |
| 11ax160MIMO | 5570 | Type5 | 16 | 2 | 39073.0 | 20 | 3 | 84.8 | 1534.0 | 1889.0 | 1463.0 |
| 11ax160MIMO | 5570 | Type5 | 16 | 3 | 183923.0 | 20 | 2 | 77.9 | 1749.0 | 1460.0 | --- |
| 11ax160MIMO | 5570 | Type5 | 16 | 4 | 328777.0 | 20 | 2 | 76.5 | 1518.0 | 1485.0 | --- |
| 11ax160MIMO | 5570 | Type5 | 16 | 5 | 474728.0 | 20 | 1 | 60.9 | 1540.0 | --- | --- |
| 11ax160MIMO | 5570 | Type5 | 16 | 6 | 21394.0 | 20 | 2 | 83.0 | 1080.0 | 1010.0 | --- |
| 11ax160MIMO | 5570 | Type5 | 16 | 7 | 165992.0 | 20 | 2 | 80.4 | 1824.0 | 1752.0 | --- |
| 11ax160MIMO | 5570 | Type5 | 16 | 8 | 310973.0 | 20 | 2 | 67.5 | 1764.0 | 1181.0 | --- |
| 11ax160MIMO | 5570 | Type5 | 16 | 9 | 456884.0 | 20 | 1 | 62.1 | 1495.0 | --- | --- |
| 11ax160MIMO | 5570 | Type5 | 16 | 10 | 3515.0 | 20 | 3 | 86.4 | 1773.0 | 1966.0 | 1263.0 |
| 11ax160MIMO | 5570 | Type5 | 16 | 11 | 147928.0 | 20 | 3 | 84.3 | 1593.0 | 1188.0 | 1788.0 |
| 11ax160MIMO | 5570 | Type5 | 16 | 12 | 293225.0 | 20 | 2 | 76.9 | 1226.0 | 1537.0 | --- |
| 11ax160MIMO | 5570 | Type5 | 16 | 13 | 436922.0 | 20 | 3 | 95.8 | 1192.0 | 1298.0 | 1844.0 |
| 11ax160MIMO | 5570 | Type5 | 16 | 14 | 584015.0 | 20 | 1 | 55.2 | 1644.0 | --- | --- |
| 11ax160MIMO | 5570 | Type5 | 16 | 15 | 130832.0 | 20 | 1 | 59.0 | 1402.0 | --- | --- |
| 11ax160MIMO | 5570 | Type5 | 16 | 16 | 274684.0 | 20 | 3 | 94.5 | 1296.0 | 1700.0 | 1283.0 |
| 11ax160MIMO | 5570 | Type5 | 16 | 17 | 418579.0 | 20 | 3 | 91.9 | 1970.0 | 1978.0 | 1165.0 |
| 11ax160MIMO | 5570 | Type5 | 16 | 18 | 563464.0 | 20 | 3 | 85.2 | 1732.0 | 1551.0 | 1189.0 |
| 11ax160MIMO | 5570 | Type5 | 16 | 19 | 112787.0 | 20 | 2 | 69.5 | 1038.0 | 1224.0 | --- |



Unless otherwise agreed in writing, this document is issued by the Company subject to its General Conditions of Service printed overleaf, available on request or accessible at <http://www.sgs.com/en/Terms-and-Conditions.aspx> and, for electronic format documents, subject to Terms and Conditions for Electronic Documents at <http://www.sgs.com/en/Terms-and-Conditions/Terms-e-Documents.aspx>. Attention is drawn to the limitation of liability, indemnification and jurisdiction issues defined therein. Any holder of this document is advised that information contained hereon reflects the Company's findings at the time of its intervention only and within the limits of Client's instructions, if any. The Company's sole responsibility is to its Client and this document does not exonerate parties to a transaction from exercising all their rights and obligations under the transaction documents. This document cannot be reproduced except in full, without prior written approval of the Company. Any unauthorized alteration, forgery or falsification of the content or appearance of this document is unlawful and offenders may be prosecuted to the fullest extent of the law. Unless otherwise stated the results shown in this test report refer only to the sample(s) tested and such sample(s) are retained for 30 days only.

Attention: To check the authenticity of testing /inspection report & certificate, please contact us at telephone: (86-755) 8307 1443, or email: CN.Doccheck@sgs.com

| @FCC_RLAN_DFS_SPC_Radar_T5_SP2_Tr17@ | | | | | | | | | | | |
|--------------------------------------|---------|------------|----------|----------|-------------------|-------------------|------------------|------------------|-----------|-----------|-----------|
| TestMode | Channel | Radar Type | Trial ID | Burst ID | Burst Offset (μs) | Chirp Width (MHz) | Number Of Pulses | Pulse Width (μs) | PRI1 (μs) | PRI2 (μs) | PRI3 (μs) |
| 11ax20MIMO | 5500 | Type5 | 17 | 0 | 429224.0 | 10 | 3 | 86.4 | 1259.0 | 1918.0 | 1455.0 |
| 11ax20MIMO | 5500 | Type5 | 17 | 1 | 670241.0 | 10 | 3 | 92.2 | 1598.0 | 1719.0 | 1895.0 |
| 11ax20MIMO | 5500 | Type5 | 17 | 2 | 912880.0 | 10 | 2 | 80.4 | 1816.0 | 1899.0 | --- |
| 11ax20MIMO | 5500 | Type5 | 17 | 3 | 158603.0 | 10 | 1 | 54.3 | 1335.0 | --- | --- |
| 11ax20MIMO | 5500 | Type5 | 17 | 4 | 400824.0 | 10 | 1 | 53.1 | 1303.0 | --- | --- |
| 11ax20MIMO | 5500 | Type5 | 17 | 5 | 641915.0 | 10 | 2 | 69.4 | 1503.0 | 1546.0 | --- |
| 11ax20MIMO | 5500 | Type5 | 17 | 6 | 883823.0 | 10 | 2 | 69.1 | 1279.0 | 1639.0 | --- |
| 11ax20MIMO | 5500 | Type5 | 17 | 7 | 128373.0 | 10 | 3 | 100.0 | 1375.0 | 1438.0 | 1595.0 |
| 11ax20MIMO | 5500 | Type5 | 17 | 8 | 370379.0 | 10 | 2 | 79.6 | 1239.0 | 1705.0 | --- |
| 11ax20MIMO | 5500 | Type5 | 17 | 9 | 611194.0 | 10 | 3 | 88.4 | 1374.0 | 1579.0 | 1623.0 |
| 11ax20MIMO | 5500 | Type5 | 17 | 10 | 855665.0 | 10 | 1 | 53.3 | 1016.0 | --- | --- |
| 11ax20MIMO | 5500 | Type5 | 17 | 11 | 98897.0 | 10 | 1 | 65.3 | 1709.0 | --- | --- |
| 11ax40MIMO | 5510 | Type5 | 17 | 0 | 429224.0 | 10 | 3 | 86.4 | 1259.0 | 1918.0 | 1455.0 |
| 11ax40MIMO | 5510 | Type5 | 17 | 1 | 670241.0 | 10 | 3 | 92.2 | 1598.0 | 1719.0 | 1895.0 |
| 11ax40MIMO | 5510 | Type5 | 17 | 2 | 912880.0 | 10 | 2 | 80.4 | 1816.0 | 1899.0 | --- |
| 11ax40MIMO | 5510 | Type5 | 17 | 3 | 158603.0 | 10 | 1 | 54.3 | 1335.0 | --- | --- |
| 11ax40MIMO | 5510 | Type5 | 17 | 4 | 400824.0 | 10 | 1 | 53.1 | 1303.0 | --- | --- |
| 11ax40MIMO | 5510 | Type5 | 17 | 5 | 641915.0 | 10 | 2 | 69.4 | 1503.0 | 1546.0 | --- |
| 11ax40MIMO | 5510 | Type5 | 17 | 6 | 883823.0 | 10 | 2 | 69.1 | 1279.0 | 1639.0 | --- |
| 11ax40MIMO | 5510 | Type5 | 17 | 7 | 128373.0 | 10 | 3 | 100.0 | 1375.0 | 1438.0 | 1595.0 |
| 11ax40MIMO | 5510 | Type5 | 17 | 8 | 370379.0 | 10 | 2 | 79.6 | 1239.0 | 1705.0 | --- |
| 11ax40MIMO | 5510 | Type5 | 17 | 9 | 611194.0 | 10 | 3 | 88.4 | 1374.0 | 1579.0 | 1623.0 |
| 11ax40MIMO | 5510 | Type5 | 17 | 10 | 855665.0 | 10 | 1 | 53.3 | 1016.0 | --- | --- |
| 11ax40MIMO | 5510 | Type5 | 17 | 11 | 98897.0 | 10 | 1 | 65.3 | 1709.0 | --- | --- |
| 11ax80MIMO | 5530 | Type5 | 17 | 0 | 429224.0 | 10 | 3 | 86.4 | 1259.0 | 1918.0 | 1455.0 |
| 11ax80MIMO | 5530 | Type5 | 17 | 1 | 670241.0 | 10 | 3 | 92.2 | 1598.0 | 1719.0 | 1895.0 |
| 11ax80MIMO | 5530 | Type5 | 17 | 2 | 912880.0 | 10 | 2 | 80.4 | 1816.0 | 1899.0 | --- |
| 11ax80MIMO | 5530 | Type5 | 17 | 3 | 158603.0 | 10 | 1 | 54.3 | 1335.0 | --- | --- |
| 11ax80MIMO | 5530 | Type5 | 17 | 4 | 400824.0 | 10 | 1 | 53.1 | 1303.0 | --- | --- |
| 11ax80MIMO | 5530 | Type5 | 17 | 5 | 641915.0 | 10 | 2 | 69.4 | 1503.0 | 1546.0 | --- |
| 11ax80MIMO | 5530 | Type5 | 17 | 6 | 883823.0 | 10 | 2 | 69.1 | 1279.0 | 1639.0 | --- |
| 11ax80MIMO | 5530 | Type5 | 17 | 7 | 128373.0 | 10 | 3 | 100.0 | 1375.0 | 1438.0 | 1595.0 |
| 11ax80MIMO | 5530 | Type5 | 17 | 8 | 370379.0 | 10 | 2 | 79.6 | 1239.0 | 1705.0 | --- |
| 11ax80MIMO | 5530 | Type5 | 17 | 9 | 611194.0 | 10 | 3 | 88.4 | 1374.0 | 1579.0 | 1623.0 |
| 11ax80MIMO | 5530 | Type5 | 17 | 10 | 855665.0 | 10 | 1 | 53.3 | 1016.0 | --- | --- |
| 11ax80MIMO | 5530 | Type5 | 17 | 11 | 98897.0 | 10 | 1 | 65.3 | 1709.0 | --- | --- |
| 11ax160MIMO | 5570 | Type5 | 17 | 0 | 429224.0 | 10 | 3 | 86.4 | 1259.0 | 1918.0 | 1455.0 |
| 11ax160MIMO | 5570 | Type5 | 17 | 1 | 670241.0 | 10 | 3 | 92.2 | 1598.0 | 1719.0 | 1895.0 |
| 11ax160MIMO | 5570 | Type5 | 17 | 2 | 912880.0 | 10 | 2 | 80.4 | 1816.0 | 1899.0 | --- |
| 11ax160MIMO | 5570 | Type5 | 17 | 3 | 158603.0 | 10 | 1 | 54.3 | 1335.0 | --- | --- |
| 11ax160MIMO | 5570 | Type5 | 17 | 4 | 400824.0 | 10 | 1 | 53.1 | 1303.0 | --- | --- |
| 11ax160MIMO | 5570 | Type5 | 17 | 5 | 641915.0 | 10 | 2 | 69.4 | 1503.0 | 1546.0 | --- |
| 11ax160MIMO | 5570 | Type5 | 17 | 6 | 883823.0 | 10 | 2 | 69.1 | 1279.0 | 1639.0 | --- |
| 11ax160MIMO | 5570 | Type5 | 17 | 7 | 128373.0 | 10 | 3 | 100.0 | 1375.0 | 1438.0 | 1595.0 |
| 11ax160MIMO | 5570 | Type5 | 17 | 8 | 370379.0 | 10 | 2 | 79.6 | 1239.0 | 1705.0 | --- |
| 11ax160MIMO | 5570 | Type5 | 17 | 9 | 611194.0 | 10 | 3 | 88.4 | 1374.0 | 1579.0 | 1623.0 |
| 11ax160MIMO | 5570 | Type5 | 17 | 10 | 855665.0 | 10 | 1 | 53.3 | 1016.0 | --- | --- |
| 11ax160MIMO | 5570 | Type5 | 17 | 11 | 98897.0 | 10 | 1 | 65.3 | 1709.0 | --- | --- |



Unless otherwise agreed in writing, this document is issued by the Company subject to its General Conditions of Service printed overleaf, available on request or accessible at <http://www.sgs.com/en/Terms-and-Conditions.aspx> and, for electronic format documents, subject to Terms and Conditions for Electronic Documents at <http://www.sgs.com/en/Terms-and-Conditions/Terms-e-Documents.aspx>. Attention is drawn to the limitation of liability, indemnification and jurisdiction issues defined therein. Any holder of this document is advised that information contained hereon reflects the Company's findings only and within the limits of Client's instructions, if any. The Company's sole responsibility is to its Client and this document does not exonerate parties to a transaction from exercising all their rights and obligations under the transaction documents. This document cannot be reproduced except in full, without prior written approval of the Company. Any unauthorized alteration, forgery or falsification of the content or appearance of this document is unlawful and offenders may be prosecuted to the fullest extent of the law. Unless otherwise stated the results shown in this test report refer only to the sample(s) tested and such sample(s) are retained for 30 days only.

Attention: To check the authenticity of testing / inspection report & certificate, please contact us at telephone: (86-755) 8307 1443, or email: QN.Doccheck@sgs.com

South of No. 6 Plant, No. 1, Runsheng Road, Suzhou Industrial Park, Suzhou Area, China (Jiangsu) Pilot Free Trade Zone 215000 t (86-512) 62992980 www.sgsqgroup.com.cn
 中国·苏州·中国(江苏)自由贸易试验区苏州片区苏州工业园区润胜路1号的6号厂房南楼 邮编: 215000 t (86-512) 62992980 sgs.china@sgs.com

@FCC_RLAN_DFS_SPC_Radar_T5_SP2_Tr18@

| TestMode | Channel | Radar Type | Trial ID | Burst ID | Burst Offset (µs) | Chirp Width (MHz) | Number Of Pulses | Pulse Width (µs) | PRI1 (µs) | PRI2 (µs) | PRI3 (µs) |
|-------------|---------|------------|----------|----------|-------------------|-------------------|------------------|------------------|-----------|-----------|-----------|
| 11ax20MIMO | 5500 | Type5 | 18 | 0 | 292143.0 | 12 | 1 | 55.3 | 1920.0 | --- | --- |
| 11ax20MIMO | 5500 | Type5 | 18 | 1 | 499633.0 | 12 | 1 | 58.3 | 1797.0 | --- | --- |
| 11ax20MIMO | 5500 | Type5 | 18 | 2 | 706377.0 | 12 | 2 | 72.3 | 1610.0 | 1039.0 | --- |
| 11ax20MIMO | 5500 | Type5 | 18 | 3 | 58989.0 | 12 | 3 | 84.8 | 1131.0 | 1761.0 | 1721.0 |
| 11ax20MIMO | 5500 | Type5 | 18 | 4 | 266161.0 | 12 | 2 | 82.5 | 1875.0 | 1431.0 | --- |
| 11ax20MIMO | 5500 | Type5 | 18 | 5 | 474469.0 | 12 | 1 | 63.3 | 1095.0 | --- | --- |
| 11ax20MIMO | 5500 | Type5 | 18 | 6 | 680544.0 | 12 | 2 | 80.0 | 1119.0 | 1913.0 | --- |
| 11ax20MIMO | 5500 | Type5 | 18 | 7 | 33519.0 | 12 | 3 | 90.3 | 1660.0 | 1853.0 | 1123.0 |
| 11ax20MIMO | 5500 | Type5 | 18 | 8 | 240319.0 | 12 | 3 | 91.1 | 1539.0 | 1783.0 | 1172.0 |
| 11ax20MIMO | 5500 | Type5 | 18 | 9 | 447400.0 | 12 | 3 | 96.6 | 1525.0 | 1036.0 | 1385.0 |
| 11ax20MIMO | 5500 | Type5 | 18 | 10 | 654516.0 | 12 | 2 | 82.7 | 1710.0 | 1990.0 | --- |
| 11ax20MIMO | 5500 | Type5 | 18 | 11 | 8083.0 | 12 | 1 | 50.7 | 1234.0 | --- | --- |
| 11ax20MIMO | 5500 | Type5 | 18 | 12 | 215435.0 | 12 | 2 | 78.4 | 1047.0 | 1109.0 | --- |
| 11ax20MIMO | 5500 | Type5 | 18 | 13 | 421325.0 | 12 | 3 | 99.5 | 1299.0 | 1965.0 | 1869.0 |
| 11ax40MIMO | 5510 | Type5 | 18 | 0 | 292143.0 | 12 | 1 | 55.3 | 1920.0 | --- | --- |
| 11ax40MIMO | 5510 | Type5 | 18 | 1 | 499633.0 | 12 | 1 | 58.3 | 1797.0 | --- | --- |
| 11ax40MIMO | 5510 | Type5 | 18 | 2 | 706377.0 | 12 | 2 | 72.3 | 1610.0 | 1039.0 | --- |
| 11ax40MIMO | 5510 | Type5 | 18 | 3 | 58989.0 | 12 | 3 | 84.8 | 1131.0 | 1761.0 | 1721.0 |
| 11ax40MIMO | 5510 | Type5 | 18 | 4 | 266161.0 | 12 | 2 | 82.5 | 1875.0 | 1431.0 | --- |
| 11ax40MIMO | 5510 | Type5 | 18 | 5 | 474469.0 | 12 | 1 | 63.3 | 1095.0 | --- | --- |
| 11ax40MIMO | 5510 | Type5 | 18 | 6 | 680544.0 | 12 | 2 | 80.0 | 1119.0 | 1913.0 | --- |
| 11ax40MIMO | 5510 | Type5 | 18 | 7 | 33519.0 | 12 | 3 | 90.3 | 1660.0 | 1853.0 | 1123.0 |
| 11ax40MIMO | 5510 | Type5 | 18 | 8 | 240319.0 | 12 | 3 | 91.1 | 1539.0 | 1783.0 | 1172.0 |
| 11ax40MIMO | 5510 | Type5 | 18 | 9 | 447400.0 | 12 | 3 | 96.6 | 1525.0 | 1036.0 | 1385.0 |
| 11ax40MIMO | 5510 | Type5 | 18 | 10 | 654516.0 | 12 | 2 | 82.7 | 1710.0 | 1990.0 | --- |
| 11ax40MIMO | 5510 | Type5 | 18 | 11 | 8083.0 | 12 | 1 | 50.7 | 1234.0 | --- | --- |
| 11ax40MIMO | 5510 | Type5 | 18 | 12 | 215435.0 | 12 | 2 | 78.4 | 1047.0 | 1109.0 | --- |
| 11ax40MIMO | 5510 | Type5 | 18 | 13 | 421325.0 | 12 | 3 | 99.5 | 1299.0 | 1965.0 | 1869.0 |
| 11ax80MIMO | 5530 | Type5 | 18 | 0 | 292143.0 | 12 | 1 | 55.3 | 1920.0 | --- | --- |
| 11ax80MIMO | 5530 | Type5 | 18 | 1 | 499633.0 | 12 | 1 | 58.3 | 1797.0 | --- | --- |
| 11ax80MIMO | 5530 | Type5 | 18 | 2 | 706377.0 | 12 | 2 | 72.3 | 1610.0 | 1039.0 | --- |
| 11ax80MIMO | 5530 | Type5 | 18 | 3 | 58989.0 | 12 | 3 | 84.8 | 1131.0 | 1761.0 | 1721.0 |
| 11ax80MIMO | 5530 | Type5 | 18 | 4 | 266161.0 | 12 | 2 | 82.5 | 1875.0 | 1431.0 | --- |
| 11ax80MIMO | 5530 | Type5 | 18 | 5 | 474469.0 | 12 | 1 | 63.3 | 1095.0 | --- | --- |
| 11ax80MIMO | 5530 | Type5 | 18 | 6 | 680544.0 | 12 | 2 | 80.0 | 1119.0 | 1913.0 | --- |
| 11ax80MIMO | 5530 | Type5 | 18 | 7 | 33519.0 | 12 | 3 | 90.3 | 1660.0 | 1853.0 | 1123.0 |
| 11ax80MIMO | 5530 | Type5 | 18 | 8 | 240319.0 | 12 | 3 | 91.1 | 1539.0 | 1783.0 | 1172.0 |
| 11ax80MIMO | 5530 | Type5 | 18 | 9 | 447400.0 | 12 | 3 | 96.6 | 1525.0 | 1036.0 | 1385.0 |
| 11ax80MIMO | 5530 | Type5 | 18 | 10 | 654516.0 | 12 | 2 | 82.7 | 1710.0 | 1990.0 | --- |
| 11ax80MIMO | 5530 | Type5 | 18 | 11 | 8083.0 | 12 | 1 | 50.7 | 1234.0 | --- | --- |
| 11ax80MIMO | 5530 | Type5 | 18 | 12 | 215435.0 | 12 | 2 | 78.4 | 1047.0 | 1109.0 | --- |
| 11ax80MIMO | 5530 | Type5 | 18 | 13 | 421325.0 | 12 | 3 | 99.5 | 1299.0 | 1965.0 | 1869.0 |
| 11ax160MIMO | 5570 | Type5 | 18 | 0 | 292143.0 | 12 | 1 | 55.3 | 1920.0 | --- | --- |
| 11ax160MIMO | 5570 | Type5 | 18 | 1 | 499633.0 | 12 | 1 | 58.3 | 1797.0 | --- | --- |
| 11ax160MIMO | 5570 | Type5 | 18 | 2 | 706377.0 | 12 | 2 | 72.3 | 1610.0 | 1039.0 | --- |
| 11ax160MIMO | 5570 | Type5 | 18 | 3 | 58989.0 | 12 | 3 | 84.8 | 1131.0 | 1761.0 | 1721.0 |
| 11ax160MIMO | 5570 | Type5 | 18 | 4 | 266161.0 | 12 | 2 | 82.5 | 1875.0 | 1431.0 | --- |
| 11ax160MIMO | 5570 | Type5 | 18 | 5 | 474469.0 | 12 | 1 | 63.3 | 1095.0 | --- | --- |
| 11ax160MIMO | 5570 | Type5 | 18 | 6 | 680544.0 | 12 | 2 | 80.0 | 1119.0 | 1913.0 | --- |
| 11ax160MIMO | 5570 | Type5 | 18 | 7 | 33519.0 | 12 | 3 | 90.3 | 1660.0 | 1853.0 | 1123.0 |
| 11ax160MIMO | 5570 | Type5 | 18 | 8 | 240319.0 | 12 | 3 | 91.1 | 1539.0 | 1783.0 | 1172.0 |
| 11ax160MIMO | 5570 | Type5 | 18 | 9 | 447400.0 | 12 | 3 | 96.6 | 1525.0 | 1036.0 | 1385.0 |
| 11ax160MIMO | 5570 | Type5 | 18 | 10 | 654516.0 | 12 | 2 | 82.7 | 1710.0 | 1990.0 | --- |
| 11ax160MIMO | 5570 | Type5 | 18 | 11 | 8083.0 | 12 | 1 | 50.7 | 1234.0 | --- | --- |
| 11ax160MIMO | 5570 | Type5 | 18 | 12 | 215435.0 | 12 | 2 | 78.4 | 1047.0 | 1109.0 | --- |
| 11ax160MIMO | 5570 | Type5 | 18 | 13 | 421325.0 | 12 | 3 | 99.5 | 1299.0 | 1965.0 | 1869.0 |



Unless otherwise agreed in writing, this document is issued by the Company subject to its General Conditions of Service printed overleaf, available on request or accessible at <http://www.sgs.com/en/Terms-and-Conditions.aspx> and, for electronic format documents, subject to Terms and Conditions for Electronic Documents at <http://www.sgs.com/en/Terms-and-Conditions/Terms-e-Documents.aspx>. Attention is drawn to the limitation of liability, indemnification and jurisdiction issues defined therein. Any holder of this document is advised that information contained hereon reflects the Company's findings at the time of its intervention only and within the limits of Client's instructions, if any. The Company's sole responsibility is to its Client and this document does not exonerate parties to a transaction from exercising all their rights and obligations under the transaction documents. This document cannot be reproduced except in full, without prior written approval of the Company. Any unauthorized alteration, forgery or falsification of the content or appearance of this document is unlawful and offenders may be prosecuted to the fullest extent of the law. Unless otherwise stated the results shown in this report refer only to the sample(s) tested and such sample(s) are retained for 30 days only.

Attention: To check the authenticity of testing / inspection report & certificate, please contact us at telephone: (86-755) 8307 1443, or email: CN.Doccheck@sgs.com

South of No. 6 Plant, No. 1, Runsheng Road, Suzhou Industrial Park, Suzhou Area, China (Jiangsu) Pilot Free Trade Zone
中国·苏州·中国 (江苏) 自由贸易试验区苏州片区苏州工业园区润胜路1号的6号厂房南楼 邮编: 215000

t (86-512) 62992980 www.sgsqgroup.com.cn
t (86-512) 62992980 sgs.china@sgs.com

| @FCC_RLAN_DFS_SPC_Radar_T5_SP2_Tr19@ | | | | | | | | | | | |
|--------------------------------------|---------|------------|----------|----------|-------------------|-------------------|------------------|------------------|-----------|-----------|-----------|
| TestMode | Channel | Radar Type | Trial ID | Burst ID | Burst Offset (μs) | Chirp Width (MHz) | Number Of Pulses | Pulse Width (μs) | PRI1 (μs) | PRI2 (μs) | PRI3 (μs) |
| 11ax20MIMO | 5500 | Type5 | 19 | 0 | 733725.0 | 10 | 3 | 88.6 | 1501.0 | 1067.0 | 1927.0 |
| 11ax20MIMO | 5500 | Type5 | 19 | 1 | 977882.0 | 10 | 1 | 57.4 | 1723.0 | --- | --- |
| 11ax20MIMO | 5500 | Type5 | 19 | 2 | 221197.0 | 10 | 3 | 96.6 | 1086.0 | 1658.0 | 1324.0 |
| 11ax20MIMO | 5500 | Type5 | 19 | 3 | 462915.0 | 10 | 2 | 69.7 | 1751.0 | 1945.0 | --- |
| 11ax20MIMO | 5500 | Type5 | 19 | 4 | 705071.0 | 10 | 2 | 77.9 | 1642.0 | 1317.0 | --- |
| 11ax20MIMO | 5500 | Type5 | 19 | 5 | 947923.0 | 10 | 1 | 62.0 | 1866.0 | --- | --- |
| 11ax20MIMO | 5500 | Type5 | 19 | 6 | 191373.0 | 10 | 3 | 88.4 | 1997.0 | 1077.0 | 1366.0 |
| 11ax20MIMO | 5500 | Type5 | 19 | 7 | 432561.0 | 10 | 3 | 97.3 | 1790.0 | 1896.0 | 1367.0 |
| 11ax20MIMO | 5500 | Type5 | 19 | 8 | 674004.0 | 10 | 3 | 96.2 | 1391.0 | 1787.0 | 1672.0 |
| 11ax20MIMO | 5500 | Type5 | 19 | 9 | 915842.0 | 10 | 3 | 95.4 | 1020.0 | 1892.0 | 1414.0 |
| 11ax20MIMO | 5500 | Type5 | 19 | 10 | 162176.0 | 10 | 1 | 54.8 | 1084.0 | --- | --- |
| 11ax20MIMO | 5500 | Type5 | 19 | 11 | 403553.0 | 10 | 2 | 80.4 | 1850.0 | 1436.0 | --- |
| 11ax40MIMO | 5510 | Type5 | 19 | 0 | 733725.0 | 10 | 3 | 88.6 | 1501.0 | 1067.0 | 1927.0 |
| 11ax40MIMO | 5510 | Type5 | 19 | 1 | 977882.0 | 10 | 1 | 57.4 | 1723.0 | --- | --- |
| 11ax40MIMO | 5510 | Type5 | 19 | 2 | 221197.0 | 10 | 3 | 96.6 | 1086.0 | 1658.0 | 1324.0 |
| 11ax40MIMO | 5510 | Type5 | 19 | 3 | 462915.0 | 10 | 2 | 69.7 | 1751.0 | 1945.0 | --- |
| 11ax40MIMO | 5510 | Type5 | 19 | 4 | 705071.0 | 10 | 2 | 77.9 | 1642.0 | 1317.0 | --- |
| 11ax40MIMO | 5510 | Type5 | 19 | 5 | 947923.0 | 10 | 1 | 62.0 | 1866.0 | --- | --- |
| 11ax40MIMO | 5510 | Type5 | 19 | 6 | 191373.0 | 10 | 3 | 88.4 | 1997.0 | 1077.0 | 1366.0 |
| 11ax40MIMO | 5510 | Type5 | 19 | 7 | 432561.0 | 10 | 3 | 97.3 | 1790.0 | 1896.0 | 1367.0 |
| 11ax40MIMO | 5510 | Type5 | 19 | 8 | 674004.0 | 10 | 3 | 96.2 | 1391.0 | 1787.0 | 1672.0 |
| 11ax40MIMO | 5510 | Type5 | 19 | 9 | 915842.0 | 10 | 3 | 95.4 | 1020.0 | 1892.0 | 1414.0 |
| 11ax40MIMO | 5510 | Type5 | 19 | 10 | 162176.0 | 10 | 1 | 54.8 | 1084.0 | --- | --- |
| 11ax40MIMO | 5510 | Type5 | 19 | 11 | 403553.0 | 10 | 2 | 80.4 | 1850.0 | 1436.0 | --- |
| 11ax80MIMO | 5530 | Type5 | 19 | 0 | 733725.0 | 10 | 3 | 88.6 | 1501.0 | 1067.0 | 1927.0 |
| 11ax80MIMO | 5530 | Type5 | 19 | 1 | 977882.0 | 10 | 1 | 57.4 | 1723.0 | --- | --- |
| 11ax80MIMO | 5530 | Type5 | 19 | 2 | 221197.0 | 10 | 3 | 96.6 | 1086.0 | 1658.0 | 1324.0 |
| 11ax80MIMO | 5530 | Type5 | 19 | 3 | 462915.0 | 10 | 2 | 69.7 | 1751.0 | 1945.0 | --- |
| 11ax80MIMO | 5530 | Type5 | 19 | 4 | 705071.0 | 10 | 2 | 77.9 | 1642.0 | 1317.0 | --- |
| 11ax80MIMO | 5530 | Type5 | 19 | 5 | 947923.0 | 10 | 1 | 62.0 | 1866.0 | --- | --- |
| 11ax80MIMO | 5530 | Type5 | 19 | 6 | 191373.0 | 10 | 3 | 88.4 | 1997.0 | 1077.0 | 1366.0 |
| 11ax80MIMO | 5530 | Type5 | 19 | 7 | 432561.0 | 10 | 3 | 97.3 | 1790.0 | 1896.0 | 1367.0 |
| 11ax80MIMO | 5530 | Type5 | 19 | 8 | 674004.0 | 10 | 3 | 96.2 | 1391.0 | 1787.0 | 1672.0 |
| 11ax80MIMO | 5530 | Type5 | 19 | 9 | 915842.0 | 10 | 3 | 95.4 | 1020.0 | 1892.0 | 1414.0 |
| 11ax80MIMO | 5530 | Type5 | 19 | 10 | 162176.0 | 10 | 1 | 54.8 | 1084.0 | --- | --- |
| 11ax80MIMO | 5530 | Type5 | 19 | 11 | 403553.0 | 10 | 2 | 80.4 | 1850.0 | 1436.0 | --- |
| 11ax160MIMO | 5570 | Type5 | 19 | 0 | 733725.0 | 10 | 3 | 88.6 | 1501.0 | 1067.0 | 1927.0 |
| 11ax160MIMO | 5570 | Type5 | 19 | 1 | 977882.0 | 10 | 1 | 57.4 | 1723.0 | --- | --- |
| 11ax160MIMO | 5570 | Type5 | 19 | 2 | 221197.0 | 10 | 3 | 96.6 | 1086.0 | 1658.0 | 1324.0 |
| 11ax160MIMO | 5570 | Type5 | 19 | 3 | 462915.0 | 10 | 2 | 69.7 | 1751.0 | 1945.0 | --- |
| 11ax160MIMO | 5570 | Type5 | 19 | 4 | 705071.0 | 10 | 2 | 77.9 | 1642.0 | 1317.0 | --- |
| 11ax160MIMO | 5570 | Type5 | 19 | 5 | 947923.0 | 10 | 1 | 62.0 | 1866.0 | --- | --- |
| 11ax160MIMO | 5570 | Type5 | 19 | 6 | 191373.0 | 10 | 3 | 88.4 | 1997.0 | 1077.0 | 1366.0 |
| 11ax160MIMO | 5570 | Type5 | 19 | 7 | 432561.0 | 10 | 3 | 97.3 | 1790.0 | 1896.0 | 1367.0 |
| 11ax160MIMO | 5570 | Type5 | 19 | 8 | 674004.0 | 10 | 3 | 96.2 | 1391.0 | 1787.0 | 1672.0 |
| 11ax160MIMO | 5570 | Type5 | 19 | 9 | 915842.0 | 10 | 3 | 95.4 | 1020.0 | 1892.0 | 1414.0 |
| 11ax160MIMO | 5570 | Type5 | 19 | 10 | 162176.0 | 10 | 1 | 54.8 | 1084.0 | --- | --- |
| 11ax160MIMO | 5570 | Type5 | 19 | 11 | 403553.0 | 10 | 2 | 80.4 | 1850.0 | 1436.0 | --- |



Unless otherwise agreed in writing, this document is issued by the Company subject to its General Conditions of Service printed overleaf, available on request or accessible at <http://www.sgs.com/en/Terms-and-Conditions.aspx> and, for electronic format documents, subject to Terms and Conditions for Electronic Documents at <http://www.sgs.com/en/Terms-and-Conditions/Terms-e-Documents.aspx>. Attention is drawn to the limitation of liability, indemnification and jurisdiction issues defined therein. Any holder of this document is advised that information contained hereon reflects the Company's findings at the time of its intervention only and within the limits of Client's instructions, if any. The Company's sole responsibility is to its Client and this document does not exonerate parties to a transaction from exercising all their rights and obligations under the transaction documents. This document cannot be reproduced except in full, without prior written approval of the Company. Any unauthorized alteration, forgery or falsification of the content or appearance of this document is unlawful and offenders may be prosecuted to the fullest extent of the law. Unless otherwise stated the results shown in this test report refer only to the sample(s) tested and such sample(s) are retained for 30 days only.

Attention: To check the authenticity of testing / inspection report & certificate, please contact us at telephone: (86-755) 8307 1443, or email: QN.Doccheck@sgs.com

South of No. 6 Plant, No. 1, Runsheng Road, Suzhou Industrial Park, Suzhou Area, China (Jiangsu) Pilot Free Trade Zone 215000 t (86-512) 62992980 www.sgsgroup.com.cn
 中国·苏州·中国(江苏)自由贸易试验区苏州片区苏州工业园区润胜路1号的6号厂房南楼 邮编: 215000 t (86-512) 62992980 sgs.china@sgs.com

| @FCC_RLAN_DFS_SPC_Radar_T5_SP2_Tr20@ | | | | | | | | | | | |
|--------------------------------------|---------|------------|----------|----------|-------------------|-------------------|------------------|------------------|-----------|-----------|-----------|
| TestMode | Channel | Radar Type | Trial ID | Burst ID | Burst Offset (μs) | Chirp Width (MHz) | Number Of Pulses | Pulse Width (μs) | PRI1 (μs) | PRI2 (μs) | PRI3 (μs) |
| 11ax20MIMO | 5500 | Type5 | 20 | 0 | 483470.0 | 15 | 2 | 74.7 | 1619.0 | 1611.0 | --- |
| 11ax20MIMO | 5500 | Type5 | 20 | 1 | 666072.0 | 15 | 1 | 57.1 | 1560.0 | --- | --- |
| 11ax20MIMO | 5500 | Type5 | 20 | 2 | 98810.0 | 15 | 3 | 91.9 | 1392.0 | 1475.0 | 1276.0 |
| 11ax20MIMO | 5500 | Type5 | 20 | 3 | 279914.0 | 15 | 2 | 83.1 | 1809.0 | 1772.0 | --- |
| 11ax20MIMO | 5500 | Type5 | 20 | 4 | 462536.0 | 15 | 1 | 50.7 | 1003.0 | --- | --- |
| 11ax20MIMO | 5500 | Type5 | 20 | 5 | 642324.0 | 15 | 2 | 79.2 | 1574.0 | 1600.0 | --- |
| 11ax20MIMO | 5500 | Type5 | 20 | 6 | 76831.0 | 15 | 1 | 58.7 | 1186.0 | --- | --- |
| 11ax20MIMO | 5500 | Type5 | 20 | 7 | 257785.0 | 15 | 2 | 71.0 | 1521.0 | 1567.0 | --- |
| 11ax20MIMO | 5500 | Type5 | 20 | 8 | 438554.0 | 15 | 2 | 79.0 | 1777.0 | 1960.0 | --- |
| 11ax20MIMO | 5500 | Type5 | 20 | 9 | 620397.0 | 15 | 2 | 68.5 | 1284.0 | 1428.0 | --- |
| 11ax20MIMO | 5500 | Type5 | 20 | 10 | 54310.0 | 15 | 2 | 73.5 | 1904.0 | 1352.0 | --- |
| 11ax20MIMO | 5500 | Type5 | 20 | 11 | 235506.0 | 15 | 2 | 70.5 | 1864.0 | 1115.0 | --- |
| 11ax20MIMO | 5500 | Type5 | 20 | 12 | 417036.0 | 15 | 2 | 76.6 | 1045.0 | 1300.0 | --- |
| 11ax20MIMO | 5500 | Type5 | 20 | 13 | 597974.0 | 15 | 2 | 81.2 | 1160.0 | 1675.0 | --- |
| 11ax20MIMO | 5500 | Type5 | 20 | 14 | 32086.0 | 15 | 1 | 61.8 | 1277.0 | --- | --- |
| 11ax20MIMO | 5500 | Type5 | 20 | 15 | 212751.0 | 15 | 3 | 94.9 | 1450.0 | 1206.0 | 1860.0 |
| 11ax40MIMO | 5510 | Type5 | 20 | 0 | 483470.0 | 15 | 2 | 74.7 | 1619.0 | 1611.0 | --- |
| 11ax40MIMO | 5510 | Type5 | 20 | 1 | 666072.0 | 15 | 1 | 57.1 | 1560.0 | --- | --- |
| 11ax40MIMO | 5510 | Type5 | 20 | 2 | 98810.0 | 15 | 3 | 91.9 | 1392.0 | 1475.0 | 1276.0 |
| 11ax40MIMO | 5510 | Type5 | 20 | 3 | 279914.0 | 15 | 2 | 83.1 | 1809.0 | 1772.0 | --- |
| 11ax40MIMO | 5510 | Type5 | 20 | 4 | 462536.0 | 15 | 1 | 50.7 | 1003.0 | --- | --- |
| 11ax40MIMO | 5510 | Type5 | 20 | 5 | 642324.0 | 15 | 2 | 79.2 | 1574.0 | 1600.0 | --- |
| 11ax40MIMO | 5510 | Type5 | 20 | 6 | 76831.0 | 15 | 1 | 58.7 | 1186.0 | --- | --- |
| 11ax40MIMO | 5510 | Type5 | 20 | 7 | 257785.0 | 15 | 2 | 71.0 | 1521.0 | 1567.0 | --- |
| 11ax40MIMO | 5510 | Type5 | 20 | 8 | 438554.0 | 15 | 2 | 79.0 | 1777.0 | 1960.0 | --- |
| 11ax40MIMO | 5510 | Type5 | 20 | 9 | 620397.0 | 15 | 2 | 68.5 | 1284.0 | 1428.0 | --- |
| 11ax40MIMO | 5510 | Type5 | 20 | 10 | 54310.0 | 15 | 2 | 73.5 | 1904.0 | 1352.0 | --- |
| 11ax40MIMO | 5510 | Type5 | 20 | 11 | 235506.0 | 15 | 2 | 70.5 | 1864.0 | 1115.0 | --- |
| 11ax40MIMO | 5510 | Type5 | 20 | 12 | 417036.0 | 15 | 2 | 76.6 | 1045.0 | 1300.0 | --- |
| 11ax40MIMO | 5510 | Type5 | 20 | 13 | 597974.0 | 15 | 2 | 81.2 | 1160.0 | 1675.0 | --- |
| 11ax40MIMO | 5510 | Type5 | 20 | 14 | 32086.0 | 15 | 1 | 61.8 | 1277.0 | --- | --- |
| 11ax40MIMO | 5510 | Type5 | 20 | 15 | 212751.0 | 15 | 3 | 94.9 | 1450.0 | 1206.0 | 1860.0 |
| 11ax80MIMO | 5530 | Type5 | 20 | 0 | 483470.0 | 15 | 2 | 74.7 | 1619.0 | 1611.0 | --- |
| 11ax80MIMO | 5530 | Type5 | 20 | 1 | 666072.0 | 15 | 1 | 57.1 | 1560.0 | --- | --- |
| 11ax80MIMO | 5530 | Type5 | 20 | 2 | 98810.0 | 15 | 3 | 91.9 | 1392.0 | 1475.0 | 1276.0 |
| 11ax80MIMO | 5530 | Type5 | 20 | 3 | 279914.0 | 15 | 2 | 83.1 | 1809.0 | 1772.0 | --- |
| 11ax80MIMO | 5530 | Type5 | 20 | 4 | 462536.0 | 15 | 1 | 50.7 | 1003.0 | --- | --- |
| 11ax80MIMO | 5530 | Type5 | 20 | 5 | 642324.0 | 15 | 2 | 79.2 | 1574.0 | 1600.0 | --- |
| 11ax80MIMO | 5530 | Type5 | 20 | 6 | 76831.0 | 15 | 1 | 58.7 | 1186.0 | --- | --- |
| 11ax80MIMO | 5530 | Type5 | 20 | 7 | 257785.0 | 15 | 2 | 71.0 | 1521.0 | 1567.0 | --- |
| 11ax80MIMO | 5530 | Type5 | 20 | 8 | 438554.0 | 15 | 2 | 79.0 | 1777.0 | 1960.0 | --- |
| 11ax80MIMO | 5530 | Type5 | 20 | 9 | 620397.0 | 15 | 2 | 68.5 | 1284.0 | 1428.0 | --- |
| 11ax80MIMO | 5530 | Type5 | 20 | 10 | 54310.0 | 15 | 2 | 73.5 | 1904.0 | 1352.0 | --- |
| 11ax80MIMO | 5530 | Type5 | 20 | 11 | 235506.0 | 15 | 2 | 70.5 | 1864.0 | 1115.0 | --- |
| 11ax80MIMO | 5530 | Type5 | 20 | 12 | 417036.0 | 15 | 2 | 76.6 | 1045.0 | 1300.0 | --- |
| 11ax80MIMO | 5530 | Type5 | 20 | 13 | 597974.0 | 15 | 2 | 81.2 | 1160.0 | 1675.0 | --- |
| 11ax80MIMO | 5530 | Type5 | 20 | 14 | 32086.0 | 15 | 1 | 61.8 | 1277.0 | --- | --- |
| 11ax80MIMO | 5530 | Type5 | 20 | 15 | 212751.0 | 15 | 3 | 94.9 | 1450.0 | 1206.0 | 1860.0 |
| 11ax160MIMO | 5570 | Type5 | 20 | 0 | 483470.0 | 15 | 2 | 74.7 | 1619.0 | 1611.0 | --- |
| 11ax160MIMO | 5570 | Type5 | 20 | 1 | 666072.0 | 15 | 1 | 57.1 | 1560.0 | --- | --- |
| 11ax160MIMO | 5570 | Type5 | 20 | 2 | 98810.0 | 15 | 3 | 91.9 | 1392.0 | 1475.0 | 1276.0 |
| 11ax160MIMO | 5570 | Type5 | 20 | 3 | 279914.0 | 15 | 2 | 83.1 | 1809.0 | 1772.0 | --- |
| 11ax160MIMO | 5570 | Type5 | 20 | 4 | 462536.0 | 15 | 1 | 50.7 | 1003.0 | --- | --- |
| 11ax160MIMO | 5570 | Type5 | 20 | 5 | 642324.0 | 15 | 2 | 79.2 | 1574.0 | 1600.0 | --- |
| 11ax160MIMO | 5570 | Type5 | 20 | 6 | 76831.0 | 15 | 1 | 58.7 | 1186.0 | --- | --- |
| 11ax160MIMO | 5570 | Type5 | 20 | 7 | 257785.0 | 15 | 2 | 71.0 | 1521.0 | 1567.0 | --- |
| 11ax160MIMO | 5570 | Type5 | 20 | 8 | 438554.0 | 15 | 2 | 79.0 | 1777.0 | 1960.0 | --- |



Unless otherwise agreed in writing, this document is issued by the Company subject to its General Conditions of Service printed overleaf, available on request or accessible at <http://www.sgs.com/en/Terms-and-Conditions.aspx> and, for electronic format documents, subject to Terms and Conditions for Electronic Documents at <http://www.sgs.com/en/Terms-and-Conditions/Terms-e-Documents.aspx>. Attention is drawn to the limitation of liability, indemnification and jurisdiction issues defined therein. Any holder of this document is advised that information contained hereon reflects the Company's findings at the time of its intervention only and within the limits of Client's instructions, if any. The Company's sole responsibility is to its Client and this document does not exonerate parties to a transaction from exercising all their rights and obligations under the transaction documents. This document cannot be reproduced except in full, without prior written approval of the Company. Any unauthorized alteration, forgery or falsification of the content or appearance of this document is unlawful and offenders may be prosecuted to the fullest extent of the law. Unless otherwise stated the results shown in this report refer only to the sample(s) tested and such sample(s) are retained for 30 days only.

Attention: To check the authenticity of testing/inspection report & certificate, please contact us at telephone: (86-755) 8307 1443, or email: QN.Doccheck@sgs.com

Report No.: SEWA2303000041RG06

Rev.: 01

Page: 89 of 104

| | | | | | | | | | | | |
|-------------|------|-------|----|----|----------|----|---|------|--------|--------|--------|
| 11ax160MIMO | 5570 | Type5 | 20 | 9 | 620397.0 | 15 | 2 | 68.5 | 1284.0 | 1428.0 | --- |
| 11ax160MIMO | 5570 | Type5 | 20 | 10 | 54310.0 | 15 | 2 | 73.5 | 1904.0 | 1352.0 | --- |
| 11ax160MIMO | 5570 | Type5 | 20 | 11 | 235506.0 | 15 | 2 | 70.5 | 1864.0 | 1115.0 | --- |
| 11ax160MIMO | 5570 | Type5 | 20 | 12 | 417036.0 | 15 | 2 | 76.6 | 1045.0 | 1300.0 | --- |
| 11ax160MIMO | 5570 | Type5 | 20 | 13 | 597974.0 | 15 | 2 | 81.2 | 1160.0 | 1675.0 | --- |
| 11ax160MIMO | 5570 | Type5 | 20 | 14 | 32086.0 | 15 | 1 | 61.8 | 1277.0 | --- | --- |
| 11ax160MIMO | 5570 | Type5 | 20 | 15 | 212751.0 | 15 | 3 | 94.9 | 1450.0 | 1206.0 | 1860.0 |



Unless otherwise agreed in writing, this document is issued by the Company subject to its General Conditions of Service printed overleaf, available on request or accessible at <http://www.sgs.com/en/Terms-and-Conditions.aspx> and, for electronic format documents, subject to Terms and Conditions for Electronic Documents at <http://www.sgs.com/en/Terms-and-Conditions/Terms-e-Documents.aspx>. Attention is drawn to the limitation of liability, indemnification and jurisdiction issues defined therein. Any holder of this document is advised that information contained hereon reflects the Company's findings at the time of its intervention only and within the limits of Client's instructions, if any. The Company's sole responsibility is to its Client and this document does not exonerate parties to a transaction from exercising all their rights and obligations under the transaction documents. This document cannot be reproduced except in full, without prior written approval of the Company. Any unauthorized alteration, forgery or falsification of the content or appearance of this document is unlawful and offenders may be prosecuted to the fullest extent of the law. Unless otherwise stated the results shown in this test report refer only to the sample(s) tested and such sample(s) are retained for 30 days only.

Attention: To check the authenticity of testing /inspection report & certificate, please contact us at telephone: (86-755) 8307 1443, or email: CN.Doccheck@sgs.com

| @FCC_RLAN_DFS_SPC_Radar_T5_SP2_Tr21@ | | | | | | | | | | | |
|--------------------------------------|---------|------------|----------|----------|-------------------|-------------------|------------------|------------------|-----------|-----------|-----------|
| TestMode | Channel | Radar Type | Trial ID | Burst ID | Burst Offset (μs) | Chirp Width (MHz) | Number Of Pulses | Pulse Width (μs) | PRI1 (μs) | PRI2 (μs) | PRI3 (μs) |
| 11ax20MIMO | 5500 | Type5 | 21 | 0 | 526149.0 | 9 | 2 | 78.5 | 1653.0 | 1698.0 | --- |
| 11ax20MIMO | 5500 | Type5 | 21 | 1 | 767135.0 | 9 | 3 | 89.8 | 1174.0 | 1962.0 | 1167.0 |
| 11ax20MIMO | 5500 | Type5 | 21 | 2 | 12955.0 | 9 | 1 | 59.4 | 1982.0 | --- | --- |
| 11ax20MIMO | 5500 | Type5 | 21 | 3 | 254612.0 | 9 | 2 | 79.6 | 1633.0 | 1890.0 | --- |
| 11ax20MIMO | 5500 | Type5 | 21 | 4 | 496588.0 | 9 | 2 | 76.0 | 1112.0 | 1811.0 | --- |
| 11ax20MIMO | 5500 | Type5 | 21 | 5 | 739728.0 | 9 | 1 | 53.6 | 1144.0 | --- | --- |
| 11ax20MIMO | 5500 | Type5 | 21 | 6 | 980872.0 | 9 | 2 | 80.9 | 1220.0 | 1053.0 | --- |
| 11ax20MIMO | 5500 | Type5 | 21 | 7 | 225249.0 | 9 | 1 | 61.6 | 1724.0 | --- | --- |
| 11ax20MIMO | 5500 | Type5 | 21 | 8 | 467279.0 | 9 | 1 | 53.4 | 1901.0 | --- | --- |
| 11ax20MIMO | 5500 | Type5 | 21 | 9 | 709720.0 | 9 | 1 | 59.9 | 1379.0 | --- | --- |
| 11ax20MIMO | 5500 | Type5 | 21 | 10 | 951847.0 | 9 | 1 | 60.4 | 1453.0 | --- | --- |
| 11ax20MIMO | 5500 | Type5 | 21 | 11 | 194839.0 | 9 | 3 | 91.4 | 1768.0 | 1726.0 | 1227.0 |
| 11ax40MIMO | 5510 | Type5 | 21 | 0 | 526149.0 | 9 | 2 | 78.5 | 1653.0 | 1698.0 | --- |
| 11ax40MIMO | 5510 | Type5 | 21 | 1 | 767135.0 | 9 | 3 | 89.8 | 1174.0 | 1962.0 | 1167.0 |
| 11ax40MIMO | 5510 | Type5 | 21 | 2 | 12955.0 | 9 | 1 | 59.4 | 1982.0 | --- | --- |
| 11ax40MIMO | 5510 | Type5 | 21 | 3 | 254612.0 | 9 | 2 | 79.6 | 1633.0 | 1890.0 | --- |
| 11ax40MIMO | 5510 | Type5 | 21 | 4 | 496588.0 | 9 | 2 | 76.0 | 1112.0 | 1811.0 | --- |
| 11ax40MIMO | 5510 | Type5 | 21 | 5 | 739728.0 | 9 | 1 | 53.6 | 1144.0 | --- | --- |
| 11ax40MIMO | 5510 | Type5 | 21 | 6 | 980872.0 | 9 | 2 | 80.9 | 1220.0 | 1053.0 | --- |
| 11ax40MIMO | 5510 | Type5 | 21 | 7 | 225249.0 | 9 | 1 | 61.6 | 1724.0 | --- | --- |
| 11ax40MIMO | 5510 | Type5 | 21 | 8 | 467279.0 | 9 | 1 | 53.4 | 1901.0 | --- | --- |
| 11ax40MIMO | 5510 | Type5 | 21 | 9 | 709720.0 | 9 | 1 | 59.9 | 1379.0 | --- | --- |
| 11ax40MIMO | 5510 | Type5 | 21 | 10 | 951847.0 | 9 | 1 | 60.4 | 1453.0 | --- | --- |
| 11ax40MIMO | 5510 | Type5 | 21 | 11 | 194839.0 | 9 | 3 | 91.4 | 1768.0 | 1726.0 | 1227.0 |
| 11ax80MIMO | 5530 | Type5 | 21 | 0 | 526149.0 | 9 | 2 | 78.5 | 1653.0 | 1698.0 | --- |
| 11ax80MIMO | 5530 | Type5 | 21 | 1 | 767135.0 | 9 | 3 | 89.8 | 1174.0 | 1962.0 | 1167.0 |
| 11ax80MIMO | 5530 | Type5 | 21 | 2 | 12955.0 | 9 | 1 | 59.4 | 1982.0 | --- | --- |
| 11ax80MIMO | 5530 | Type5 | 21 | 3 | 254612.0 | 9 | 2 | 79.6 | 1633.0 | 1890.0 | --- |
| 11ax80MIMO | 5530 | Type5 | 21 | 4 | 496588.0 | 9 | 2 | 76.0 | 1112.0 | 1811.0 | --- |
| 11ax80MIMO | 5530 | Type5 | 21 | 5 | 739728.0 | 9 | 1 | 53.6 | 1144.0 | --- | --- |
| 11ax80MIMO | 5530 | Type5 | 21 | 6 | 980872.0 | 9 | 2 | 80.9 | 1220.0 | 1053.0 | --- |
| 11ax80MIMO | 5530 | Type5 | 21 | 7 | 225249.0 | 9 | 1 | 61.6 | 1724.0 | --- | --- |
| 11ax80MIMO | 5530 | Type5 | 21 | 8 | 467279.0 | 9 | 1 | 53.4 | 1901.0 | --- | --- |
| 11ax80MIMO | 5530 | Type5 | 21 | 9 | 709720.0 | 9 | 1 | 59.9 | 1379.0 | --- | --- |
| 11ax80MIMO | 5530 | Type5 | 21 | 10 | 951847.0 | 9 | 1 | 60.4 | 1453.0 | --- | --- |
| 11ax80MIMO | 5530 | Type5 | 21 | 11 | 194839.0 | 9 | 3 | 91.4 | 1768.0 | 1726.0 | 1227.0 |
| 11ax160MIMO | 5570 | Type5 | 21 | 0 | 526149.0 | 9 | 2 | 78.5 | 1653.0 | 1698.0 | --- |
| 11ax160MIMO | 5570 | Type5 | 21 | 1 | 767135.0 | 9 | 3 | 89.8 | 1174.0 | 1962.0 | 1167.0 |
| 11ax160MIMO | 5570 | Type5 | 21 | 2 | 12955.0 | 9 | 1 | 59.4 | 1982.0 | --- | --- |
| 11ax160MIMO | 5570 | Type5 | 21 | 3 | 254612.0 | 9 | 2 | 79.6 | 1633.0 | 1890.0 | --- |
| 11ax160MIMO | 5570 | Type5 | 21 | 4 | 496588.0 | 9 | 2 | 76.0 | 1112.0 | 1811.0 | --- |
| 11ax160MIMO | 5570 | Type5 | 21 | 5 | 739728.0 | 9 | 1 | 53.6 | 1144.0 | --- | --- |
| 11ax160MIMO | 5570 | Type5 | 21 | 6 | 980872.0 | 9 | 2 | 80.9 | 1220.0 | 1053.0 | --- |
| 11ax160MIMO | 5570 | Type5 | 21 | 7 | 225249.0 | 9 | 1 | 61.6 | 1724.0 | --- | --- |
| 11ax160MIMO | 5570 | Type5 | 21 | 8 | 467279.0 | 9 | 1 | 53.4 | 1901.0 | --- | --- |
| 11ax160MIMO | 5570 | Type5 | 21 | 9 | 709720.0 | 9 | 1 | 59.9 | 1379.0 | --- | --- |
| 11ax160MIMO | 5570 | Type5 | 21 | 10 | 951847.0 | 9 | 1 | 60.4 | 1453.0 | --- | --- |
| 11ax160MIMO | 5570 | Type5 | 21 | 11 | 194839.0 | 9 | 3 | 91.4 | 1768.0 | 1726.0 | 1227.0 |



Unless otherwise agreed in writing, this document is issued by the Company subject to its General Conditions of Service printed overleaf, available on request or accessible at <http://www.sgs.com/en/Terms-and-Conditions.aspx> and, for electronic format documents, subject to Terms and Conditions for Electronic Documents at <http://www.sgs.com/en/Terms-and-Conditions/Terms-e-Documents.aspx>. Attention is drawn to the limitation of liability, indemnification and jurisdiction issues defined therein. Any holder of this document is advised that information contained hereon reflects the Company's findings at the time of its intervention only and within the limits of Client's instructions, if any. The Company's sole responsibility is to its Client and this document does not exonerate parties to a transaction from exercising all their rights and obligations under the transaction documents. This document cannot be reproduced except in full, without prior written approval of the Company. Any unauthorized alteration, forgery or falsification of the content or appearance of this document is unlawful and offenders may be prosecuted to the fullest extent of the law. Unless otherwise stated the results shown in this test report refer only to the sample(s) tested and such sample(s) are retained for 30 days only.

Attention: To check the authenticity of testing / inspection report & certificate, please contact us at telephone: (86-755) 8307 1443, or email: QN.Doccheck@sgs.com

South of No. 6 Plant, No. 1, Runsheng Road, Suzhou Industrial Park, Suzhou Area, China (Jiangsu) Pilot Free Trade Zone 215000 t (86-512) 62992980 www.sgs.com.cn
 中国·苏州·中国(江苏)自由贸易试验区苏州片区苏州工业园区润胜路1号的6号厂房南楼 邮编: 215000 t (86-512) 62992980 sgs.china@sgs.com

| @FCC_RLAN_DFS_SPC_Radar_T5_SP2_Tr22@ | | | | | | | | | | | |
|--------------------------------------|---------|------------|----------|----------|-------------------|-------------------|------------------|------------------|-----------|-----------|-----------|
| TestMode | Channel | Radar Type | Trial ID | Burst ID | Burst Offset (μs) | Chirp Width (MHz) | Number Of Pulses | Pulse Width (μs) | PRI1 (μs) | PRI2 (μs) | PRI3 (μs) |
| 11ax20MIMO | 5500 | Type5 | 22 | 0 | 261858.0 | 20 | 2 | 77.0 | 1191.0 | 1363.0 | --- |
| 11ax20MIMO | 5500 | Type5 | 22 | 1 | 407646.0 | 20 | 1 | 58.1 | 1248.0 | --- | --- |
| 11ax20MIMO | 5500 | Type5 | 22 | 2 | 552319.0 | 20 | 1 | 62.1 | 1836.0 | --- | --- |
| 11ax20MIMO | 5500 | Type5 | 22 | 3 | 99107.0 | 20 | 2 | 76.9 | 1334.0 | 1236.0 | --- |
| 11ax20MIMO | 5500 | Type5 | 22 | 4 | 243514.0 | 20 | 2 | 80.0 | 1914.0 | 1852.0 | --- |
| 11ax20MIMO | 5500 | Type5 | 22 | 5 | 389464.0 | 20 | 1 | 52.0 | 1701.0 | --- | --- |
| 11ax20MIMO | 5500 | Type5 | 22 | 6 | 531093.0 | 20 | 3 | 88.6 | 1693.0 | 1995.0 | 1905.0 |
| 11ax20MIMO | 5500 | Type5 | 22 | 7 | 81159.0 | 20 | 2 | 72.9 | 1922.0 | 1387.0 | --- |
| 11ax20MIMO | 5500 | Type5 | 22 | 8 | 225245.0 | 20 | 3 | 98.5 | 1839.0 | 1746.0 | 1389.0 |
| 11ax20MIMO | 5500 | Type5 | 22 | 9 | 371906.0 | 20 | 1 | 57.9 | 1193.0 | --- | --- |
| 11ax20MIMO | 5500 | Type5 | 22 | 10 | 514197.0 | 20 | 3 | 95.9 | 1659.0 | 1870.0 | 1066.0 |
| 11ax20MIMO | 5500 | Type5 | 22 | 11 | 63561.0 | 20 | 1 | 53.5 | 1162.0 | --- | --- |
| 11ax20MIMO | 5500 | Type5 | 22 | 12 | 207510.0 | 20 | 3 | 92.0 | 1745.0 | 1654.0 | 1458.0 |
| 11ax20MIMO | 5500 | Type5 | 22 | 13 | 353638.0 | 20 | 1 | 57.3 | 1834.0 | --- | --- |
| 11ax20MIMO | 5500 | Type5 | 22 | 14 | 497515.0 | 20 | 2 | 70.5 | 1684.0 | 1586.0 | --- |
| 11ax20MIMO | 5500 | Type5 | 22 | 15 | 45553.0 | 20 | 2 | 70.0 | 1042.0 | 1664.0 | --- |
| 11ax20MIMO | 5500 | Type5 | 22 | 16 | 189821.0 | 20 | 3 | 84.0 | 1765.0 | 1630.0 | 1176.0 |
| 11ax20MIMO | 5500 | Type5 | 22 | 17 | 335330.0 | 20 | 2 | 76.1 | 1557.0 | 1057.0 | --- |
| 11ax20MIMO | 5500 | Type5 | 22 | 18 | 478825.0 | 20 | 3 | 93.2 | 1985.0 | 1018.0 | 1340.0 |
| 11ax20MIMO | 5500 | Type5 | 22 | 19 | 27594.0 | 20 | 3 | 96.8 | 1760.0 | 1614.0 | 1817.0 |
| 11ax40MIMO | 5510 | Type5 | 22 | 0 | 261858.0 | 20 | 2 | 77.0 | 1191.0 | 1363.0 | --- |
| 11ax40MIMO | 5510 | Type5 | 22 | 1 | 407646.0 | 20 | 1 | 58.1 | 1248.0 | --- | --- |
| 11ax40MIMO | 5510 | Type5 | 22 | 2 | 552319.0 | 20 | 1 | 62.1 | 1836.0 | --- | --- |
| 11ax40MIMO | 5510 | Type5 | 22 | 3 | 99107.0 | 20 | 2 | 76.9 | 1334.0 | 1236.0 | --- |
| 11ax40MIMO | 5510 | Type5 | 22 | 4 | 243514.0 | 20 | 2 | 80.0 | 1914.0 | 1852.0 | --- |
| 11ax40MIMO | 5510 | Type5 | 22 | 5 | 389464.0 | 20 | 1 | 52.0 | 1701.0 | --- | --- |
| 11ax40MIMO | 5510 | Type5 | 22 | 6 | 531093.0 | 20 | 3 | 88.6 | 1693.0 | 1995.0 | 1905.0 |
| 11ax40MIMO | 5510 | Type5 | 22 | 7 | 81159.0 | 20 | 2 | 72.9 | 1922.0 | 1387.0 | --- |
| 11ax40MIMO | 5510 | Type5 | 22 | 8 | 225245.0 | 20 | 3 | 98.5 | 1839.0 | 1746.0 | 1389.0 |
| 11ax40MIMO | 5510 | Type5 | 22 | 9 | 371906.0 | 20 | 1 | 57.9 | 1193.0 | --- | --- |
| 11ax40MIMO | 5510 | Type5 | 22 | 10 | 514197.0 | 20 | 3 | 95.9 | 1659.0 | 1870.0 | 1066.0 |
| 11ax40MIMO | 5510 | Type5 | 22 | 11 | 63561.0 | 20 | 1 | 53.5 | 1162.0 | --- | --- |
| 11ax40MIMO | 5510 | Type5 | 22 | 12 | 207510.0 | 20 | 3 | 92.0 | 1745.0 | 1654.0 | 1458.0 |
| 11ax40MIMO | 5510 | Type5 | 22 | 13 | 353638.0 | 20 | 1 | 57.3 | 1834.0 | --- | --- |
| 11ax40MIMO | 5510 | Type5 | 22 | 14 | 497515.0 | 20 | 2 | 70.5 | 1684.0 | 1586.0 | --- |
| 11ax40MIMO | 5510 | Type5 | 22 | 15 | 45553.0 | 20 | 2 | 70.0 | 1042.0 | 1664.0 | --- |
| 11ax40MIMO | 5510 | Type5 | 22 | 16 | 189821.0 | 20 | 3 | 84.0 | 1765.0 | 1630.0 | 1176.0 |
| 11ax40MIMO | 5510 | Type5 | 22 | 17 | 335330.0 | 20 | 2 | 76.1 | 1557.0 | 1057.0 | --- |
| 11ax40MIMO | 5510 | Type5 | 22 | 18 | 478825.0 | 20 | 3 | 93.2 | 1985.0 | 1018.0 | 1340.0 |
| 11ax40MIMO | 5510 | Type5 | 22 | 19 | 27594.0 | 20 | 3 | 96.8 | 1760.0 | 1614.0 | 1817.0 |
| 11ax80MIMO | 5530 | Type5 | 22 | 0 | 261858.0 | 20 | 2 | 77.0 | 1191.0 | 1363.0 | --- |
| 11ax80MIMO | 5530 | Type5 | 22 | 1 | 407646.0 | 20 | 1 | 58.1 | 1248.0 | --- | --- |
| 11ax80MIMO | 5530 | Type5 | 22 | 2 | 552319.0 | 20 | 1 | 62.1 | 1836.0 | --- | --- |
| 11ax80MIMO | 5530 | Type5 | 22 | 3 | 99107.0 | 20 | 2 | 76.9 | 1334.0 | 1236.0 | --- |
| 11ax80MIMO | 5530 | Type5 | 22 | 4 | 243514.0 | 20 | 2 | 80.0 | 1914.0 | 1852.0 | --- |
| 11ax80MIMO | 5530 | Type5 | 22 | 5 | 389464.0 | 20 | 1 | 52.0 | 1701.0 | --- | --- |
| 11ax80MIMO | 5530 | Type5 | 22 | 6 | 531093.0 | 20 | 3 | 88.6 | 1693.0 | 1995.0 | 1905.0 |
| 11ax80MIMO | 5530 | Type5 | 22 | 7 | 81159.0 | 20 | 2 | 72.9 | 1922.0 | 1387.0 | --- |
| 11ax80MIMO | 5530 | Type5 | 22 | 8 | 225245.0 | 20 | 3 | 98.5 | 1839.0 | 1746.0 | 1389.0 |
| 11ax80MIMO | 5530 | Type5 | 22 | 9 | 371906.0 | 20 | 1 | 57.9 | 1193.0 | --- | --- |
| 11ax80MIMO | 5530 | Type5 | 22 | 10 | 514197.0 | 20 | 3 | 95.9 | 1659.0 | 1870.0 | 1066.0 |
| 11ax80MIMO | 5530 | Type5 | 22 | 11 | 63561.0 | 20 | 1 | 53.5 | 1162.0 | --- | --- |
| 11ax80MIMO | 5530 | Type5 | 22 | 12 | 207510.0 | 20 | 3 | 92.0 | 1745.0 | 1654.0 | 1458.0 |
| 11ax80MIMO | 5530 | Type5 | 22 | 13 | 353638.0 | 20 | 1 | 57.3 | 1834.0 | --- | --- |
| 11ax80MIMO | 5530 | Type5 | 22 | 14 | 497515.0 | 20 | 2 | 70.5 | 1684.0 | 1586.0 | --- |
| 11ax80MIMO | 5530 | Type5 | 22 | 15 | 45553.0 | 20 | 2 | 70.0 | 1042.0 | 1664.0 | --- |
| 11ax80MIMO | 5530 | Type5 | 22 | 16 | 189821.0 | 20 | 3 | 84.0 | 1765.0 | 1630.0 | 1176.0 |
| 11ax80MIMO | 5530 | Type5 | 22 | 17 | 335330.0 | 20 | 2 | 76.1 | 1557.0 | 1057.0 | --- |



Unless otherwise agreed in writing, this document is issued by the Company subject to its General Conditions of Service printed overleaf, available on request or accessible at <http://www.sgs.com/en/Terms-and-Conditions.aspx> and, for electronic format documents, subject to Terms and Conditions for Electronic Documents at <http://www.sgs.com/en/Terms-and-Conditions/Terms-e-Documents.aspx>. Attention is drawn to the limitation of liability, indemnification and jurisdiction issues defined therein. Any holder of this document is advised that information contained hereon reflects the Company's findings only and within the limits of Client's instructions, if any. The Company's sole responsibility is to its Client and this document does not exonerate parties to a transaction from exercising all their rights and obligations under the transaction documents. This document cannot be reproduced except in full, without prior written approval of the Company. Any unauthorized alteration, forgery or falsification of the content or appearance of this document is unlawful and offenders may be prosecuted to the fullest extent of the law. Unless otherwise stated the results shown in this test report refer only to the sample(s) tested and such sample(s) are retained for 30 days only.

Attention: To check the authenticity of testing/inspection report & certificate, please contact us at telephone: (86-755) 8307 1443, or email: CN_Doccheck@sgs.com
 South of No. 6 Plant, No. 1, Runsheng Road, Suzhou Industrial Park, Suzhou Area, China (Jiangsu) Pilot Free Trade Zone 215000 t (86-512) 62992980 www.sgs.com.cn
 中国·苏州·中国（江苏）自由贸易试验区苏州片区苏州工业园区润胜路1号的6号厂房南楼 邮编：215000 t (86-512) 62992980 sgs.china@sgs.com

| | | | | | | | | | | | |
|-------------|------|-------|----|----|----------|----|---|------|--------|--------|--------|
| 11ax80MIMO | 5530 | Type5 | 22 | 18 | 478825.0 | 20 | 3 | 93.2 | 1985.0 | 1018.0 | 1340.0 |
| 11ax80MIMO | 5530 | Type5 | 22 | 19 | 27594.0 | 20 | 3 | 96.8 | 1760.0 | 1614.0 | 1817.0 |
| 11ax160MIMO | 5570 | Type5 | 22 | 0 | 261858.0 | 20 | 2 | 77.0 | 1191.0 | 1363.0 | --- |
| 11ax160MIMO | 5570 | Type5 | 22 | 1 | 407646.0 | 20 | 1 | 58.1 | 1248.0 | --- | --- |
| 11ax160MIMO | 5570 | Type5 | 22 | 2 | 552319.0 | 20 | 1 | 62.1 | 1836.0 | --- | --- |
| 11ax160MIMO | 5570 | Type5 | 22 | 3 | 99107.0 | 20 | 2 | 76.9 | 1334.0 | 1236.0 | --- |
| 11ax160MIMO | 5570 | Type5 | 22 | 4 | 243514.0 | 20 | 2 | 80.0 | 1914.0 | 1852.0 | --- |
| 11ax160MIMO | 5570 | Type5 | 22 | 5 | 389464.0 | 20 | 1 | 52.0 | 1701.0 | --- | --- |
| 11ax160MIMO | 5570 | Type5 | 22 | 6 | 531093.0 | 20 | 3 | 88.6 | 1693.0 | 1995.0 | 1905.0 |
| 11ax160MIMO | 5570 | Type5 | 22 | 7 | 81159.0 | 20 | 2 | 72.9 | 1922.0 | 1387.0 | --- |
| 11ax160MIMO | 5570 | Type5 | 22 | 8 | 225245.0 | 20 | 3 | 98.5 | 1839.0 | 1746.0 | 1389.0 |
| 11ax160MIMO | 5570 | Type5 | 22 | 9 | 371906.0 | 20 | 1 | 57.9 | 1193.0 | --- | --- |
| 11ax160MIMO | 5570 | Type5 | 22 | 10 | 514197.0 | 20 | 3 | 95.9 | 1659.0 | 1870.0 | 1066.0 |
| 11ax160MIMO | 5570 | Type5 | 22 | 11 | 63561.0 | 20 | 1 | 53.5 | 1162.0 | --- | --- |
| 11ax160MIMO | 5570 | Type5 | 22 | 12 | 207510.0 | 20 | 3 | 92.0 | 1745.0 | 1654.0 | 1458.0 |
| 11ax160MIMO | 5570 | Type5 | 22 | 13 | 353638.0 | 20 | 1 | 57.3 | 1834.0 | --- | --- |
| 11ax160MIMO | 5570 | Type5 | 22 | 14 | 497515.0 | 20 | 2 | 70.5 | 1684.0 | 1586.0 | --- |
| 11ax160MIMO | 5570 | Type5 | 22 | 15 | 45553.0 | 20 | 2 | 70.0 | 1042.0 | 1664.0 | --- |
| 11ax160MIMO | 5570 | Type5 | 22 | 16 | 189821.0 | 20 | 3 | 84.0 | 1765.0 | 1630.0 | 1176.0 |
| 11ax160MIMO | 5570 | Type5 | 22 | 17 | 335330.0 | 20 | 2 | 76.1 | 1557.0 | 1057.0 | --- |
| 11ax160MIMO | 5570 | Type5 | 22 | 18 | 478825.0 | 20 | 3 | 93.2 | 1985.0 | 1018.0 | 1340.0 |
| 11ax160MIMO | 5570 | Type5 | 22 | 19 | 27594.0 | 20 | 3 | 96.8 | 1760.0 | 1614.0 | 1817.0 |



Unless otherwise agreed in writing, this document is issued by the Company subject to its General Conditions of Service printed overleaf, available on request or accessible at <http://www.sgs.com/en/Terms-and-Conditions.aspx> and, for electronic format documents, subject to Terms and Conditions for Electronic Documents at <http://www.sgs.com/en/Terms-and-Conditions/Terms-e-Documents.aspx>. Attention is drawn to the limitation of liability, indemnification and jurisdiction issues defined therein. Any holder of this document is advised that information contained hereon reflects the Company's findings at the time of its intervention only and within the limits of Client's instructions, if any. The Company's sole responsibility is to its Client and this document does not exonerate parties to a transaction from exercising all their rights and obligations under the transaction documents. This document cannot be reproduced except in full, without prior written approval of the Company. Any unauthorized alteration, forgery or falsification of the content or appearance of this document is unlawful and offenders may be prosecuted to the fullest extent of the law. Unless otherwise stated the results shown in this test report refer only to the sample(s) tested and such sample(s) are retained for 30 days only.

Attention: To check the authenticity of testing / inspection report & certificate, please contact us at telephone: (86-755) 8307 1443, or email: CN.Doccheck@sgs.com

| @FCC_RLAN_DFS_SPC_Radar_T5_SP2_Tr23@ | | | | | | | | | | | |
|--------------------------------------|---------|------------|----------|----------|-------------------|-------------------|------------------|------------------|-----------|-----------|-----------|
| TestMode | Channel | Radar Type | Trial ID | Burst ID | Burst Offset (μs) | Chirp Width (MHz) | Number Of Pulses | Pulse Width (μs) | PRI1 (μs) | PRI2 (μs) | PRI3 (μs) |
| 11ax20MIMO | 5500 | Type5 | 23 | 0 | 247117.0 | 12 | 1 | 50.1 | 1841.0 | --- | --- |
| 11ax20MIMO | 5500 | Type5 | 23 | 1 | 453362.0 | 12 | 3 | 93.5 | 1590.0 | 1081.0 | 1413.0 |
| 11ax20MIMO | 5500 | Type5 | 23 | 2 | 660875.0 | 12 | 2 | 68.8 | 1707.0 | 1577.0 | --- |
| 11ax20MIMO | 5500 | Type5 | 23 | 3 | 14140.0 | 12 | 1 | 56.3 | 1056.0 | --- | --- |
| 11ax20MIMO | 5500 | Type5 | 23 | 4 | 220734.0 | 12 | 3 | 86.0 | 1953.0 | 1108.0 | 1987.0 |
| 11ax20MIMO | 5500 | Type5 | 23 | 5 | 428367.0 | 12 | 2 | 75.2 | 1572.0 | 1536.0 | --- |
| 11ax20MIMO | 5500 | Type5 | 23 | 6 | 636681.0 | 12 | 1 | 54.4 | 1517.0 | --- | --- |
| 11ax20MIMO | 5500 | Type5 | 23 | 7 | 843157.0 | 12 | 2 | 71.1 | 1329.0 | 1243.0 | --- |
| 11ax20MIMO | 5500 | Type5 | 23 | 8 | 195585.0 | 12 | 2 | 76.2 | 1940.0 | 1770.0 | --- |
| 11ax20MIMO | 5500 | Type5 | 23 | 9 | 403231.0 | 12 | 2 | 80.2 | 1098.0 | 1209.0 | --- |
| 11ax20MIMO | 5500 | Type5 | 23 | 10 | 610202.0 | 12 | 2 | 79.7 | 1588.0 | 1214.0 | --- |
| 11ax20MIMO | 5500 | Type5 | 23 | 11 | 815229.0 | 12 | 3 | 90.9 | 1615.0 | 1862.0 | 1601.0 |
| 11ax20MIMO | 5500 | Type5 | 23 | 12 | 170267.0 | 12 | 2 | 68.7 | 1377.0 | 1441.0 | --- |
| 11ax20MIMO | 5500 | Type5 | 23 | 13 | 377306.0 | 12 | 2 | 67.4 | 1872.0 | 1313.0 | --- |
| 11ax40MIMO | 5510 | Type5 | 23 | 0 | 247117.0 | 12 | 1 | 50.1 | 1841.0 | --- | --- |
| 11ax40MIMO | 5510 | Type5 | 23 | 1 | 453362.0 | 12 | 3 | 93.5 | 1590.0 | 1081.0 | 1413.0 |
| 11ax40MIMO | 5510 | Type5 | 23 | 2 | 660875.0 | 12 | 2 | 68.8 | 1707.0 | 1577.0 | --- |
| 11ax40MIMO | 5510 | Type5 | 23 | 3 | 14140.0 | 12 | 1 | 56.3 | 1056.0 | --- | --- |
| 11ax40MIMO | 5510 | Type5 | 23 | 4 | 220734.0 | 12 | 3 | 86.0 | 1953.0 | 1108.0 | 1987.0 |
| 11ax40MIMO | 5510 | Type5 | 23 | 5 | 428367.0 | 12 | 2 | 75.2 | 1572.0 | 1536.0 | --- |
| 11ax40MIMO | 5510 | Type5 | 23 | 6 | 636681.0 | 12 | 1 | 54.4 | 1517.0 | --- | --- |
| 11ax40MIMO | 5510 | Type5 | 23 | 7 | 843157.0 | 12 | 2 | 71.1 | 1329.0 | 1243.0 | --- |
| 11ax40MIMO | 5510 | Type5 | 23 | 8 | 195585.0 | 12 | 2 | 76.2 | 1940.0 | 1770.0 | --- |
| 11ax40MIMO | 5510 | Type5 | 23 | 9 | 403231.0 | 12 | 2 | 80.2 | 1098.0 | 1209.0 | --- |
| 11ax40MIMO | 5510 | Type5 | 23 | 10 | 610202.0 | 12 | 2 | 79.7 | 1588.0 | 1214.0 | --- |
| 11ax40MIMO | 5510 | Type5 | 23 | 11 | 815229.0 | 12 | 3 | 90.9 | 1615.0 | 1862.0 | 1601.0 |
| 11ax40MIMO | 5510 | Type5 | 23 | 12 | 170267.0 | 12 | 2 | 68.7 | 1377.0 | 1441.0 | --- |
| 11ax40MIMO | 5510 | Type5 | 23 | 13 | 377306.0 | 12 | 2 | 67.4 | 1872.0 | 1313.0 | --- |
| 11ax80MIMO | 5530 | Type5 | 23 | 0 | 247117.0 | 12 | 1 | 50.1 | 1841.0 | --- | --- |
| 11ax80MIMO | 5530 | Type5 | 23 | 1 | 453362.0 | 12 | 3 | 93.5 | 1590.0 | 1081.0 | 1413.0 |
| 11ax80MIMO | 5530 | Type5 | 23 | 2 | 660875.0 | 12 | 2 | 68.8 | 1707.0 | 1577.0 | --- |
| 11ax80MIMO | 5530 | Type5 | 23 | 3 | 14140.0 | 12 | 1 | 56.3 | 1056.0 | --- | --- |
| 11ax80MIMO | 5530 | Type5 | 23 | 4 | 220734.0 | 12 | 3 | 86.0 | 1953.0 | 1108.0 | 1987.0 |
| 11ax80MIMO | 5530 | Type5 | 23 | 5 | 428367.0 | 12 | 2 | 75.2 | 1572.0 | 1536.0 | --- |
| 11ax80MIMO | 5530 | Type5 | 23 | 6 | 636681.0 | 12 | 1 | 54.4 | 1517.0 | --- | --- |
| 11ax80MIMO | 5530 | Type5 | 23 | 7 | 843157.0 | 12 | 2 | 71.1 | 1329.0 | 1243.0 | --- |
| 11ax80MIMO | 5530 | Type5 | 23 | 8 | 195585.0 | 12 | 2 | 76.2 | 1940.0 | 1770.0 | --- |
| 11ax80MIMO | 5530 | Type5 | 23 | 9 | 403231.0 | 12 | 2 | 80.2 | 1098.0 | 1209.0 | --- |
| 11ax80MIMO | 5530 | Type5 | 23 | 10 | 610202.0 | 12 | 2 | 79.7 | 1588.0 | 1214.0 | --- |
| 11ax80MIMO | 5530 | Type5 | 23 | 11 | 815229.0 | 12 | 3 | 90.9 | 1615.0 | 1862.0 | 1601.0 |
| 11ax80MIMO | 5530 | Type5 | 23 | 12 | 170267.0 | 12 | 2 | 68.7 | 1377.0 | 1441.0 | --- |
| 11ax80MIMO | 5530 | Type5 | 23 | 13 | 377306.0 | 12 | 2 | 67.4 | 1872.0 | 1313.0 | --- |
| 11ax160MIMO | 5570 | Type5 | 23 | 0 | 247117.0 | 12 | 1 | 50.1 | 1841.0 | --- | --- |
| 11ax160MIMO | 5570 | Type5 | 23 | 1 | 453362.0 | 12 | 3 | 93.5 | 1590.0 | 1081.0 | 1413.0 |
| 11ax160MIMO | 5570 | Type5 | 23 | 2 | 660875.0 | 12 | 2 | 68.8 | 1707.0 | 1577.0 | --- |
| 11ax160MIMO | 5570 | Type5 | 23 | 3 | 14140.0 | 12 | 1 | 56.3 | 1056.0 | --- | --- |
| 11ax160MIMO | 5570 | Type5 | 23 | 4 | 220734.0 | 12 | 3 | 86.0 | 1953.0 | 1108.0 | 1987.0 |
| 11ax160MIMO | 5570 | Type5 | 23 | 5 | 428367.0 | 12 | 2 | 75.2 | 1572.0 | 1536.0 | --- |
| 11ax160MIMO | 5570 | Type5 | 23 | 6 | 636681.0 | 12 | 1 | 54.4 | 1517.0 | --- | --- |
| 11ax160MIMO | 5570 | Type5 | 23 | 7 | 843157.0 | 12 | 2 | 71.1 | 1329.0 | 1243.0 | --- |
| 11ax160MIMO | 5570 | Type5 | 23 | 8 | 195585.0 | 12 | 2 | 76.2 | 1940.0 | 1770.0 | --- |
| 11ax160MIMO | 5570 | Type5 | 23 | 9 | 403231.0 | 12 | 2 | 80.2 | 1098.0 | 1209.0 | --- |
| 11ax160MIMO | 5570 | Type5 | 23 | 10 | 610202.0 | 12 | 2 | 79.7 | 1588.0 | 1214.0 | --- |
| 11ax160MIMO | 5570 | Type5 | 23 | 11 | 815229.0 | 12 | 3 | 90.9 | 1615.0 | 1862.0 | 1601.0 |
| 11ax160MIMO | 5570 | Type5 | 23 | 12 | 170267.0 | 12 | 2 | 68.7 | 1377.0 | 1441.0 | --- |
| 11ax160MIMO | 5570 | Type5 | 23 | 13 | 377306.0 | 12 | 2 | 67.4 | 1872.0 | 1313.0 | --- |



Unless otherwise agreed in writing, this document is issued by the Company subject to its General Conditions of Service printed overleaf, available on request or accessible at <http://www.sgs.com/en/Terms-and-Conditions.aspx> and, for electronic format documents, subject to Terms and Conditions for Electronic Documents at <http://www.sgs.com/en/Terms-and-Conditions/Terms-e-Documents.aspx>. Attention is drawn to the limitation of liability, indemnification and jurisdiction issues defined therein. Any holder of this document is advised that information contained hereon reflects the Company's findings at the time of its intervention only and within the limits of Client's instructions, if any. The Company's sole responsibility is to its Client and this document does not exonerate parties to a transaction from exercising all their rights and obligations under the transaction documents. This document cannot be reproduced except in full, without prior written approval of the Company. Any unauthorized alteration, forgery or falsification of the content or appearance of this document is unlawful and offenders may be prosecuted to the fullest extent of the law. Unless otherwise stated the results shown in this test report refer only to the sample(s) tested and such sample(s) are retained for 30 days only.

Attention: To check the authenticity of testing/inspection report & certificate, please contact us at telephone: (86-755) 8307 1443, or email: CN.Doccheck@sgs.com
 South of No. 6 Plant, No. 1, Runsheng Road, Suzhou Industrial Park, Suzhou Area, China (Jiangsu) Pilot Free Trade Zone 215000 t (86-512) 62992980 www.sgs.com.cn
 中国·苏州·中国(江苏)自由贸易试验区苏州片区苏州工业园区润胜路1号的6号厂房南座 邮编: 215000 t (86-512) 62992980 sgs.china@sgs.com

@FCC_RLAN_DFS_SPC_Radar_T5_SP2_Tr24@

| TestMode | Channel | Radar Type | Trial ID | Burst ID | Burst Offset (µs) | Chirp Width (MHz) | Number Of Pulses | Pulse Width (µs) | PRI1 (µs) | PRI2 (µs) | PRI3 (µs) |
|-------------|---------|------------|----------|----------|-------------------|-------------------|------------------|------------------|-----------|-----------|-----------|
| 11ax20MIMO | 5500 | Type5 | 24 | 0 | 628071.0 | 11 | 3 | 94.0 | 1643.0 | 1748.0 | 1941.0 |
| 11ax20MIMO | 5500 | Type5 | 24 | 1 | 853391.0 | 11 | 2 | 70.8 | 1177.0 | 1201.0 | --- |
| 11ax20MIMO | 5500 | Type5 | 24 | 2 | 156223.0 | 11 | 1 | 56.3 | 1006.0 | --- | --- |
| 11ax20MIMO | 5500 | Type5 | 24 | 3 | 378734.0 | 11 | 3 | 96.7 | 1230.0 | 1163.0 | 1332.0 |
| 11ax20MIMO | 5500 | Type5 | 24 | 4 | 601331.0 | 11 | 3 | 90.6 | 1217.0 | 1582.0 | 1498.0 |
| 11ax20MIMO | 5500 | Type5 | 24 | 5 | 825462.0 | 11 | 2 | 74.5 | 1569.0 | 1281.0 | --- |
| 11ax20MIMO | 5500 | Type5 | 24 | 6 | 128265.0 | 11 | 3 | 92.6 | 1065.0 | 1669.0 | 1222.0 |
| 11ax20MIMO | 5500 | Type5 | 24 | 7 | 351161.0 | 11 | 3 | 89.0 | 1493.0 | 1135.0 | 1380.0 |
| 11ax20MIMO | 5500 | Type5 | 24 | 8 | 573425.0 | 11 | 3 | 96.5 | 1607.0 | 1822.0 | 1602.0 |
| 11ax20MIMO | 5500 | Type5 | 24 | 9 | 798431.0 | 11 | 2 | 70.5 | 1141.0 | 1178.0 | --- |
| 11ax20MIMO | 5500 | Type5 | 24 | 10 | 100737.0 | 11 | 3 | 94.0 | 1009.0 | 1629.0 | 1956.0 |
| 11ax20MIMO | 5500 | Type5 | 24 | 11 | 324661.0 | 11 | 1 | 55.8 | 1290.0 | --- | --- |
| 11ax20MIMO | 5500 | Type5 | 24 | 12 | 546278.0 | 11 | 3 | 87.7 | 1435.0 | 1963.0 | 1164.0 |
| 11ax40MIMO | 5510 | Type5 | 24 | 0 | 628071.0 | 11 | 3 | 94.0 | 1643.0 | 1748.0 | 1941.0 |
| 11ax40MIMO | 5510 | Type5 | 24 | 1 | 853391.0 | 11 | 2 | 70.8 | 1177.0 | 1201.0 | --- |
| 11ax40MIMO | 5510 | Type5 | 24 | 2 | 156223.0 | 11 | 1 | 56.3 | 1006.0 | --- | --- |
| 11ax40MIMO | 5510 | Type5 | 24 | 3 | 378734.0 | 11 | 3 | 96.7 | 1230.0 | 1163.0 | 1332.0 |
| 11ax40MIMO | 5510 | Type5 | 24 | 4 | 601331.0 | 11 | 3 | 90.6 | 1217.0 | 1582.0 | 1498.0 |
| 11ax40MIMO | 5510 | Type5 | 24 | 5 | 825462.0 | 11 | 2 | 74.5 | 1569.0 | 1281.0 | --- |
| 11ax40MIMO | 5510 | Type5 | 24 | 6 | 128265.0 | 11 | 3 | 92.6 | 1065.0 | 1669.0 | 1222.0 |
| 11ax40MIMO | 5510 | Type5 | 24 | 7 | 351161.0 | 11 | 3 | 89.0 | 1493.0 | 1135.0 | 1380.0 |
| 11ax40MIMO | 5510 | Type5 | 24 | 8 | 573425.0 | 11 | 3 | 96.5 | 1607.0 | 1822.0 | 1602.0 |
| 11ax40MIMO | 5510 | Type5 | 24 | 9 | 798431.0 | 11 | 2 | 70.5 | 1141.0 | 1178.0 | --- |
| 11ax40MIMO | 5510 | Type5 | 24 | 10 | 100737.0 | 11 | 3 | 94.0 | 1009.0 | 1629.0 | 1956.0 |
| 11ax40MIMO | 5510 | Type5 | 24 | 11 | 324661.0 | 11 | 1 | 55.8 | 1290.0 | --- | --- |
| 11ax40MIMO | 5510 | Type5 | 24 | 12 | 546278.0 | 11 | 3 | 87.7 | 1435.0 | 1963.0 | 1164.0 |
| 11ax80MIMO | 5530 | Type5 | 24 | 0 | 628071.0 | 11 | 3 | 94.0 | 1643.0 | 1748.0 | 1941.0 |
| 11ax80MIMO | 5530 | Type5 | 24 | 1 | 853391.0 | 11 | 2 | 70.8 | 1177.0 | 1201.0 | --- |
| 11ax80MIMO | 5530 | Type5 | 24 | 2 | 156223.0 | 11 | 1 | 56.3 | 1006.0 | --- | --- |
| 11ax80MIMO | 5530 | Type5 | 24 | 3 | 378734.0 | 11 | 3 | 96.7 | 1230.0 | 1163.0 | 1332.0 |
| 11ax80MIMO | 5530 | Type5 | 24 | 4 | 601331.0 | 11 | 3 | 90.6 | 1217.0 | 1582.0 | 1498.0 |
| 11ax80MIMO | 5530 | Type5 | 24 | 5 | 825462.0 | 11 | 2 | 74.5 | 1569.0 | 1281.0 | --- |
| 11ax80MIMO | 5530 | Type5 | 24 | 6 | 128265.0 | 11 | 3 | 92.6 | 1065.0 | 1669.0 | 1222.0 |
| 11ax80MIMO | 5530 | Type5 | 24 | 7 | 351161.0 | 11 | 3 | 89.0 | 1493.0 | 1135.0 | 1380.0 |
| 11ax80MIMO | 5530 | Type5 | 24 | 8 | 573425.0 | 11 | 3 | 96.5 | 1607.0 | 1822.0 | 1602.0 |
| 11ax80MIMO | 5530 | Type5 | 24 | 9 | 798431.0 | 11 | 2 | 70.5 | 1141.0 | 1178.0 | --- |
| 11ax80MIMO | 5530 | Type5 | 24 | 10 | 100737.0 | 11 | 3 | 94.0 | 1009.0 | 1629.0 | 1956.0 |
| 11ax80MIMO | 5530 | Type5 | 24 | 11 | 324661.0 | 11 | 1 | 55.8 | 1290.0 | --- | --- |
| 11ax80MIMO | 5530 | Type5 | 24 | 12 | 546278.0 | 11 | 3 | 87.7 | 1435.0 | 1963.0 | 1164.0 |
| 11ax160MIMO | 5570 | Type5 | 24 | 0 | 628071.0 | 11 | 3 | 94.0 | 1643.0 | 1748.0 | 1941.0 |
| 11ax160MIMO | 5570 | Type5 | 24 | 1 | 853391.0 | 11 | 2 | 70.8 | 1177.0 | 1201.0 | --- |
| 11ax160MIMO | 5570 | Type5 | 24 | 2 | 156223.0 | 11 | 1 | 56.3 | 1006.0 | --- | --- |
| 11ax160MIMO | 5570 | Type5 | 24 | 3 | 378734.0 | 11 | 3 | 96.7 | 1230.0 | 1163.0 | 1332.0 |
| 11ax160MIMO | 5570 | Type5 | 24 | 4 | 601331.0 | 11 | 3 | 90.6 | 1217.0 | 1582.0 | 1498.0 |
| 11ax160MIMO | 5570 | Type5 | 24 | 5 | 825462.0 | 11 | 2 | 74.5 | 1569.0 | 1281.0 | --- |
| 11ax160MIMO | 5570 | Type5 | 24 | 6 | 128265.0 | 11 | 3 | 92.6 | 1065.0 | 1669.0 | 1222.0 |
| 11ax160MIMO | 5570 | Type5 | 24 | 7 | 351161.0 | 11 | 3 | 89.0 | 1493.0 | 1135.0 | 1380.0 |
| 11ax160MIMO | 5570 | Type5 | 24 | 8 | 573425.0 | 11 | 3 | 96.5 | 1607.0 | 1822.0 | 1602.0 |
| 11ax160MIMO | 5570 | Type5 | 24 | 9 | 798431.0 | 11 | 2 | 70.5 | 1141.0 | 1178.0 | --- |
| 11ax160MIMO | 5570 | Type5 | 24 | 10 | 100737.0 | 11 | 3 | 94.0 | 1009.0 | 1629.0 | 1956.0 |
| 11ax160MIMO | 5570 | Type5 | 24 | 11 | 324661.0 | 11 | 1 | 55.8 | 1290.0 | --- | --- |
| 11ax160MIMO | 5570 | Type5 | 24 | 12 | 546278.0 | 11 | 3 | 87.7 | 1435.0 | 1963.0 | 1164.0 |



Unless otherwise agreed in writing, this document is issued by the Company subject to its General Conditions of Service printed overleaf, available on request or accessible at <http://www.sgs.com/en/Terms-and-Conditions.aspx> and, for electronic format documents, subject to Terms and Conditions for Electronic Documents at <http://www.sgs.com/en/Terms-and-Conditions/Terms-e-Documents.aspx>. Attention is drawn to the limitation of liability, indemnification and jurisdiction issues defined therein. Any holder of this document is advised that information contained hereon reflects the Company's findings at the time of its intervention only and within the limits of Client's instructions, if any. The Company's sole responsibility is to its Client and this document does not exonerate parties to a transaction from exercising all their rights and obligations under the transaction documents. This document cannot be reproduced except in full, without prior written approval of the Company. Any unauthorized alteration, forgery or falsification of the content or appearance of this document is unlawful and offenders may be prosecuted to the fullest extent of the law. Unless otherwise stated the results shown in this test report refer only to the sample(s) tested and such sample(s) are retained for 30 days only.

Attention: To check the authenticity of testing/inspection report & certificate, please contact us at telephone: (86-755) 8307 1443, or email: QI.Doccheck@sgs.com
 South of No. 6 Plant, No. 1, Runsheng Road, Suzhou Industrial Park, Suzhou Area, China (Jiangsu) Pilot Free Trade Zone 215000 t (86-512) 62992980 www.sgs.com.cn
 中国·苏州·中国(江苏)自由贸易试验区苏州片区苏州工业园区润胜路1号的6号厂房南座 邮编: 215000 t (86-512) 62992980 sgs.china@sgs.com

| @FCC_RLAN_DFS_SPC_Radar_T5_SP2_Tr25@ | | | | | | | | | | | |
|--------------------------------------|---------|------------|----------|----------|-------------------|-------------------|------------------|------------------|-----------|-----------|-----------|
| TestMode | Channel | Radar Type | Trial ID | Burst ID | Burst Offset (μs) | Chirp Width (MHz) | Number Of Pulses | Pulse Width (μs) | PRI1 (μs) | PRI2 (μs) | PRI3 (μs) |
| 11ax20MIMO | 5500 | Type5 | 25 | 0 | 1253842.0 | 5 | 2 | 68.6 | 1306.0 | 1161.0 | --- |
| 11ax20MIMO | 5500 | Type5 | 25 | 1 | 119486.0 | 5 | 2 | 83.1 | 1420.0 | 1315.0 | --- |
| 11ax20MIMO | 5500 | Type5 | 25 | 2 | 482958.0 | 5 | 1 | 60.9 | 1687.0 | --- | --- |
| 11ax20MIMO | 5500 | Type5 | 25 | 3 | 845641.0 | 5 | 2 | 77.7 | 1776.0 | 1158.0 | --- |
| 11ax20MIMO | 5500 | Type5 | 25 | 4 | 1208428.0 | 5 | 2 | 77.4 | 1793.0 | 1510.0 | --- |
| 11ax20MIMO | 5500 | Type5 | 25 | 5 | 74748.0 | 5 | 2 | 66.8 | 1576.0 | 1323.0 | --- |
| 11ax20MIMO | 5500 | Type5 | 25 | 6 | 438300.0 | 5 | 1 | 63.7 | 1333.0 | --- | --- |
| 11ax20MIMO | 5500 | Type5 | 25 | 7 | 800152.0 | 5 | 3 | 91.2 | 1409.0 | 1681.0 | 1275.0 |
| 11ax40MIMO | 5510 | Type5 | 25 | 0 | 1253842.0 | 5 | 2 | 68.6 | 1306.0 | 1161.0 | --- |
| 11ax40MIMO | 5510 | Type5 | 25 | 1 | 119486.0 | 5 | 2 | 83.1 | 1420.0 | 1315.0 | --- |
| 11ax40MIMO | 5510 | Type5 | 25 | 2 | 482958.0 | 5 | 1 | 60.9 | 1687.0 | --- | --- |
| 11ax40MIMO | 5510 | Type5 | 25 | 3 | 845641.0 | 5 | 2 | 77.7 | 1776.0 | 1158.0 | --- |
| 11ax40MIMO | 5510 | Type5 | 25 | 4 | 1208428.0 | 5 | 2 | 77.4 | 1793.0 | 1510.0 | --- |
| 11ax40MIMO | 5510 | Type5 | 25 | 5 | 74748.0 | 5 | 2 | 66.8 | 1576.0 | 1323.0 | --- |
| 11ax40MIMO | 5510 | Type5 | 25 | 6 | 438300.0 | 5 | 1 | 63.7 | 1333.0 | --- | --- |
| 11ax40MIMO | 5510 | Type5 | 25 | 7 | 800152.0 | 5 | 3 | 91.2 | 1409.0 | 1681.0 | 1275.0 |
| 11ax80MIMO | 5530 | Type5 | 25 | 0 | 1253842.0 | 5 | 2 | 68.6 | 1306.0 | 1161.0 | --- |
| 11ax80MIMO | 5530 | Type5 | 25 | 1 | 119486.0 | 5 | 2 | 83.1 | 1420.0 | 1315.0 | --- |
| 11ax80MIMO | 5530 | Type5 | 25 | 2 | 482958.0 | 5 | 1 | 60.9 | 1687.0 | --- | --- |
| 11ax80MIMO | 5530 | Type5 | 25 | 3 | 845641.0 | 5 | 2 | 77.7 | 1776.0 | 1158.0 | --- |
| 11ax80MIMO | 5530 | Type5 | 25 | 4 | 1208428.0 | 5 | 2 | 77.4 | 1793.0 | 1510.0 | --- |
| 11ax80MIMO | 5530 | Type5 | 25 | 5 | 74748.0 | 5 | 2 | 66.8 | 1576.0 | 1323.0 | --- |
| 11ax80MIMO | 5530 | Type5 | 25 | 6 | 438300.0 | 5 | 1 | 63.7 | 1333.0 | --- | --- |
| 11ax80MIMO | 5530 | Type5 | 25 | 7 | 800152.0 | 5 | 3 | 91.2 | 1409.0 | 1681.0 | 1275.0 |
| 11ax160MIMO | 5570 | Type5 | 25 | 0 | 1253842.0 | 5 | 2 | 68.6 | 1306.0 | 1161.0 | --- |
| 11ax160MIMO | 5570 | Type5 | 25 | 1 | 119486.0 | 5 | 2 | 83.1 | 1420.0 | 1315.0 | --- |
| 11ax160MIMO | 5570 | Type5 | 25 | 2 | 482958.0 | 5 | 1 | 60.9 | 1687.0 | --- | --- |
| 11ax160MIMO | 5570 | Type5 | 25 | 3 | 845641.0 | 5 | 2 | 77.7 | 1776.0 | 1158.0 | --- |
| 11ax160MIMO | 5570 | Type5 | 25 | 4 | 1208428.0 | 5 | 2 | 77.4 | 1793.0 | 1510.0 | --- |
| 11ax160MIMO | 5570 | Type5 | 25 | 5 | 74748.0 | 5 | 2 | 66.8 | 1576.0 | 1323.0 | --- |
| 11ax160MIMO | 5570 | Type5 | 25 | 6 | 438300.0 | 5 | 1 | 63.7 | 1333.0 | --- | --- |
| 11ax160MIMO | 5570 | Type5 | 25 | 7 | 800152.0 | 5 | 3 | 91.2 | 1409.0 | 1681.0 | 1275.0 |



Unless otherwise agreed in writing, this document is issued by the Company subject to its General Conditions of Service printed overleaf, available on request or accessible at <http://www.sgs.com/en/Terms-and-Conditions.aspx> and, for electronic format documents, subject to Terms and Conditions for Electronic Documents at <http://www.sgs.com/en/Terms-and-Conditions/Terms-e-Documents.aspx>. Attention is drawn to the limitation of liability, indemnification and jurisdiction issues defined therein. Any holder of this document is advised that information contained hereon reflects the Company's findings at the time of its intervention only and within the limits of Client's instructions, if any. The Company's sole responsibility is to its Client and this document does not exonerate parties to a transaction from exercising all their rights and obligations under the transaction documents. This document cannot be reproduced except in full, without prior written approval of the Company. Any unauthorized alteration, forgery or falsification of the content or appearance of this document is unlawful and offenders may be prosecuted to the fullest extent of the law. Unless otherwise stated the results shown in this test report refer only to the sample(s) tested and such sample(s) are retained for 30 days only.

Attention: To check the authenticity of testing /inspection report & certificate, please contact us at telephone: (86-755) 8307 1443, or email: QN.Doccheck@sgs.com

South of No. 6 Plant, No. 1, Runsheng Road, Suzhou Industrial Park, Suzhou Area, China (Jiangsu) Pilot Free Trade Zone 215000 t (86-512) 62992980 www.sgs.com.cn
 中国·苏州·中国 (江苏) 自由贸易试验区苏州片区苏州工业园区润胜路1号的6号厂房南楼 邮编: 215000 t (86-512) 62992980 sgs.china@sgs.com

| @FCC_RLAN_DFS_SPC_Radar_T5_SP2_Tr26@ | | | | | | | | | | | |
|--------------------------------------|---------|------------|----------|----------|-------------------|-------------------|------------------|------------------|-----------|-----------|-----------|
| TestMode | Channel | Radar Type | Trial ID | Burst ID | Burst Offset (μs) | Chirp Width (MHz) | Number Of Pulses | Pulse Width (μs) | PRI1 (μs) | PRI2 (μs) | PRI3 (μs) |
| 11ax20MIMO | 5500 | Type5 | 26 | 0 | 545865.0 | 16 | 3 | 83.6 | 1632.0 | 1195.0 | 1000.0 |
| 11ax20MIMO | 5500 | Type5 | 26 | 1 | 14067.0 | 16 | 3 | 89.4 | 1173.0 | 1627.0 | 1656.0 |
| 11ax20MIMO | 5500 | Type5 | 26 | 2 | 184953.0 | 16 | 1 | 55.8 | 1532.0 | --- | --- |
| 11ax20MIMO | 5500 | Type5 | 26 | 3 | 353759.0 | 16 | 3 | 90.9 | 1981.0 | 1554.0 | 1998.0 |
| 11ax20MIMO | 5500 | Type5 | 26 | 4 | 526388.0 | 16 | 1 | 54.7 | 1825.0 | --- | --- |
| 11ax20MIMO | 5500 | Type5 | 26 | 5 | 694806.0 | 16 | 3 | 97.7 | 1734.0 | 1202.0 | 1250.0 |
| 11ax20MIMO | 5500 | Type5 | 26 | 6 | 163568.0 | 16 | 2 | 67.5 | 1571.0 | 1434.0 | --- |
| 11ax20MIMO | 5500 | Type5 | 26 | 7 | 333410.0 | 16 | 3 | 96.7 | 1589.0 | 1469.0 | 1268.0 |
| 11ax20MIMO | 5500 | Type5 | 26 | 8 | 504006.0 | 16 | 2 | 68.3 | 1750.0 | 1954.0 | --- |
| 11ax20MIMO | 5500 | Type5 | 26 | 9 | 675297.0 | 16 | 2 | 78.3 | 1591.0 | 1082.0 | --- |
| 11ax20MIMO | 5500 | Type5 | 26 | 10 | 142890.0 | 16 | 1 | 55.0 | 1427.0 | --- | --- |
| 11ax20MIMO | 5500 | Type5 | 26 | 11 | 312479.0 | 16 | 3 | 84.9 | 1129.0 | 1936.0 | 1199.0 |
| 11ax20MIMO | 5500 | Type5 | 26 | 12 | 482953.0 | 16 | 2 | 74.6 | 1959.0 | 1856.0 | --- |
| 11ax20MIMO | 5500 | Type5 | 26 | 13 | 655022.0 | 16 | 1 | 63.3 | 1885.0 | --- | --- |
| 11ax20MIMO | 5500 | Type5 | 26 | 14 | 121457.0 | 16 | 3 | 99.8 | 1035.0 | 1515.0 | 1120.0 |
| 11ax20MIMO | 5500 | Type5 | 26 | 15 | 292606.0 | 16 | 1 | 63.6 | 1647.0 | --- | --- |
| 11ax20MIMO | 5500 | Type5 | 26 | 16 | 461322.0 | 16 | 3 | 87.3 | 1931.0 | 1051.0 | 1831.0 |
| 11ax40MIMO | 5510 | Type5 | 26 | 0 | 545865.0 | 16 | 3 | 83.6 | 1632.0 | 1195.0 | 1000.0 |
| 11ax40MIMO | 5510 | Type5 | 26 | 1 | 14067.0 | 16 | 3 | 89.4 | 1173.0 | 1627.0 | 1656.0 |
| 11ax40MIMO | 5510 | Type5 | 26 | 2 | 184953.0 | 16 | 1 | 55.8 | 1532.0 | --- | --- |
| 11ax40MIMO | 5510 | Type5 | 26 | 3 | 353759.0 | 16 | 3 | 90.9 | 1981.0 | 1554.0 | 1998.0 |
| 11ax40MIMO | 5510 | Type5 | 26 | 4 | 526388.0 | 16 | 1 | 54.7 | 1825.0 | --- | --- |
| 11ax40MIMO | 5510 | Type5 | 26 | 5 | 694806.0 | 16 | 3 | 97.7 | 1734.0 | 1202.0 | 1250.0 |
| 11ax40MIMO | 5510 | Type5 | 26 | 6 | 163568.0 | 16 | 2 | 67.5 | 1571.0 | 1434.0 | --- |
| 11ax40MIMO | 5510 | Type5 | 26 | 7 | 333410.0 | 16 | 3 | 96.7 | 1589.0 | 1469.0 | 1268.0 |
| 11ax40MIMO | 5510 | Type5 | 26 | 8 | 504006.0 | 16 | 2 | 68.3 | 1750.0 | 1954.0 | --- |
| 11ax40MIMO | 5510 | Type5 | 26 | 9 | 675297.0 | 16 | 2 | 78.3 | 1591.0 | 1082.0 | --- |
| 11ax40MIMO | 5510 | Type5 | 26 | 10 | 142890.0 | 16 | 1 | 55.0 | 1427.0 | --- | --- |
| 11ax40MIMO | 5510 | Type5 | 26 | 11 | 312479.0 | 16 | 3 | 84.9 | 1129.0 | 1936.0 | 1199.0 |
| 11ax40MIMO | 5510 | Type5 | 26 | 12 | 482953.0 | 16 | 2 | 74.6 | 1959.0 | 1856.0 | --- |
| 11ax40MIMO | 5510 | Type5 | 26 | 13 | 655022.0 | 16 | 1 | 63.3 | 1885.0 | --- | --- |
| 11ax40MIMO | 5510 | Type5 | 26 | 14 | 121457.0 | 16 | 3 | 99.8 | 1035.0 | 1515.0 | 1120.0 |
| 11ax40MIMO | 5510 | Type5 | 26 | 15 | 292606.0 | 16 | 1 | 63.6 | 1647.0 | --- | --- |
| 11ax40MIMO | 5510 | Type5 | 26 | 16 | 461322.0 | 16 | 3 | 87.3 | 1931.0 | 1051.0 | 1831.0 |
| 11ax80MIMO | 5530 | Type5 | 26 | 0 | 545865.0 | 16 | 3 | 83.6 | 1632.0 | 1195.0 | 1000.0 |
| 11ax80MIMO | 5530 | Type5 | 26 | 1 | 14067.0 | 16 | 3 | 89.4 | 1173.0 | 1627.0 | 1656.0 |
| 11ax80MIMO | 5530 | Type5 | 26 | 2 | 184953.0 | 16 | 1 | 55.8 | 1532.0 | --- | --- |
| 11ax80MIMO | 5530 | Type5 | 26 | 3 | 353759.0 | 16 | 3 | 90.9 | 1981.0 | 1554.0 | 1998.0 |
| 11ax80MIMO | 5530 | Type5 | 26 | 4 | 526388.0 | 16 | 1 | 54.7 | 1825.0 | --- | --- |
| 11ax80MIMO | 5530 | Type5 | 26 | 5 | 694806.0 | 16 | 3 | 97.7 | 1734.0 | 1202.0 | 1250.0 |
| 11ax80MIMO | 5530 | Type5 | 26 | 6 | 163568.0 | 16 | 2 | 67.5 | 1571.0 | 1434.0 | --- |
| 11ax80MIMO | 5530 | Type5 | 26 | 7 | 333410.0 | 16 | 3 | 96.7 | 1589.0 | 1469.0 | 1268.0 |
| 11ax80MIMO | 5530 | Type5 | 26 | 8 | 504006.0 | 16 | 2 | 68.3 | 1750.0 | 1954.0 | --- |
| 11ax80MIMO | 5530 | Type5 | 26 | 9 | 675297.0 | 16 | 2 | 78.3 | 1591.0 | 1082.0 | --- |
| 11ax80MIMO | 5530 | Type5 | 26 | 10 | 142890.0 | 16 | 1 | 55.0 | 1427.0 | --- | --- |
| 11ax80MIMO | 5530 | Type5 | 26 | 11 | 312479.0 | 16 | 3 | 84.9 | 1129.0 | 1936.0 | 1199.0 |
| 11ax80MIMO | 5530 | Type5 | 26 | 12 | 482953.0 | 16 | 2 | 74.6 | 1959.0 | 1856.0 | --- |
| 11ax80MIMO | 5530 | Type5 | 26 | 13 | 655022.0 | 16 | 1 | 63.3 | 1885.0 | --- | --- |
| 11ax80MIMO | 5530 | Type5 | 26 | 14 | 121457.0 | 16 | 3 | 99.8 | 1035.0 | 1515.0 | 1120.0 |
| 11ax80MIMO | 5530 | Type5 | 26 | 15 | 292606.0 | 16 | 1 | 63.6 | 1647.0 | --- | --- |
| 11ax80MIMO | 5530 | Type5 | 26 | 16 | 461322.0 | 16 | 3 | 87.3 | 1931.0 | 1051.0 | 1831.0 |
| 11ax160MIMO | 5570 | Type5 | 26 | 0 | 545865.0 | 16 | 3 | 83.6 | 1632.0 | 1195.0 | 1000.0 |
| 11ax160MIMO | 5570 | Type5 | 26 | 1 | 14067.0 | 16 | 3 | 89.4 | 1173.0 | 1627.0 | 1656.0 |
| 11ax160MIMO | 5570 | Type5 | 26 | 2 | 184953.0 | 16 | 1 | 55.8 | 1532.0 | --- | --- |
| 11ax160MIMO | 5570 | Type5 | 26 | 3 | 353759.0 | 16 | 3 | 90.9 | 1981.0 | 1554.0 | 1998.0 |
| 11ax160MIMO | 5570 | Type5 | 26 | 4 | 526388.0 | 16 | 1 | 54.7 | 1825.0 | --- | --- |
| 11ax160MIMO | 5570 | Type5 | 26 | 5 | 694806.0 | 16 | 3 | 97.7 | 1734.0 | 1202.0 | 1250.0 |



Unless otherwise agreed in writing, this document is issued by the Company subject to its General Conditions of Service printed overleaf, available on request or accessible at <http://www.sgs.com/en/Terms-and-Conditions.aspx> and, for electronic format documents, subject to Terms and Conditions for Electronic Documents at <http://www.sgs.com/en/Terms-and-Conditions/Terms-e-Documents.aspx>. Attention is drawn to the limitation of liability, indemnification and jurisdiction issues defined therein. Any holder of this document is advised that information contained hereon reflects the Company's findings at the time of its intervention only and within the limits of Client's instructions, if any. The Company's sole responsibility is to its Client and this document does not exonerate parties to a transaction from exercising all their rights and obligations under the transaction documents. This document cannot be reproduced except in full, without prior written approval of the Company. Any unauthorized alteration, forgery or falsification of the content or appearance of this document is unlawful and offenders may be prosecuted to the fullest extent of the law. Unless otherwise stated the results shown in this report refer only to the sample(s) tested and such sample(s) are retained for 30 days only.

Attention: To check the authenticity of testing/inspection report & certificate, please contact us at telephone: (86-755) 8307 1443, or email: CN.Doccheck@sgs.com

Report No.: SEWA2303000041RG06

Rev.: 01

Page: 97 of 104

| | | | | | | | | | | | |
|-------------|------|-------|----|----|----------|----|---|------|--------|--------|--------|
| 11ax160MIMO | 5570 | Type5 | 26 | 6 | 163568.0 | 16 | 2 | 67.5 | 1571.0 | 1434.0 | --- |
| 11ax160MIMO | 5570 | Type5 | 26 | 7 | 333410.0 | 16 | 3 | 96.7 | 1589.0 | 1469.0 | 1268.0 |
| 11ax160MIMO | 5570 | Type5 | 26 | 8 | 504006.0 | 16 | 2 | 68.3 | 1750.0 | 1954.0 | --- |
| 11ax160MIMO | 5570 | Type5 | 26 | 9 | 675297.0 | 16 | 2 | 78.3 | 1591.0 | 1082.0 | --- |
| 11ax160MIMO | 5570 | Type5 | 26 | 10 | 142890.0 | 16 | 1 | 55.0 | 1427.0 | --- | --- |
| 11ax160MIMO | 5570 | Type5 | 26 | 11 | 312479.0 | 16 | 3 | 84.9 | 1129.0 | 1936.0 | 1199.0 |
| 11ax160MIMO | 5570 | Type5 | 26 | 12 | 482953.0 | 16 | 2 | 74.6 | 1959.0 | 1856.0 | --- |
| 11ax160MIMO | 5570 | Type5 | 26 | 13 | 655022.0 | 16 | 1 | 63.3 | 1885.0 | --- | --- |
| 11ax160MIMO | 5570 | Type5 | 26 | 14 | 121457.0 | 16 | 3 | 99.8 | 1035.0 | 1515.0 | 1120.0 |
| 11ax160MIMO | 5570 | Type5 | 26 | 15 | 292606.0 | 16 | 1 | 63.6 | 1647.0 | --- | --- |
| 11ax160MIMO | 5570 | Type5 | 26 | 16 | 461322.0 | 16 | 3 | 87.3 | 1931.0 | 1051.0 | 1831.0 |



Unless otherwise agreed in writing, this document is issued by the Company subject to its General Conditions of Service printed overleaf, available on request or accessible at <http://www.sgs.com/en/Terms-and-Conditions.aspx> and, for electronic format documents, subject to Terms and Conditions for Electronic Documents at <http://www.sgs.com/en/Terms-and-Conditions/Terms-e-Documents.aspx>. Attention is drawn to the limitation of liability, indemnification and jurisdiction issues defined therein. Any holder of this document is advised that information contained hereon reflects the Company's findings at the time of its intervention only and within the limits of Client's instructions, if any. The Company's sole responsibility is to its Client and this document does not exonerate parties to a transaction from exercising all their rights and obligations under the transaction documents. This document cannot be reproduced except in full, without prior written approval of the Company. Any unauthorized alteration, forgery or falsification of the content or appearance of this document is unlawful and offenders may be prosecuted to the fullest extent of the law. Unless otherwise stated the results shown in this test report refer only to the sample(s) tested and such sample(s) are retained for 30 days only.

Attention: To check the authenticity of testing /inspection report & certificate, please contact us at telephone: (86-755) 8307 1443, or email: CN.Doccheck@sgs.com

| @FCC_RLAN_DFS_SPC_Radar_T5_SP2_Tr27@ | | | | | | | | | | | |
|--------------------------------------|---------|------------|----------|----------|-------------------|-------------------|------------------|------------------|-----------|-----------|-----------|
| TestMode | Channel | Radar Type | Trial ID | Burst ID | Burst Offset (μs) | Chirp Width (MHz) | Number Of Pulses | Pulse Width (μs) | PRI1 (μs) | PRI2 (μs) | PRI3 (μs) |
| 11ax20MIMO | 5500 | Type5 | 27 | 0 | 565136.0 | 19 | 3 | 85.6 | 1946.0 | 1078.0 | 1015.0 |
| 11ax20MIMO | 5500 | Type5 | 27 | 1 | 89970.0 | 19 | 2 | 68.6 | 1029.0 | 1780.0 | --- |
| 11ax20MIMO | 5500 | Type5 | 27 | 2 | 243121.0 | 19 | 1 | 54.2 | 1111.0 | --- | --- |
| 11ax20MIMO | 5500 | Type5 | 27 | 3 | 396034.0 | 19 | 1 | 61.2 | 1104.0 | --- | --- |
| 11ax20MIMO | 5500 | Type5 | 27 | 4 | 546225.0 | 19 | 3 | 97.1 | 1157.0 | 1969.0 | 1100.0 |
| 11ax20MIMO | 5500 | Type5 | 27 | 5 | 70998.0 | 19 | 3 | 98.3 | 1142.0 | 1699.0 | 1622.0 |
| 11ax20MIMO | 5500 | Type5 | 27 | 6 | 224093.0 | 19 | 1 | 62.4 | 1655.0 | --- | --- |
| 11ax20MIMO | 5500 | Type5 | 27 | 7 | 376127.0 | 19 | 2 | 80.2 | 1126.0 | 1769.0 | --- |
| 11ax20MIMO | 5500 | Type5 | 27 | 8 | 527806.0 | 19 | 3 | 87.5 | 1216.0 | 1448.0 | 1179.0 |
| 11ax20MIMO | 5500 | Type5 | 27 | 9 | 52247.0 | 19 | 3 | 85.8 | 1847.0 | 1348.0 | 1472.0 |
| 11ax20MIMO | 5500 | Type5 | 27 | 10 | 204582.0 | 19 | 3 | 88.1 | 1023.0 | 1124.0 | 1631.0 |
| 11ax20MIMO | 5500 | Type5 | 27 | 11 | 357941.0 | 19 | 1 | 65.3 | 1848.0 | --- | --- |
| 11ax20MIMO | 5500 | Type5 | 27 | 12 | 510977.0 | 19 | 1 | 52.5 | 1470.0 | --- | --- |
| 11ax20MIMO | 5500 | Type5 | 27 | 13 | 33698.0 | 19 | 1 | 52.3 | 1312.0 | --- | --- |
| 11ax20MIMO | 5500 | Type5 | 27 | 14 | 186023.0 | 19 | 2 | 74.1 | 1915.0 | 1200.0 | --- |
| 11ax20MIMO | 5500 | Type5 | 27 | 15 | 339327.0 | 19 | 1 | 54.9 | 1479.0 | --- | --- |
| 11ax20MIMO | 5500 | Type5 | 27 | 16 | 491053.0 | 19 | 2 | 76.2 | 1376.0 | 1502.0 | --- |
| 11ax20MIMO | 5500 | Type5 | 27 | 17 | 14858.0 | 19 | 1 | 60.4 | 1758.0 | --- | --- |
| 11ax20MIMO | 5500 | Type5 | 27 | 18 | 167387.0 | 19 | 2 | 81.5 | 1491.0 | 1103.0 | --- |
| 11ax40MIMO | 5510 | Type5 | 27 | 0 | 565136.0 | 19 | 3 | 85.6 | 1946.0 | 1078.0 | 1015.0 |
| 11ax40MIMO | 5510 | Type5 | 27 | 1 | 89970.0 | 19 | 2 | 68.6 | 1029.0 | 1780.0 | --- |
| 11ax40MIMO | 5510 | Type5 | 27 | 2 | 243121.0 | 19 | 1 | 54.2 | 1111.0 | --- | --- |
| 11ax40MIMO | 5510 | Type5 | 27 | 3 | 396034.0 | 19 | 1 | 61.2 | 1104.0 | --- | --- |
| 11ax40MIMO | 5510 | Type5 | 27 | 4 | 546225.0 | 19 | 3 | 97.1 | 1157.0 | 1969.0 | 1100.0 |
| 11ax40MIMO | 5510 | Type5 | 27 | 5 | 70998.0 | 19 | 3 | 98.3 | 1142.0 | 1699.0 | 1622.0 |
| 11ax40MIMO | 5510 | Type5 | 27 | 6 | 224093.0 | 19 | 1 | 62.4 | 1655.0 | --- | --- |
| 11ax40MIMO | 5510 | Type5 | 27 | 7 | 376127.0 | 19 | 2 | 80.2 | 1126.0 | 1769.0 | --- |
| 11ax40MIMO | 5510 | Type5 | 27 | 8 | 527806.0 | 19 | 3 | 87.5 | 1216.0 | 1448.0 | 1179.0 |
| 11ax40MIMO | 5510 | Type5 | 27 | 9 | 52247.0 | 19 | 3 | 85.8 | 1847.0 | 1348.0 | 1472.0 |
| 11ax40MIMO | 5510 | Type5 | 27 | 10 | 204582.0 | 19 | 3 | 88.1 | 1023.0 | 1124.0 | 1631.0 |
| 11ax40MIMO | 5510 | Type5 | 27 | 11 | 357941.0 | 19 | 1 | 65.3 | 1848.0 | --- | --- |
| 11ax40MIMO | 5510 | Type5 | 27 | 12 | 510977.0 | 19 | 1 | 52.5 | 1470.0 | --- | --- |
| 11ax40MIMO | 5510 | Type5 | 27 | 13 | 33698.0 | 19 | 1 | 52.3 | 1312.0 | --- | --- |
| 11ax40MIMO | 5510 | Type5 | 27 | 14 | 186023.0 | 19 | 2 | 74.1 | 1915.0 | 1200.0 | --- |
| 11ax40MIMO | 5510 | Type5 | 27 | 15 | 339327.0 | 19 | 1 | 54.9 | 1479.0 | --- | --- |
| 11ax40MIMO | 5510 | Type5 | 27 | 16 | 491053.0 | 19 | 2 | 76.2 | 1376.0 | 1502.0 | --- |
| 11ax40MIMO | 5510 | Type5 | 27 | 17 | 14858.0 | 19 | 1 | 60.4 | 1758.0 | --- | --- |
| 11ax40MIMO | 5510 | Type5 | 27 | 18 | 167387.0 | 19 | 2 | 81.5 | 1491.0 | 1103.0 | --- |
| 11ax80MIMO | 5530 | Type5 | 27 | 0 | 565136.0 | 19 | 3 | 85.6 | 1946.0 | 1078.0 | 1015.0 |
| 11ax80MIMO | 5530 | Type5 | 27 | 1 | 89970.0 | 19 | 2 | 68.6 | 1029.0 | 1780.0 | --- |
| 11ax80MIMO | 5530 | Type5 | 27 | 2 | 243121.0 | 19 | 1 | 54.2 | 1111.0 | --- | --- |
| 11ax80MIMO | 5530 | Type5 | 27 | 3 | 396034.0 | 19 | 1 | 61.2 | 1104.0 | --- | --- |
| 11ax80MIMO | 5530 | Type5 | 27 | 4 | 546225.0 | 19 | 3 | 97.1 | 1157.0 | 1969.0 | 1100.0 |
| 11ax80MIMO | 5530 | Type5 | 27 | 5 | 70998.0 | 19 | 3 | 98.3 | 1142.0 | 1699.0 | 1622.0 |
| 11ax80MIMO | 5530 | Type5 | 27 | 6 | 224093.0 | 19 | 1 | 62.4 | 1655.0 | --- | --- |
| 11ax80MIMO | 5530 | Type5 | 27 | 7 | 376127.0 | 19 | 2 | 80.2 | 1126.0 | 1769.0 | --- |
| 11ax80MIMO | 5530 | Type5 | 27 | 8 | 527806.0 | 19 | 3 | 87.5 | 1216.0 | 1448.0 | 1179.0 |
| 11ax80MIMO | 5530 | Type5 | 27 | 9 | 52247.0 | 19 | 3 | 85.8 | 1847.0 | 1348.0 | 1472.0 |
| 11ax80MIMO | 5530 | Type5 | 27 | 10 | 204582.0 | 19 | 3 | 88.1 | 1023.0 | 1124.0 | 1631.0 |
| 11ax80MIMO | 5530 | Type5 | 27 | 11 | 357941.0 | 19 | 1 | 65.3 | 1848.0 | --- | --- |
| 11ax80MIMO | 5530 | Type5 | 27 | 12 | 510977.0 | 19 | 1 | 52.5 | 1470.0 | --- | --- |
| 11ax80MIMO | 5530 | Type5 | 27 | 13 | 33698.0 | 19 | 1 | 52.3 | 1312.0 | --- | --- |
| 11ax80MIMO | 5530 | Type5 | 27 | 14 | 186023.0 | 19 | 2 | 74.1 | 1915.0 | 1200.0 | --- |
| 11ax80MIMO | 5530 | Type5 | 27 | 15 | 339327.0 | 19 | 1 | 54.9 | 1479.0 | --- | --- |
| 11ax80MIMO | 5530 | Type5 | 27 | 16 | 491053.0 | 19 | 2 | 76.2 | 1376.0 | 1502.0 | --- |
| 11ax80MIMO | 5530 | Type5 | 27 | 17 | 14858.0 | 19 | 1 | 60.4 | 1758.0 | --- | --- |
| 11ax80MIMO | 5530 | Type5 | 27 | 18 | 167387.0 | 19 | 2 | 81.5 | 1491.0 | 1103.0 | --- |



Unless otherwise agreed in writing, this document is issued by the Company subject to its General Conditions of Service printed overleaf, available on request or accessible at <http://www.sgs.com/en/Terms-and-Conditions.aspx> and, for electronic format documents, subject to Terms and Conditions for Electronic Documents at <http://www.sgs.com/en/Terms-and-Conditions/Terms-e-Documents.aspx>. Attention is drawn to the limitation of liability, indemnification and jurisdiction issues defined therein. Any holder of this document is advised that information contained hereon reflects the Company's findings at the time of its intervention only and within the limits of Client's instructions, if any. The Company's sole responsibility is to its Client and this document does not exonerate parties to a transaction from exercising all their rights and obligations under the transaction documents. This document cannot be reproduced except in full, without prior written approval of the Company. Any unauthorized alteration, forgery or falsification of the content or appearance of this document is unlawful and offenders may be prosecuted to the fullest extent of the law. Unless otherwise stated the results shown in this test report refer only to the sample(s) tested and such sample(s) are retained for 30 days only.

Attention: To check the authenticity of testing/inspection report & certificate, please contact us at telephone: (86-755) 8307 1443, or email: QN.Doccheck@sgs.com

| | | | | | | | | | | | |
|-------------|------|-------|----|----|----------|----|---|------|--------|--------|--------|
| 11ax160MIMO | 5570 | Type5 | 27 | 0 | 565136.0 | 19 | 3 | 85.6 | 1946.0 | 1078.0 | 1015.0 |
| 11ax160MIMO | 5570 | Type5 | 27 | 1 | 89970.0 | 19 | 2 | 68.6 | 1029.0 | 1780.0 | --- |
| 11ax160MIMO | 5570 | Type5 | 27 | 2 | 243121.0 | 19 | 1 | 54.2 | 1111.0 | --- | --- |
| 11ax160MIMO | 5570 | Type5 | 27 | 3 | 396034.0 | 19 | 1 | 61.2 | 1104.0 | --- | --- |
| 11ax160MIMO | 5570 | Type5 | 27 | 4 | 546225.0 | 19 | 3 | 97.1 | 1157.0 | 1969.0 | 1100.0 |
| 11ax160MIMO | 5570 | Type5 | 27 | 5 | 70998.0 | 19 | 3 | 98.3 | 1142.0 | 1699.0 | 1622.0 |
| 11ax160MIMO | 5570 | Type5 | 27 | 6 | 224093.0 | 19 | 1 | 62.4 | 1655.0 | --- | --- |
| 11ax160MIMO | 5570 | Type5 | 27 | 7 | 376127.0 | 19 | 2 | 80.2 | 1126.0 | 1769.0 | --- |
| 11ax160MIMO | 5570 | Type5 | 27 | 8 | 527806.0 | 19 | 3 | 87.5 | 1216.0 | 1448.0 | 1179.0 |
| 11ax160MIMO | 5570 | Type5 | 27 | 9 | 52247.0 | 19 | 3 | 85.8 | 1847.0 | 1348.0 | 1472.0 |
| 11ax160MIMO | 5570 | Type5 | 27 | 10 | 204582.0 | 19 | 3 | 88.1 | 1023.0 | 1124.0 | 1631.0 |
| 11ax160MIMO | 5570 | Type5 | 27 | 11 | 357941.0 | 19 | 1 | 65.3 | 1848.0 | --- | --- |
| 11ax160MIMO | 5570 | Type5 | 27 | 12 | 510977.0 | 19 | 1 | 52.5 | 1470.0 | --- | --- |
| 11ax160MIMO | 5570 | Type5 | 27 | 13 | 33698.0 | 19 | 1 | 52.3 | 1312.0 | --- | --- |
| 11ax160MIMO | 5570 | Type5 | 27 | 14 | 186023.0 | 19 | 2 | 74.1 | 1915.0 | 1200.0 | --- |
| 11ax160MIMO | 5570 | Type5 | 27 | 15 | 339327.0 | 19 | 1 | 54.9 | 1479.0 | --- | --- |
| 11ax160MIMO | 5570 | Type5 | 27 | 16 | 491053.0 | 19 | 2 | 76.2 | 1376.0 | 1502.0 | --- |
| 11ax160MIMO | 5570 | Type5 | 27 | 17 | 14858.0 | 19 | 1 | 60.4 | 1758.0 | --- | --- |
| 11ax160MIMO | 5570 | Type5 | 27 | 18 | 167387.0 | 19 | 2 | 81.5 | 1491.0 | 1103.0 | --- |



Unless otherwise agreed in writing, this document is issued by the Company subject to its General Conditions of Service printed overleaf, available on request or accessible at <http://www.sgs.com/en/Terms-and-Conditions.aspx> and, for electronic format documents, subject to Terms and Conditions for Electronic Documents at <http://www.sgs.com/en/Terms-and-Conditions/Terms-e-Documents.aspx>. Attention is drawn to the limitation of liability, indemnification and jurisdiction issues defined therein. Any holder of this document is advised that information contained hereon reflects the Company's findings at the time of its intervention only and within the limits of Client's instructions, if any. The Company's sole responsibility is to its Client and this document does not exonerate parties to a transaction from exercising all their rights and obligations under the transaction documents. This document cannot be reproduced except in full, without prior written approval of the Company. Any unauthorized alteration, forgery or falsification of the content or appearance of this document is unlawful and offenders may be prosecuted to the fullest extent of the law. Unless otherwise stated the results shown in this test report refer only to the sample(s) tested and such sample(s) are retained for 30 days only.

Attention: To check the authenticity of testing /inspection report & certificate, please contact us at telephone: (86-755) 8307 1443, or email: CN.Doccheck@sgs.com

| @FCC_RLAN_DFS_SPC_Radar_T5_SP2_Tr28@ | | | | | | | | | | | |
|--------------------------------------|---------|------------|----------|----------|-------------------|-------------------|------------------|------------------|-----------|-----------|-----------|
| TestMode | Channel | Radar Type | Trial ID | Burst ID | Burst Offset (μs) | Chirp Width (MHz) | Number Of Pulses | Pulse Width (μs) | PRI1 (μs) | PRI2 (μs) | PRI3 (μs) |
| 11ax20MIMO | 5500 | Type5 | 28 | 0 | 507709.0 | 10 | 1 | 50.5 | 1857.0 | --- | --- |
| 11ax20MIMO | 5500 | Type5 | 28 | 1 | 750249.0 | 10 | 1 | 55.7 | 1246.0 | --- | --- |
| 11ax20MIMO | 5500 | Type5 | 28 | 2 | 989003.0 | 10 | 3 | 85.8 | 1774.0 | 1002.0 | 1967.0 |
| 11ax20MIMO | 5500 | Type5 | 28 | 3 | 235634.0 | 10 | 2 | 76.9 | 1125.0 | 1474.0 | --- |
| 11ax20MIMO | 5500 | Type5 | 28 | 4 | 477675.0 | 10 | 2 | 75.1 | 1254.0 | 1052.0 | --- |
| 11ax20MIMO | 5500 | Type5 | 28 | 5 | 718312.0 | 10 | 3 | 92.3 | 1180.0 | 1486.0 | 1492.0 |
| 11ax20MIMO | 5500 | Type5 | 28 | 6 | 960895.0 | 10 | 2 | 78.1 | 1301.0 | 1757.0 | --- |
| 11ax20MIMO | 5500 | Type5 | 28 | 7 | 205370.0 | 10 | 3 | 92.2 | 1898.0 | 1252.0 | 1713.0 |
| 11ax20MIMO | 5500 | Type5 | 28 | 8 | 446940.0 | 10 | 3 | 89.0 | 1260.0 | 1706.0 | 1411.0 |
| 11ax20MIMO | 5500 | Type5 | 28 | 9 | 689225.0 | 10 | 2 | 70.9 | 1578.0 | 1620.0 | --- |
| 11ax20MIMO | 5500 | Type5 | 28 | 10 | 932305.0 | 10 | 1 | 63.1 | 1782.0 | --- | --- |
| 11ax20MIMO | 5500 | Type5 | 28 | 11 | 176231.0 | 10 | 1 | 55.3 | 1522.0 | --- | --- |
| 11ax40MIMO | 5510 | Type5 | 28 | 0 | 507709.0 | 10 | 1 | 50.5 | 1857.0 | --- | --- |
| 11ax40MIMO | 5510 | Type5 | 28 | 1 | 750249.0 | 10 | 1 | 55.7 | 1246.0 | --- | --- |
| 11ax40MIMO | 5510 | Type5 | 28 | 2 | 989003.0 | 10 | 3 | 85.8 | 1774.0 | 1002.0 | 1967.0 |
| 11ax40MIMO | 5510 | Type5 | 28 | 3 | 235634.0 | 10 | 2 | 76.9 | 1125.0 | 1474.0 | --- |
| 11ax40MIMO | 5510 | Type5 | 28 | 4 | 477675.0 | 10 | 2 | 75.1 | 1254.0 | 1052.0 | --- |
| 11ax40MIMO | 5510 | Type5 | 28 | 5 | 718312.0 | 10 | 3 | 92.3 | 1180.0 | 1486.0 | 1492.0 |
| 11ax40MIMO | 5510 | Type5 | 28 | 6 | 960895.0 | 10 | 2 | 78.1 | 1301.0 | 1757.0 | --- |
| 11ax40MIMO | 5510 | Type5 | 28 | 7 | 205370.0 | 10 | 3 | 92.2 | 1898.0 | 1252.0 | 1713.0 |
| 11ax40MIMO | 5510 | Type5 | 28 | 8 | 446940.0 | 10 | 3 | 89.0 | 1260.0 | 1706.0 | 1411.0 |
| 11ax40MIMO | 5510 | Type5 | 28 | 9 | 689225.0 | 10 | 2 | 70.9 | 1578.0 | 1620.0 | --- |
| 11ax40MIMO | 5510 | Type5 | 28 | 10 | 932305.0 | 10 | 1 | 63.1 | 1782.0 | --- | --- |
| 11ax40MIMO | 5510 | Type5 | 28 | 11 | 176231.0 | 10 | 1 | 55.3 | 1522.0 | --- | --- |
| 11ax80MIMO | 5530 | Type5 | 28 | 0 | 507709.0 | 10 | 1 | 50.5 | 1857.0 | --- | --- |
| 11ax80MIMO | 5530 | Type5 | 28 | 1 | 750249.0 | 10 | 1 | 55.7 | 1246.0 | --- | --- |
| 11ax80MIMO | 5530 | Type5 | 28 | 2 | 989003.0 | 10 | 3 | 85.8 | 1774.0 | 1002.0 | 1967.0 |
| 11ax80MIMO | 5530 | Type5 | 28 | 3 | 235634.0 | 10 | 2 | 76.9 | 1125.0 | 1474.0 | --- |
| 11ax80MIMO | 5530 | Type5 | 28 | 4 | 477675.0 | 10 | 2 | 75.1 | 1254.0 | 1052.0 | --- |
| 11ax80MIMO | 5530 | Type5 | 28 | 5 | 718312.0 | 10 | 3 | 92.3 | 1180.0 | 1486.0 | 1492.0 |
| 11ax80MIMO | 5530 | Type5 | 28 | 6 | 960895.0 | 10 | 2 | 78.1 | 1301.0 | 1757.0 | --- |
| 11ax80MIMO | 5530 | Type5 | 28 | 7 | 205370.0 | 10 | 3 | 92.2 | 1898.0 | 1252.0 | 1713.0 |
| 11ax80MIMO | 5530 | Type5 | 28 | 8 | 446940.0 | 10 | 3 | 89.0 | 1260.0 | 1706.0 | 1411.0 |
| 11ax80MIMO | 5530 | Type5 | 28 | 9 | 689225.0 | 10 | 2 | 70.9 | 1578.0 | 1620.0 | --- |
| 11ax80MIMO | 5530 | Type5 | 28 | 10 | 932305.0 | 10 | 1 | 63.1 | 1782.0 | --- | --- |
| 11ax80MIMO | 5530 | Type5 | 28 | 11 | 176231.0 | 10 | 1 | 55.3 | 1522.0 | --- | --- |
| 11ax160MIMO | 5570 | Type5 | 28 | 0 | 507709.0 | 10 | 1 | 50.5 | 1857.0 | --- | --- |
| 11ax160MIMO | 5570 | Type5 | 28 | 1 | 750249.0 | 10 | 1 | 55.7 | 1246.0 | --- | --- |
| 11ax160MIMO | 5570 | Type5 | 28 | 2 | 989003.0 | 10 | 3 | 85.8 | 1774.0 | 1002.0 | 1967.0 |
| 11ax160MIMO | 5570 | Type5 | 28 | 3 | 235634.0 | 10 | 2 | 76.9 | 1125.0 | 1474.0 | --- |
| 11ax160MIMO | 5570 | Type5 | 28 | 4 | 477675.0 | 10 | 2 | 75.1 | 1254.0 | 1052.0 | --- |
| 11ax160MIMO | 5570 | Type5 | 28 | 5 | 718312.0 | 10 | 3 | 92.3 | 1180.0 | 1486.0 | 1492.0 |
| 11ax160MIMO | 5570 | Type5 | 28 | 6 | 960895.0 | 10 | 2 | 78.1 | 1301.0 | 1757.0 | --- |
| 11ax160MIMO | 5570 | Type5 | 28 | 7 | 205370.0 | 10 | 3 | 92.2 | 1898.0 | 1252.0 | 1713.0 |
| 11ax160MIMO | 5570 | Type5 | 28 | 8 | 446940.0 | 10 | 3 | 89.0 | 1260.0 | 1706.0 | 1411.0 |
| 11ax160MIMO | 5570 | Type5 | 28 | 9 | 689225.0 | 10 | 2 | 70.9 | 1578.0 | 1620.0 | --- |
| 11ax160MIMO | 5570 | Type5 | 28 | 10 | 932305.0 | 10 | 1 | 63.1 | 1782.0 | --- | --- |
| 11ax160MIMO | 5570 | Type5 | 28 | 11 | 176231.0 | 10 | 1 | 55.3 | 1522.0 | --- | --- |



Unless otherwise agreed in writing, this document is issued by the Company subject to its General Conditions of Service printed overleaf, available on request or accessible at <http://www.sgs.com/en/Terms-and-Conditions.aspx> and, for electronic format documents, subject to Terms and Conditions for Electronic Documents at <http://www.sgs.com/en/Terms-and-Conditions/Terms-e-Documents.aspx>. Attention is drawn to the limitation of liability, indemnification and jurisdiction issues defined therein. Any holder of this document is advised that information contained hereon reflects the Company's findings only and within the limits of Client's instructions, if any. The Company's sole responsibility is to its Client and this document does not exonerate parties to a transaction from exercising all their rights and obligations under the transaction documents. This document cannot be reproduced except in full, without prior written approval of the Company. Any unauthorized alteration, forgery or falsification of the content or appearance of this document is unlawful and offenders may be prosecuted to the fullest extent of the law. Unless otherwise stated the results shown in this test report refer only to the sample(s) tested and such sample(s) are retained for 30 days only.

Attention: To check the authenticity of testing /inspection report & certificate, please contact us at telephone: (86-755) 8307 1443, or email: QN.Doccheck@sgs.com

South of No. 6 Plant, No. 1, Runsheng Road, Suzhou Industrial Park, Suzhou Area, China (Jiangsu) Pilot Free Trade Zone 215000 t (86-512) 62992980 www.sgsgroup.com.cn
 中国·苏州·中国(江苏)自由贸易试验区苏州片区苏州工业园区润胜路1号的6号厂房南楼 邮编: 215000 t (86-512) 62992980 sgs.china@sgs.com



@FCC_RLAN_DFS_SPC_Radar_T5_SP2_Tr29@

| TestMode | Channel | Radar Type | Trial ID | Burst ID | Burst Offset (μs) | Chirp Width (MHz) | Number Of Pulses | Pulse Width (μs) | PRI1 (μs) | PRI2 (μs) | PRI3 (μs) |
|-------------|---------|------------|----------|----------|-------------------|-------------------|------------------|------------------|-----------|-----------|-----------|
| 11ax20MIMO | 5500 | Type5 | 29 | 0 | 277485.0 | 17 | 3 | 83.4 | 1454.0 | 1205.0 | 1801.0 |
| 11ax20MIMO | 5500 | Type5 | 29 | 1 | 437880.0 | 17 | 3 | 97.3 | 1319.0 | 1826.0 | 1635.0 |
| 11ax20MIMO | 5500 | Type5 | 29 | 2 | 598445.0 | 17 | 3 | 90.4 | 1079.0 | 1986.0 | 1674.0 |
| 11ax20MIMO | 5500 | Type5 | 29 | 3 | 97088.0 | 17 | 3 | 91.8 | 1563.0 | 1151.0 | 1802.0 |
| 11ax20MIMO | 5500 | Type5 | 29 | 4 | 257251.0 | 17 | 3 | 98.2 | 1876.0 | 1977.0 | 1766.0 |
| 11ax20MIMO | 5500 | Type5 | 29 | 5 | 419893.0 | 17 | 1 | 59.5 | 1952.0 | --- | --- |
| 11ax20MIMO | 5500 | Type5 | 29 | 6 | 580724.0 | 17 | 2 | 80.0 | 1253.0 | 1137.0 | --- |
| 11ax20MIMO | 5500 | Type5 | 29 | 7 | 77366.0 | 17 | 3 | 86.5 | 1054.0 | 1128.0 | 1828.0 |
| 11ax20MIMO | 5500 | Type5 | 29 | 8 | 238032.0 | 17 | 3 | 91.1 | 1105.0 | 1599.0 | 1442.0 |
| 11ax20MIMO | 5500 | Type5 | 29 | 9 | 398605.0 | 17 | 3 | 93.5 | 1867.0 | 1373.0 | 1087.0 |
| 11ax20MIMO | 5500 | Type5 | 29 | 10 | 562025.0 | 17 | 1 | 60.7 | 1033.0 | --- | --- |
| 11ax20MIMO | 5500 | Type5 | 29 | 11 | 57684.0 | 17 | 2 | 67.2 | 1288.0 | 1405.0 | --- |
| 11ax20MIMO | 5500 | Type5 | 29 | 12 | 219083.0 | 17 | 1 | 61.8 | 1585.0 | --- | --- |
| 11ax20MIMO | 5500 | Type5 | 29 | 13 | 379234.0 | 17 | 2 | 79.4 | 1933.0 | 1667.0 | --- |
| 11ax20MIMO | 5500 | Type5 | 29 | 14 | 540896.0 | 17 | 2 | 81.4 | 1096.0 | 1464.0 | --- |
| 11ax20MIMO | 5500 | Type5 | 29 | 15 | 37916.0 | 17 | 1 | 65.7 | 1496.0 | --- | --- |
| 11ax20MIMO | 5500 | Type5 | 29 | 16 | 198794.0 | 17 | 2 | 76.0 | 1733.0 | 1255.0 | --- |
| 11ax20MIMO | 5500 | Type5 | 29 | 17 | 359754.0 | 17 | 2 | 81.0 | 1326.0 | 1668.0 | --- |
| 11ax40MIMO | 5510 | Type5 | 29 | 0 | 277485.0 | 17 | 3 | 83.4 | 1454.0 | 1205.0 | 1801.0 |
| 11ax40MIMO | 5510 | Type5 | 29 | 1 | 437880.0 | 17 | 3 | 97.3 | 1319.0 | 1826.0 | 1635.0 |
| 11ax40MIMO | 5510 | Type5 | 29 | 2 | 598445.0 | 17 | 3 | 90.4 | 1079.0 | 1986.0 | 1674.0 |
| 11ax40MIMO | 5510 | Type5 | 29 | 3 | 97088.0 | 17 | 3 | 91.8 | 1563.0 | 1151.0 | 1802.0 |
| 11ax40MIMO | 5510 | Type5 | 29 | 4 | 257251.0 | 17 | 3 | 98.2 | 1876.0 | 1977.0 | 1766.0 |
| 11ax40MIMO | 5510 | Type5 | 29 | 5 | 419893.0 | 17 | 1 | 59.5 | 1952.0 | --- | --- |
| 11ax40MIMO | 5510 | Type5 | 29 | 6 | 580724.0 | 17 | 2 | 80.0 | 1253.0 | 1137.0 | --- |
| 11ax40MIMO | 5510 | Type5 | 29 | 7 | 77366.0 | 17 | 3 | 86.5 | 1054.0 | 1128.0 | 1828.0 |
| 11ax40MIMO | 5510 | Type5 | 29 | 8 | 238032.0 | 17 | 3 | 91.1 | 1105.0 | 1599.0 | 1442.0 |
| 11ax40MIMO | 5510 | Type5 | 29 | 9 | 398605.0 | 17 | 3 | 93.5 | 1867.0 | 1373.0 | 1087.0 |
| 11ax40MIMO | 5510 | Type5 | 29 | 10 | 562025.0 | 17 | 1 | 60.7 | 1033.0 | --- | --- |
| 11ax40MIMO | 5510 | Type5 | 29 | 11 | 57684.0 | 17 | 2 | 67.2 | 1288.0 | 1405.0 | --- |
| 11ax40MIMO | 5510 | Type5 | 29 | 12 | 219083.0 | 17 | 1 | 61.8 | 1585.0 | --- | --- |
| 11ax40MIMO | 5510 | Type5 | 29 | 13 | 379234.0 | 17 | 2 | 79.4 | 1933.0 | 1667.0 | --- |
| 11ax40MIMO | 5510 | Type5 | 29 | 14 | 540896.0 | 17 | 2 | 81.4 | 1096.0 | 1464.0 | --- |
| 11ax40MIMO | 5510 | Type5 | 29 | 15 | 37916.0 | 17 | 1 | 65.7 | 1496.0 | --- | --- |
| 11ax40MIMO | 5510 | Type5 | 29 | 16 | 198794.0 | 17 | 2 | 76.0 | 1733.0 | 1255.0 | --- |
| 11ax40MIMO | 5510 | Type5 | 29 | 17 | 359754.0 | 17 | 2 | 81.0 | 1326.0 | 1668.0 | --- |
| 11ax80MIMO | 5530 | Type5 | 29 | 0 | 277485.0 | 17 | 3 | 83.4 | 1454.0 | 1205.0 | 1801.0 |
| 11ax80MIMO | 5530 | Type5 | 29 | 1 | 437880.0 | 17 | 3 | 97.3 | 1319.0 | 1826.0 | 1635.0 |
| 11ax80MIMO | 5530 | Type5 | 29 | 2 | 598445.0 | 17 | 3 | 90.4 | 1079.0 | 1986.0 | 1674.0 |
| 11ax80MIMO | 5530 | Type5 | 29 | 3 | 97088.0 | 17 | 3 | 91.8 | 1563.0 | 1151.0 | 1802.0 |
| 11ax80MIMO | 5530 | Type5 | 29 | 4 | 257251.0 | 17 | 3 | 98.2 | 1876.0 | 1977.0 | 1766.0 |
| 11ax80MIMO | 5530 | Type5 | 29 | 5 | 419893.0 | 17 | 1 | 59.5 | 1952.0 | --- | --- |
| 11ax80MIMO | 5530 | Type5 | 29 | 6 | 580724.0 | 17 | 2 | 80.0 | 1253.0 | 1137.0 | --- |
| 11ax80MIMO | 5530 | Type5 | 29 | 7 | 77366.0 | 17 | 3 | 86.5 | 1054.0 | 1128.0 | 1828.0 |
| 11ax80MIMO | 5530 | Type5 | 29 | 8 | 238032.0 | 17 | 3 | 91.1 | 1105.0 | 1599.0 | 1442.0 |
| 11ax80MIMO | 5530 | Type5 | 29 | 9 | 398605.0 | 17 | 3 | 93.5 | 1867.0 | 1373.0 | 1087.0 |
| 11ax80MIMO | 5530 | Type5 | 29 | 10 | 562025.0 | 17 | 1 | 60.7 | 1033.0 | --- | --- |
| 11ax80MIMO | 5530 | Type5 | 29 | 11 | 57684.0 | 17 | 2 | 67.2 | 1288.0 | 1405.0 | --- |
| 11ax80MIMO | 5530 | Type5 | 29 | 12 | 219083.0 | 17 | 1 | 61.8 | 1585.0 | --- | --- |
| 11ax80MIMO | 5530 | Type5 | 29 | 13 | 379234.0 | 17 | 2 | 79.4 | 1933.0 | 1667.0 | --- |
| 11ax80MIMO | 5530 | Type5 | 29 | 14 | 540896.0 | 17 | 2 | 81.4 | 1096.0 | 1464.0 | --- |
| 11ax80MIMO | 5530 | Type5 | 29 | 15 | 37916.0 | 17 | 1 | 65.7 | 1496.0 | --- | --- |
| 11ax80MIMO | 5530 | Type5 | 29 | 16 | 198794.0 | 17 | 2 | 76.0 | 1733.0 | 1255.0 | --- |
| 11ax80MIMO | 5530 | Type5 | 29 | 17 | 359754.0 | 17 | 2 | 81.0 | 1326.0 | 1668.0 | --- |
| 11ax160MIMO | 5570 | Type5 | 29 | 0 | 277485.0 | 17 | 3 | 83.4 | 1454.0 | 1205.0 | 1801.0 |
| 11ax160MIMO | 5570 | Type5 | 29 | 1 | 437880.0 | 17 | 3 | 97.3 | 1319.0 | 1826.0 | 1635.0 |
| 11ax160MIMO | 5570 | Type5 | 29 | 2 | 598445.0 | 17 | 3 | 90.4 | 1079.0 | 1986.0 | 1674.0 |



Unless otherwise agreed in writing, this document is issued by the Company subject to its General Conditions of Service printed overleaf, available on request or accessible at <http://www.sgs.com/en/Terms-and-Conditions.aspx> and, for electronic format documents, subject to Terms and Conditions for Electronic Documents at <http://www.sgs.com/en/Terms-and-Conditions/Terms-e-Documents.aspx>. Attention is drawn to the limitation of liability, indemnification and jurisdiction issues defined therein. Any holder of this document is advised that information contained hereon reflects the Company's findings at the time of its intervention only and within the limits of Client's instructions, if any. The Company's sole responsibility is to its Client and this document does not exonerate parties to a transaction from exercising all their rights and obligations under the transaction documents. This document cannot be reproduced except in full, without prior written approval of the Company. Any unauthorized alteration, forgery or falsification of the content or appearance of this document is unlawful and offenders may be prosecuted to the fullest extent of the law. Unless otherwise stated the results shown in this report refer only to the sample(s) tested and such sample(s) are retained for 30 days only.

Attention: To check the authenticity of testing /inspection report & certificate, please contact us at telephone: (86-755) 8307 1443, or email: CN.Doccheck@sgs.com

| | | | | | | | | | | | |
|-------------|------|-------|----|----|----------|----|---|------|--------|--------|--------|
| 11ax160MIMO | 5570 | Type5 | 29 | 3 | 97088.0 | 17 | 3 | 91.8 | 1563.0 | 1151.0 | 1802.0 |
| 11ax160MIMO | 5570 | Type5 | 29 | 4 | 257251.0 | 17 | 3 | 98.2 | 1876.0 | 1977.0 | 1766.0 |
| 11ax160MIMO | 5570 | Type5 | 29 | 5 | 419893.0 | 17 | 1 | 59.5 | 1952.0 | --- | --- |
| 11ax160MIMO | 5570 | Type5 | 29 | 6 | 580724.0 | 17 | 2 | 80.0 | 1253.0 | 1137.0 | --- |
| 11ax160MIMO | 5570 | Type5 | 29 | 7 | 77366.0 | 17 | 3 | 86.5 | 1054.0 | 1128.0 | 1828.0 |
| 11ax160MIMO | 5570 | Type5 | 29 | 8 | 238032.0 | 17 | 3 | 91.1 | 1105.0 | 1599.0 | 1442.0 |
| 11ax160MIMO | 5570 | Type5 | 29 | 9 | 398605.0 | 17 | 3 | 93.5 | 1867.0 | 1373.0 | 1087.0 |
| 11ax160MIMO | 5570 | Type5 | 29 | 10 | 562025.0 | 17 | 1 | 60.7 | 1033.0 | --- | --- |
| 11ax160MIMO | 5570 | Type5 | 29 | 11 | 57684.0 | 17 | 2 | 67.2 | 1288.0 | 1405.0 | --- |
| 11ax160MIMO | 5570 | Type5 | 29 | 12 | 219083.0 | 17 | 1 | 61.8 | 1585.0 | --- | --- |
| 11ax160MIMO | 5570 | Type5 | 29 | 13 | 379234.0 | 17 | 2 | 79.4 | 1933.0 | 1667.0 | --- |
| 11ax160MIMO | 5570 | Type5 | 29 | 14 | 540896.0 | 17 | 2 | 81.4 | 1096.0 | 1464.0 | --- |
| 11ax160MIMO | 5570 | Type5 | 29 | 15 | 37916.0 | 17 | 1 | 65.7 | 1496.0 | --- | --- |
| 11ax160MIMO | 5570 | Type5 | 29 | 16 | 198794.0 | 17 | 2 | 76.0 | 1733.0 | 1255.0 | --- |
| 11ax160MIMO | 5570 | Type5 | 29 | 17 | 359754.0 | 17 | 2 | 81.0 | 1326.0 | 1668.0 | --- |

| TestMode | Frequency[MHz] | Radar Type | Trial ID | Pulse width (μs) | PRI (μs) | Pulses per Hop | Detection (1: Yes; 0: No) |
|-------------|----------------|------------|----------|------------------|----------|----------------|---------------------------|
| 11ax20MIMO | 5500 | Type6 | 0 | 1 | 333.3 | 9 | 1 |
| | | Type6 | 1 | 1 | 333.3 | 9 | 1 |
| | | Type6 | 2 | 1 | 333.3 | 9 | 0 |
| | | Type6 | 3 | 1 | 333.3 | 9 | 1 |
| | | Type6 | 4 | 1 | 333.3 | 9 | 1 |
| | | Type6 | 5 | 1 | 333.3 | 9 | 0 |
| | | Type6 | 6 | 1 | 333.3 | 9 | 1 |
| | | Type6 | 7 | 1 | 333.3 | 9 | 1 |
| | | Type6 | 8 | 1 | 333.3 | 9 | 1 |
| | | Type6 | 9 | 1 | 333.3 | 9 | 1 |
| | | Type6 | 10 | 1 | 333.3 | 9 | 1 |
| | | Type6 | 11 | 1 | 333.3 | 9 | 1 |
| | | Type6 | 12 | 1 | 333.3 | 9 | 1 |
| | | Type6 | 13 | 1 | 333.3 | 9 | 1 |
| | | Type6 | 14 | 1 | 333.3 | 9 | 0 |
| | | Type6 | 15 | 1 | 333.3 | 9 | 1 |
| | | Type6 | 16 | 1 | 333.3 | 9 | 1 |
| | | Type6 | 17 | 1 | 333.3 | 9 | 1 |
| | | Type6 | 18 | 1 | 333.3 | 9 | 1 |
| | | Type6 | 19 | 1 | 333.3 | 9 | 1 |
| 111ax40MIMO | 5510 | Type6 | 0 | 1 | 333.3 | 9 | 1 |
| | | Type6 | 1 | 1 | 333.3 | 9 | 1 |
| | | Type6 | 2 | 1 | 333.3 | 9 | 1 |
| | | Type6 | 3 | 1 | 333.3 | 9 | 1 |
| | | Type6 | 4 | 1 | 333.3 | 9 | 1 |
| | | Type6 | 5 | 1 | 333.3 | 9 | 1 |
| | | Type6 | 6 | 1 | 333.3 | 9 | 1 |
| | | Type6 | 7 | 1 | 333.3 | 9 | 1 |
| | | Type6 | 8 | 1 | 333.3 | 9 | 1 |



Unless otherwise agreed in writing, this document is issued by the Company subject to its General Conditions of Service printed overleaf, available on request or accessible at <http://www.sgs.com/en/Terms-and-Conditions.aspx> and, for electronic format documents, subject to Terms and Conditions for Electronic Documents at <http://www.sgs.com/en/Terms-and-Conditions/Terms-e-Documents.aspx>. Attention is drawn to the limitation of liability, indemnification and jurisdiction issues defined therein. Any holder of this document is advised that information contained herein reflects the Company's findings at the time of its intervention only and within the limits of Client's instructions, if any. The Company's sole responsibility is to its Client and this document does not exonerate parties to a transaction from exercising all their rights and obligations under the transaction documents. This document cannot be reproduced except in full, without prior written approval of the Company. Any unauthorized alteration, forgery or falsification of the content or appearance of this document is unlawful and offenders may be prosecuted to the fullest extent of the law. Unless otherwise stated the results shown in this test report refer only to the sample(s) tested and such sample(s) are retained for 30 days only.

Attention: To check the authenticity of testing /inspection report & certificate, please contact us at telephone: (86-755) 8307 1443, or email: QN.Doccheck@sgs.com

| | | | | | | | |
|--|--|-------|----|---|-------|---|---|
| | | Type6 | 9 | 1 | 333.3 | 9 | 1 |
| | | Type6 | 10 | 1 | 333.3 | 9 | 1 |
| | | Type6 | 11 | 1 | 333.3 | 9 | 1 |
| | | Type6 | 12 | 1 | 333.3 | 9 | 1 |
| | | Type6 | 13 | 1 | 333.3 | 9 | 1 |
| | | Type6 | 14 | 1 | 333.3 | 9 | 1 |
| | | Type6 | 15 | 1 | 333.3 | 9 | 1 |
| | | Type6 | 16 | 1 | 333.3 | 9 | 1 |
| | | Type6 | 17 | 1 | 333.3 | 9 | 1 |
| | | Type6 | 18 | 1 | 333.3 | 9 | 1 |
| | | Type6 | 19 | 1 | 333.3 | 9 | 1 |
| | | Type6 | 20 | 1 | 333.3 | 9 | 0 |
| | | Type6 | 21 | 1 | 333.3 | 9 | 1 |
| | | Type6 | 22 | 1 | 333.3 | 9 | 1 |
| | | Type6 | 23 | 1 | 333.3 | 9 | 1 |
| | | Type6 | 24 | 1 | 333.3 | 9 | 1 |
| | | Type6 | 25 | 1 | 333.3 | 9 | 1 |
| | | Type6 | 26 | 1 | 333.3 | 9 | 1 |
| | | Type6 | 27 | 1 | 333.3 | 9 | 1 |
| | | Type6 | 28 | 1 | 333.3 | 9 | 1 |
| | | Type6 | 29 | 1 | 333.3 | 9 | 1 |
| | | Type6 | 0 | 1 | 333.3 | 9 | 1 |
| | | Type6 | 1 | 1 | 333.3 | 9 | 1 |
| | | Type6 | 2 | 1 | 333.3 | 9 | 1 |
| | | Type6 | 3 | 1 | 333.3 | 9 | 1 |
| | | Type6 | 4 | 1 | 333.3 | 9 | 1 |
| | | Type6 | 5 | 1 | 333.3 | 9 | 1 |
| | | Type6 | 6 | 1 | 333.3 | 9 | 1 |
| | | Type6 | 7 | 1 | 333.3 | 9 | 1 |
| | | Type6 | 8 | 1 | 333.3 | 9 | 1 |
| | | Type6 | 9 | 1 | 333.3 | 9 | 1 |
| | | Type6 | 10 | 1 | 333.3 | 9 | 1 |
| | | Type6 | 11 | 1 | 333.3 | 9 | 1 |
| | | Type6 | 12 | 1 | 333.3 | 9 | 1 |
| | | Type6 | 13 | 1 | 333.3 | 9 | 1 |
| | | Type6 | 14 | 1 | 333.3 | 9 | 1 |
| | | Type6 | 15 | 1 | 333.3 | 9 | 0 |
| | | Type6 | 16 | 1 | 333.3 | 9 | 1 |
| | | Type6 | 17 | 1 | 333.3 | 9 | 1 |
| | | Type6 | 18 | 1 | 333.3 | 9 | 1 |
| | | Type6 | 19 | 1 | 333.3 | 9 | 1 |
| | | Type6 | 20 | 1 | 333.3 | 9 | 1 |
| | | Type6 | 21 | 1 | 333.3 | 9 | 1 |
| | | Type6 | 22 | 1 | 333.3 | 9 | 1 |
| | | Type6 | 23 | 1 | 333.3 | 9 | 1 |
| | | Type6 | 24 | 1 | 333.3 | 9 | 1 |
| | | Type6 | 25 | 1 | 333.3 | 9 | 1 |
| | | Type6 | 26 | 1 | 333.3 | 9 | 1 |
| | | Type6 | 27 | 1 | 333.3 | 9 | 1 |
| | | Type6 | 28 | 1 | 333.3 | 9 | 1 |
| | | Type6 | 29 | 1 | 333.3 | 9 | 1 |
| | | Type6 | 0 | 1 | 333.3 | 9 | 1 |
| | | Type6 | 1 | 1 | 333.3 | 9 | 1 |
| | | Type6 | 2 | 1 | 333.3 | 9 | 1 |
| | | Type6 | 3 | 1 | 333.3 | 9 | 1 |
| | | Type6 | 4 | 1 | 333.3 | 9 | 1 |
| | | Type6 | 5 | 1 | 333.3 | 9 | 0 |



Unless otherwise agreed in writing, this document is issued by the Company subject to its General Conditions of Service printed overleaf, available on request or accessible at <http://www.sgs.com/en/Terms-and-Conditions.aspx> and, for electronic format documents, subject to Terms and Conditions for Electronic Documents at <http://www.sgs.com/en/Terms-and-Conditions/Terms-e-Documents.aspx>. Attention is drawn to the limitation of liability, indemnification and jurisdiction issues defined therein. Any holder of this document is advised that information contained herein reflects the Company's findings at the time of its intervention only and within the limits of Client's instructions, if any. The Company's sole responsibility is to its Client and this document does not exonerate parties to a transaction from exercising all their rights and obligations under the transaction documents. This document cannot be reproduced except in full, without prior written approval of the Company. Any unauthorized alteration, forgery or falsification of the content or appearance of this document is unlawful and offenders may be prosecuted to the fullest extent of the law. Unless otherwise stated the results shown in this test report refer only to the sample(s) tested and such sample(s) are retained for 30 days only.

Attention: To check the authenticity of testing/inspection report & certificate, please contact us at telephone: (86-755) 8307 1443, or email: CN.Doccheck@sgs.com

| | | | | | |
|-------|----|---|-------|---|---|
| Type6 | 6 | 1 | 333.3 | 9 | 1 |
| Type6 | 7 | 1 | 333.3 | 9 | 1 |
| Type6 | 8 | 1 | 333.3 | 9 | 1 |
| Type6 | 9 | 1 | 333.3 | 9 | 1 |
| Type6 | 10 | 1 | 333.3 | 9 | 1 |
| Type6 | 11 | 1 | 333.3 | 9 | 1 |
| Type6 | 12 | 1 | 333.3 | 9 | 1 |
| Type6 | 13 | 1 | 333.3 | 9 | 1 |
| Type6 | 14 | 1 | 333.3 | 9 | 1 |
| Type6 | 15 | 1 | 333.3 | 9 | 0 |
| Type6 | 16 | 1 | 333.3 | 9 | 1 |
| Type6 | 17 | 1 | 333.3 | 9 | 1 |
| Type6 | 18 | 1 | 333.3 | 9 | 1 |
| Type6 | 19 | 1 | 333.3 | 9 | 0 |
| Type6 | 20 | 1 | 333.3 | 9 | 1 |
| Type6 | 21 | 1 | 333.3 | 9 | 1 |
| Type6 | 22 | 1 | 333.3 | 9 | 1 |
| Type6 | 23 | 1 | 333.3 | 9 | 1 |
| Type6 | 24 | 1 | 333.3 | 9 | 0 |
| Type6 | 25 | 1 | 333.3 | 9 | 1 |
| Type6 | 26 | 1 | 333.3 | 9 | 1 |
| Type6 | 27 | 1 | 333.3 | 9 | 1 |
| Type6 | 28 | 1 | 333.3 | 9 | 1 |
| Type6 | 29 | 1 | 333.3 | 9 | 1 |

---End of Report---



Unless otherwise agreed in writing, this document is issued by the Company subject to its General Conditions of Service printed overleaf, available on request or accessible at <http://www.sgs.com/en/Terms-and-Conditions.aspx> and, for electronic format documents, subject to Terms and Conditions for Electronic Documents at <http://www.sgs.com/en/Terms-and-Conditions/Terms-e-Documents.aspx>. Attention is drawn to the limitation of liability, indemnification and jurisdiction issues defined therein. Any holder of this document is advised that information contained hereon reflects the Company's findings at the time of its intervention only and within the limits of Client's instructions, if any. The Company's sole responsibility is to its Client and this document does not exonerate parties to a transaction from exercising all their rights and obligations under the transaction documents. This document cannot be reproduced except in full, without prior written approval of the Company. Any unauthorized alteration, forgery or falsification of the content or appearance of this document is unlawful and offenders may be prosecuted to the fullest extent of the law. Unless otherwise stated the results shown in this test report refer only to the sample(s) tested and such sample(s) are retained for 30 days only.

Attention: To check the authenticity of testing /inspection report & certificate, please contact us at telephone: (86-755) 8307 1443, or email: CN.Doccheck@sgs.com