



# FCC RF Test Report

**APPLICANT** : Quectel Wireless Solutions Co., Ltd.  
**EQUIPMENT** : Smart Module  
**BRAND NAME** : Quectel  
**MODEL NAME** : SC668S-NA  
**FCC ID** : XMR2022SC668SNA  
**STANDARD** : 47 CFR Part 2, 22(H), 24(E), 27(L)  
**CLASSIFICATION** : PCS Licensed Transmitter (PCB)  
**TEST DATE(S)** : Feb. 04, 2023 ~ Feb. 08, 2023

We, Sporton International Inc. (Kunshan), would like to declare that the tested sample has been evaluated in accordance with the procedures given in ANSI C63.26-2015 and shown compliance with the applicable technical standards.

The test results in this report apply exclusively to the tested model / sample. Without written approval of Sporton International Inc. (Kunshan), the test report shall not be reproduced except in full.

Jason Jia

Approved by: Jason Jia



**Sporton International Inc. (Kunshan)**

**No. 1098, Pengxi North Road, Kunshan Economic Development Zone Jiangsu Province 215300  
People's Republic of China**



TABLE OF CONTENTS

REVISION HISTORY...3
SUMMARY OF TEST RESULT...4
1 GENERAL DESCRIPTION...5
1.1 Applicant...5
1.2 Manufacturer...5
1.3 Product Feature of Equipment Under Test...5
1.4 Product Specification of Equipment Under Test...6
1.5 Modification of EUT...6
1.6 Maximum Conducted Power and Emission Designator...7
1.7 Testing Location...9
1.8 Test Software...9
1.9 Applicable Standards...9
2 TEST CONFIGURATION OF EQUIPMENT UNDER TEST...10
2.1 Test Mode...10
2.2 Connection Diagram of Test System...11
2.3 Support Unit used in test configuration and system...12
2.4 Measurement Results Explanation Example...12
2.5 Frequency List of Low/Middle/High Channels...13
3 CONDUCTED TEST ITEMS...16
3.1 Measuring Instruments...16
3.2 Test Setup...16
3.3 Test Result of Conducted Test...16
3.4 Conducted Output Power and ERP/EIRP...17
3.5 Peak-to-Average Ratio...18
3.6 Occupied Bandwidth...19
3.7 Conducted Band Edge...20
3.8 Conducted Spurious Emission...22
3.9 Frequency Stability...23
4 RADIATED TEST ITEMS...24
4.1 Measuring Instruments...24
4.2 Test Setup...24
4.3 Test Result of Radiated Test...25
4.4 Radiated Spurious Emission...26
5 LIST OF MEASURING EQUIPMENT...27
6 UNCERTAINTY OF EVALUATION...28
APPENDIX A. TEST RESULTS OF CONDUCTED TEST
APPENDIX B. TEST RESULTS OF RADIATED TEST
APPENDIX C. TEST SETUP PHOTOGRAPHS



### REVISION HISTORY

REPORT NO.	VERSION	DESCRIPTION	ISSUED DATE
FG311713A	Rev. 01	Initial issue of report	Apr. 21, 2023



## SUMMARY OF TEST RESULT

Report Section	FCC Rule	Description	Limit	Result	Remark
3.4	§2.1046	Conducted Output Power	-	Report Only	-
	§22.913(a)(5)	Effective Radiated Power (Band 5) (Band 26)	ERP < 7 Watt	PASS	-
	§24.232(c)	Equivalent Isotropic Radiated Power (Band 2) (Band 25)	EIRP < 2Watt		-
	§27.50(d)(4)	Equivalent Isotropic Radiated Power (Band 4) (Band 66)	EIRP < 1Watt		-
3.5	§24.232(d)	Peak-to-Average Ratio	<13 dB	PASS	-
3.6	§2.1049	Occupied Bandwidth	-	Report Only	-
3.7	§2.1051 §22.917(a) §24.238(a) §27.53(h)	Conducted Band Edge Measurement (Band 2) (Band 4) (Band 5) (Band 25) (Band 26) (Band 66)	< 43+10log <sub>10</sub> (P[Watts])	PASS	-
3.8	§2.1051 §22.917(a) §24.238(a) §27.53(h)	Conducted Spurious Emission (Band 2) (Band 4) (Band 5) (Band 25) (Band 26) (Band 66)	< 43+10log <sub>10</sub> (P[Watts])	PASS	-
3.9	§2.1055 §22.355	Frequency Stability Temperature & Voltage	< 2.5 ppm for Part 22	PASS	-
	§2.1055 §24.235 §27.54		Within Authorized Band		
4.4	§2.1053 §22.917(a) §24.238(a) §27.53(h)	Radiated Spurious Emission (Band 2) (Band 4) (Band 5) (Band 25) (Band 26) (Band 66)	< 43+10log <sub>10</sub> (P[Watts])	PASS	Under limit 40.63 dB at 7584.360 MHz

**Declaration of Conformity:**

The test results with all measurement uncertainty excluded are presented in accordance with the regulation limits or requirements declared by manufacturers.

**Comments and Explanations:**

The declared of product specification for EUT presented in the report are provided by the manufacturer, and the manufacturer takes all the responsibilities for the accuracy of product specification.



# 1 General Description

## 1.1 Applicant

**Quectel Wireless Solutions Co., Ltd.**

Building 5, Shanghai Business Park Phase III (Area B), No.1016 Tianlin Road, Minhang District, Shanghai, 200233,China

## 1.2 Manufacturer

**Quectel Wireless Solutions Co., Ltd.**

Building 5, Shanghai Business Park Phase III (Area B), No.1016 Tianlin Road, Minhang District, Shanghai, 200233,China

## 1.3 Product Feature of Equipment Under Test

Product Feature	
Equipment	Smart Module
Brand Name	Quectel
Model Name	SC668S-NA
FCC ID	XMR2022SC668SNA
SN Code	Conducted: D1C22LT14000058 Radiation: D1C22LT14000064
HW Version	R1.0
SW Version	SC668SNANAR02A02
EUT Stage	Identical Prototype



### 1.4 Product Specification of Equipment Under Test

Standards-related Product Specification	
<b>Tx Frequency</b>	LTE Band 2 : 1850 MHz ~ 1910 MHz LTE Band 4 : 1710 MHz ~ 1755 MHz LTE Band 5 : 824 MHz ~ 849 MHz LTE Band 25 : 1850 MHz ~ 1915 MHz LTE Band 26 : 824 MHz ~ 849 MHz LTE Band 66 : 1710 MHz ~ 1780 MHz
<b>Rx Frequency</b>	LTE Band 2 : 1930 MHz ~ 1990 MHz LTE Band 4 : 2110 MHz ~ 2155 MHz LTE Band 5 : 869 MHz ~ 894 MHz LTE Band 25 : 1930 MHz ~ 1995 MHz LTE Band 26 : 869 MHz ~ 894 MHz LTE Band 66 : 2110 MHz~ 2180 MHz
<b>Bandwidth</b>	LTE Band 2 : 1.4MHz / 3MHz / 5MHz / 10MHz / 15MHz / 20MHz LTE Band 4 : 1.4MHz / 3MHz / 5MHz / 10MHz / 15MHz / 20MHz LTE Band 5 : 1.4MHz / 3MHz / 5MHz / 10MHz LTE Band 25 : 1.4MHz / 3MHz / 5MHz / 10MHz / 15MHz / 20MHz LTE Band 26 : 1.4MHz / 3MHz / 5MHz / 10MHz / 15MHz LTE Band 66 : 1.4MHz / 3MHz / 5MHz / 10MHz / 15MHz / 20MHz
<b>Antenna Type</b>	Fixed External Antenna
<b>Maximum Output Power to Antenna</b>	LTE Band 2 : 23.46 dBm LTE Band 4 : 23.55 dBm LTE Band 5 : 23.06 dBm LTE Band 25 : 23.71 dBm LTE Band 26 : 23.15 dBm LTE Band 66 : 23.61 dBm
<b>Antenna Gain</b>	LTE Band 2 : 1.59 dBi LTE Band 4 : 2.00 dBi LTE Band 5 : 2.53 dBi LTE Band 25 : 1.59 dBi LTE Band 26 : 2.53 dBi LTE Band 66 : 2.00 dBi
<b>Type of Modulation</b>	QPSK / 16QAM

### 1.5 Modification of EUT

No modifications are made to the EUT during all test items.



### 1.6 Maximum Conducted Power and Emission Designator

LTE Band 2		QPSK		16QAM	
BW (MHz)	Frequency Range (MHz)	Maximum Conducted power (W)	Emission Designator (99%OBW)	Maximum Conducted power (W)	Emission Designator (99%OBW)
1.4	1850.7 ~ 1909.3	0.2173	1M09G7D	0.1901	1M09W7D
3	1851.5 ~ 1908.5	0.2198	2M73G7D	0.1884	2M72W7D
5	1852.5 ~ 1907.5	0.2213	4M51G7D	0.1875	4M49W7D
10	1855.0 ~ 1905.0	0.2208	9M03G7D	0.1884	9M01W7D
15	1857.5 ~ 1902.5	0.2198	13M4G7D	0.1897	13M4W7D
20	1860.0 ~ 1900.0	0.2218	17M9G7D	0.1910	17M8W7D
LTE Band 25		QPSK		16QAM	
BW (MHz)	Frequency Range (MHz)	Maximum Conducted power (W)	Emission Designator (99%OBW)	Maximum Conducted power (W)	Emission Designator (99%OBW)
1.4	1850.7 ~ 1914.3	0.2213	1M09G7D	0.1875	1M09W7D
3	1851.5 ~ 1913.5	0.2270	2M73G7D	0.1968	2M72W7D
5	1852.5 ~ 1912.5	0.2254	4M51G7D	0.1950	4M49W7D
10	1855.0 ~ 1910.0	0.2339	9M03G7D	0.2000	9M01W7D
15	1857.5 ~ 1907.5	0.2307	13M4G7D	0.2009	13M4W7D
20	1860.0 ~ 1905.0	0.2350	17M9G7D	0.2018	17M8W7D
LTE Band 4		QPSK		16QAM	
BW (MHz)	Frequency Range (MHz)	Maximum Conducted power (W)	Emission Designator (99%OBW)	Maximum Conducted power (W)	Emission Designator (99%OBW)
1.4	1710.7 ~ 1754.3	0.2183	1M09G7D	0.1923	1M09W7D
3	1711.5 ~ 1753.5	0.2198	2M72G7D	0.1914	2M74W7D
5	1712.5 ~ 1752.5	0.2213	4M48G7D	0.1919	4M48W7D
10	1715.0 ~ 1750.0	0.2193	9M05G7D	0.1914	9M01W7D
15	1717.5 ~ 1747.5	0.2198	13M5G7D	0.1936	13M4W7D
20	1720.0 ~ 1745.0	0.2265	17M8G7D	0.1941	17M8W7D
LTE Band 5		QPSK		16QAM	
BW (MHz)	Frequency Range (MHz)	Maximum Conducted power (W)	Emission Designator (99%OBW)	Maximum Conducted power (W)	Emission Designator (99%OBW)
1.4	824.7 ~ 848.3	0.1982	1M09G7D	0.1774	1M09W7D
3	825.5 ~ 847.5	0.2004	3M73G7D	0.1710	2M72W7D
5	826.5 ~ 846.5	0.2009	4M51G7D	0.1758	4M49W7D
10	829.0 ~ 844.0	0.2023	9M05G7D	0.1803	9M07W7D



LTE Band 26		QPSK		16QAM	
BW (MHz)	Frequency Range (MHz)	Maximum Conducted power (W)	Emission Designator (99%OBW)	Maximum Conducted power (W)	Emission Designator (99%OBW)
1.4	824.7 ~ 848.3	0.1982	1M09G7D	0.1694	1M09W7D
3	825.5 ~ 847.5	0.2000	3M73G7D	0.1726	2M72W7D
5	826.5 ~ 846.5	0.2009	4M51G7D	0.1746	4M49W7D
10	829.0 ~ 844.0	0.2032	9M05G7D	0.1778	9M07W7D
15	831.5 ~ 841.5	0.2065	13M5G7D	0.1778	13M4W7D
CH26790	824.0	0.1991	13M4G7D	0.1722	13M4W7D
LTE Band 66		QPSK		16QAM	
BW (MHz)	Frequency Range (MHz)	Maximum Conducted power (W)	Emission Designator (99%OBW)	Maximum Conducted power (W)	Emission Designator (99%OBW)
1.4	1710.7 ~ 1779.3	0.2265	1M09G7D	0.1963	1M09W7D
3	1711.5 ~ 1778.5	0.2254	2M72G7D	0.1928	2M74W7D
5	1712.5 ~ 1777.5	0.2259	4M48G7D	0.1963	4M48W7D
10	1715.0 ~ 1775.0	0.2249	9M05G7D	0.1972	9M01W7D
15	1717.5 ~ 1772.5	0.2286	13M5G7D	0.1977	13M4W7D
20	1720.0 ~ 1770.0	0.2296	17M8G7D	0.2234	17M8W7D

Note:

1. LTE Band 26 overlaps the entire frequency range of LTE Band 5. Therefore, the test results provided in this report covers Band 5 and the portion of Band 26 subject to Part 22.
2. LTE Band 66 overlaps the entire frequency range of LTE Band 4. Therefore, the test results provided in this report covers Band 66 as well as Band 4.
3. LTE Band 25 overlaps the entire frequency range of LTE Band 2. Therefore, the test results provided in this report covers Band 25 as well as Band 2.





### 1.7 Testing Location

Sporton International Inc. (Kunshan) is accredited to ISO/IEC 17025:2017 by American Association for Laboratory Accreditation with Certificate Number 5145.02.

<b>Test Firm</b>	Sporton International Inc. (Kunshan)		
<b>Test Site Location</b>	No. 1098, Pengxi North Road, Kunshan Economic Development Zone Jiangsu Province 215300 People's Republic of China TEL : +86-512-57900158		
<b>Test Site No.</b>	<b>Sporton Site No.</b>	<b>FCC Designation No.</b>	<b>FCC Test Firm Registration No.</b>
	03CH04-KS TH01-KS	CN1257	314309

### 1.8 Test Software

Item	Site	Manufacturer	Name	Version
1.	03CH04-KS	AUDIX	E3	6.2009-8-24al

### 1.9 Applicable Standards

According to the specifications of the manufacturer, the EUT must comply with the requirements of the following standards:

- ♦ 47 CFR Part 2, 22(H), 24(E), 27(L)
- ♦ ANSI C63.26-2015
- ♦ FCC KDB 971168 D01 Power Meas License Digital Systems v03r01
- ♦ FCC KDB 412172 D01 Determining ERP and EIRP v01r01

**Remark:**

1. All test items were verified and recorded according to the standards and without any deviation during the test.
2. This EUT has also been tested and complied with the requirements of FCC Part 15, Subpart B, recorded in a separate test report.



## 2 Test Configuration of Equipment Under Test

### 2.1 Test Mode

Antenna port conducted and radiated test items listed below are performed according to KDB 971168 D01 Power Meas License Digital Systems v03r01 with maximum output power.

Radiated measurements are performed by rotating the EUT in three different orthogonal test planes to find the maximum emission. (X Plane)

Test Items	Band	Bandwidth (MHz)						Modulation				RB #			Test Channel		
		1.4	3	5	10	15	20	QPSK	16QAM	64QAM	256QAM	1	Half	Full	L	M	H
Max. Output Power	2	v	v	v	v	v	v	v	v	-	-	v		v	v	v	v
	4	v	v	v	v	v	v	v	v	-	-	v		v	v	v	v
	5	v	v	v	v	-	-	v	v	-	-	v		v	v	v	v
	25	v	v	v	v	v	v	v	v	-	-	v		v	v	v	v
	26	v	v	v	v	v	-	v	v	-	-	v		v	v	v	v
	66	v	v	v	v	v	v	v	v	-	-	v		v	v	v	v
Peak-to-Average Ratio	25						v	v	v	-	-	v		v		v	
	26				v		-	v	v	-	-	v		v		v	
	66						v	v	v	-	-	v		v		v	
26dB and 99% Bandwidth	25	v	v	v	v	v	v	v	v	-	-			v		v	
	26	v	v	v	v	v	-	v	v	-	-			v		v	
	66	v	v	v	v	v	v	v	v	-	-			v		v	
Conducted Band Edge	25	v	v	v	v	v	v	v	v	-	-	v		v	v		v
	26	v	v	v	v	v	-	v	v	-	-	v		v	v		v
	66	v	v	v	v	v	v	v	v	-	-	v		v	v		v
Conducted Spurious Emission	25	v	v	v	v	v	v	v		-	-	v			v	v	v
	26	v	v	v	v	v	-	v		-	-	v			v	v	v
	66	v	v	v	v	v	v	v		-	-	v			v	v	v
Frequency Stability	25				v			v		-	-			v		v	
	26				v		-	v		-	-			v		v	
	66				v			v		-	-			v		v	

Test Items	Band	Bandwidth (MHz)						Modulation				RB #			Test Channel		
		1.4	3	5	10	15	20	QPSK	16QAM	64QAM	256QAM	1	Half	Full	L	M	H
E.R.P / E.I.R.P	2	v	v	v	v	v	v	v	v	-	-	v		v	v	v	v
	4	v	v	v	v	v	v	v	v	-	-	v		v	v	v	v
	5	v	v	v	v	-	-	v	v	-	-	v		v	v	v	v
	25	v	v	v	v	v	v	v	v	-	-	v		v	v	v	v
	26	v	v	v	v	v	-	v	v	-	-	v		v	v	v	v
	66	v	v	v	v	v	v	v	v	-	-	v		v	v	v	v
Radiated Spurious Emission	25	Worst Case												v	v	v	
	26	Worst Case												v	v	v	
	66	Worst Case												v	v	v	
Note	1. The mark "v" means that this configuration is chosen for testing 2. The mark "-" means that this bandwidth is not supported. 3. The device is investigated from 30MHz to 10 times of fundamental signal for radiated spurious emission test under different RB size/offset and modulations in exploratory test. Subsequently, only the worst case emissions are reported.																

## 2.2 Connection Diagram of Test System

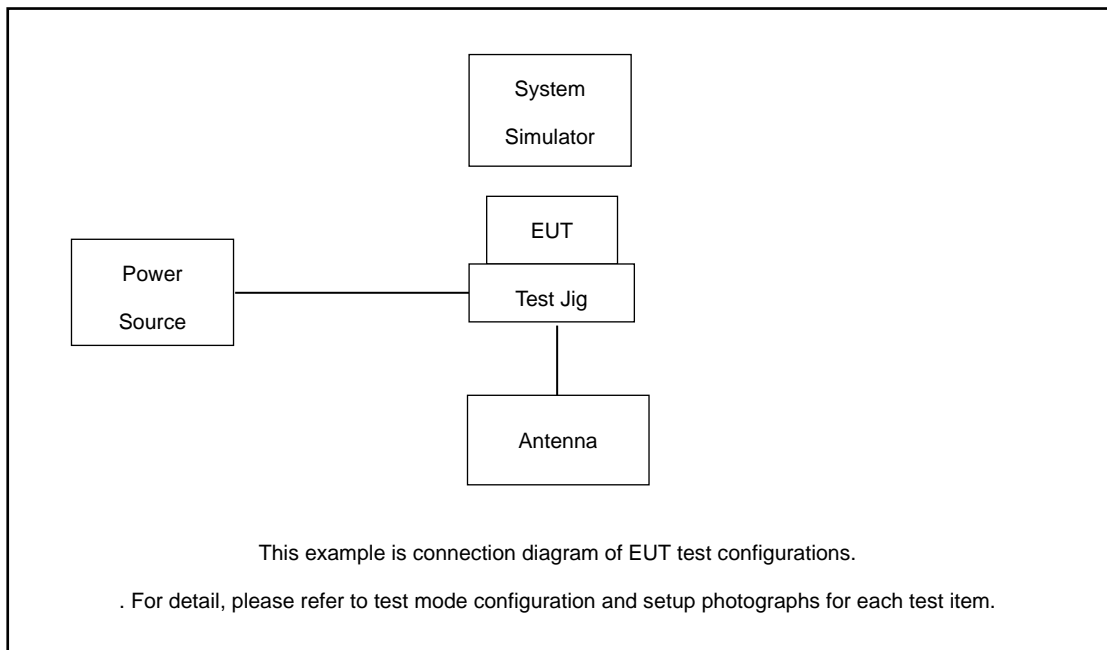

## 2.3 Support Unit used in test configuration and system

Item	Equipment	Trade Name	Model No.	FCC ID	Data Cable	Power Cord
1.	Power Supply	GWINSTEK	PSS-2002	N/A	N/A	Unshielded, 1.8 m
2.	Base Station	Anritsu	MT8820/8821	N/A	N/A	Unshielded, 1.8 m
3.	Adapter	N/A	N/A	N/A	N/A	N/A
4.	Test Jig	N/A	N/A	N/A	N/A	N/A
5.	Antenna	N/A	N/A	N/A	N/A	N/A

## 2.4 Measurement Results Explanation Example

### For all conducted test items:

The offset level is set in the spectrum analyzer to compensate the RF cable loss between EUT conducted output port and spectrum analyzer. With the offset compensation, the spectrum analyzer reading level is exactly the EUT RF output level.

The spectrum analyzer offset is derived from RF cable loss.

*Offset = RF cable loss.*

Following shows an offset computation example with cable loss 5.4 dB.

Example :

$$\begin{aligned} \text{Offset(dB)} &= \text{RF cable loss(dB)}. \\ &= 5.4 \text{ (dB)} \end{aligned}$$



### 2.5 Frequency List of Low/Middle/High Channels

LTE Band 2 Channel and Frequency List				
BW [MHz]	Channel/Frequency(MHz)	Lowest	Middle	Highest
20	Channel	18700	18900	19100
	Frequency	1860	1880	1900
15	Channel	18675	18900	19125
	Frequency	1857.5	1880	1902.5
10	Channel	18650	18900	19150
	Frequency	1855	1880	1905
5	Channel	18625	18900	19175
	Frequency	1852.5	1880	1907.5
3	Channel	18615	18900	19185
	Frequency	1851.5	1880	1908.5
1.4	Channel	18607	18900	19193
	Frequency	1850.7	1880	1909.3

LTE Band 4 Channel and Frequency List				
BW [MHz]	Channel/Frequency(MHz)	Lowest	Middle	Highest
20	Channel	20050	20175	20300
	Frequency	1720	1732.5	1745
15	Channel	20025	20175	20325
	Frequency	1717.5	1732.5	1747.5
10	Channel	20000	20175	20350
	Frequency	1715	1732.5	1750
5	Channel	19975	20175	20375
	Frequency	1712.5	1732.5	1752.5
3	Channel	19965	20175	20385
	Frequency	1711.5	1732.5	1753.5
1.4	Channel	19957	20175	20393
	Frequency	1710.7	1732.5	1754.3



LTE Band 5 Channel and Frequency List				
BW [MHz]	Channel/Frequency(MHz)	Lowest	Middle	Highest
10	Channel	20450	20525	20600
	Frequency	829	836.5	844
5	Channel	20425	20525	20625
	Frequency	826.5	836.5	846.5
3	Channel	20415	20525	20635
	Frequency	825.5	836.5	847.5
1.4	Channel	20407	20525	20643
	Frequency	824.7	836.5	848.3

LTE Band 25 Channel and Frequency List				
BW [MHz]	Channel/Frequency(MHz)	Lowest	Middle	Highest
20	Channel	26140	26340	26590
	Frequency	1860	1880	1905
15	Channel	26115	26340	26615
	Frequency	1857.5	1880	1907.5
10	Channel	26090	26340	26640
	Frequency	1855	1880	1910
5	Channel	26065	26340	26665
	Frequency	1852.5	1880	1912.5
3	Channel	26055	26340	26675
	Frequency	1851.5	1880	1913.5
1.4	Channel	26047	26340	26683
	Frequency	1850.7	1880	1914.3



LTE Band 26 Channel and Frequency List				
BW [MHz]	Channel/Frequency(MHz)	Lowest	Middle	Highest
15	Channel	26865	26915	26965
	Frequency	831.5	836.5	841.5
10	Channel	26840	26915	26990
	Frequency	829	836.5	844
5	Channel	26815	26915	27015
	Frequency	826.5	836.5	846.5
3	Channel	26805	26915	27025
	Frequency	825.5	836.5	847.5
1.4	Channel	26797	26915	27033
	Frequency	824.7	836.5	848.3

LTE Band 66 Channel and Frequency List				
BW [MHz]	Channel/Frequency(MHz)	Lowest	Middle	Highest
20	Channel	132072	132322	132572
	Frequency	1720	1745	1770
15	Channel	132047	132322	132597
	Frequency	1717.5	1745	1772.5
10	Channel	132022	132322	132622
	Frequency	1715	1745	1775
5	Channel	131997	132322	132647
	Frequency	1712.5	1745	1777.5
3	Channel	131987	132322	132657
	Frequency	1711.5	1745	1778.5
1.4	Channel	131979	132322	132665
	Frequency	1710.7	1745	1779.3

### 3 Conducted Test Items

#### 3.1 Measuring Instruments

See list of measuring instruments of this test report.

#### 3.2 Test Setup

##### 3.2.1 Conducted Output Power

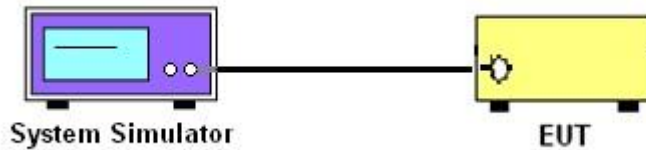

##### 3.2.2 Peak-to-Average Ratio, Occupied Bandwidth ,Conducted Band-Edge and Conducted Spurious Emission



##### 3.2.3 Frequency Stability

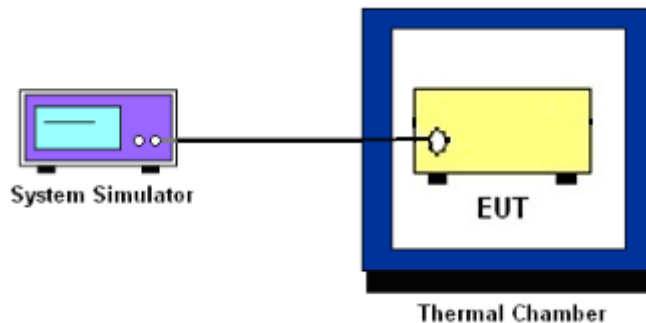

### 3.3 Test Result of Conducted Test

Please refer to Appendix A.





### 3.4 Conducted Output Power and ERP/EIRP

#### 3.4.1 Description of the Conducted Output Power Measurement and ERP/EIRP Measurement

A system simulator was used to establish communication with the EUT. Its parameters were set to force the EUT transmitting at maximum output power. The measured power in the radio frequency on the transmitter output terminals shall be reported.

The ERP of mobile transmitters must not exceed 7 Watts for LTE Band 5 and Band 26.

The EIRP of mobile transmitters must not exceed 2 Watts for LTE Band 2 and Band 25

The EIRP of mobile transmitters must not exceed 1 Watts for LTE Band 4 and Band 66.

According to KDB 412172 D01 Power Approach,

$EIRP = P_T + G_T - L_C$ ,  $ERP = EIRP - 2.15$ , where

$P_T$  = transmitter output power in dBm

$G_T$  = gain of the transmitting antenna in dBi

$L_C$  = signal attenuation in the connecting cable between the transmitter and antenna in dB

#### 3.4.2 Test Procedures

1. The testing follows ANSI C63.26 Section 5.2
2. The transmitter output port was connected to the system simulator.
3. Set EUT at maximum power through the system simulator.
4. Select lowest, middle, and highest channels for each band and different modulation.
5. Measure and record the power level from the system simulator.



## 3.5 Peak-to-Average Ratio

### 3.5.1 Description of the PAR Measurement

Power Complementary Cumulative Distribution Function (CCDF) curves provide a means for characterizing the power peaks of a digitally modulated signal on a statistical basis. A CCDF curve depicts the probability of the peak signal amplitude exceeding the average power level. Most contemporary measurement instrumentation include the capability to produce CCDF curves for an input signal provided that the instrument's resolution bandwidth can be set wide enough to accommodate the entire input signal bandwidth. In measuring transmissions in this band using an average power technique, the peak-to-average ratio (PAR) of the transmission may not exceed 13 dB.

### 3.5.2 Test Procedures

1. The testing follows ANSI C63.26 Section 5.2.3.4 (CCDF).
2. The EUT was connected to spectrum and system simulator via a power divider.
3. Set the CCDF (Complementary Cumulative Distribution Function) option in spectrum analyzer.
4. The highest RF powers were measured and recorded the maximum PAPR level associated with a probability of 0.1 %.
5. Record the deviation as Peak to Average Ratio.



## 3.6 Occupied Bandwidth

### 3.6.1 Description of Occupied Bandwidth Measurement

The occupied bandwidth is the width of a frequency band such that, below the lower and above the upper frequency limits, the mean powers emitted are each equal to a specified percentage 0.5% of the total mean transmitted power.

The 26 dB emission bandwidth is defined as the frequency range between two points, one above and one below the carrier frequency, at which the spectral density of the emission is attenuated 26 dB below the maximum in-band spectral density of the modulated signal. Spectral density (power per unit bandwidth) is to be measured with a detector of resolution bandwidth equal to approximately 1.0% of the emission bandwidth.

### 3.6.2 Test Procedures

1. The testing follows ANSI C63.26 Section 5.4
2. The EUT was connected to spectrum analyzer and system simulator via a power divider.
3. The spectrum analyzer center frequency is set to the nominal EUT channel center frequency. The span range for the spectrum analyzer shall be between two and five times the anticipated OBW.
4. The nominal resolution bandwidth (RBW) shall be in the range of 1 to 5 % of the anticipated OBW, and the VBW shall be at least 3 times the RBW.
5. Set the detection mode to peak, and the trace mode to max hold.
6. Determine the reference value: Set the EUT to transmit a modulated signal. Allow the trace to stabilize. Set the spectrum analyzer marker to the highest level of the displayed trace.  
(this is the reference value)
7. Determine the “-26 dB down amplitude” as equal to (Reference Value – X).
8. Place two markers, one at the lowest and the other at the highest frequency of the envelope of the spectral display such that each marker is at or slightly below the “-X dB down amplitude” determined in step 6. If a marker is below this “-X dB down amplitude” value it shall be placed as close as possible to this value. The OBW is the positive frequency difference between the two markers.
9. Use the 99 % power bandwidth function of the spectrum analyzer and report the measured bandwidth.



## 3.7 Conducted Band Edge

### 3.7.1 Description of Conducted Band Edge Measurement

22.917(a)

For operations in the 824 – 849 MHz band, the FCC limit is  $43 + 10\log_{10}(P[\text{Watts}])$  dB below the transmitter power  $P(\text{Watts})$  in a 100kHz bandwidth. However, in the 1MHz bands immediately outside and adjacent to the licensee's frequency block, a resolution bandwidth of at least one percent of the emission bandwidth of the fundamental emission of the transmitter may be employed.

24.238 (a)

For operations in the 1850-1910 and 1930-1990 MHz band, the FCC limit is  $43 + 10\log_{10}(P[\text{Watts}])$  dB below the transmitter power  $P(\text{Watts})$  in a 1MHz bandwidth. However, in the 1 MHz bands immediately outside and adjacent to the frequency block a resolution bandwidth of at least one percent of the emission bandwidth of the fundamental emission of the transmitter may be employed.

27.53 (h)

For operations in the 1710 – 1755 MHz and 1710 – 1780 MHz band, the FCC limit is  $43 + 10\log_{10}(P[\text{Watts}])$  dB below the transmitter power  $P(\text{Watts})$  in a 1 MHz bandwidth. However, in the 1MHz bands immediately outside and adjacent to the licensee's frequency block, a resolution bandwidth of at least one percent of the emission bandwidth of the fundamental emission of the transmitter may be employed.



### 3.7.2 Test Procedures

1. The testing follows ANSI C63.26 section 5.7
2. The EUT was connected to spectrum analyzer and system simulator via a power divider.
3. The band edges of low and high channels for the highest RF powers were measured.
4. Set RBW  $\geq$  1% EBW in the 1MHz band immediately outside and adjacent to the band edge.
5. Beyond the 1 MHz band from the band edge, RBW=1MHz was used or a narrower RBW was used and the measured power was integrated over the full required measurement bandwidth of 1 MHz.
6. Set spectrum analyzer with RMS detector.
7. The RF fundamental frequency should be excluded against the limit line in the operating frequency band.
8. Checked that all the results comply with the emission limit line.

Example:

The limit line is derived from  $43 + 10\log(P)$ dB below the transmitter power P(Watts)

$$= P(W) - [43 + 10\log(P)] \text{ (dB)}$$

$$= [30 + 10\log(P)] \text{ (dBm)} - [43 + 10\log(P)] \text{ (dB)} = -13\text{dBm}.$$

9. When using the integration method, the starting frequency of the integration shall be centered at one-half of the RBW away from the band edge.



### 3.8 Conducted Spurious Emission

#### 3.8.1 Description of Conducted Spurious Emission Measurement

The power of any emission outside of the authorized operating frequency ranges must be lower than the transmitter power (P) by a factor of at least  $43 + 10 \log (P)$  dB.

It is measured by means of a calibrated spectrum analyzer and scanned from 30 MHz up to a frequency including its 10<sup>th</sup> harmonic.

#### 3.8.2 Test Procedures

1. The testing follows ANSI C63.26 section 5.7
2. The EUT was connected to spectrum analyzer and system simulator via a power divider.
3. The RF output of EUT was connected to the spectrum analyzer by RF cable and attenuator. The path loss was compensated to the results for each measurement.
4. The middle channel for the highest RF power within the transmitting frequency was measured.
5. The conducted spurious emission for the whole frequency range was taken.
6. Make the measurement with the spectrum analyzer's RBW = 1MHz, VBW = 3MHz.
7. Set spectrum analyzer with RMS detector.
8. Taking the record of maximum spurious emission.
9. The RF fundamental frequency should be excluded against the limit line in the operating frequency band.
10. The limit line is derived from  $43 + 10\log(P)$ dB below the transmitter power P(Watts)  
=  $P(W) - [43 + 10\log(P)]$  (dB)  
=  $[30 + 10\log(P)]$  (dBm) -  $[43 + 10\log(P)]$  (dB)  
= -13dBm.



## 3.9 Frequency Stability

### 3.9.1 Description of Frequency Stability Measurement

The frequency stability shall be measured by variation of ambient temperature and variation of primary supply voltage to ensure that the fundamental emission stays within the authorized frequency block. The frequency stability of the transmitter shall be maintained within  $\pm 0.00025\%$  ( $\pm 2.5\text{ppm}$ ) of the center frequency.

### 3.9.2 Test Procedures for Temperature Variation

1. The testing follows ANSI C63.26 section 5.6.4
2. The EUT was set up in the thermal chamber and connected with the system simulator.
3. With power OFF, the temperature was decreased to  $-30^{\circ}\text{C}$  and the EUT was stabilized before testing. Power was applied and the maximum change in frequency was recorded within one minute.
4. With power OFF, the temperature was raised in  $10^{\circ}\text{C}$  step up to  $50^{\circ}\text{C}$ . The EUT was stabilized at each step for at least half an hour. Power was applied and the maximum frequency change was recorded within one minute.

### 3.9.3 Test Procedures for Voltage Variation

1. The testing follows ANSI C63.26 section 5.6.5
2. The EUT was placed in a temperature chamber at  $20\pm 5^{\circ}\text{C}$  and connected with the system simulator.
3. The power supply voltage to the EUT was varied from 85% to 115% of the nominal value for other than hand carried battery equipment.
4. For hand carried, battery powered equipment, reduce the primary ac or dc supply voltage to the battery operating end point, which shall be specified by the manufacturer.
5. The variation in frequency was measured for the worst case.

## 4 Radiated Test Items

### 4.1 Measuring Instruments

See list of measuring instruments of this test report.

### 4.2 Test Setup

#### 4.2.1 For radiated test below 30MHz

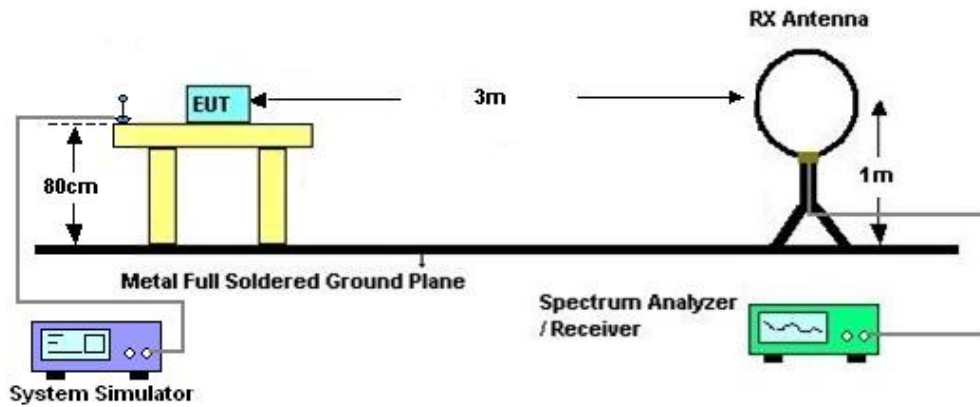

#### 4.2.2 For radiated test from 30MHz to 1GHz

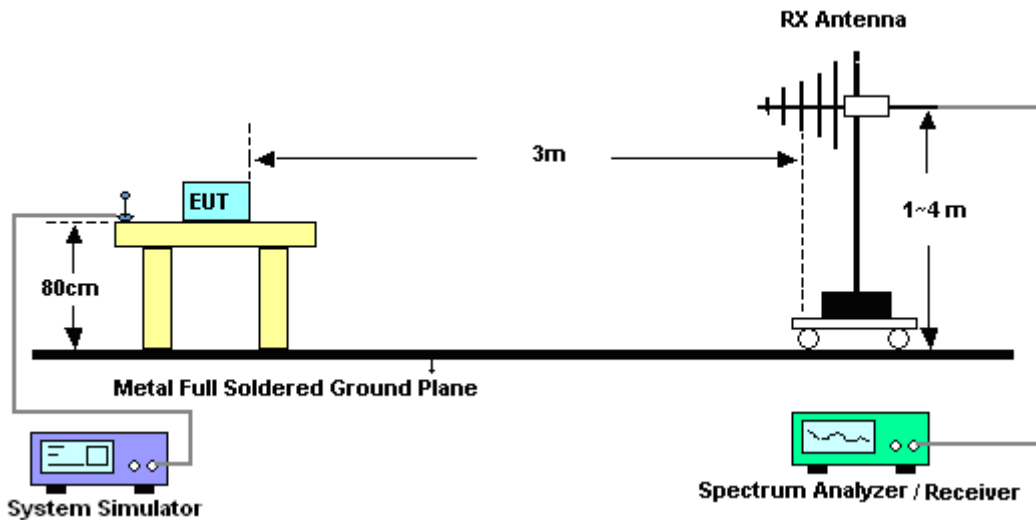



### 4.2.3 For radiated test above 1GHz

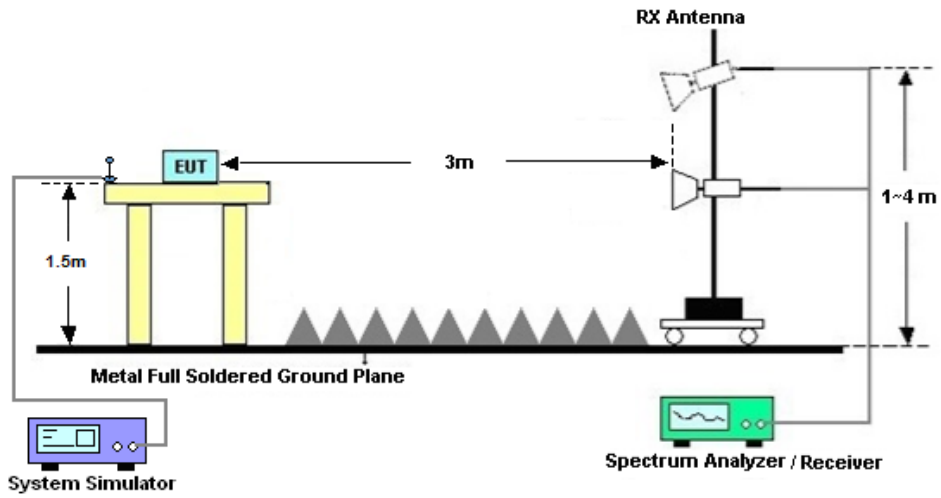

### 4.3 Test Result of Radiated Test

The low frequency, which started from 9 kHz to 30MHz, was pre-scanned and the result which was 20dB lower than the limit line was not reported.

Please refer to Appendix B.



## 4.4 Radiated Spurious Emission

### 4.4.1 Description of Radiated Spurious Emission

The radiated spurious emission was measured by substitution method according to ANSI C63.26. The power of any emission outside of the authorized operating frequency ranges must be attenuated below the transmitter power (P) by a factor of at least  $43 + 10 \log(P)$  dB.

The spectrum is scanned from 30 MHz up to a frequency including its 10th harmonic.

### 4.4.2 Test Procedures

1. The testing follows ANSI C63.26 Section 5.5
2. The EUT was placed on a turntable with 0.8 meter height for frequency below 1GHz and 1.5 meter height for frequency above 1GHz respectively above ground.
3. The EUT was set 3 meters from the receiving antenna mounted on the antenna tower.
4. The table was rotated 360 degrees to determine the position of the highest spurious emission.
5. The height of the receiving antenna is varied between 1m to 4m to search the maximum spurious emission for both horizontal and vertical polarizations.
6. During the measurement, the system simulator parameters were set to force the EUT transmitting at maximum output power.
7. Make the measurement with the spectrum analyzer's RBW = 1MHz, VBW = 3MHz, taking the record of maximum spurious emission.
8. A horn antenna was substituted in place of the EUT and was driven by a signal generator.
9. Tune the output power of signal generator to the same emission level with EUT maximum spurious emission.
10.  $EIRP \text{ (dBm)} = S.G. \text{ Power} - Tx \text{ Cable Loss} + Tx \text{ Antenna Gain}$
11.  $ERP \text{ (dBm)} = EIRP - 2.15$
12. The RF fundamental frequency should be excluded against the limit line in the operating frequency band.

The limit line is derived from  $43 + 10\log(P)$ dB below the transmitter power P(Watts)  
=  $P(W) - [43 + 10\log(P)]$  (dB)  
=  $[30 + 10\log(P)]$  (dBm) -  $[43 + 10\log(P)]$  (dB)  
= -13dBm.



## 5 List of Measuring Equipment

Instrument	Manufacturer	Model No.	Serial No.	Characteristics	Calibration Date	Test Date	Due Date	Remark
EXA Spectrum Analyzer	Keysight	N9010B	MY57471079	10Hz-44G,MAX 30dB	Oct. 12, 2022	Feb. 07, 2023	Oct. 11, 2023	Radiation (03CH04-KS)
Loop Antenna	R&S	HFH2-Z2	100321	9kHz~30MHz	Oct. 16, 2022	Feb. 07, 2023	Oct. 15, 2023	Radiation (03CH04-KS)
Bilog Antenna	TeseQ	CBL6111D	49922	30MHz-1GHz	May 24, 2022	Feb. 07, 2023	May 23, 2023	Radiation (03CH04-KS)
Horn Antenna	Schwarzbeck	BBHA9120D	1284	1GHz~18GHz	Jan. 04, 2023	Feb. 07, 2023	Jan. 03, 2024	Radiation (03CH04-KS)
SHF-EHF Horn	Com-power	AH-840	101070	18GHz~40GHz	Jan. 04, 2023	Feb. 07, 2023	Jan. 03, 2024	Radiation (03CH04-KS)
Amplifier	SONOMA	310N	187289	9KHz-1GHz	Jan. 04, 2023	Feb. 07, 2023	Jan. 03, 2024	Radiation (03CH04-KS)
Amplifier	MITEQ	EM18G40G GA	060728	18~40GHz	Jan. 04, 2023	Feb. 07, 2023	Jan. 03, 2024	Radiation (03CH04-KS)
high gain Amplifier	EM	EM01G18G A	060840	1Ghz-18Ghz	Oct. 12, 2022	Feb. 07, 2023	Oct. 11, 2023	Radiation (03CH04-KS)
Amplifier	Agilent	8449B	3008A02370	1Ghz-18Ghz	Oct. 12, 2022	Feb. 07, 2023	Oct. 11, 2023	Radiation (03CH04-KS)
AC Power Source	Chroma	61601	F104090004	N/A	NCR	Feb. 07, 2023	NCR	Radiation (03CH04-KS)
Turn Table	ChamPro	EM 1000-T	060762-T	0~360 degree	NCR	Feb. 07, 2023	NCR	Radiation (03CH04-KS)
Antenna Mast	ChamPro	EM 1000-A	060762-A	1 m~4 m	NCR	Feb. 07, 2023	NCR	Radiation (03CH04-KS)
Spectrum Analyzer	R&S	FSV40	101040	10Hz~40GHz	Oct. 12, 2022	Feb. 04, 2023~ Feb. 08, 2023	Oct. 11, 2023	Conducted (TH01-KS)
Power divider	STI	STI08-0055	-	0.5~40GHz	NCR	Feb. 04, 2023~ Feb. 08, 2023	NCR	Conducted (TH01-KS)
Temperature & humidity chamber	Hongzhan	LP-150U	H2014011440	-40~+150°C 20%~95%RH	Jul. 15, 2022	Feb. 04, 2023~ Feb. 08, 2023	Jul. 14, 2023	Conducted (TH01-KS)

NCR: No Calibration Required



## 6 Uncertainty of Evaluation

The measurement uncertainties shown below were calculated in accordance with the requirements of ANSI 63.26-2015. All the measurement uncertainty value were shown with a coverage K=2 to indicate 95% level of confidence. The measurement data show herein meets or exceeds the CISPR measurement uncertainty values specified in CISPR 16-4-2 and can be compared directly to specified limit to determine compliance.

### Uncertainty of Conducted Measurement

Test Item	Uncertainty
Conducted Power	±0.46 dB
Conducted Emissions	±0.48 dB
Occupied Channel Bandwidth	±0.1 %

### Uncertainty of Radiated Emission Measurement (30 MHz ~ 1000 MHz)

Measuring Uncertainty for a Level of Confidence of 95% (U = 2Uc(y))	3.3dB
---	-------

### Uncertainty of Radiated Emission Measurement (1 GHz ~ 18 GHz)

Measuring Uncertainty for a Level of Confidence of 95% (U = 2Uc(y))	2.8dB
---	-------

### Uncertainty of Radiated Emission Measurement (18 GHz ~ 40 GHz)

Measuring Uncertainty for a Level of Confidence of 95% (U = 2Uc(y))	2.8dB
---	-------



## Appendix A. Test Results of Conducted Test

Test Engineer :	Simle Wang	Temperature :	22~23°C
		Relative Humidity :	40~42%

### Conducted Output Power(Average power) and ERP/EIRP

LTE Band 2									
BW [MHz]	Modulation	RB Size	RB Offset	Power Low Ch. / Freq.	Power Middle Ch. / Freq.	Power High Ch. / Freq.	EIRP(W)		
Channel				18700	18900	19100			
Frequency (MHz)				1860	1880	1900	L	M	H
20	QPSK	1	0	23.35	23.46	23.27	0.3119	0.3199	0.3062
20	QPSK	1	99	23.42	23.39	23.01	0.3170	0.3148	0.2884
20	QPSK	100	0	22.48	22.52	22.24	0.2553	0.2576	0.2415
20	16QAM	1	0	22.76	22.81	22.52	0.2723	0.2754	0.2576
Channel				18675	18900	19125	EIRP(W)		
Frequency (MHz)				1857.5	1880	1902.5	L	M	H
15	QPSK	1	0	23.40	23.42	23.14	0.3155	0.3170	0.2972
15	16QAM	1	0	22.66	22.78	22.40	0.2661	0.2735	0.2506
Channel				18650	18900	19150	EIRP(W)		
Frequency (MHz)				1855	1880	1905	L	M	H
10	QPSK	1	0	23.34	23.44	23.08	0.3112	0.3184	0.2931
10	16QAM	1	0	22.75	22.75	22.50	0.2716	0.2716	0.2564
Channel				18625	18900	19175	EIRP(W)		
Frequency (MHz)				1852.5	1880	1907.5	L	M	H
5	QPSK	1	0	23.37	23.45	23.01	0.3133	0.3192	0.2884
5	16QAM	1	0	22.66	22.73	22.47	0.2661	0.2704	0.2547
Channel				18615	18900	19185	EIRP(W)		
Frequency (MHz)				1851.5	1880	1908.5	L	M	H
3	QPSK	1	0	23.36	23.42	23.25	0.3126	0.3170	0.3048
3	16QAM	1	0	22.75	22.69	22.65	0.2716	0.2679	0.2655
Channel				18607	18900	19193	EIRP(W)		
Frequency (MHz)				1850.7	1880	1909.3	L	M	H
1.4	QPSK	1	0	23.29	23.37	22.98	0.3076	0.3133	0.2864
1.4	16QAM	1	0	22.61	22.79	22.41	0.2630	0.2742	0.2512



LTE Band 4									
BW [MHz]	Modulation	RB Size	RB Offset	Power Low Ch. / Freq.	Power Middle Ch. / Freq.	Power High Ch. / Freq.	EIRP(W)		
Channel				20050	20175	20300			
Frequency (MHz)				1720	1732.5	1745	L	M	H
20	QPSK	1	0	23.46	23.46	23.38	0.3516	0.3516	0.3451
20	QPSK	1	99	23.55	23.51	23.36	0.3589	0.3556	0.3436
20	QPSK	100	0	22.57	22.59	22.45	0.2864	0.2877	0.2786
20	16QAM	1	0	22.88	22.83	22.82	0.3076	0.3041	0.3034
Channel				20025	20175	20325	EIRP(W)		
Frequency (MHz)				1717.5	1732.5	1747.5	L	M	H
15	QPSK	1	0	23.37	23.42	23.38	0.3443	0.3483	0.3451
15	16QAM	1	0	22.87	22.76	22.82	0.3069	0.2992	0.3034
Channel				20000	20175	20350	EIRP(W)		
Frequency (MHz)				1715	1732.5	1750	L	M	H
10	QPSK	1	0	23.40	23.41	23.38	0.3467	0.3475	0.3451
10	16QAM	1	0	22.68	22.82	22.77	0.2938	0.3034	0.2999
Channel				19975	20175	20375	EIRP(W)		
Frequency (MHz)				1712.5	1732.5	1752.5	L	M	H
5	QPSK	1	0	23.33	23.45	23.37	0.3412	0.3508	0.3443
5	16QAM	1	0	22.78	22.83	22.72	0.3006	0.3041	0.2965
Channel				19965	20175	20385	EIRP(W)		
Frequency (MHz)				1711.5	1732.5	1753.5	L	M	H
3	QPSK	1	0	23.40	23.42	23.36	0.3467	0.3483	0.3436
3	16QAM	1	0	22.72	22.82	22.73	0.2965	0.3034	0.2972
Channel				19957	20175	20393	EIRP(W)		
Frequency (MHz)				1710.7	1732.5	1754.3	L	M	H
1.4	QPSK	1	0	23.34	23.39	23.28	0.3420	0.3459	0.3373
1.4	16QAM	1	0	22.74	22.84	22.66	0.2979	0.3048	0.2924



LTE Band 5									
BW [MHz]	Modulation	RB Size	RB Offset	Power Low Ch. / Freq.	Power Middle Ch. / Freq.	Power High Ch. / Freq.	ERP(W)		
Channel				20450	20525	20600			
Frequency (MHz)				829	836.5	844	L	M	H
10	QPSK	1	0	23.06	23.05	22.95	0.2208	0.2203	0.2153
10	QPSK	1	49	22.95	22.92	22.83	0.2153	0.2138	0.2094
10	QPSK	50	0	22.13	22.13	22.81	0.1782	0.1782	0.2084
10	16QAM	1	0	22.41	22.56	22.25	0.1901	0.1968	0.1832
Channel				20425	20525	20625	ERP(W)		
Frequency (MHz)				826.5	836.5	846.5	L	M	H
5	QPSK	1	0	23.01	23.03	22.94	0.2183	0.2193	0.2148
5	16QAM	1	0	22.45	22.36	22.28	0.1919	0.1879	0.1845
Channel				20415	20525	20635	ERP(W)		
Frequency (MHz)				825.5	836.5	847.5	L	M	H
3	QPSK	1	0	23.00	23.02	22.88	0.2178	0.2188	0.2118
3	16QAM	1	0	22.33	22.27	22.12	0.1866	0.1841	0.1778
Channel				20407	20525	20643	ERP(W)		
Frequency (MHz)				824.7	836.5	848.3	L	M	H
1.4	QPSK	1	0	22.96	22.97	22.86	0.2158	0.2163	0.2109
1.4	16QAM	1	0	22.49	22.42	22.12	0.1936	0.1905	0.1778



LTE Band 25									
BW [MHz]	Modulation	RB Size	RB Offset	Power Low Ch. / Freq.	Power Middle Ch. / Freq.	Power High Ch. / Freq.	EIRP(W)		
Channel				26140	26340	26590			
Frequency (MHz)				1860	1880	1905	L	M	H
20	QPSK	1	0	23.69	23.71	23.58	0.3373	0.3388	0.3289
20	QPSK	1	99	23.62	23.59	23.45	0.3319	0.3296	0.3192
20	QPSK	100	0	22.52	22.54	22.47	0.2576	0.2588	0.2547
20	16QAM	1	0	23.02	23.05	22.89	0.2891	0.2911	0.2805
Channel				26115	26340	26615	EIRP(W)		
Frequency (MHz)				1857.5	1880	1907.5	L	M	H
15	QPSK	1	0	23.48	23.54	23.63	0.3214	0.3258	0.3327
15	16QAM	1	0	22.79	23.03	23.02	0.2742	0.2897	0.2891
Channel				26090	26340	26640	EIRP(W)		
Frequency (MHz)				1855	1880	1910	L	M	H
10	QPSK	1	0	23.69	23.67	23.54	0.3373	0.3357	0.3258
10	16QAM	1	0	22.99	23.01	22.86	0.2871	0.2884	0.2786
Channel				26065	26340	26665	EIRP(W)		
Frequency (MHz)				1852.5	1880	1912.5	L	M	H
5	QPSK	1	0	23.53	23.45	23.52	0.3251	0.3192	0.3243
5	16QAM	1	0	22.76	22.72	22.90	0.2723	0.2698	0.2812
Channel				26055	26340	26675	EIRP(W)		
Frequency (MHz)				1851.5	1880	1913.5	L	M	H
3	QPSK	1	0	23.51	23.47	23.56	0.3236	0.3206	0.3273
3	16QAM	1	0	22.88	22.78	22.94	0.2799	0.2735	0.2838
Channel				26047	26340	26683	EIRP(W)		
Frequency (MHz)				1850.7	1880	1914.3	L	M	H
1.4	QPSK	1	0	23.45	23.35	23.37	0.3192	0.3119	0.3133
1.4	16QAM	1	0	22.73	22.60	22.62	0.2704	0.2624	0.2636





LTE Band 26											
BW [MHz]	Modulation	RB Size	RB Offset	Power Low Ch. / Freq.	Power Low Ch. / Freq.	Power Middle Ch. / Freq.	Power High Ch. / Freq.	ERP(W)			
Channel				26790	26865	26915	26965				
Frequency (MHz)				824	831.5	836.5	841.5	Straddle Ch	L	M	H
15	QPSK	1	0	22.99	23.12	23.15	23.10	0.2173	0.2239	0.2254	0.2228
15	QPSK	1	74	22.98	22.95	23.05	23.01	0.2168	0.2153	0.2203	0.2183
15	QPSK	75	0	22.12	22.10	22.06	22.03	0.1778	0.1770	0.1754	0.1742
15	16QAM	1	0	22.36	22.38	22.45	22.50	0.1879	0.1888	0.1919	0.1941
Channel					26840	26915	26990	ERP(W)			
Frequency (MHz)					829	836.5	844	L	M	H	
10	QPSK	1	0		23.05	23.06	23.08	0.2203	0.2208	0.2218	
10	16QAM	1	0		22.36	22.41	22.50	0.1879	0.1901	0.1941	
Channel					26815	26915	27015	ERP(W)			
Frequency (MHz)					826.5	836.5	846.5	L	M	H	
5	QPSK	1	0		23.01	23.03	22.99	0.2183	0.2193	0.2173	
5	16QAM	1	0		22.36	22.39	22.42	0.1879	0.1892	0.1905	
Channel					26815	26915	27025	ERP(W)			
Frequency (MHz)					825.5	836.5	847.5	L	M	H	
3	QPSK	1	0		22.95	23.01	22.98	0.2153	0.2183	0.2168	
3	16QAM	1	0		22.37	22.35	22.34	0.1884	0.1875	0.1871	
Channel					26797	26915	27033	ERP(W)			
Frequency (MHz)					824.7	836.5	848.3	L	M	H	
1.4	QPSK	1	0		22.97	22.92	22.91	0.2163	0.2138	0.2133	
1.4	16QAM	1	0		22.29	22.24	22.21	0.1849	0.1828	0.1816	



LTE Band 66									
BW [MHz]	Modulation	RB Size	RB Offset	Power Low Ch. / Freq.	Power Middle Ch. / Freq.	Power High Ch. / Freq.	EIRP(W)		
Channel				132072	132322	132572			
Frequency (MHz)				1720	1745	1770	L	M	H
20	QPSK	1	0	23.54	23.61	23.39	0.3581	0.3639	0.3459
20	QPSK	1	99	23.50	23.58	23.35	0.3548	0.3614	0.3428
20	QPSK	100	0	22.58	22.63	22.41	0.2871	0.2904	0.2761
20	16QAM	1	0	22.97	23.49	23.37	0.3141	0.3540	0.3443
Channel				132047	132322	132597	EIRP(W)		
Frequency (MHz)				1717.5	1745	1772.5	L	M	H
15	QPSK	1	0	23.56	23.59	23.38	0.3597	0.3622	0.3451
15	16QAM	1	0	22.92	22.96	22.87	0.3105	0.3133	0.3069
Channel				132022	132322	132622	EIRP(W)		
Frequency (MHz)				1715	1745	1775	L	M	H
10	QPSK	1	0	23.52	23.50	23.39	0.3565	0.3548	0.3459
10	16QAM	1	0	22.95	22.94	22.73	0.3126	0.3119	0.2972
Channel				131997	132322	132647	EIRP(W)		
Frequency (MHz)				1712.5	1745	1777.5	L	M	H
5	QPSK	1	0	23.52	23.54	23.34	0.3565	0.3581	0.3420
5	16QAM	1	0	22.93	22.86	22.88	0.3112	0.3062	0.3076
Channel				131987	132322	132657	EIRP(W)		
Frequency (MHz)				1711.5	1745	1778.5	L	M	H
3	QPSK	1	0	23.53	23.51	23.37	0.3573	0.3556	0.3443
3	16QAM	1	0	22.84	22.85	22.83	0.3048	0.3055	0.3041
Channel				131979	132322	132665	EIRP(W)		
Frequency (MHz)				1710.7	1745	1779.3	L	M	H
1.4	QPSK	1	0	23.55	23.49	23.32	0.3589	0.3540	0.3404
1.4	16QAM	1	0	22.91	22.93	22.78	0.3097	0.3112	0.3006



# LTE Band 25

## Peak-to-Average Ratio

Mode	LTE Band 25 / 20MHz		
Mod.	QPSK	16QAM	Limit: 13dB
RB Size	Full RB	Full RB	Result
Middle CH	4.64	6.06	PASS

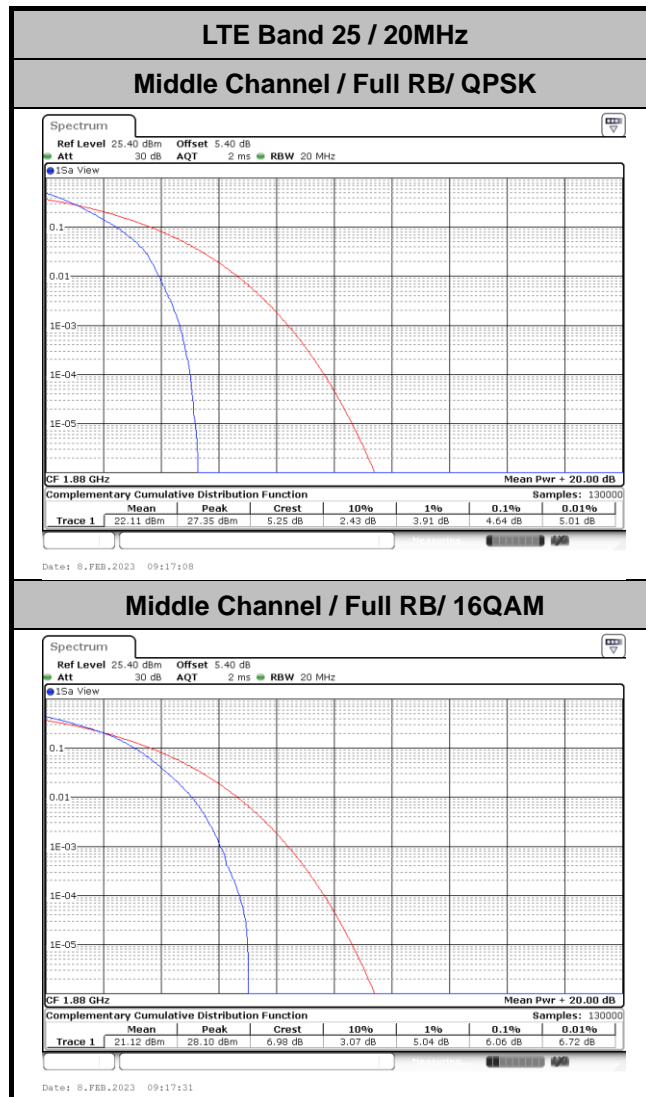



**26dB Bandwidth**

Mode	LTE Band 25 : 26dB BW(MHz)	
<b>BW</b>	<b>1.4MHz</b>	
<b>Mod.</b>	<b>QPSK</b>	<b>16QAM</b>
<b>Middle CH</b>	1.23	1.23
<b>BW</b>	<b>3MHz</b>	
<b>Mod.</b>	<b>QPSK</b>	<b>16QAM</b>
<b>Middle CH</b>	3.02	3.05
<b>BW</b>	<b>5MHz</b>	
<b>Mod.</b>	<b>QPSK</b>	<b>16QAM</b>
<b>Middle CH</b>	4.94	4.89
<b>BW</b>	<b>10MHz</b>	
<b>Mod.</b>	<b>QPSK</b>	<b>16QAM</b>
<b>Middle CH</b>	9.89	9.71
<b>BW</b>	<b>15MHz</b>	
<b>Mod.</b>	<b>QPSK</b>	<b>16QAM</b>
<b>Middle CH</b>	14.42	14.30
<b>BW</b>	<b>20MHz</b>	
<b>Mod.</b>	<b>QPSK</b>	<b>16QAM</b>
<b>Middle CH</b>	18.94	18.90



LTE Band 25

Middle Channel / 1.4MHz / QPSK

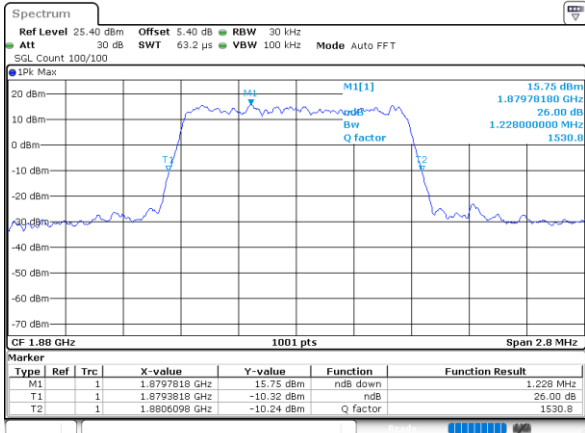

Date: 7.FEB.2023 19:32:03

Middle Channel / 1.4MHz / 16QAM

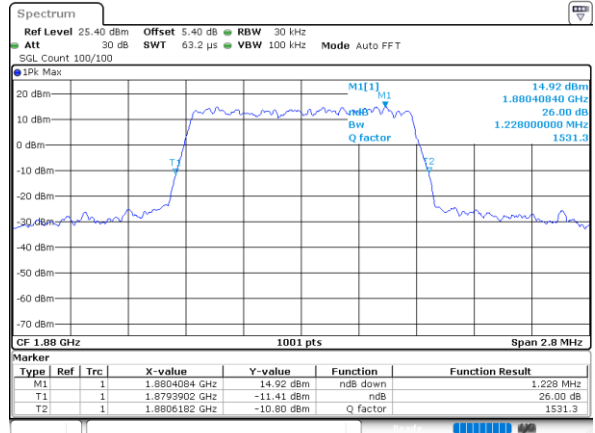

Date: 7.FEB.2023 19:32:25

LTE Band 25

Middle Channel / 3MHz / QPSK

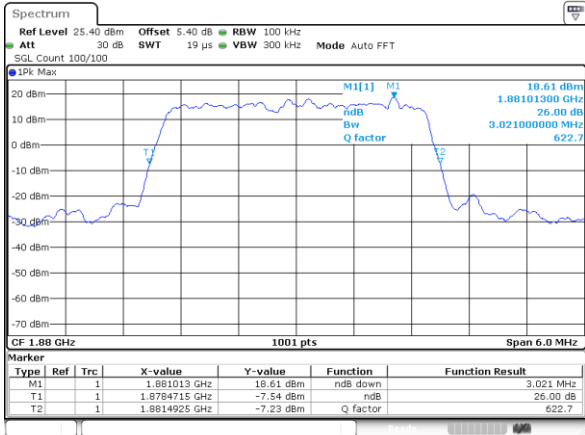

Date: 8.FEB.2023 08:03:06

Middle Channel / 3MHz / 16QAM

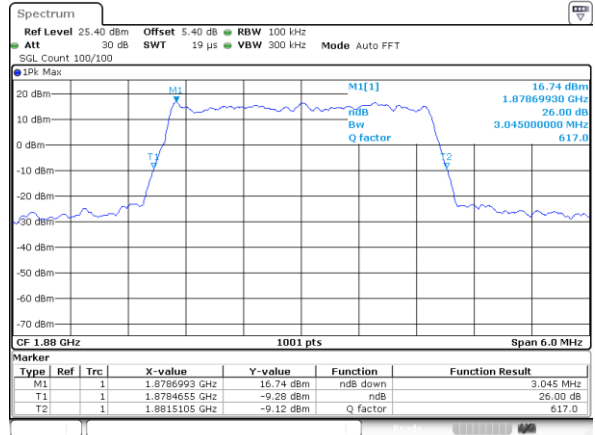

Date: 8.FEB.2023 08:03:49

LTE Band 25

Middle Channel / 5MHz / QPSK

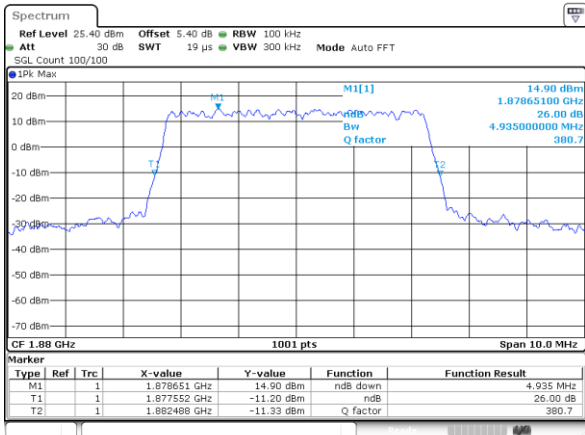

Date: 8.FEB.2023 08:20:42

Middle Channel / 5MHz / 16QAM

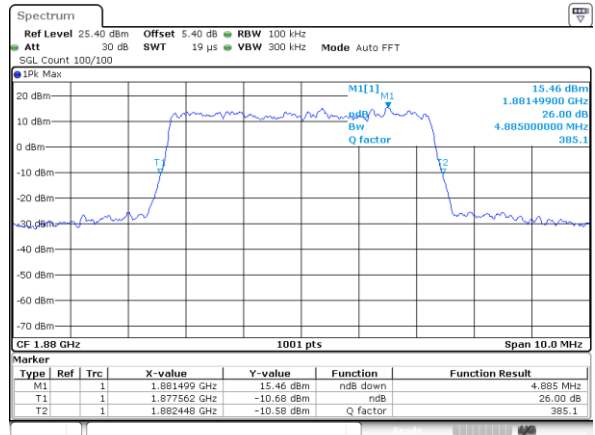

Date: 8.FEB.2023 08:21:04



LTE Band 25

Middle Channel / 10MHz / QPSK

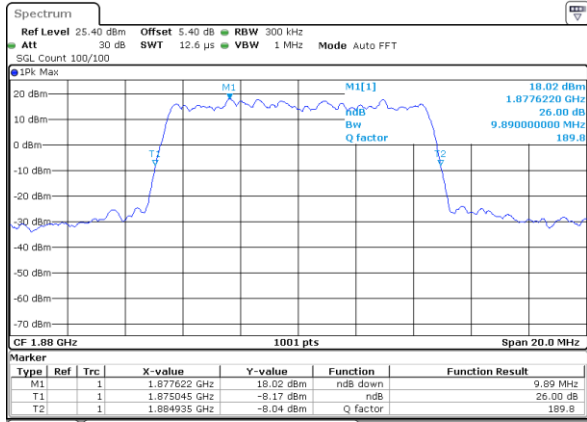

Date: 8.FEB.2023 08:16:56

Middle Channel / 10MHz / 16QAM

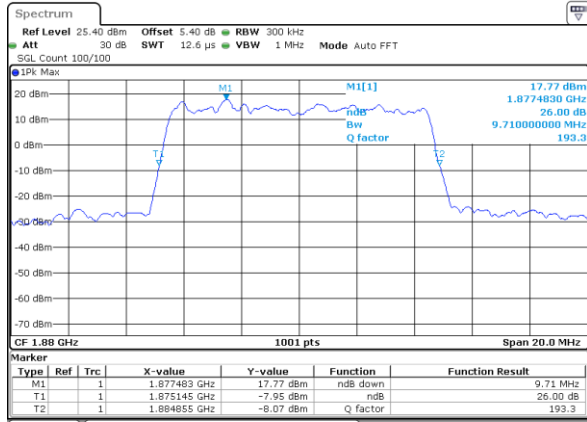

Date: 8.FEB.2023 08:17:39

LTE Band 25

Middle Channel / 15MHz / QPSK

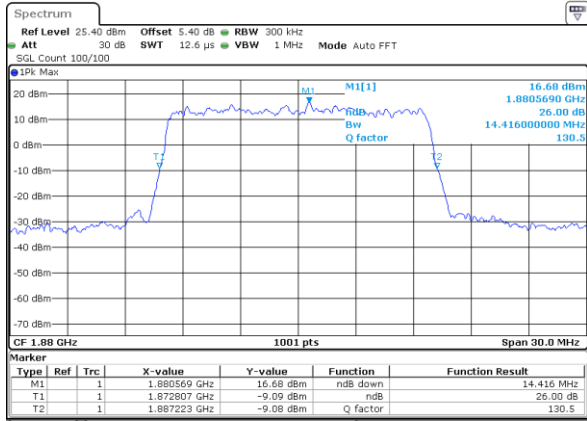

Date: 8.FEB.2023 08:53:08

Middle Channel / 15MHz / 16QAM

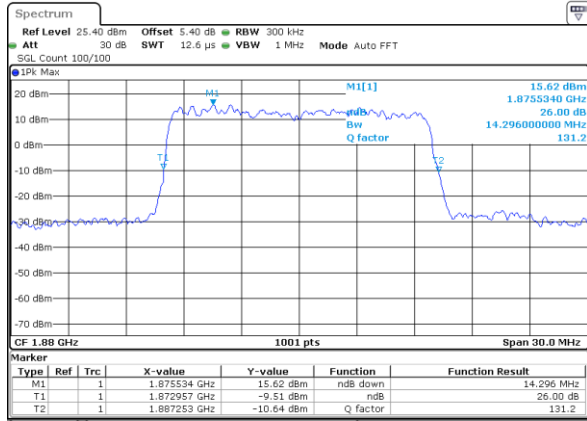

Date: 8.FEB.2023 08:53:30

LTE Band 25

Middle Channel / 20MHz / QPSK

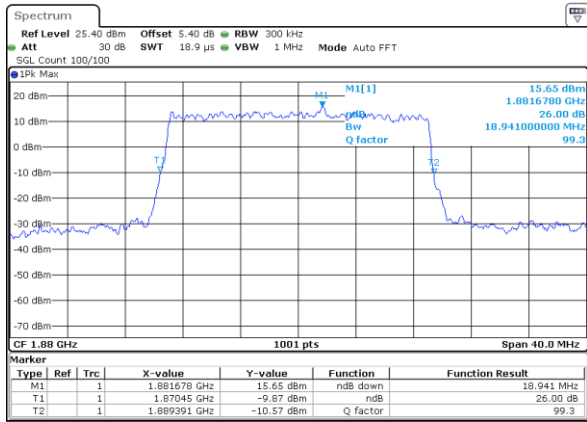

Date: 8.FEB.2023 09:09:21

Middle Channel / 20MHz / 16QAM

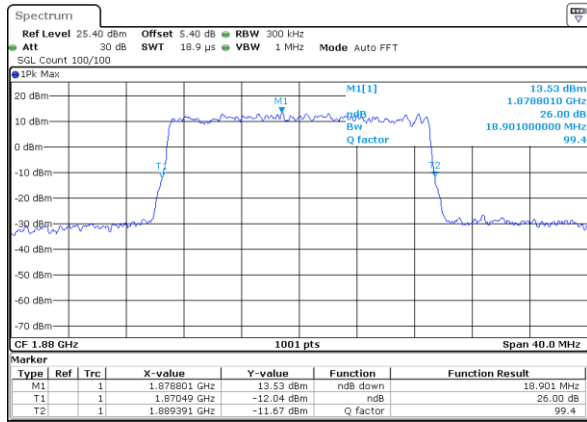

Date: 8.FEB.2023 09:09:42



Occupied Bandwidth

Mode	LTE Band 25 : 99%OBW(MHz)	
<b>BW</b>	<b>1.4MHz</b>	
<b>Mod.</b>	<b>QPSK</b>	<b>16QAM</b>
<b>Middle CH</b>	1.09	1.09
<b>BW</b>	<b>3MHz</b>	
<b>Mod.</b>	<b>QPSK</b>	<b>16QAM</b>
<b>Middle CH</b>	2.73	2.72
<b>BW</b>	<b>5MHz</b>	
<b>Mod.</b>	<b>QPSK</b>	<b>16QAM</b>
<b>Middle CH</b>	4.51	4.49
<b>BW</b>	<b>10MHz</b>	
<b>Mod.</b>	<b>QPSK</b>	<b>16QAM</b>
<b>Middle CH</b>	9.03	9.01
<b>BW</b>	<b>15MHz</b>	
<b>Mod.</b>	<b>QPSK</b>	<b>16QAM</b>
<b>Middle CH</b>	13.4	13.43
<b>BW</b>	<b>20MHz</b>	
<b>Mod.</b>	<b>QPSK</b>	<b>16QAM</b>
<b>Middle CH</b>	17.86	17.82



LTE Band 25

Middle Channel / 1.4MHz / QPSK

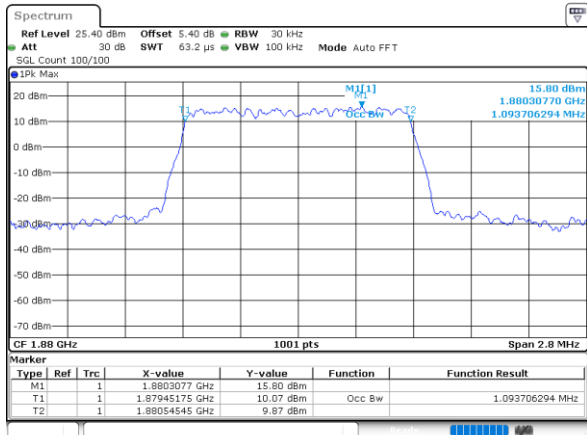

Date: 7.FEB.2023 19:13:14Z

Middle Channel / 1.4MHz / 16QAM

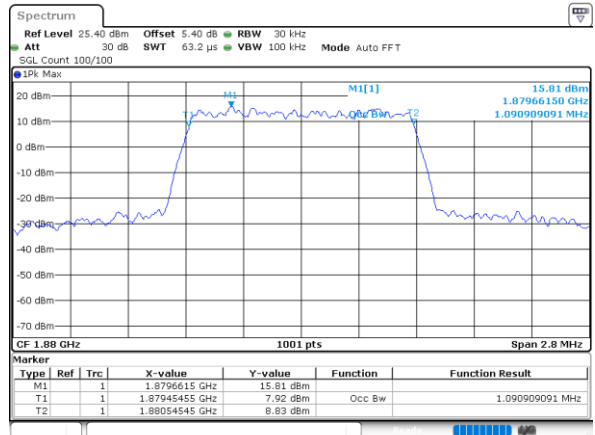

Date: 7.FEB.2023 19:32:46

LTE Band 25

Middle Channel / 3MHz / QPSK

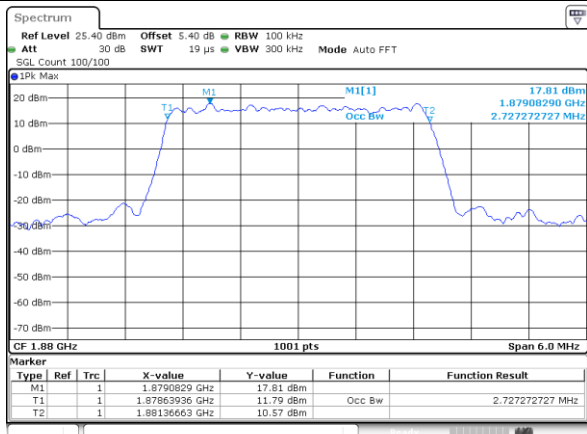

Date: 8.FEB.2023 08:02:45

Middle Channel / 3MHz / 16QAM

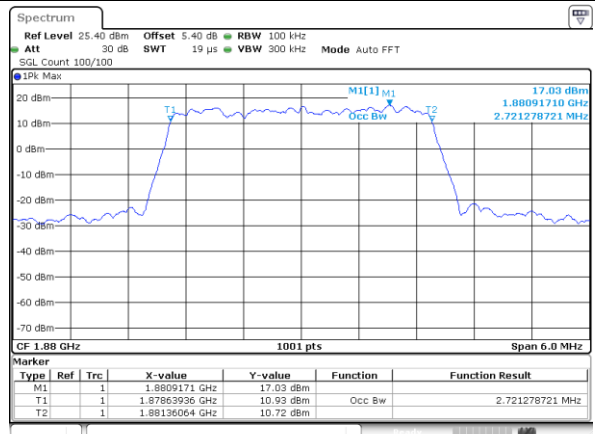

Date: 8.FEB.2023 08:03:28

LTE Band 25

Middle Channel / 5MHz / QPSK

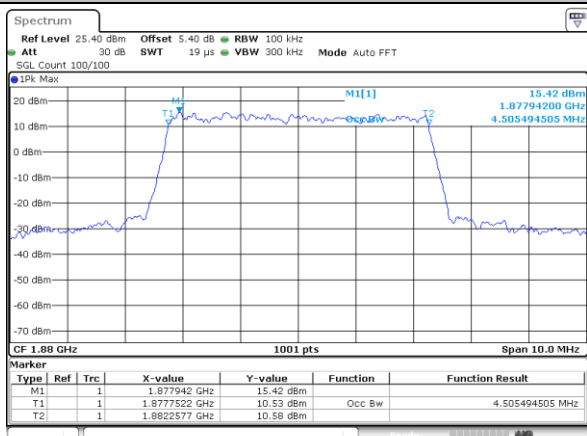

Date: 8.FEB.2023 08:20:21

Middle Channel / 5MHz / 16QAM

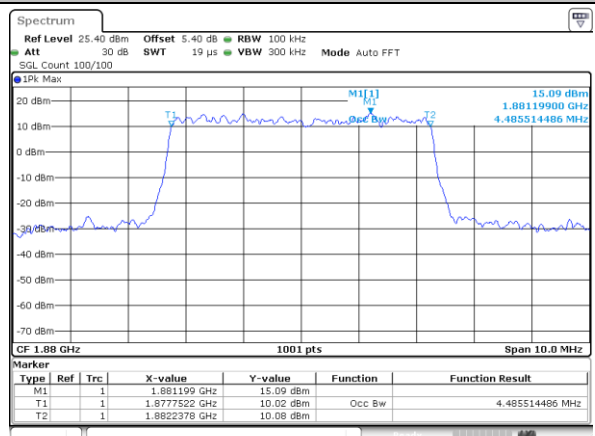

Date: 8.FEB.2023 08:21:25





LTE Band 25

Middle Channel / 10MHz / QPSK

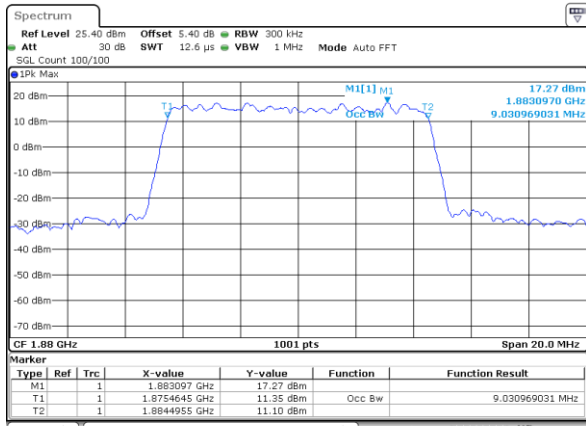

Date: 8.FEB.2023 08:13:14

Middle Channel / 10MHz / 16QAM

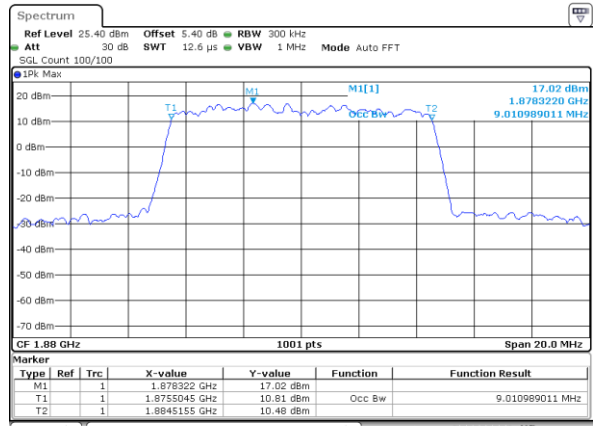

Date: 8.FEB.2023 08:17:17

LTE Band 25

Middle Channel / 15MHz / QPSK

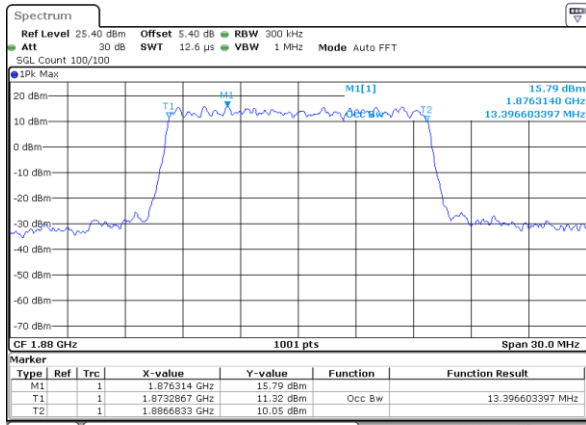

Date: 8.FEB.2023 08:52:47

Middle Channel / 15MHz / 16QAM

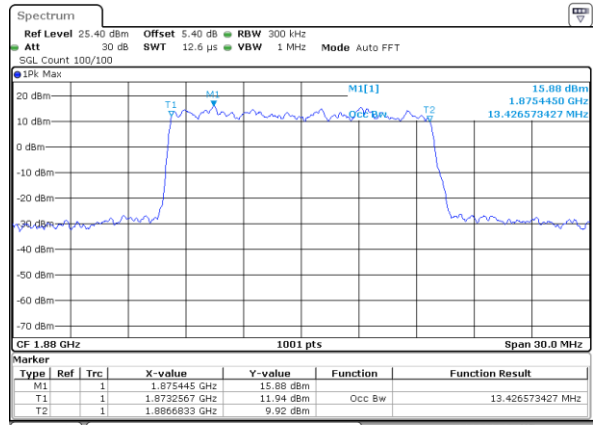

Date: 8.FEB.2023 08:53:51

LTE Band 25

Middle Channel / 20MHz / QPSK

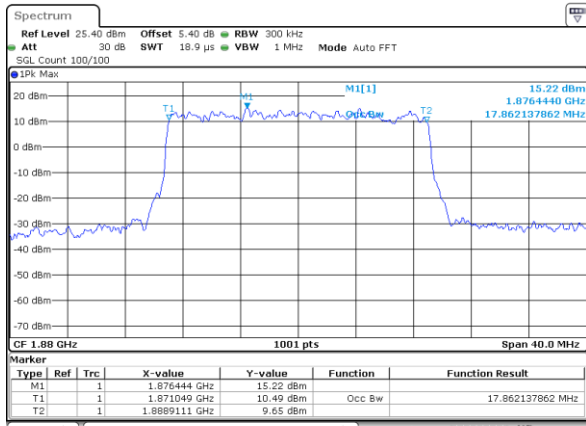

Date: 8.FEB.2023 09:08:59

Middle Channel / 20MHz / 16QAM

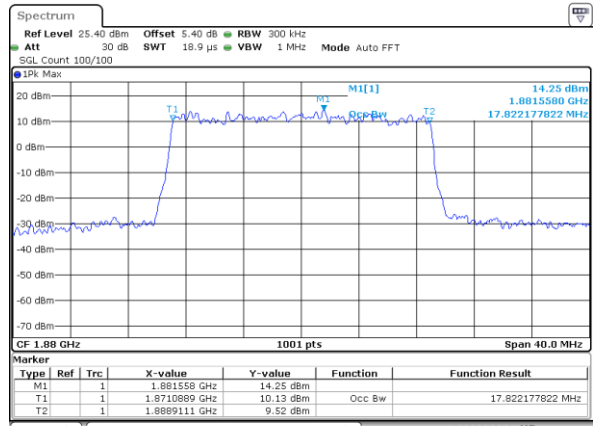

Date: 8.FEB.2023 09:10:04



# Conducted Band Edge

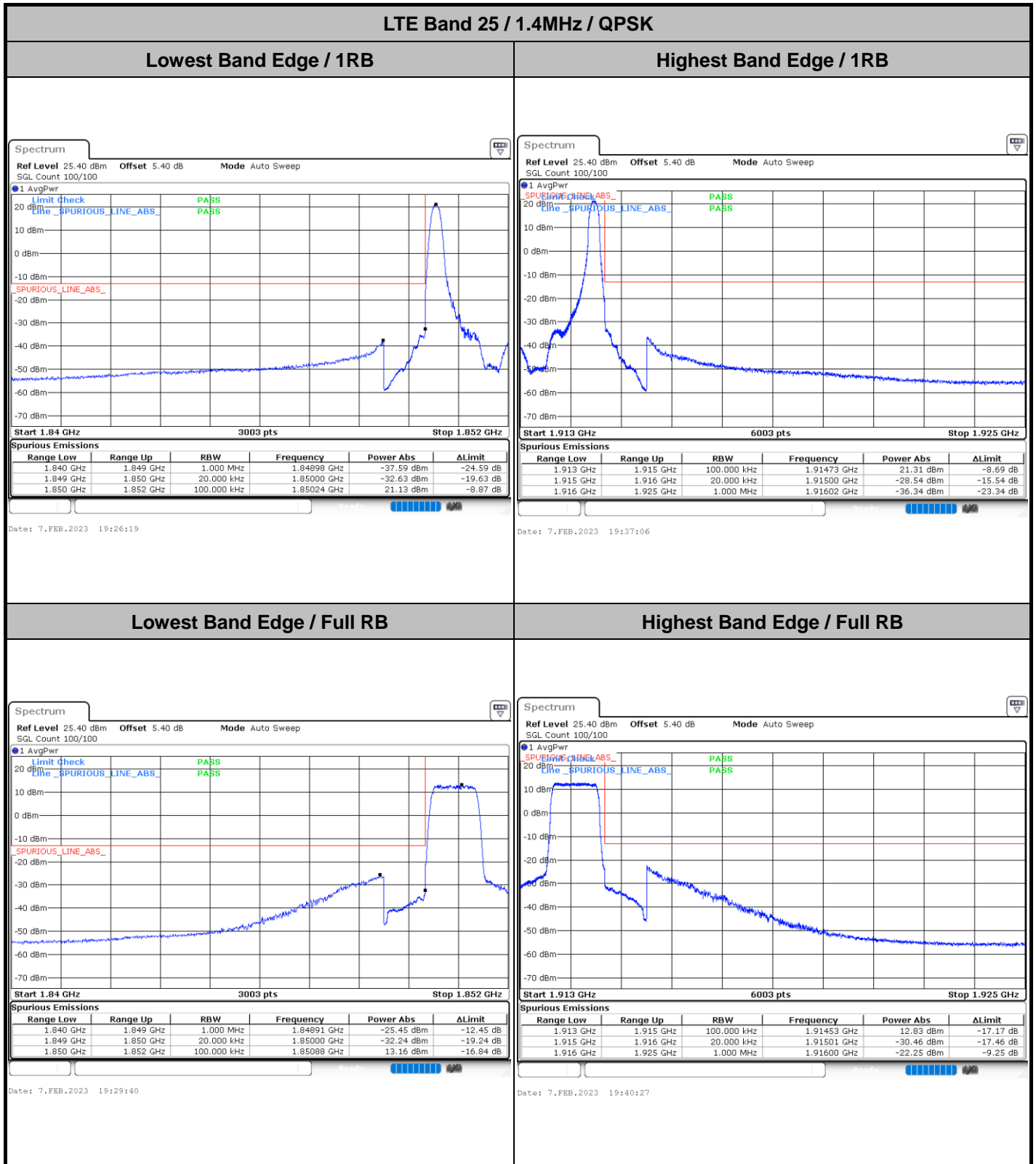



LTE Band 25 / 1.4MHz / 16QAM

Lowest Band Edge / 1 RB

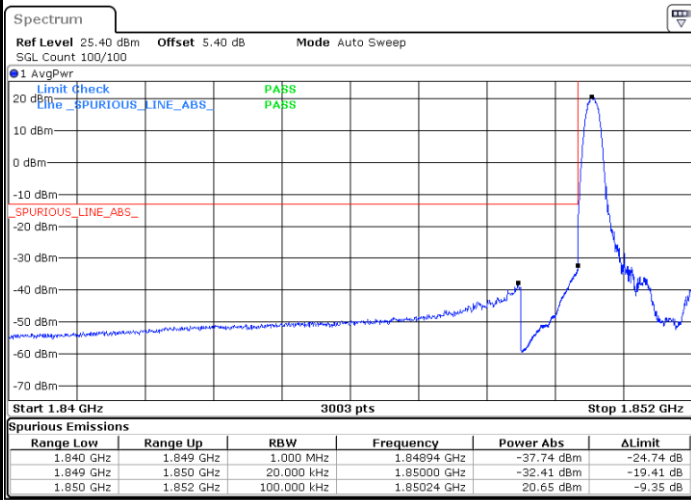

Date: 7.FEB.2023 19:28:00

Highest Band Edge / 1 RB

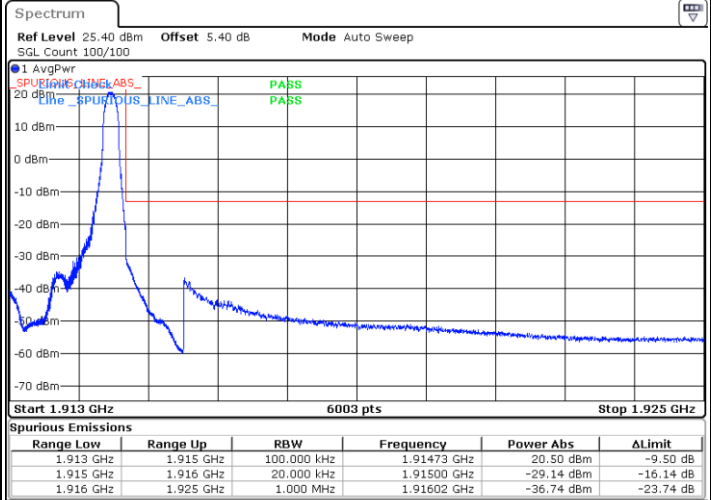

Date: 7.FEB.2023 19:38:46

Lowest Band Edge / Full RB

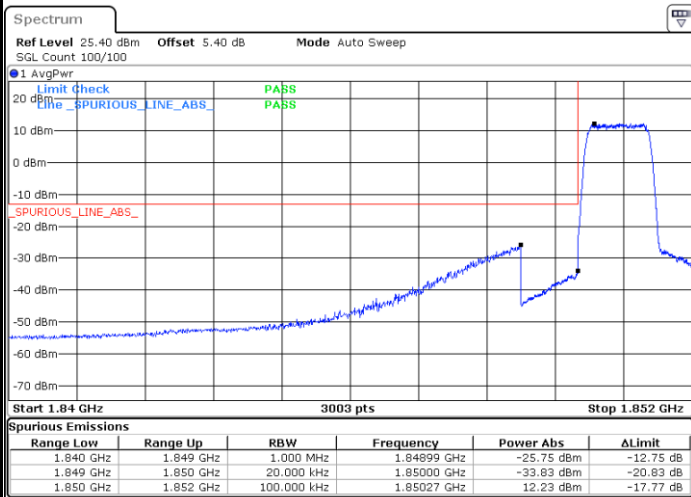

Date: 7.FEB.2023 19:31:20

Highest Band Edge / Full RB

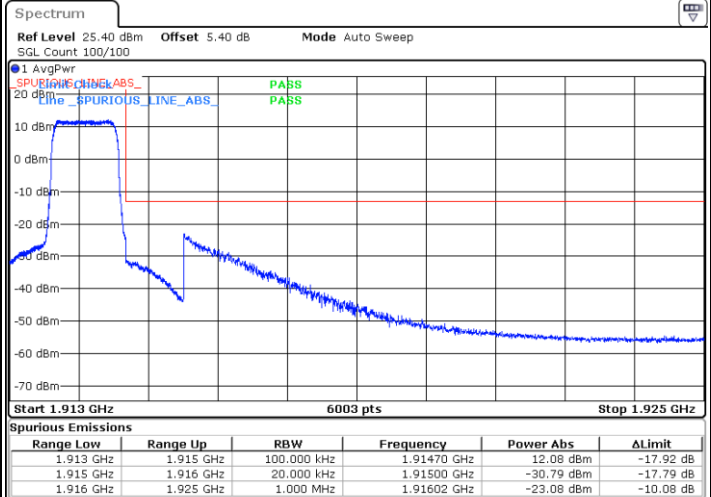

Date: 7.FEB.2023 19:42:07



LTE Band 25 / 3MHz / QPSK

Lowest Band Edge / 1RB

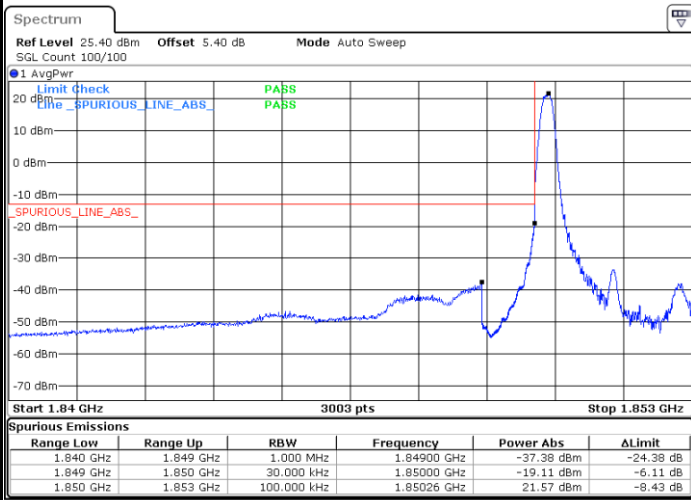

Date: 8.FEB.2023 08:01:03

Highest Band Edge / 1 RB

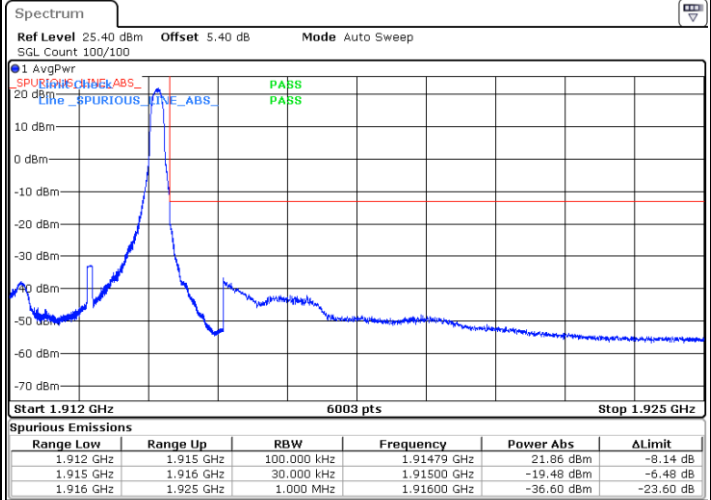

Date: 8.FEB.2023 08:07:53

Lowest Band Edge / Full RB

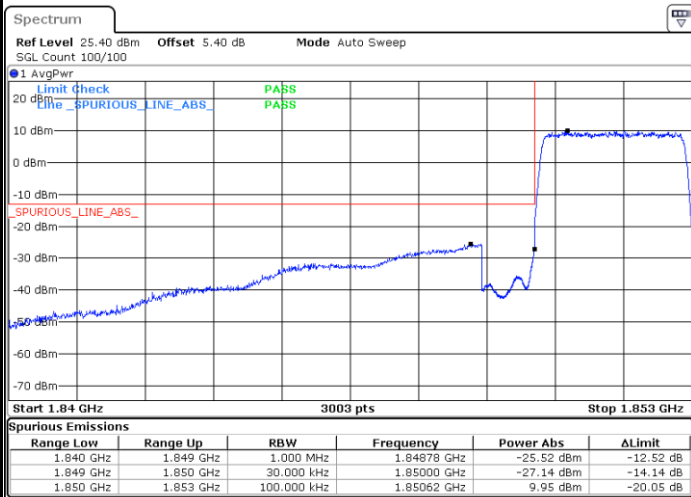

Date: 8.FEB.2023 07:57:02

Highest Band Edge / Full RB

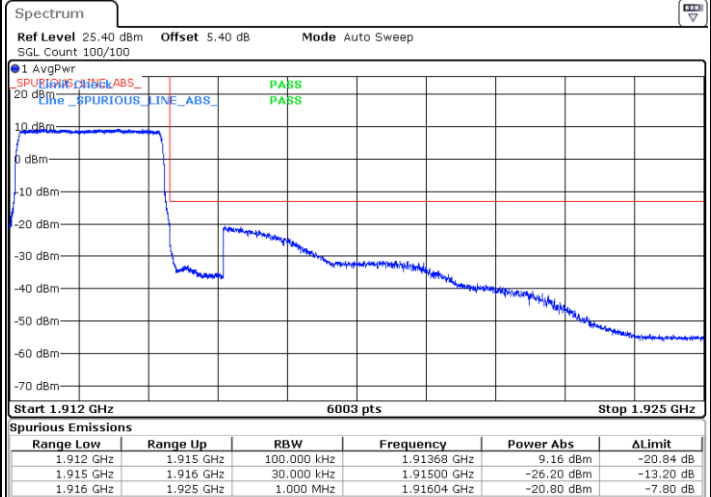

Date: 8.FEB.2023 08:10:33



LTE Band 25 / 3MHz / 16QAM

Lowest Band Edge / 1 RB

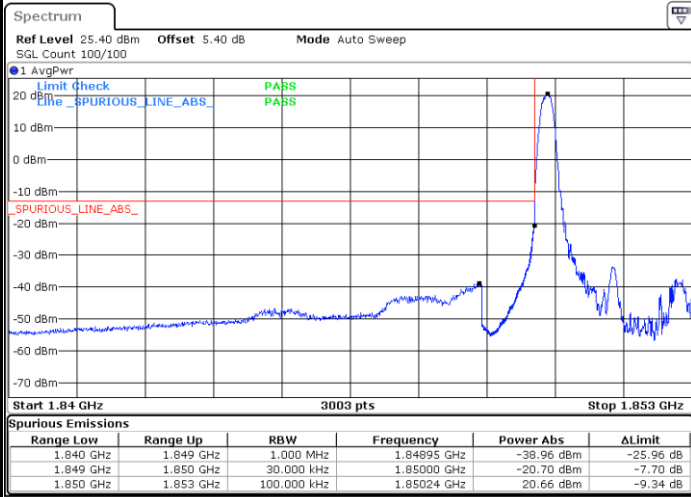

Date: 8.FEB.2023 08:02:22

Highest Band Edge / 1 RB

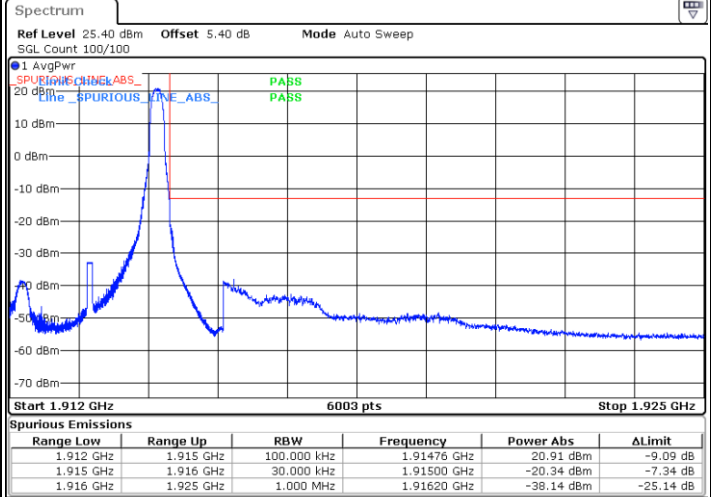

Date: 8.FEB.2023 08:09:13

Lowest Band Edge / Full RB

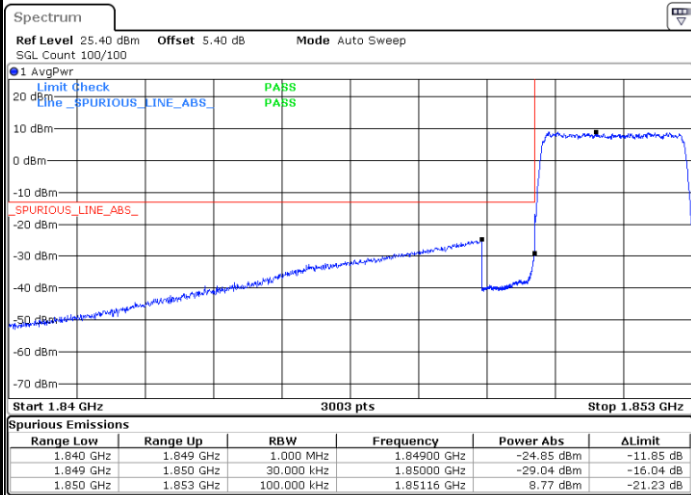

Date: 8.FEB.2023 07:58:21

Highest Band Edge / Full RB

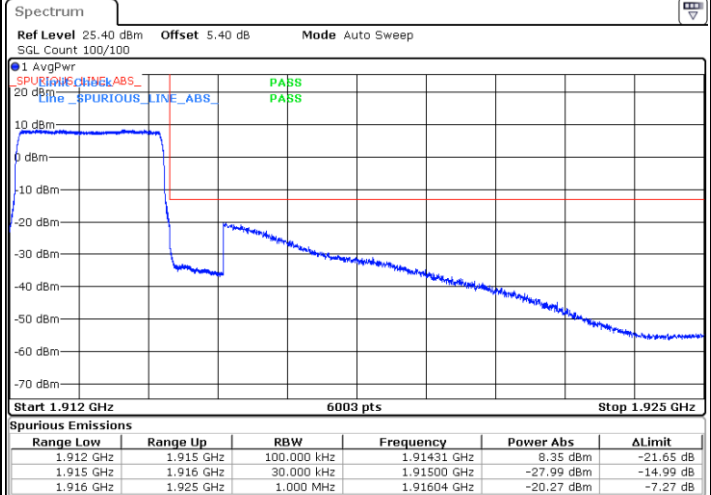

Date: 8.FEB.2023 08:11:53



LTE Band 25 / 5MHz / QPSK

Lowest Band Edge / 1 RB

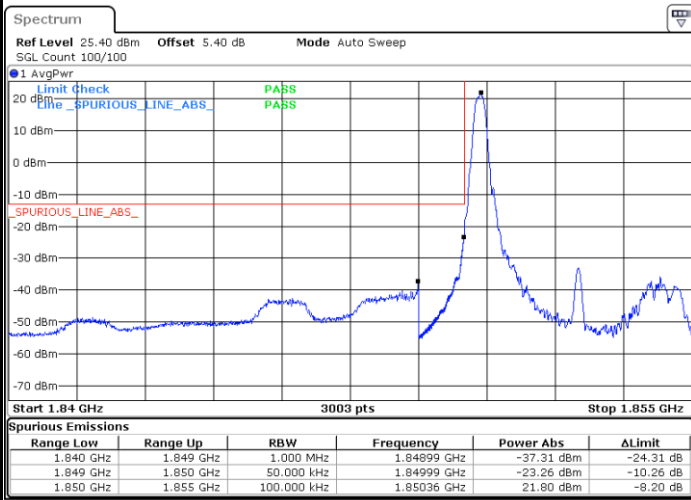

Date: 8.FEB.2023 08:17:16

Highest Band Edge / 1 RB

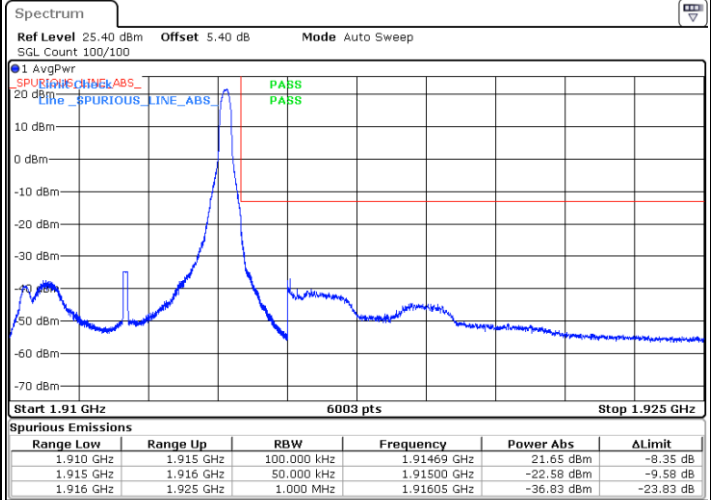

Date: 8.FEB.2023 08:26:46

Lowest Band Edge / Full RB

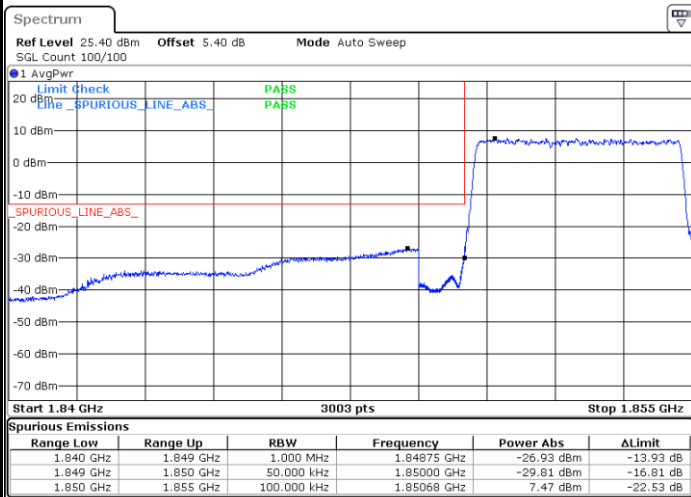

Date: 8.FEB.2023 08:13:14

Highest Band Edge / Full RB

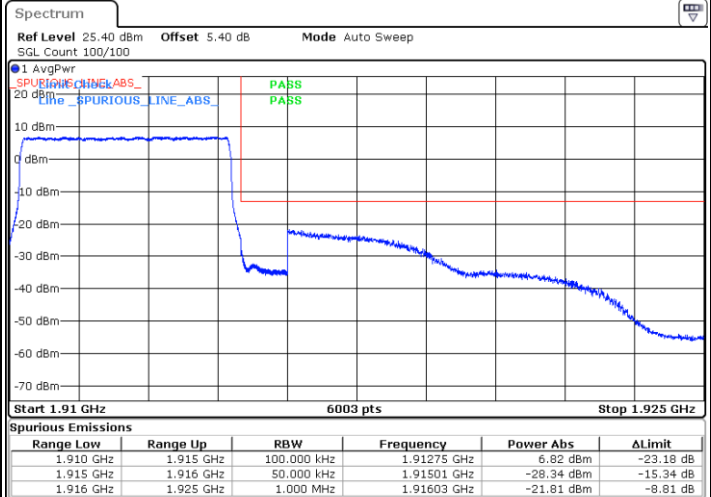

Date: 8.FEB.2023 08:24:06



LTE Band 25 / 5MHz / 16QAM

Lowest Band Edge / 1RB

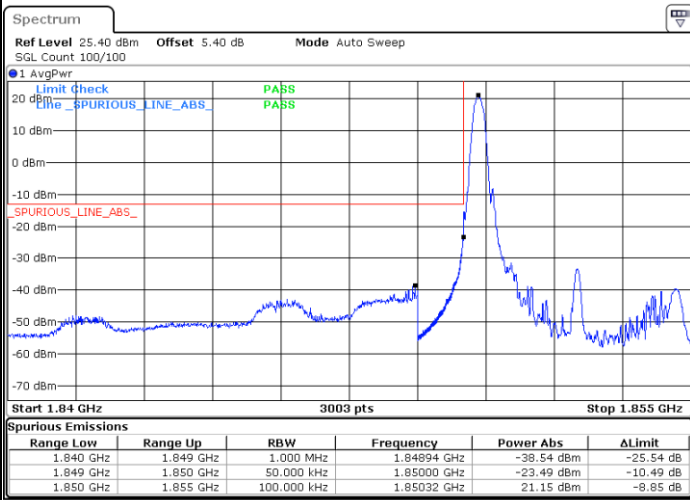

Date: 8.FEB.2023 08:18:36

Highest Band Edge / 1 RB

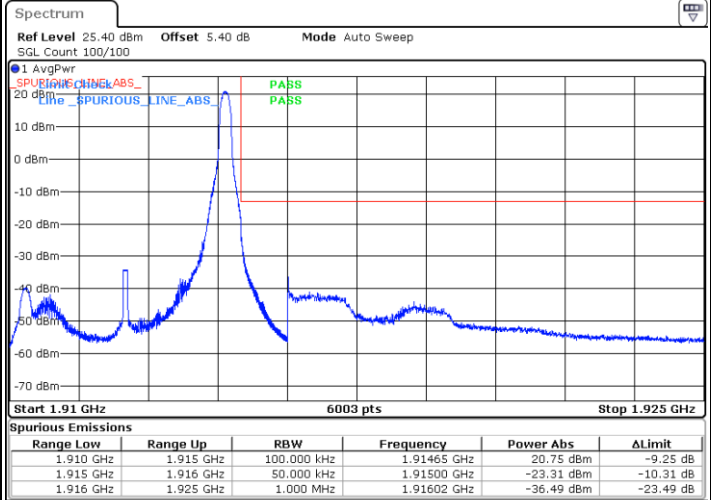

Date: 8.FEB.2023 08:28:07

Lowest Band Edge / Full RB

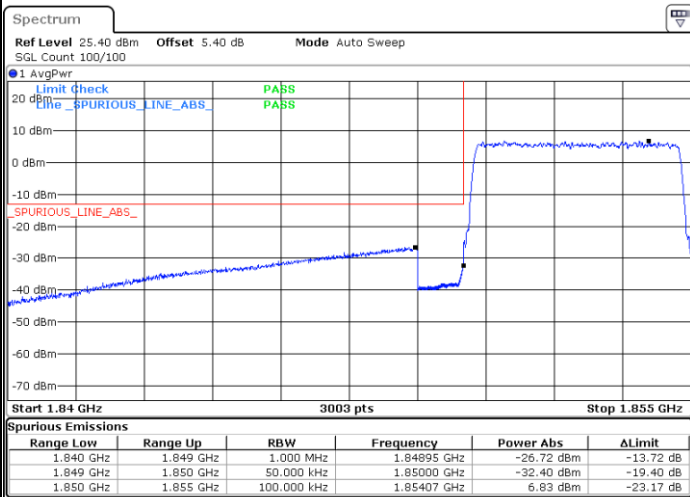

Date: 8.FEB.2023 08:14:34

Highest Band Edge / Full RB

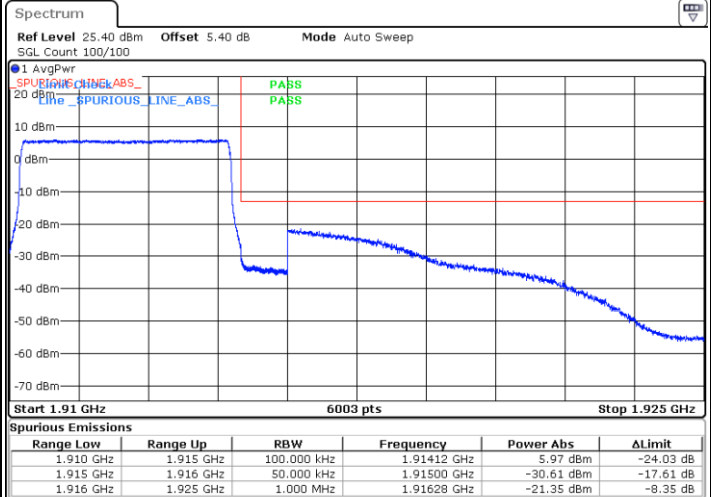

Date: 8.FEB.2023 08:25:26



LTE Band 25 / 10MHz / QPSK

Lowest Band Edge / 1 RB

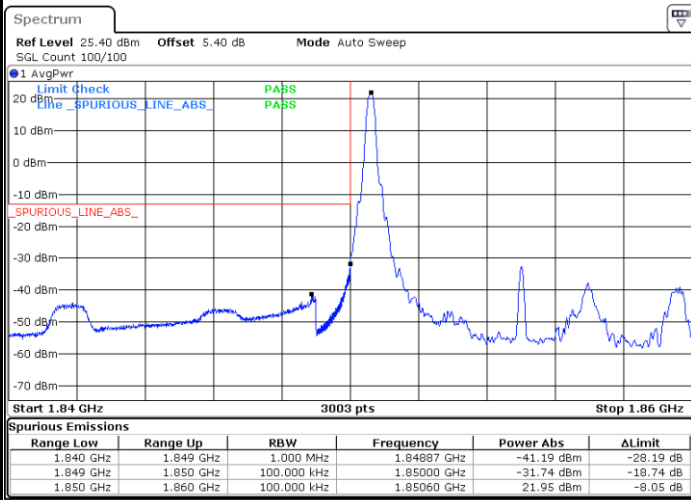

Date: 8.FEB.2023 08:32:08

Highest Band Edge / 1 RB

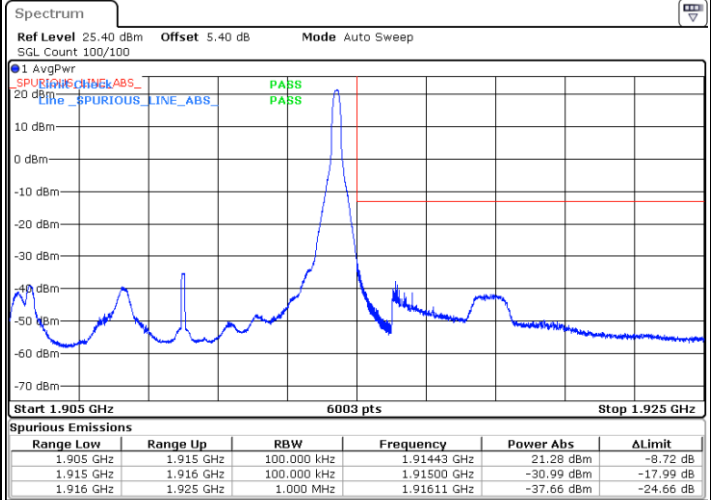

Date: 8.FEB.2023 08:43:00

Lowest Band Edge / Full RB

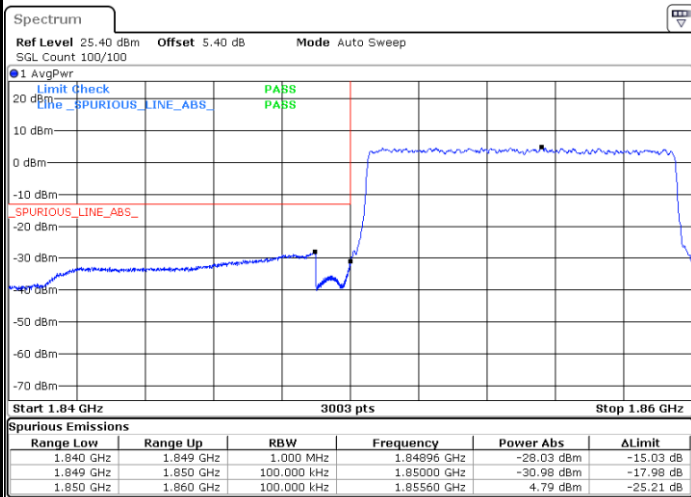

Date: 8.FEB.2023 08:29:28

Highest Band Edge / Full RB

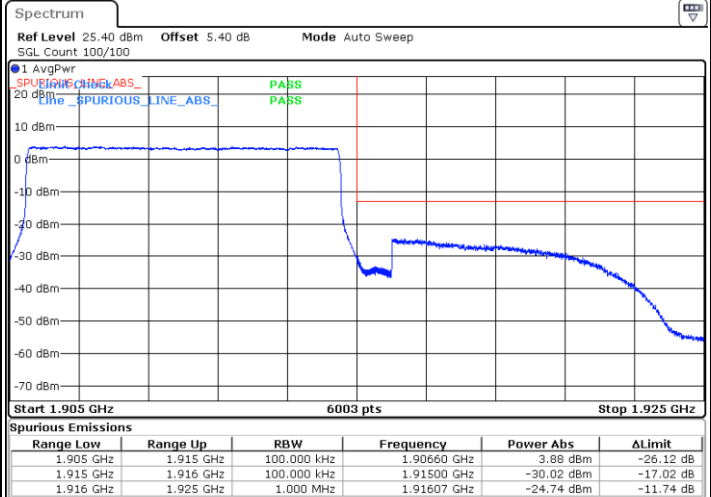

Date: 8.FEB.2023 08:40:20





LTE Band 25 / 10MHz / 16QAM

Lowest Band Edge / 1 RB

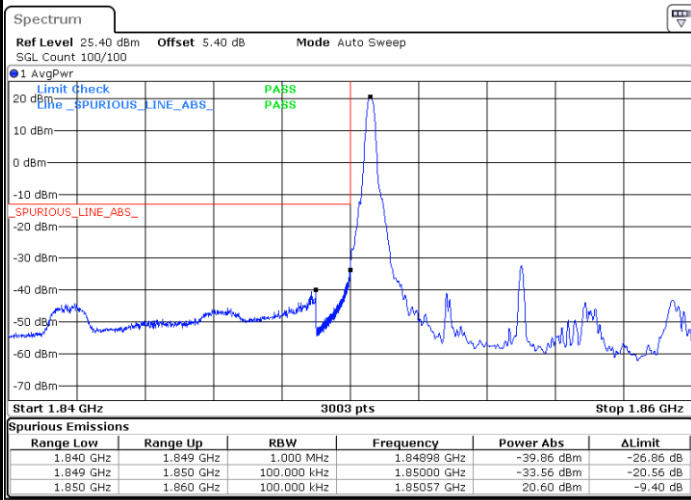

Date: 8.FEB.2023 08:34:50

Highest Band Edge / 1 RB

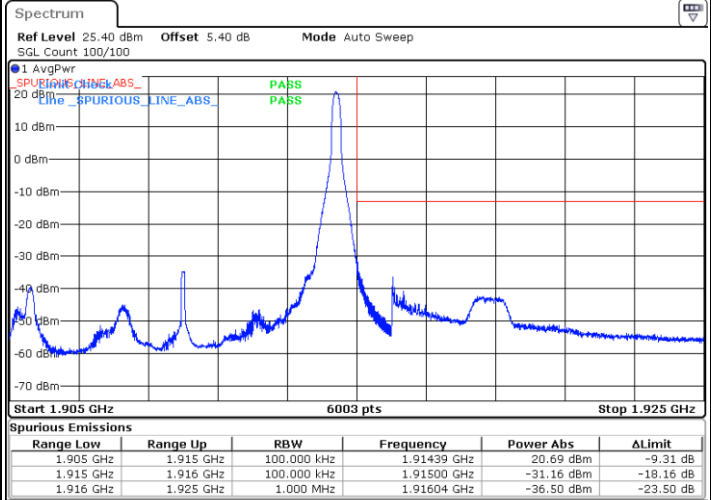

Date: 8.FEB.2023 08:44:20

Lowest Band Edge / Full RB

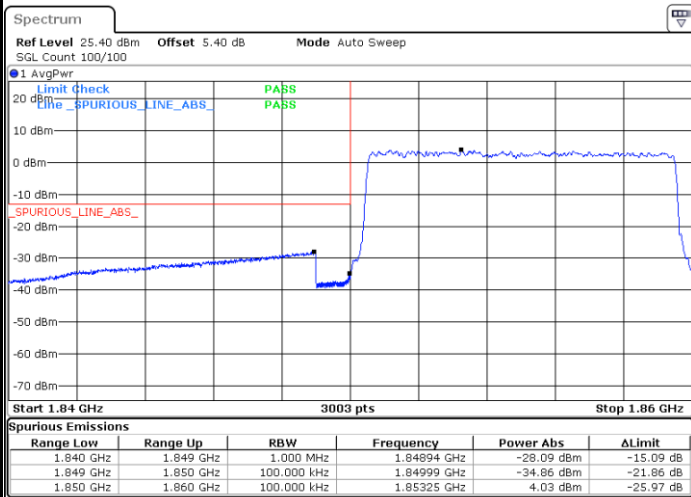

Date: 8.FEB.2023 08:30:48

Highest Band Edge / Full RB

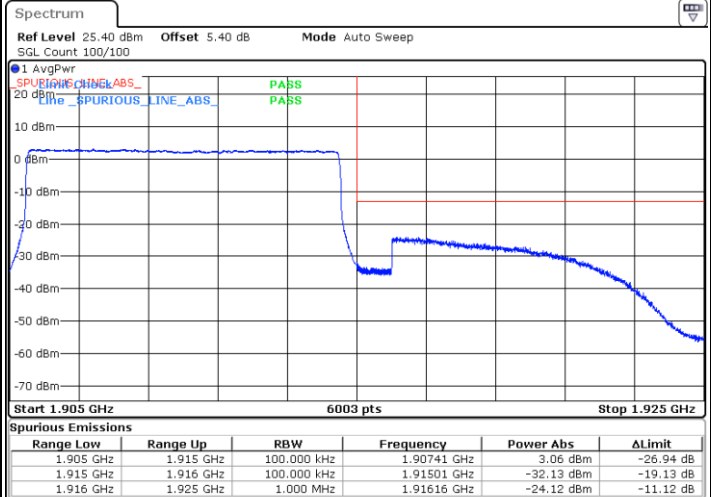

Date: 8.FEB.2023 08:41:40



LTE Band 25 / 15MHz / QPSK

Lowest Band Edge / 1 RB

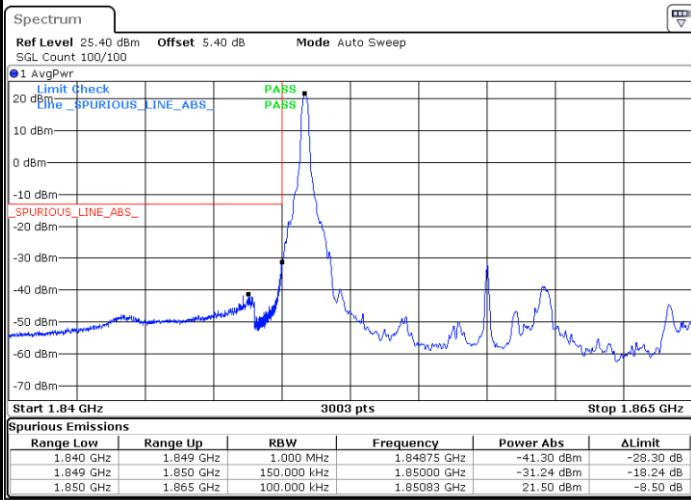

Date: 8.FEB.2023 08:49:43

Highest Band Edge / 1 RB

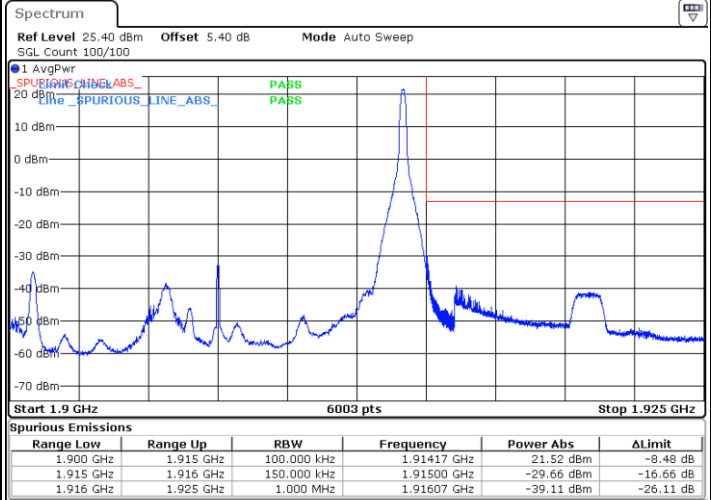

Date: 8.FEB.2023 08:59:13

Lowest Band Edge / Full RB

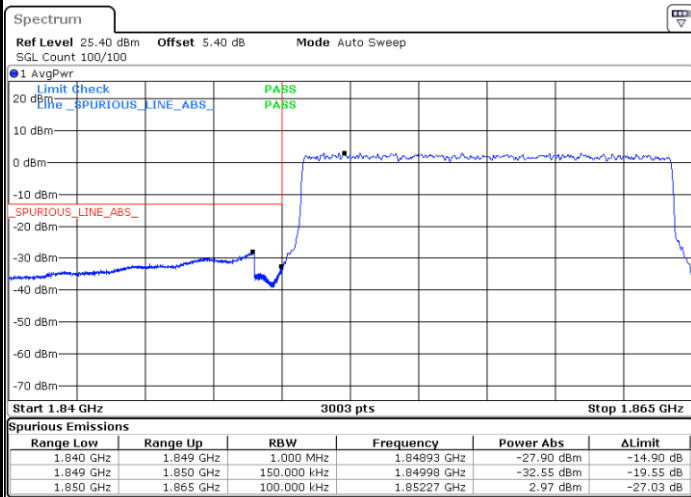

Date: 8.FEB.2023 08:45:41

Highest Band Edge / Full RB

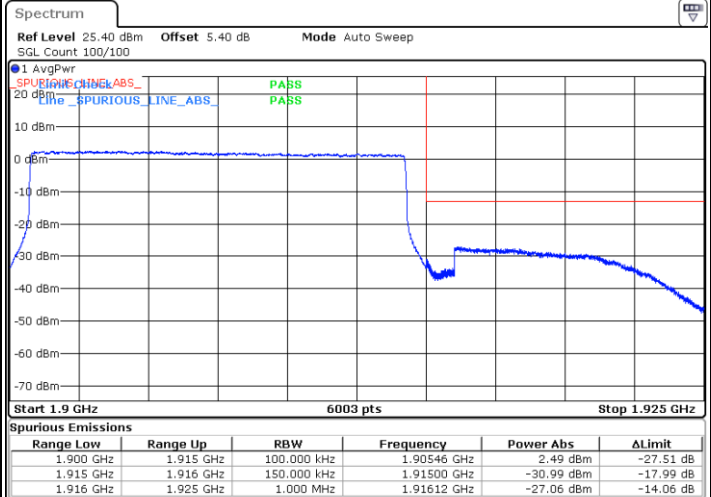

Date: 8.FEB.2023 08:56:33



LTE Band 25 / 15MHz / 16QAM

Lowest Band Edge / 1 RB

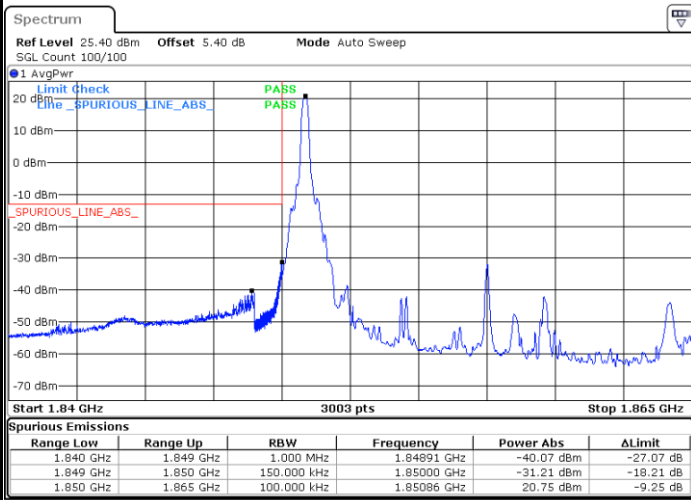

Date: 8.FEB.2023 08:51:02

Highest Band Edge / 1 RB

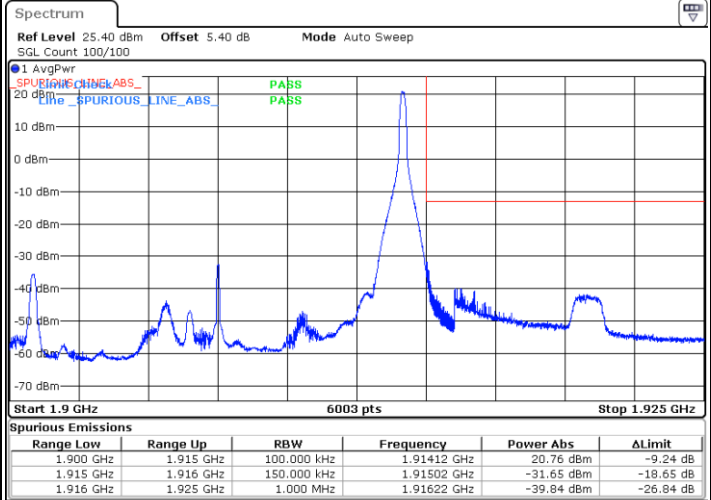

Date: 8.FEB.2023 09:00:33

Lowest Band Edge / Full RB

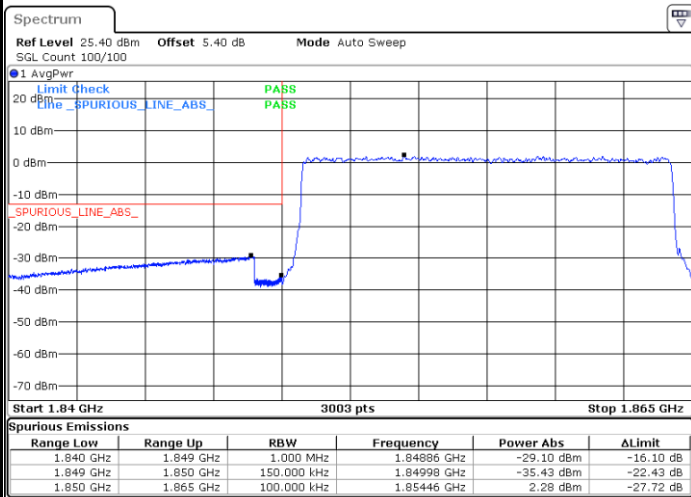

Date: 8.FEB.2023 08:47:01

Highest Band Edge / Full RB

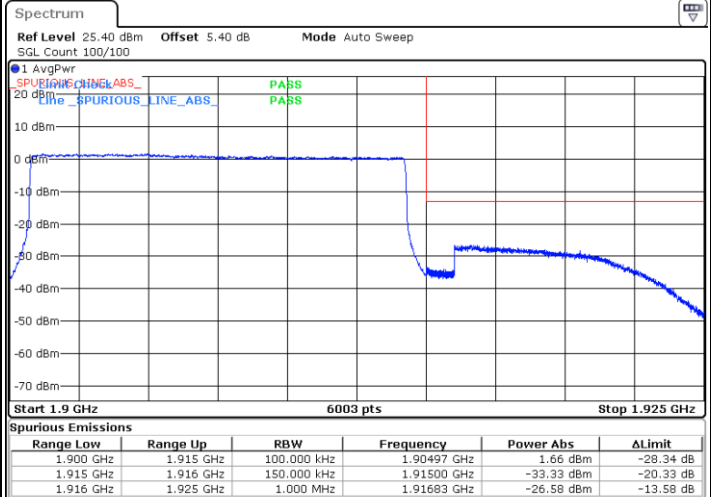

Date: 8.FEB.2023 08:57:53



LTE Band 25 / 20MHz / QPSK

Lowest Band Edge / 1 RB

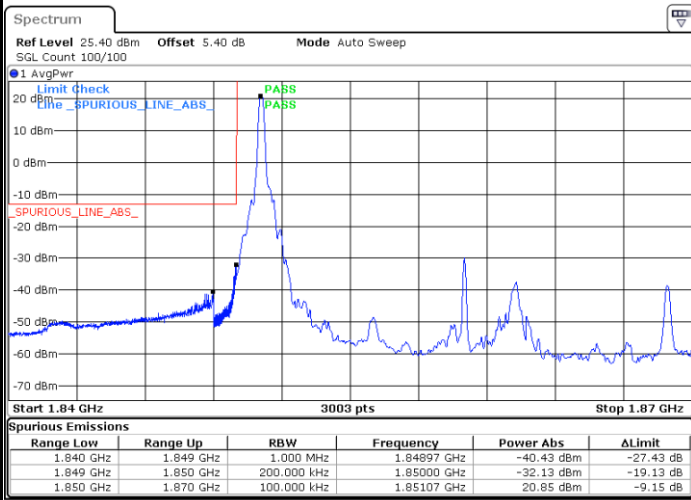

Date: 8.FEB.2023 09:05:56

Highest Band Edge / 1 RB

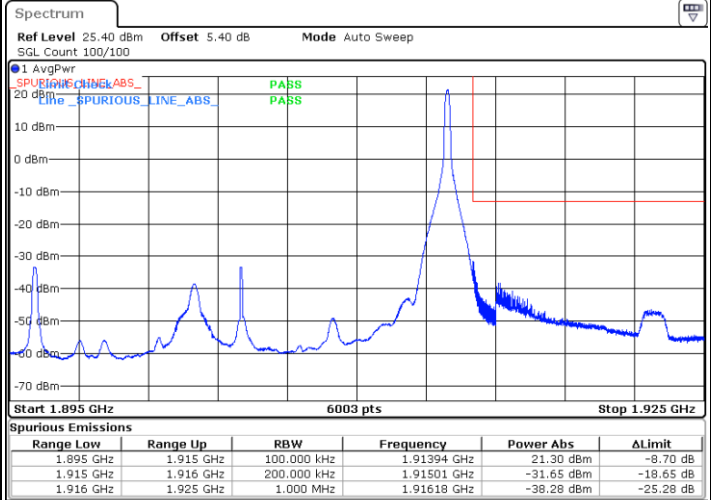

Date: 8.FEB.2023 09:15:25

Lowest Band Edge / Full RB

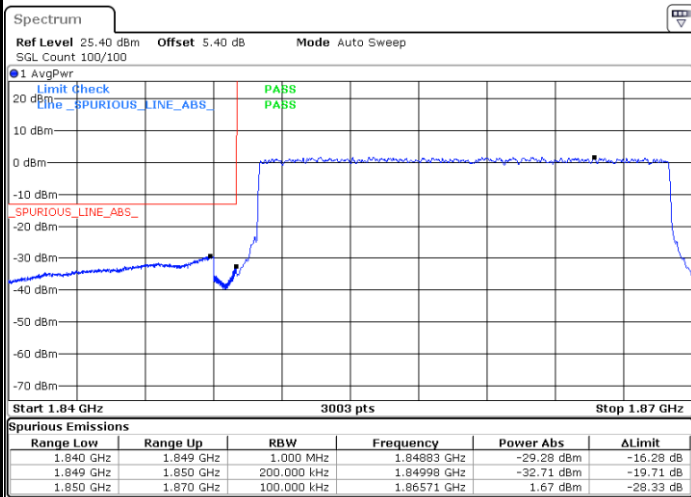

Date: 8.FEB.2023 09:01:54

Highest Band Edge / Full RB

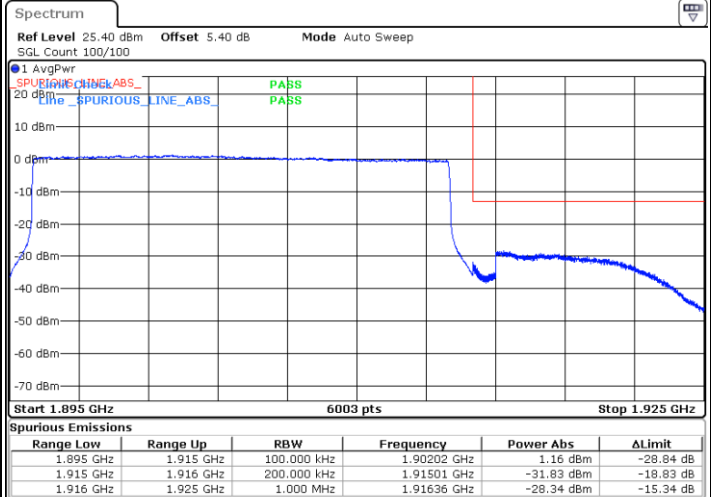

Date: 8.FEB.2023 09:12:45



LTE Band 25 / 20MHz / 16QAM

Lowest Band Edge / 1 RB

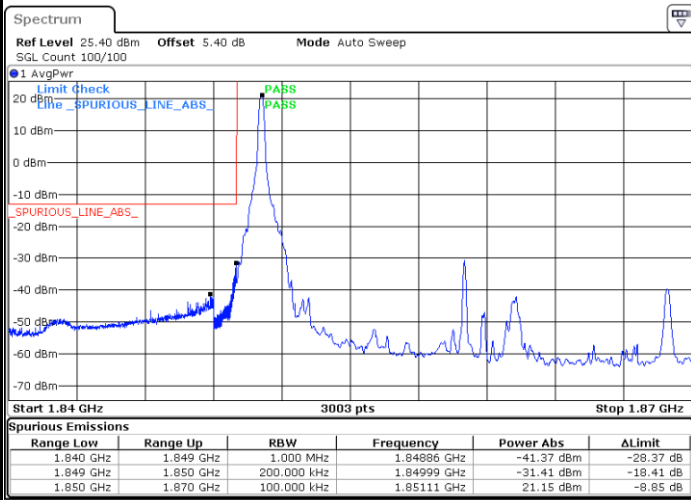

Date: 8.FEB.2023 09:07:15

Highest Band Edge / 1 RB

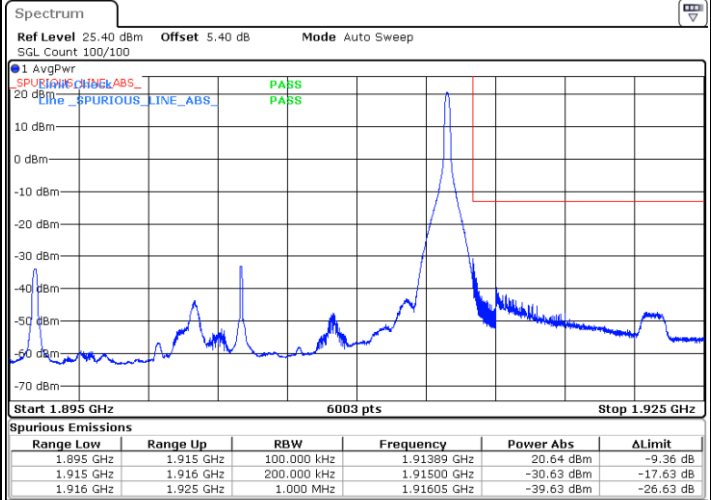

Date: 8.FEB.2023 09:16:45

Lowest Band Edge / Full RB

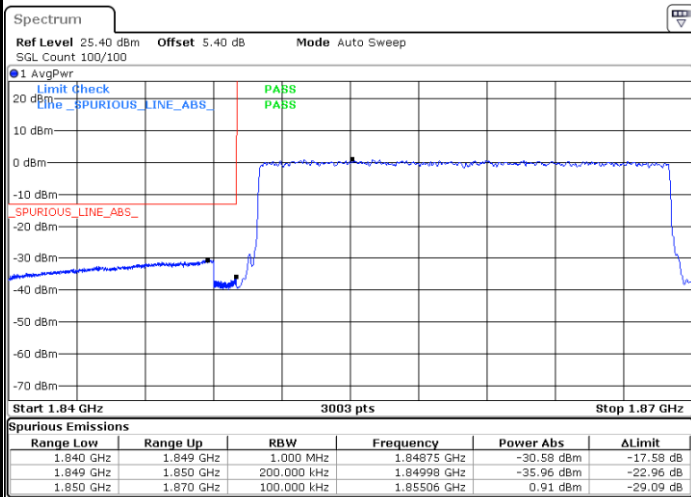

Date: 8.FEB.2023 09:03:14

Highest Band Edge / Full RB

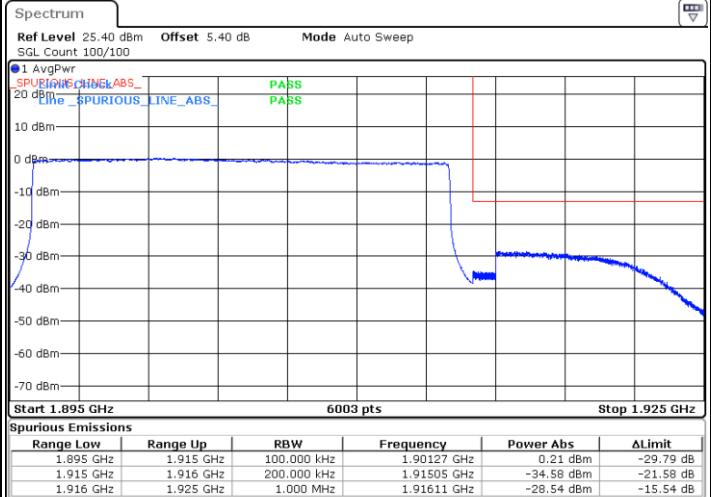

Date: 8.FEB.2023 09:14:05



# Conducted Spurious Emission

## LTE Band 25 / 1.4MHz

### Lowest Channel / QPSK

### Middle Channel / QPSK

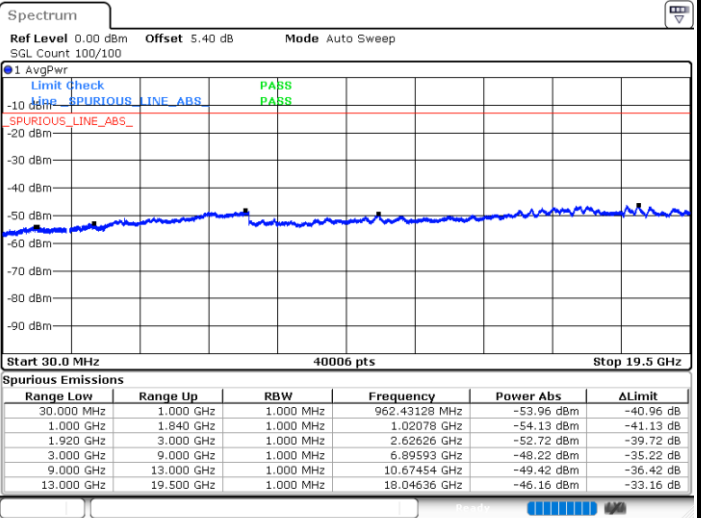
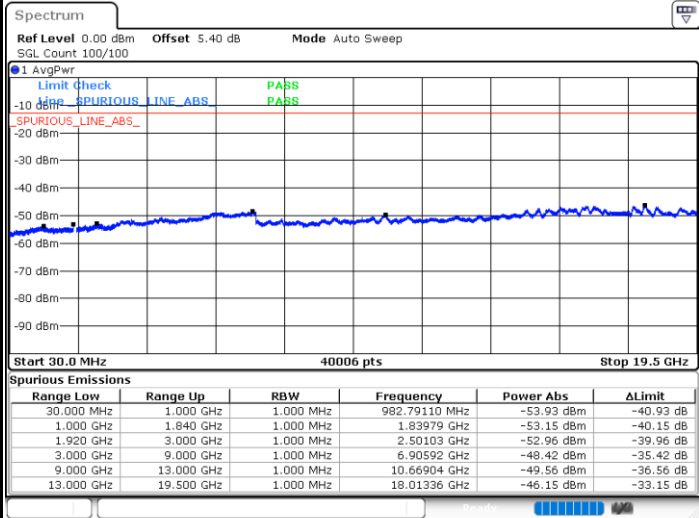

Date: 7.FEB.2023 19:24:39

Date: 7.FEB.2023 19:34:06

### Highest Channel / QPSK

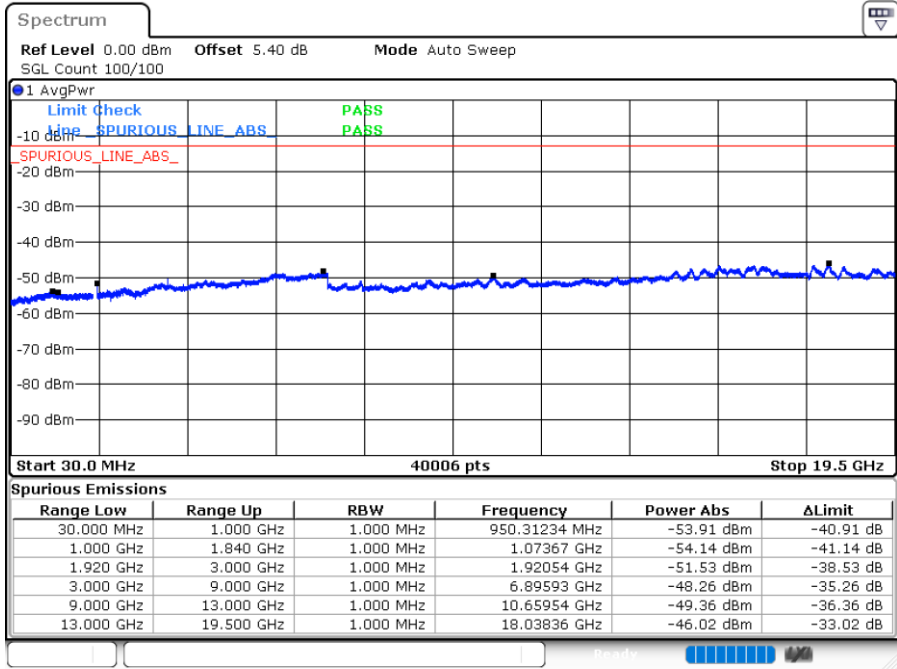

Date: 7.FEB.2023 19:35:26



LTE Band 25 / 3MHz

Lowest Channel / QPSK

Middle Channel / QPSK

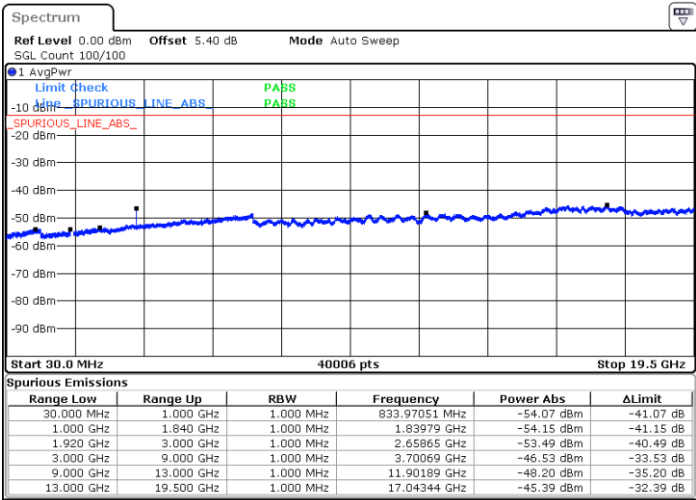

Date: 8.FEB.2023 07:59:43

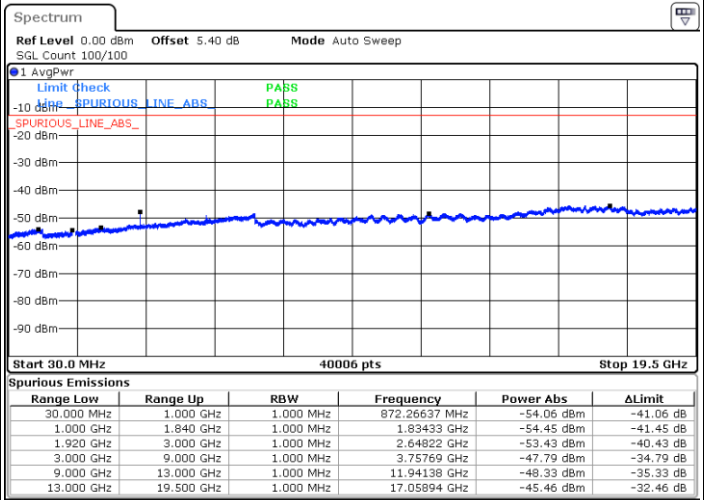

Date: 8.FEB.2023 08:05:11

Highest Channel / QPSK

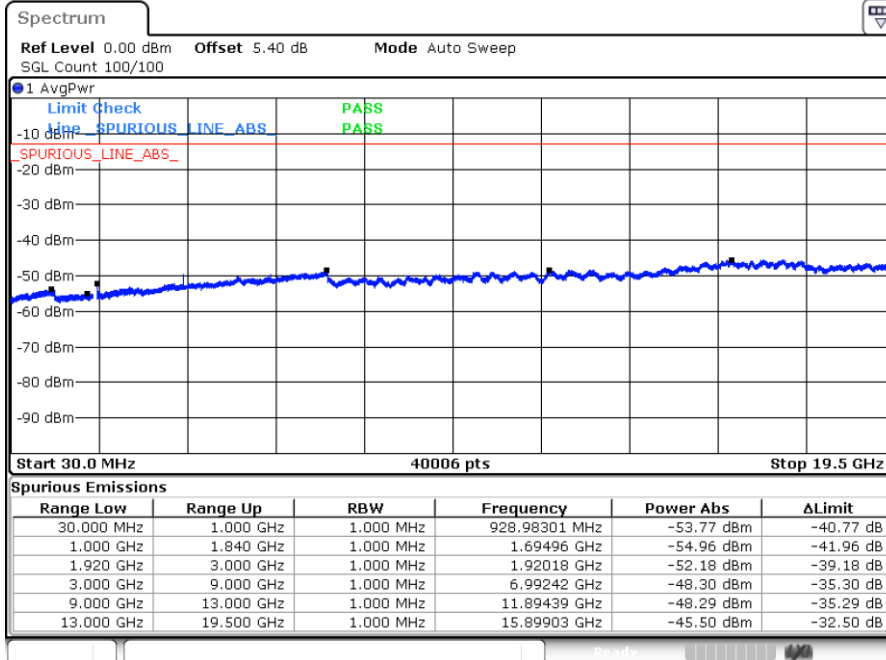

Date: 8.FEB.2023 08:06:33



LTE Band 25 / 5MHz

Lowest Channel / QPSK

Middle Channel / QPSK

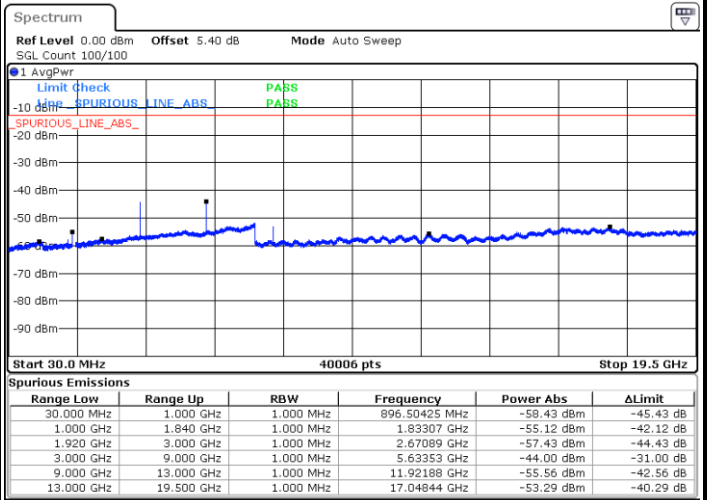
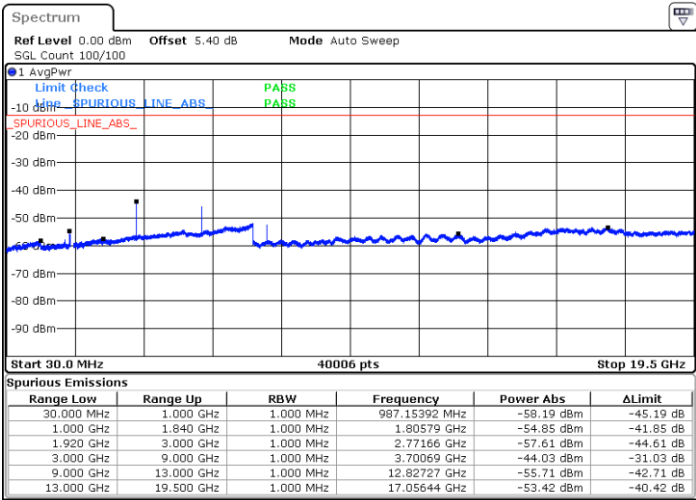

Date: 8.FEB.2023 08:15:56

Date: 8.FEB.2023 08:19:58

Highest Channel / QPSK

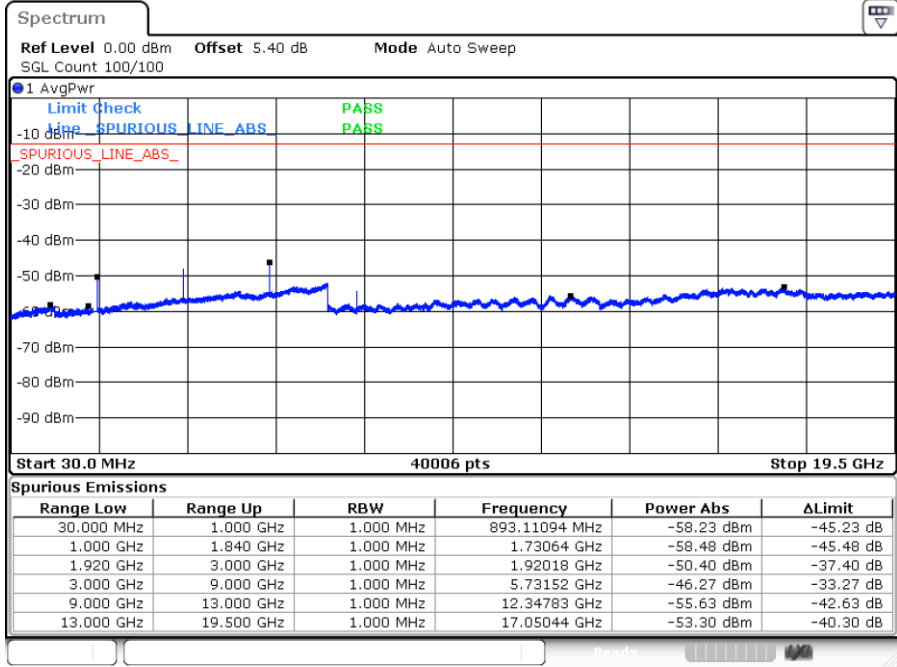

Date: 8.FEB.2023 08:22:46





LTE Band 25 / 10MHz

Lowest Channel / QPSK

Middle Channel / QPSK

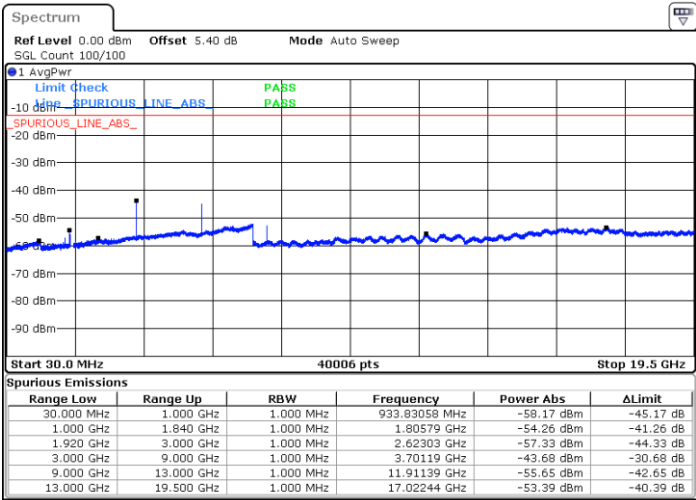

Date: 8.FEB.2023 08:33:30

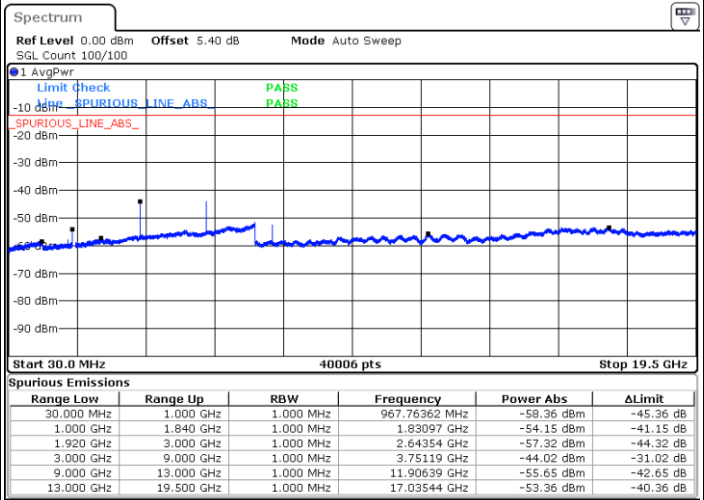

Date: 8.FEB.2023 08:36:12

Highest Channel / QPSK

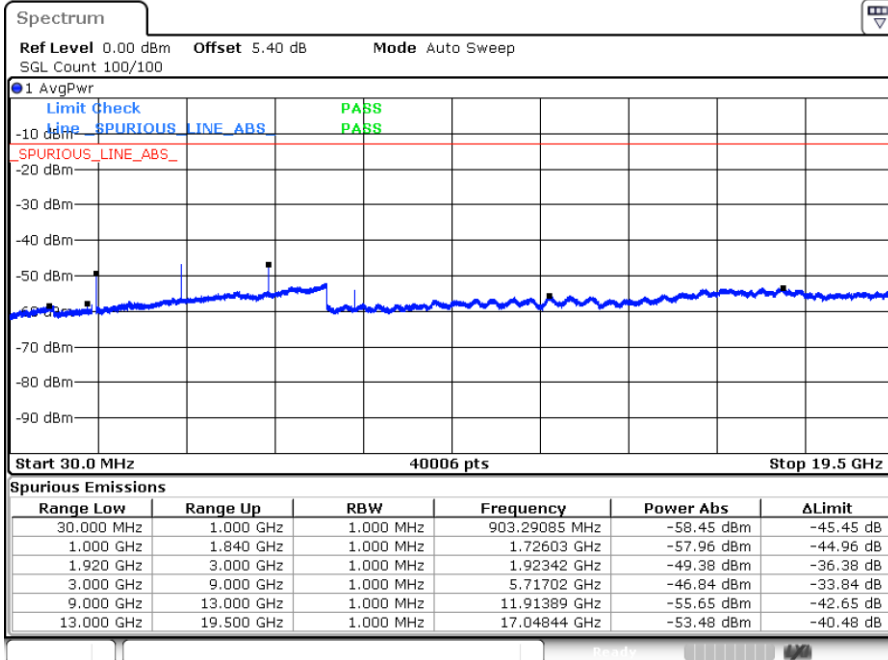

Date: 8.FEB.2023 08:39:00