

FCC Radio Test Report

FCC ID: XMR2023RM520NGLM

Report No. : BTL-FCCP-10-2311T076
Equipment : 5G Sub-6 GHz M.2 Module
Model Name : RM520N-GL
Brand Name : Quectel
Applicant : Quectel Wireless Solutions Co., Ltd.
Address : Building 5, Shanghai Business Park Phase III (Area B), No.1016 Tianlin Road, Minhang District, Shanghai, China 200233

Radio Function : LTE Band 14

FCC Rule Part(s) : FCC CFR Title 47, Part 90, Subpart R

Date of Receipt : 2023/11/16
Date of Test : 2023/11/27 ~ 2024/1/12
Issued Date : 2024/3/19

The above equipment has been tested and found in compliance with the requirement of the above standards by BTL Inc.

Prepared by :

Jerry Chuang, Supervisor

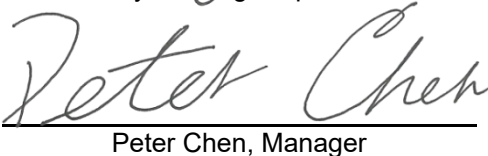

Approved by :

Peter Chen, Manager

BTL Inc.

No.18, Ln. 171, Sec. 2, Jiuzong Rd., Neihu Dist., Taipei City 114, Taiwan

Tel: +886-2-2657-3299 Fax: +886-2-2657-3331 Web: www.newbtl.com Service mail: btl_qa@newbtl.com

Declaration

BTL represents to the client that testing is done in accordance with standard procedures as applicable and that test instruments used has been calibrated with standards traceable to international standard(s) and/or national standard(s).

BTL's reports apply only to the specific samples tested under conditions. It is manufacture's responsibility to ensure that additional production units of this model are manufactured with the identical electrical and mechanical components. **BTL** shall have no liability for any declarations, inferences or generalizations drawn by the client or others from **BTL** issued reports.

This report is the confidential property of the client. As a mutual protection to the clients, the public and ourselves, the test report shall not be reproduced, except in full, without our written approval.

BTL's laboratory quality assurance procedures are in compliance with the **ISO/IEC 17025** requirements, and accredited by the conformity assessment authorities listed in this test report.

BTL is not responsible for the sampling stage, so the results only apply to the sample as received.

The information, data and test plan are provided by manufacturer which may affect the validity of results, so it is manufacturer's responsibility to ensure that the apparatus meets the essential requirements of applied standards and in all the possible configurations as representative of its intended use.

Limitation

For the use of the authority's logo is limited unless the Test Standard(s)/Scope(s)/Item(s) mentioned in this test report is (are) included in the conformity assessment authorities acceptance respective.

Please note that the measurement uncertainty is provided for informational purpose only and are not use in determining the Pass/Fail results.

CONTENTS

1	SUMMARY OF TEST RESULTS	5
1.1	REFERENCE TEST GUIDANCE	6
1.2	TEST FACILITY	6
1.3	MEASUREMENT UNCERTAINTY	6
1.4	TEST ENVIRONMENT CONDITIONS	6
2	GENERAL INFORMATION	7
2.1	DESCRIPTION OF EUT	7
2.2	TEST MODES	8
2.3	BLOCK DIAGRAM SHOWING THE CONFIGURATION OF SYSTEM TESTED	9
2.4	SUPPORT UNITS	9
3	EFFECTIVE RADIATED POWER MEASUREMENT	10
3.1	LIMIT	10
3.2	TEST PROCEDURE	10
3.3	DEVIATION FROM TEST STANDARD	10
3.4	TEST SETUP	10
3.5	EUT OPERATING CONDITIONS	10
3.6	TEST RESULT	10
4	RADIATED SPURIOUS EMISSIONS MEASUREMENT	11
4.1	LIMIT	11
4.2	TEST PROCEDURE	11
4.3	DEVIATION FROM TEST STANDARD	11
4.4	TEST SETUP	12
4.5	EUT OPERATING CONDITIONS	12
4.6	TEST RESULT	12
5	LIST OF MEASURING EQUIPMENTS	13
6	EUT TEST PHOTO	14
7	EUT PHOTOS	14
APPENDIX A	EFFECTIVE RADIATED POWER	15
APPENDIX B	RADIATED SPURIOUS EMISSIONS	18

REVISION HISTORY

Report No.	Version	Description	Issued Date	Note
BTL-FCCP-10-2311T076	R00	Original Report.	2024/1/31	Invalid
BTL-FCCP-10-2311T076	R01	Revised report to address TCB's comments.	2024/3/6	Invalid
BTL-FCCP-10-2311T076	R02	Revised Typo.	2024/3/19	Invalid
BTL-FCCP-10-2311T076	R03	Revised Typo.	2024/3/19	Valid

1 SUMMARY OF TEST RESULTS

Test procedures according to the technical standards.

Standard(s) Section	Description	Test Result	Judgement	Remark
2.1046 90.542 (a)(7)	Effective Radiated Power	APPENDIX A	Pass	-----
2.1053 90.543 (c) 90.543 (f)	Radiated Spurious Emissions	APPENDIX B	Pass	-----

NOTE:

- (1) "N/A" denotes test is not applicable in this Test Report.
- (2) The report format version is TP.1.1.1.
- (3) This test report is issued for the RF module (FCCID: XMR2023RM520NGLM) to be incorporated to the host device (Model number: TP00160A), Product name: Notebook Computer).
Since the RF module has been certificated, after evaluation, above test items were criticized and reconfirmed in this report.
- (4) After spot check, this revision does not change original radio parameters.

1.1 REFERENCE TEST GUIDANCE

ANSI C63.26-2015
 ANSI/TIA-603-E-2016
 FCC KDB 971168 D01 Power Meas License Digital Systems v03r01

1.2 TEST FACILITY

The test locations stated below are under the TAF Accreditation Number 0659.

The test location(s) used to collect the test data in this report are:
 No. 68-1, Ln. 169, Sec. 2, Datong Rd., Xizhi Dist., New Taipei City 221, Taiwan
 (FCC DN: TW0659)

C05 SR10 SR11

No. 72, Ln. 169, Sec. 2, Datong Rd., Xizhi Dist., New Taipei City 221, Taiwan
 (FCC DN: TW0659)

C06 CB21 CB22

1.3 MEASUREMENT UNCERTAINTY

The reported uncertainty of measurement $y \pm U$, where expanded uncertainty U is based on a standard uncertainty multiplied by a coverage factor of $k = 2$, providing a level of confidence of approximately **95 %**.

The measurement instrumentation uncertainty considerations contained in CISPR 16-4-2. The BTL measurement uncertainty is less than the CISPR 16-4-2 U_{cispr} requirement.

A. Radiated emissions test :

Test Site	Measurement Frequency Range	U,(dB)
CB21	0.03 GHz ~ 0.2 GHz	4.17
	0.2 GHz ~ 1 GHz	4.72
	1 GHz ~ 6 GHz	5.21
	6 GHz ~ 18 GHz	5.51
	18 GHz ~ 26 GHz	3.69
	26 GHz ~ 40 GHz	4.23

NOTE:

Unless specifically mentioned, the uncertainty of measurement has not been taken into account to declare the compliance or non-compliance to the specification.

1.4 TEST ENVIRONMENT CONDITIONS

Test Item	Environment Condition	Test Voltage	Tested by
Effective Radiated Power	22.5 °C, 51 %	AC 120V	Cora Lin
Radiated Spurious Emissions	Refer to data	AC 120V	Kevin Zhen

2 GENERAL INFORMATION

2.1 DESCRIPTION OF EUT

Equipment	5G Sub-6 GHz M.2 Module			
Model Name	RM520N-GL			
Brand Name	Quectel			
Model Difference	N/A			
Power Source	Supplied from host system.			
Power Rating	3.3 Vdc			
Host device information				
Equipment	Notebook Computer			
Model Name	TP00160A			
Brand Name	Lenovo			
Model Difference	N/A			
Power Source	DC voltage supplied from External Power Supply. (Lenovo/ ADLX65YSDC2A)			
Power Rating	I/P: 100-240V~ 1.8A 50-60Hz O/P: 20.0VDC 3.25A 65.0W / 15.0VDC 3.0A / 9.0VDC 3.0A / 5.0VDC 3.0A 15.0W			
WIFI+BT Module	Intel® Wi-Fi 6E AX211 / AX211D2W Intel® BE200D2W / BE200D2W			
WWAN Module	Quectel / RM520N-GL Quectel / EM061K-GL			
NFC Module	FOXCONN / T77H747			
Operation Frequency	Band	UL Frequency (MHz)	DL Frequency (MHz)	
	LTE 14	788 ~ 798	758 ~ 768	
Maximum ERP	Band	BW (MHz)	Mode	Power (W)
	LTE 14	5	QPSK	0.055
			16QAM	0.047
			64QAM	0.045
			256QAM	0.020
	LTE 14	10	QPSK	0.055
			16QAM	0.048
			64QAM	0.045
256QAM			0.020	
Test Model	RM520N-GL			
Sample Status	Engineering Sample			
EUT Modification(s)	N/A			

NOTE:

(1) The above EUT information is declared by manufacturer and for more detailed features description, please refers to the manufacturer's specifications or user's manual.

(2) Table for Filed Antenna:

Antenna	Manufacture	Parts Number	Type	Connector	Gain (dBi)	Note
Main	Luxshare-ICT	DC330022C00	PIFA	I-PEX	-3.93	LTE Band 14
Aux	Luxshare-ICT	DC330022D00	PIFA	I-PEX	-	RX only

Antenna	Manufacture	Parts Number	Type	Connector	Gain (dBi)	Note
Main	SPEEDWIRE	DC330022J10	PIFA	I-PEX	-3.93	LTE Band 14
Aux	SPEEDWIRE	DC330022J20	PIFA	I-PEX	-	RX only

(3) The above Antenna information are derived from the antenna data sheet provided by manufacturer and for more detailed features description, please refer to the manufacturer's specifications, the laboratory shall not be held responsible.

2.2 TEST MODES

Test Items	Band	Test Mode	Note
Effective Radiated Power	LTE Band 14	Refer to APPENDIX A	-
Radiated Spurious Emissions (Below 1G)	LTE Band 14	TX Mode (CH 23330)	-
Radiated Spurious Emissions (Above 1G)	LTE Band 14	TX Mode (CH 23330)	-

NOTE:

- (1) All X, Y and Z axes are evaluated, but only the worst case (X axis) is recorded.
- (2) For Radiated Spurious Emissions both QPSK, 16QAM, 64QAM and 256QAM are evaluated, but only the worst case (QPSK) is recorded.

2.3 BLOCK DIAGRAM SHOWING THE CONFIGURATION OF SYSTEM TESTED

Equipment letters and Cable numbers refer to item numbers described in the tables of clause 2.4.

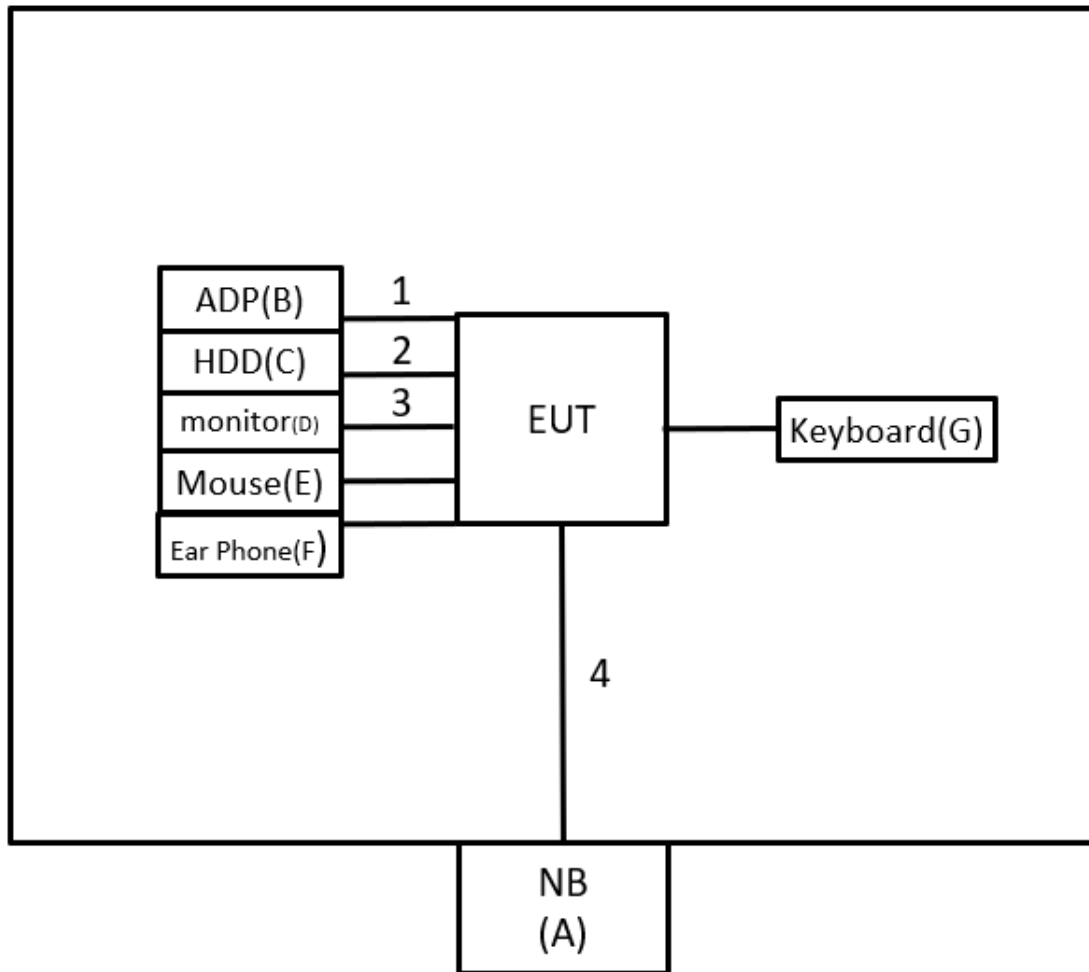

2.4 SUPPORT UNITS

Item	Equipment	Brand	Model No.	Series No.	Remarks
A	NB	HP	TPN-1119	N/A	Furnished by test lab.
B	ADP	Lenovo	ADLX65YSDC2 A	N/A	Supplied by test requester.
C	USB 2.5" HDD	TOSIBA	XS700	483B60M9KQSS	Furnished by test lab.
D	27" 4K Monitor	DELL	U2720Q	CN-083VF-WSL0 0-0B7-332L	Furnished by test lab.
E	Mouse	Lenovo	SM-8823	N/A	Furnished by test lab.
F	Ear Phone	HTC	N/A	N/A	Furnished by test lab.
G	Keyboard	Bloody	KB-8	N/A	Furnished by test lab.

Item	Shielded	Ferrite Core	Length	Cable Type	Remarks
1	N/A	N/A	0.9m	Power Cord	Supplied by test requester.
2	N/A	N/A	1m	Type C to USB Cable	Furnished by test lab.
3	N/A	N/A	1.8m	HDMI	Furnished by test lab.
4	N/A	N/A	10m	RJ45 Cable	Furnished by test lab.

3 EFFECTIVE RADIATED POWER MEASUREMENT

3.1 LIMIT

Mobile / Portable station are limited to 3 watts e.r.p.

3.2 TEST PROCEDURE

The testing follows FCC KDB 971168 v03r01 Section 5.8.

- a. Substitution method is used for E.I.R.P measurement. In the semi-anechoic chamber, EUT placed on the 0.8m height of Turn Table, rotated the table around 360 degrees to search the maximum radiation power and receiver antenna shall be rotated vertical and horizontal polarization and moved height from 1m to 4m to find the maximum polar radiated power. The "Read Value" is the spectrum reading the maximum power value.
- b. The substitution horn antenna is substituted for EUT at the same position and signals generator export the CW signal to the substitution antenna via a TX cable. Rotated the Turn Table and moved receiving antenna to find the maximum radiation power. Adjust output power level of S.G to get a Value of spectrum reading equal to "Read Value " of step a. Record the power level of S.G
- c. $EIRP = \text{Output power level of S.G} - \text{TX cable loss} + \text{Antenna gain of substitution horn.}$
- d. ERP can be calculated form EIRP by subtracting the gain of dipole, $ERP = EIPR - 2.15\text{dBi.}$
- e. The resolution bandwidth and video bandwidth of test receiver/spectrum analyzer is 1MHz/3MHz.

3.3 DEVIATION FROM TEST STANDARD

No deviation.

3.4 TEST SETUP

Conducted Measurement:

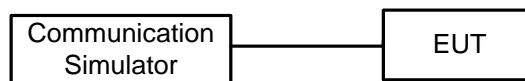

3.5 EUT OPERATING CONDITIONS

The EUT was programmed to be in continuously transmitting mode.

3.6 TEST RESULT

Please refer to the APPENDIX A.

4 RADIATED SPURIOUS EMISSIONS MEASUREMENT

4.1 LIMIT

The power of any emission outside of the authorized operating frequency ranges must be attenuated below the transmitting power (P) by a factor of at least $43 + 10 \log(P)$ dB. The emission limit equal to -13dBm.

NOTE:

- (1) The measurements of emission power can be expressed in peak or average values, provided they are expressed in the same parameters as the transmitter power.
- (2) The test result calculated as following:

Measurement Value = Reading Level + Correct Factor
 Correct Factor = Antenna Factor + Cable Loss - Amplifier Gain(if use)
 Margin Level = Measurement Value - Limit Value

Calculation example:

Reading Level (dBm)		Correct Factor (dB/m)		Measurement Value (dBm)
-50.43	+	-2.11	=	-52.54

Measurement Value (dBm)		Limit Value (dBm)		Margin Level (dB)
-52.54	-	-13	=	-39.54

4.2 TEST PROCEDURE

The testing follows FCC KDB 971168 v03r01 Section 6.2.

- a. Substitution method is used for E.I.R.P measurement. In the semi-anechoic chamber, EUT placed on the 0.8m height of Turn Table, rotated the table around 360 degrees to search the maximum radiation power and receiver antenna shall be rotated vertical and horizontal polarization and moved height from 1m to 4m to find the maximum polar radiated power. The "Read Value" is the spectrum reading the maximum power value.
- b. The substitution horn antenna is substituted for EUT at the same position and signals generator export the CW signal to the substitution antenna via a TX cable. Rotated the Turn Table and moved receiving antenna to find the maximum radiation power. Adjust output power level of S.G to get a Value of spectrum reading equal to "Read Value " of step a. Record the power level of S.G
- c. EIRP = Output power level of S.G – TX cable loss + Antenna gain of substitution horn.
- d. ERP can be calculated form EIRP by subtracting the gain of dipole, $ERP = EIPR - 2.15\text{dBi}$.
- e. The resolution bandwidth and video bandwidth of test receiver/spectrum analyzer is 1MHz/3MHz.

4.3 DEVIATION FROM TEST STANDARD

No deviation.

4.4 TEST SETUP

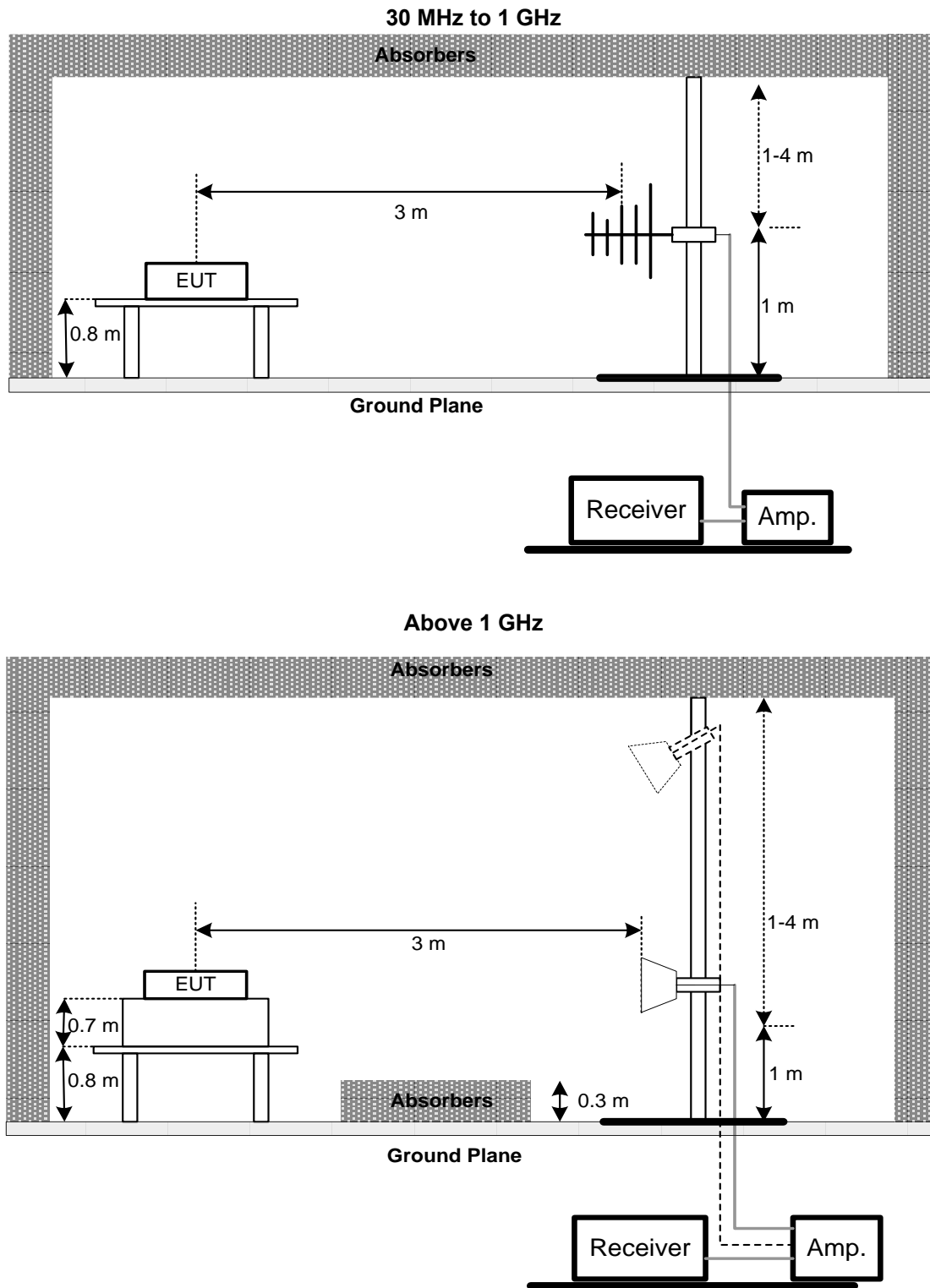

4.5 EUT OPERATING CONDITIONS

The EUT was programmed to be in continuously transmitting mode.

4.6 TEST RESULT

Please refer to the APPENDIX B.

5 LIST OF MEASURING EQUIPMENTS

Effective Radiated Power						
Item	Kind of Equipment	Manufacturer	Type No.	Serial No.	Calibrated Date	Calibrated Until
1	WIRELESS COMMUNICATION TEST SET	Agilent	E5515C	GB47390193	2023/7/4	2024/7/3
2	Radio Communication Test Station	ANRITSU	MT8821C	6262044728	2023/11/22	2024/11/21
3	Radio Communication Analyzer	ANRITSU	MT8000A	6262036844	2023/11/22	2024/11/21
4	Radio Communication Analyzer	Keysight	E7515B	MY59020217	2023/7/6	2024/7/5

Radiated Emissions						
Item	Kind of Equipment	Manufacturer	Type No.	Serial No.	Calibrated Date	Calibrated Until
1	Preamplifier	EMCI	EMC330N	980850	2023/9/6	2024/9/5
2	Preamplifier	EMCI	EMC118A45SE	980819	2023/3/7	2024/3/6
3	Pre-Amplifier	EMCI	EMC184045SE	980907	2023/9/21	2024/9/20
4	Test Cable	EMCI	EMC104-SM-1000	180809	2023/7/10	2024/7/9
5	Test Cable	EMCI	EMC104-SM-SM-3000	220322	2023/3/14	2024/3/13
6	Test Cable	EMCI	EMC104-SM-SM-7000	220324	2023/3/14	2024/3/13
7	EXA Signal Analyzer	keysight	N9020B	MY57120120	2023/2/24	2024/2/23
8	Horn Antenna	RFSPIN	DRH18-E	211202A18EN	2023/5/12	2024/5/11
9	Horn Ant	Schwarzbeck	BBHA 9170D	1136	2023/5/12	2024/5/11
10	Log-bicon Antenna	Schwarzbeck	VULB9168	1369	2023/5/9	2024/5/8
11	6dB Attenuator	EMCI	EMCI-N-6-06	AT-06001	2023/5/9	2024/5/8
12	Test Cable	EMCI	EMC101G-KM-KM-3000	220329	2023/3/14	2024/3/13
13	Test Cable	EMCI	EMC102-KM-KM-1000	220327	2023/3/14	2024/3/13
14	WIRELESS COMMUNICATION TEST SET	Agilent	E5515C	GB47390193	2023/7/4	2024/7/3
15	Radio Communication Analyzer	ANRITSU	MT8820C	6201381608	2022/12/22	2023/12/21
16	Radio Communication Analyzer	Keysight	E7515B	MY59020217	2023/7/6	2024/7/5
17	Measurement Software	EZ	EZ_EMCI (Version NB-03A1-01)	N/A	N/A	N/A

Remark: "N/A" denotes no model name, no serial no. or no calibration specified.
All calibration period of equipment list is one year.

6 EUT TEST PHOTO

Please refer to document Appendix No.: TP-2311T076-FCCP-1 (APPENDIX-TEST PHOTOS).

7 EUT PHOTOS

Please refer to document Appendix No.: EP-2311T076-1 (APPENDIX-EUT PHOTOS).

APPENDIX A EFFECTIVE RADIATED POWER

LTE Band 14 Power:

Band	BW (MHz)	Channel	Frequency (MHz)	Mode	UL RB Allocation	UL RB Offset	MPR	Average power (dBm)	ERP power (dBm)	ERP power (W)
14	5	23305	790.5	QPSK	1	0	0	23.47	17.39	0.055
					1	12	0	23.39	17.31	0.054
					1	24	0	23.30	17.22	0.053
					25	0	1	22.32	16.24	0.042
				16QAM	1	0	1	22.82	16.74	0.047
					1	12	1	22.68	16.60	0.046
					1	24	1	22.76	16.68	0.047
				64QAM	25	0	2	21.36	15.28	0.034
					1	0	2	22.59	16.51	0.045
					1	12	2	22.61	16.53	0.045
					1	24	2	22.55	16.47	0.044
				256QAM	25	0	3	21.33	15.25	0.033
		1	0		4	18.99	12.91	0.020		
		1	12		4	18.87	12.79	0.019		
		1	24		4	18.67	12.59	0.018		
		23330	793.0	QPSK	25	0	5	18.70	12.62	0.018
					1	0	0	23.46	17.38	0.055
					1	12	0	23.37	17.29	0.054
					1	24	0	23.29	17.21	0.053
				16QAM	25	0	1	22.32	16.24	0.042
					1	0	1	22.82	16.74	0.047
					1	12	1	22.68	16.60	0.046
				64QAM	1	24	1	22.75	16.67	0.046
					25	0	2	21.38	15.30	0.034
					1	0	2	22.58	16.50	0.045
					1	12	2	22.60	16.52	0.045
				256QAM	1	24	2	22.56	16.48	0.044
		25	0		3	21.31	15.23	0.033		
		1	0		4	18.97	12.89	0.019		
		1	12		4	18.89	12.81	0.019		
		23355	795.5	QPSK	1	24	4	18.68	12.60	0.018
					25	0	5	18.73	12.65	0.018
					1	0	0	23.45	17.37	0.055
					1	12	0	23.37	17.29	0.054
				16QAM	1	24	0	23.30	17.22	0.053
					25	0	1	22.31	16.23	0.042
					1	0	1	22.84	16.76	0.047
				64QAM	1	12	1	22.69	16.61	0.046
					1	24	1	22.77	16.69	0.047
					25	0	2	21.39	15.31	0.034
					1	0	2	22.57	16.49	0.045
				256QAM	1	12	2	22.60	16.52	0.045
		1	24		2	22.56	16.48	0.044		
		25	0		3	21.32	15.24	0.033		
		1	0		4	18.99	12.91	0.020		
		256QAM	1	12	4	18.88	12.80	0.019		
			1	24	4	18.69	12.61	0.018		
			25	0	5	18.73	12.65	0.018		
25	0		5	18.73	12.65	0.018				

NOTE:

(1) EIRP = Average power + Antenna gain.

(2) ERP = EIRP - 2.15.

 (3) $P(W) = 10^{(P(dBm) / 10)} / 1000$

Band	BW (MHz)	Channel	Frequency (MHz)	Mode	UL RB Allocation	UL RB Offset	MPR	Average power (dBm)	ERP power (dBm)	ERP power (W)
14	10	23330	793.0	QPSK	1	0	0	23.51	17.43	0.055
					1	24	0	23.44	17.36	0.054
					1	49	0	23.34	17.26	0.053
					50	0	1	22.39	16.31	0.043
				16QAM	1	0	1	22.89	16.81	0.048
					1	24	1	22.73	16.65	0.046
					1	49	1	22.82	16.74	0.047
				64QAM	50	0	2	21.43	15.35	0.034
					1	0	2	22.64	16.56	0.045
					1	24	2	22.66	16.58	0.045
					1	49	2	22.63	16.55	0.045
					50	0	3	21.38	15.30	0.034
				256QAM	1	0	4	19.03	12.95	0.020
					1	24	4	18.93	12.85	0.019
					1	49	4	18.74	12.66	0.018
					50	0	5	18.77	12.69	0.019

NOTE:

(1) EIRP = Average power + Antenna gain.

(2) ERP = EIRP - 2.15.

(3) $P(W) = 1 W \cdot 10^{(P(dBm) / 10) / 1000}$

APPENDIX B RADIATED SPURIOUS EMISSIONS

Test Mode	LTE Band 14	Test Date	2023/11/29
Test Channel	CH23330	Polarization	Vertical
Temp	23°C	Hum.	56%

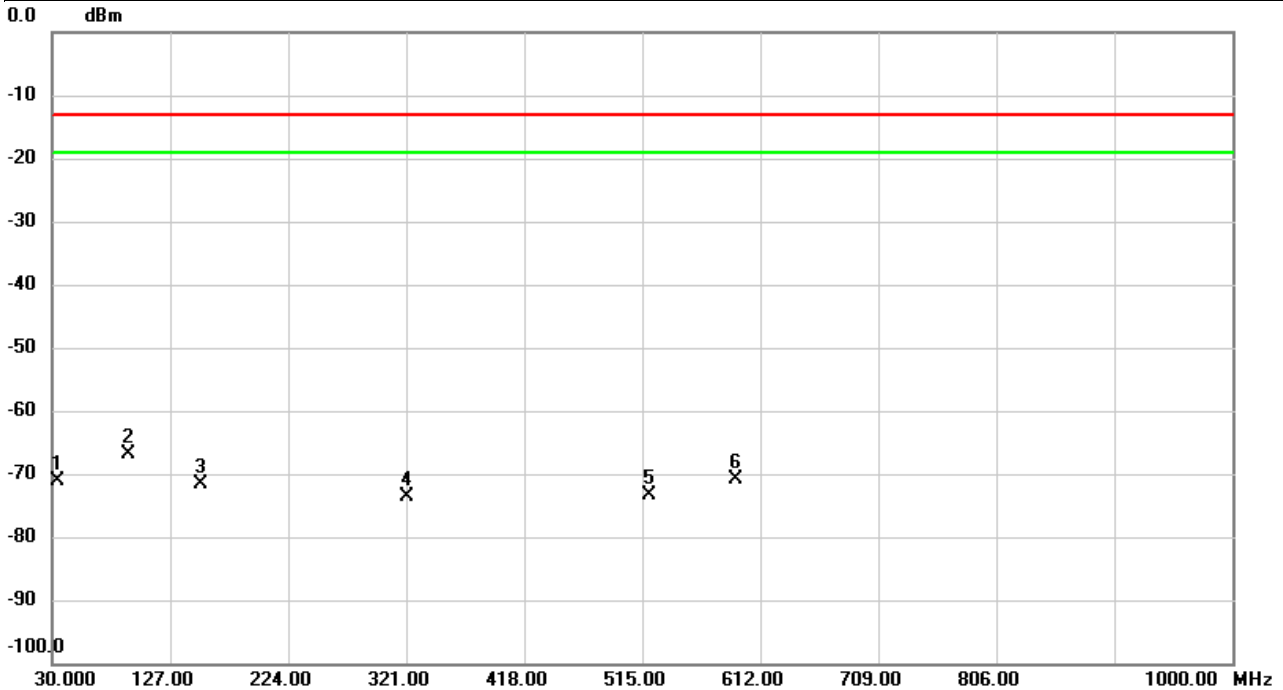

No.	Mk.	Freq. MHz	Reading Level dBm	Correct Factor dB	Measure- ment dBm	Limit dBm	Over dB	Detector	Comment
1		34.6237	-61.78	-9.33	-71.11	-13.00	-58.11	peak	
2	*	92.8883	-61.09	-5.79	-66.88	-13.00	-53.88	peak	
3		152.6727	-69.06	-2.59	-71.65	-13.00	-58.65	peak	
4		321.0323	-70.62	-3.09	-73.71	-13.00	-60.71	peak	
5		520.4320	-74.47	1.13	-73.34	-13.00	-60.34	peak	
6		592.1150	-73.98	3.14	-70.84	-13.00	-57.84	peak	

REMARKS:

- (1) Measurement Value = Reading Level + Correct Factor.
- (2) Margin Level = Measurement Value - Limit Value.

Test Mode	LTE Band 14	Test Date	2023/11/29
Test Channel	CH23330	Polarization	Horizontal
Temp	23°C	Hum.	56%

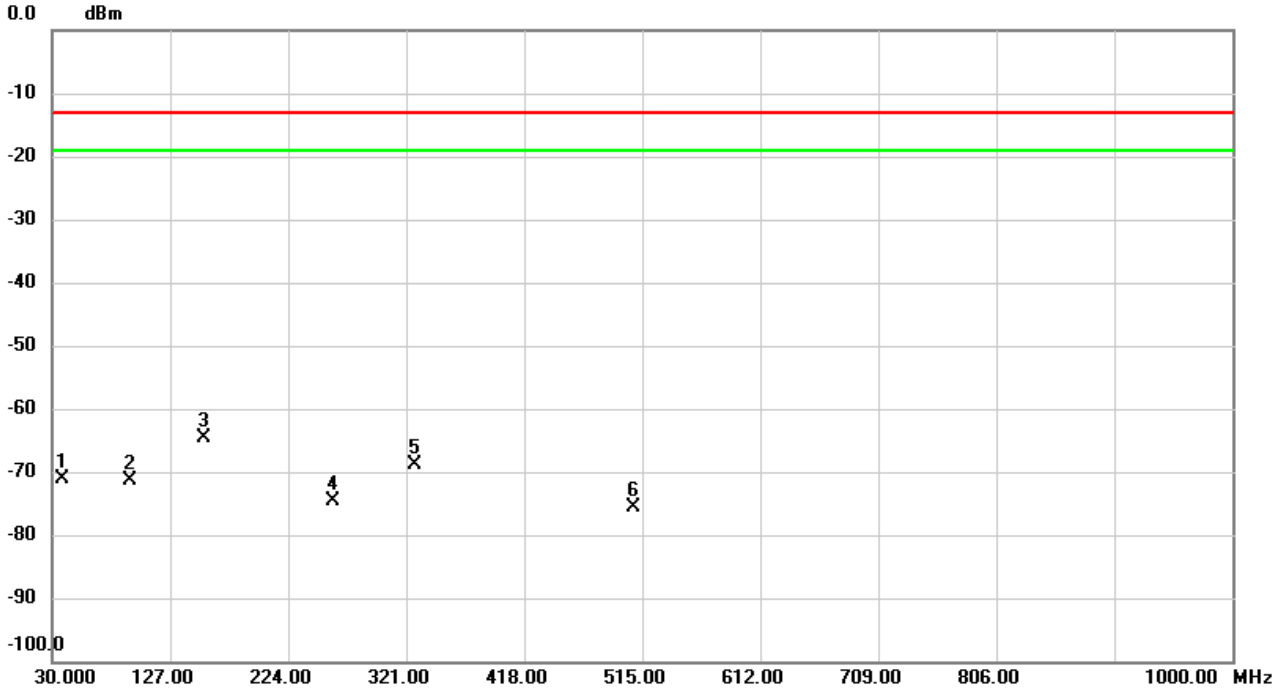

No.	Mk.	Freq.	Reading Level	Correct Factor	Measurement	Limit	Over	Detector	Comment
		MHz	dBm	dB	dBm	dBm	dB		
1		38.7300	-73.23	2.00	-71.23	-13.00	-58.23	peak	
2		94.0523	-63.23	-8.13	-71.36	-13.00	-58.36	peak	
3	*	154.4187	-58.80	-5.82	-64.62	-13.00	-51.62	peak	
4		260.3103	-66.97	-7.61	-74.58	-13.00	-61.58	peak	
5		327.8223	-64.82	-4.17	-68.99	-13.00	-55.99	peak	
6		508.3717	-74.26	-1.41	-75.67	-13.00	-62.67	peak	

REMARKS:

- (1) Measurement Value = Reading Level + Correct Factor.
- (2) Margin Level = Measurement Value - Limit Value.

Test Mode	LTE Band 14	Test Date	2023/11/27
Test Channel	CH23330	Polarization	Vertical
Temp	21°C	Hum.	57%

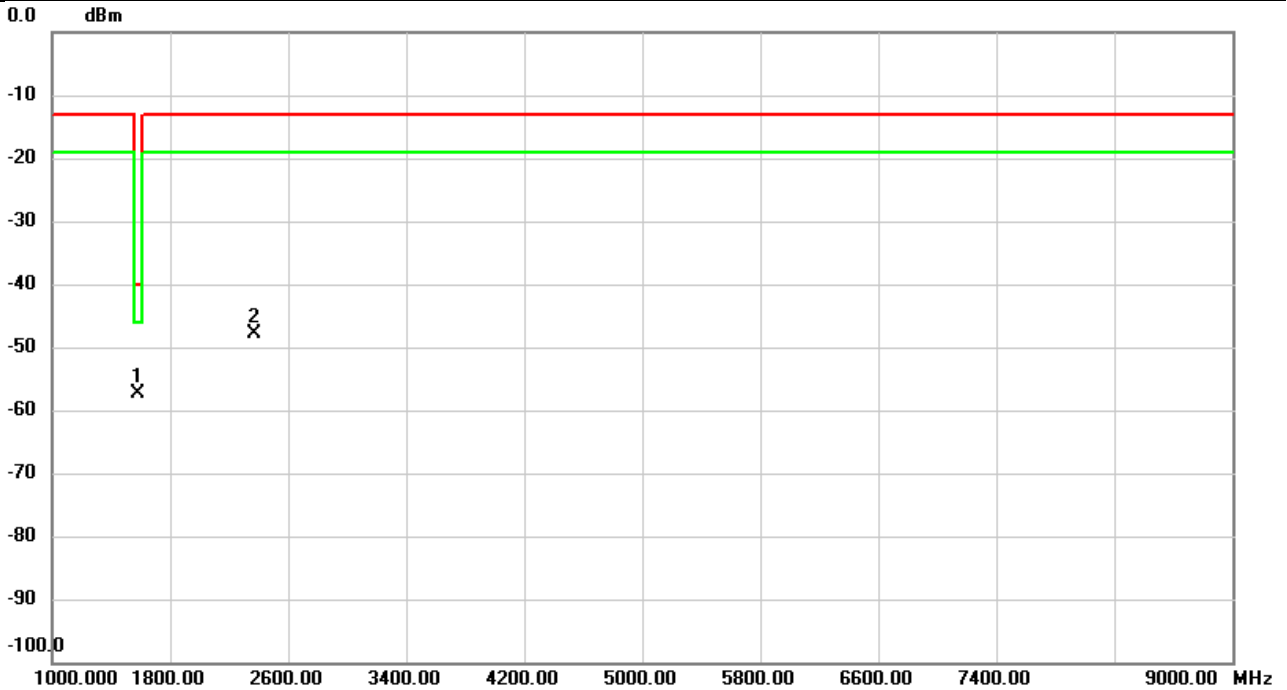

No.	Mk.	Freq.	Reading Level	Correct Factor	Measurement	Limit	Over	Detector	Comment
		MHz	dBm	dB	dBm	dBm	dB		
1	*	1577.867	-61.94	4.63	-57.31	-40.00	-17.31	peak	
2		2365.600	-55.39	7.54	-47.85	-13.00	-34.85	peak	

REMARKS:

- (1) Measurement Value = Reading Level + Correct Factor.
- (2) Margin Level = Measurement Value - Limit Value.

Test Mode	LTE Band 14	Test Date	2023/11/27
Test Channel	CH23330	Polarization	Horizontal
Temp	21°C	Hum.	57%

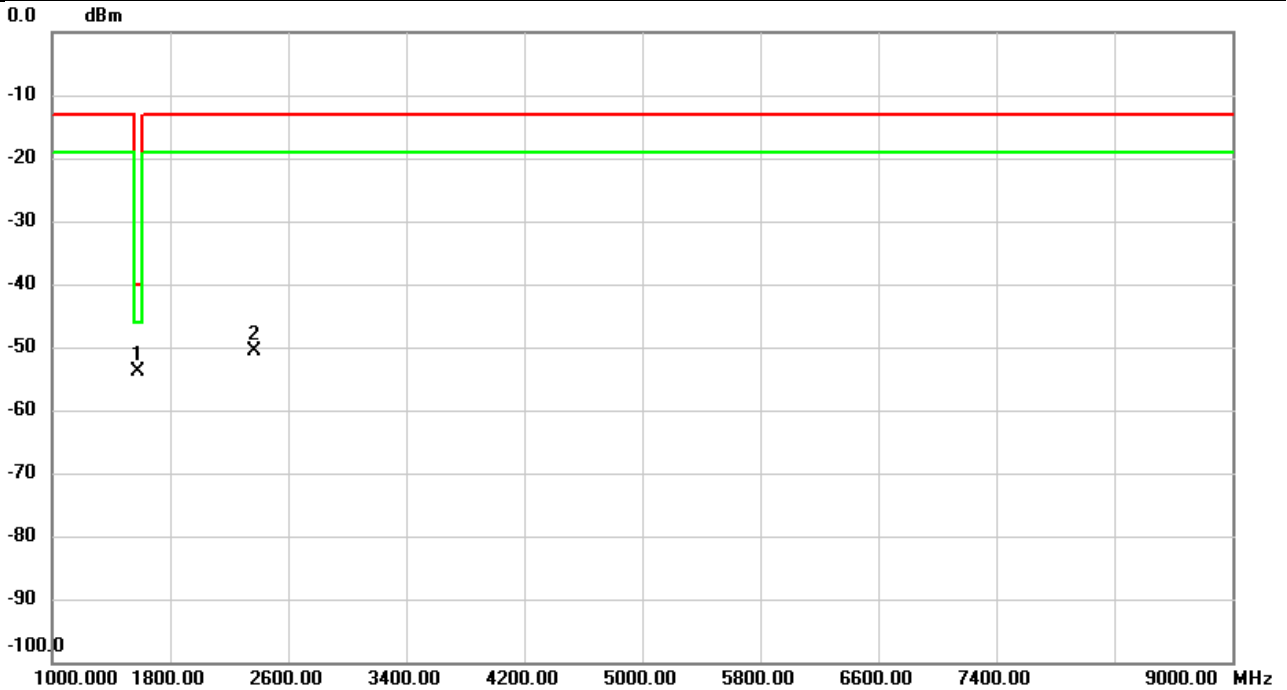

No.	Mk.	Freq.	Reading Level	Correct Factor	Measurement	Limit	Over	Detector	Comment
		MHz	dBm	dB	dBm	dBm	dB		
1	*	1577.067	-58.51	4.71	-53.80	-40.00	-13.80	peak	
2		2365.867	-58.34	7.70	-50.64	-13.00	-37.64	peak	

REMARKS:

- (1) Measurement Value = Reading Level + Correct Factor.
- (2) Margin Level = Measurement Value - Limit Value.

End of Test Report