

Lenovo
ThinkPad X1

ThinkPad X1 Carbon Gen 12 and ThinkPad X1
2-in-1 Gen 9
User Guide

Lenovo
ThinkPad



Lenovo

Read this first

Before using this documentation and the product it supports, ensure that you read and understand the following:

- *Safety and Warranty Guide*
- *Setup Guide*
- [Generic Safety and Compliance Notices](#)

First Edition (December 2023)

© Copyright Lenovo 2023.

LIMITED AND RESTRICTED RIGHTS NOTICE: If data or software is delivered pursuant to a General Services Administration "GSA" contract, use, reproduction, or disclosure is subject to restrictions set forth in Contract No. GS-35F-05925.

Contents

Discover your Lenovo notebook.iii

Chapter 1. Meet your computer. 1

Front view	1
Side view	5
Bottom view	7
Features and specifications	8
USB specifications.	8

Chapter 2. Get started with your computer. 11

Access networks	11
Interact with your computer	12
Use the keyboard shortcuts	12
Use the TrackPoint pointing device	13
Use the Haptic Touchpad / trackpad	15
Use the touch screen (for selected models)	19
Connect to an external display	21
Get to know convertible multi-modes	22
Use Lenovo Slim Pen (for selected models)	24

Chapter 3. Explore your computer 27

Lenovo apps	27
Lenovo Commercial Vantage	27
Lenovo View	27
TrackPoint Quick Menu	29
Intelligent Cooling	31
Manage power	32
Check the battery status	32
Charge the computer	32
Change the power settings	33
Enable Flip to Start.	33
Transfer data	34
Connect to a Bluetooth device	34
Set up an NFC connection	34
Accessories	34
Purchase accessories	35

Chapter 4. Secure your computer and information 37

Lock the computer	37
Log in with your fingerprint	37
Log in with your face ID (for selected models)	38
User Presence Sensing (for selected models)	38
Lock on leave function (for selected models only)	40
Protect your privacy (for selected models)	40

Protect data against power loss (for selected models)	41
UEFI BIOS passwords	41
Password types	41
Set, change, and remove a password	42
Associate your fingerprints with passwords (for selected models)	43
FIDO (Fast Identity Online) authentication	43

Chapter 5. Configure advanced settings. 45

UEFI BIOS	45
Enter the UEFI BIOS menu.	45
Navigate in the UEFI BIOS interface	45
Set the system date and time.	45
Change the startup sequence	45
View UEFI BIOS Event logs	45
Detect memory retraining (for Intel models only)	46
Customize BIOS Defaults	47
Reset system to factory defaults	47
Recover the UEFI BIOS	48
Update UEFI BIOS	48
Cloud bare metal recovery (for selected models)	49
Install a Windows operating system and drivers	49

Chapter 6. CRU replacement 51

CRU list	51
Disable Fast Startup and the built-in battery.	51
Replace a CRU	52
Base cover assembly	52
Wireless WAN card and wireless WAN card bracket (for selected models).	53
2242 M.2 solid-state drive and bracket	56

Chapter 7. Help and support 59

Frequently asked questions	59
Diagnose and troubleshoot your computer	60
Hardware scan	60
UEFI Diagnostics tool.	61
Error messages	62
Battery-charge LED indicator diagnosis	62
Self-help resources	65
Windows label	66
Call Lenovo	66
Before you contact Lenovo	66
Lenovo Customer Support Center	67

Purchase additional services. 68

**Appendix A. Compliance
information. 69**

**Appendix B. Notices and
trademarks. 73**

Discover your Lenovo notebook

Thank you for choosing a Lenovo® notebook! We are dedicated to delivering the best solution to you.

Before starting your tour, please read the following information:







- Illustrations in this documentation might look different from your product.
- Depending on the model, some optional accessories, features, software programs, and user interface instructions might not be applicable to your computer.
- Documentation content is subject to change without notice. To get the latest documentation, go to <https://pcsupport.lenovo.com>.



Chapter 1. Meet your computer

Front view

ThinkPad X1 Carbon Gen 12



Item	Description	Item	Description
	Microphone		Infrared camera / Camera
	Webcam privacy shutter		Touch screen
	TrackPoint® pointing stick		Fingerprint reader

Item	Description	Item	Description
	NFC (near field communication) mark		Trackpad / Haptic Touchpad
	TrackPoint buttons		

* for selected models

Note: Depending on models, your computer comes with either a Trackpad or a Haptic Touchpad. NFC function is only for selected models with trackpad.



Webcam privacy shutter







Slide the webcam privacy shutter to cover or uncover the camera lens. It is designed to protect your privacy.

Related topics

- “Use the TrackPoint pointing device” on page 13
- “Use the Haptic Touchpad / trackpad” on page 15
- “Use the touch screen (for selected models)” on page 19
- “User Presence Sensing (for selected models)” on page 38
- “Lock on leave function (for selected models only)” on page 40
- “Set up an NFC connection” on page 34
- “Log in with your fingerprint” on page 37
- “Log in with your face ID (for selected models)” on page 38
- “Protect your privacy (for selected models)” on page 40

ThinkPad X1 2-in-1 Gen 9



Item	Description	Item	Description
	Microphone		Infrared camera / Camera
	Webcam privacy shutter		Touch screen
	TrackPoint® pointing stick		Fingerprint reader
	Trackpad / Haptic Touchpad		

* for selected models

Note: Depending on models, your computer comes with either a Trackpad or a Haptic Touchpad. NFC function is for selected models with trackpad.



Webcam privacy shutter





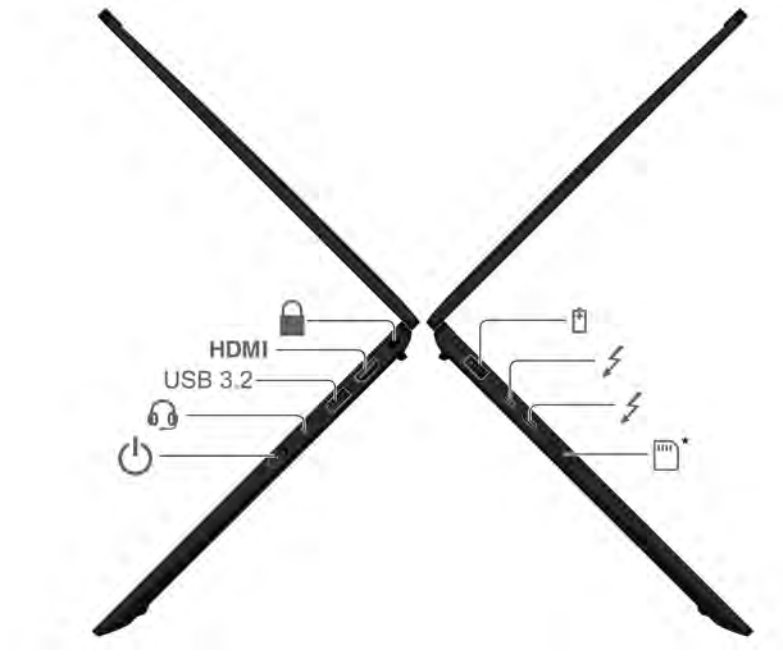

Slide the webcam privacy shutter to cover or uncover the camera lens. It is designed to protect your privacy.

Related topics

- “Use the TrackPoint pointing device” on page 13
- “Use the Haptic Touchpad / trackpad” on page 15
- “Use the touch screen (for selected models)” on page 19
- “User Presence Sensing (for selected models)” on page 38
- “Lock on leave function (for selected models only)” on page 40
- “Log in with your fingerprint” on page 37
- “Log in with your face ID (for selected models)” on page 38
- “Protect your privacy (for selected models)” on page 40

Side view



Item	Description	Item	Description
	USB-A connector (USB 5Gbps, Always On USB)		USB-C® connector (Thunderbolt™ 4)
	Nano-SIM-card tray		Power button
	Audio connector	USB 3.2	USB-A connector (USB 5Gbps)
HDMI	HDMI™ connector		Security-lock slot

Note: The Ethernet extension connector Gen 2 and the adjoining USB-C (Thunderbolt 4) connector cannot be used simultaneously.

Statement on USB transfer rate

Depending on many factors such as the processing capability of the host and peripheral devices, file attributes, and other factors related to system configuration and operating environments, the actual transfer rate using the various USB connectors on this device will vary and will be slower than the data rate listed below for each corresponding device.

USB device	Data rate (Gbit/s)
3.2 Gen 1	5
3.2 Gen 2	10
3.2 Gen 2 × 2	20
4 Gen 2 × 2	20
4 Gen 3 × 2	40

USB device	Data rate (Gbit/s)
Thunderbolt 3	40
Thunderbolt 4	40

Related topics

- “USB specifications” on page 8
- “Access networks” on page 11
- “Connect to an external display” on page 21
- “Charge the computer” on page 32
- “Lock the computer” on page 37

Bottom view



Emergency-reset hole

If the computer stops responding and you cannot turn it off by pressing the power button, reset your computer:

1. Disconnect your computer from ac power.
2. Insert a straightened paper clip into the hole to cut off power supply temporarily.
3. Connect your computer to ac power and then turn on your computer.

CAUTION:

When the computer is operating, it should be placed on a hard and flat surface with its bottom area not in contact with user's bare skin. Under normal operating conditions, the temperature of the bottom surface will remain within an acceptable range as defined in IEC 62368-1, but such temperatures can still be high enough to cause discomfort or harm to the user if directly touched for over one minute at a time. As such, it is recommended that users avoid prolonged direct contact with the bottom of the computer.

Note: Some Lenovo computers include a display that can be rotated 360 degrees. When those products are used as a tablet computer, the temperatures of all the accessible parts are within an acceptable range as defined in IEC 62368-1.

Features and specifications

Specification	Description
Memory	Low Power Double Data Rate 5 (LPDDR5), soldered on board, up to 64 GB
Storage device	One slot, 2280 M.2 solid-state drive, up to 2 TB Note: In case of M.2 SSD replacement, your computer only supports single-sided M.2 SSD. Double-sided M.2 SSD is not applicable due to the height limitation of the slot.
Audio	<ul style="list-style-type: none">• Dolby Atmos®• Dolby Voice®
Display	<ul style="list-style-type: none">• 120 Hz refresh rate OLED display*• Color display with In-Plane Switching (IPS) technology• Display ratio: 16:10• Display resolution: 2880 x 1800 pixels or 1920 x 1200 pixels• Multi-touch technology*• Eye Comfort certified*• Dolby Vision®
Security features	<ul style="list-style-type: none">• Face authentication*• User Presence Sensing*• Human presence detection*• Fingerprint reader*• Lenovo View Privacy Guard*• Lenovo View Privacy Alert*• ePrivacy panel*• Trusted Platform Module (TPM) 2.0*
Wireless features	<ul style="list-style-type: none">• Bluetooth• NFC*• GPS (on wireless WAN model)*• Wireless LAN• Wireless WAN (4G or 5G)* <p>Note: The 4G or 5G cellular service is provided by authorized mobile service carriers in some countries or regions. You must have a cellular plan from a service carrier to connect to the cellular network. The cellular data plan might vary by location.</p>



* for selected models

USB specifications

Notes:

- Depending on the model, some USB connectors might not be available on your computer.
- On very rare occasions, the USB-C compatible devices connected to the USB-C connector might interfere with the wireless features. If your computer cannot be connected to Wi-Fi or cellular network, or if

your location cannot be pinpointed through the GPS function, detach the USB-C compatible devices from the USB-C connector.

Connector name	Description
 <ul style="list-style-type: none">• USB-A 2.0 connector• USB-A 3.2 Gen 1 connector• USB-A 3.2 Gen 2 connector	<p>Connect USB-compatible devices, such as a USB keyboard, USB mouse, USB storage device, or USB printer.</p>
 <ul style="list-style-type: none">• USB-C (3.2 Gen 1) connector• USB-C (3.2 Gen 2) connector• USB-C (Thunderbolt 3) connector• USB-C (Thunderbolt 4) connector• USB-C (USB 4) connector	<ul style="list-style-type: none">• Charge USB-C compatible devices with the output voltage and current of 5 V and 1.5 A.• Connect to an external display:<ul style="list-style-type: none">– USB-C to VGA: up to 1920 x 1200 pixels, 60 Hz– USB-C to DP: up to 5120 x 3200 pixels, 60 Hz• Connect to USB-C accessories to help expand your computer functionality. To purchase USB-C accessories, go to https://www.lenovo.com/accessories.

Chapter 2. Get started with your computer

Access networks

This section helps you connect to a wireless or wired network.

Connect to Wi-Fi networks

Click the network icon  on the bottom right of your display to connect to an available network. Provide required information, if needed.

Note: The wireless LAN module on your computer may support different standards. For some countries or regions, use of 802.11ax may be disabled according to local regulations.

Connect to the wired Ethernet

To connect your computer to a local network, you need a Lenovo USB-C to Ethernet Adapter. Lenovo USB-C to Ethernet Adapter is available as an option and shipped with some computer models. You can purchase one from Lenovo at <https://www.lenovo.com/accessories>.



Connect to a cellular network (for selected models)

To connect a 4G or 5G cellular data network, you must have a wireless wide area network (WWAN) card and a nano-SIM card installed. The nano-SIM card might come with your computer by countries or regions. If no nano-SIM card is shipped, you will need to purchase one from authorized service carriers.

Notes:



- Depending on model, your computer might have no WWAN card installed.
- The 4G or 5G cellular service is provided by authorized mobile service carriers in some countries or regions. You must have a cellular plan from a service carrier to connect to the cellular network. The cellular data plan might vary by location.
- Network connection speeds might also vary by location, environment, network conditions and other factors.

To establish a cellular connection:

1. Turn off the computer.

2. Insert a straightened paper clip into the hole in the nano-SIM-card tray. The tray ejects. Install a nano-SIM card as shown and insert the tray into the nano-SIM card slot. Note the orientation of the card and ensure that it is seated correctly.



3. Turn on the computer.
4. Click the network icon  on the bottom right of your display, and then select the cellular network icon  from the list. Provide required information, if needed.

Turn on the Airplane mode

You may need to turn on the Airplane mode if you board an airplane. When the Airplane mode is on, all wireless features are turned off automatically. Click the network icon  on the bottom right of your display to turn on the Airplane mode.

Note: You can enable Wi-Fi networks in this mode according to your actual needs.

Interact with your computer





Your computer provides you various ways to navigate the screen.







Use the keyboard shortcuts

Keyboard shortcuts are keys or combinations of keys that provide a quick way to perform particular functions. They help you work more efficiently.

The following tables describe the functions of keyboard shortcuts.

FnLock and function keys

Key / Key combination	Function description
	Switch between the special and standard functions of the function keys (F1–F12).
Fn + FnLock	<p>Function keys provide two sets of functions: special function and standard function. Icons on the key denote the special function, such as  and . Characters on the key denote the standard function, such as F1 and F2.</p> <p>LED indicator on Esc key indicates which function of the function keys is enabled:</p> <ul style="list-style-type: none"> • When the indicator is off, the special function is enabled. • When the indicator is on, the standard function is enabled.
	Mute / Unmute sound.
	Decrease volume.
	Increase volume.

Key / Key combination	Function description
	Enable / Disable the microphone.
	Increase screen brightness.
	Decrease screen brightness.
	Select and set up display devices.
Mode	Change performance modes.
PrtSc	Print Screen.
	Open Snipping Tool.
	Open Microsoft® Phone Link.
☆	Open the Vantage app.

Other general keyboard shortcuts

Key combination	Function description
Fn + 	Adjust the keyboard backlight.
Fn + <	Go to beginning.
Fn + >	Go to end.
Fn + Tab	Open Magnifier.
Fn + 4	Enter sleep mode.
Fn + B	Break operation.
Fn + K	Scroll contents.
Fn + P	Pause operation.
Fn + S	Send system request.

* for selected models

You can customize keyboard settings in Vantage app. To customize detailed settings, open the Vantage app, and then click **Device** → **Input & Accessories**.

For more keyboard shortcuts, go to <https://support.lenovo.com/us/en/solutions/windows-support>.

Use the TrackPoint pointing device

The TrackPoint pointing device enables you to perform all the functions of a traditional mouse, such as pointing, clicking, and scrolling.

Use the TrackPoint pointing device

Haptic Touchpad

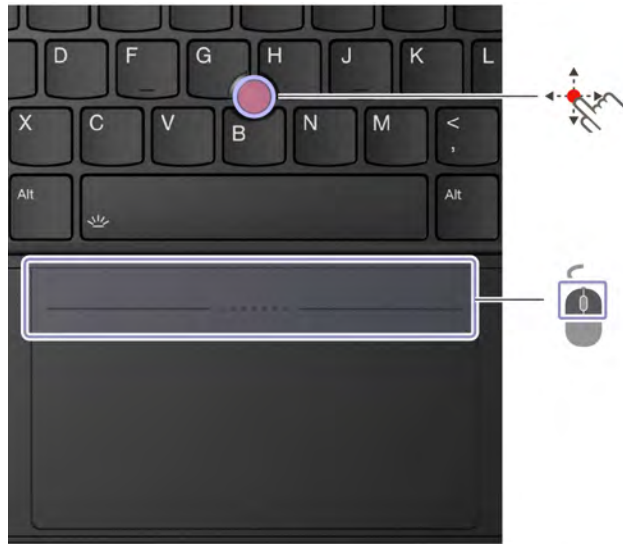

Trackpad

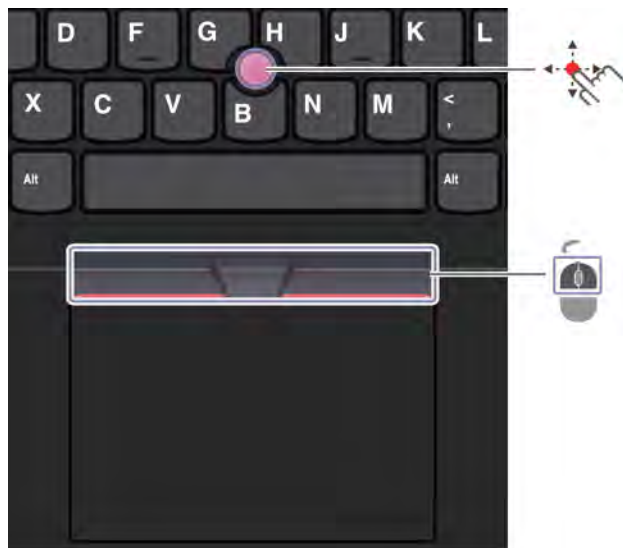

TrackPoint pointing stick

Use your finger to apply pressure to the pointing-stick nonslip cap in any direction parallel to the keyboard. The pointer on the screen moves accordingly. The higher the pressure applied, the faster the pointer moves.



TrackPoint buttons

The left-click button and right-click button correspond to the left and right buttons on a traditional mouse. Press and hold the dotted middle button while using your finger to applying pressure to the pointing stick in the vertical or horizontal direction. Then, you can scroll through the document, Web site, or apps.

Press Ctrl + dotted middle button + TrackPoint pointing stick at the same time to zoom in or zoom out.

Disable the TrackPoint pointing device

The TrackPoint pointing device is active by default. To disable the device:

1. Open the **Start** menu, and then click **Settings → Devices → Mouse**.
2. Follow the on-screen instructions to disable TrackPoint.

Disable the TrackPoint buttons

The TrackPoint buttons are enabled by default. To disable the TrackPoint buttons:

1. Open the **Start** menu, and then click **Settings → Bluetooth & devices → Touchpad**.
2. In the Sensel Haptic Touchpad section, click **Settings**.
3. In the TrackPoint Buttons section, turn off **Use top zone as TrackPoint buttons**.

Replace the pointing-stick nonslip cap

Note: Ensure that the new cap has grooves **a**.

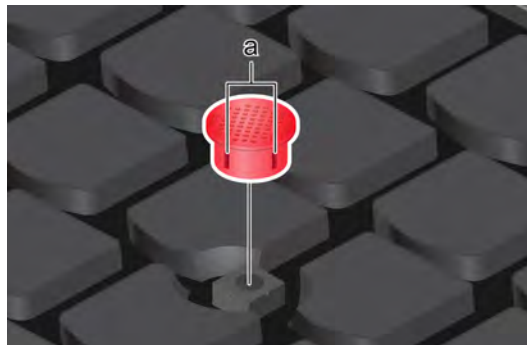

Use the Haptic Touchpad / trackpad

You can use the trackpad to perform all the pointing, clicking, and scrolling functions of a traditional mouse. It is ideal for you to use for occasions with high portability requirements, for example, business trips.

Use the Haptic Touchpad

- When TrackPoint buttons are enabled



- When TrackPoint buttons are disabled



Item	Description	Item	Description
	Left-click zone		Right-click zone

Notes:

- Some gestures are not available in the following cases:
 - if the last action was done from the TrackPoint pointing device.
 - when you are using certain apps.
 - when you are using two or more fingers and your fingers are too close.
- Trackpad might be insensitive in the following cases:
 - when you position your fingers too close to the edge of trackpad .
 - when you touch the trackpad with wet fingers.
 - if the trackpad surface is stained with water or oil. Turn off the computer first. Then, gently wipe the trackpad surface with a soft and lint-free cloth that is moistened with lukewarm water or computer cleaner.

The following tables introduce default trackpad touch gestures.

One and two-finger touch gestures

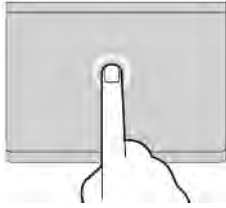
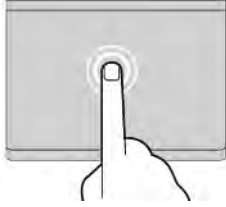
To do this	Gesture
Select an item.	<p>One finger taps once.</p> 
Open an item.	<p>One finger taps twice.</p> 

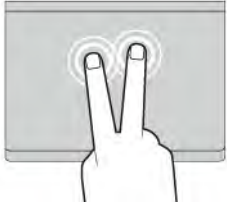
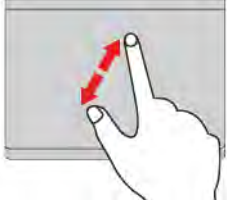
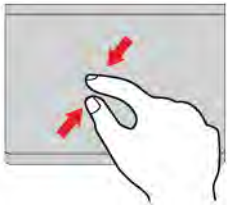
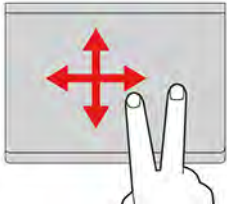
To do this	Gesture
Display a shortcut menu.	<p data-bbox="987 226 1304 258">Two fingers tap twice quickly.</p> 
Zoom in.	<p data-bbox="1019 520 1271 552">Two fingers stretch out.</p> 
Zoom out.	<p data-bbox="1036 814 1255 846">Two fingers pinch in.</p> 
Scroll through items.	<p data-bbox="922 1108 1369 1140">Two fingers slide horizontally or vertically.</p> 

Three- and four-finger touch gestures

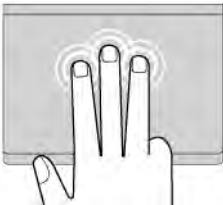
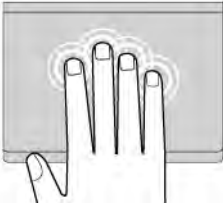
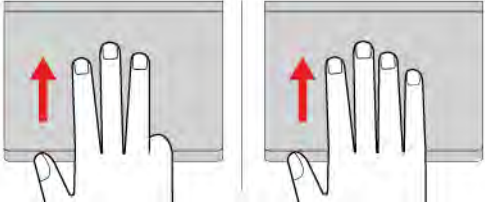
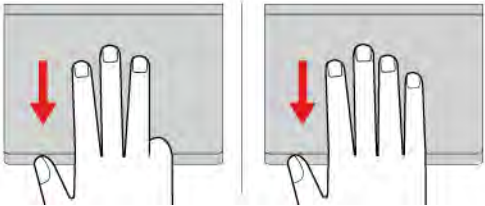
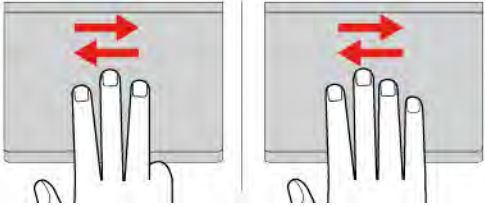
To do this	Gesture
Open search window	Three fingers tap twice. 
Open notification center.	Four fingers tap twice. 
Show all windows.	Three- or four-finger swipes up 
Show the desktop.	Three- or four-finger swipes down. 
Switch between open apps or windows.	Three- or four-finger swipes left or right. 

To change other settings, such as cursor speed, touch gesture, and trackpad sensitivity, do the following:

1. Type touchpad in the Windows search box and then press Enter.
2. Follow the on-screen instructions to change the settings as you prefer.



Use the touch screen (for selected models)

For computers with a touch-enabled screen, you can touch the screen directly with your fingers and interact with computer in a simple way. The following sections introduce frequently used touch gestures.



Notes:

- Some gestures might not be available when you are using certain apps.
- Do not use gloved fingers or incompatible pens for input on the screen. Otherwise, the touch screen might be not sensitive or does not respond.
- The touch screen is delicate. Do not apply pressure on the screen or touch the screen with anything hard or sharp. Otherwise, the touch panel might malfunction or get damaged.

One finger touch gesture

To do this	Gesture
Open a shortcut menu.	Tap and hold. 
Open the widget panel.	Swipe from the left. 
Open notification center.	Swipe from the right. 

Two-finger touch gesture

To do this	Gesture
Zoom out.	Move two fingers towards. 
Zoom in.	Spread two fingers apart. 

Three- and four-finger touch gesture

To enable three- and four-finger touch gestures:

1. Type touch gesture in the Windows search box and then press Enter.
2. Turn on the Three- and four-finger touch gestures switch.

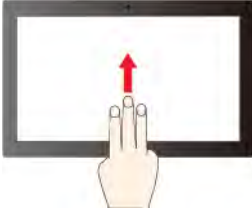
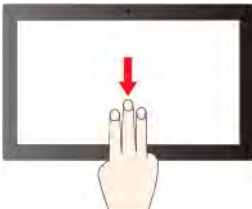
To do this	Gesture
Show all open windows.	Swipe with three fingers up. 
Show the desktop.	Swipe with three fingers down. 

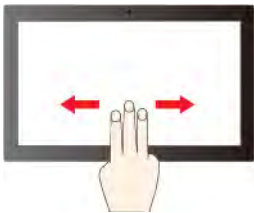
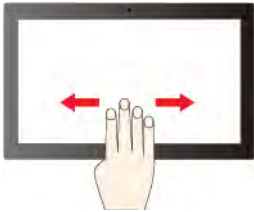
To do this	Gesture
Switch apps.	Swipe with three fingers to the left or right. 
Switch desktops.	Swipe with four fingers to the left or right. 

If the touch screen is not sensitive or does not respond, do the following:

1. Turn off the computer.
2. Use a dry, soft, and lint-free cloth or a piece of absorbent cotton to remove fingerprints or dust from the touch screen. Do not apply solvents to the cloth.
3. Restart the computer and check if the touch screen works normally.
4. If the touch screen cannot work normally, type `Windows Update` in the Windows search box and then press `Enter`.
5. Follow the on-screen instructions to update Windows.
6. After updating Windows, check if the touch screen works normally.
7. If the touch screen still cannot work normally, the touch screen might get damaged. You can call Lenovo Customer Support Center to get further help.

Connect to an external display

Connect your computer to a projector or a monitor to give presentations or expand your workspace.

Connect to a wired display

If your computer cannot detect the external display, right-click a blank area on the desktop and select display settings. Then follow the on-screen instructions to detect the external display.

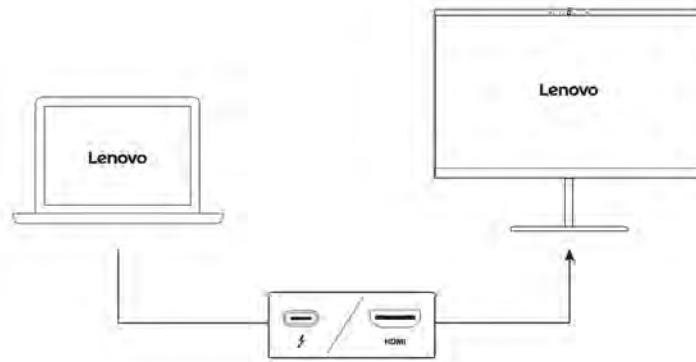

Supported resolution

The following table lists the supported maximum resolution of the external display.

Connect the external display to	Supported resolution
USB-C connector (Thunderbolt 4)	Up to 5K / 60 Hz
HDMI™ connector	Up to 4K / 60 Hz

Note: The refresh rate higher than 60 Hz can also be supported. If you set the refresh rate higher than 60 Hz, the maximum resolution might be limited.

Connect to a wireless display

To use a wireless display, ensure that both your computer and the external display support the Miracast® feature.

Press Windows logo key + K and then select a wireless display to connect with.

Set the display mode

Press F7 or Fn + F7 and then select a display mode of your preference.

Change display settings

1. Right-click a blank area on the desktop and select display settings.
2. Select the display that you want to configure and change display settings of your preference.

You can change the settings for both the computer display and the external display. For example, you can define which one is the main display and which one is the secondary display. You also can change the resolution and orientation.

Get to know convertible multi-modes

The computer display can be opened up to an angle of 360 degrees. Rotate the computer display to switch among different Flex modes for different purposes.

Notes:

- Do not rotate the display with too much force, or apply too much force to the upper-right or upper-left corner of the display. Otherwise, the computer display or hinges might get damaged.

- The keyboard and the pointing device are automatically disabled in the stand mode, tent mode, and tablet mode. Use the touch screen to control your computer instead. The keyboard and the pointing device will be enabled again automatically when you switch from other modes to notebook mode.

Mode	Recommended scenario
------	----------------------

Notebook mode



Enter text.

Use the trackpad and the pointing device.

Stand mode

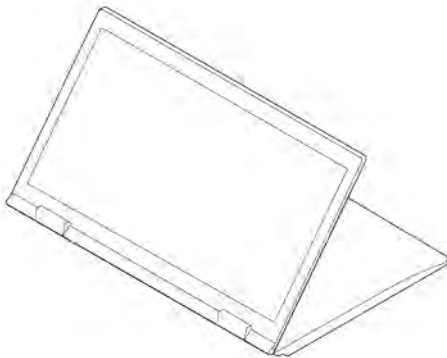

Have a video call.

Give a presentation.

Mode	Recommended scenario
------	----------------------

Tent mode

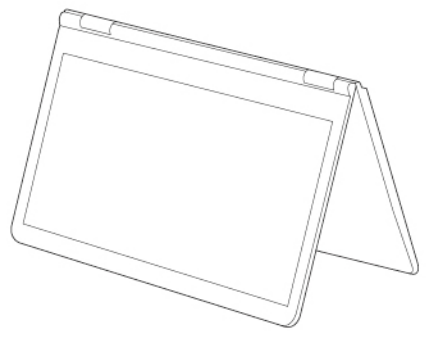

Watch a video.
View a slide show.

Tablet mode

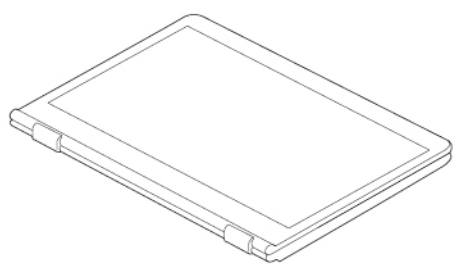



Write and draw.
Play touch-enabled games.

Use Lenovo Slim Pen (for selected models)

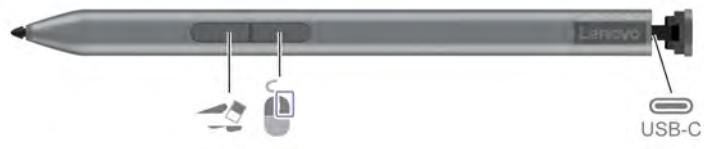
The New Slim Pen (hereafter referred to as the pen) enables a more precise and easier way of writing and sketching. It attaches magnetically to your computer.



Item	Description	Item	Description
	Eraser button		Click button
	USB-C connector		

Notes:

- The default function of each barrel button might vary in different apps.
- To customize the barrel button functions, use Lenovo Pen Settings. You can also check the battery life on your pen in Lenovo Pen Settings. If Lenovo Pen Settings is not installed on your computer, download and install the latest WinTab driver from <https://support.lenovo.com> or from Microsoft Store.
- To purchase the pen, go to <https://www.lenovo.com/accessories>.

Charge the pen

1. Remove the pen cap in the direction as shown.
2. Connect the pen to a charger with a USB-C cable.
3. Install the pen cap back on the pen after charging.

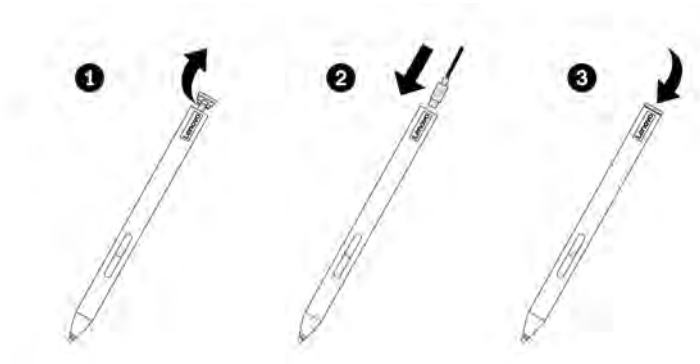

Store the pen

Attach the pen to the magnetic side of your computer. Depending on different scenarios, the pen should be attached to different magnetic sides as shown.

- Attach the pen to the right side of your display for temporal using.
- Attach the pen to the right side of the keyboard for carrying.



Maintenance tips

- Do not attach the pen to other areas on your computer even it can be magnetically attached. Otherwise, the pen and your computer might be broken.
- The pen is not waterproof. Keep the pen away from water and excessive moisture.
- If possible, place your pen in a well-ventilated and dry area without direct exposure to sunshine.
- Do not use or store the pen in a place where excessive changes in temperature might occur such as in a car.
- The pen contains pressure sensors. Apply an appropriate amount of pressure when writing on the screen. Do not subject the pen to shock or vibration.

Chapter 3. Explore your computer

Lenovo apps

This section provides introduction to Lenovo apps.

Lenovo Commercial Vantage

The Lenovo Commercial Vantage app (hereafter referred to as Vantage app) is a customized one-stop solution to help you maintain your computer with automated updates and fixes, configure hardware settings, and get personalized support.

To access the Vantage app, type *Lenovo Commercial Vantage* in the Windows search box.

Notes:

- The available features vary depending on the computer model.
- The Vantage app makes periodic updates of the features to keep improving your experience with your computer. The description of features might be different from that on your actual user interface. Ensure that you use the latest version of Vantage app, and apply Windows Update to get the latest updates.

The Vantage app enables you to:

- Know the device status easily and customize device settings.
- Download and install UEFI BIOS, firmware, and driver updates to keep your computer up-to-date.
- Monitor your computer health, and secure your computer against outside threats.
- Scan your computer hardware and diagnose hardware problems.
- Look up warranty status (online).
- Access *User Guide* and helpful articles.
- Temporarily disable the keyboard, screen, trackpad, and TrackPoint pointing device for cleaning.

Lenovo View

Lenovo View is an app that enhances camera quality and provides collaboration features for some mainstream video call apps.

Access Lenovo View

Type *Lenovo View* in the Windows search box and then press Enter.

Explore key features

- **Video Enhancer:** Adjust relevant camera parameters (light, intensity, color) and reduce noise to improve your video call experience. The low-light enhancer feature can help you improve image quality and brightness in low light environments.



- **Collaboration**

- **Background Removal:** Conceal the background during a video call to keep the focus on you.



- **Auto-framing:** Automatically keep your face centered in the video call when you move around.



- **Virtual presenter:** Overlay your face on any materials you want to present like a presentation.



- **Privacy**

- **Privacy Alert:** An alert icon appears on your computer screen when a shoulder surfer appears behind you.



- **Privacy Guard:** Your screen becomes blurred when a shoulder surfer appears behind you. Press Alt +F2 to cancel the blur effect.

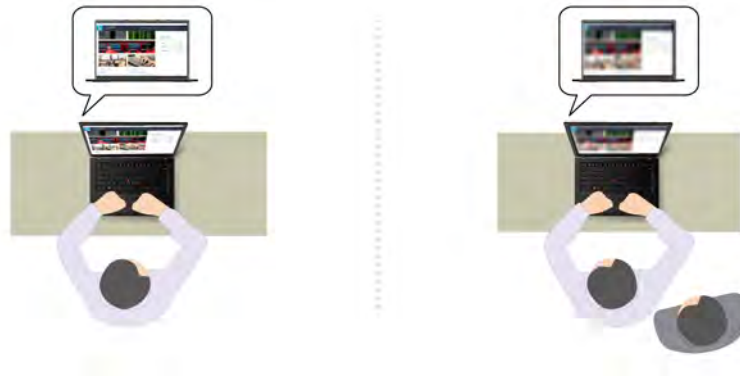

- **Wellness**

- **Posture Warning:** Remind you to adjust your posture when you hunch toward the screen.
- **Eye Wellness:** Remind you to look away from the screen and relax your eyes for 20 seconds every 20 minutes.

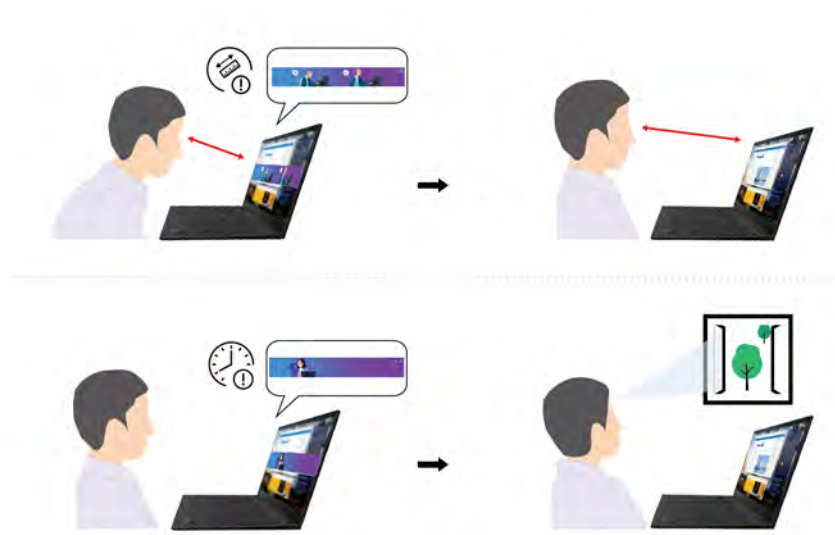

Notes:

- The available features vary depending on the computer model.
- The features only work when camera shutter is open.
- Some features might not be able to be used at the same time.
- The Lenovo View app periodically updates features to improve your camera and video call experience. The feature description might be different from that on your actual user interface.

TrackPoint Quick Menu

Launch the TrackPoint Quick Menu

Double-tap the TrackPoint pointing stick to launch the TrackPoint Quick Menu. You can also set single-tapping as the way to launch in OS settings. To change the settings, do the following:

1. Click the flyout ⓘ and select **ADVANCED SETTINGS**.
2. Enable **Single-tapping launch** in **elan** setting page.

The TrackPoint Quick Menu is enabled by default. Press Fn+G to disable or enable the double-tapping gesture. When disabled, it cannot be launched by double-tapping or single-tapping the TrackPoint pointing stick.



Use the TrackPoint Quick Menu

You can click the edit button  to rearrange the features in the preview panel, or drag and drop the features on the right to the preview panel to customize your quick menu.

- **Camera**

You can adjust the brightness and contrast of the camera, and restore the settings to default by tapping the reset button .

- **Microphone**

You can mute your computer, and adjust the sound effect of your microphone by selecting the following modes:

- Center mode: Capture the speaker's voice.
- Spatial mode: Capture the speaker's voice and the ambience.

Note: When internal microphone is not supported by Dolby or the Dolby driver is disabled, an input device list will be displayed instead. The list provides options and one volume bar to test your microphone.

- **Voice typing**

You can convert the speech to text in the text box. Click **START VOICE TYPING** to invoke the text box.

- **Battery**

You can extend the battery life by setting the charging threshold below 100%.

To set the threshold, enable the feature and click **ADJUST THRESHOLD**. Then set the charge threshold in the Vantage app.

- **Audio playback**

You can select the output device of your preference and set the volume of your selected channel or mute it.

- **Noise suppression**

You can suppress your own background noise and the noise from other meeting participants.

- Off: Disable noise suppression.

- Low: Suppress low-level background noise.
- High: Suppress all non-speech background noise.

Note: The feature does not work when Dolby Voice is off. Click the link in NOISE SUPPRESSION to help you enable it.

- **Enable Haptic Touchpad button area**

You can enable or disable the TrackPoint buttons. When the Haptic Touchpad button area is enabled, it works as the TrackPoint buttons corresponding to the left and right buttons on a traditional mouse. When the Haptic Touchpad button area is disabled, it becomes part of the Haptic Touchpad. You can also click **ADVANCED SETTINGS** to enter OS settings to customize your TrackPoint features.

- **Quick Clean**

You can temporarily disable the keyboard, screen, trackpad, and TrackPoint pointing device to clean your computer.

Notes:

- The features may vary due to periodic updates. For details of the version installed on your computer, click the flyout ⓘ at the top-right corner of the page and click **LEARN MORE**.

Intelligent Cooling

The Intelligent Cooling feature helps you adjust power consumption, fan speed, computer temperature, and performance.

Notes: If you reinstall a Windows operating system, the default intelligent cooling settings might be various. It is recommended that you download and install the latest Intelligent Thermal Solution (ITS) driver. To download the ITS driver, do the following:

1. Go to <https://pcsupport.lenovo.com>.
2. Type Intelligent Thermal Solution driver in the search box and then press Enter.
3. Select the latest driver and then follow the on-screen instruction to download driver.

You can press F8 or do the following to switch among preferred modes:

1. Right-click the battery icon in the task bar to access power and sleep settings.
2. Locate the Power section and select a preferred mode.

Mode	Recommended scenario
Best power efficiency	<ul style="list-style-type: none"> • You want the computer to be quieter and cooler.
Balanced	<ul style="list-style-type: none"> • You plan to frequently switch between different computer tasks over a period time.
Best performance	<ul style="list-style-type: none"> • You want the computer to achieve the best performance. • Louder fan noise and higher temperature are acceptable to you. <p>Note: Avoid keeping your hands, your lap, or any other part of your body in contact with a hot section of the computer for 10 seconds or longer.</p>

Note: Balanced mode is the default setting in both ac and dc power mode.

Manage power

Use the information in this section to achieve the best balance between performance and power efficiency.

Check the battery status

Go to **Settings** → **System** to check the battery status. For more details about your battery, refer to the Vantage app.

Charge the computer

Use ac power

Power source of the ac power adapter:

- Power: 45 W or 65 W
- Sine-wave input at 50 Hz to 60 Hz
- Input rating of the ac power adapter: 100 V to 240 V ac, 50 Hz to 60 Hz
- Output rating of the ac power adapter: 20 V dc, 2.25 A or 3.25 A

When the battery power is low, charge your battery by connecting your computer to ac power with the supplied power adapter. The 65 W ac power adapter supports the rapid charge function, the battery is 80% charged in about one hour when the computer is turned off. The actual charging time depends on the battery size, the physical environment, and whether you are using the computer.

Battery charging is also affected by its temperature. The recommended temperature range for charging the battery is between 10°C (50°F) and 35°C (95°F).

Note: Some models may not ship with ac adapters or power cords. Use only the certified adapters and power cords provided by Lenovo that comply with the requirements of relevant national standards to charge the product. It is recommended to use the Lenovo qualified adapters. You can refer to <https://www.lenovo.com/us/en/compliance/eu-doc>.



Notes: To maximize the life of the battery:

- Use the battery until the charge is depleted and recharge the battery completely before using it. Once the battery is fully charged, it must discharge to 94% or lower before it will be allowed to recharge again.
- Keep the battery from full charge when it is not in heavy use. For more information, refer to the **Battery settings** tab in the power section of the Vantage app.
- The battery may optimize its full charge capacity based on your usage. After prolonged periods of limited use, full battery capacity may not be available until you discharge to as low as 20% and recharge completely. For more information, refer to the power section of the Vantage app.

Use P-to-P 2.0 (Peer to Peer 2.0) charging function

Both USB-C (Thunderbolt 3) connectors on the computer feature the Lenovo-unique P-to-P 2.0 charging function. To use the function, ensure that **Always On USB** and **Charge in Battery Mode** are enabled in UEFI BIOS of your computers, so that the function works even when the computers are off or in hibernation mode.

To enable **Always On USB** and **Charge in Battery Mode**:

1. Press F1 to enter the UEFI BIOS menu.
2. Click **Config** → **USB**, and then to enable **Always On USB** and **Charge in Battery Mode**.

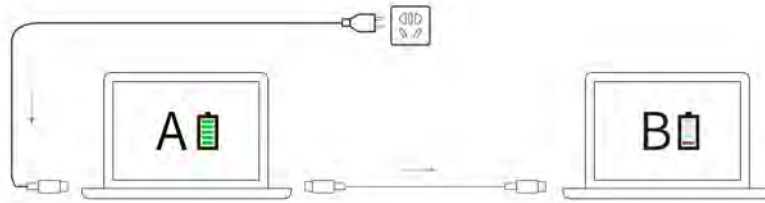

Note: The actual charging speed of your computer depends on many factors, such as the remaining battery power of the computers, the wattage of the ac power adapter, and whether you are using the computers.

Change the power settings

For ENERGY STAR® compliant computers, the following power plan takes effect by default when your computer is on ac power and has been idle for a specified duration:

For models with Windows 10

- Turn off the display: After 10 minutes
- Put the computer to sleep: After 10 minutes

For models with Windows 11

- Turn off the display: After 5 minutes
- Put the computer to sleep: After 5 minutes

To reset the power plan:

1. Go to **Control Panel** and view by Large icons or Small icons.
2. Click **Power Options**.
3. Choose or customize a power plan of your preference.

To reset the power button function:

1. Go to **Control Panel** and view by Large icons or Small icons.
2. Click **Power Options**, and then click **Choose what the power buttons do** on the left pane.
3. Change the settings as you prefer.

Enable Flip to Start

Your computer supports Flip to Start feature. It is disabled by default. If you enable this feature, the computer will start up automatically without pressing power on button when you open the lid.

To enable Flip to Start feature:

1. Open the Vantage app, and then click **Device → Power → Power settings**.
2. Turn on the **Flip to start** toggle to enable the feature.

If the Vantage app is uninstalled, you can enable this feature in UEFI BIOS menu:

1. Restart the computer. When the logo is displayed, press F1 to enter the UEFI BIOS menu.
2. Select **Config → Power**.
3. Turn on the **Flip to start** toggle to enable the feature.

Transfer data

Quickly share your files using the built-in Bluetooth or NFC technology among devices with the same features.

Connect to a Bluetooth device

You can connect all types of Bluetooth-enabled devices to your computer, such as a keyboard, a mouse, a smartphone, or speakers. To ensure successful connection, place the devices at most 10 meters (33 feet) from the computer.

Set up an NFC connection

If your computer supports NFC, you will see an NFC mark or label  around the trackpad area.

To turn on NFC:

1. Type **Airplane mode** in the Windows search box and then press Enter.
2. Ensure that the Airplane mode is off and turn on the NFC function.

By using NFC, you can simply tap and connect your computer and another NFC-enabled device over a few centimeters or inches. To pair with an NFC card or smartphone:

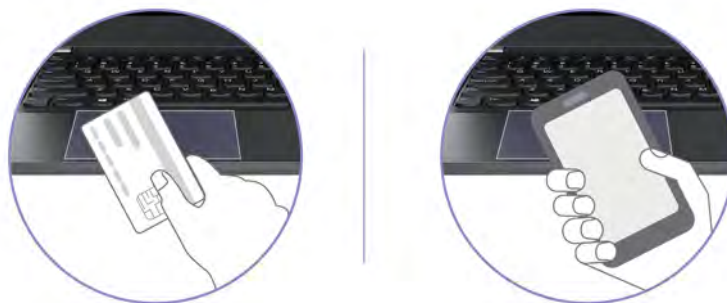

Note: Ensure that the NFC card is in NFC Data Exchange Format (NDEF), otherwise the card cannot be detected.

Accessories

This section provides instructions on how to use hardware accessories to expand your computer functionalities.

Purchase accessories

Lenovo has a number of hardware accessories and upgrades to help expand the functionalities of your computer. Options include memory modules, storage devices, network cards, port replicators or docking stations, batteries, power adapters, keyboards, mice, and more.

To shop at Lenovo, go to <https://www.lenovo.com/accessories>.

Chapter 4. Secure your computer and information

Lock the computer

Lock your computer to a desk, table, or other fixtures through a compatible security cable lock.

Note: The slot supports cable locks that conform to the Kensington NanoSaver® lock standards using Cleat™ locking technology. You are responsible for evaluating, selecting, and implementing the locking device and security feature. Lenovo is not responsible for the locking device and security feature. You can purchase the cable locks at <https://smartfind.lenovo.com>.



Log in with your fingerprint

Enroll your fingerprints and unlock computer by scanning your fingerprints on the fingerprint reader key.

1. Type Sign-in options in the Windows search box and then press Enter.
2. Select the fingerprint setting and then follow the on-screen instruction to enroll your fingerprint.

Note: It is recommended that you put your finger at the center of the power button during enrollment and enroll more than one fingerprint in case of any injuries to your fingers. After the enrollment, the fingerprints are associated with the Windows password automatically.

3. Log in with your fingerprint.



Associate your fingerprints with UEFI BIOS passwords

You can associate your fingerprints with your power-on password and NVMe password. See “Associate your fingerprints with passwords (for selected models)” on page 43.

Maintenance tips:

- Do not scratch the surface of the reader with anything hard or sharp.
- Do not use or touch the reader with a wet, dirty, wrinkled, or injured finger.

Log in with your face ID (for selected models)

For models come with a webcam privacy shutter, slide the webcam privacy shutter to uncover the camera lens before using the Windows Hello face recognition.

Create your face ID and unlock your computer by scanning your face:

1. Type Sign-in options in the Windows search box and then press Enter.
2. Select the face ID setting and then follow the on-screen instruction to create your face ID.

User Presence Sensing (for selected models)

Your computer with 4K camera might support User Presence Sensing feature. This feature offers smarter privacy protection, simpler login convenience, and better energy management for your computer. You can customize this feature in the Vantage app.

Note: Before using this feature, ensure you create your Face ID with the IR camera.

1. Open the Vantage app, and then click **Device** → **Smart Assist**.
2. Turn on the **User Presence Sensing** toggle to enable the feature.
3. Customize the sub-features such as **Zero Touch Login**, **Zero Touch Lock** and **Adaptive Dimming** according to your preference.

When using this feature, it provides the following functions:

- **Face Sensing:** Wake your computer from sleep mode without touching when you has enrolled Face ID.

- **Zero Touch Login:** Wake your computer from sleep mode. With Windows Hello Facial Recognition, you can log in without touching your computer.



Note: When **Face Sensing** is enabled, only users who has enrolled Face ID can wake the computer up.



- **Zero Touch Lock:** Lock your computer screen automatically whenever you step away.



- **Adaptive Dimming:** Track your face movement to recognize your attention focus. When you are facing away, the display will dim to save battery power.



Notes:

- The feature does not work in the following cases:
 - the computer is in tent, tablet, or stand mode.
 - the computer is in hibernation mode or has been turned off.
 - the computer display or camera shutter is closed.
 - you set the power options to never turn off the display **in the OS settings**.
- The feature might not work properly in the following cases:
 - when used in bright back light or very dark environment.
 - when your face is partially hidden by your clothing or mask.

- when the camera recognizes a face image behind you like a poster or picture.
- For some countries or regions, this feature might be disabled according to local regulations.

Lock on leave function (for selected models only)

Your computer with FHD camera supports the lock on leave function with ultrasound-based human presence detection. The computer display will first dim and then lock when it senses you have walked away. This provides added security and improves battery life.



Lock on leave function is enabled by default. To change the settings:



1. Open the Vantage app, and then click **Device** → **Smart Assist**.
2. Slide the **Zero Touch Lock** switch to disable or enable the function.

Notes:

- The lock on leave function does not work if you set the power options to never turn off the display in the OS settings.
- If the Vantage app is uninstalled, this function will be enabled automatically. You can change the settings through the UEFI BIOS menu:
 1. Restart the computer. When the logo is displayed, press F1 to enter the UEFI BIOS menu.
 2. Select **Security** → **Intelligent Security**.
 3. Slide the **User Presence Sensing** switch to disable or enable the function.
- For some countries or regions, the lock on leave function might be disabled according to local regulations.

Protect your privacy (for selected models)

Use the ePrivacy screen

Your computer might come with an ePrivacy screen. It can reduce screen visibility from side angles to protect screen content against visual hacking. By default, this function is disabled. You can press F12 or Fn +D to enable it. You will be prompted by the on-screen icon  or  every time the function is enabled or disabled.

Your ePrivacy screen can be automatically enabled in case that you are required to input passwords. By default, this automatic function for passwords is disabled. You can enable it on the Vantage app.

Set the privacy level

The privacy level of this function varies depending on the screen brightness level, the contrast ratio, and the physical environment where you are using this function.

- Press F5 to increase the privacy level.
- Press F6 to decrease the privacy level.

Protect data against power loss (for selected models)

NVMe (Non-Volatile Memory express) M.2 solid-state drive features the Lenovo-unique PLP (Power Loss Protection) function to avoid data loss or damage. If your computer is not responding and you might have to shut down your computer by pressing and holding the power button for several seconds. In this case, the PLP function enables your computer data to be saved timely. However, there is no guarantee that all data is saved in any situation. To check the type of your M.2 solid-state drive:

1. Restart the computer. When the logo screen is displayed, press F10 to enter the Lenovo diagnostics window.
2. On the TOOLS tab, select **SYSTEM INFORMATION → STORAGE** using the arrow keys.
3. Locate the **Device Type** section to check the information.

UEFI BIOS passwords

You can set passwords in UEFI (Unified Extensible Firmware Interface) BIOS (Basic Input/Output System) to strengthen the security of your computer.

Password types

You can set a power-on password, supervisor password, system management password, or NVMe password in UEFI BIOS to prevent unauthorized access to your computer. However, you are not prompted to enter any UEFI BIOS password when your computer resumes from sleep mode.

Power-on password

If you set a power-on password, a window is displayed on the screen when you turn on the computer. Enter the correct password to use the computer.

Supervisor password

The supervisor password protects the system information stored in UEFI BIOS. When entering the UEFI BIOS menu, enter the correct supervisor password in the window prompted. You also can press Enter to skip the password prompt. However, you cannot change most of the system configuration options in UEFI BIOS.

If you have set both the supervisor password and power-on password, you can use the supervisor password to access your computer when you turn it on. The supervisor password overrides the power-on password.

System management password

The system management password can also protect the system information stored in UEFI BIOS like a supervisor password, but it has lower authority by default. The system management password can be set through the UEFI BIOS menu or through Windows Management Instrumentation (WMI) with the Lenovo client-management interface.

You can enable the system management password to have the same authority as the supervisor password to control security-related features. To customize the authority of the system management password through the UEFI BIOS menu:

1. Restart the computer. When the logo screen is displayed, press F1 to enter the UEFI BIOS menu.
2. Select **Security → Password → System Management Password Access Control**.
3. Follow the on-screen instructions.

If you have set both the supervisor password and the system management password, the supervisor password overrides the system management password. If you have set both the system management

password and the power-on password, the system management password overrides the power-on password.

NVMe passwords

The NVMe password prevents unauthorized access to the data on the storage drive. When an NVMe password is set, you are prompted to type a correct password each time you try to access the storage drive.

- **Single Password**

When a Single NVMe password is set, the user must enter the user NVMe password to access files and applications on the storage drive.

- **Dual Password (User + Admin)**

The admin NVMe password is set and used by a system administrator. It enables the administrator to access any storage drive in a system or any computer connected in the same network. The administrator can also assign a user NVMe password for each computer in the network. The user of the computer can change the user NVMe password as desired, but only the administrator can remove the user NVMe password.

When prompted to enter an NVMe password, press F1 to switch between the admin NVMe password and user NVMe password.

Notes: The NVMe password is not available in the following situations:

- A Trusted Computing Group (TCG) Opal-compliant storage drive and a TCG Opal management software program are installed in the computer, and the TCG Opal management software program is activated.
- An eDrive storage drive is installed in the computer preinstalled with the Windows operating system.

Set, change, and remove a password

Before you start, print these instructions.

1. Restart the computer. When the logo screen is displayed, press F1 to enter the UEFI BIOS menu.
2. Select **Security → Password** by using the arrow keys.
3. Select the password type. Then, follow the on-screen instructions to set, change, or remove a password.

You should record all your passwords and store them in a safe place. If you forget any of your passwords, any potential repair actions required are not covered under warranty.

What to do if you forget your power-on password

If you forget your power-on password, do the following to remove the power-on password:

- If you have set a supervisor password and remember it:
 1. Restart the computer. When the logo screen is displayed, immediately press F1.
 2. Type the supervisor password to enter the UEFI BIOS menu.
 3. Select **Security → Password → Power-On Password** by using the arrow keys.
 4. Type the current supervisor password in the **Enter Current Password** field. Then, leave the **Enter New Password** field blank, and press Enter twice.
 5. In the Changes have been saved window, press Enter.
 6. Press F10 to save changes and exit the UEFI BIOS menu.
- If you have not set a supervisor password, contact a Lenovo authorized service provider to have the power-on password removed.

What to do if you forget your NVMe password

If you forget your NVMe password (Single password) or both user and admin NVMe passwords (Dual password), Lenovo cannot reset your passwords or recover data from the storage drive. You can contact a Lenovo authorized service provider to have the storage drive replaced. A fee will be charged for parts and service. If the storage drive is a CRU (Customer Replaceable Unit), you can also contact Lenovo to purchase a new storage drive to replace the old one by yourself. To check whether the storage drive is a CRU and the relevant replacement procedure, see Chapter 6 “CRU replacement” on page 51.

What to do if you forget your supervisor password

If you forget your supervisor password, there is no service procedure to remove the password. You have to contact a Lenovo authorized service provider to have the system board replaced. A fee will be charged for parts and service.

What to do if you forget your system management password

If you forget your system management password, do the following to remove the system management password:

- If you have set a supervisor password and remember it:
 1. Restart the computer. When the logo screen is displayed, immediately press F1.
 2. Type the supervisor password to enter the UEFI BIOS menu.
 3. Select **Security** → **Password** → **System Management Password** by using the arrow keys.
 4. Type the current supervisor password in the **Enter Current Password** field. Then, leave the **Enter New Password** field blank, and press Enter twice.
 5. In the Changes have been saved window, press Enter.
 6. Press F10 to save changes and exit the UEFI BIOS menu.
- If you have not set a supervisor password, contact a Lenovo authorized service provider to have the system management password removed.

Associate your fingerprints with passwords (for selected models)

Do the following to associate your fingerprints with the power-on password and NVMe password:

1. Turn off and then turn on the computer.
2. When prompted, scan your finger on the fingerprint reader.
3. Enter your power-on password, NVMe password, or both as required. The association is established.

When you start the computer again, you can use your fingerprints to log in to the computer without entering your Windows password, power-on password, or NVMe password. To change settings, press F1 to enter the UEFI BIOS menu, and then select **Security** → **Fingerprint**.

Attention: If you always use your fingerprint to log in to the computer, you might forget your passwords. Write down your passwords, and keep them in a safe place.

FIDO (Fast Identity Online) authentication

Your computer supports FIDO (Fast Identity Online) authentication feature. This feature works as an alternative to password-based authentication to achieve passwordless authentication. This feature only works when a power-on password is set in UEFI BIOS and the FIDO2 USB device is registered in ThinkShield™ Passwordless Power-On Device Manager. With this feature, you can input the power-on password or use the registered FIDO2 USB device to power on your computer.

Register your FIDO2 USB device in ThinkShield Passwordless Power-On Device Manager

1. Turn on the computer.
2. Press F12 during the power-on process.
3. If you set a power-on password, you are prompted to enter the correct password.
4. Select **App Menu → ThinkShield Passwordless Power-On Device Manager** and press Enter.
5. Insert the FIDO2 USB device to register the device by following steps:
 - a. Select the available FIDO2 USB device that you want to register in the **Discovered Devices** field.
 - b. Click **Yes** in the displayed window to confirm the device you selected.
 - c. If you set a power-on password, you are prompted to enter the correct password.
 - d. The **User operation request** window is displayed. You are prompted to press the button on the connected FIDO2 USB device, and then follow the on-screen instruction to close the window.
 - e. Press Esc to exit and restart your computer.

Notes:

- If you want to unregister your devices, click the available FIDO2 USB device that you want to unregister in the **My Device** field and enter the correct power-on password for verification.
- If you use more than one FIDO2 USB device with a common identifier for registration, only one device is available.

Log in to the System with Passwordless Power-On Authentication

1. Restart the computer.
2. **ThinkShield Passwordless Power-On Authentication** window is displayed.
3. Insert your registered FIDO2 USB device for detection.
4. Then follow the on-screen instruction to press the button on your FIDO2 USB device for verification.
5. After your device is verified, the power-on process continues.

Note: You should insert the FIDO2 USB device or enter the power-on password within 60 seconds. Otherwise, your computer will shut down automatically.

Chapter 5. Configure advanced settings

UEFI BIOS

UEFI BIOS is the first program that the computer runs. When the computer turns on, UEFI BIOS performs a self test to make sure that various devices in the computer are functioning.

Enter the UEFI BIOS menu

Restart the computer. When the logo screen is displayed, press F1 to enter the UEFI BIOS menu.

Navigate in the UEFI BIOS interface

You can navigate in the UEFI BIOS interface by pressing the following keys:

- F1: General Help
- F9: Setup Defaults
- F10: Save and Exit
- F5 / F6: Change boot priority order
- ↑ ↓ or PgUp / PgDn: Select / Scroll page
- ← →: Move keyboard focus
- Esc: Back / Close dialog
- Enter: Select / Open submenu

Set the system date and time

1. Restart the computer. When the logo screen is displayed, press F1.
2. Select **Date/Time** and set the system date and time as desired.
3. Press F10 to save changes and exit.

Change the startup sequence

1. Restart the computer. When the logo screen is displayed, press F1.
2. Select **Startup → Boot**. Then, press Enter. The default device order list is displayed.

Note: No bootable device is displayed if the computer cannot start from any devices or the operating system cannot be found.

3. Set the startup sequence as desired.
4. Press F10 to save the changes and exit.

To change the startup sequence temporarily:

1. Restart the computer. When the logo screen is displayed, press F12.
2. Select the device that you want the computer to start from and press Enter.

View UEFI BIOS Event logs

The UEFI BIOS Event log viewer provides the brief information about UEFI BIOS events. Do the following to view the logs:

1. Restart the computer. When the logo screen is displayed, press F1.

2. Select **Main → BIOS Event log**. Then, press Enter. The UEFI BIOS Event log interface is displayed.
3. Navigate the interface by pressing the following keys, and then check details by selecting each item.
 - ↑↓: Move keyboard focus
 - PgUp / PgDn: Scroll page
 - Enter: Select
 - F3: Exit

The following UEFI BIOS event logs might be listed on your screen depending on UEFI BIOS activities. Each log consists of a date, a time, and a description of the event.

- **Power On** event: This log shows the Power On Self Test (POST) routine has started with the power-on process. It includes the power-on reason, the boot mode, and the shutdown reason.
- **Subcomponent Code Measurement** event: This log shows the subcomponent code measurement has worked. It includes the validation result of each component.
- **System Preboot Authentication** event: This log shows what credential is provided to gain preboot authentication. It includes the installed password, the password type, the input device, and the authentication result.
- **BIOS Password Change** event: This log shows the change history of the UEFI BIOS passwords. It includes the password type, the type and result of the event.
- **Subcomponent Self-healing** event: This log shows the information about the subcomponent where the recovery event occurred. It includes the cause and result of the event, and the recovered firmware version.
- **BIOS Setup Configuration Change** event: This log shows the change history of the UEFI BIOS Setup configuration. It includes the item name and value.
- **Device Change** event: This log shows the change history of devices. It includes the cause and type of the event.
- **System Boot** event: This log shows which device was utilized to boot the system. It includes the boot option, the description, and the file path list.
- **System Tamper** event: This log shows the occurrence of system tamper events. It includes the cause and type of the event.
- **POST Error** event: This log shows the occurrence of errors during the POST routine. It includes the error code.
- **Flash Update** event: This log shows the occurrence of flash update. It includes the cause and result of the event, and the updated firmware version.
- **Set On-Premise** event: This log shows the change history of on-premise boot settings. It includes the value of on-premise settings and the change method.
- **Capsule Update** event: This log shows the occurrence of UEFI capsule firmware update. It includes the cause and result of the event, and the updated firmware version.
- **Log Cleared** event: This log shows UEFI BIOS event logs are cleared. It includes the cause and result of the event.
- **Shutdown / Reboot** event: This log shows the UEFI BIOS is successfully shut down or the system is rebooted. It includes the cause and type of the event.

Detect memory retraining (for Intel models only)

Memory retraining is a process to initialize the memory module and run diagnostic tests for the memory module in your computer. The memory retraining might occur during POST if any of the following situations is detected:

- Memory module replacement

- Total Memory Encryption setting change in UEFI BIOS
- Memory Reference Code (MRC) change when UEFI BIOS update

When memory retraining occurs, the screen might be blank. You might see the LED indicators on Esc, F1, and F4 blinking sequentially to indicate the progress. Do not press the power button to interrupt the process. Wait a few minutes until the logo screen is displayed.

Customize BIOS Defaults

The feature provides a solution to backup your preferred BIOS Setup settings. It helps you to save the BIOS Setup settings as customized BIOS default settings, load them to current BIOS settings when needed, and reset the settings to Setup Defaults.

Save the customized settings configuration

1. Restart the computer. When the logo screen is displayed, press F1 to enter the UEFI BIOS menu.
2. Select **Restart → Save Custom Defaults**.
3. Click **Yes** to save the settings configuration you customized.

Load the customized settings configuration

1. Restart the computer. When the logo screen is displayed, press F1 to enter the UEFI BIOS menu.
2. Select **Restart → Load Custom Defaults**.
3. Click **Yes** to load the customized settings configuration you saved.

You can also press F9 and click **Custom Defaults** to load the customized settings configuration.

Note: **Load Custom Defaults** is unavailable if no customized BIOS default settings are saved.

Reset the settings configuration to Setup Defaults

1. Restart the computer. When the logo screen is displayed, press F1 to enter the UEFI BIOS menu.
2. Select **Restart → Load Factory Defaults**.
3. Click **Yes** to reset the settings configuration to Setup Defaults.

You can also press F9 and click **Factory Defaults** to reset the settings configuration to Setup Defaults.

Reset system to factory defaults

This feature allows you to reset the UEFI BIOS to the factory default settings, including all UEFI BIOS settings and internal data. It helps you wipe user data in case that you want to dispose of or reuse your computer.

1. Restart the computer. When the logo screen is displayed, press F1 to enter the UEFI BIOS menu.
2. Select **Security → Reset System to Factory Defaults** and press Enter.
3. Several warning windows might be displayed. Do the following before resetting the system to the factory default settings:
 - a. Deactivate the Absolute Persistence Module.
 - b. Remove the NVMe password if you have set one.
4. For computer models with RAID settings, a window is displayed to remind you of data damage. Select **Yes** to proceed.
5. A window is displayed to confirm all UEFI BIOS settings will be reset. Select **Yes** to proceed.

Note: If the **Intel AMT control** and **Absolute Persistence(R) Module** are permanently disabled, these settings cannot be reset successfully.

6. Enter the supervisor password, system management password or power-on password in the window prompted.

Your computer will restart immediately. It takes a few minutes to complete the initialization process. Your computer screen might be blank during this process. This is normal and you should not interrupt it.

Notes: Use ThinkShield Secure Wipe feature for ThinkPad 2019 or later models by following steps:

1. Restart the computer. When the logo screen is displayed, press F12 to enter UEFI BIOS menu.
2. Press tab to switch to **App Menu**.
3. Select **ThinkShield Secure Wipe** from the list.
4. Follow the on-screen instructions to wipe the disk.

Recover the UEFI BIOS

If the UEFI BIOS is corrupted or maliciously attacked, it can self-recover and restore your computer from the last uncorrupted and secure backup. This function protects your computer data.

During the UEFI BIOS self-recovery, the screen might be blank. You can check the progress based on blinking modes of the LED indicators on Esc, F1, and F4. For details, refer to the following table.

Note: Do not press the power button to interrupt the progress. Wait a few minutes until the logo screen is displayed.

Blinking modes	Self-recovery progress
LED indicator on Esc blinks	0% to 32%
LED indicators on Esc and F1 blink simultaneously	33% to 65%
LED indicators on Esc, F1 and F4 blink simultaneously	66% to 100%

Update UEFI BIOS

When you install a new program, device driver, or hardware component, you might need to update UEFI BIOS.

Download and install the latest UEFI BIOS update package by one of the following methods:

- Open the Vantage app to check the available update packages. If the latest UEFI BIOS update package is available, follow the on-screen instructions to download and install the package.
- Go to <https://pcsupport.lenovo.com> and select the entry for your computer. Then, follow the on-screen instructions to download and install the latest UEFI BIOS update package.

Note: During the UEFI BIOS update process, MRC change might cause memory retraining. Memory retraining is a process to initialize the memory module and run diagnostic tests for the memory module in your computer. When memory retraining occurs, the screen might be blank. You might see the LED indicators on Esc, F1, and F4 blinking sequentially to indicate the progress. Do not press the power button to interrupt the process. Wait a few minutes until the logo screen is displayed.

To know more about UEFI BIOS, visit Knowledge Base of your computer at <https://pcsupport.lenovo.com>.

Cloud bare metal recovery (for selected models)

This feature enables you to remove all user files on your computer and restore the Windows operating system from Cloud (Microsoft® Connected System Recovery). Before using this feature, read the following information.

Notes:

- This feature will restore your computer to the Windows operating system preinstalled at the factory. Do not use this feature if a customized operating system is installed on your computer, otherwise the customized functions or applications cannot be restored.
- This feature only works with wired network (connected via the Ethernet connector on your computer) and wireless network (WPA2 personal only).

Do the following to restore the Windows operating system:

1. Restart the computer. When the logo screen is displayed, press F1 to enter the UEFI BIOS menu.
2. Select **Config → Reinstall Windows from Cloud**. Follow the on-screen instructions to enable this feature.
3. Press F10 to save changes and exit.
4. The computer will restart automatically. When the logo screen is displayed, press F12.
5. Select **App Menu → Reinstall Windows from Cloud**, and then follow the on-screen instructions.

If the recovery process fails, you still have other options to restore the Windows operating system. For more information, refer to “Self-help resources” on page 65.

Install a Windows operating system and drivers

This section provides instructions on installing a Windows operating system and device drivers

Install a Windows operating system

Microsoft® constantly makes updates to the Windows operating system. Before installing a particular Windows version, check the compatibility list for the Windows version. For details, go to <https://support.lenovo.com/us/en/solutions/windows-support>.

Attention:

- It is recommended that you update your operating system through official channels. Any unofficial update might cause security risks.
- The process of installing a new operating system deletes all the data on your internal storage drive, including the data stored in a hidden folder.

Notes:

1. For models with a Trusted Platform Module, if you are using the Windows BitLocker® Drive Encryption feature, ensure that you have disabled the feature. You can re-enable the feature after the operating system installation is complete.
2. Ensure that the security-related features (Security Chip, Virtualization, and Secure Boot) are enabled.
To access the security-related features in the UEFI BIOS menu:
 - a. Restart the computer. When the logo screen is displayed, press F1 to enter the UEFI BIOS menu.
 - b. Select **Security** and select the security-related features. Then, press Enter. Ensure that the security-related features are enabled.
 - c. Press F10 to save the settings and exit.

3. Network connection is required to the installation of Windows 11.

Installation procedures

1. Connect the drive that contains the operating system installation program to the computer.
To create the installation media, refer to <https://support.microsoft.com/windows>.
2. Restart the computer. When the logo screen is displayed, press F1 to enter the UEFI BIOS menu.
3. Select **Startup → Boot** to open the **Boot Priority Order** submenu.
4. Change the startup sequence:
 - a. Select the drive that contains the operating system installation program, such as **USB HDD**. Then, press Esc.
 - b. Press F10 to save the setting and exit.

Attention: After you change the startup sequence, ensure that you select the correct device during a copy, save, or format operation. If you select the wrong device, the data on that device might be erased or overwritten.

Note: If the system cannot boot from the selected drive, disable **Secure Boot** and try again. Ensure that you re-enable the feature after the operating system installation is complete.

5. Follow the on-screen instructions to install the device drivers and necessary programs.

Install device drivers

You should download the latest driver for a component when you notice poor performance from that component or when you added a component. This action might eliminate the driver as the potential cause of a problem. Download and install the latest driver by one of the following methods:

- Open the Vantage app to check the available update packages. Select the update packages you want, and then follow the on-screen instructions to download and install the packages.
- Go to <https://pcsupport.lenovo.com> and select the entry for your computer. Then, follow the on-screen instructions to download and install necessary drivers and software.
- Apply Windows Update to get the latest updates, such as the security patches. Then, follow the on-screen instructions to download and install the necessary updates.

Chapter 6. CRU replacement

Customer Replaceable Units (CRUs) are parts that can be replaced by the customer. The computers contain the following types of CRUs:

- **Self-service CRUs:** Refer to parts that can be replaced easily by customer themselves or by trained service technicians at an additional cost.
- **Optional-service CRUs:** Refer to parts that can be replaced by customers with a greater skill level. Trained service technicians can also provide service to replace the parts under the type of warranty designated for the customer's machine.

If you intend on installing a CRU, Lenovo will ship the CRU to you. CRU information and replacement instructions are shipped with your product and are available from Lenovo at any time upon request. You might be required to return the defective part that is replaced by the CRU. When return is required: (1) return instructions, a prepaid shipping label, and a container will be included with the replacement CRU; and (2) you might be charged for the replacement CRU if Lenovo does not receive the defective CRU within thirty (30) days of your receipt of the replacement CRU. For full details, see the Lenovo Limited Warranty documentation at https://www.lenovo.com/warranty/llw_02.

CRU list

The following is a list of CRUs of your computer.

Self-service CRUs

- ac power adapter*
- Base cover assembly
- M.2 solid-state drive
- M.2 solid-state drive bracket
- Nano-SIM-card tray*
- Lenovo Slim Pen*
- Power cord*

Optional-service CRUs

- Wireless WAN card*
- Wireless WAN card bracket*

* for selected models

Note: Replacement of any parts not listed above, including the built-in rechargeable battery, must be done by a Lenovo-authorized repair facility or technician. Go to <https://support.lenovo.com/partnerlocator> for more information.

Disable Fast Startup and the built-in battery

Before replacing any CRU, ensure that you disable Fast Startup first and then disable the built-in battery.

To disable Fast Startup:

1. Go to **Control Panel** and view by Large icons or Small icons.

2. Click **Power Options**, and then click **Choose what the power buttons do** on the left pane.
3. Click **Change settings that are currently unavailable** at the top.
4. If prompted by User Account Control (UAC), click **Yes**.
5. Clear the **Turn on fast startup** check box, and then click **Save changes**.

To disable the built-in battery:

1. Restart your computer. When the logo screen is displayed, immediately press F1 to enter the UEFI BIOS menu.
2. Select **Config → Power**. The **Power** submenu is displayed.
3. Select **Disable Built-in Battery** and press Enter.
4. Select **Yes** in the Setup Confirmation window. The built-in battery is disabled and the computer turns off automatically. Wait three to five minutes to let the computer cool.

Replace a CRU

Follow the replacement procedure to replace a CRU.

Base cover assembly

Prerequisite

Before you start, read [Generic Safety and Compliance Notices](#) and print the following instructions.

Notes: Do not remove the base cover assembly in the following situations. Otherwise, there might be a risk of short circuits.

- When your computer has the removable battery installed
- When your computer is connected to ac power

For access, do the following:

1. Disable the built-in battery. See “Disable Fast Startup and the built-in battery” on page 51.
2. Turn off the computer and disconnect the computer from ac power and all connected cables.
3. Remove the nano-SIM-card tray if your computer comes with one. See “Access networks” on page 11.
4. Close the computer display and turn over the computer.

Removal procedure

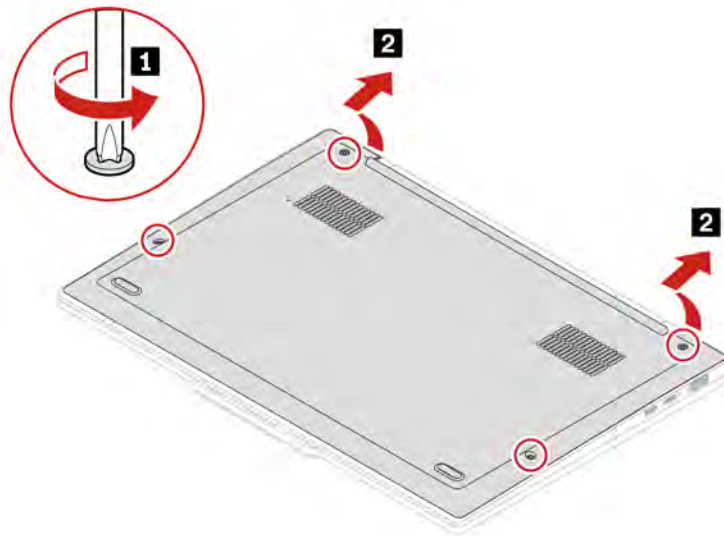

Troubleshooting

If the computer does not start up after you reinstall the base cover assembly, disconnect the ac power adapter and then reconnect it to the computer.

Wireless WAN card and wireless WAN card bracket (for selected models)

The following information is only for the computer with user-installable modules. Ensure that you use only a Lenovo-authorized wireless module specifically tested for this computer model. Otherwise, the computer will generate an error-code beep sequence when you turn on the computer.

Prerequisite

Before you start, read [Generic Safety and Compliance Notices](#) and print the following instructions.

Attention: Do not touch the contact edge of the wireless WAN card. Otherwise, the wireless WAN card might get damaged.

For access, do the following:

1. Disable the built-in battery. See “Disable Fast Startup and the built-in battery” on page 51.
2. Turn off the computer and disconnect the computer from ac power and all connected cables.
3. Remove the nano-SIM-card tray if your computer comes with one. See “Access networks” on page 11.
4. Close the computer display and turn the computer over.
5. Remove the base cover assembly. See “Base cover assembly” on page 52.

Removal procedure

Note: A Mylar film might cover the wireless WAN card. To access the wireless WAN card, peel off the film first.

Type one: models with 4G wireless WAN card

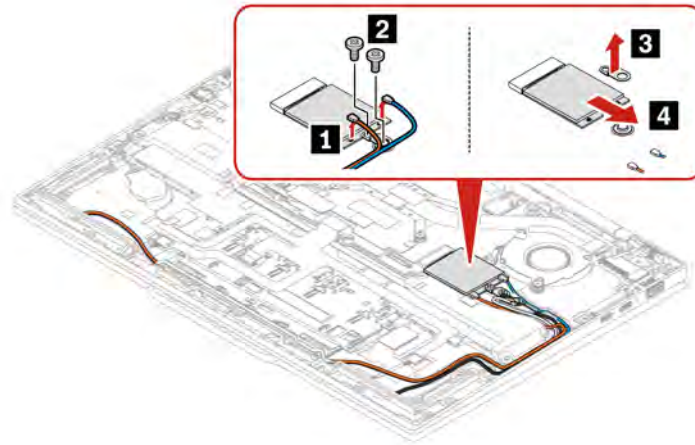

Note: Depending on models, the 4G wireless WAN card may be either 4 connectors or 2 connectors.

Type two: models with 5G wireless WAN card

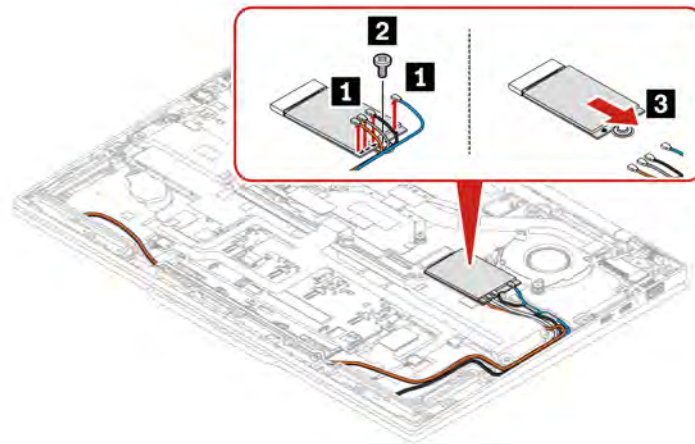

Type three: models with wireless WAN card bracket only

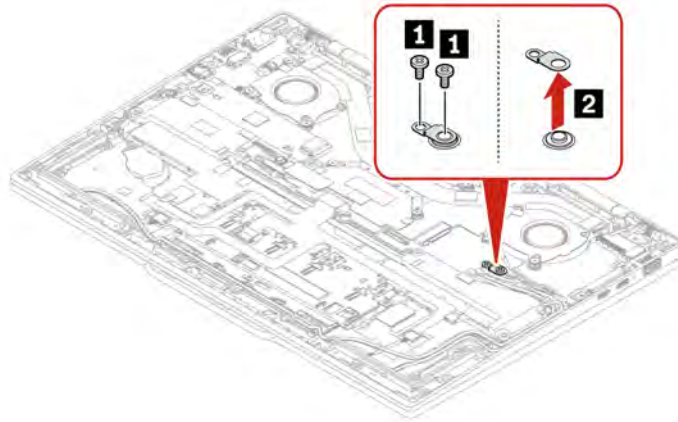

Antenna cable routing

The cable routing is different for 4G wireless WAN card and 5G wireless WAN card. Ensure that the antenna cables are installed appropriately when installing a wireless WWAN card.

Type one: 4G wireless WAN card with 2 connectors

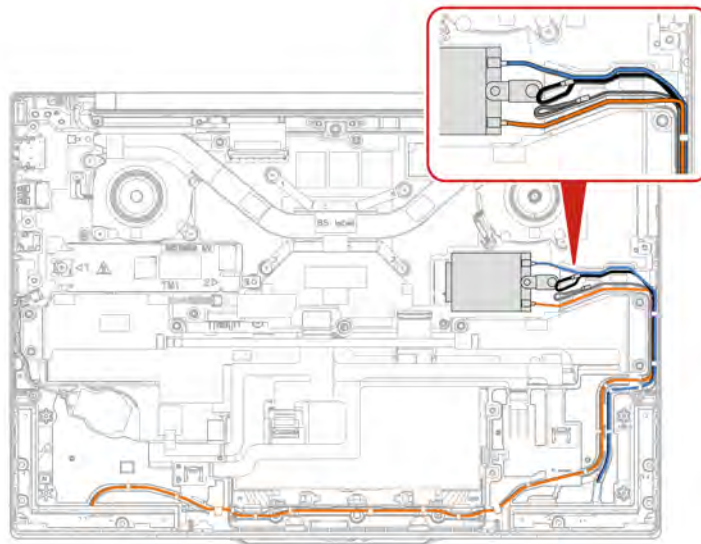

Type two: 4G wireless WAN card with 4 connectors

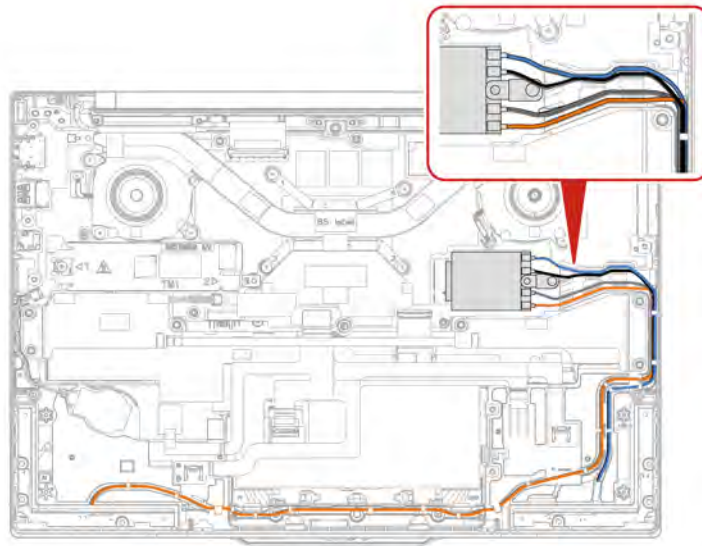

Type three: 5G wireless WAN card

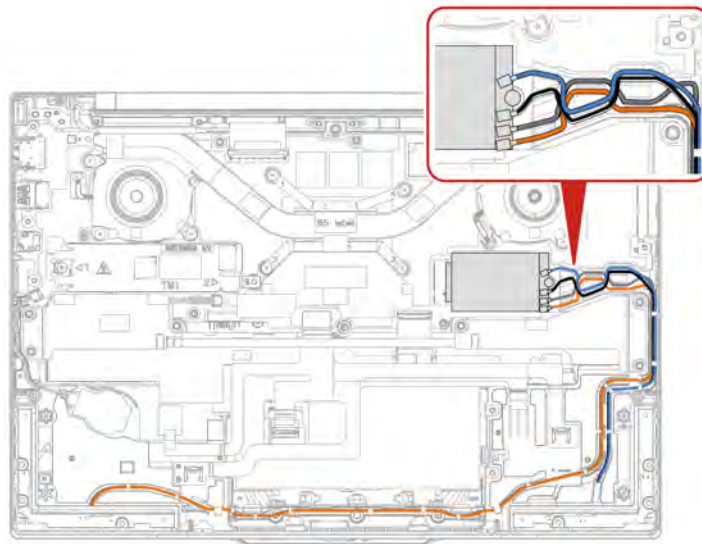

2242 M.2 solid-state drive and bracket

Prerequisite

Before you start, read [Generic Safety and Compliance Notices](#) and print the following instructions.

Attention:

- If you replace a M.2 solid-state drive, you might need to install a new operating system. For details on how to install a new operating system, see “Install a Windows operating system and drivers” on page 49.

The M.2 solid-state drive is sensitive. Inappropriate handling might cause damage and permanent loss of data.

When handling the M.2 solid-state drive, remove or insert the M.2 solid-state drive horizontally. Otherwise the slot might get damaged.



When handling the M.2 solid-state drive, observe the following guidelines:

- Replace the M.2 solid-state drive only for repair. The M.2 solid-state drive is not designed for frequent changes or replacement.
- Before replacing the M.2 solid-state drive, make a backup copy of all the data that you want to keep.
- Do not apply pressure to the M.2 solid-state drive.
- Do not touch the contact edge or circuit board of the M.2 solid-state drive. Otherwise, the M.2 solid-state drive might get damaged.
- Do not make the M.2 solid-state drive subject to physical shocks or vibration. Put the M.2 solid-state drive on a soft material, such as cloth, to absorb physical shocks.

For access, do the following:

1. Disable the built-in battery. See “Disable Fast Startup and the built-in battery” on page 51.
2. Turn off the computer and disconnect the computer from ac power and all connected cables.
3. Remove the nano-SIM-card tray if your computer comes with one. See “Access networks” on page 11.
4. Close the computer display and turn the computer over.
5. Remove the base cover assembly. See “Base cover assembly” on page 52.

Removal procedure

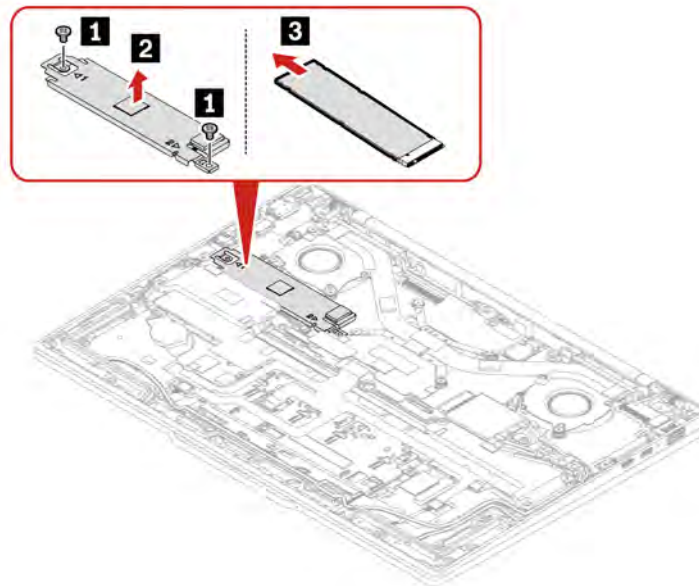

Chapter 7. Help and support

Frequently asked questions

Question	Solution
How do I access Control Panel ?	Type Control Panel in the Windows search box and then press Enter.
How do I turn off my computer?	Open the Start menu and click  Power . Then, click Shut down .
How do I partition my storage drive?	https://support.lenovo.com/solutions/ht503851
What do I do if my computer stops responding?	<ol style="list-style-type: none">1. Press and hold the power button until the computer turns off. Then, restart the computer.2. If step 1 does not work:<ul style="list-style-type: none">• For models with an emergency reset hole: Insert a straightened paper clip into the emergency reset hole to cut off power supply temporarily. Then, restart the computer with ac power connected.• For models without an emergency reset hole:<ul style="list-style-type: none">– For models with the removable battery, remove the removable battery and disconnect all power sources. Then, reconnect to ac power and restart the computer.– For models with the built-in battery, disconnect all power sources. Press and hold the power button for about seven seconds. Then, reconnect to ac power and restart the computer.
What do I do if I spill liquid on the computer?	<ol style="list-style-type: none">1. Carefully unplug the ac power adapter and turn off the computer immediately. The more quickly you stop the current from passing through the computer the more likely you will reduce damage from short circuits. Attention: Although you might lose some data or work by turning off the computer immediately, leaving the computer on might make your computer unusable.2. Do not try to drain out the liquid by turning over the computer. If your computer has keyboard drainage holes on the bottom, the liquid will be drained out through the holes.3. Wait until you are certain that all the liquid is dry before turning on your computer.
How do I enter the UEFI BIOS menu?	Restart the computer. When the logo screen is displayed, press F1 to enter the UEFI BIOS menu.

Question	Solution
Where can I get the latest device drivers and UEFI BIOS?	<ul style="list-style-type: none"> From the Vantage app. See “Install a Windows operating system and drivers” on page 49 and “Update UEFI BIOS” on page 48. Download from Lenovo Support Web site at https://pcsupport.lenovo.com.
What do I do if the LCD goes black when I turn on the computer?	<p>To run LCD Self-Test:</p> <ol style="list-style-type: none"> Ensure that the computer is connected to the ac power adapter. Press the power button for about seven seconds to turn off the computer. Press Fn, left Ctrl, and the power button at the same time. If the computer displays five solid colors in sequence across the entire screen, it indicates that the LCD functions normally. The test lasts for about 20 seconds and then exits automatically. You also can press the power button to exit the test.

Diagnose and troubleshoot your computer

This section provides introduction to a set of diagnostics and troubleshooting tools at Lenovo Support Web site, the Vantage app, and in your computer. They can help you diagnose common software and hardware issues.

The following table lists these diagnostics tools and the recommended conditions for each tool.

Diagnostics tool	Recommended scenario
Troubleshoot and diagnose at Lenovo Support Web site	You want to have an online troubleshooting or scan of hardware and drivers on your computer.
Hardware scan	<ul style="list-style-type: none"> Your computer is installed with the Vantage app. You want to perform basic examinations of the hardware components.
UEFI Diagnostics tool	<ul style="list-style-type: none"> You cannot log in to the operating system. Your computer cannot connect to the network.

Hardware scan

Hardware scan is an effective hardware testing tool to help you identify existing hardware issues.

To run the Hardware scan:

- Type **Vantage** in the Windows search box and then press Enter.
- Click **Hardware scan** or **Support → Hardware scan**.
- Select **QUICK SCAN** or **CUSTOMIZE** and then follow the on-screen instructions to run the hardware scan.

Notes:

- The Quick Scan tool contains a pre-selected suite of tests that performs basic examinations of the hardware components found in the system. The Customize tool enables you to select one or several hardware components to perform the examinations.
- Before selecting **QUICK SCAN**, click **Refresh Modules** to ensure that the list of hardware components are the components currently available for the computer.

4. If any hardware failure is detected, the result varies depending on the warranty status and varies by country or region. Follow the on-screen instructions to resolve the issue.

UEFI Diagnostics tool

UEFI Diagnostics tool enables you to view system information and identify hardware issues when you cannot log in to the operating system, or the computer cannot connect to the network.

To use the UEFI Diagnostics tool:

1. Connect your computer to ac power.
2. Turn on your computer, and press F10 immediately to enter the UEFI Diagnostics tool.
3. Follow the on-screen instructions to run the test.
4. Press Esc to exit the tool. Your computer will restart immediately.
5. If any hardware failure is detected and you are unable to locate and resolve the problem, you can call Lenovo Customer Support Center. See “Call Lenovo” on page 66

Error messages

If you see a message that is not included in the following table, record the error message first, then shut down the computer and call Lenovo for help. See “Lenovo Customer Support Center” on page 67.

Message	Solution
0190: Critical low-battery error	The computer turned off because the battery power is low. Connect the ac power adapter to the computer and charge the batteries.
0191: System Security - Invalid remote change requested	The system configuration change has failed. Confirm the operation and try again.
0199: System Security - Security password retry count exceeded.	This message is displayed when you enter a wrong supervisor password more than three times. Confirm the supervisor password and try again.
0271: Check Date and Time settings.	The date or the time is not set in the computer. Enter the UEFI BIOS menu and set the date and time.
210x/211x: Detection/Read error on HDDx/SSDx	The storage drive is not working. Reinstall the storage drive. If the problem still exists, replace the storage drive.

Note:

This error indicates that the operating system or programs cannot create, modify, or delete data in the non-volatile system UEFI variable storage due to insufficient storage space after POST.

The non-volatile system UEFI variable storage is used by the UEFI BIOS and by the operating system or programs. This error occurs when the operating system or programs store large amounts of data in the variable storage. All data needed for POST, such as UEFI BIOS setup settings, chipset, or platform configuration data, are stored in a separate UEFI variable storage.

Press F1 after the error message is displayed to enter the UEFI BIOS menu. A dialog asks for confirmation to clean up the storage. If you select “Yes”, all data that were created by the operating system or programs will be deleted except global variables defined by the Unified Extensible Firmware Interface Specification. If you select “No”, all data will be kept, but the operating system or programs will not be able to create, modify, or delete data in the storage.

If this error happens at a service center, Lenovo authorized service personnel will clean up the non-volatile system UEFI variable storage using the preceding solution.







Error: The non-volatile system UEFI variable storage is nearly full.

Battery-charge LED indicator diagnosis

The battery-charge LED indicator (hereafter referred to as LED indicator) blinks to help you diagnose and solve some computer problems.



























Indicator blinking patterns





The LED indicator blinks amber first and then white continually, consisting of different blinking patterns. Each blinking pattern corresponds to an error code. For example, when the LED indicator blinks amber once  and then blinks white twice  , the blinking pattern    corresponds to error code 0001.

Refer to the blinking patterns and error codes in the table below to solve your computer problems. 
<https://xxxxxx>.

Notes:

- The LED indicator blinks automatically only when the error in the following table occurs.
- The LED indicator blinks continually until the computer turns off. If you need to interrupt the process, press power button for a few seconds.
- Do not attempt to service a computer yourself unless instructed to do so by the Customer Support Center or product documentation. Only use a Lenovo-authorized service provider to repair your computer.

Blinking patterns	Error codes	Solutions
  	0001: Reset error (platform reset not deasserted)	<ol style="list-style-type: none"> 1. Remove the ac power adapter and the removable battery if your computer has one. Then, reset the computer by doing one of the following: <ul style="list-style-type: none"> • For models with the emergency-reset hole, insert a straightened paper clip into the emergency-reset hole. Wait for one minute. Then, reconnect all power resources and restart the computer. • For models without the emergency-reset hole, press and hold the power button for about seven seconds. Then, reconnect to all power resources and restart the computer. 2. If step 1 does not work, replace the system board (service provider only).
   	0002: Internal bus error	Replace the system board (service provider only).
    	0003: Non-Volatile Memory programming error in system power circuit	Replace the system board (service provider only).
  	0282: Memory module error	<ol style="list-style-type: none"> 1. Reinstall or replace the memory module. 2. If step 1 does not work, replace the system board (service provider only).
   	0283: PCI resource error	<ol style="list-style-type: none"> 1. Remove PCIe devices (the M.2 card, PCIe card, and so on) (service provider only). 2. If step 1 does not work, replace the system board (service provider only).
    	0284: TCG-compliant functionality-related error (might be the BIOS code validation failure)	Replace the system board (service provider only).

Blinking patterns	Error codes	Solutions
	0285: TCG-compliant functionality-related error (might be the TPM initialization failure)	Replace the system board (service provider only).
	0286: Integrated graphics error	Replace the system board (service provider only).
	0287: Discrete graphics error	<ol style="list-style-type: none"> 1. Reinstall or replace the discrete graphics card (service provider only). 2. If step 1 does not work, replace the system board (service provider only).
	0288: Computer display error	<ol style="list-style-type: none"> 1. Reconnect the display cable on both the system board side and the computer display side (service provider only) and check the LCD panel. 2. If step 1 does not work, connect an external display to your computer and check the status (customer or service provider). <ul style="list-style-type: none"> • If the external display works, replace the LCD panel (service provider only). • If the external display does not work, replace the system board (service provider only).
	0281: General embedded controller error	Replace the system board (service provider only).

Self-help resources

Use the following self-help resources to learn more about the computer and troubleshoot problems.

Resources	How to access?
Troubleshooting and FAQ	<ul style="list-style-type: none">• https://www.lenovo.com/tips• https://forums.lenovo.com
Accessibility information	https://www.lenovo.com/accessibility
Reset or restore Windows	<ul style="list-style-type: none">• Use Lenovo recovery options.<ol style="list-style-type: none">1. Go to https://support.lenovo.com/HowToCreateLenovoRecovery.2. Follow the on-screen instructions.• Use Windows recovery options.<ol style="list-style-type: none">1. Go to https://pcsupport.lenovo.com.2. Detect your computer or manually select your computer model.3. Navigate to the troubleshooting menu to diagnose the operating system for recovery instructions.
Use the Vantage app to: <ul style="list-style-type: none">• Configure device settings.• Download and install UEFI BIOS, drivers, and firmware updates.• Secure your computer from outside threats.• Diagnose hardware problems.• Check the computer warranty status.• Access <i>User Guide</i> and helpful articles.	Type Vantage in the Windows search box and then press Enter.
Note: The available features vary depending on the computer model.	
Product documentation: <ul style="list-style-type: none">• <i>Safety and Warranty Guide</i>• <i>Generic Safety and Compliance Notices</i>• <i>Setup Guide</i>• <i>This User Guide</i>• <i>Regulatory Notice</i>	Go to https://pcsupport.lenovo.com . Then, follow the on-screen instructions to filter out the documentation you want.

Resources	How to access?
<p>Lenovo Support Web site with the latest support information of the following:</p> <ul style="list-style-type: none"> • Drivers and software • Diagnostic solutions • Product and service warranty • Product and parts details • Knowledge base and frequently asked questions 	<p>https://pcsupport.lenovo.com</p>
<p>Windows help information</p>	<ul style="list-style-type: none"> • Open the Start menu and click Get Help or Tips. • Use Windows Search or the Cortana® personal assistant. • Microsoft support Web site: https://support.microsoft.com

Windows label

Your computer might have a Windows Genuine Microsoft label affixed to its cover depending on the following factors:

- Your geographic location
- Edition of Windows that is preinstalled

Go to <https://www.microsoft.com/en-us/howtotell/Hardware.aspx> for illustrations of the various types of Genuine Microsoft labels.

- In the People's Republic of China, the Genuine Microsoft label is required on all computer models preinstalled with any edition of the Windows operating system.
- In other countries and regions, the Genuine Microsoft label is required only on computer models licensed for Windows Pro editions.

The absence of a Genuine Microsoft label does not indicate that the preinstalled Windows version is not genuine. For details on how to tell whether your preinstalled Windows product is genuine, refer to the information provided by Microsoft at <https://www.microsoft.com/en-us/howtotell/default.aspx>.

There are no external, visual indicators of the Product ID or Windows version for which the computer is licensed. Instead, the Product ID is recorded in the computer firmware. Whenever a Windows product is installed, the installation program checks the computer firmware for a valid, matching Product ID to complete the activation.

In some cases, an earlier Windows version might be preinstalled under the terms of the Windows Pro edition license downgrade rights.

Call Lenovo

If you have tried to correct the problem yourself and still need help, you can call Lenovo Customer Support Center.

Before you contact Lenovo

Prepare the following before you contact Lenovo:

1. Record the problem symptoms and details:

- What is the problem? Is it continuous or intermittent?
 - Any error message or error code?
 - What operating system are you using? Which version?
 - Which software applications were running at the time of the problem?
 - Can the problem be reproduced? If so, how?
2. Record the system information:
- Product name
 - Machine type and serial number

The following illustration shows where to find the machine type and serial number of your computer.

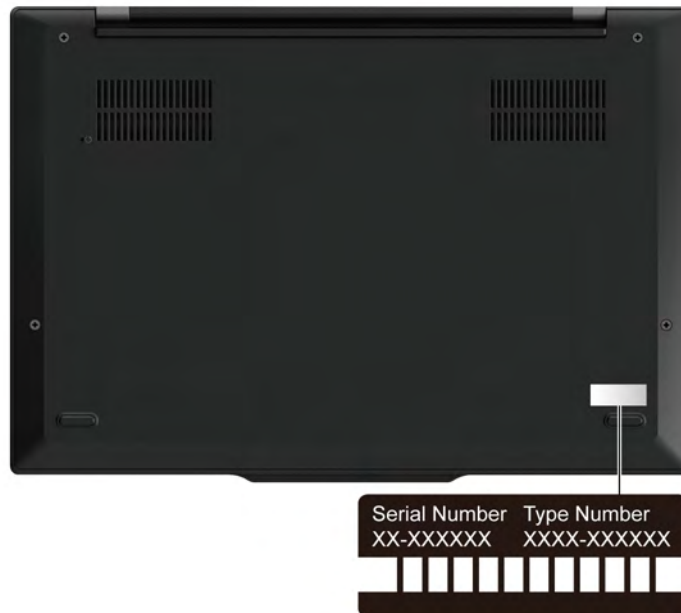

Lenovo Customer Support Center

During the warranty period, you can call Lenovo Customer Support Center for help.

Telephone numbers

For a list of the Lenovo Support phone numbers for your country or region, go to <https://pcsupport.lenovo.com/supportphonenumberlist> for the latest phone numbers.

Note: Phone numbers are subject to change without notice. If the number for your country or region is not provided, contact your Lenovo reseller or Lenovo marketing representative.

Services available during the warranty period

- Problem determination - Trained personnel are available to assist you with determining if you have a hardware problem and deciding what action is necessary to fix the problem.
- Lenovo hardware repair - If the problem is determined to be caused by Lenovo hardware under warranty, trained service personnel are available to provide the applicable level of service.
- Engineering change management - Occasionally, there might be changes that are required after a product has been sold. Lenovo or your reseller, if authorized by Lenovo, will make selected Engineering Changes (ECs) that apply to your hardware available.

Services not covered

- Replacement or use of parts not manufactured for or by Lenovo or nonwarranted parts
- Identification of software problem sources
- Configuration of UEFI BIOS as part of an installation or upgrade
- Changes, modifications, or upgrades to device drivers
- Installation and maintenance of network operating systems (NOS)
- Installation and maintenance of programs

For the terms and conditions of the Lenovo Limited Warranty that apply to your Lenovo hardware product, go to:

- https://www.lenovo.com/warranty/llw_02
- <https://pcsupport.lenovo.com/warrantylookup>

Purchase additional services

During and after the warranty period, you can purchase additional services from Lenovo at <https://pcsupport.lenovo.com/warrantyupgrade>.

Service availability and service name might vary by country or region.

Appendix A. Compliance information

For compliance information, refer to *Regulatory Notice* at <https://pcsupport.lenovo.com> and *Generic Safety and Compliance Notices* at https://pcsupport.lenovo.com/docs/generic_notices.

Certification-related information

Product name	Compliance ID	Machine type(s)
<ul style="list-style-type: none">ThinkPad X1 Carbon Gen 12ThinkPad X1 Carbon Gen 12 CAT4¹ThinkPad X1 Carbon Gen 12 5G¹	TP00150A	21KC and 21KD
<ul style="list-style-type: none">ThinkPad X1 2-in-1 Gen 9	TP00151A	21KE and 21KF

¹ for mainland China only

Further compliance information related to your product is available at <https://www.lenovo.com/compliance>.

Locate the UltraConnect wireless antennas

Your computer has an UltraConnect™ wireless antenna system. You can enable wireless communication wherever you are.

The following illustration shows the antenna locations on ThinkPad X1 Carbon Gen 12:



- 1** Wireless LAN antenna (main and auxiliary)
- 2** Wireless WAN antenna (MIMO1)*
- 3** Wireless WAN antenna (main)*
- 4** Wireless WAN antenna (auxiliary)*
- 5** Wireless WAN antenna (MIMO2)*

The following illustration shows the antenna locations on ThinkPad X1 2-in-1 Gen 9:

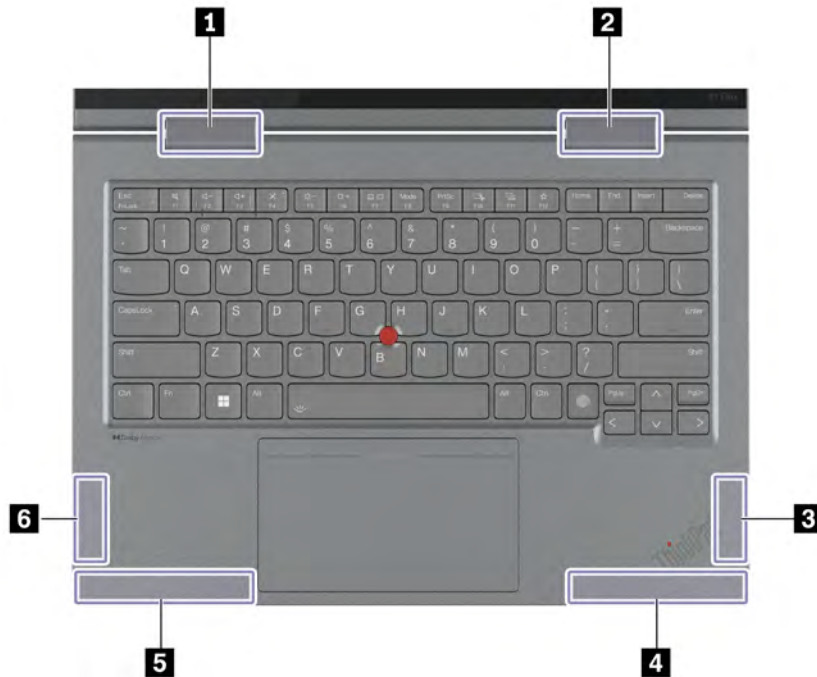

- 1 Wireless LAN antenna (auxiliary)
- 2 Wireless LAN antenna (main)
- 3 Wireless WAN antenna (MIMO1)*
- 4 Wireless WAN antenna (main)*
- 5 Wireless WAN antenna (auxiliary)*
- 6 Wireless WAN antenna (MIMO2)*

Operating environment

Maximum altitude (without pressurization)

3048 m (10 000 ft)

Temperature

- Operating: 5°C to 35°C (41°F to 95°F)
- Storage and transportation in original shipping packaging: -20°C to 60°C (-4°F to 140°F)
- Storage without packaging: 5°C to 43°C (41°F to 109°F)

Note: When you charge the battery, its temperature must be no lower than 10°C (50°F).

Relative humidity

- Operating: 8% to 95% at wet-bulb temperature 23°C (73°F)
- Storage and transportation: 5% to 95% at wet-bulb temperature 27°C (81°F)

Appendix B. Notices and trademarks

Notices

Lenovo may not offer the products, services, or features discussed in this document in all countries. Consult your local Lenovo representative for information on the products and services currently available in your area. Any reference to a Lenovo product, program, or service is not intended to state or imply that only that Lenovo product, program, or service may be used. Any functionally equivalent product, program, or service that does not infringe any Lenovo intellectual property right may be used instead. However, it is the user's responsibility to evaluate and verify the operation of any other product, program, or service.

Lenovo may have patents or pending patent programs covering subject matter described in this document. The furnishing of this document does not give you any license to these patents. You can send license inquiries, in writing, to:

*Lenovo (United States), Inc.
8001 Development Drive
Morrisville, NC 27560
U.S.A.
Attention: Lenovo Director of Licensing*

LENOVO PROVIDES THIS PUBLICATION "AS IS" WITHOUT WARRANTY OF ANY KIND, EITHER EXPRESS OR IMPLIED, INCLUDING, BUT NOT LIMITED TO, THE IMPLIED WARRANTIES OF NON-INFRINGEMENT, MERCHANTABILITY OR FITNESS FOR A PARTICULAR PURPOSE. Some jurisdictions do not allow disclaimer of express or implied warranties in certain transactions, therefore, this statement may not apply to you.

Changes are made periodically to the information herein; these changes will be incorporated in new editions of the publication. To provide better service, Lenovo reserves the right to improve and/or modify the products and software programs described in the manuals included with your computer, and the content of the manual, at any time without additional notice.

The software interface and function and hardware configuration described in the manuals included with your computer might not match exactly the actual configuration of the computer that you purchase. For the configuration of the product, refer to the related contract (if any) or product packing list, or consult the distributor for the product sales. Lenovo may use or distribute any of the information you supply in any way it believes appropriate without incurring any obligation to you.

The products described in this document are not intended for use in implantation or other life support applications where malfunction may result in injury or death to persons. The information contained in this document does not affect or change Lenovo product specifications or warranties. Nothing in this document shall operate as an express or implied license or indemnity under the intellectual property rights of Lenovo or third parties. All information contained in this document was obtained in specific environments and is presented as an illustration. The result obtained in other operating environments may vary.

Lenovo may use or distribute any of the information you supply in any way it believes appropriate without incurring any obligation to you.

Any references in this publication to non-Lenovo Web sites are provided for convenience only and do not in any manner serve as an endorsement of those Web sites. The materials at those Web sites are not part of the materials for this Lenovo product, and use of those Web sites is at your own risk.

Any performance data contained herein was determined in a controlled environment. Therefore, the result obtained in other operating environments may vary significantly. Some measurements may have been made on development-level systems and there is no guarantee that these measurements will be the same on generally available systems. Furthermore, some measurements may have been estimated through extrapolation. Actual results may vary. Users of this document should verify the applicable data for their specific environment.

This document is copyrighted by Lenovo and is not covered by any open source license, including any Linux® agreement(s) which may accompany software included with this product. Lenovo may update this document at any time without notice.

For the latest information or any questions or comments, contact or visit the Lenovo Web site:

<https://pcsupport.lenovo.com>

Trademarks

Lenovo, Lenovo logo, ThinkPad, ThinkPad logo, and TrackPoint are trademarks of Lenovo. Intel and Thunderbolt are trademarks of Intel Corporation or its subsidiaries in the U.S. and/or other countries. Linux is the registered trademark of Linus Torvalds in the U.S. and other countries. Microsoft, Microsoft Teams, Windows, BitLocker, and Cortana are trademarks of the Microsoft group of companies. NVIDIA is a registered trademark of NVIDIA Corporation. Dolby, Dolby Voice, Dolby Atmos and Dolby Vision are trademarks of Dolby Laboratories Licensing Corporation. The terms HDMI and HDMI High-Definition Multimedia Interface are trademarks or registered trademarks of HDMI Licensing LLC in the United States and other countries. USB-C is a registered trademark of USB Implementers Forum. Wi-Fi and Miracast are registered trademarks of Wi-Fi Alliance. All other trademarks are the property of their respective owners.