

MEASUREMENT REPORT

FCC ID: XMR2023RG520NNA
Applicant: Quectel Wireless Solutions Co., Ltd
Product: 5G Sub-6 GHz LGA Module
Model No.: RG520N-NA
Brand Name: Quectel
FCC Rule Part(s): Part 2, 27
Result: Complies
Received Date: 2023-03-23
Test Date: 2023-03-23 ~ 2023-04-14

Reviewed By:

Sunny Sun

Approved By:

Robin Wu



The test results relate only to the samples tested.

This equipment has been shown to be capable of compliance with the applicable technical standards as indicated in the measurement report and was tested in accordance with the measurement procedures specified in ANSI C63.26-2015. Test results reported herein relate only to the item(s) tested.

The test report shall not be reproduced except in full without the written approval of MRT Technology (Suzhou) Co., Ltd.

Revision History

Report No.	Version	Description	Issue Date	Note
2203RSU050-U1	Rev. 01	Initial Report	2023-04-24	Valid

Note: This report is based on FCC ID: XMR2022RG520NNA increasing 5G NR n41/77/78 UL MIMO Power Class to PC 1.5 via SW.

CONTENTS

Description	Page
1. General Information.....	5
1.1. Applicant	5
1.2. Manufacturer	5
1.3. Testing Facility	5
1.4. Product Information.....	6
1.5. Radio Specification under Testing.....	6
1.6. Description of Available Antennas.....	7
1.7. Test Methodology	7
1.8. Device Capabilities	8
2. Test Configuration	9
2.1. Test System Connection Diagram.....	9
2.2. Test Environment Condition	9
3. Measuring Instrument	10
4. Decision Rules and Measurement Uncertainty.....	11
4.1. Decision Rules	11
4.2. Measurement Uncertainty.....	11
5. Test Result.....	12
5.1. Summary.....	12
5.2. Occupied Bandwidth Measurement.....	13
5.2.1. Test Limit	13
5.2.2. Test Procedure.....	13
5.2.3. Test Setting	13
5.2.4. Test Setup	13
5.2.5. Test Result	14
5.3. Frequency Stability Measurement	15
5.3.1. Test Limit	15
5.3.2. Test Procedure.....	15
5.3.3. Test Setting	15
5.3.4. Test Setup	16
5.3.5. Test Result	16
5.4. Equivalent Isotropically Radiated Power Measurement	17
5.4.1. Test Limit	17
5.4.2. Test Procedure.....	17
5.4.3. Test Setting	17

5.4.4.	Test Setup	17
5.4.5.	Test Result	18
5.5.	Peak to Average Ratio Measurement	19
5.5.1.	Test Limit	19
5.5.2.	Test Procedure	19
5.5.3.	Test Setting	19
5.5.4.	Test Setup	19
5.5.5.	Test Result	19
5.6.	Band Edge Measurement	20
5.6.1.	Test Limit	20
5.6.2.	Test Procedure	20
5.6.3.	Test Setting	21
5.6.4.	Test Setup	21
5.6.5.	Test Result	21
5.7.	Conducted Spurious Emissions Measurement.....	22
5.7.1.	Test Limit	22
5.7.2.	Test Procedure	22
5.7.3.	Test Setting	22
5.7.4.	Test Setup	23
5.7.5.	Test Result	23
5.8.	Radiated Spurious Emissions Measurement.....	24
5.8.1.	Test Limit	24
5.8.2.	Test Procedure	24
5.8.3.	Test Setting	24
5.8.4.	Test Setup	25
5.8.5.	Test Result	25
Appendix A - Test Result		26
A.1	Occupied Bandwidth Test Result	26
A.2	Frequency Stability Test Result.....	56
A.3	Equivalent Isotropically Radiated Power Test Result.....	59
A.4	Peak to Average Ratio Test Result	197
A.5	Band Edge Test Result	200
A.6	Conducted Spurious Emissions Test Result	222
A.7	Radiated Spurious Emissions Test Result	243
Appendix B - Test Setup Photograph		246
Appendix C - EUT Photograph		247

1.4. Product Information

Product Name	5G Sub-6 GHz LGA Module
Model No.	RG520N-NA
Brand Name	Quectel
IMEI	863109050057814
E-UTRA Single Band	Band 2, 4, 5, 7, 12, 13, 14, 17, 25, 26, 30, 38, 41, 48, 66, 71
5G NR SA Band	n2, n5, n7, n12, n13, n14, n25, n26, n30, n38, n41, n48, n66, n71, n77, n78
SCS for NR cell	FDD Band: 15kHz; TDD Band: 30kHz
Operating Temperature	-30 ~ 75 °C
Supply Voltage	3.3 ~ 4.4Vdc, typical 3.8Vdc
Remark: The information of EUT was provided by the manufacturer, and the accuracy of the information shall be the responsibility of the manufacturer.	

1.5. Radio Specification under Testing

5G NR Specification	
TDD Frequency Range	n41: 2496 ~ 2690 MHz; n77: 3450 ~ 3550, 3700 ~ 3980MHz n78: 3450 ~ 3550, 3700 ~ 3800MHz
Support Bandwidth	n41: 20, 30, 40, 50, 60, 70, 80, 90, 100MHz n77, n78: 10, 15, 20, 30, 40, 50, 60, 70, 80, 90, 100MHz
Modulation	UL & DL up to 256QAM
Power Class	1.5

1.6. Description of Available Antennas

Technology	Frequency Range (MHz)	Antenna Type	Max Peak Gain (dBi)
n41	2496 ~ 2690	Dipole	1.18
n77	3450 ~ 3550		0.58
	3700 ~ 3980		
n78	3450 ~ 3550		0.58
	3700 ~ 3800		

Note 1: All antenna information (Antenna type and Peak Gain) is provided by the manufacturer.

Note 2: The typical antennas used to calculate the ERP (EIRP).

1.7. Test Methodology

According to the specifications of the manufacturer, the EUT must comply with the requirements of the following standards:

- ANSI C63.26:2015
- FCC CFR 47 Part 2, Part 22, Part 24, Part 27
- FCC KDB 971168 D01 v03r01: Power Meas License Digital Systems
- FCC KDB 971168 D02 v02r01: Misc Rev Approv License Devices
- FCC KDB 412172 D01 v01r01: Determining ERP and EIRP
- FCC KDB 662911 D01 v02r01: Multiple Transmitter Output

1.8. Device Capabilities

This device contains 5G NR SA & EN-DC the following capabilities:

Working on NR Band n2, n5, n7, n12, n13, n25, n26, n30, n38, n41, n66, n71, n77, n78.

n77 (3300 ~ 4200 MHz) overlaps the entire frequency range of n78 (3300 ~ 3800 MHz). Therefore, test data provided in this report covers n78 as well as n77.

PI/2 BPSK modulation applied for 5G NR band frequencies and has the same tune up power as QPSK modulations.

The worst-case scenario for all measurements is based on an engineering evaluation and QPSK was observed as the worst one and set for all conducted and radiated. Output power measurements were measured on DFT-s-OFDM PI/2 BPSK, QPSK, 16QAM, 64QAM, 256QAM, and CP-OFDM QPSK modulations.

2. Test Configuration

2.1. Test System Connection Diagram

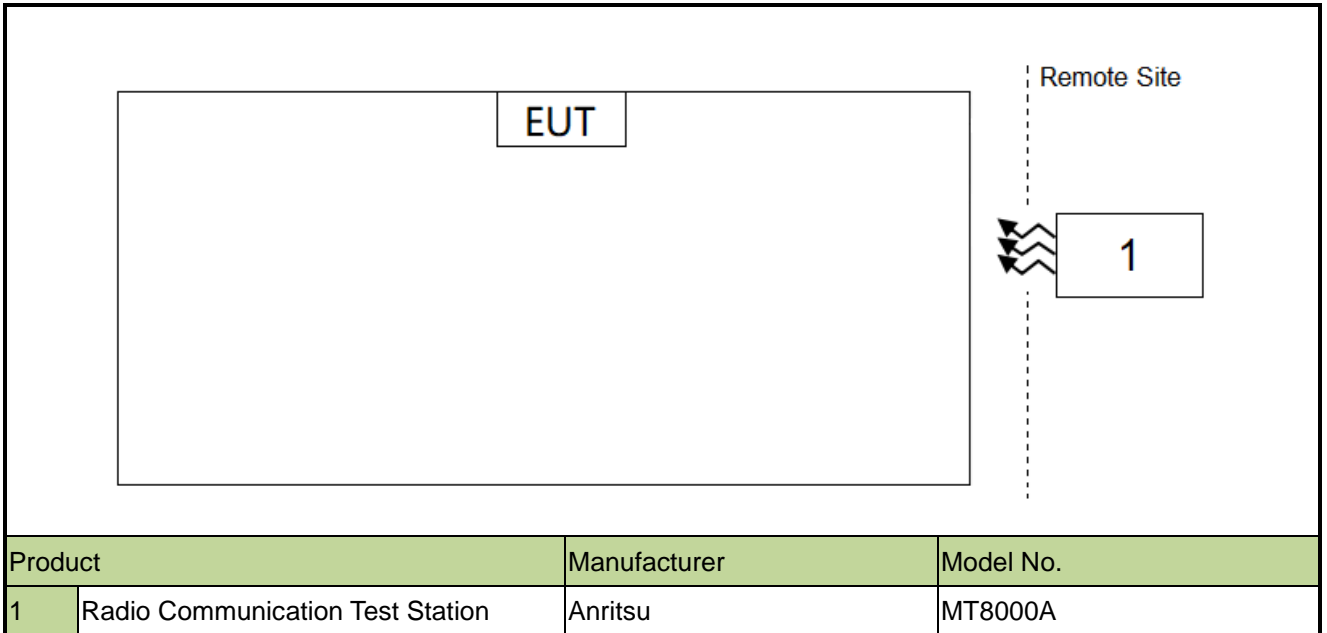

2.2. Test Environment Condition

Ambient Temperature	15 ~ 35°C
Relative Humidity	20 ~ 75%RH

3. Measuring Instrument

Instrument	Manufacturer	Model No.	Asset No.	Cali. Interval	Cali. Due Date	Test Site
Thermohygrometer	testo	608-H1	MRTSUE06362	1 year	2024-02-14	WZ-SR6
Shielding Room	HUAMING	WZ-SR6	MRTSUE06443	N/A	N/A	WZ-SR6
Signal Analyzer	Keysight	N9020B	MRTSUE06583	1 year	2023-10-08	WZ-SR6
Signal Generator	Keysight	N5173B	MRTSUE06606	1 year	2023-11-25	WZ-SR6
5G Wireless Test Platform	Keysight	E7515B	MRTSUE06942	1 year	2024-02-29	WZ-SR6
Radio Communication Analyzer	Anritsu	MT8821C	MRTSUE06960	1 year	2023-07-08	WZ-SR6
Radio Communication Test Station	Anritsu	MT8000A	MRTSUE06961	1 year	2023-06-30	WZ-SR6
TRILOG Antenna	Schwarzbeck	VULB 9162	MRTSUE06022	1 year	2023-05-20	WZ-AC2
EMI Test Receiver	Agilent	N9038A	MRTSUE06125	1 year	2023-06-04	WZ-AC2
Thermohygrometer	Mingle	ETH529	MRTSUE06170	1 year	2023-11-27	WZ-AC2
Horn Antenna	Schwarzbeck	BBHA 9120D	MRTSUE06171	1 year	2023-10-13	WZ-AC2
Preamplifier	Schwarzbeck	BBV 9718	MRTSUE06176	1 year	2023-05-08	WZ-AC2
Anechoic Chamber	RIKEN	WZ-AC2	MRTSUE06213	1 year	2023-04-21	WZ-AC2
Thermohygrometer	testo	608-H1	MRTSUE11038	1 year	2023-11-01	WZ-AC2
Temperature Chamber	BAOYT	BYH-150CL	MRTSUE06051	1 year	2023-10-08	WZ-TR3
Vibration Test System	DongLing	ES-1-150	MRTSUE06206	1 year	2023-07-07	WZ-TR3
Thermohygrometer	testo	608-H1	MRTSUE06401	1 year	2023-06-06	WZ-TR3

Software	Version	Function
EMI Software	V3.0.0	EMI Test Software
Controller_MF 7802	1.02	RE Antenna & Turntable

4. Decision Rules and Measurement Uncertainty

4.1. Decision Rules

The Decision Rule is based on Simple Acceptance in accordance with ISO Guide 98-4: 2012 Clause 8.2. (Measurement uncertainty is not taken into account when stating conformity with a specified requirement.)

4.2. Measurement Uncertainty

Where relevant, the following test uncertainty levels have been estimated for tests performed on the EUT as specified in CISPR 16-4-2. This uncertainty represents an expanded uncertainty expressed at approximately the 95% confidence level using a coverage factor of $k = 2$.

Radiated Spurious Emissions
Measurement Uncertainty for a Level of Confidence of 95% ($U=2Uc(y)$): Horizontal: 9kHz ~ 300MHz: 5.04dB 300MHz ~ 1GHz: 4.95dB 1GHz ~ 40GHz: 6.40dB Vertical: 9kHz ~ 300MHz: 5.24dB 300MHz ~ 1GHz: 6.03dB 1GHz ~ 40GHz: 6.40dB
Conducted Spurious Emissions
Measuring Uncertainty for a Level of Confidence of 95% ($U=2Uc(y)$): 0.78dB
Output Power
Measuring Uncertainty for a Level of Confidence of 95% ($U=2Uc(y)$): 1.13dB
Occupied Bandwidth
Measuring Uncertainty for a Level of Confidence of 95% ($U=2Uc(y)$): 0.28%
Frequency Stability
Measuring Uncertainty for a Level of Confidence of 95% ($U=2Uc(y)$): 76.2Hz

5. Test Result

5.1. Summary

FCC Part Section(s)	Test Description	Test Condition	Test Result
2.1049	Occupied Bandwidth	Conducted	Pass
2.1055, 27.54	Frequency Stability		
27.50(h)(2), (j)(3), (k)(3)	Equivalent Isotropic Radiated Power		
27.50(j), (k)(4)	Peak to Average Ratio		
2.1051, 27.53(m), (n), (l)(2)	Band Edge		
2.1051, 27.53(m), (n), (l)(2)	Spurious Emission		
2.1051, 27.53(m), (n), (l)(2)	Spurious Emissions	Radiated	Pass

Notes:

- 1) The analyzer plots shown in this section were all taken with a correction table loaded into the analyzer. The correction table was used to account for the losses of the cables and attenuators used as part of the system to connect the EUT to the analyzer at all frequencies of interest.
- 2) All supported modulation types were evaluated. The worst-case emission of modulation was selected. Therefore, the Frequency Stability, Channel Band Edge, Conducted & Radiated Spurious Emission were presented worst-case in the test report.
- 3) For radiated emission tests, every axis (X, Y, Z) was also verified. The test results shown in the following sections represent the worst-case emissions.

5.2. Occupied Bandwidth Measurement

5.2.1. Test Limit

The occupied bandwidth, that is the frequency bandwidth such that, below its lower and above its upper frequency limits, the mean powers radiated are each equal to 0.5 percent of the total mean power radiated by a given emission shall be measured.

5.2.2. Test Procedure

ANSI C63.26-2015 - Section 5.4

5.2.3. Test Setting

1. Set center frequency to the nominal EUT channel center frequency
2. RBW = The nominal RBW shall be in the range of 1% to 5% of the anticipated OBW
3. VBW $\geq 3 \times$ RBW
4. Detector = Peak
5. Trace mode = max hold
6. Sweep = auto couple
7. Allow the trace to stabilize
8. Use the 99% power bandwidth function of the instrument and report the measured bandwidth.

5.2.4. Test Setup

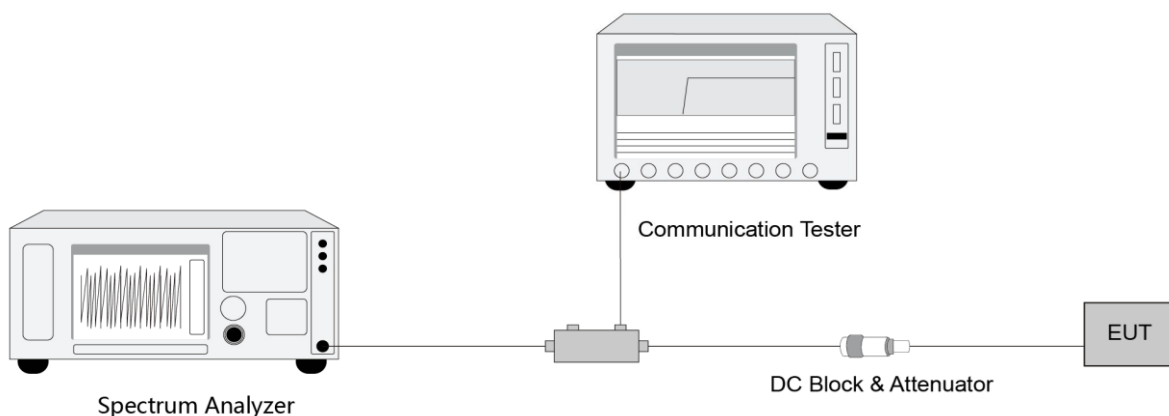

5.2.5. Test Result

Refer to Appendix A.1.

5.3. Frequency Stability Measurement

5.3.1. Test Limit

The frequency stability shall be measured by variation of ambient temperature and variation of primary supply voltage to ensure that the fundamental emission stays within the authorized frequency block. The frequency stability of the transmitter shall be maintained within $\pm 0.00025\%$ ($\pm 2.5\text{ppm}$) of the center frequency.

5.3.2. Test Procedure

ANSI C63.26-2015 - Section 5.4 & 5.6

5.3.3. Test Setting

1. Use the occupied bandwidth function of the instrument and record the low edge for low channel occupancy bandwidth and the high edge for high channel occupancy bandwidth.
2. Change the temperature of equipment and repeat Steps 1.
3. Change the Voltage of equipment and repeat Steps 1.
4. Use the frequency error function of the instrument and record the frequency error.
5. Change the temperature of equipment and repeat Steps 4.
6. Change the Voltage of equipment and repeat Steps 4.

Frequency Stability Under Temperature Variations:

The equipment under test was connected to an external AC or DC power supply and input rated voltage. RF output was connected to a frequency counter or spectrum analyzer via feed through attenuators. The EUT was placed inside the temperature chamber. Set the spectrum analyzer RBW low enough to obtain the desired frequency resolution and measure EUT 20°C operating frequency as reference frequency. Turn EUT off and set the chamber temperature to highest. After the temperature stabilized for approximately 30 minutes recorded the frequency. Repeat step measure with 10°C decreased per stage until the lowest temperature reached.

Frequency Stability Under Voltage Variations:

Set chamber temperature to 20°C. Use a variable AC power supply / DC power source to power the EUT and set the voltage to rated voltage. Set the spectrum analyzer RBW low enough to obtain the desired frequency resolution and recorded the frequency.

Reduce the input voltage to specify extreme voltage variation ($\pm 15\%$) and endpoint, record the maximum frequency change.

5.3.4. Test Setup

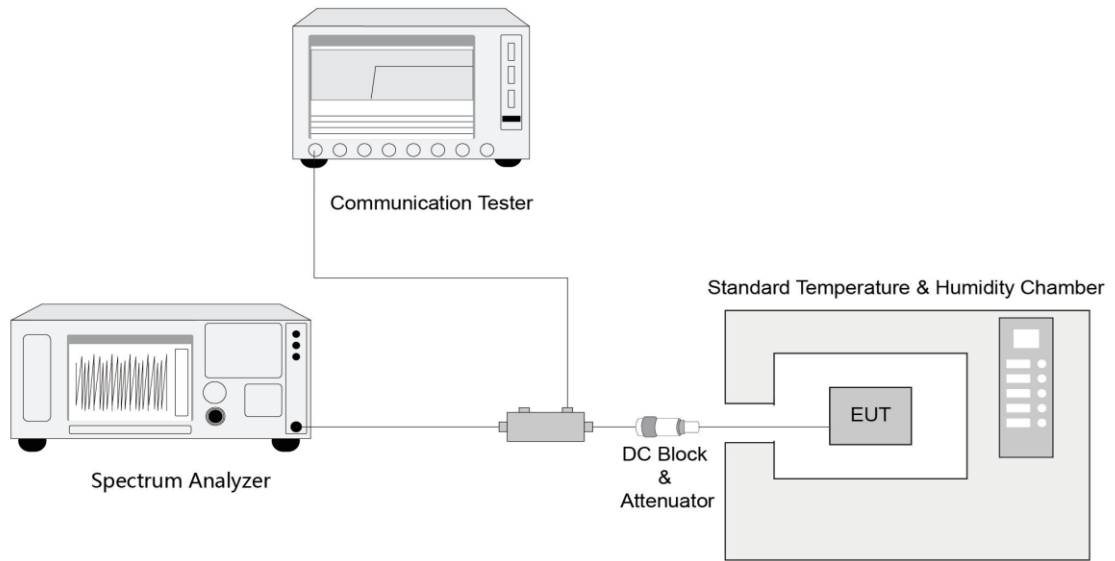

5.3.5. Test Result

Refer to Appendix A.2.

5.4. Equivalent Isotropically Radiated Power Measurement

5.4.1. Test Limit

The EIRP of mobile transmitters must not exceed 2 watts for n41.

The EIRP of mobile transmitters must not exceed 1 watt for n77 & n78.

5.4.2. Test Procedure

ANSI C63.26-2015 - Section 5.2

5.4.3. Test Setting

Average power measurements were performed only when the EUT was transmitting at its maximum power control level using a broadband power meter with a pulse sensor. The power meter implemented triggering and gating capabilities which were set up such that power measurements were recorded only during the ON time of the transmitter.

The relevant equation for determining the maximum ERP or EIRP from the measured RF output power is given in Equation (1) as follows:

$$\text{ERP or EIRP} = P_{\text{Meas}} + G_T$$

where

ERP or EIRP effective radiated power or equivalent isotropically radiated power, respectively (expressed in the same units as P_{Meas} , e.g., dBm or dBW)

P_{Meas} measured transmitter output power or PSD, in dBm or dBW

G_T gain of the transmitting antenna, in dBd (ERP) or dBi (EIRP)

$$\text{ERP} = \text{EIRP} - 2.15$$

5.4.4. Test Setup

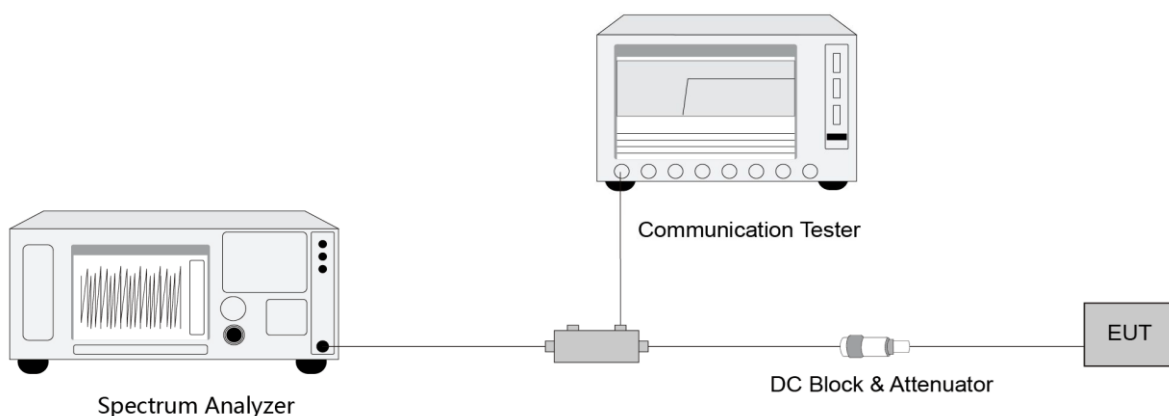

5.4.5. Test Result

Refer to Appendix A.3.

5.5. Peak to Average Ratio Measurement

5.5.1. Test Limit

A peak to average ratio measurement is performed at the conducted port of the EUT. The spectrum analyzers Complementary Cumulative Distribution Function (CCDF) measurement profile is used to determine the largest deviation between the average and the peak power of the EUT in a given bandwidth. The CCDF curve shows how much time the peak waveform spends at or above a given average power level. The percent of time the signal spends at or above the level defines the probability for that particular power level.

5.5.2. Test Procedure

ANSI C63.26-2015 - Section 5.2.3.4 (CCDF).

5.5.3. Test Setting

1. Set the resolution / measurement bandwidth \geq signal's occupied bandwidth
2. Set the number of counts to a value that stabilizes the measured CCDF curve
3. Record the maximum PARR level associated with a probability of 0.1%

5.5.4. Test Setup

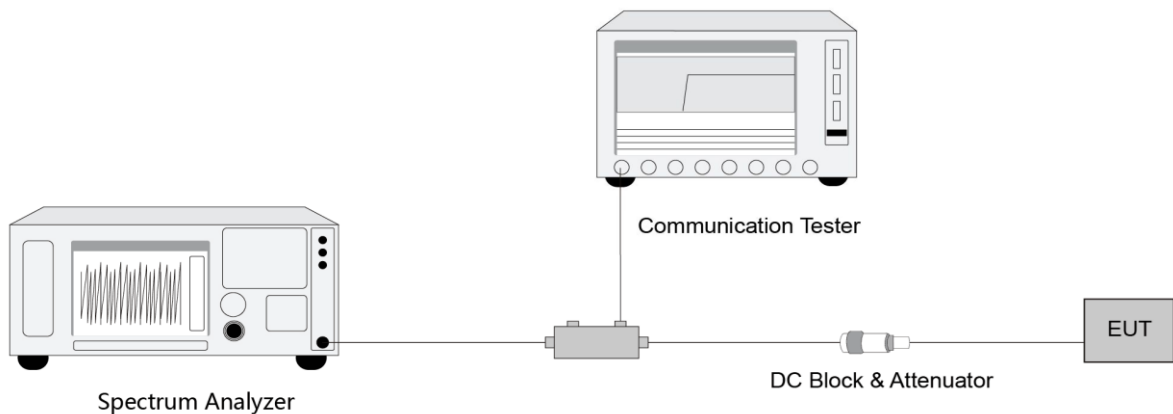

5.5.5. Test Result

Refer to Appendix A.4.

5.6. Band Edge Measurement

5.6.1. Test Limit

27.53 (n) (l)(2)

The FCC limit is $43 + 10\log_{10}(P_{\text{Watts}})$ dB below the transmitter power P(Watts) in a 1 MHz bandwidth.

However, in the 1MHz bands immediately outside and adjacent to the licensee's frequency block, a resolution bandwidth of at least one percent of the emission bandwidth of the fundamental emission of the transmitter may be employed.

27.53(m)(4)

For mobile digital stations, the attenuation factor shall be not less than $40 + 10 \log (P)$ dB on all frequencies between the channel edge and 5 megahertz from the channel edge, $43 + 10 \log (P)$ dB on all frequencies between 5 megahertz and X megahertz from the channel edge, and $55 + 10 \log (P)$ dB on all frequencies more than X megahertz from the channel edge, where X is the greater of 6 megahertz or the actual emission bandwidth as defined in paragraph (m)(6) of this section. In addition, the attenuation factor shall not be less than $43 + 10 \log (P)$ dB on all frequencies between 2490.5 MHz and 2496 MHz and $55 + 10 \log (P)$ dB at or below 2490.5 MHz. Mobile Satellite Service licensees operating on frequencies below 2495 MHz may also submit a documented interference complaint against BRS licensees operating on channel BRS Channel 1 on the same terms and conditions as adjacent channel BRS or EBS licensees.

5.6.2. Test Procedure

ANSI C63.26-2015 - Section 5.7

5.6.3. Test Setting

1. Set the analyzer frequency to low or high channel
2. $RBW \geq$ The nominal RBW shall be in the range of 1% of the anticipated OBW (in the 1MHz band immediately outside and adjacent to the band edge). For improvement of the accuracy in the measurement of the average power of a noise-like emission, a RBW narrower than the specified reference bandwidth can be used (generally limited to no less than 1% of the OBW), provided that a subsequent integration is performed over the full required measurement bandwidth. This integration should be performed using the spectrum analyzer's band power functions.
3. $VBW \geq 3 \cdot RBW$
4. Sweep time = auto
5. Detector = power averaging (rms)
6. Set sweep trigger to "free run."
7. User gate triggered such that the analyzer only sweeps when the device is transmitting at full power
8. Trace average at least 100 traces in power averaging (rms) mode if sweep is set to auto-couple. To accurately determine the average power over the on and off time of the transmitter, it can be necessary to increase the number of traces to be averaged above 100, or if using a manually configured sweep time, increase the sweep time.

5.6.4. Test Setup

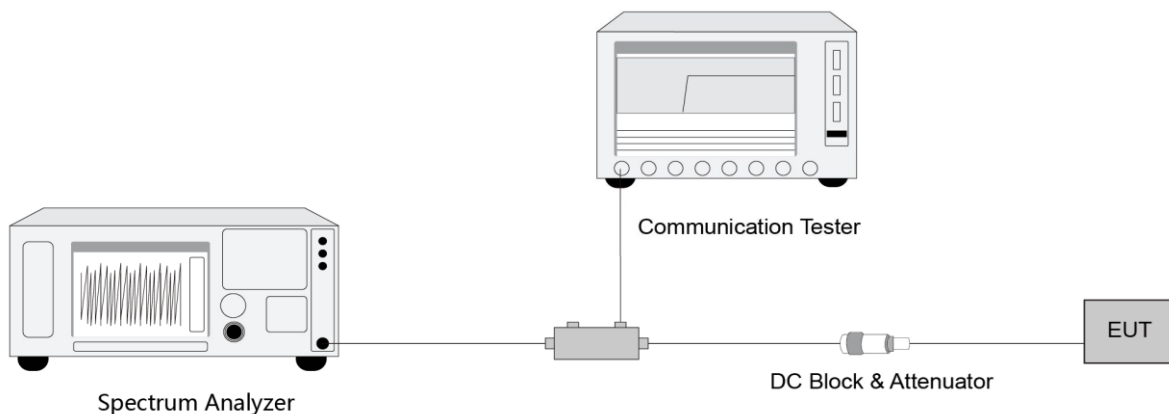

5.6.5. Test Result

Refer to Appendix A.5.

5.7. Conducted Spurious Emissions Measurement

5.7.1. Test Limit

The level of the carrier and the various conducted spurious and harmonic frequencies is measured by means of a calibrated spectrum analyzer. The spectrum is scanned from the lowest frequency generated in the equipment up to a frequency including its 10th harmonic. All out of band emissions are measured with a spectrum analyzer connected to the antenna terminal of the EUT while the EUT is operating at its maximum duty cycle, at maximum power, and at the appropriate frequencies. All data rates were investigated to determine the worst-case configuration. All modes of operation were investigated and the worst-case configuration results are reported in this section.

The power of any emission outside of the authorized operating frequency ranges must be attenuated below the transmitting power (P) by a factor of at least $43 + 10 \log(P)$ dB.

For mobile digital stations, the attenuation factor shall be not less than $40 + 10 \log(P)$ dB on all frequencies between the channel edge and 5 megahertz from the channel edge, $43 + 10 \log(P)$ dB on all frequencies between 5 megahertz and X megahertz from the channel edge, and $55 + 10 \log(P)$ dB on all frequencies more than X megahertz from the channel edge, where X is the greater of 6 megahertz or the actual emission bandwidth.

5.7.2. Test Procedure

ANSI C63.26-2015 - Section 5.7

5.7.3. Test Setting

1. Set the analyzer frequency to low, mid, high channel.
2. RBW = 1MHz
3. VBW $\geq 3 \cdot$ RBW
4. Sweep time = auto
5. Detector = power averaging (rms)
6. Set sweep trigger to "free run."
7. User gate triggered such that the analyzer only sweeps when the device is transmitting at full power.
8. Trace average at least 100 traces in power averaging (rms) mode if sweep is set to auto-couple. To accurately determine the average power over the on and off time of the transmitter, it can be necessary to increase the number of traces to be averaged above 100, or if using a manually configured sweep time, increase the sweep time.

5.7.4. Test Setup

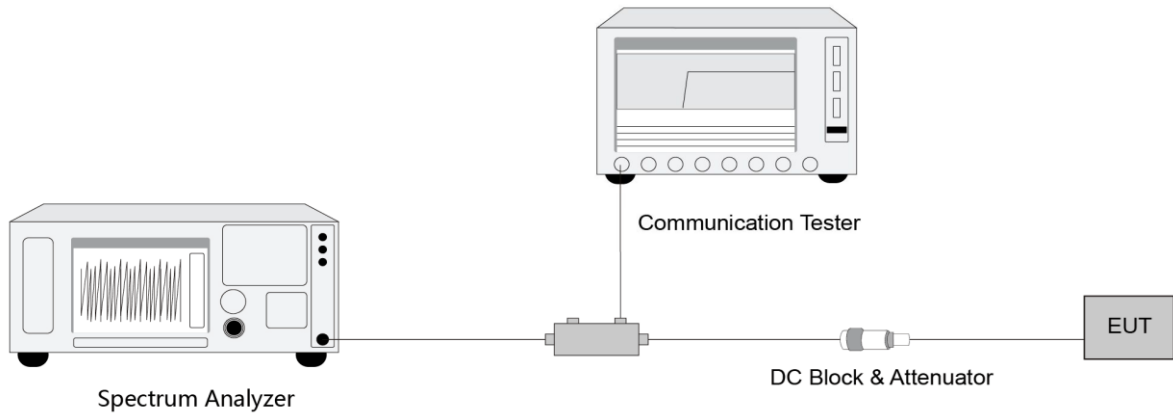

5.7.5. Test Result

Refer to Appendix A.6.

5.8. Radiated Spurious Emissions Measurement

5.8.1. Test Limit

Out of band emissions: The power of any emission outside of the authorized operating frequency ranges must be attenuated below the transmitting power (P) by a factor of at least $43 + 10 \log(P)$ dB. The emission limit equal to -13dBm.

For mobile digital stations, the attenuation factor shall be not less than $40 + 10 \log(P)$ dB on all frequencies between the channel edge and 5 megahertz from the channel edge, $43 + 10 \log(P)$ dB on all frequencies between 5 megahertz and X megahertz from the channel edge, and $55 + 10 \log(P)$ dB on all frequencies more than X megahertz from the channel edge, where X is the greater of 6 megahertz or the actual emission bandwidth.

E (dB μ V/m) = EIRP (dBm) - $20 \log D$ + 104.8; where D is the measurement distance in meters. The emission limit equal to 82.3dB μ V/m or 70.3dB μ V/m.

5.8.2. Test Procedure

ANSI C63.26-2015 - Section 5.2.7 & 5.5

5.8.3. Test Setting

1. RBW = 1MHz
2. VBW $\geq 3 \times$ RBW
3. Sweep time $\geq 10 \times$ (number of points in sweep) \times (transmission symbol period)
4. Detector = Peak
5. Trace mode = max hold
6. The trace was allowed to stabilize

5.8.4. Test Setup

Below 1GHz Test Setup:

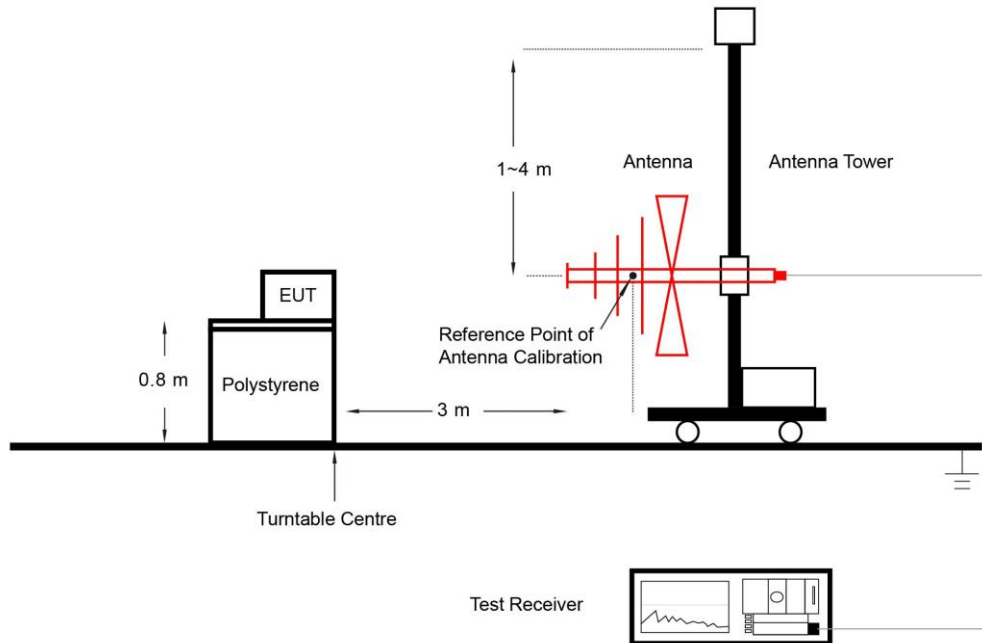

Above 1GHz Test Setup:

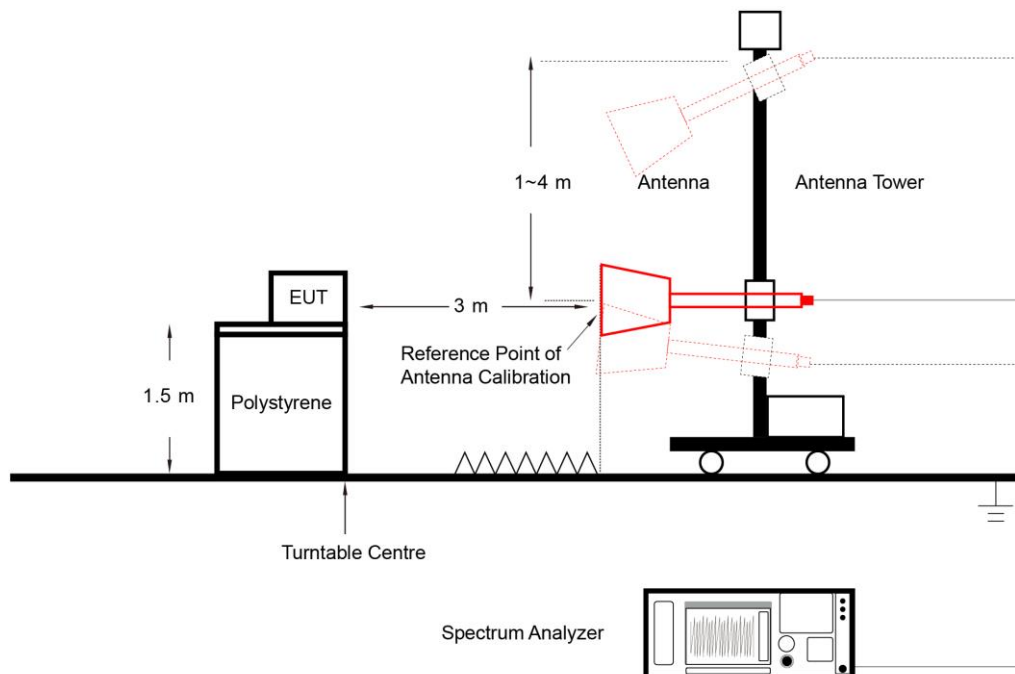

5.8.5. Test Result

Refer to Appendix A.7.

Appendix A - Test Result

A.1 Occupied Bandwidth Test Result

Test Site	WZ-SR6	Test Engineer	Cloud Guo
Test Date	2023-04-13	Test Band	n41_UL MIMO

Frequency (MHz)	Bandwidth (MHz)	99% Bandwidth (MHz)
QPSK		
2592.99	20	18.22
2592.99	30	27.83
2592.99	40	37.76
2592.99	50	47.43
2592.99	60	57.71
2592.99	70	67.36
2592.99	80	77.28
2592.99	90	87.34
2592.99	100	97.26
16QAM		
2592.99	20	18.22
2592.99	30	27.85
2592.99	40	38.01
2592.99	50	47.48
2592.99	60	57.71
2592.99	70	67.33
2592.99	80	77.37
2592.99	90	87.29
2592.99	100	97.30

64QAM		
2592.99	20	18.25
2592.99	30	27.86
2592.99	40	37.75
2592.99	50	47.51
2592.99	60	57.78
2592.99	70	67.39
2592.99	80	77.40
2592.99	90	87.31
2592.99	100	97.20
256QAM		
2592.99	20	18.19
2592.99	30	27.83
2592.99	40	37.75
2592.99	50	47.51
2592.99	60	57.78
2592.99	70	67.40
2592.99	80	77.32
2592.99	90	87.35
2592.99	100	97.40

99% Bandwidth - QPSK

20MHz Channel Bandwidth

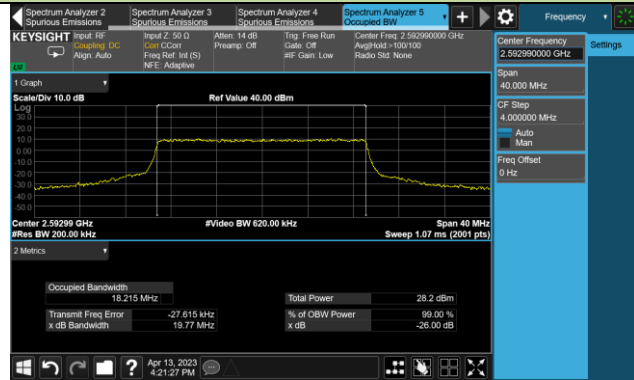

30MHz Channel Bandwidth

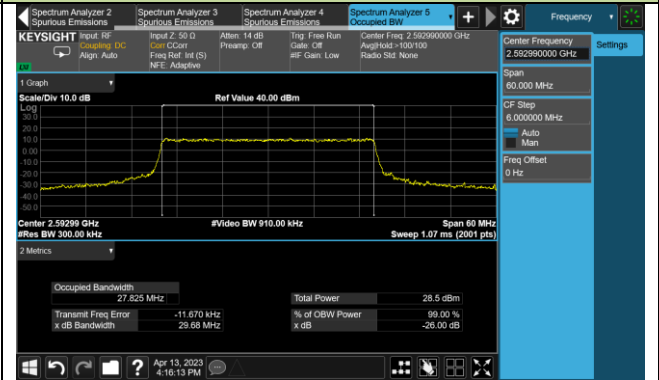

40MHz Channel Bandwidth

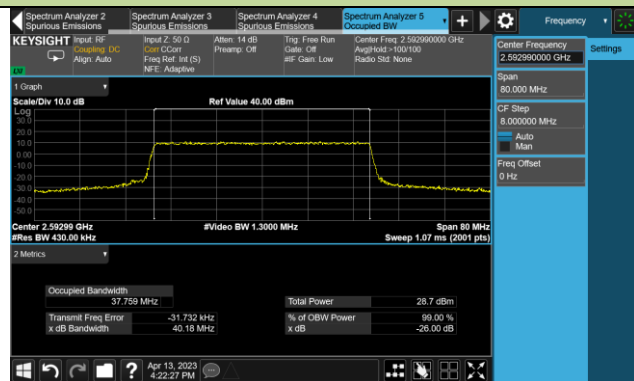

50MHz Channel Bandwidth

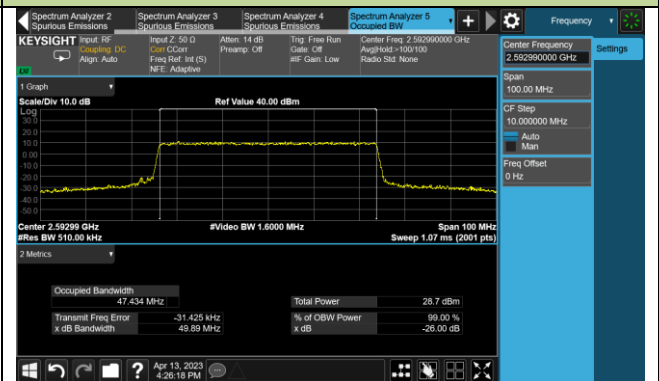

60MHz Channel Bandwidth

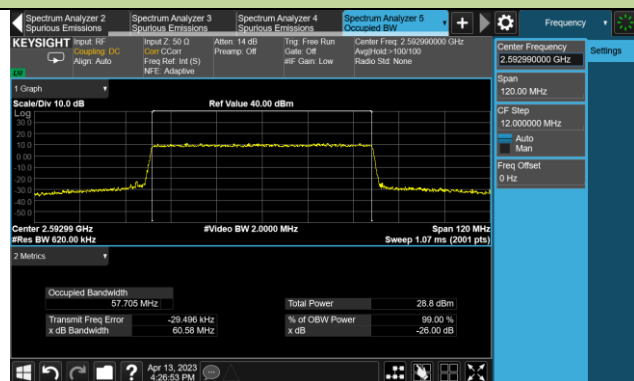

70MHz Channel Bandwidth

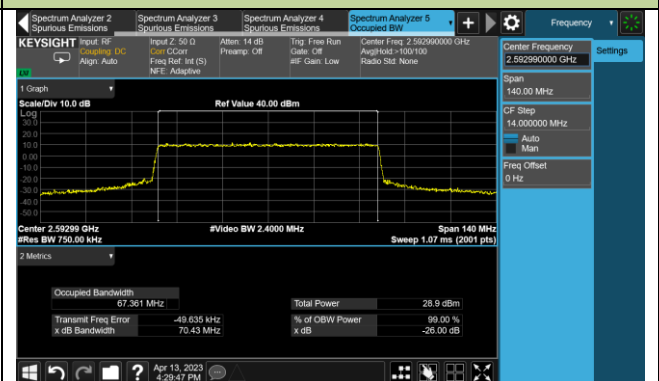

80MHz Channel Bandwidth

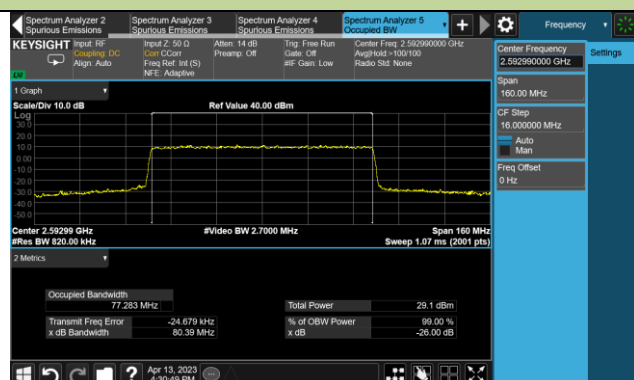

90MHz Channel Bandwidth

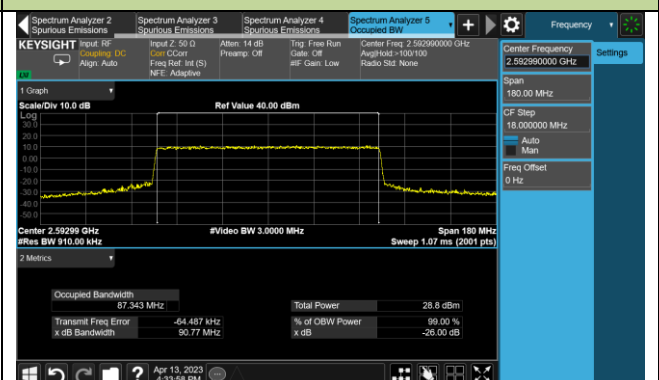



99% Bandwidth - 16QAM

20MHz Channel Bandwidth

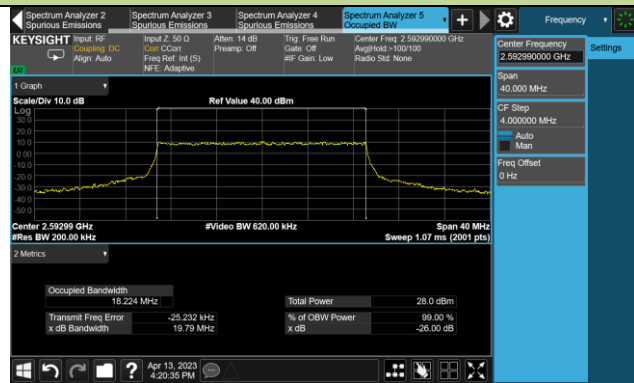

30MHz Channel Bandwidth

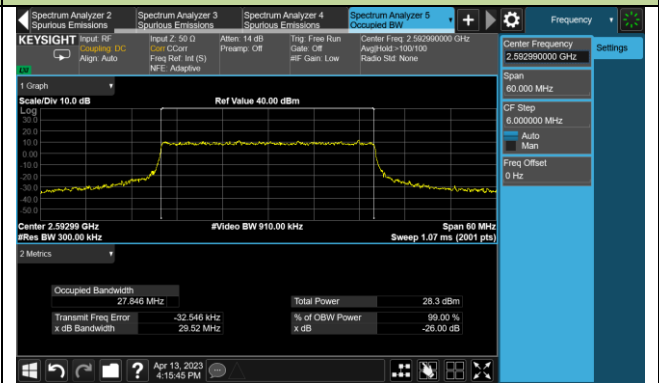

40MHz Channel Bandwidth

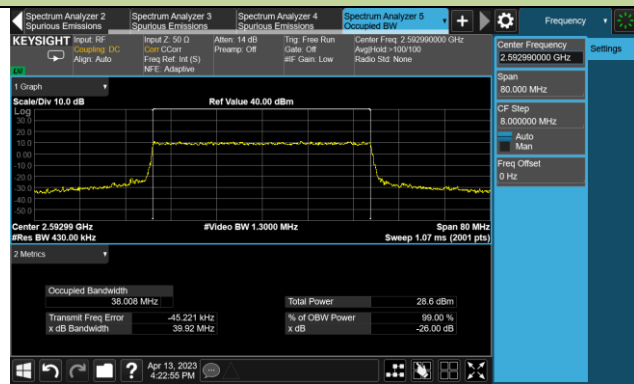

50MHz Channel Bandwidth

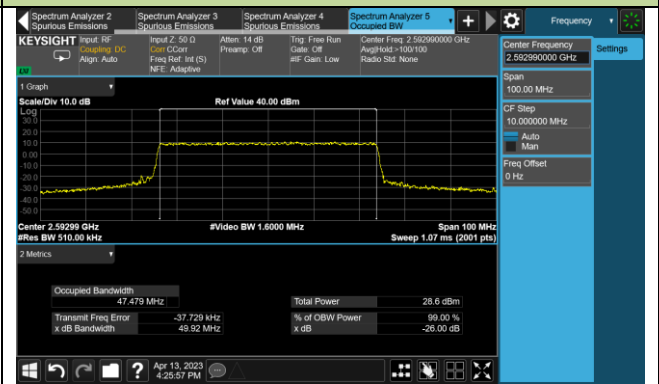

60MHz Channel Bandwidth

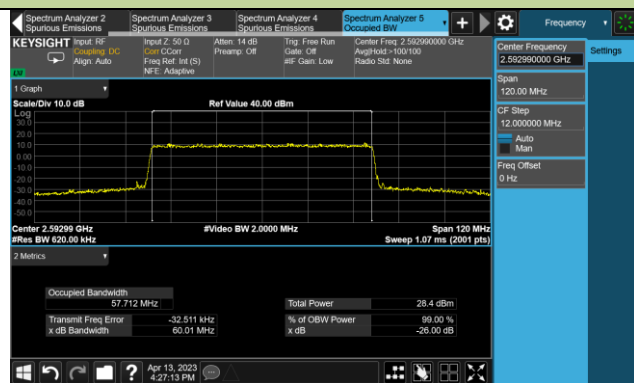

70MHz Channel Bandwidth

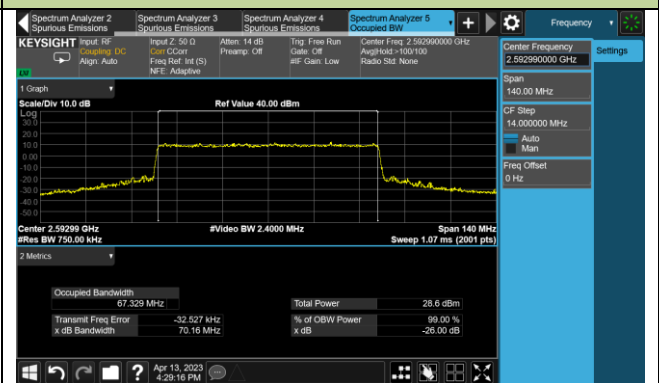

80MHz Channel Bandwidth

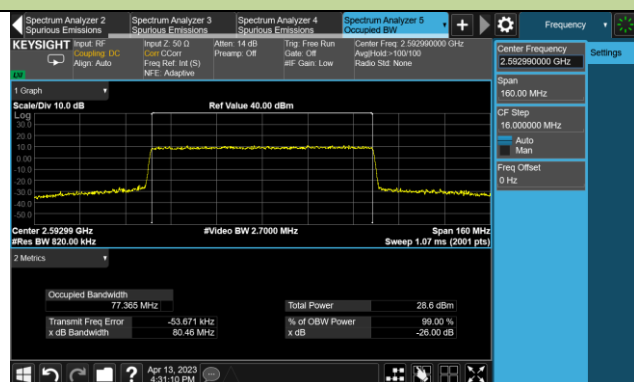

90MHz Channel Bandwidth

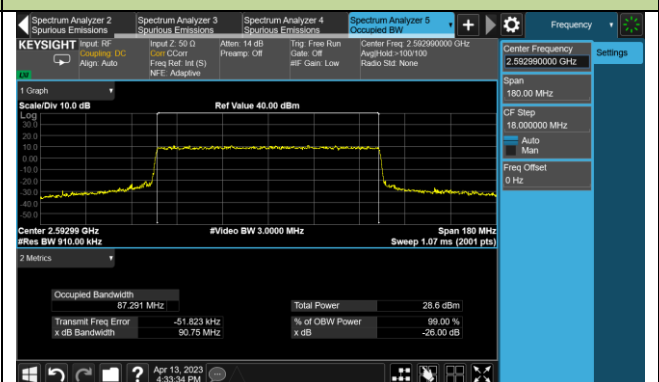



99% Bandwidth - 64QAM

20MHz Channel Bandwidth

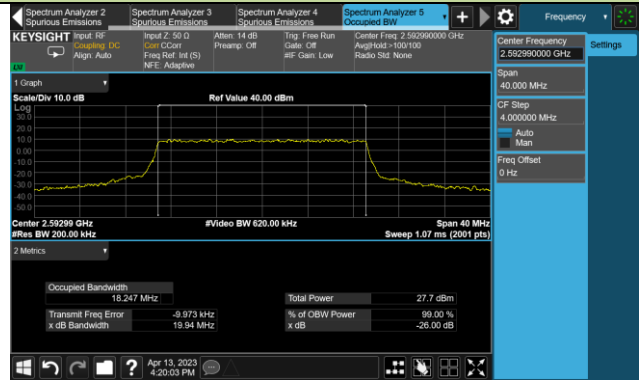

30MHz Channel Bandwidth

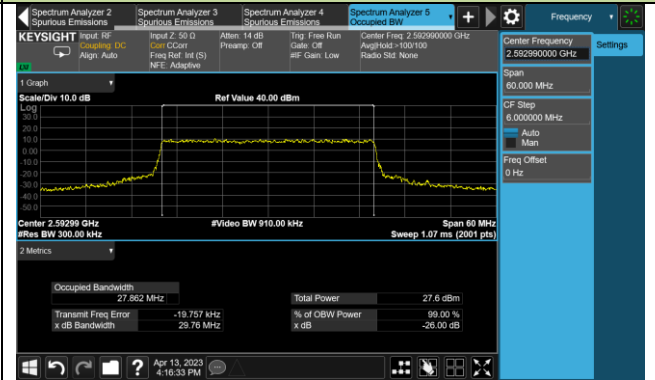

40MHz Channel Bandwidth

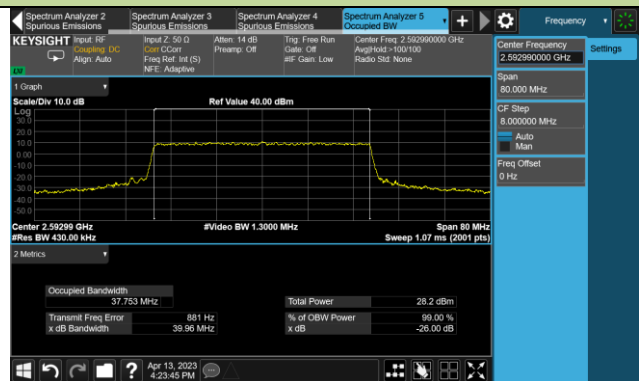

50MHz Channel Bandwidth

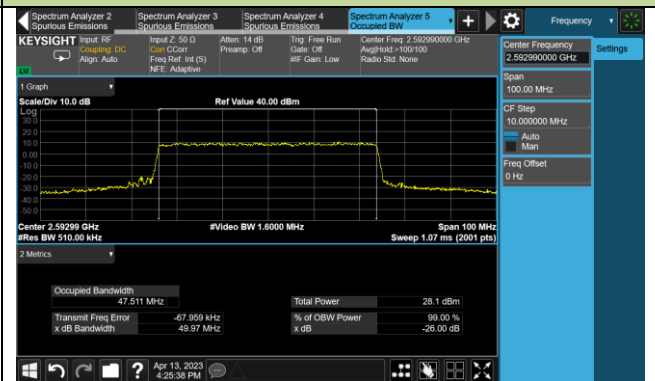

60MHz Channel Bandwidth

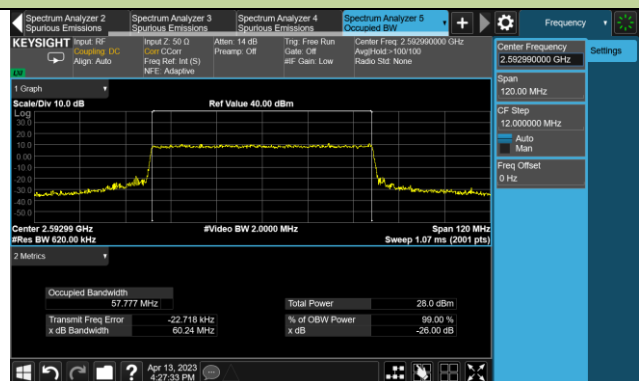

70MHz Channel Bandwidth

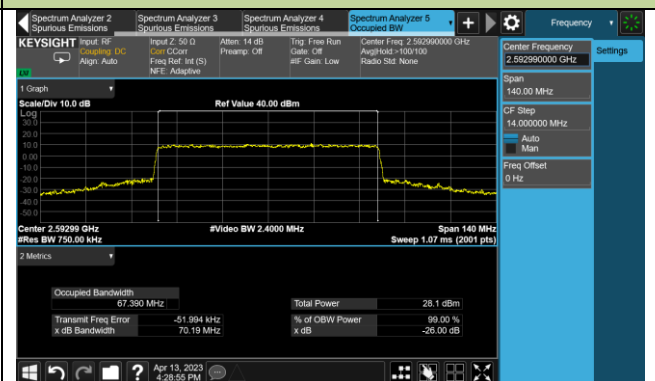

80MHz Channel Bandwidth

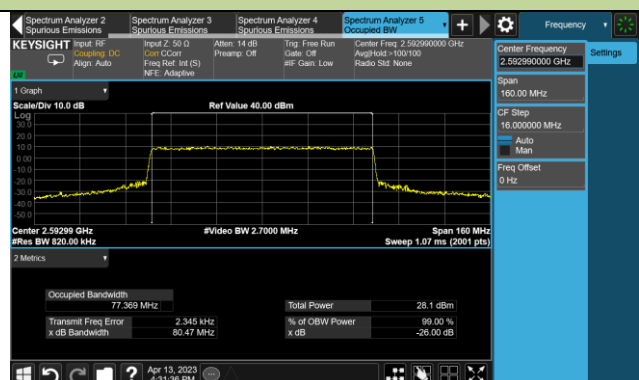

90MHz Channel Bandwidth

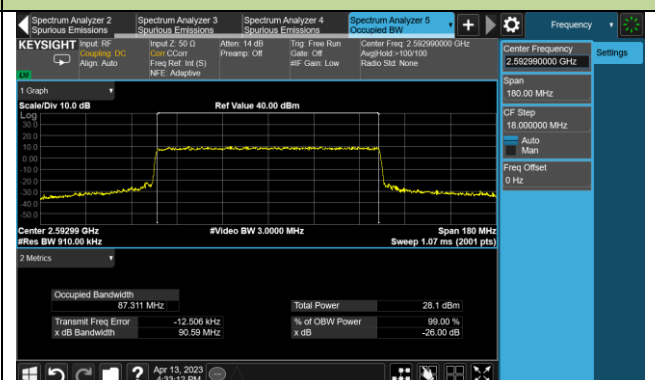

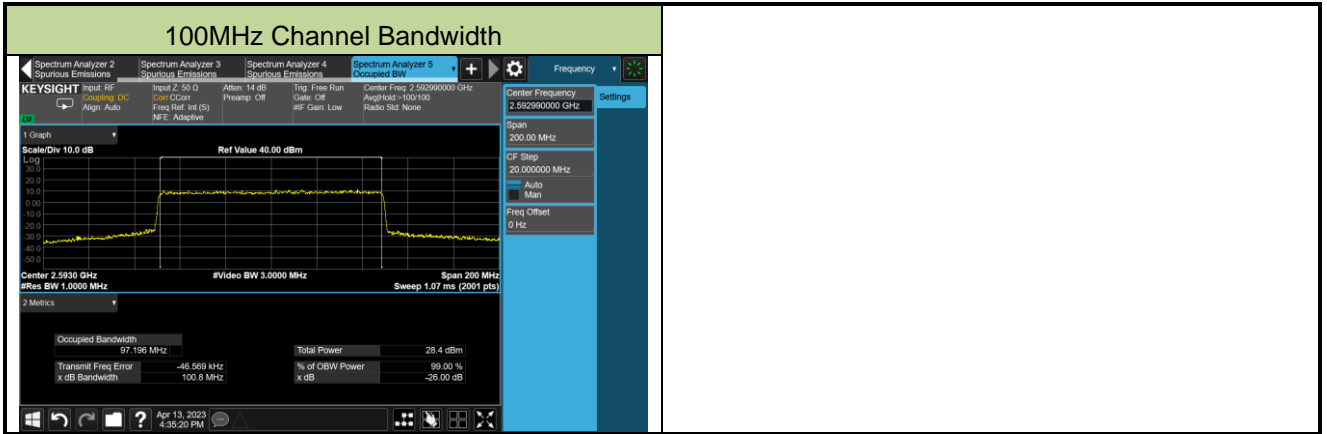

99% Bandwidth - 256QAM

20MHz Channel Bandwidth

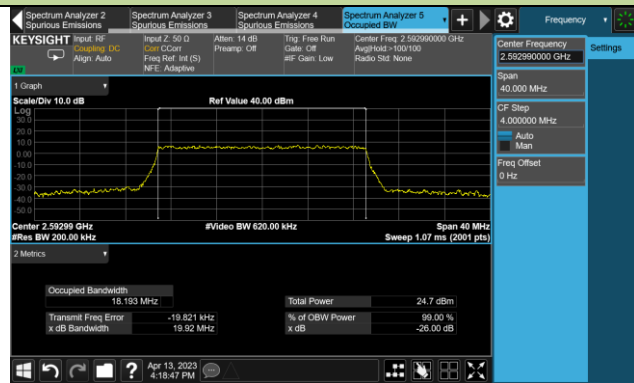

30MHz Channel Bandwidth

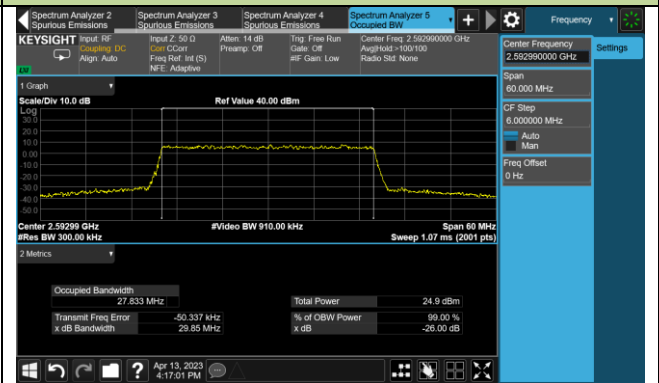

40MHz Channel Bandwidth

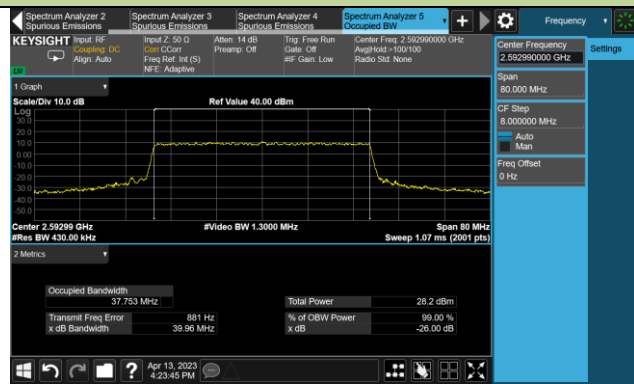

50MHz Channel Bandwidth

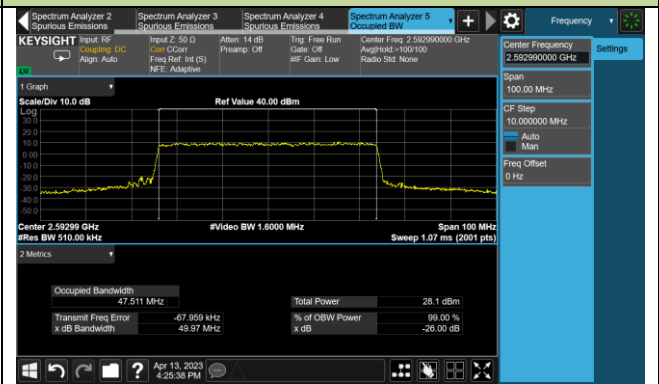

60MHz Channel Bandwidth

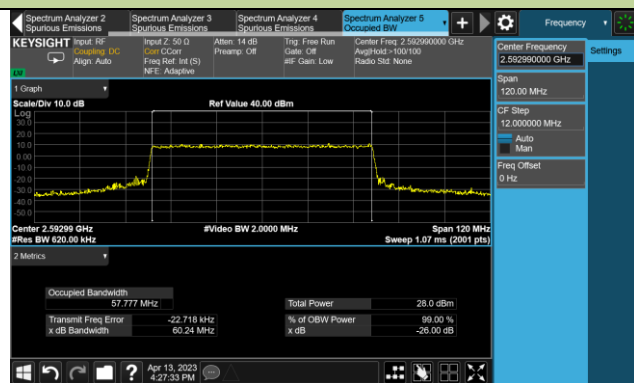

70MHz Channel Bandwidth

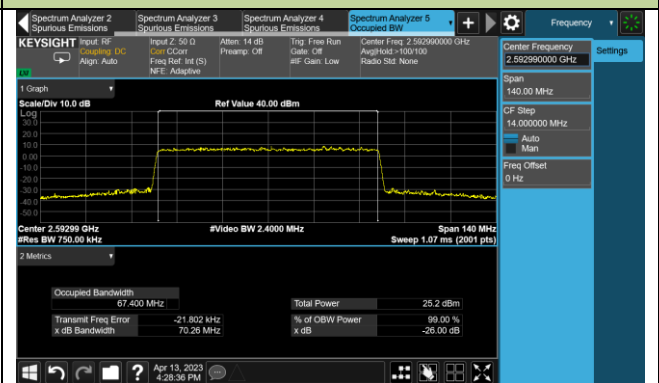

80MHz Channel Bandwidth

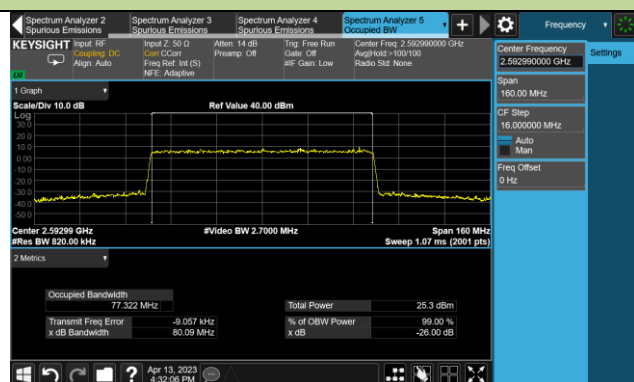

90MHz Channel Bandwidth

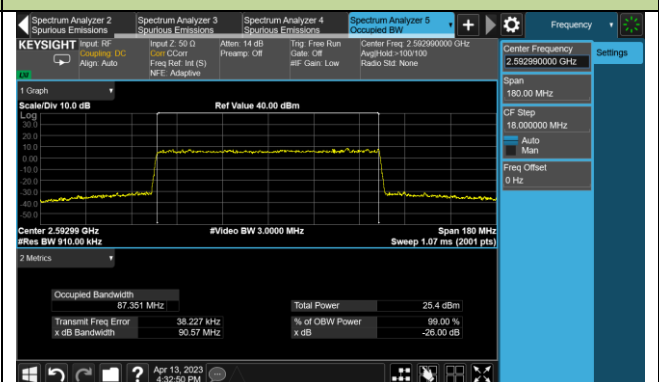



Test Site	WZ-SR6	Test Engineer	Cloud Guo
Test Date	2023-04-13	Test Band	n77/n78_UL MIMO (3450 ~ 3550MHz)

Frequency (MHz)	Bandwidth (MHz)	99% Bandwidth (MHz)
QPSK		
3500.01	10	8.62
3500.01	15	13.56
3500.01	20	18.23
3500.01	30	27.85
3500.01	40	37.76
3500.01	50	47.38
3500.01	60	57.73
3500.01	70	67.43
3500.01	80	77.31
3500.01	90	87.40
3500.01	100	97.32
16QAM		
3500.01	10	8.62
3500.01	15	13.62
3500.01	20	18.21
3500.01	30	27.83
3500.01	40	37.94
3500.01	50	47.42
3500.01	60	57.71
3500.01	70	67.39
3500.01	80	77.35
3500.01	90	87.31
3500.01	100	97.39

64QAM		
3500.01	10	8.65
3500.01	15	13.60
3500.01	20	18.21
3500.01	30	27.86
3500.01	40	37.75
3500.01	50	47.49
3500.01	60	57.81
3500.01	70	67.35
3500.01	80	77.37
3500.01	90	87.33
3500.01	100	97.32
256QAM		
3500.01	10	8.59
3500.01	15	13.57
3500.01	20	18.17
3500.01	30	27.84
3500.01	40	37.95
3500.01	50	47.48
3500.01	60	57.72
3500.01	70	67.42
3500.01	80	77.36
3500.01	90	87.46
3500.01	100	97.33

99% Bandwidth - QPSK

10MHz Channel Bandwidth

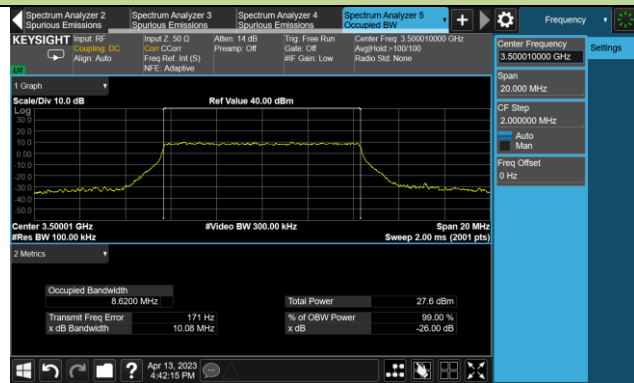

15MHz Channel Bandwidth

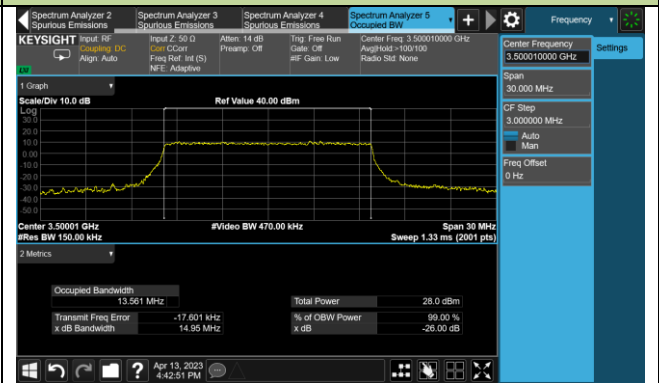

20MHz Channel Bandwidth

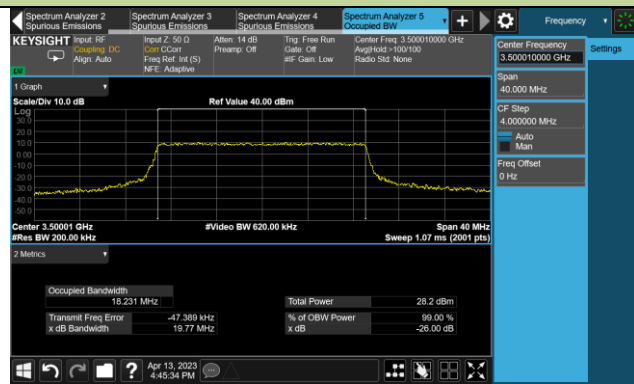

30MHz Channel Bandwidth

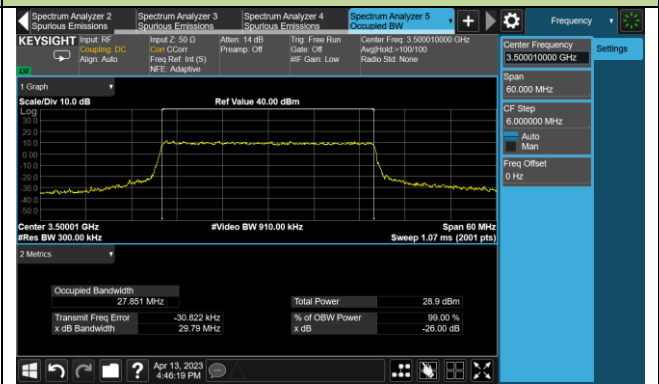

40MHz Channel Bandwidth

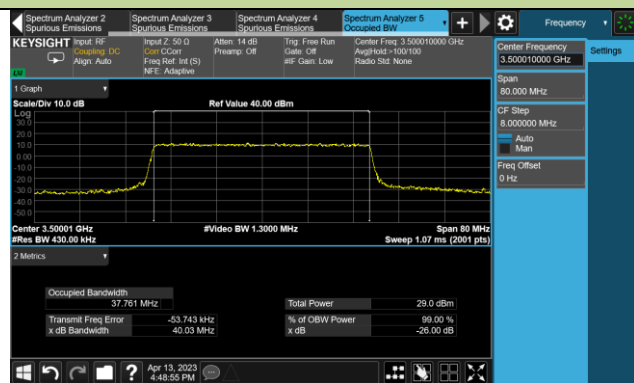

50MHz Channel Bandwidth

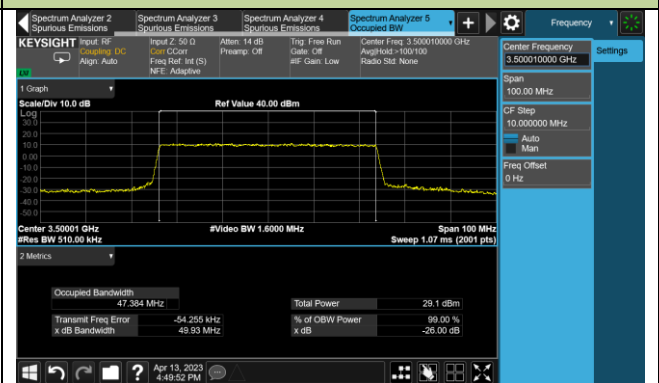

60MHz Channel Bandwidth

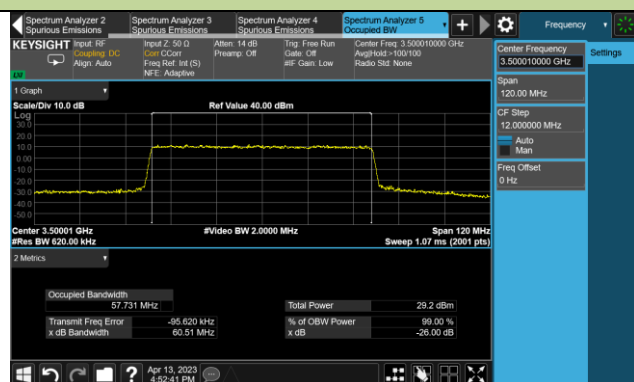

70MHz Channel Bandwidth

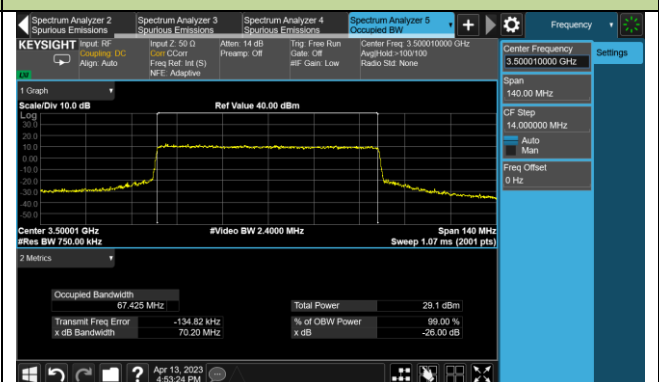

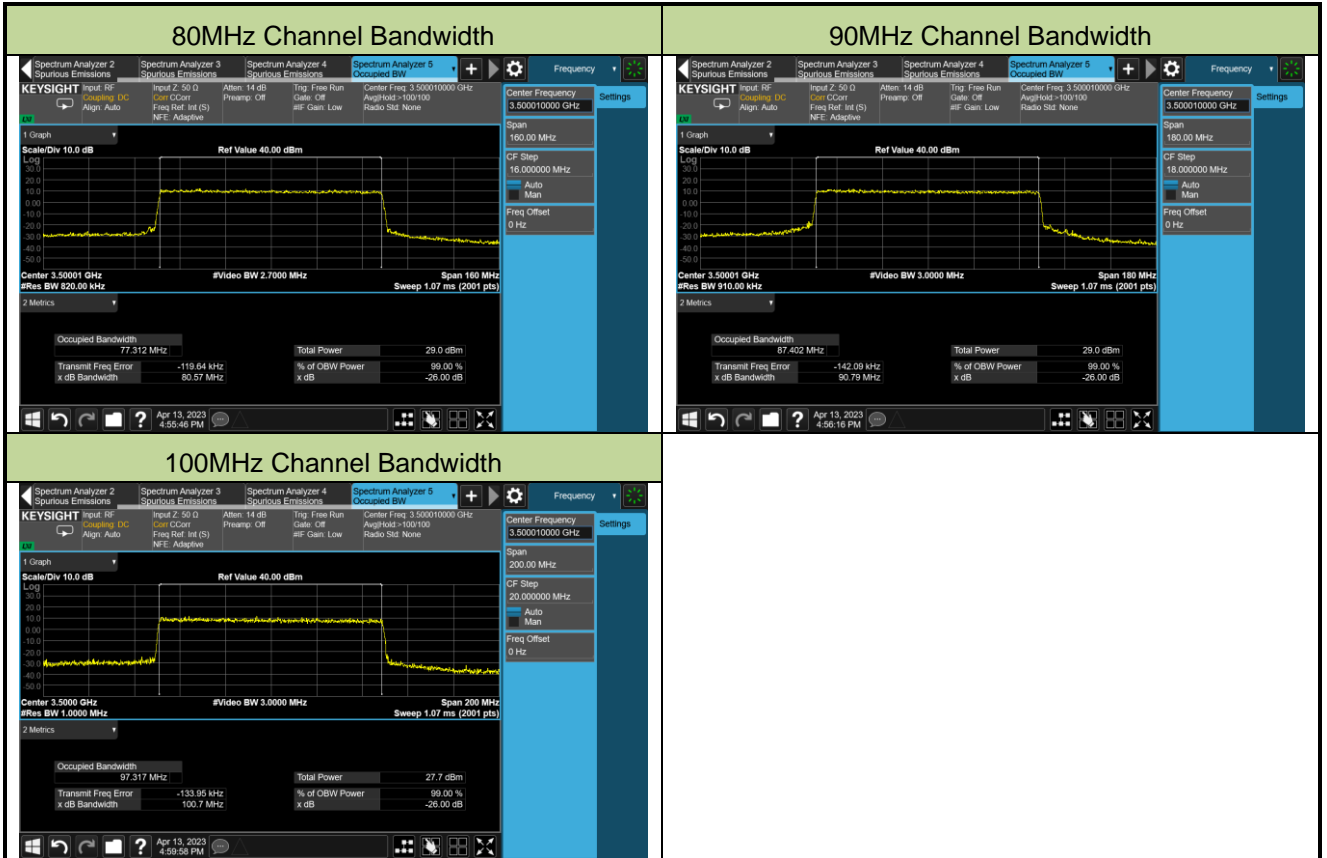

99% Bandwidth - 16QAM

10MHz Channel Bandwidth

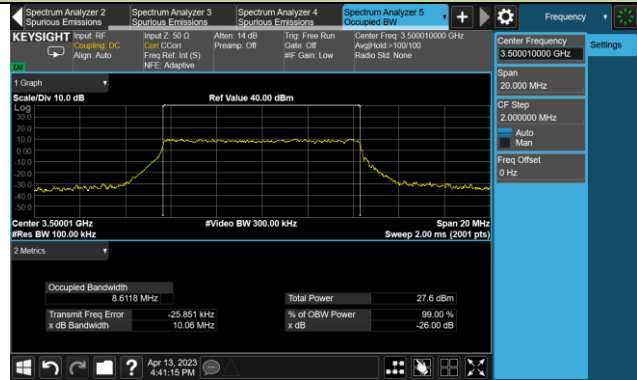

15MHz Channel Bandwidth

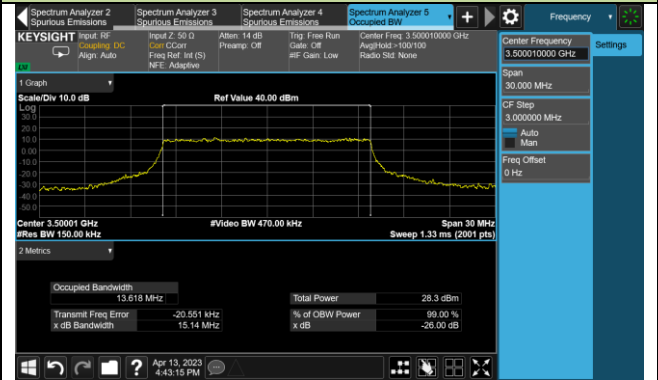

20MHz Channel Bandwidth

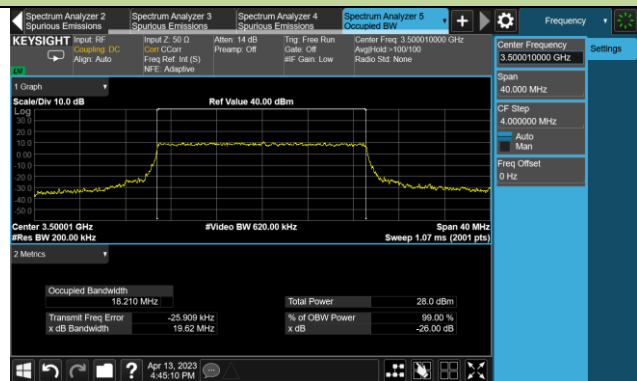

30MHz Channel Bandwidth

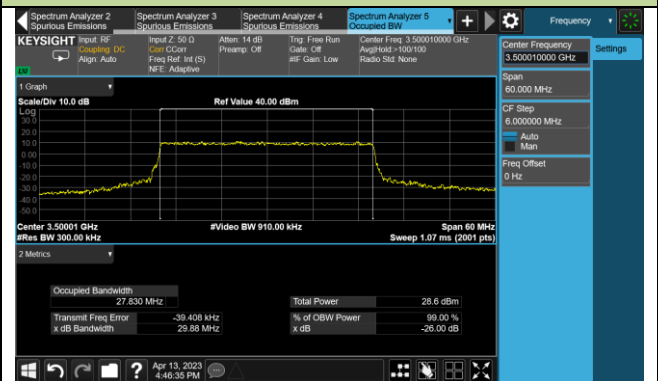

40MHz Channel Bandwidth

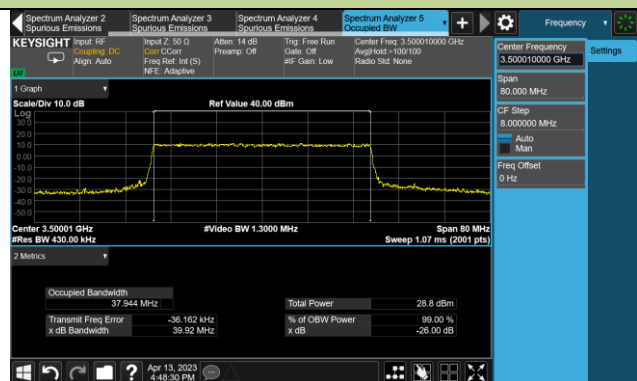

50MHz Channel Bandwidth

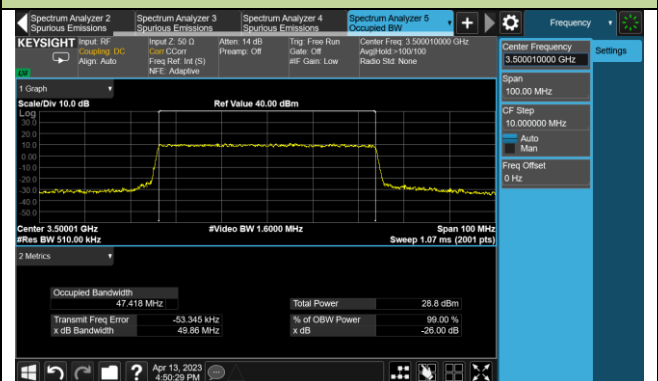

60MHz Channel Bandwidth

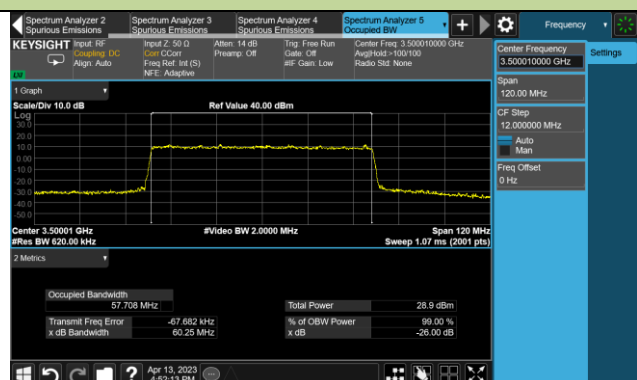

70MHz Channel Bandwidth

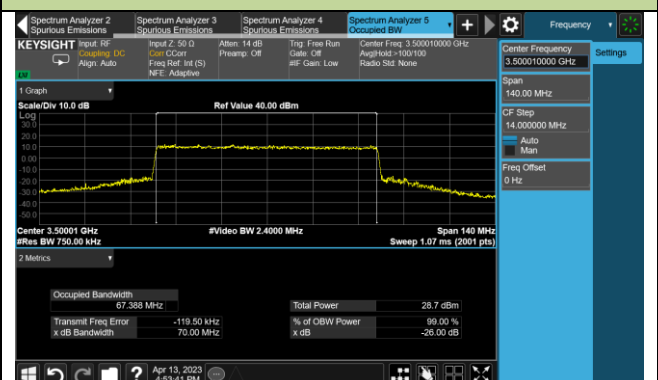

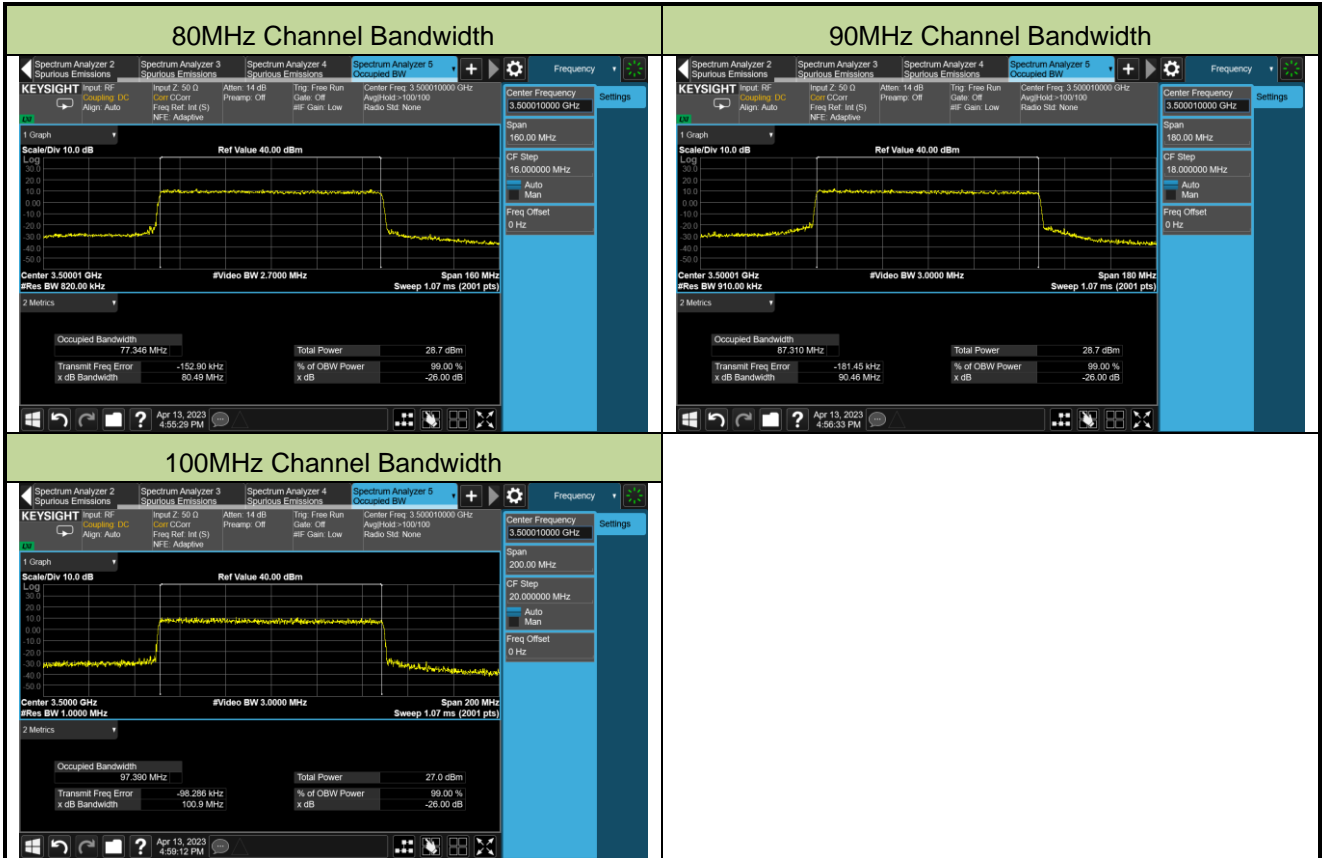

99% Bandwidth - 64QAM

10MHz Channel Bandwidth

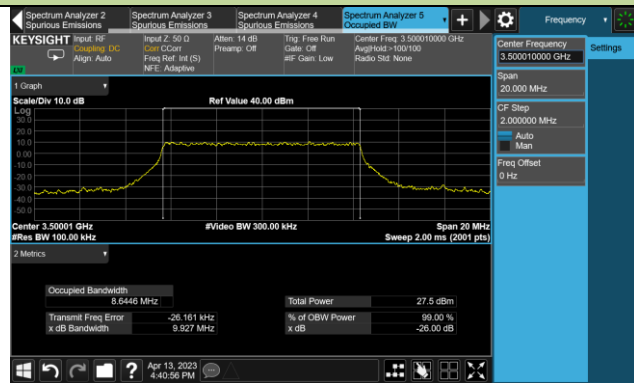

15MHz Channel Bandwidth

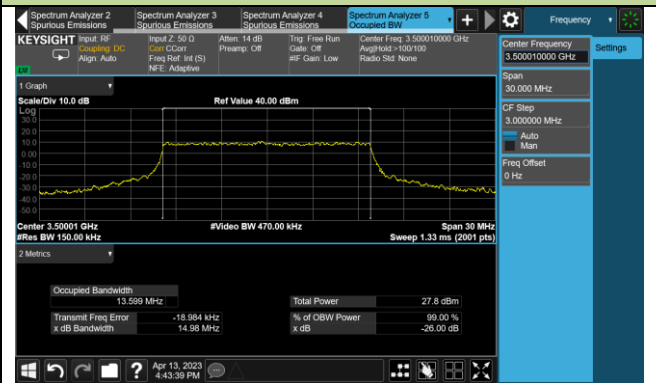

20MHz Channel Bandwidth

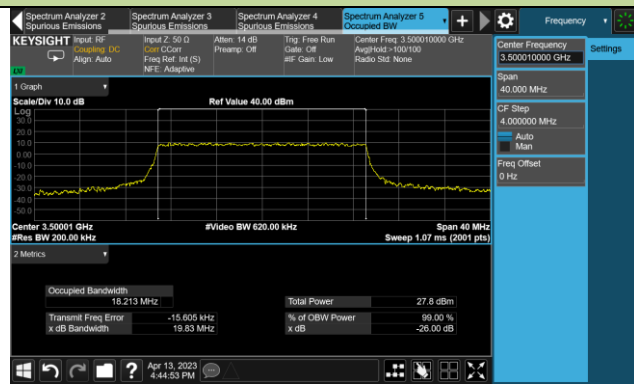

30MHz Channel Bandwidth

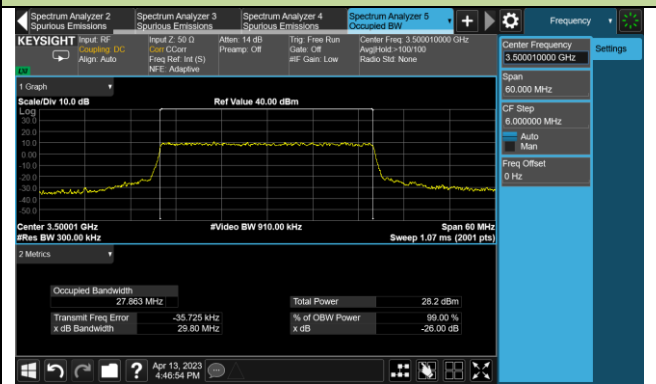

40MHz Channel Bandwidth

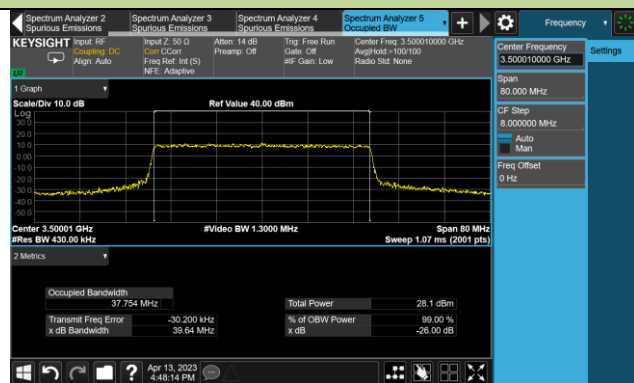

50MHz Channel Bandwidth

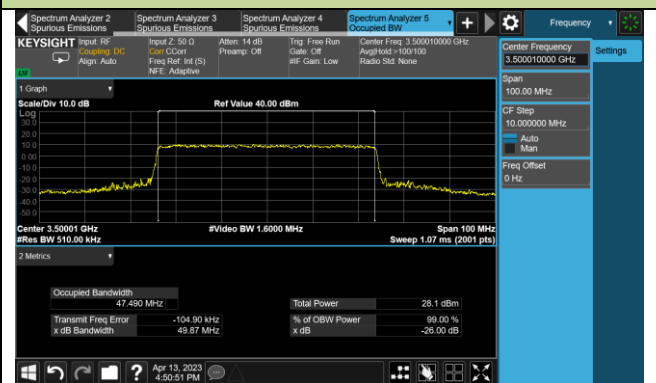

60MHz Channel Bandwidth

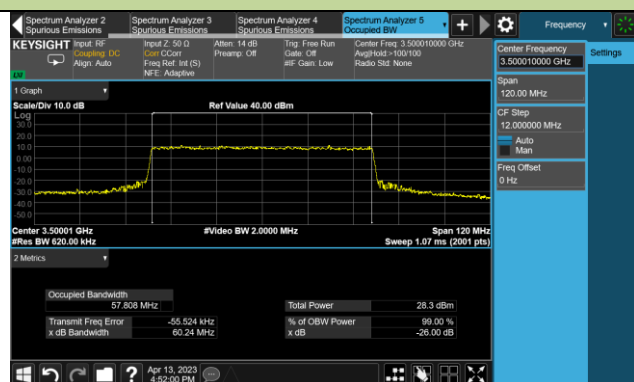

70MHz Channel Bandwidth

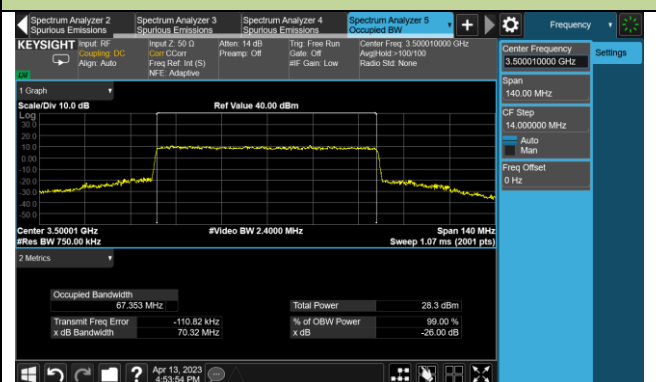

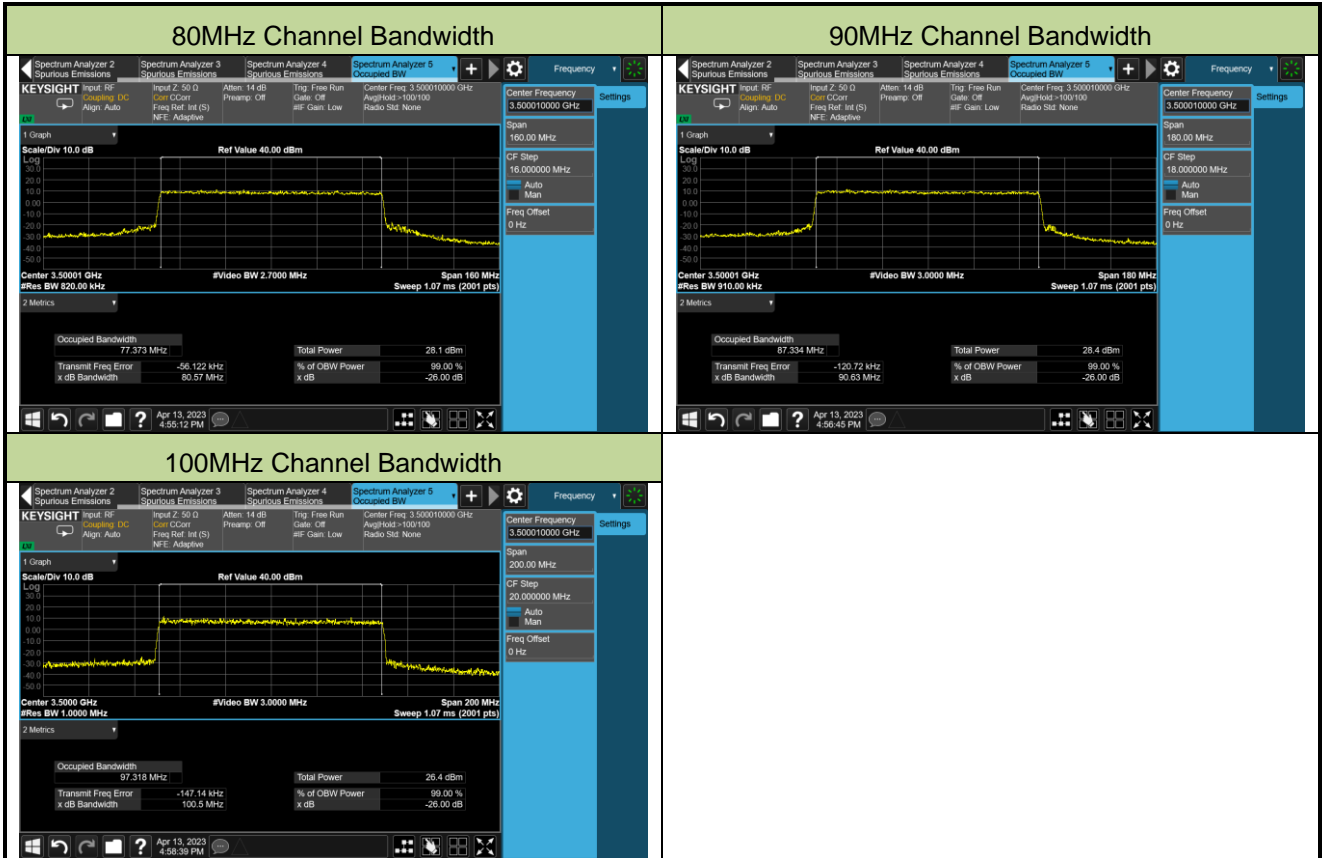

99% Bandwidth - 256QAM

10MHz Channel Bandwidth

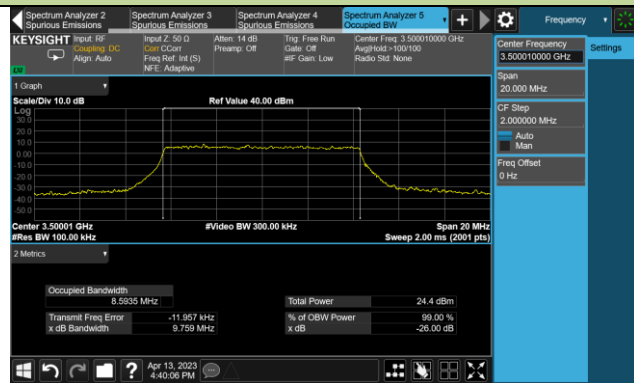

15MHz Channel Bandwidth

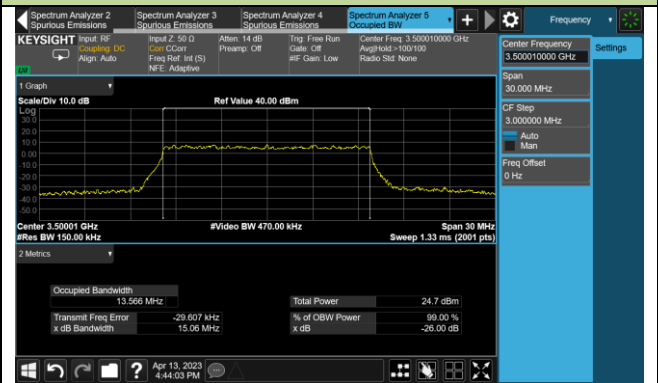

20MHz Channel Bandwidth

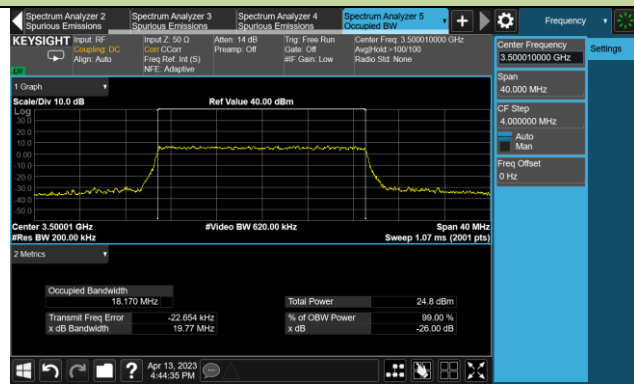

30MHz Channel Bandwidth

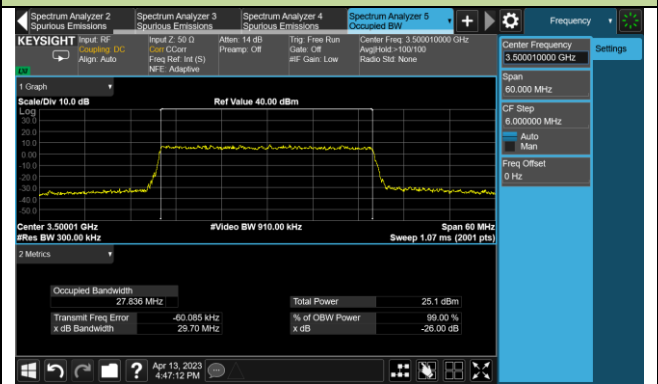

40MHz Channel Bandwidth

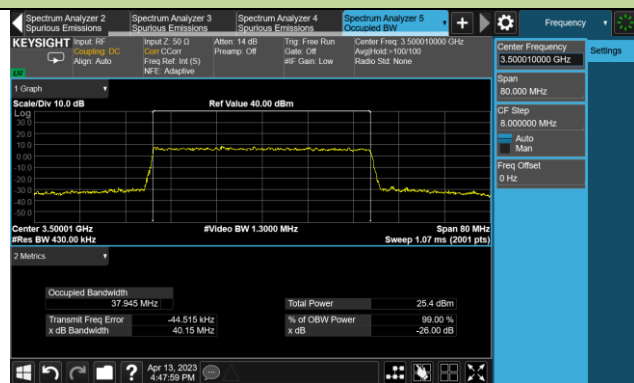

50MHz Channel Bandwidth

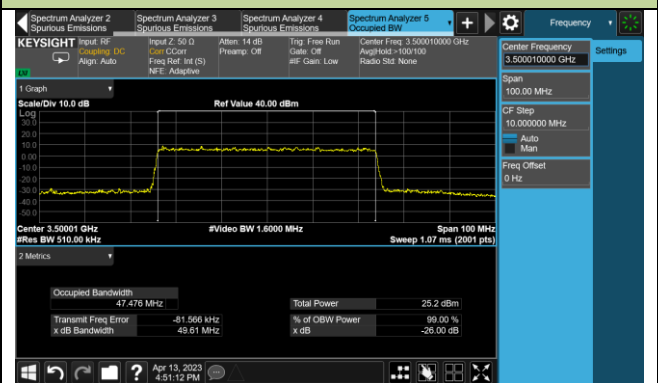

60MHz Channel Bandwidth

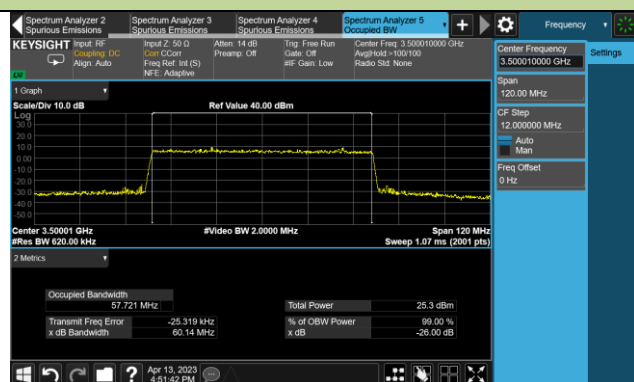

70MHz Channel Bandwidth

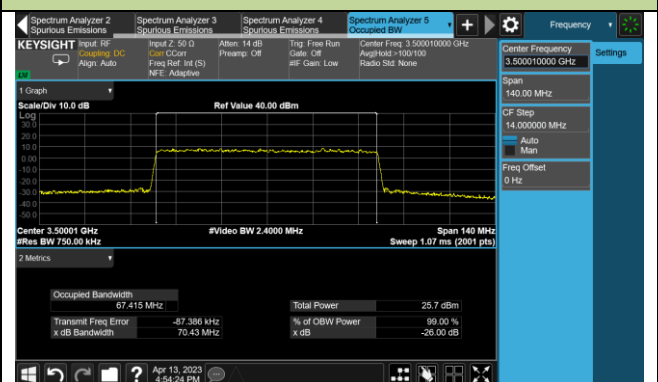

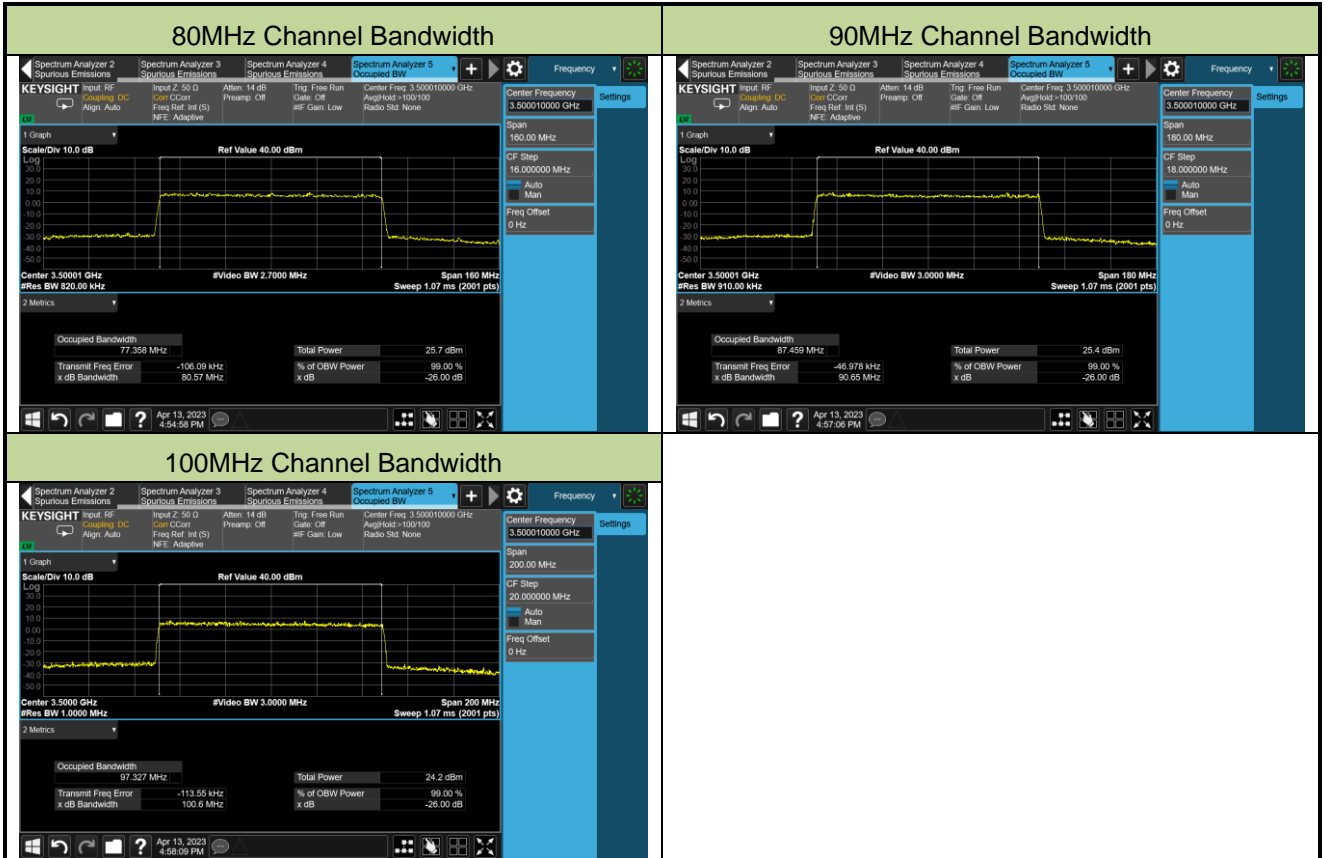

Test Site	WZ-SR6	Test Engineer	Cloud Guo
Test Date	2023-04-13	Test Band	n77/n78_UL MIMO (3700 ~ 3980MHz)

Frequency (MHz)	Bandwidth (MHz)	99% Bandwidth (MHz)
QPSK		
3840.00	10	8.60
3840.00	15	13.58
3840.00	20	18.21
3840.00	30	27.85
3840.00	40	37.73
3840.00	50	47.40
3840.00	60	57.75
3840.00	70	67.35
3840.00	80	77.40
3840.00	90	87.35
3840.00	100	97.28
16QAM		
3840.00	10	8.57
3840.00	15	13.58
3840.00	20	18.17
3840.00	30	28.83
3840.00	40	37.81
3840.00	50	47.49
3840.00	60	57.61
3840.00	70	67.38
3840.00	80	77.39
3840.00	90	87.20
3840.00	100	97.36

64QAM		
3840.00	10	8.58
3840.00	15	13.55
3840.00	20	18.20
3840.00	30	27.81
3840.00	40	37.77
3840.00	50	47.53
3840.00	60	57.71
3840.00	70	67.42
3840.00	80	77.35
3840.00	90	87.31
3840.00	100	97.31
256QAM		
3840.00	10	8.59
3840.00	15	13.55
3840.00	20	18.17
3840.00	30	27.83
3840.00	40	37.83
3840.00	50	47.31
3840.00	60	57.69
3840.00	70	67.39
3840.00	80	77.48
3840.00	90	87.47
3840.00	100	97.34