



# FCC RF Test Report

**APPLICANT** : Quectel Wireless Solutions Co., Ltd.  
**EQUIPMENT** : 5G Sub-6 GHz LGA Module  
**BRAND NAME** : Quectel  
**MODEL NAME** : RG500L-NA  
**FCC ID** : XMR2023RG500LNA  
**STANDARD** : 47 CFR Part 2, 90(R)  
**CLASSIFICATION** : PCS Licensed Transmitter (PCB)  
**TEST DATE(S)** : Jan. 21, 2023 ~ Mar. 20, 2023

We, Sporton International Inc. (Kunshan), would like to declare that the tested sample has been evaluated in accordance with the procedures given in ANSI C63.26-2015 and shown compliance with the applicable technical standards.

The test results in this report apply exclusively to the tested model / sample. Without written approval of Sporton International Inc. (Kunshan), the test report shall not be reproduced except in full.

Jason Jia

Approved by: Jason Jia



**Sporton International Inc. (Kunshan)**

**No. 1098, Pengxi North Road, Kunshan Economic Development Zone Jiangsu Province 215300  
People's Republic of China**



TABLE OF CONTENTS

REVISION HISTORY.....3
SUMMARY OF TEST RESULT .....4
1 GENERAL DESCRIPTION .....5
1.1 Applicant.....5
1.2 Manufacturer.....5
1.3 Feature of Equipment Under Test.....5
1.4 Maximum Conducted Power and Emission Designator .....6
1.5 Testing Site.....6
1.6 Test Software.....6
1.7 Applied Standards .....6
2 TEST CONFIGURATION OF EQUIPMENT UNDER TEST.....7
2.1 Test Mode.....7
2.2 Connection Diagram of Test System.....8
2.3 Support Unit used in test configuration and system.....8
2.4 Measurement Results Explanation Example.....8
3 CONDUCTED TEST ITEMS .....9
3.1 Measuring Instruments .....9
3.2 Conducted Output Power and ERP .....10
3.3 Peak-to-Average Ratio .....11
3.4 Occupied Bandwidth.....12
3.5 Conducted Band Edge Measurement .....13
3.6 Emission Mask.....14
3.7 Conducted Spurious Emission Measurement .....15
3.8 Frequency Stability Measurement .....16
4 RADIATED TEST ITEMS .....17
4.1 Measuring Instruments .....17
4.2 Test Setup .....17
4.3 Test Result of Radiated Test .....18
4.4 Radiated Spurious Emission Measurement .....19
5 LIST OF MEASURING EQUIPMENT .....20
6 UNCERTAINTY OF EVALUATION .....21
APPENDIX A. TEST RESULTS OF CONDUCTED TEST
APPENDIX B. TEST RESULTS OF RADIATED TEST
APPENDIX C. TEST SETUP PHOTOGRAPHS



## REVISION HISTORY

REPORT NO.	VERSION	DESCRIPTION	ISSUED DATE
FG2D0201C	Rev. 01	Initial issue of report	Jun. 02, 2023



### SUMMARY OF TEST RESULT

Report Section	FCC Rule	Description	Limit	Result	Remark
3.2	§2.1046	Conducted Output Power	—	Reporting only	-
	§90.542 (a)(7)	Effective Radiated Power	ERP < 3Watt	PASS	-
3.3	-	Peak-to-Average Ratio	—	Reporting only	-
3.4	§2.1049	Occupied Bandwidth	—	Reporting only	-
3.5	§2.1053 §90.543 (e)(2)(3)	Conducted Band Edge Measurement	Refer standard	PASS	-
3.6	§2.1051 §90.210(n)	Emission Mask	Mask B	PASS	-
3.7	§2.1053 §90.543 (e)(3)	Conducted Spurious Emission	< 43+10log <sub>10</sub> (P[Watts])	PASS	-
3.8	§2.1055 §90.539 (e)	Frequency Stability Temperature & Voltage	< ±1.25 ppm	PASS	-
4.4	§2.1053 §90.543 (e)(3) §90.543 (f)	Radiated Spurious Emission	< 43+10log <sub>10</sub> (P[Watts])	PASS	Under limit 16.02 dB at 1584.00 MHz

**Declaration of Conformity:**  
The test results with all measurement uncertainty excluded are presented in accordance with the regulation limits or requirements declared by manufacturers.

**Comments and Explanations:**  
The declared of product specification for EUT presented in the report are provided by the manufacturer, and the manufacturer takes all the responsibilities for the accuracy of product specification.

# 1 General Description

## 1.1 Applicant

**Quectel Wireless Solutions Co., Ltd.**

Building 5, Shanghai Business Park Phase III (Area B), No.1016 Tianlin Road, Minhang District, Shanghai, 200233,China

## 1.2 Manufacturer

**Quectel Wireless Solutions Co., Ltd.**

Building 5, Shanghai Business Park Phase III (Area B), No.1016 Tianlin Road, Minhang District, Shanghai, 200233,China

## 1.3 Feature of Equipment Under Test

Product Feature	
Equipment	5G Sub-6 GHz LGA Module
Brand Name	Quectel
Model Name	RG500L-NA
FCC ID	XMR2023RG500LNA
Tx Frequency	LTE Band 14: 788 MHz ~ 798 MHz
Rx Frequency	LTE Band 14: 758 MHz ~ 768 MHz
Bandwidth	5MHz / 10MHz
Maximum Output Power to Antenna	22.55 dBm
Antenna Gain	<b>Ant 7:</b> LTE Band 14 : -10.95 dBi
Type of Modulation	QPSK / 16QAM / 64QAM/ 256QAM
IMEI Code	Conducted: 860815050004316 Radiation: 860815050004233
HW Version	R1.0
SW Version	RG500LNAAAR04A02E32_OCPU
EUT Stage	Identical Prototype

**Remark:** The above EUT's information was declared by manufacturer. Please refer to the specifications or user's manual for more detailed description.

### 1.4 Maximum Conducted Power and Emission Designator

LTE Band 14		QPSK		16QAM/64QAM/256QAM	
BW (MHz)	Frequency Range (MHz)	Maximum Conducted power (W)	Emission Designator (99%OBW)	Maximum Conducted power (W)	Emission Designator (99%OBW)
5	790.5~795.5	0.1786	4M49G7D	0.1387	4M50W7D
10	793	0.1799	9M01G7D	0.1462	8M97W7D

### 1.5 Testing Site

Sporton International Inc. (Kunshan) is accredited to ISO/IEC 17025:2017 by American Association for Laboratory Accreditation with Certificate Number 5145.02.

<b>Test Firm</b>	Sporton International Inc. (Kunshan)		
<b>Test Site Location</b>	No. 1098, Pengxi North Road, Kunshan Economic Development Zone Jiangsu Province 215300 People's Republic of China TEL : +86-512-57900158		
<b>Test Site No.</b>	<b>Sporton Site No.</b>	<b>FCC Designation No.</b>	<b>FCC Test Firm Registration No.</b>
	03CH04-KS TH01-KS	CN1257	314309

### 1.6 Test Software

Item	Site	Manufacturer	Name	Version
1.	03CH04-KS	AUDIX	E3	6.2009-8-24a

### 1.7 Applied Standards

According to the specifications of the manufacturer, the EUT must comply with the requirements of the following standards:

- 47 CFR Part 2, Part 90(R)
- ANSI C63.26-2015
- KDB 971168 D01 Power Meas License Digital Systems v03r01
- KDB 412172 D01 Determining ERP and EIRP v01r01

**Remark:**

1. All test items were verified and recorded according to the standards and without any deviation during the test.
2. This EUT has also been tested and complied with the requirements of FCC Part 15, Subpart B, recorded in a separate test report.



## 2 Test Configuration of Equipment Under Test

### 2.1 Test Mode

Antenna port conducted and radiated test items listed below are performed according to KDB 971168 D01 Power Meas License Digital Systems v03r01 with maximum output power.

Radiated measurements are performed by rotating the EUT in three different orthogonal test planes to find the maximum emission. (X-Plane)

Conducted Test Cases	Band	Bandwidth (MHz)						Modulation				RB #			Test Channel		
		1.4	3	5	10	15	20	QPSK	16QAM	64QAM	256QAM	1	Half	Full	L	M	H
Max. Output Power	14	-	-	v	-	-	-	v	v	v	v	v		v	v	v	
	14	-	-		v	-	-	v	v	v	v	v		v		v	
Peak-to-Average Ratio	14				v			v	v	v	v			v		v	
26dB and 99% Bandwidth	14	-	-	v	v	-	-	v	v					v		v	
Conducted Band Edge	14	-	-	v		-	-	v	v	v	v	v		v	v		v
	14	-	-		v	-	-	v	v	v	v	v		v	v		v
Emission Mask	14	-	-	v		-	-	v	v	v	v	v		v	v	v	v
	14	-	-		v	-	-	v	v	v	v	v		v		v	
Conducted Spurious Emission	14	-	-	v		-	-	v				v			v	v	v
	14	-	-		v	-	-	v				v				v	
Frequency Stability	14	-	-	v	v	-	-	v						v		v	
E.R.P	14	-	-	v		-	-	v	v	v	v	v		v	v	v	v
	14	-	-		v	-	-	v	v	v	v	v		v		v	
Radiated Spurious Emission	14	Worst Case													v	v	v
Note	<ol style="list-style-type: none"> <li>The mark "v" means that this configuration is chosen for testing</li> <li>The mark "-" means that this bandwidth is not supported.</li> <li>The device is investigated from 30MHz to 10 times of fundamental signal for radiated spurious emission test under different RB size/offset and modulations in exploratory test. Subsequently, only the worst case emissions are reported.</li> </ol>																

## 2.2 Connection Diagram of Test System

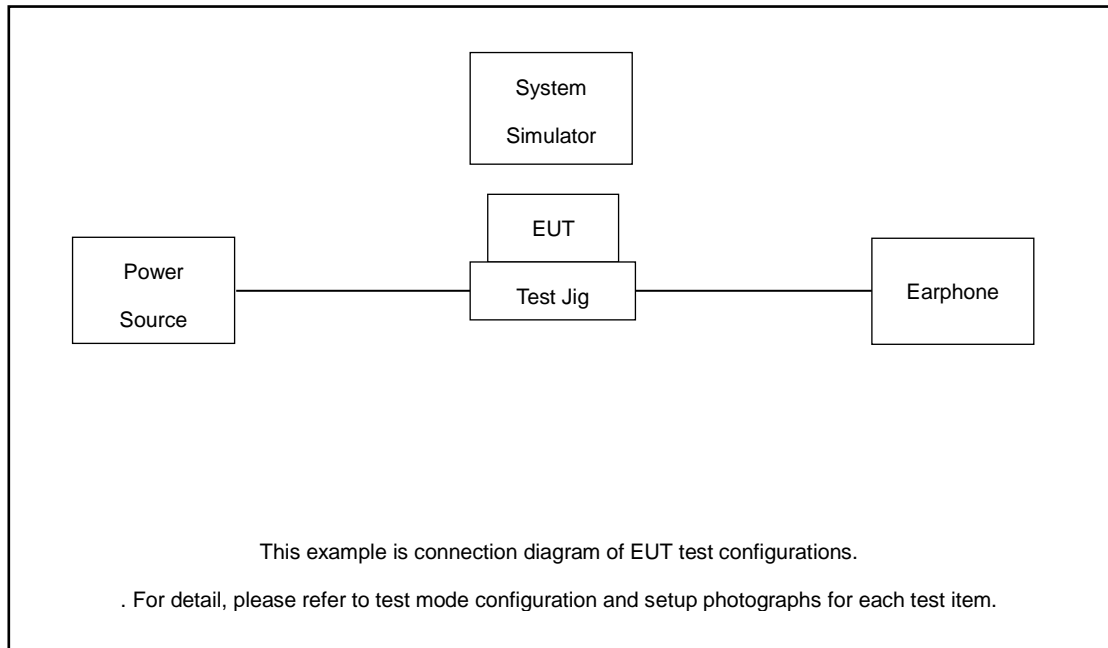

## 2.3 Support Unit used in test configuration and system

Item	Equipment	Trade Name	Model No.	FCC ID	Data Cable	Power Cord
1.	Power Supply	GWINSTEK	PSS-2002	N/A	N/A	Unshielded, 1.8 m
2.	Base Station	Anritsu	MT8820/8821	N/A	N/A	Unshielded, 1.8 m
3.	Test jig	N/A	N/A	N/A	N/A	N/A
4.	Adapter	N/A	N/A	N/A	N/A	N/A
5.	Earphone	N/A	N/A	N/A	N/A	N/A

## 2.4 Measurement Results Explanation Example

### For all conducted test items:

The offset level is set in the spectrum analyzer to compensate the RF cable loss between EUT conducted output port and spectrum analyzer. With the offset compensation, the spectrum analyzer reading level is exactly the EUT RF output level.

The spectrum analyzer offset is derived from RF cable loss.

$$\text{Offset} = \text{RF cable loss.}$$

Following shows an offset computation example with cable loss 4.60 dB

Example :

$$\begin{aligned} \text{Offset(dB)} &= \text{RF cable loss(dB)} \\ &= 4.60(\text{dB}) \end{aligned}$$



### 3 Conducted Test Items

#### 3.1 Measuring Instruments

See list of measuring instruments of this test report.

##### 3.1.1 Test Setup

##### 3.1.2 Conducted Output Power

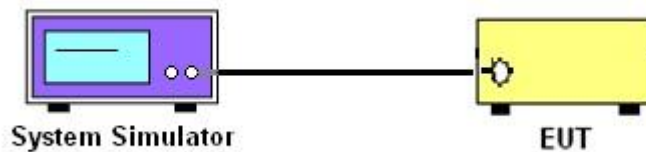

##### 3.1.3 Peak-to-Average Ratio, Occupied Bandwidth, Conducted Band-Edge, Emission Mask, and Conducted Spurious Emission

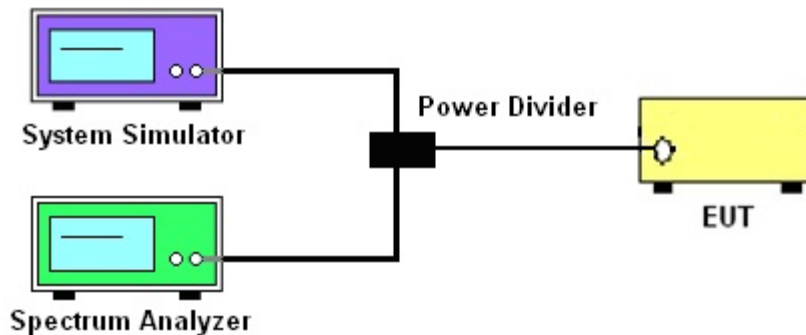

##### 3.1.4 Frequency Stability

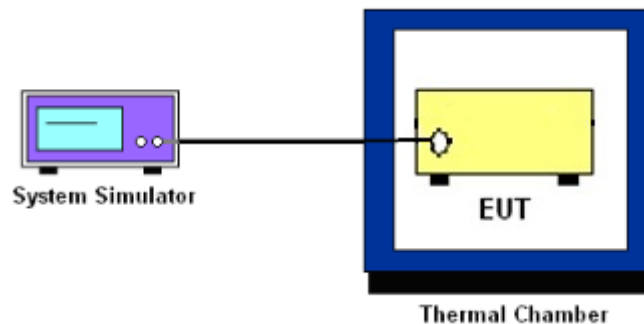

##### 3.1.5 Test Result of Conducted Test

Please refer to Appendix A.

## 3.2 Conducted Output Power and ERP

### 3.2.1 Description of the Conducted Output Power Measurement and ERP

A base station simulator was used to establish communication with the EUT. Its parameters were set to transmit the maximum power on the EUT. The measured power in the radio frequency on the transmitter output terminals shall be reported.

The ERP of mobile transmitters must not exceed 3 Watts for LTE Band 14.

According to KDB 412172 D01 Power Approach,

$EIRP = P_T + G_T - L_C$ ,  $ERP = EIRP - 2.15$ , where

$P_T$  = transmitter output power in dBm

$G_T$  = gain of the transmitting antenna in dBi

$L_C$  = signal attenuation in the connecting cable between the transmitter and antenna in dB

### 3.2.2 Test Procedures

1. The testing follows ANSI C63.26 Section 5.2
2. The transmitter output port was connected to the system simulator.
3. Set EUT at maximum power through the system simulator.
4. Select lowest, middle, and highest channels for each band and different modulation.
5. Measure and record the power level from the system simulator.

### **3.3 Peak-to-Average Ratio**

#### **3.3.1 Description of the PAR Measurement**

Power Complementary Cumulative Distribution Function (CCDF) curves provide a means for characterizing the power peaks of a digitally modulated signal on a statistical basis. A CCDF curve depicts the probability of the peak signal amplitude exceeding the average power level. Most contemporary measurement instrumentation include the capability to produce CCDF curves for an input signal provided that the instrument's resolution bandwidth can be set wide enough to accommodate the entire input signal bandwidth. In measuring transmissions in this band using an average power technique, the peak-to-average ratio (PAR) of the transmission may not exceed 13 dB.

#### **3.3.2 Test Procedures**

1. The EUT was connected to spectrum and system simulator via a power divider.
2. Set the CCDF (Complementary Cumulative Distribution Function) option in spectrum analyzer.
3. The highest RF powers were measured and recorded the maximum PAPR level associated with a probability of 0.1 %.
4. Record the deviation as Peak to Average Ratio.

## 3.4 Occupied Bandwidth

### 3.4.1 Description of Occupied Bandwidth Measurement

The occupied bandwidth is the width of a frequency band such that, below the lower and above the upper frequency limits, the mean powers emitted are each equal to a specified percentage 0.5% of the total mean transmitted power.

The 26 dB emission bandwidth is defined as the frequency range between two points, one above and one below the carrier frequency, at which the spectral density of the emission is attenuated 26 dB below the maximum in-band spectral density of the modulated signal. Spectral density (power per unit bandwidth) is to be measured with a detector of resolution bandwidth equal to approximately 1.0% of the emission bandwidth.

### 3.4.2 Test Procedures

1. The testing follows ANSI C63.26 Section 5.4
2. The EUT was connected to spectrum analyzer and system simulator via a power divider.
3. The spectrum analyzer center frequency is set to the nominal EUT channel center frequency. The span range for the spectrum analyzer shall be between two and five times the anticipated OBW.
4. The nominal resolution bandwidth (RBW) shall be in the range of 1 to 5 % of the anticipated OBW, and the VBW shall be at least 3 times the RBW.
5. Set the detection mode to peak, and the trace mode to max hold.
6. Determine the reference value: Set the EUT to transmit a modulated signal. Allow the trace to stabilize. Set the spectrum analyzer marker to the highest level of the displayed trace.  
(this is the reference value)
7. Determine the “-26 dB down amplitude” as equal to (Reference Value – X).
8. Place two markers, one at the lowest and the other at the highest frequency of the envelope of the spectral display such that each marker is at or slightly below the “-X dB down amplitude” determined in step 6. If a marker is below this “-X dB down amplitude” value it shall be placed as close as possible to this value. The OBW is the positive frequency difference between the two markers.
9. Use the 99 % power bandwidth function of the spectrum analyzer and report the measured bandwidth.

## 3.5 Conducted Band Edge Measurement

### 3.5.1 Description of Conducted Band Edge Measurement

For operations in the 758-768 MHz and the 788-798 MHz bands

(1) On all frequencies between 769-775 MHz and 799-805 MHz, by a factor not less than  $76 + 10 \log$  (P) dB in a 6.25 kHz band segment, for base and fixed stations.

(2) On all frequencies between 769-775 MHz and 799-805 MHz, by a factor not less than  $65 + 10 \log$  (P) dB in a 6.25 kHz band segment, for mobile and portable stations.

(3) On any frequency between 775-788 MHz, above 805 MHz, and below 758 MHz, by at least  $43 + 10 \log$  (P) dB.

### 3.5.2 Test Procedures

1. The testing follows ANSI C63.26 section 5.7
2. The EUT was connected to spectrum analyzer and system simulator via a power divider.
3. The band edges of low and high channels for the highest RF powers were measured.
4. Set spectrum analyzer with RMS detector.
5. The RF fundamental frequency should be excluded against the limit line in the operating frequency band.
6. Checked that all the results comply with the emission limit line.

Example:

The limit line is derived from  $43 + 10\log(P)$ dB below the transmitter power P(Watts)

$$= P(W) - [43 + 10\log(P)] \text{ (dB)}$$

$$= [30 + 10\log(P)] \text{ (dBm)} - [43 + 10\log(P)] \text{ (dB)} = -13\text{dBm}.$$

## 3.6 Emission Mask

### 3.6.1 Description of Emission Mask

<Emission Mask B>.

For transmitters that are equipped with an audio low-pass filter, the power of any emission must be attenuated below the unmodulated carrier power (P) as follows:

- (1) On any frequency removed from the assigned frequency by more than 50 percent, but not more than 100 percent of the authorized bandwidth: At least 25 dB.
- (2) On any frequency removed from the assigned frequency by more than 100 percent, but not more than 250 percent of the authorized bandwidth: At least 35 dB.
- (3) On any frequency removed from the assigned frequency by more than 250 percent of the authorized bandwidth: At least  $43 + 10 \log (P)$  dB.

### 3.6.2 Test Procedures

1. The testing follows ANSI C63.26 section 5.7
2. The EUT was connected to spectrum analyzer and system simulator via a power divider.
3. The RF output of EUT was connected to the spectrum analyzer by RF cable and attenuator. The path loss was compensated to the results for each measurement.
4. Make the measurement with the spectrum analyzer's RBW = 1MHz, VBW = 3MHz.
5. Set spectrum analyzer with RMS detector.
6. Taking the record of maximum spurious emission.
7. The RF fundamental frequency should be excluded against the limit line in the operating frequency band.
8. The limit line is derived from  $43 + 10\log(P)$ dB below the transmitter power P(Watts)  
=  $P(W) - [43 + 10\log(P)]$  (dB)  
=  $[30 + 10\log(P)]$  (dBm) -  $[43 + 10\log(P)]$  (dB)  
= -13dBm.

## 3.7 Conducted Spurious Emission Measurement

### 3.7.1 Description of Conducted Spurious Emission Measurement

The power of any emission outside of the authorized operating frequency ranges must be lower than the transmitter power (P) by a factor of at least  $43 + 10 \log (P)$  dB.

It is measured by means of a calibrated spectrum analyzer and scanned from 30MHz up to a frequency including its 10<sup>th</sup> harmonic.

### 3.7.2 Test Procedures

1. The testing follows ANSI C63.26 section 5.7
2. The EUT was connected to spectrum analyzer and base station via power divider.
3. The RF output of EUT was connected to the spectrum analyzer by RF cable and attenuator. The path loss was compensated to the results for each measurement.
4. The middle channel for the highest RF power within the transmitting frequency was measured.
5. The conducted spurious emission for the whole frequency range was taken.
6. Make the measurement with the spectrum analyzer's, for under 1GHz RBW = 100kHz, VBW = 300kHz and for above 1GHz RBW = 1MHz, VBW = 3MHz, taking the record of maximum spurious emission.
7. Set spectrum analyzer with RMS detector.
8. The RF fundamental frequency should be excluded against the limit line in the operating frequency band.
9. The limit line is derived from  $43 + 10\log(P)$ dB below the transmitter power P(Watts)  
= P(W)- [43 + 10log(P)] (dB)  
= [30 + 10log(P)] (dBm) - [43 + 10log(P)] (dB)  
= -13dBm.

## 3.8 Frequency Stability Measurement

### 3.8.1 Description of Frequency Stability Measurement

The frequency stability shall be measured by variation of ambient temperature and variation of primary supply voltage to ensure that the fundamental emission stays within the authorized frequency block. The frequency stability of the transmitter shall be maintained within  $\pm 1.25$  ppm of the center frequency.

### 3.8.2 Test Procedures for Temperature Variation

1. The testing follows ANSI C63.26 section 5.6.4
2. The EUT was set up in the thermal chamber and connected with the system simulator.
3. With power OFF, the temperature was decreased to  $-30^{\circ}\text{C}$  and the EUT was stabilized before testing. Power was applied and the maximum change in frequency was recorded within one minute.
4. With power OFF, the temperature was raised in  $10^{\circ}\text{C}$  step up to  $50^{\circ}\text{C}$ . The EUT was stabilized at each step for at least half an hour. Power was applied and the maximum frequency change was recorded within one minute.

### 3.8.3 Test Procedures for Voltage Variation

1. The testing follows ANSI C63.26 section 5.6.5.
2. The EUT was placed in a temperature chamber at  $20\pm 5^{\circ}\text{C}$  and connected with the system simulator.
3. The power supply voltage to the EUT was varied from 85% to 115% of the nominal value for other than hand carried battery equipment.
4. For hand carried, battery powered equipment, reduce the primary ac or dc supply voltage to the battery operating end point, which shall be specified by the manufacturer.
5. The variation in frequency was measured for the worst case.



## 4 Radiated Test Items

### 4.1 Measuring Instruments

See list of measuring instruments of this test report.

### 4.2 Test Setup

#### 4.2.1 For radiated test below 30MHz

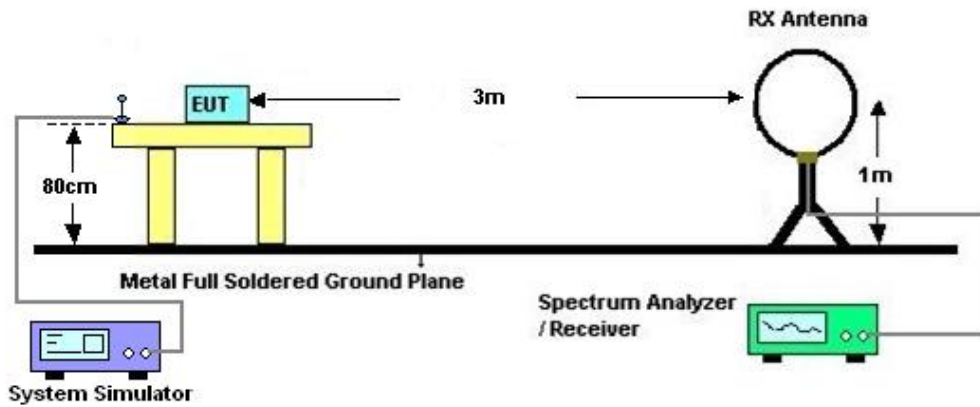

#### 4.2.2 For radiated test from 30MHz to 1GHz

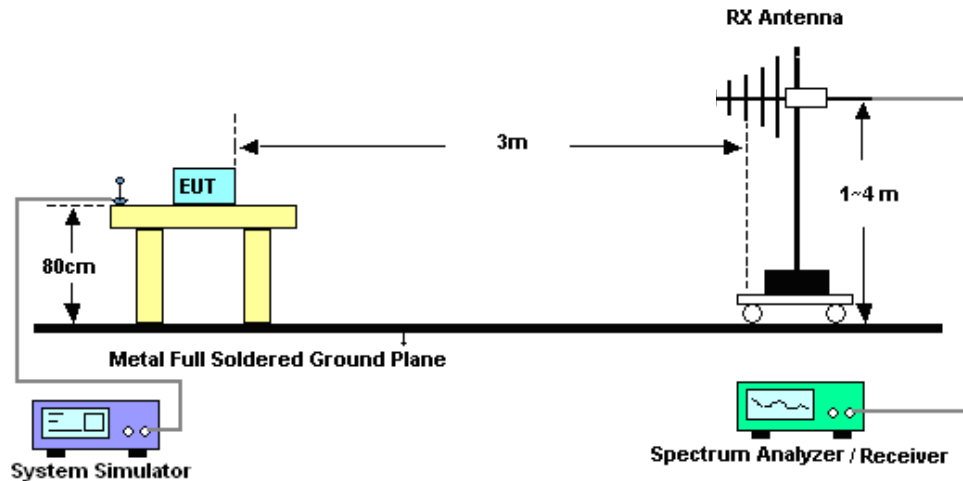

#### 4.2.3 For radiated test above 1GHz

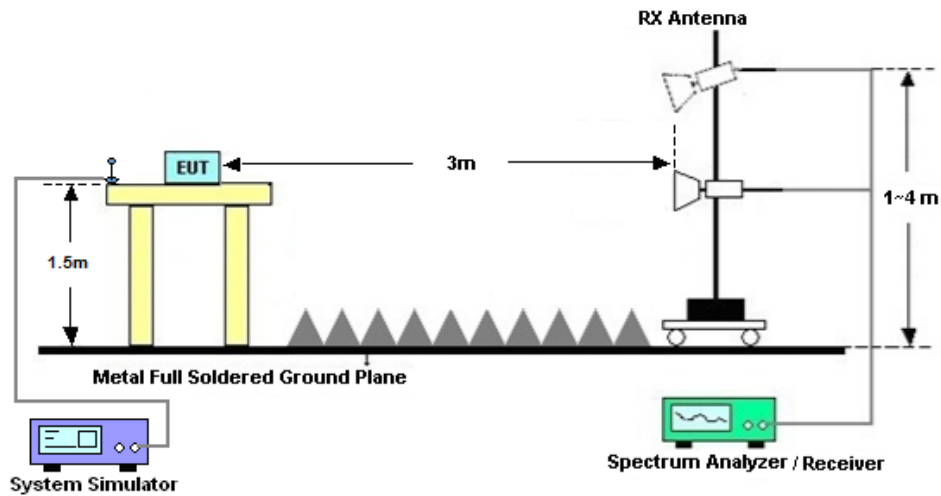

### 4.3 Test Result of Radiated Test

The low frequency, which started from 9 kHz to 30MHz, was pre-scanned and the result which was 20dB lower than the limit line was not reported.

Please refer to Appendix B.

## 4.4 Radiated Spurious Emission Measurement

### 4.4.1 Description of Radiated Spurious Emission

The radiated spurious emission was measured by substitution method according to ANSI C63.26.

The power of any emission outside of the authorized operating frequency ranges must be attenuated below the transmitter power (P) by a factor of at least  $43 + 10 \log (P)$  dB.

For operations in the 758-775 MHz and 788-805 MHz bands, all emissions including harmonics in the band 1559–1610 MHz shall be limited to -70 dBW/MHz equivalent isotropically radiated power (EIRP) for wideband signals, and -80 dBW EIRP for discrete emissions of less than 700 Hz bandwidth. For the purpose of equipment authorization, a transmitter shall be tested with an antenna that is representative of the type that will be used with the equipment in normal operation.

### 4.4.2 Test Procedures

1. The testing follows ANSI C63.26 Section 5.5
2. The EUT was placed on a turntable with 0.8 meter height for frequency below 1GHz and 1.5 meter height for frequency above 1GHz respectively above ground.
3. The EUT was set 3 meters from the receiving antenna mounted on the antenna tower.
4. The table was rotated 360 degrees to determine the position of the highest spurious emission.
5. The height of the receiving antenna is varied between 1m to 4m to search the maximum spurious emission for both horizontal and vertical polarizations.
6. During the measurement, the system simulator parameters were set to force the EUT transmitting at maximum output power.
7. Make the measurement with the spectrum analyzer's RBW = 1MHz, VBW = 3MHz, taking the record of maximum spurious emission.
8. A horn antenna was substituted in place of the EUT and was driven by a signal generator.
9. Tune the output power of signal generator to the same emission level with EUT maximum spurious emission.
10.  $EIRP (dBm) = S.G. Power - Tx Cable Loss + Tx Antenna Gain$
11.  $ERP (dBm) = EIRP - 2.15$
12. The RF fundamental frequency should be excluded against the limit line in the operating frequency band.

The limit line is derived from  $43 + 10\log(P)$ dB below the transmitter power P(Watts)  
 $= P(W) - [43 + 10\log(P)] (dB)$   
 $= [30 + 10\log(P)] (dBm) - [43 + 10\log(P)] (dB)$   
 $= -13dBm.$

## 5 List of Measuring Equipment

Instrument	Manufacturer	Model No.	Serial No.	Characteristics	Calibration Date	Test Date	Due Date	Remark
EXA Spectrum Analyzer	Keysight	N9010B	MY57471079	10Hz-44G,MAX 30dB	Oct. 12, 2022	Mar. 20, 2023	Oct. 11, 2023	Radiation (03CH04-KS)
Loop Antenna	R&S	HFH2-Z2	100321	9kHz~30MHz	Oct. 16, 2022	Mar. 20, 2023	Oct. 15, 2023	Radiation (03CH04-KS)
Bilog Antenna	TeseQ	CBL6111D	49922	30MHz-1GHz	May 24, 2022	Mar. 20, 2023	May 23, 2023	Radiation (03CH04-KS)
Horn Antenna	Schwarzbeck	BBHA9120D	1284	1GHz~18GHz	Oct. 16, 2022	Mar. 20, 2023	Oct. 15, 2023	Radiation (03CH04-KS)
SHF-EHF Horn	Com-power	AH-840	101070	18GHz~40GHz	Jan. 08, 2023	Mar. 20, 2023	Jan. 07, 2024	Radiation (03CH04-KS)
Amplifier	SONOMA	310N	187289	9KHz-1GHz	May 24, 2022	Mar. 20, 2023	May 23, 2023	Radiation (03CH04-KS)
Amplifier	MITEQ	EM18G40GGA	060728	18~40GHz	Jan. 05, 2023	Mar. 20, 2023	Jan. 04, 2024	Radiation (03CH04-KS)
high gain Amplifier	EM	EM01G18GA	060840	1Ghz-18Ghz	Oct. 12, 2022	Mar. 20, 2023	Oct. 11, 2023	Radiation (03CH04-KS)
Amplifier	Agilent	8449B	3008A02370	1Ghz-18Ghz	Oct. 12, 2022	Mar. 20, 2023	Oct. 11, 2023	Radiation (03CH04-KS)
AC Power Source	Chroma	61601	F104090004	N/A	NCR	Mar. 20, 2023	NCR	Radiation (03CH04-KS)
Turn Table	ChamPro	EM 1000-T	060762-T	0~360 degree	NCR	Mar. 20, 2023	NCR	Radiation (03CH04-KS)
Antenna Mast	ChamPro	EM 1000-A	060762-A	1 m~4 m	NCR	Mar. 20, 2023	NCR	Radiation (03CH04-KS)
Spectrum Analyzer	R&S	FSV40	101040	10Hz~40GHz	Oct. 12, 2022	Jan. 21, 2023	Oct. 11, 2023	Conducted (TH01-KS)
Power divider	STI	STI08-0055	-	0.5~40GHz	NCR	Jan. 21, 2023	NCR	Conducted (TH01-KS)
Temperature & humidity chamber	Hongzhan	LP-150U	H2014011440	-40~+150°C 20%~95%RH	Jul. 15, 2022	Jan. 21, 2023	Jul. 14, 2023	Conducted (TH01-KS)

NCR: No Calibration Required.

## 6 Uncertainty of Evaluation

The measurement uncertainties shown below were calculated in accordance with the requirements of ANSI 63.26-2015. All the measurement uncertainty value were shown with a coverage K=2 to indicate 95% level of confidence. The measurement data show herein meets or exceeds the CISPR measurement uncertainty values specified in CISPR 16-4-2 and can be compared directly to specified limit to determine compliance.

### Uncertainty of Conducted Measurement

Test Item	Uncertainty
Conducted Power	±0.46 dB
Conducted Emissions	±0.48 dB
Occupied Channel Bandwidth	±0.1 %

### Uncertainty of Radiated Emission Measurement (30 MHz ~ 1000 MHz)

Measuring Uncertainty for a Level of Confidence of 95% (U = 2Uc(y))	3.3dB
---	-------

### Uncertainty of Radiated Emission Measurement (1 GHz ~ 18 GHz)

Measuring Uncertainty for a Level of Confidence of 95% (U = 2Uc(y))	2.8dB
---	-------

### Uncertainty of Radiated Emission Measurement (18 GHz ~ 40 GHz)

Measuring Uncertainty for a Level of Confidence of 95% (U = 2Uc(y))	2.8dB
---	-------

----- THE END -----



## Appendix A. Test Results of Conducted Test

Test Engineer :	Simle Wang	Temperature :	22~23℃
		Relative Humidity :	40~42%

### Conducted Output Power(Average power)and ERP

BW [MHz]	Modulation	RB Size	RB Offset	Power Low Ch. / Freq.	Power Middle Ch. / Freq.	Power High Ch. / Freq.	ERP(W)		
Channel				23330					
Frequency (MHz)				793				M	
10	QPSK	1	0		22.55			0.0088	
10	QPSK	1	49		22.32			0.0084	
10	QPSK	50	0		21.40			0.0068	
10	16QAM	1	0		21.65			0.0072	
10	64QAM	1	0		20.46			0.0054	
10	256QAM	1	0		17.52			0.0028	
Channel				23305	23330	23355	ERP(W)		
Frequency (MHz)				790.5	793	795.5	L	M	H
5	QPSK	1	0	22.41	22.52	22.34	0.0085	0.0087	0.0084
5	16QAM	1	0	21.42	21.34	21.24	0.0068	0.0067	0.0065

## Peak-to-Average Ratio

Mode	LTE Band 14 / 10MHz				
Mod.	QPSK	16QAM	64QAM	256QAM	Limit: 13dB
RB Size	Full RB	Full RB	Full RB	Full RB	Result
Middle CH	5.36	5.97	6.26	6.20	PASS

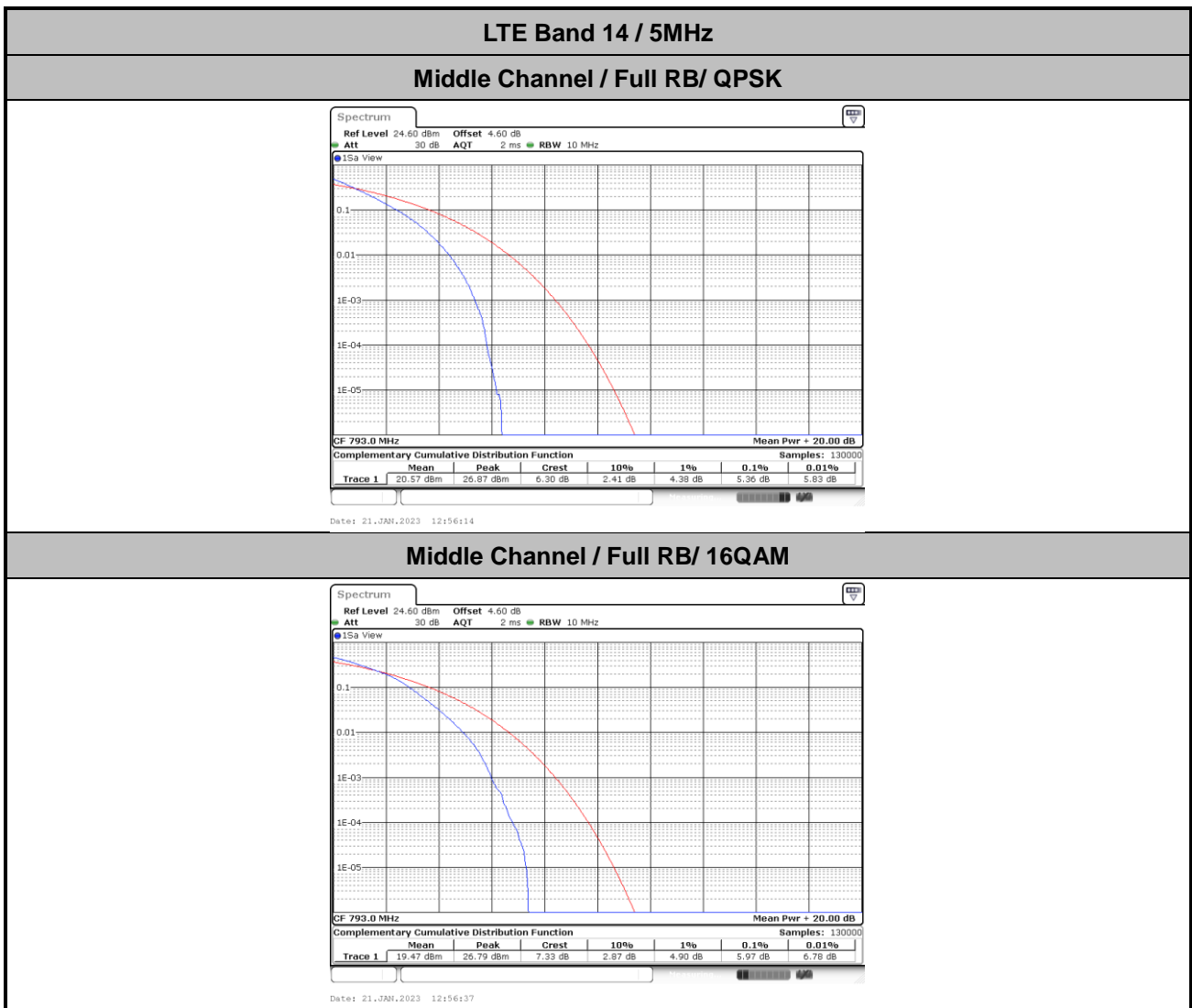

**Middle Channel / Full RB/ 16QAM**



Middle Channel / Full RB/ 64QAM

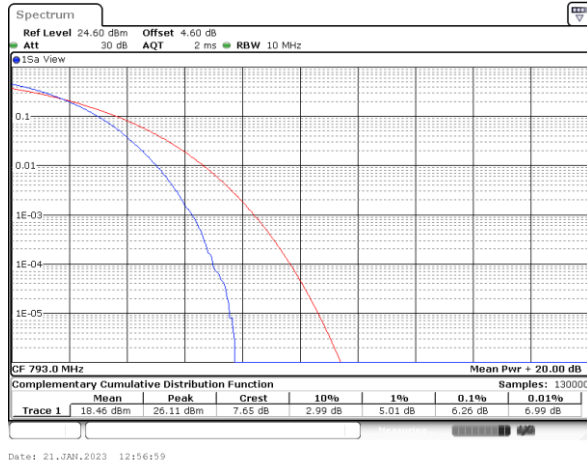

Middle Channel / Full RB/ 256QAM

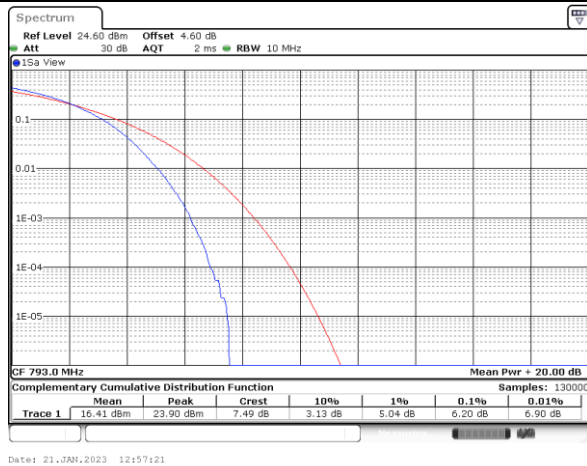





## 26dB Bandwidth

Mode	LTE Band 14 : 26dB BW(MHz)	
BW	10MHz	
Mod.	QPSK	16QAM
Middle CH	9.75	9.81
BW	5MHz	
Mod.	QPSK	16QAM
Middle CH	4.84	4.88

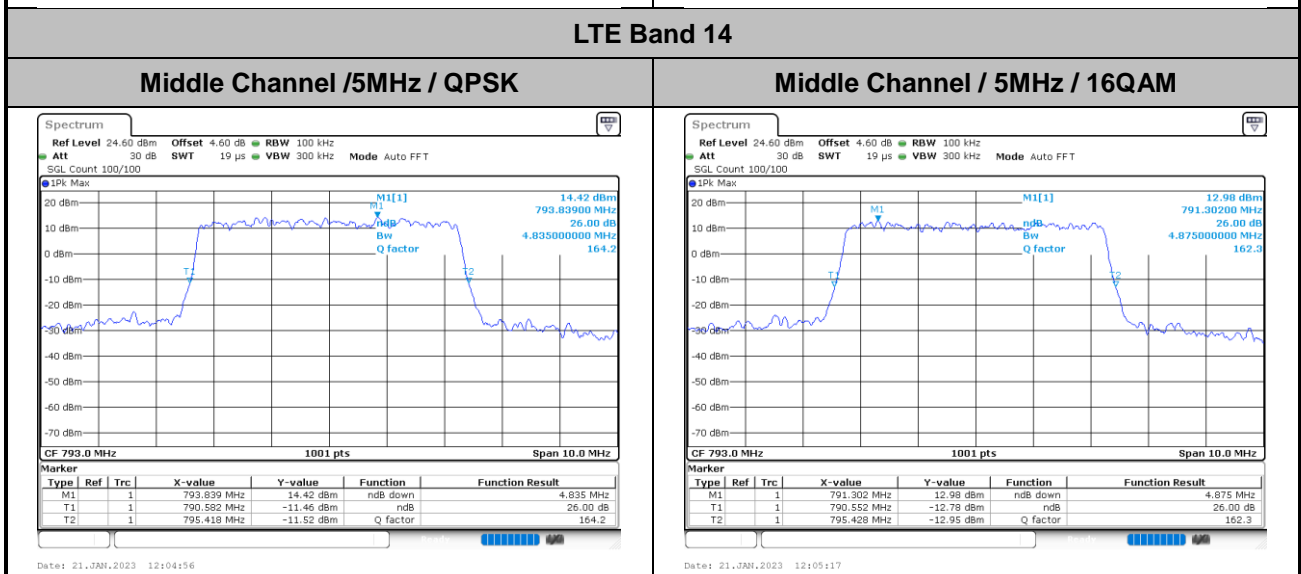
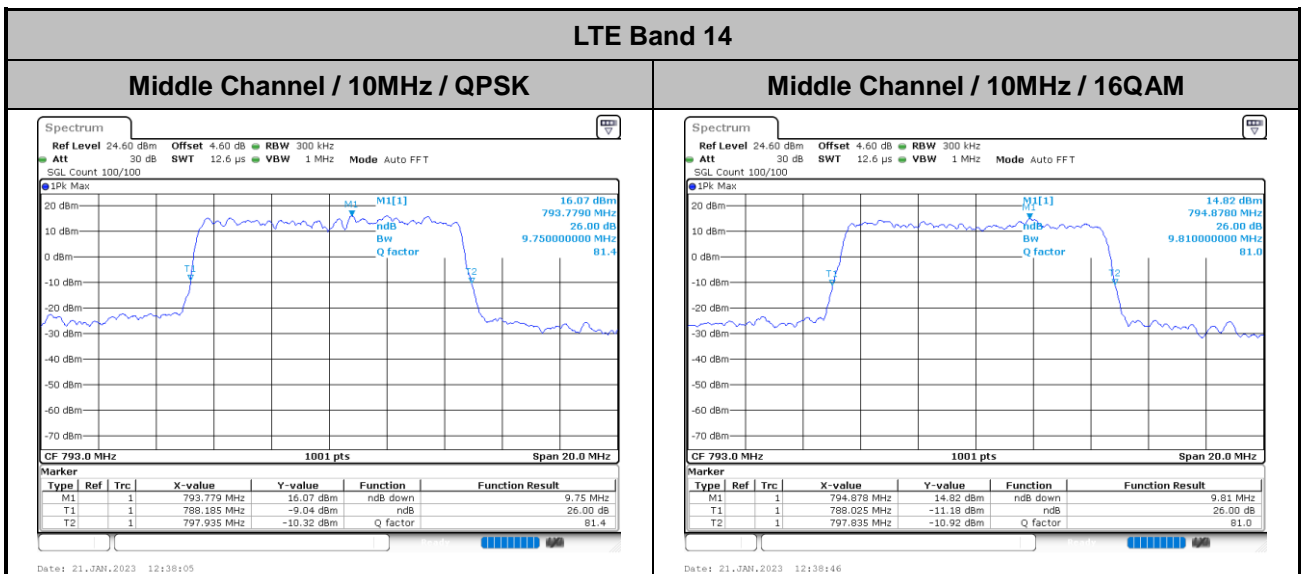



# Occupied Bandwidth

Mode	LTE Band 14 : 99%OBW(MHz)	
BW	10MHz	
Mod.	QPSK	16QAM
Middle CH	9.01	8.97
BW	5MHz	
Mod.	QPSK	16QAM
Middle CH	4.49	4.50

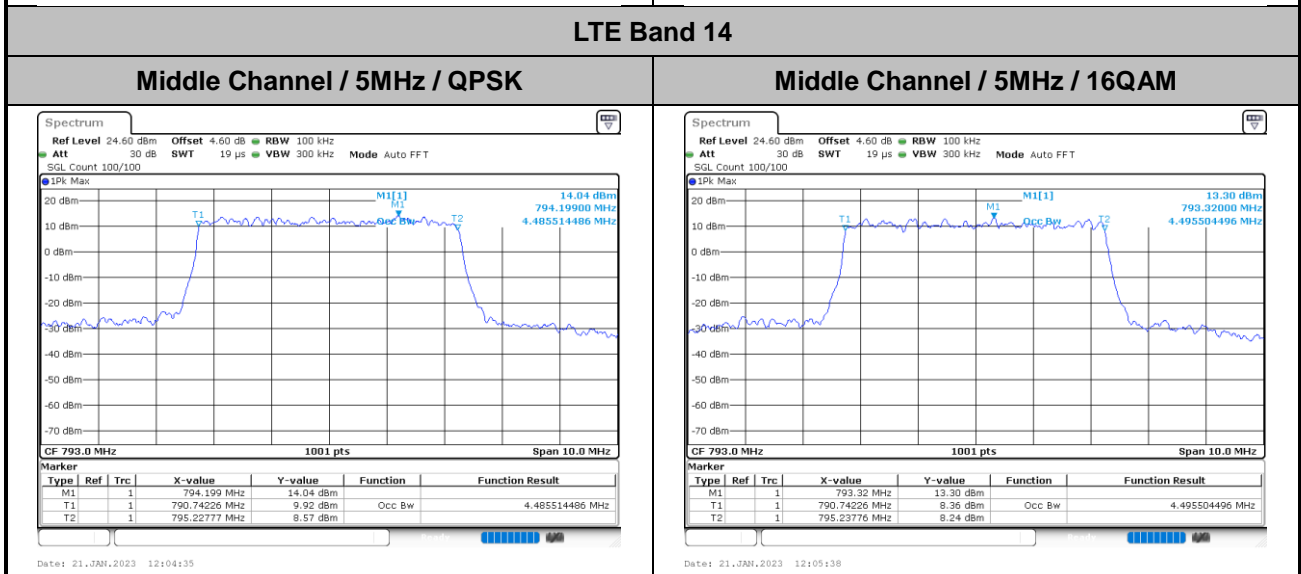
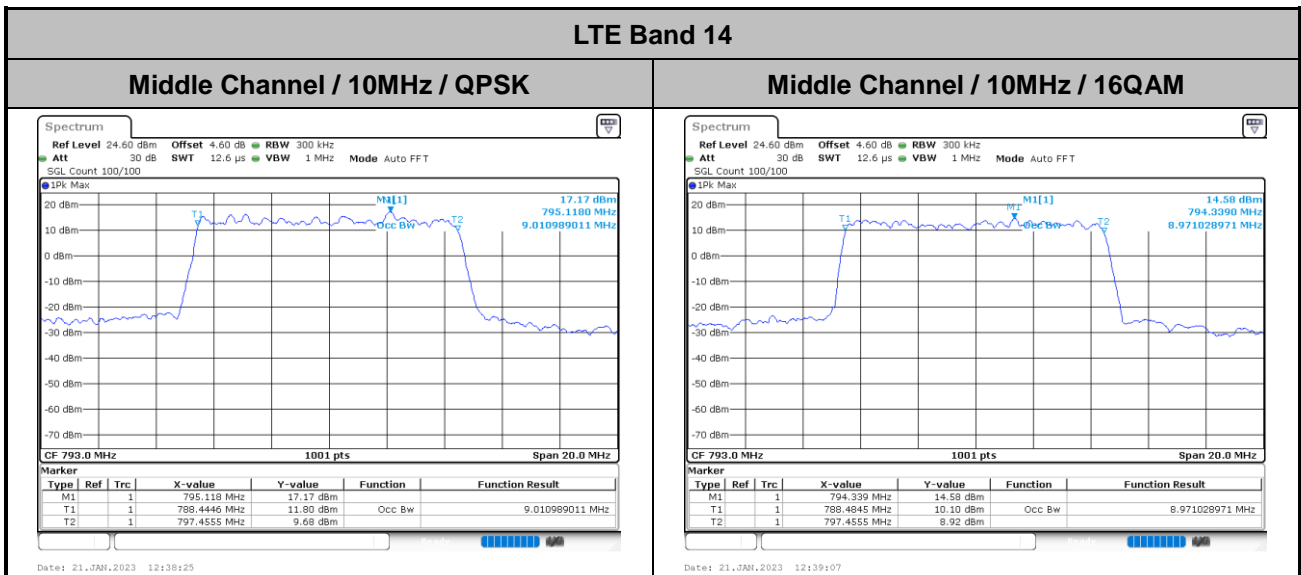



# Conducted Band Edge

## LTE Band 14 / 5MHz / QPSK

### Lowest Band Edge / 1 RB

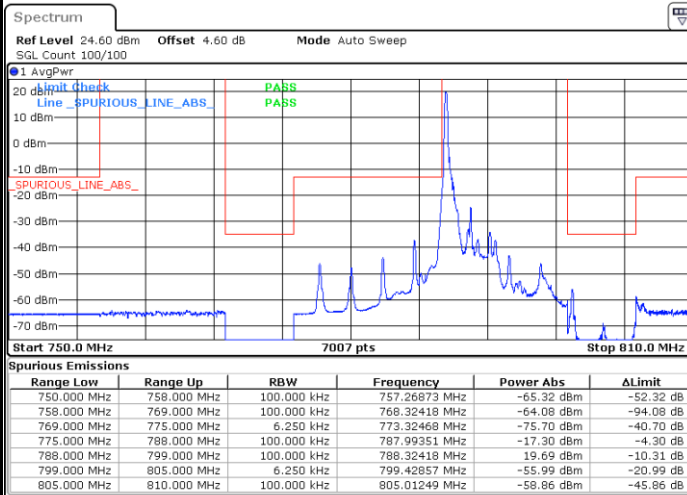

Date: 21.JAN.2023 11:18:18

### Highest Band Edge / 1 RB

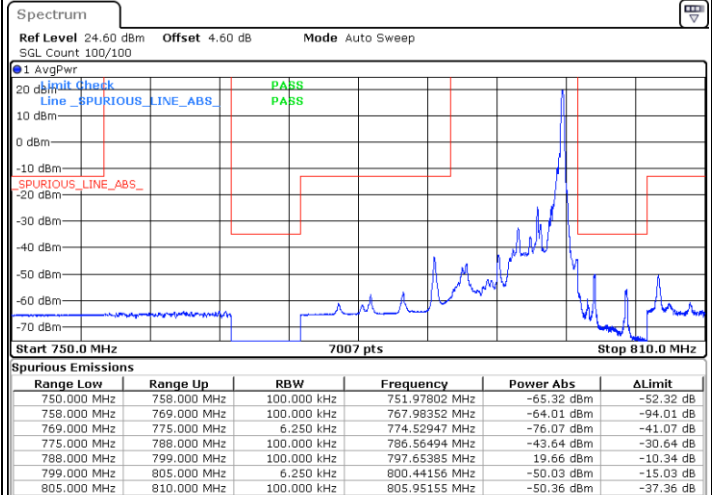

Date: 21.JAN.2023 12:27:06

### Lowest Band Edge / Full RB

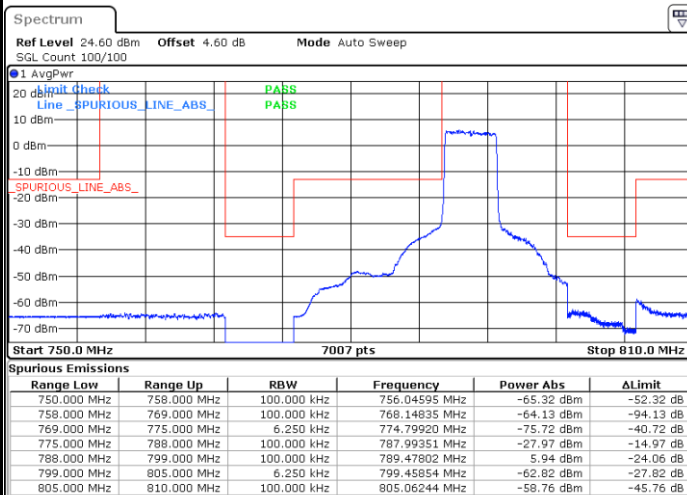

Date: 21.JAN.2023 11:28:58

### Highest Band Edge / Full RB

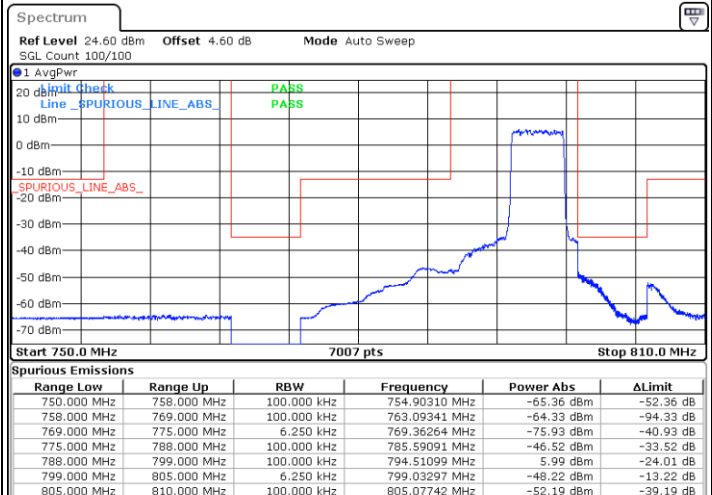

Date: 21.JAN.2023 12:37:43



LTE Band 14 / 5MHz / 16QAM

Lowest Band Edge / 1 RB

Highest Band Edge / 1 RB

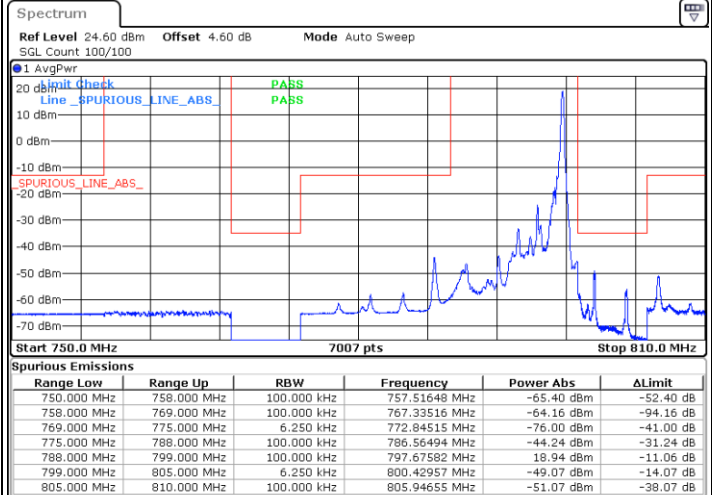
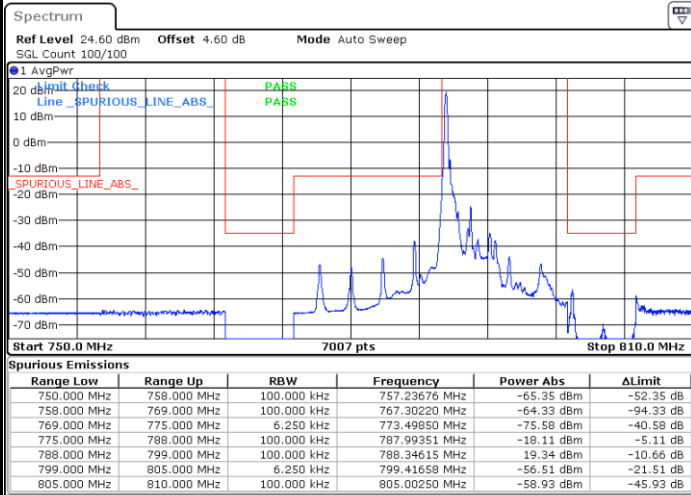

Date: 21.JAN.2023 11:19:38

Date: 21.JAN.2023 12:28:27

Lowest Band Edge / Full RB

Highest Band Edge / Full RB

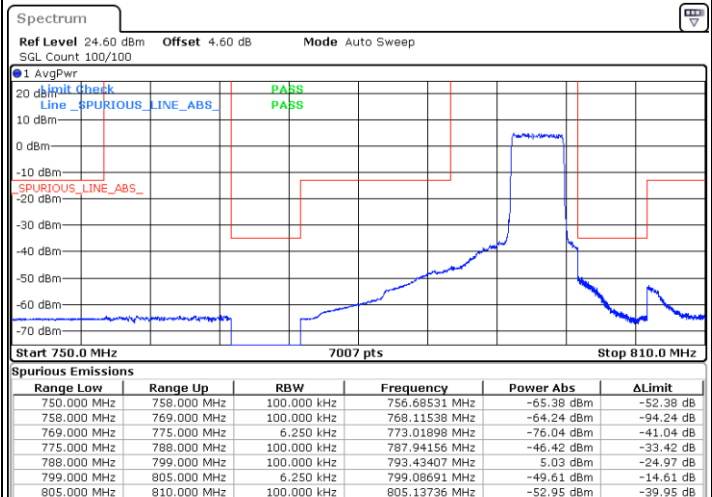
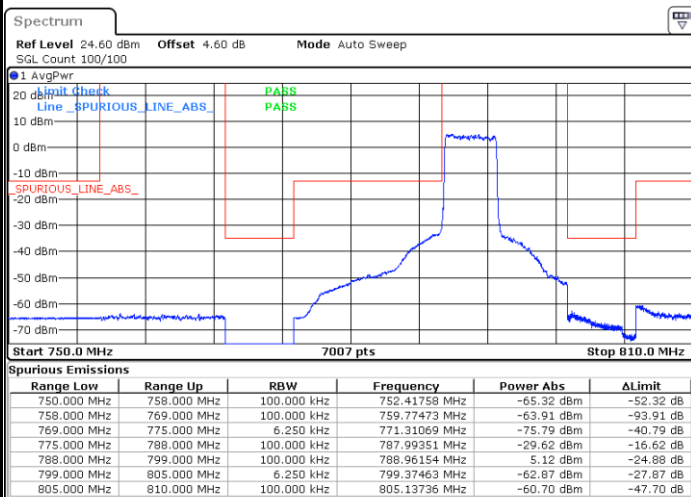

Date: 21.JAN.2023 11:27:38

Date: 21.JAN.2023 12:36:23



LTE Band 14 / 5MHz / 64QAM

Lowest Band Edge / 1 RB

Highest Band Edge / 1 RB

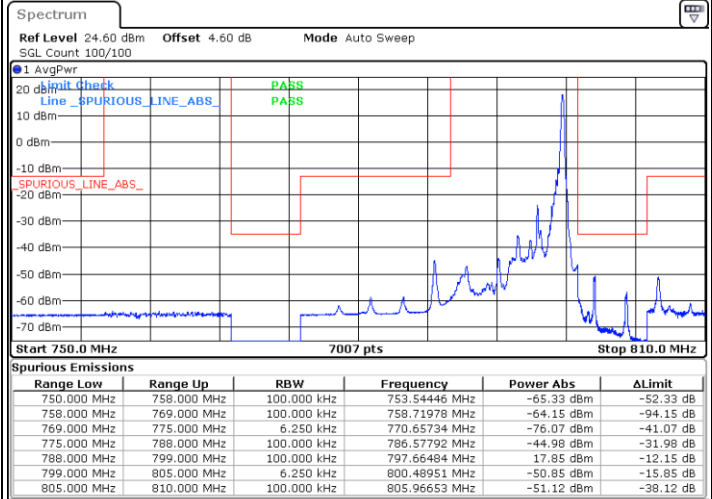
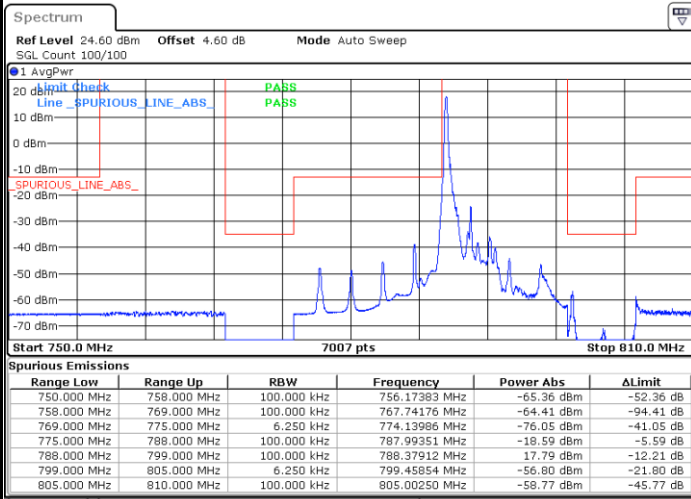

Date: 21.JAN.2023 11:20:59

Date: 21.JAN.2023 12:29:47

Lowest Band Edge / Full RB

Highest Band Edge / Full RB

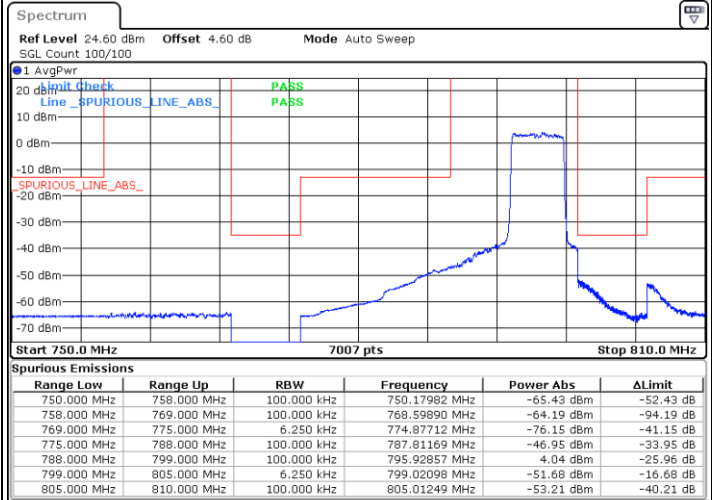
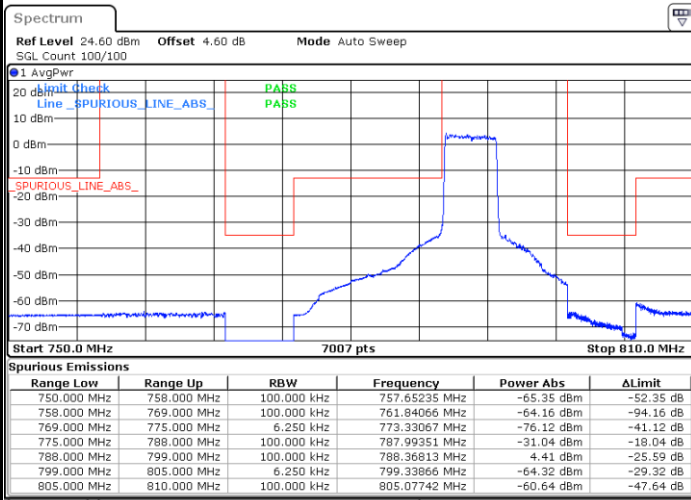

Date: 21.JAN.2023 11:26:17

Date: 21.JAN.2023 12:35:03



LTE Band 14 / 5MHz / 256QAM

Lowest Band Edge / 1 RB

Highest Band Edge / 1 RB

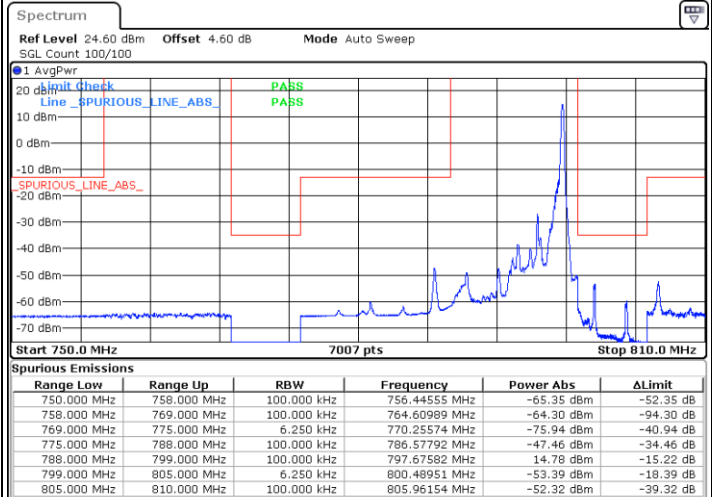
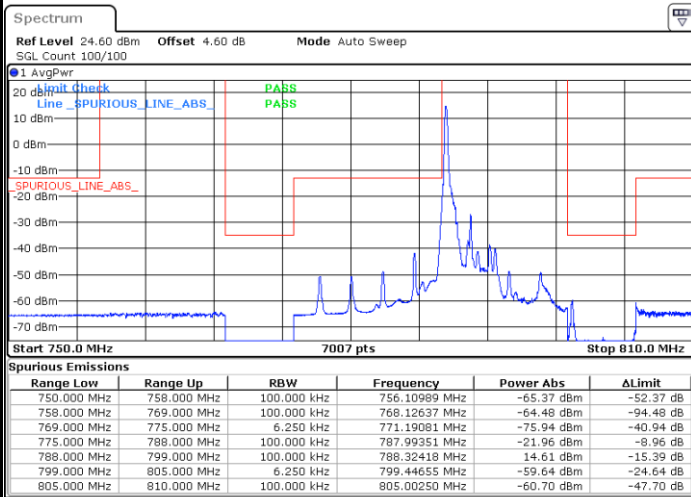

Date: 21.JAN.2023 11:22:19

Date: 21.JAN.2023 12:31:07

Lowest Band Edge / Full RB

Highest Band Edge / Full RB

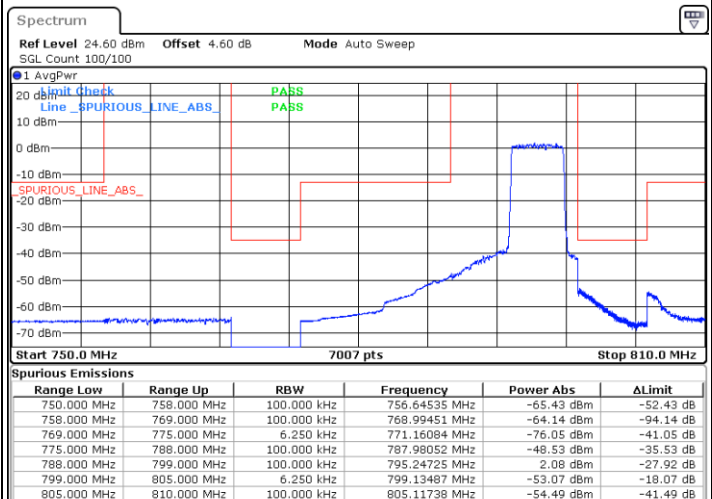
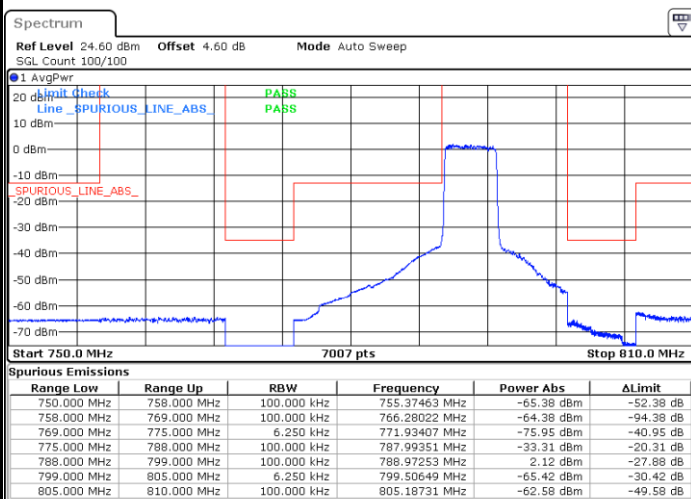

Date: 21.JAN.2023 11:24:54

Date: 21.JAN.2023 12:33:42



LTE Band 14 / 10MHz / QPSK

Lowest Band Edge / 1 RB

Highest Band Edge / 1 RB

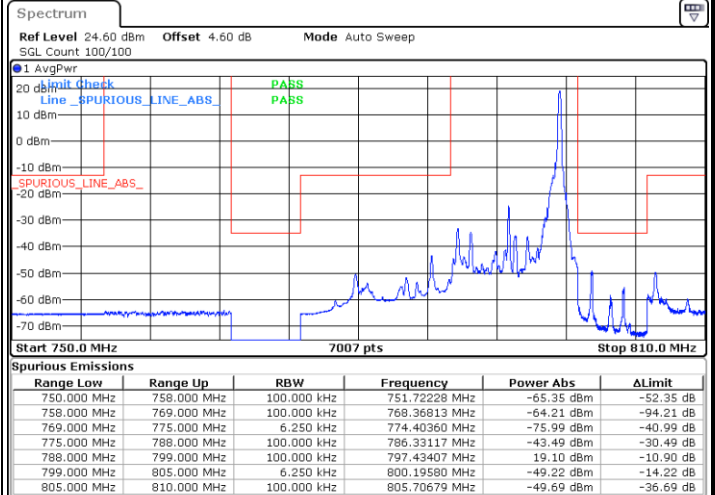
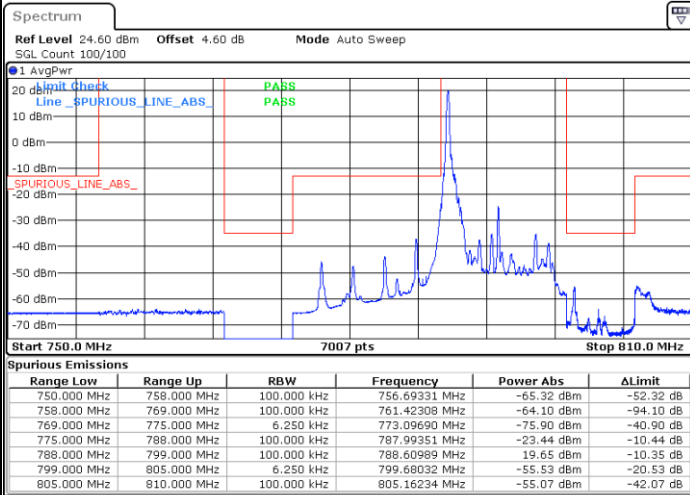

Date: 21. JAN. 2023 12:41:16

Date: 21. JAN. 2023 12:50:34

Band Edge / Full RB

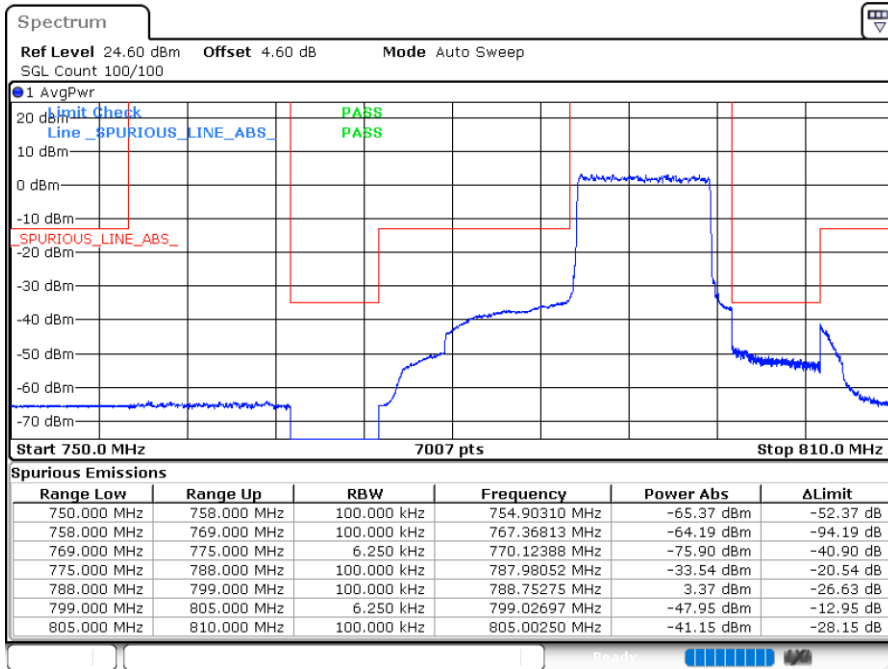

Date: 21. JAN. 2023 12:51:53



LTE Band 14 / 10MHz / 16QAM

Lowest Band Edge / 1 RB

Highest Band Edge / 1 RB

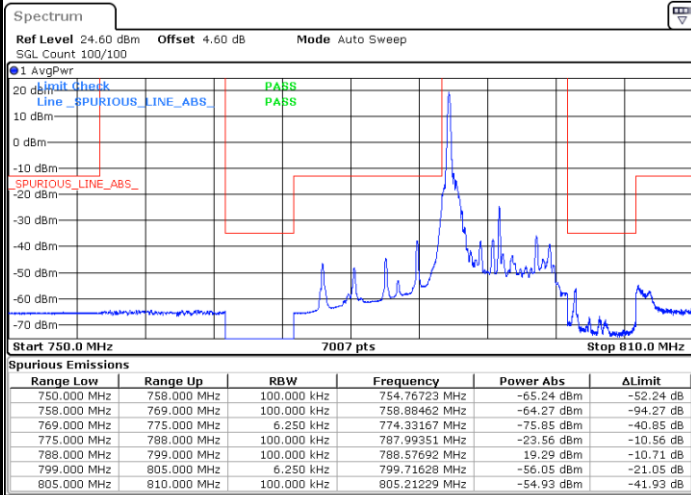

Date: 21. JAN. 2023 12:42:36

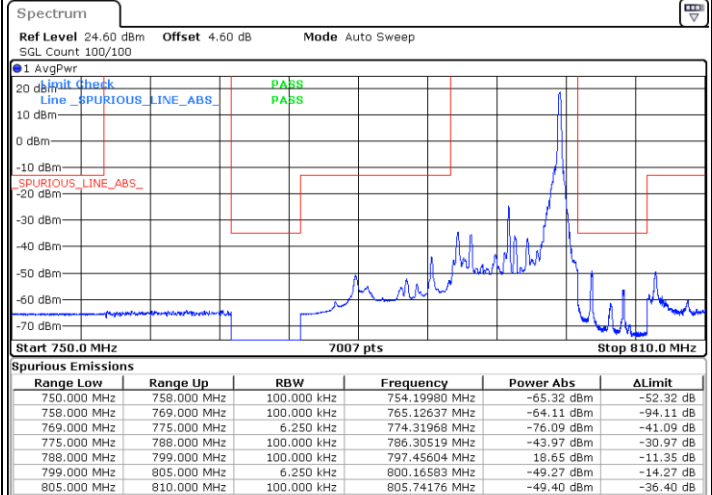

Date: 21. JAN. 2023 12:49:14

Band Edge / Full RB

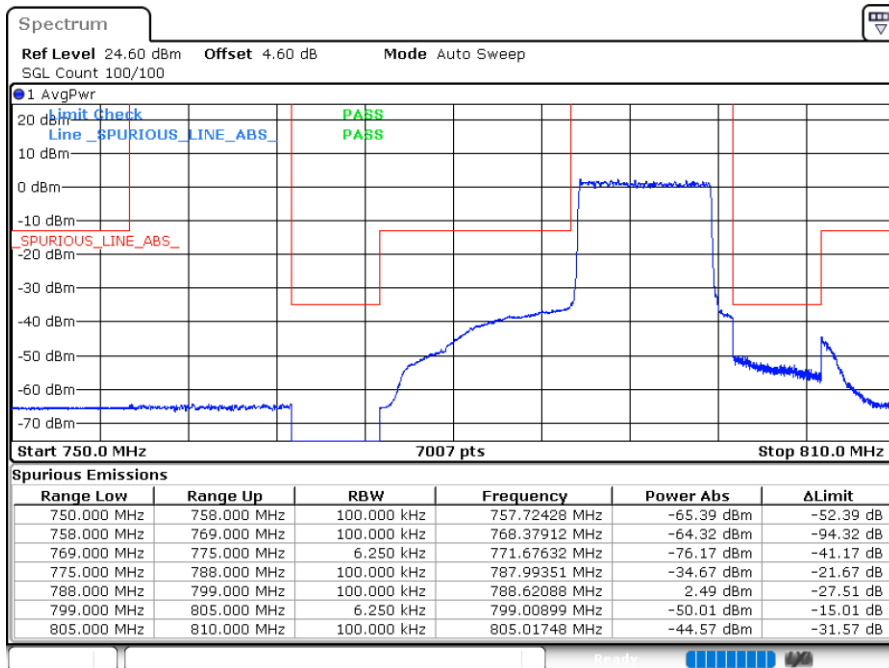

Date: 21. JAN. 2023 12:53:13





LTE Band 14 / 10MHz / 64QAM

Lowest Band Edge / 1 RB

Highest Band Edge / 1 RB

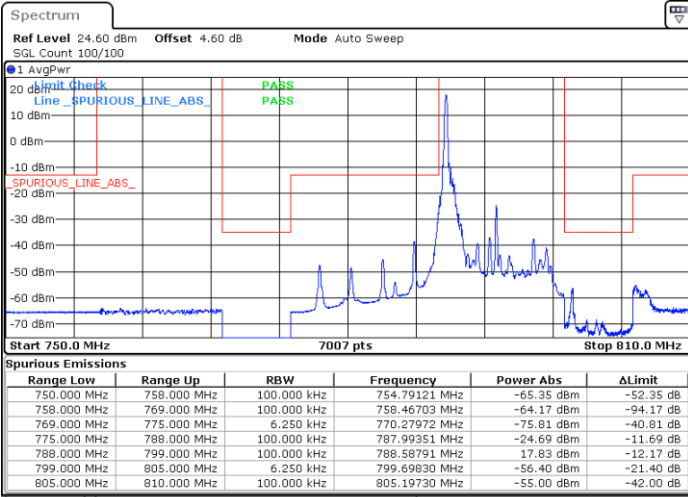

Date: 21.JAN.2023 12:43:55

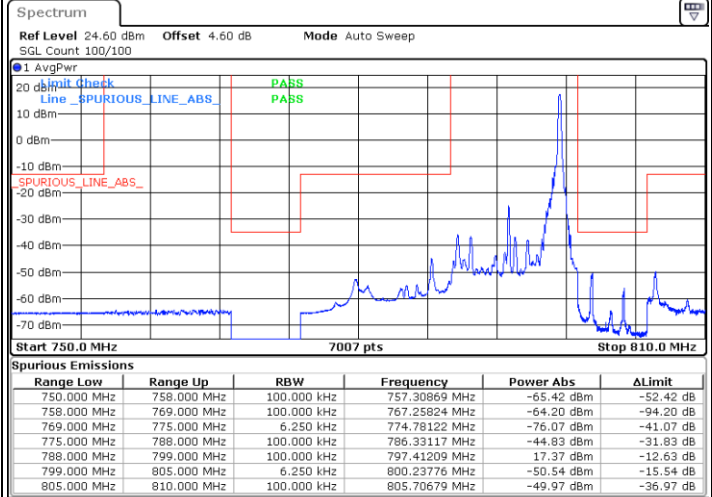

Date: 21.JAN.2023 12:47:54

Band Edge / Full RB

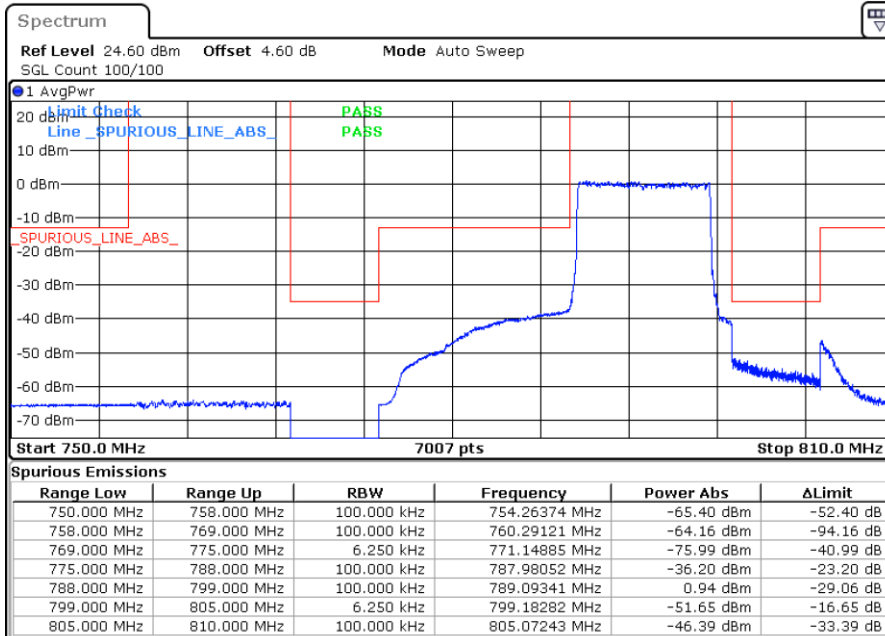

Date: 21.JAN.2023 12:54:33



LTE Band 14 / 10MHz / 256QAM

Lowest Band Edge / 1 RB

Highest Band Edge / 1 RB

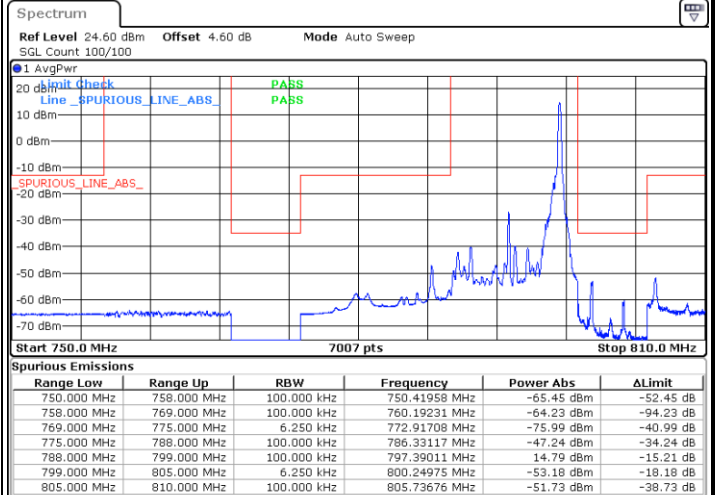
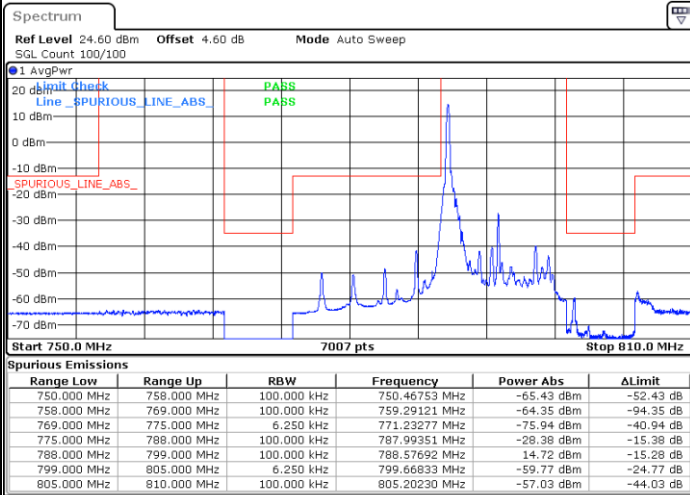

Date: 21.JAN.2023 12:45:15

Date: 21.JAN.2023 12:46:35

Band Edge / Full RB

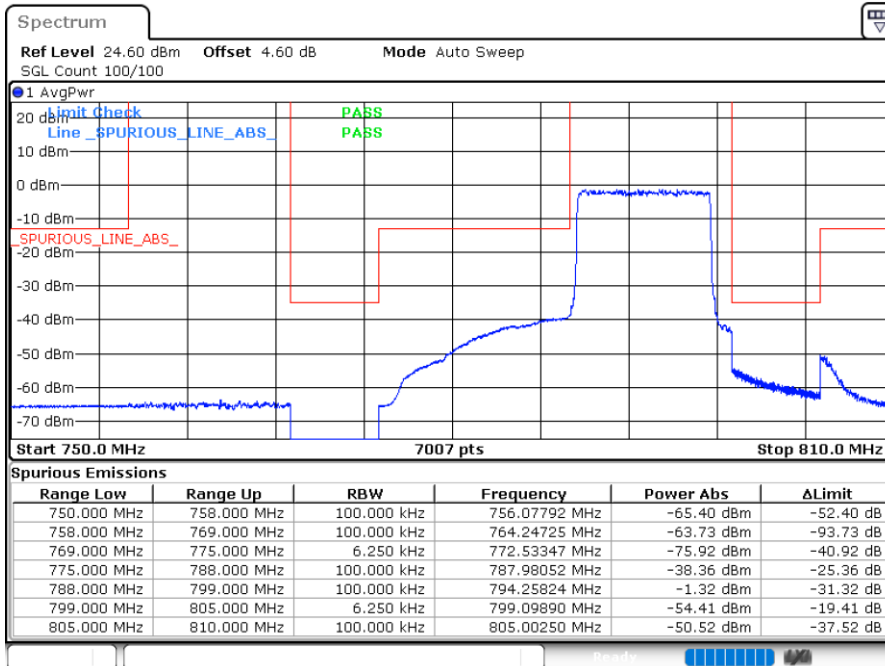

Date: 21.JAN.2023 12:55:52



# Conducted Spurious Emission

## LTE Band 14 / 5MHz

### Lowest Channel / QPSK

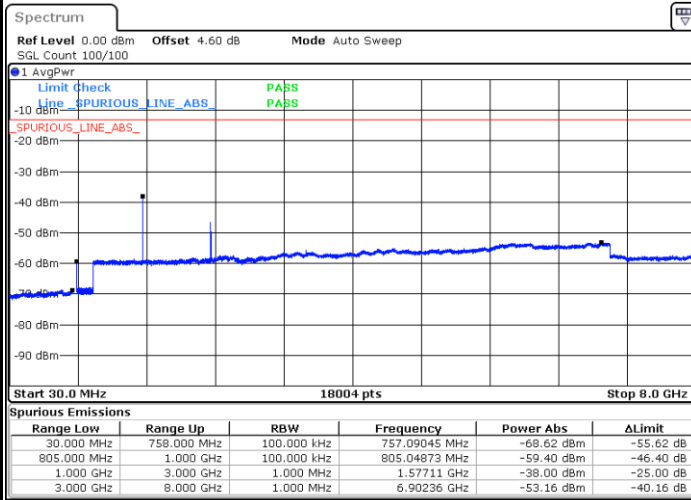

Date: 21.JAN.2023 12:04:14

### Middle Channel / QPSK

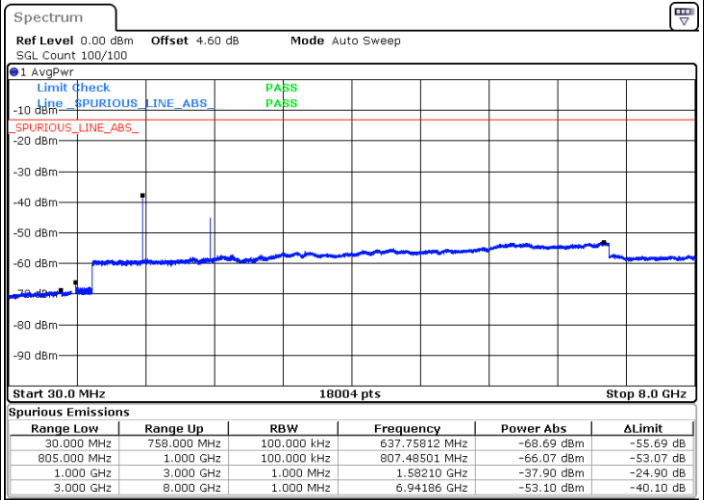

Date: 21.JAN.2023 12:24:57

### Highest Channel / QPSK

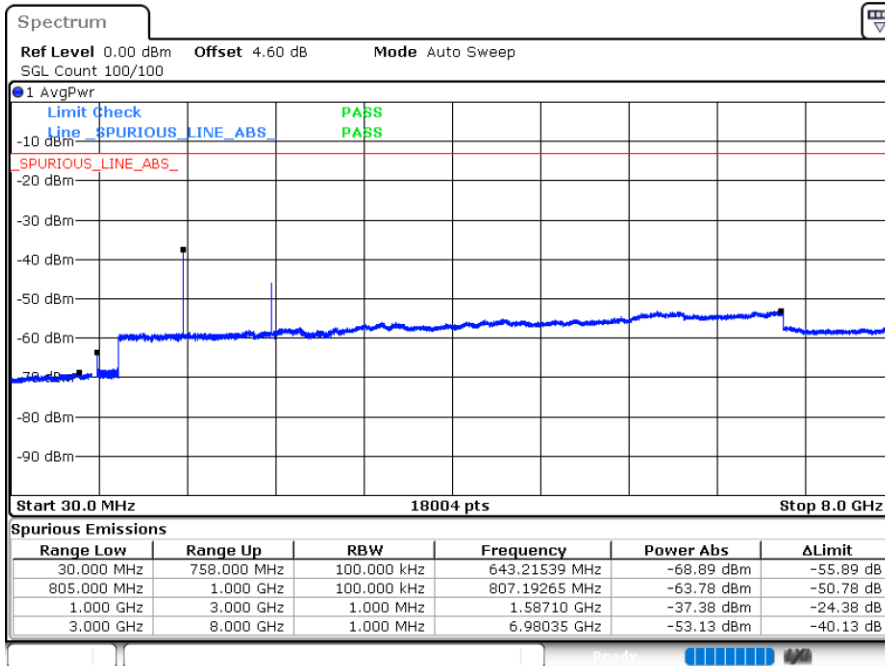

Date: 21.JAN.2023 12:25:46



LTE Band 14 / 10MHz

Middle Channel / QPSK

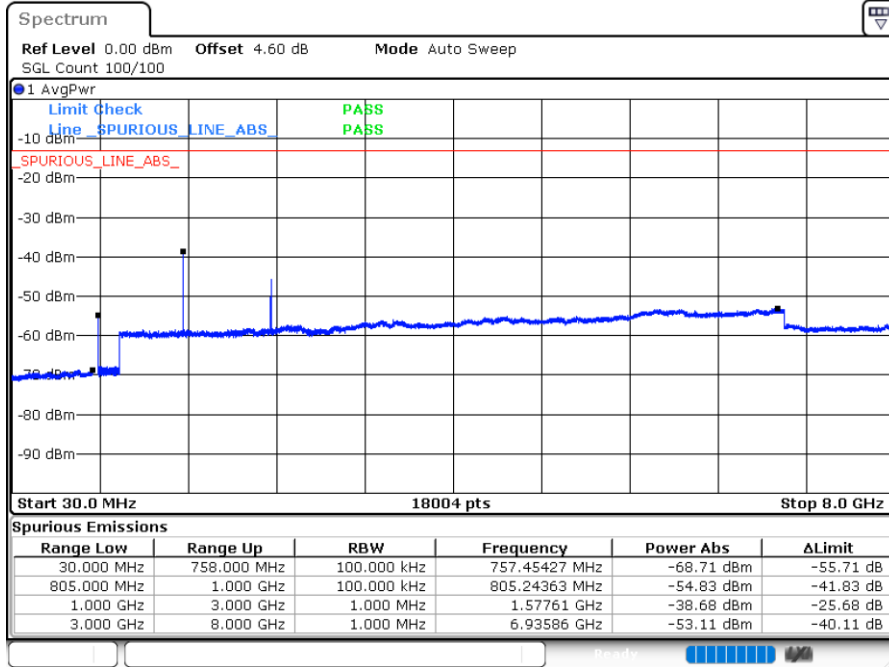

Date: 21 JAN 2023 12:39:57

# Emission Mask

## LTE Band 14 / 5MHz / QPSK

### Lowest Channel / 1RB

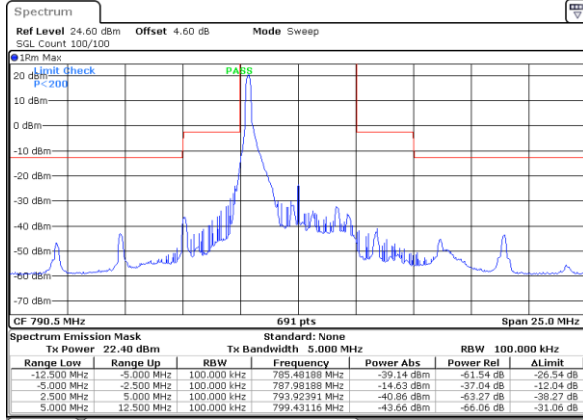

Date: 21.JAN.2023 13:02:09

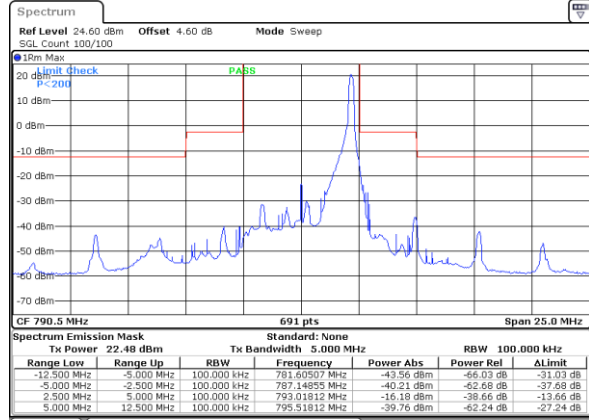

Date: 21.JAN.2023 11:58:35

### Lowest Channel / Full RB

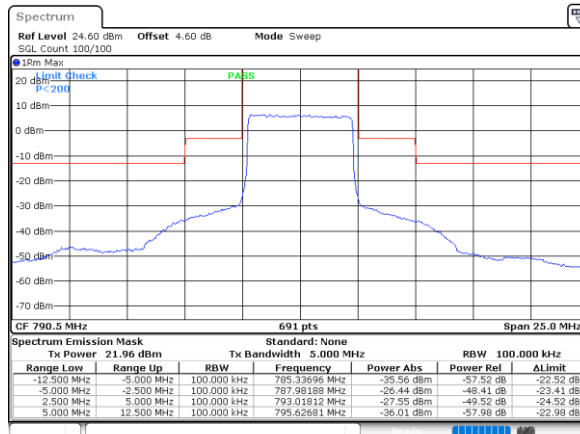

Date: 21.JAN.2023 11:56:58



LTE Band 14 / 5MHz / 16QAM

Lowest Channel / 1RB

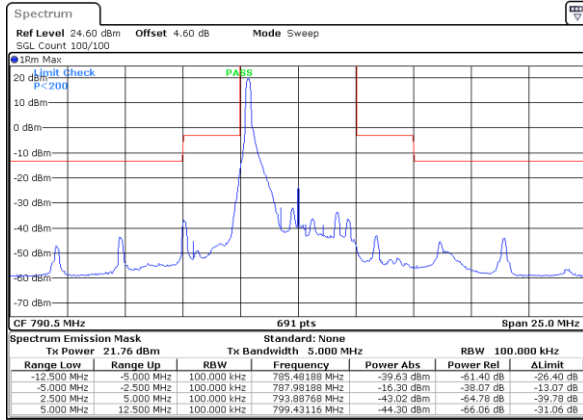

Date: 21.JAN.2023 11:47:04

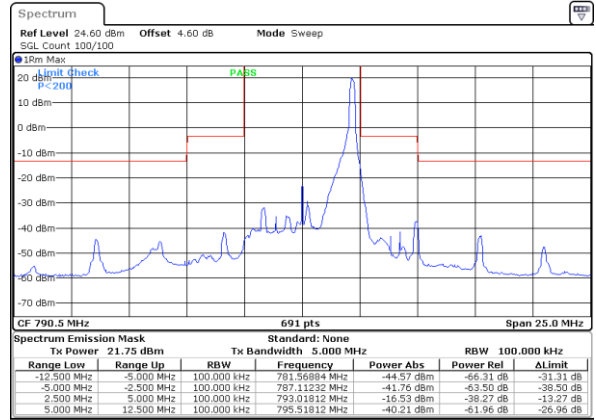

Date: 21.JAN.2023 12:00:12

Lowest Channel / Full RB

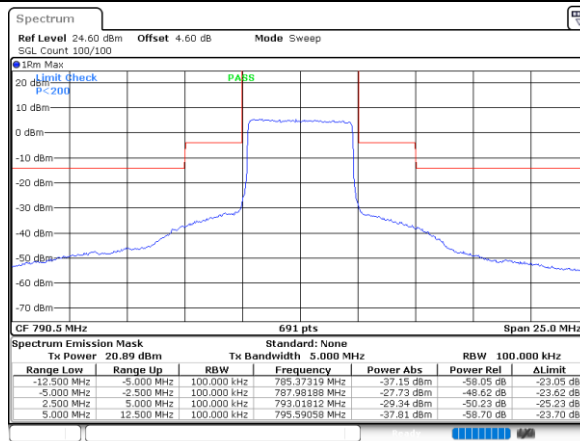

Date: 21.JAN.2023 11:55:21



LTE Band 14 / 5MHz / 64QAM

Lowest Channel / 1RB

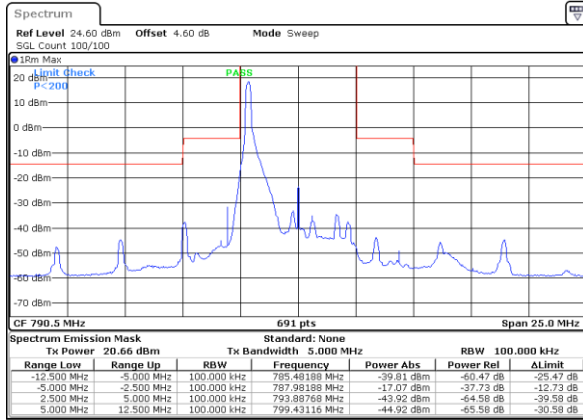

Date: 21.JAN.2023 11:48:41

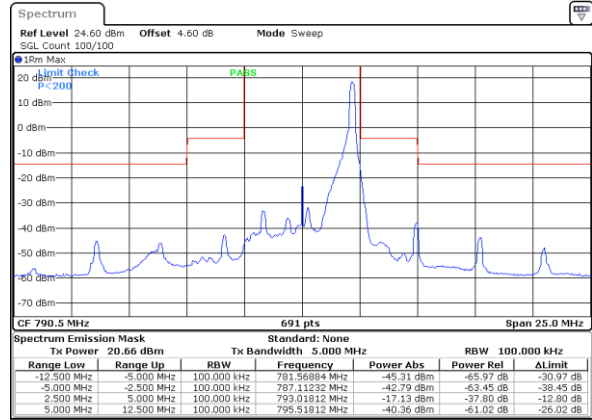

Date: 21.JAN.2023 12:01:49

Lowest Channel / Full RB

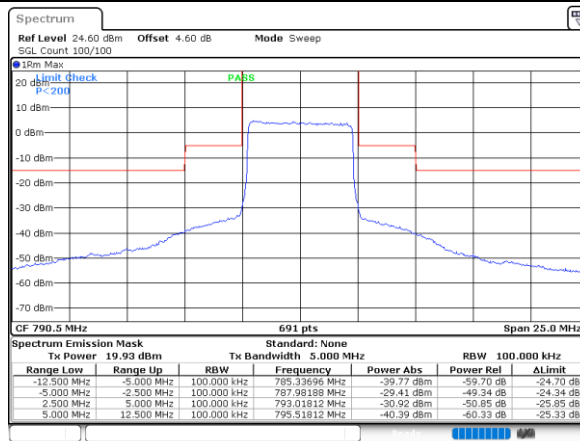

Date: 21.JAN.2023 11:53:44



LTE Band 14 / 5MHz / 256QAM

Lowest Channel / 1RB

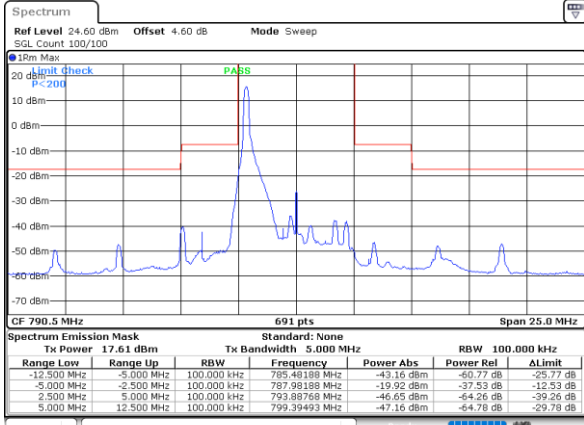

Date: 21.JAN.2023 11:50:18

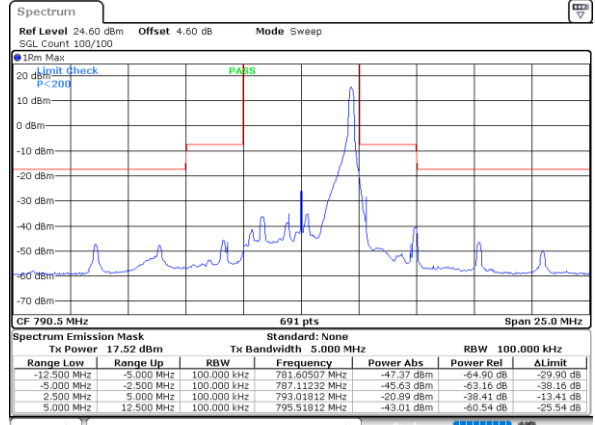

Date: 21.JAN.2023 12:03:26

Lowest Channel / Full RB

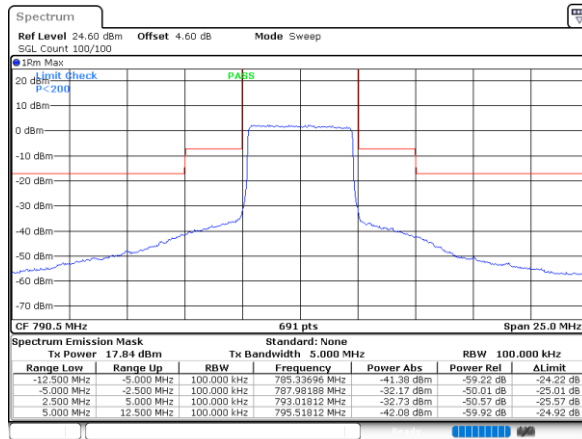

Date: 21.JAN.2023 14:42:02



**LTE Band 14 / 5MHz / QPSK**

**Middle Channel / 1RB**

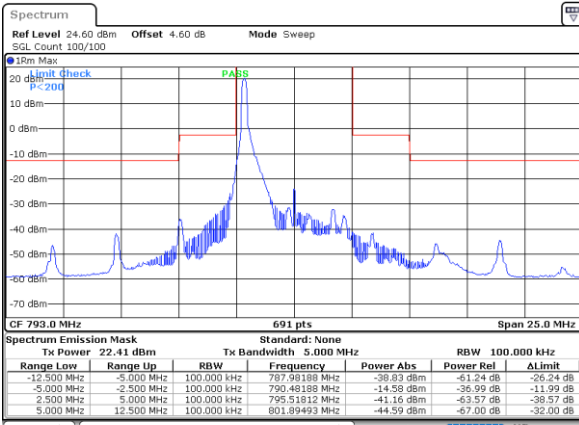

Date: 21.JAN.2023 13:03:46

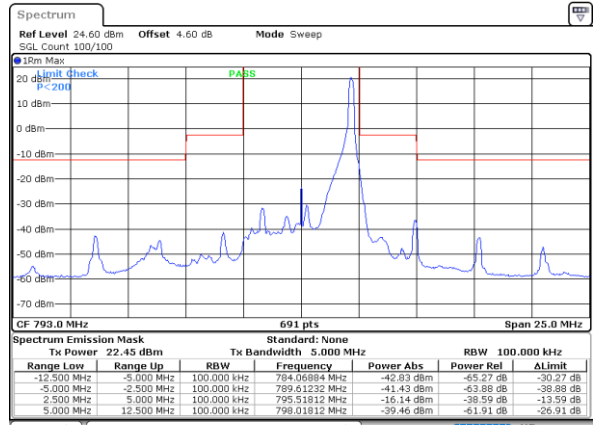

Date: 21.JAN.2023 13:15:02

**Middle Channel / Full RB**

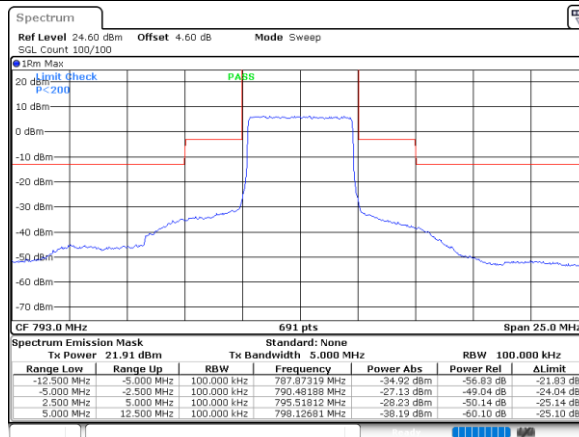

Date: 21.JAN.2023 13:16:38



LTE Band 14 / 5MHz / 16QAM

Middle Channel / 1RB

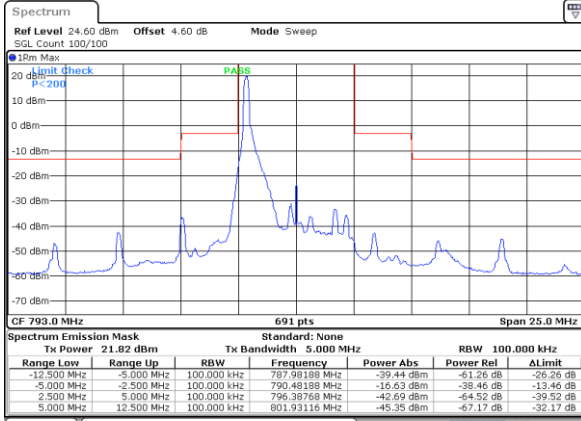

Date: 21.JAN.2023 13:05:23

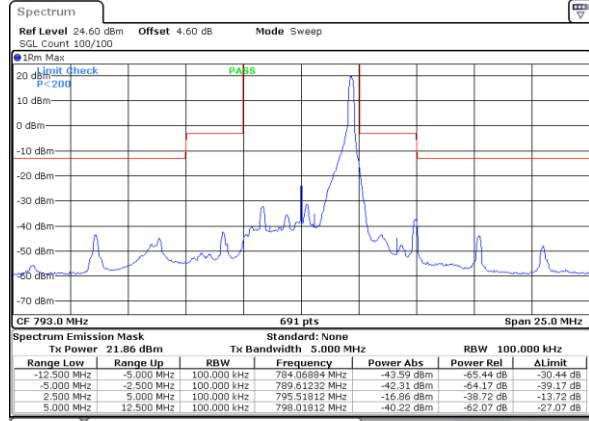

Date: 21.JAN.2023 13:11:25

Middle Channel / Full RB

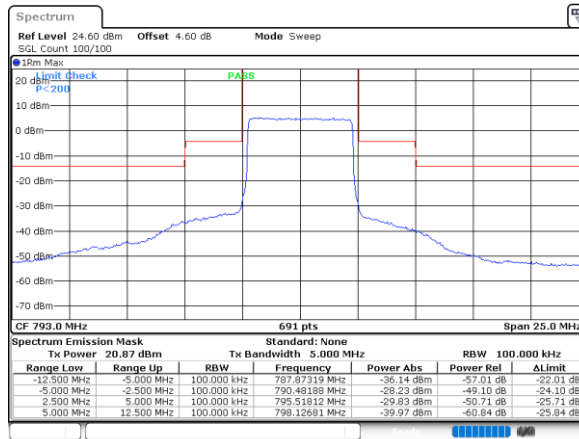

Date: 21.JAN.2023 13:18:15



LTE Band 14 / 5MHz / 64QAM

Middle Channel / 1RB

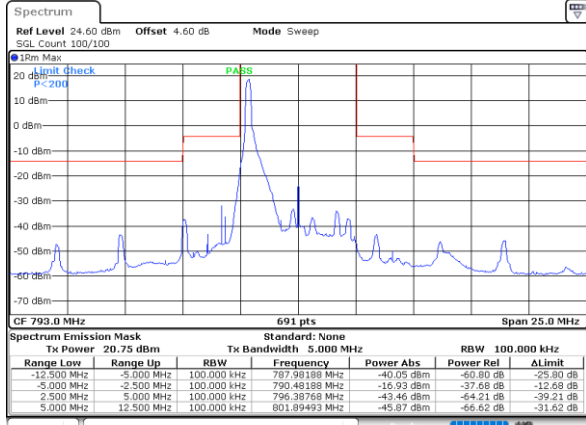

Date: 21.JAN.2023 13:06:59

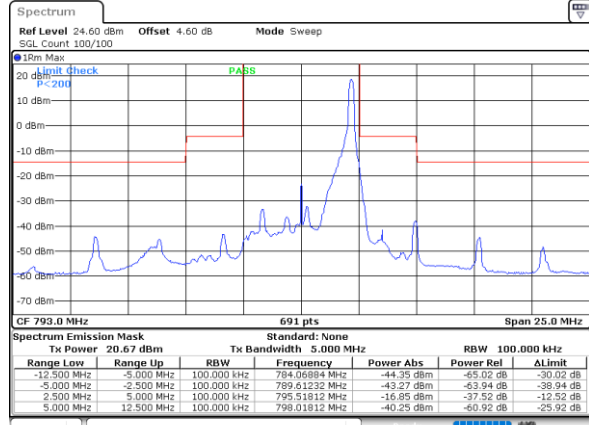

Date: 21.JAN.2023 13:11:49

Middle Channel / Full RB

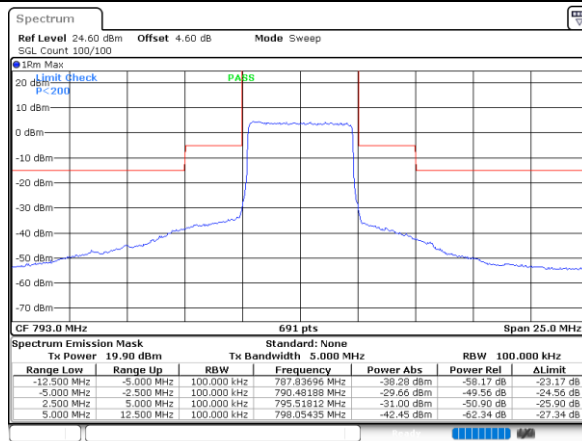

Date: 21.JAN.2023 13:19:51

**LTE Band 14 / 5MHz / 256QAM**

**Middle Channel / 1RB**

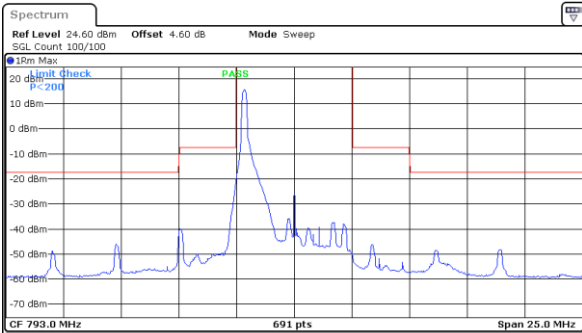

CF 793.0 MHz 691 pts Span 25.0 MHz

Spectrum Emission Mask		Standard: None		Tx Power 17.65 dBm		Tx Bandwidth 5.000 MHz		RBW 100.000 kHz	
Range Low	Range Up	RBW	Frequency	Power Abs	Power Rel	ALimit			
-12.500 MHz	-5.000 MHz	100.000 kHz	787.98188 MHz	-42.95 dBm	-60.60 dB	-25.60 dB			
-5.000 MHz	-2.500 MHz	100.000 kHz	790.48188 MHz	-20.02 dBm	-37.67 dB	-12.67 dB			
2.500 MHz	5.000 MHz	100.000 kHz	796.38768 MHz	-46.19 dBm	-63.84 dB	-38.84 dB			
5.000 MHz	12.500 MHz	100.000 kHz	801.89493 MHz	-48.22 dBm	-65.87 dB	-39.87 dB			

Date: 21.JAN.2023 13:10:13

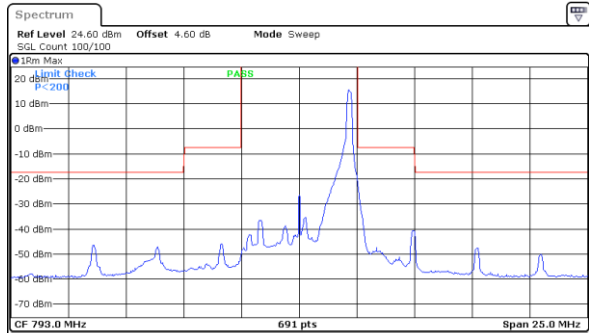

CF 793.0 MHz 691 pts Span 25.0 MHz

Spectrum Emission Mask		Standard: None		Tx Power 17.50 dBm		Tx Bandwidth 5.000 MHz		RBW 100.000 kHz	
Range Low	Range Up	RBW	Frequency	Power Abs	Power Rel	ALimit			
-12.500 MHz	-5.000 MHz	100.000 kHz	784.06894 MHz	-45.60 dBm	-64.11 dB	-29.10 dB			
-5.000 MHz	-2.500 MHz	100.000 kHz	789.61232 MHz	-45.83 dBm	-63.32 dB	-38.32 dB			
2.500 MHz	5.000 MHz	100.000 kHz	795.51812 MHz	-20.95 dBm	-38.45 dB	-13.45 dB			
5.000 MHz	12.500 MHz	100.000 kHz	798.01812 MHz	-43.13 dBm	-60.62 dB	-25.62 dB			

Date: 21.JAN.2023 13:10:12

**Middle Channel / Full RB**

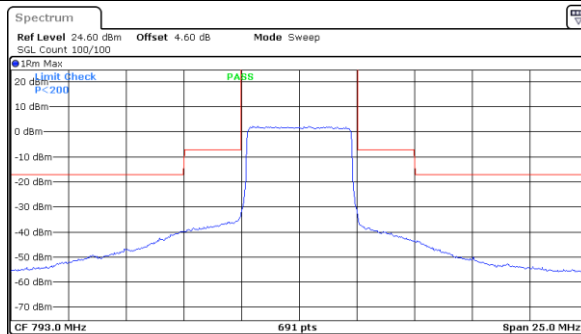

CF 793.0 MHz 691 pts Span 25.0 MHz

Spectrum Emission Mask		Standard: None		Tx Power 17.80 dBm		Tx Bandwidth 5.000 MHz		RBW 100.000 kHz	
Range Low	Range Up	RBW	Frequency	Power Abs	Power Rel	ALimit			
-12.500 MHz	-5.000 MHz	100.000 kHz	787.87319 MHz	-39.76 dBm	-57.56 dB	-22.56 dB			
-5.000 MHz	-2.500 MHz	100.000 kHz	790.48188 MHz	-32.19 dBm	-49.99 dB	-24.99 dB			
2.500 MHz	5.000 MHz	100.000 kHz	795.51812 MHz	-32.74 dBm	-50.54 dB	-25.54 dB			
5.000 MHz	12.500 MHz	100.000 kHz	798.12681 MHz	-43.53 dBm	-61.33 dB	-26.33 dB			

Date: 21.JAN.2023 13:21:28

**LTE Band 14 / 5MHz / QPSK**

**Highest Channel / 1RB**

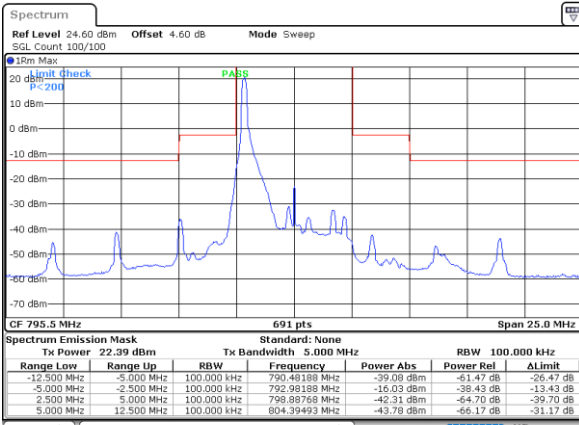

Date: 21.JAN.2023 13:13:18

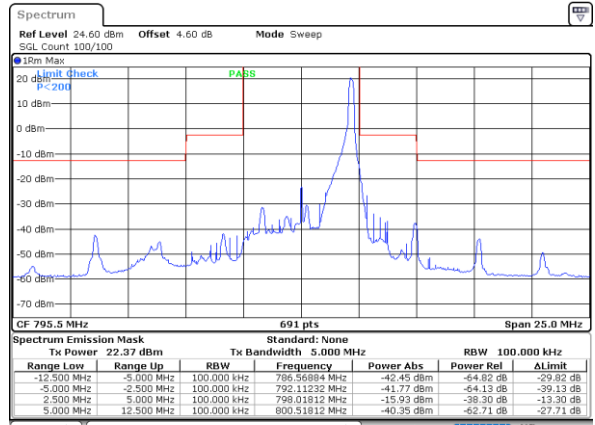

Date: 21.JAN.2023 13:44:27

**Highest Channel / Full RB**

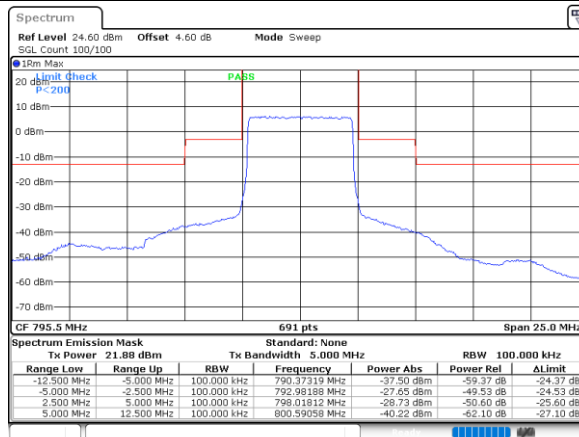

Date: 21.JAN.2023 14:02:15



LTE Band 14 / 5MHz / 16QAM

Highest Channel / 1RB

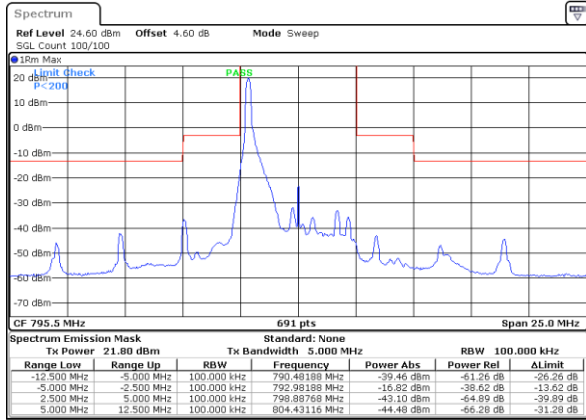

Date: 21.JAN.2023 13:36:50

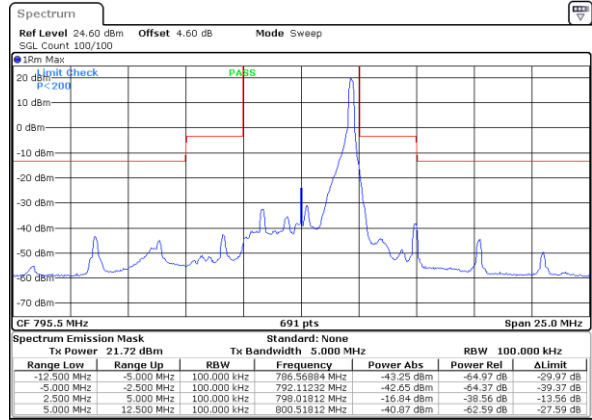

Date: 21.JAN.2023 13:46:59

Highest Channel / Full RB

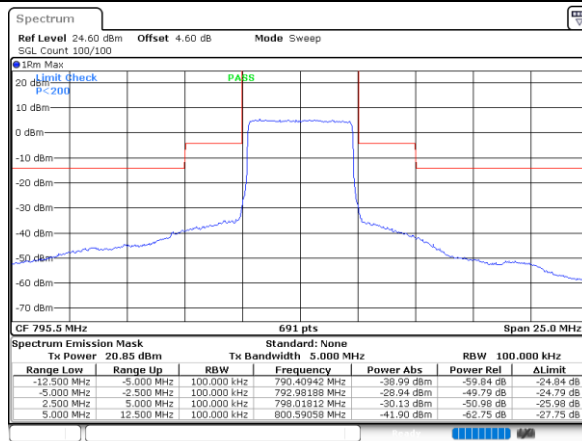

Date: 21.JAN.2023 13:59:43



LTE Band 14 / 5MHz / 64QAM

Highest Channel / 1RB

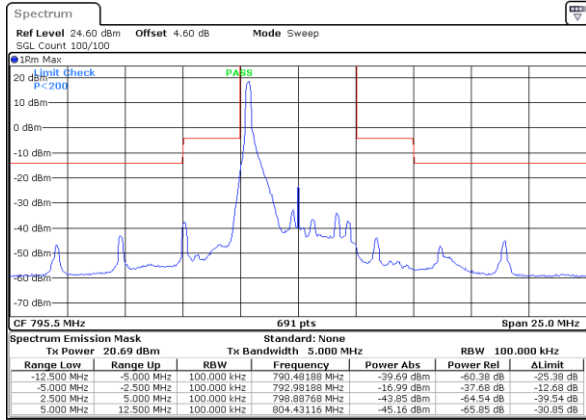

Date: 21.JAN.2023 13:39:23

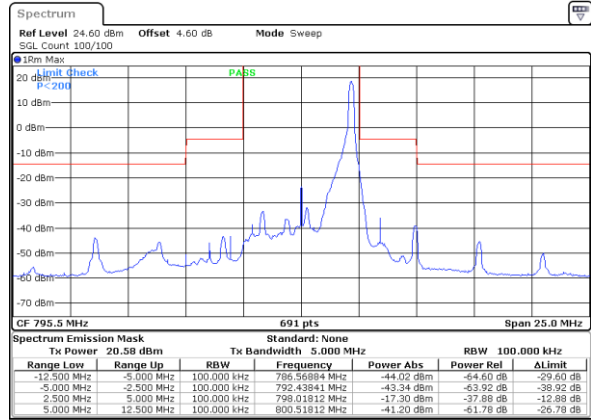

Date: 21.JAN.2023 13:49:32

Highest Channel / Full RB

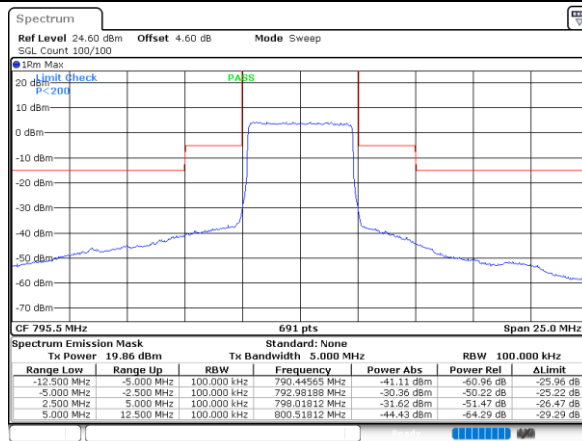

Date: 21.JAN.2023 13:57:11

**LTE Band 14 / 5MHz / 256QAM**

**Highest Channel / 1RB**

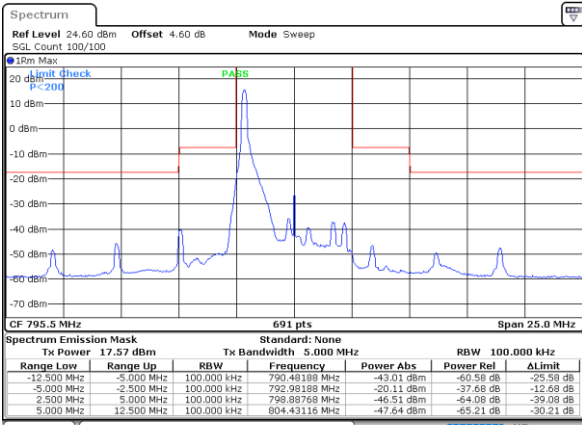

Date: 21.JAN.2023 13:41:55

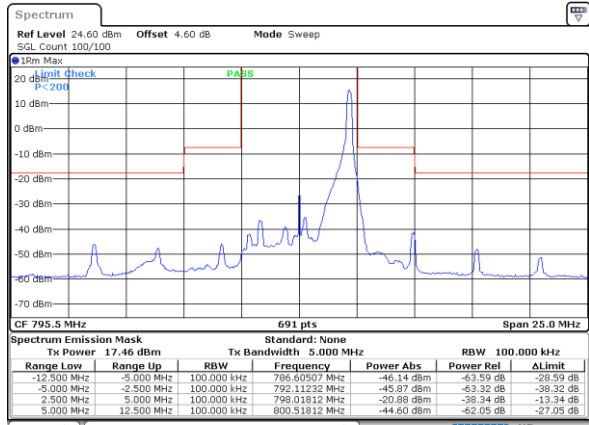

Date: 21.JAN.2023 13:52:04

**Highest Channel / Full RB**

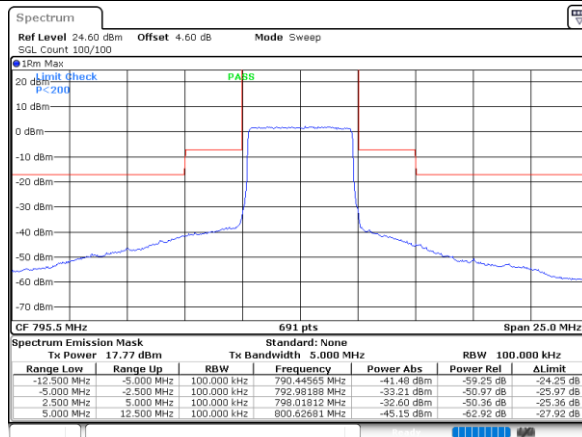

Date: 21.JAN.2023 14:46:57



**LTE Band 14 / 10MHz / QPSK**

**Middle Channel / 1RB**

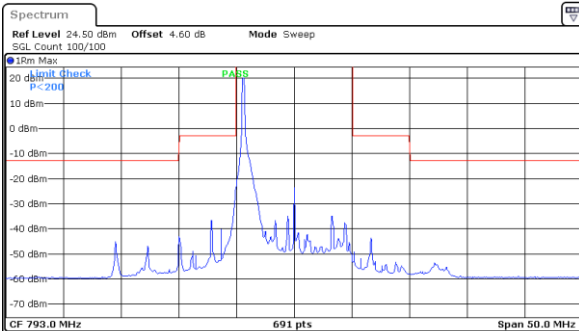

Spectrum Emission Mask		Standard: None		Tx Power 22.12 dBm		Tx Bandwidth 10.000 MHz		RBW 100.000 kHz	
Range Low	Range Up	RBW	Frequency	Power Abs	Power Rel	ALimit			
-25.000 MHz	-10.000 MHz	100.000 kHz	771.520999 MHz	-45.23 dBm	-57.40 dB	-32.40 dB			
-10.000 MHz	-5.000 MHz	100.000 kHz	787.963777 MHz	-23.18 dBm	-45.30 dB	-20.30 dB			
5.000 MHz	10.000 MHz	100.000 kHz	799.630433 MHz	-43.64 dBm	-65.76 dB	-40.76 dB			
10.000 MHz	25.000 MHz	100.000 kHz	805.137688 MHz	-53.51 dBm	-75.64 dB	-40.64 dB			

Date: 21.JAN.2023 14:04:48

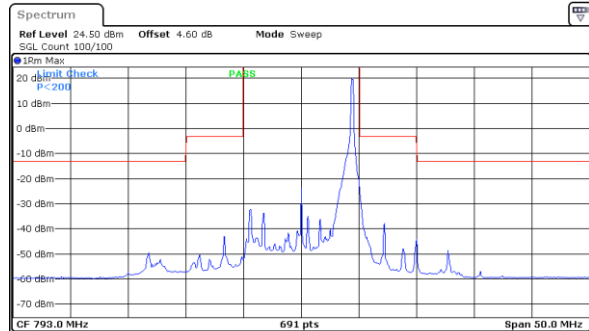

Spectrum Emission Mask		Standard: None		Tx Power 21.91 dBm		Tx Bandwidth 10.000 MHz		RBW 100.000 kHz	
Range Low	Range Up	RBW	Frequency	Power Abs	Power Rel	ALimit			
-25.000 MHz	-10.000 MHz	100.000 kHz	779.77536 MHz	-49.65 dBm	-71.56 dB	-36.56 dB			
-10.000 MHz	-5.000 MHz	100.000 kHz	786.29710 MHz	-43.19 dBm	-65.10 dB	-40.10 dB			
5.000 MHz	10.000 MHz	100.000 kHz	798.03623 MHz	-23.29 dBm	-45.20 dB	-20.20 dB			
10.000 MHz	25.000 MHz	100.000 kHz	803.03623 MHz	-46.44 dBm	-68.35 dB	-33.35 dB			

Date: 21.JAN.2023 14:22:28

**Middle Channel / Full RB**

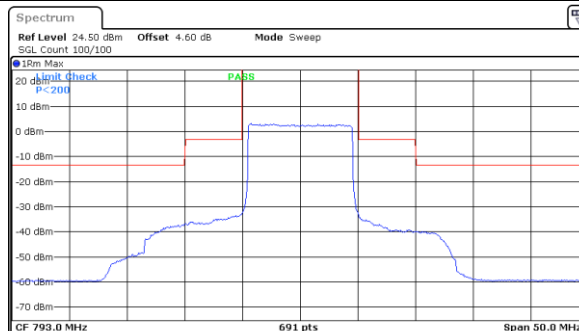

Spectrum Emission Mask		Standard: None		Tx Power 21.66 dBm		Tx Bandwidth 10.000 MHz		RBW 100.000 kHz	
Range Low	Range Up	RBW	Frequency	Power Abs	Power Rel	ALimit			
-25.000 MHz	-10.000 MHz	100.000 kHz	782.963777 MHz	-37.06 dBm	-58.72 dB	-23.72 dB			
-10.000 MHz	-5.000 MHz	100.000 kHz	787.963777 MHz	-32.69 dBm	-54.35 dB	-29.35 dB			
5.000 MHz	10.000 MHz	100.000 kHz	798.03623 MHz	-33.17 dBm	-54.83 dB	-29.83 dB			
10.000 MHz	25.000 MHz	100.000 kHz	803.03623 MHz	-39.91 dBm	-61.58 dB	-26.58 dB			

Date: 21.JAN.2023 14:25:00



LTE Band 14 / 10MHz / 16QAM

Middle Channel / 1RB

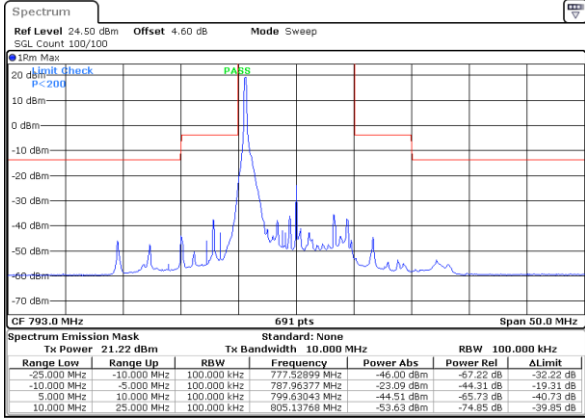

Date: 21.JAN.2023 14:07:19

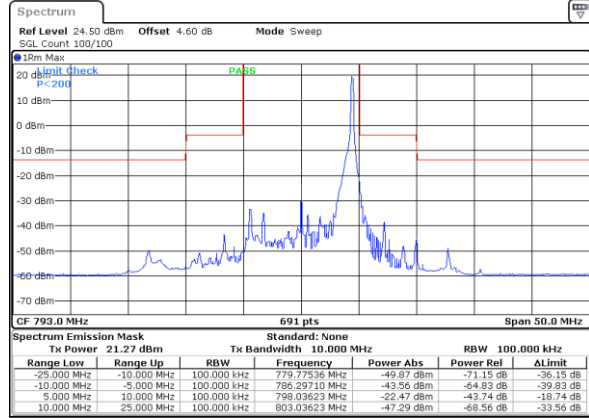

Date: 21.JAN.2023 14:19:56

Middle Channel / Full RB

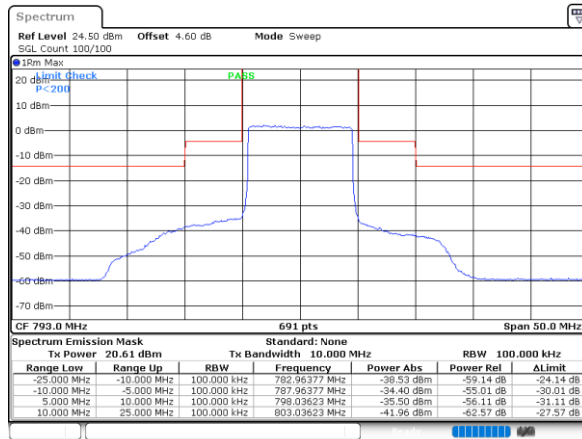

Date: 21.JAN.2023 14:27:31



LTE Band 14 / 10MHz / 64QAM

Middle Channel / 1RB

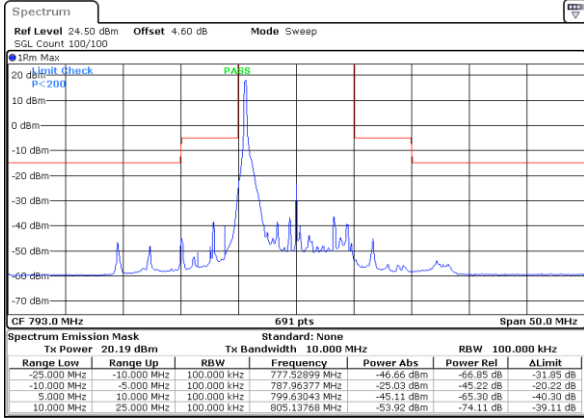

Date: 21.JAN.2023 14:09:51

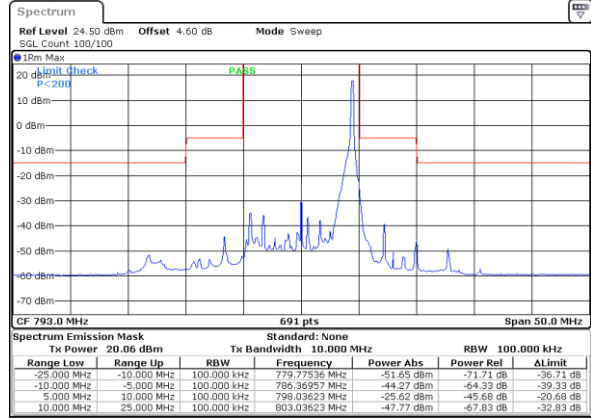

Date: 21.JAN.2023 14:17:25

Middle Channel / Full RB

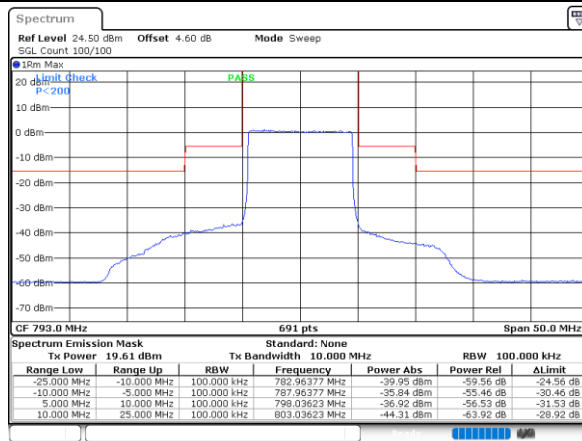

Date: 21.JAN.2023 14:30:03



LTE Band 14 / 10MHz / 256QAM

Middle Channel / 1RB

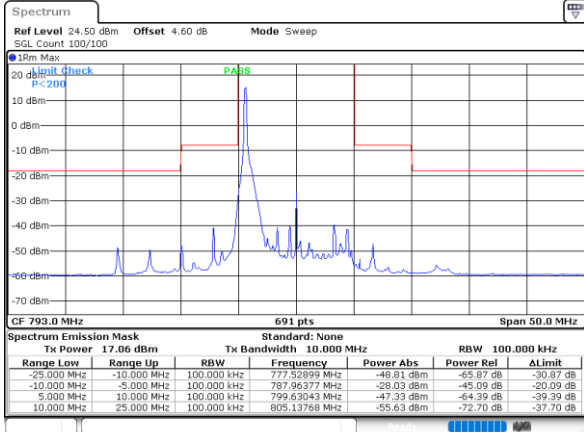

Date: 21.JAN.2023 14:12:22

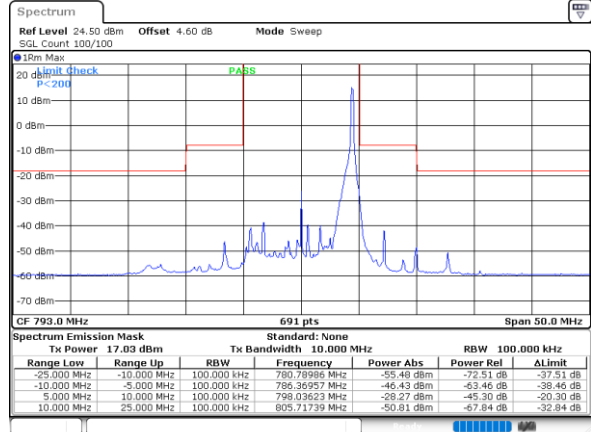

Date: 21.JAN.2023 14:14:54

Middle Channel / Full RB

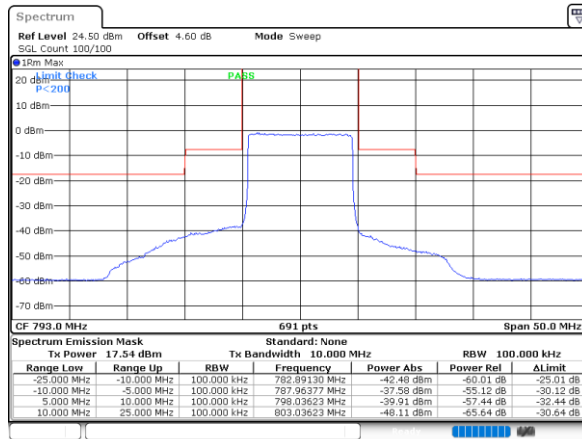

Date: 21.JAN.2023 14:32:34

**Frequency Stability**

Test Conditions		LTE Band 14 (QPSK) / Middle Channel	Limit
Temperature (°C)	Voltage (Volt)	BW 5MHz	Note 2.
		Deviation (ppm)	Result
50	Normal Voltage	0.0026	PASS
40	Normal Voltage	0.0021	
30	Normal Voltage	0.0043	
20(Ref.)	Normal Voltage	0.0000	
10	Normal Voltage	0.0008	
0	Normal Voltage	0.0026	
-10	Normal Voltage	0.0016	
-20	Normal Voltage	0.0013	
-30	Normal Voltage	0.0027	
20	Maximum Voltage	0.0009	
20	Normal Voltage	0.0046	
20	Battery End Point	0.0012	

**Note:**

1. Normal Voltage =3.8 V. ; Battery End Point (BEP) =3.3 V. ; Maximum Voltage =4.3 V.
2. Note: The frequency fundamental emissions stay within the authorized frequency block.



Test Conditions		LTE Band 14 (QPSK) / Middle Channel	Limit
Temperature (°C)	Voltage (Volt)	BW 10MHz	Note 2.
		Deviation (ppm)	Result
50	Normal Voltage	0.0024	PASS
40	Normal Voltage	0.0022	
30	Normal Voltage	0.0048	
20(Ref.)	Normal Voltage	0.0000	
10	Normal Voltage	0.0005	
0	Normal Voltage	0.0026	
-10	Normal Voltage	0.0017	
-20	Normal Voltage	0.0015	
-30	Normal Voltage	0.0023	
20	Maximum Voltage	0.0006	
20	Normal Voltage	0.0047	
20	Battery End Point	0.0013	

**Note:**

- 1. Normal Voltage =3.8 V. ; Battery End Point (BEP) =3.3 V. ; Maximum Voltage =4.3 V.
- 2. Note: The frequency fundamental emissions stay within the authorized frequency block.



### Appendix B. Test Results of Radiated Test

#### Field Strength of Spurious Radiated

Test Engineer :	Carry Xu	Temperature :	23~25°C
		Relative Humidity :	41~42%

LTE Band 14 / QPSK / RB Size 1 Offset 0									
Channel	Bandwidth	Frequency ( MHz )	ERP ( dBm )	Limit ( dBm )	Over Limit ( dB )	S.G. Power ( dBm )	TX Cable loss ( dB )	TX Antenna Gain (dBi)	Polarization (H/V)
Low	5MHz	1576	-59.48	-42.15	-17.33	-62.11	1.09	5.87	H
		2368	-62.97	-13	-49.97	-65.37	1.37	5.92	H
		3152	-61.05	-13	-48.05	-64.94	1.64	7.68	H
		1576	-60.15	-42.15	-18.00	-62.78	1.09	5.87	V
		2368	-61.14	-13	-48.14	-63.54	1.37	5.92	V
		3152	-60.88	-13	-47.88	-64.77	1.64	7.68	V
Middle	5MHz	1584	-58.17	-42.15	-16.02	-60.80	1.09	5.87	H
		2376	-62.70	-13	-49.70	-65.10	1.37	5.92	H
		3160	-60.86	-13	-47.86	-64.75	1.64	7.68	H
		1584	-65.09	-42.15	-22.94	-67.72	1.09	5.87	V
		2376	-61.43	-13	-48.43	-63.83	1.37	5.92	V
		3160	-60.81	-13	-47.81	-64.70	1.64	7.68	V
High	5MHz	1584	-65.67	-42.15	-23.52	-68.30	1.09	5.87	H
		2376	-62.75	-13	-49.75	-65.15	1.37	5.92	H
		3176	-61.04	-13	-48.04	-64.93	1.64	7.68	H
		1584	-66.89	-42.15	-24.74	-69.52	1.09	5.87	V
		2376	-61.09	-13	-48.09	-63.49	1.37	5.92	V
		3176	-61.00	-13	-48.00	-64.89	1.64	7.68	V
Remark: Spurious emissions within 30-1000MHz were found more than 20dB below limit line.									
Test Result					PASS				



LTE Band 14 / QPSK / RB Size 1 Offset 0									
Channel	Bandwidth	Frequency ( MHz )	ERP ( dBm )	Limit ( dBm )	Over Limit ( dB )	S.G. Power ( dBm )	TX Cable loss ( dB )	TX Antenna Gain (dBi)	Polarization (H/V)
Middle	10MHz	1576	-58.62	-42.15	-16.47	-61.25	1.09	5.87	H
		2368	-62.60	-13	-49.60	-65.00	1.37	5.92	H
		3152	-60.69	-13	-47.69	-64.58	1.64	7.68	H
		1576	-59.99	-42.15	-17.84	-62.62	1.09	5.87	V
		2368	-61.63	-13	-48.63	-64.03	1.37	5.92	V
		3152	-60.63	-13	-47.63	-64.52	1.64	7.68	V
Remark: Spurious emissions within 30-1000MHz were found more than 20dB below limit line.									
Test Result					PASS				