

# RF TEST REPORT

<b>Applicant</b>	Quectel Wireless Solutions Company Limited
<b>FCC ID</b>	XMR2023HCM511S
<b>Product</b>	Bluetooth Module
<b>Brand</b>	Quectel
<b>Model</b>	HCM511S
<b>Report No.</b>	R2310A1164-R1V2
<b>Issue Date</b>	January 2, 2024

TA Technology (Shanghai) Co., Ltd. tested the above equipment in accordance with the requirements in **FCC CFR47 Part 15C (2022)**. The test results show that the equipment tested is capable of demonstrating compliance with the requirements as documented in this report.

*Prepared by: Zhu Chentao*

*Approved by: Xu Kai*

## TA Technology (Shanghai) Co., Ltd.

*Building 3, No.145, Jintang Rd, Pudong Shanghai, P.R.China*

*TEL: +86-021-50791141/2/3*

*FAX: +86-021-50791141/2/3-8000*

## TABLE OF CONTENT

1. Test Laboratory .....	5
1.1. Notes of the Test Report .....	5
1.2. Test Facility .....	5
1.3. Testing Location .....	5
2. General Description of Equipment Under Test .....	6
2.1. Applicant and Manufacturer Information .....	6
2.2. General Information .....	6
3. Applied Standards .....	7
4. Test Configuration .....	8
5. Test Case Results .....	9
5.1. Maximum output power .....	9
5.2. 99% Bandwidth and 6dB Bandwidth .....	11
5.3. Band Edge .....	19
5.4. Power Spectral Density .....	24
5.5. Spurious RF Conducted Emissions .....	30
5.6. Unwanted Emission .....	38
5.7. Conducted Emission .....	52
6. Main Test Instruments .....	55
ANNEX A: The EUT Appearance .....	56
ANNEX B: Test Setup Photos .....	57

Version	Revision Description	Issue Date
Rev.0	Initial issue of report.	December 18, 2023
Rev.1	Update information.	December 28, 2023
Rev.2	Update information.	January 2, 2024
Note: This revised report (Report No.: R2310A1164-R1V2) supersedes and replaces the previously issued report (Report No.: R2310A1164-R1V1). Please discard or destroy the previously issued report and dispose of it accordingly.		

## Summary of Measurement Results

Number	Test Case	Clause in FCC rules	Verdict
1	Maximum output power	15.247(b)(3)	PASS
2	99% Bandwidth and 6dB Bandwidth	15.247(a)(2) C63.10 6.9	PASS
3	Power spectral density	15.247(e)	PASS
4	Band Edge	15.247(d)	PASS
5	Spurious RF Conducted Emissions	15.247(d)	PASS
6	Unwanted Emissions	15.247(d), 15.205, 15.209	PASS
7	Conducted Emissions	15.207	PASS
Date of Testing: November 28, 2023 ~ December 5, 2023			
Date of Sample Received: November 2, 2023			
Note: All indications of Pass/Fail in this report are opinions expressed by TA Technology (Shanghai) Co., Ltd. based on interpretations and/or observations of test results. Measurement Uncertainties were not taken into account and are published for informational purposes only.			

## 1. Test Laboratory

### 1.1. Notes of the Test Report

This report shall not be reproduced in full or partial, without the written approval of **TA Technology (Shanghai) Co., Ltd.** The results documented in this report apply only to the tested sample, under the conditions and modes of operation as described herein. Measurement Uncertainties were not taken into account and are published for informational purposes only. This report is written to support regulatory compliance of the applicable standards stated above.

### 1.2. Test Facility

#### **FCC (Designation number: CN1179, Test Firm Registration Number: 446626)**

TA Technology (Shanghai) Co., Ltd. has been listed on the US Federal Communications Commission list of test facilities recognized to perform measurements.

#### **A2LA (Certificate Number: 3857.01)**

TA Technology (Shanghai) Co., Ltd. has been listed by American Association for Laboratory Accreditation to perform measurement.

### 1.3. Testing Location

Company: TA Technology (Shanghai) Co., Ltd.  
 Address: Building 3, No.145, Jintang Rd, Pudong Shanghai, P.R.China  
 City: Shanghai  
 Post code: 201201  
 Country: P. R. China  
 Contact: Xu Kai  
 Telephone: +86-021-50791141/2/3  
 Fax: +86-021-50791141/2/3-8000  
 Website: <http://www.ta-shanghai.com>  
 E-mail: [xukai@ta-shanghai.com](mailto:xukai@ta-shanghai.com)

## 2. General Description of Equipment Under Test

### 2.1. Applicant and Manufacturer Information

Applicant	Quectel Wireless Solutions Company Limited
Applicant address	Building 5, Shanghai Business Park Phase III (Area B), No.1016 Tianlin Road, Minhang District, Shanghai, China, 200233
Manufacturer	Quectel Wireless Solutions Company Limited
Manufacturer address	Building 5, Shanghai Business Park Phase III (Area B), No.1016 Tianlin Road, Minhang District, Shanghai, China, 200233

### 2.2. General Information

EUT Description		
Model	HCM511S	
SN	Conducted	E1N23JB0C000060
	Radiated	E1N23KP0E000034
Hardware Version	R1.0	
Software Version	NA	
Power Supply	External power supply	
Antenna Type	PCB Antenna	
Antenna Connector	A permanently attached antenna (meet with the standard FCC Part 15.203 requirement)	
Antenna Gain	-0.5 dBi	
Additional Beamforming Gain	NA	
Operating Frequency Range(s)	Bluetooth LE V5.4: 2402 ~2480 MHz	
Modulation Type	Bluetooth LE: GFSK	
Max. Output Power	Bluetooth LE: 6.05 dBm	
Auxiliary test equipment		
PC	Manufacturer: DELL Model: Latitude 3301 SN: 1Q6DJW2	
Mother board	Manufacturer: Quectel Wireless Solutions Company Limited Model: /	
Note: 1. The EUT is sent from the applicant to TA and the information of the EUT is declared by the applicant.		

### 3. Applied Standards

According to the specifications of the manufacturer, it must comply with the requirements of the following standards:

**Test standards:**

**FCC CFR47 Part 15C (2022) Radio Frequency Devices**

**ANSI C63.10-2013**

**Reference standard:**

**KDB 558074 D01 15.247 Meas Guidance v05r02**

## 4. Test Configuration

### Test Mode

The EUT has been associated with peripherals and configuration operated in a manner tended to maximize its emission characteristics in a typical application.

The radiated emission was measured in the following position: EUT stand-up position (vertical), lie-down position (horizontal). The worst emission was found in stand-up position (horizontal) and the worst case was recorded.

In order to find the worst case condition, Pre-tests are needed at the presence of different data rate. Preliminary tests have been done on all the configuration for confirming worst case. Data rate below means worst-case rate of each test item.

Worst-case data rates are shown as following table.

Test Mode	Data Rate
Bluetooth(Low Energy)	1Mbps; 2Mbps



## 5. Test Case Results

### 5.1. Maximum output power

#### Ambient Condition

Temperature	Relative humidity
15°C ~ 35°C	20% ~ 80%

#### Methods of Measurement

During the process of the testing, The EUT was connected to Power meter with a known loss. The EUT is max power transmission with proper modulation.

#### Test Setup

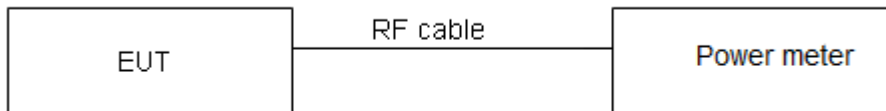

#### Limits

Rule Part 15.247 (b) (3) specifies that " For systems using digital modulation in the 902–928 MHz, 2400–2483.5 MHz: 1 Watt."

Average Output Power	$\leq 1W$ (30dBm)
----------------------	-------------------

#### Measurement Uncertainty

The assessed measurement uncertainty to ensure 95% confidence level for the normal distribution is with the coverage factor  $k = 2$ ,  $U = 0.44$  dB.

## Test Results

Power Index	
Channel	Bluetooth (Low Energy)
CH0	6
CH19	6
CH39	6

Test Mode	Duty cycle	Duty cycle correction Factor (dB)
Bluetooth LE (1M)	0.855	0.68
Bluetooth LE (2M)	0.576	2.39

Note: when Duty cycle  $\geq 0.98$ , Duty cycle correction Factor not required.

Test Mode	Carrier frequency (MHz) / Channel	Average Power Measured (dBm)	Average Power with duty factor (dBm)	Limit (dBm)	Conclusion
Bluetooth (Low Energy) (1M)	2402/CH0	5.30	5.98	30	PASS
	2440/CH19	5.22	5.90	30	PASS
	2480/CH39	5.27	5.95	30	PASS
Bluetooth (Low Energy) (2M)	2402/CH0	3.66	6.05	30	PASS
	2440/CH19	3.66	6.05	30	PASS
	2480/CH39	3.55	5.94	30	PASS

Note: Average Power with duty factor = Average Power Measured + Duty cycle correction factor

## 5.2. 99% Bandwidth and 6dB Bandwidth

### Ambient Condition

Temperature	Relative humidity
15°C ~ 35°C	20% ~ 80%

### Method of Measurement

The EUT was connected to the spectrum analyzer through an external attenuator (20dB) and a known loss cable. RBW is set to 100 kHz; VBW is set to 300 kHz on spectrum analyzer. Dector=Peak, Trace mode=max hold.

The EUT was connected to the spectrum analyzer through a known loss cable. The resolution bandwidth (RBW) shall be in the range of 1% to 5% of the actual occupied / x dB bandwidth and the video bandwidth (VBW) shall not be smaller than three times the RBW value.

### Test Setup

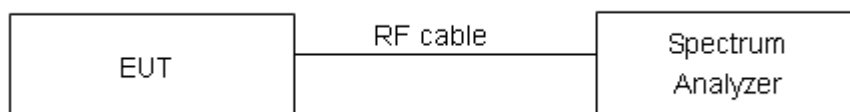

### Limits

Rule Part 15.247 (a) (2) specifies that “Systems using digital modulation techniques may operate in the 902–928 MHz, 2400–2483.5 MHz bands. The minimum 6 dB bandwidth shall be at least 500 kHz.”

minimum 6 dB bandwidth	≥ 500 kHz
------------------------	-----------

### Measurement Uncertainty

The assessed measurement uncertainty to ensure 95% confidence level for the normal distribution is with the coverage factor  $k = 2$ ,  $U = 936$  Hz.

**Test Results:**

Test Mode	Carrier frequency (MHz)	99% bandwidth (MHz)	Minimum 6 dB bandwidth (MHz)	Limit (kHz)	Conclusion
Bluetooth (Low Energy) (1M)	2402	1.019	0.640	500	PASS
	2440	1.018	0.648	500	PASS
	2480	1.020	0.639	500	PASS
Bluetooth (Low Energy) (2M)	2402	2.035	1.131	500	PASS
	2440	2.029	1.103	500	PASS
	2480	2.026	1.163	500	PASS

99%bandwidth

OBW Bluetooth LE(1M) 2402MHz

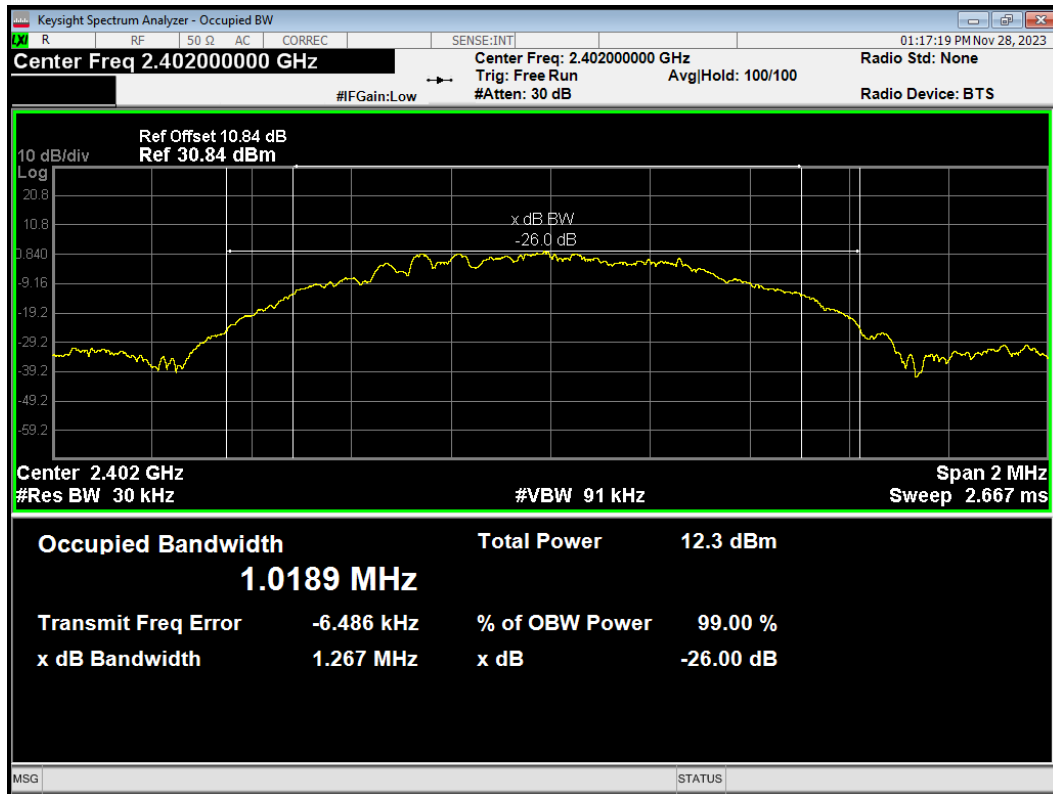

OBW Bluetooth LE(1M) 2440MHz

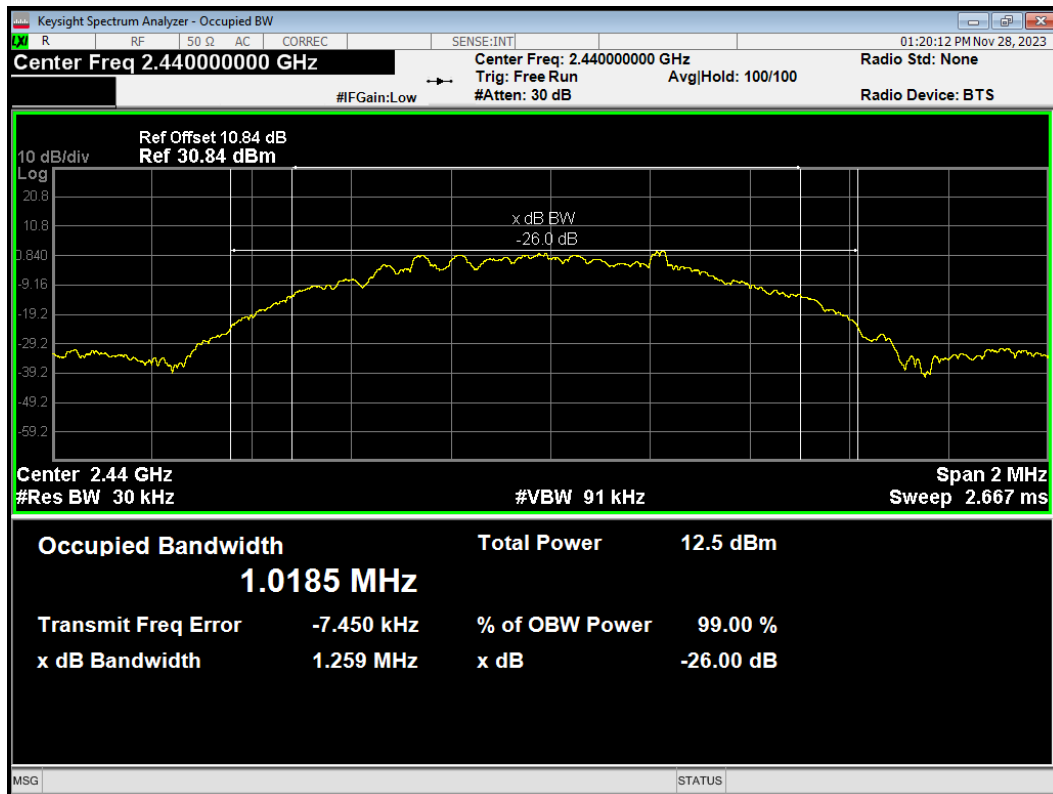

OBW Bluetooth LE(1M) 2480MHz

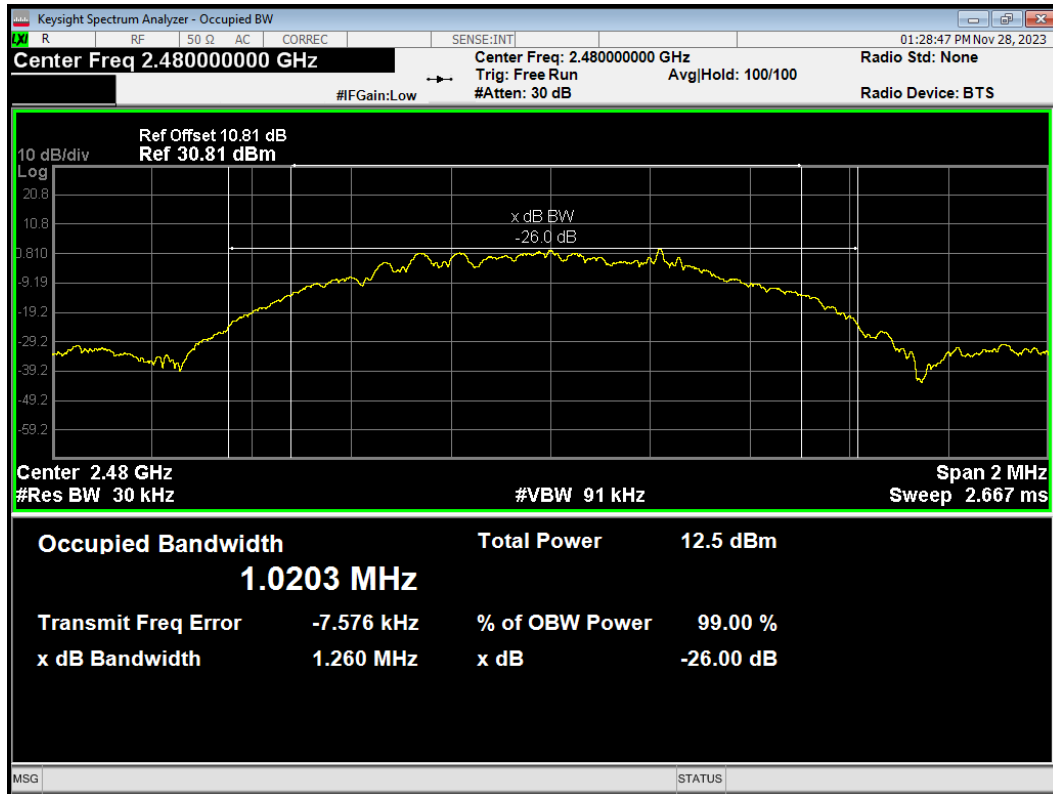

OBW Bluetooth LE(2M) 2402MHz

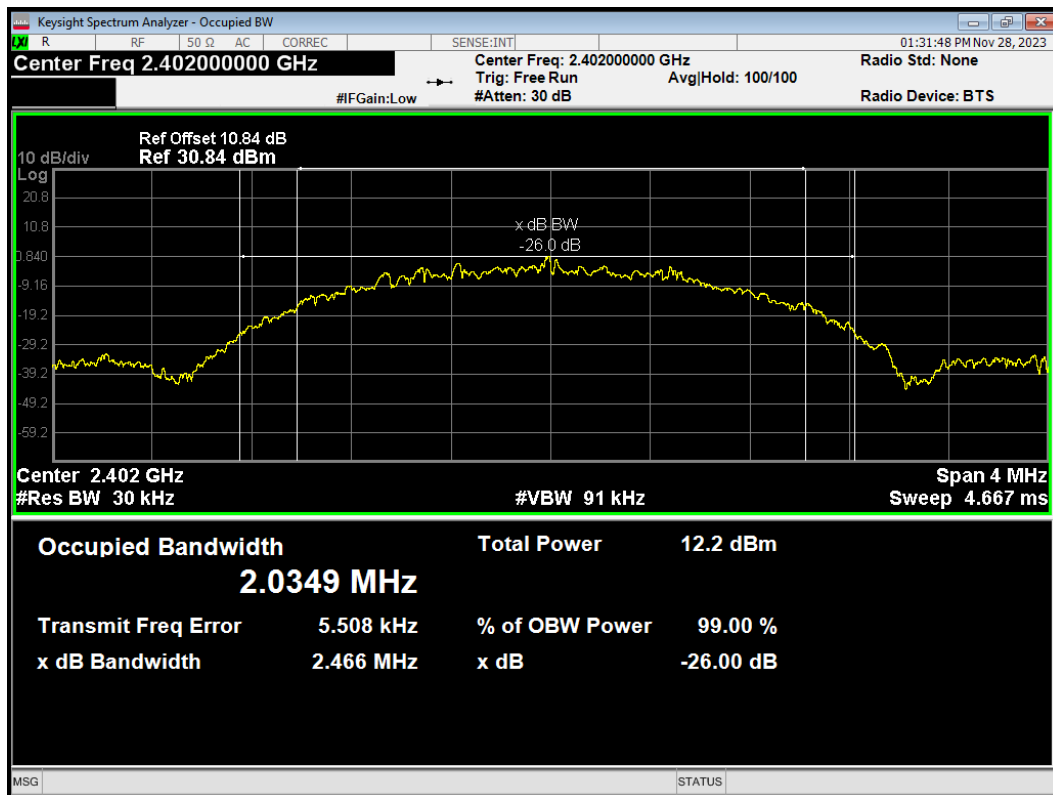

OBW Bluetooth LE(2M) 2440MHz

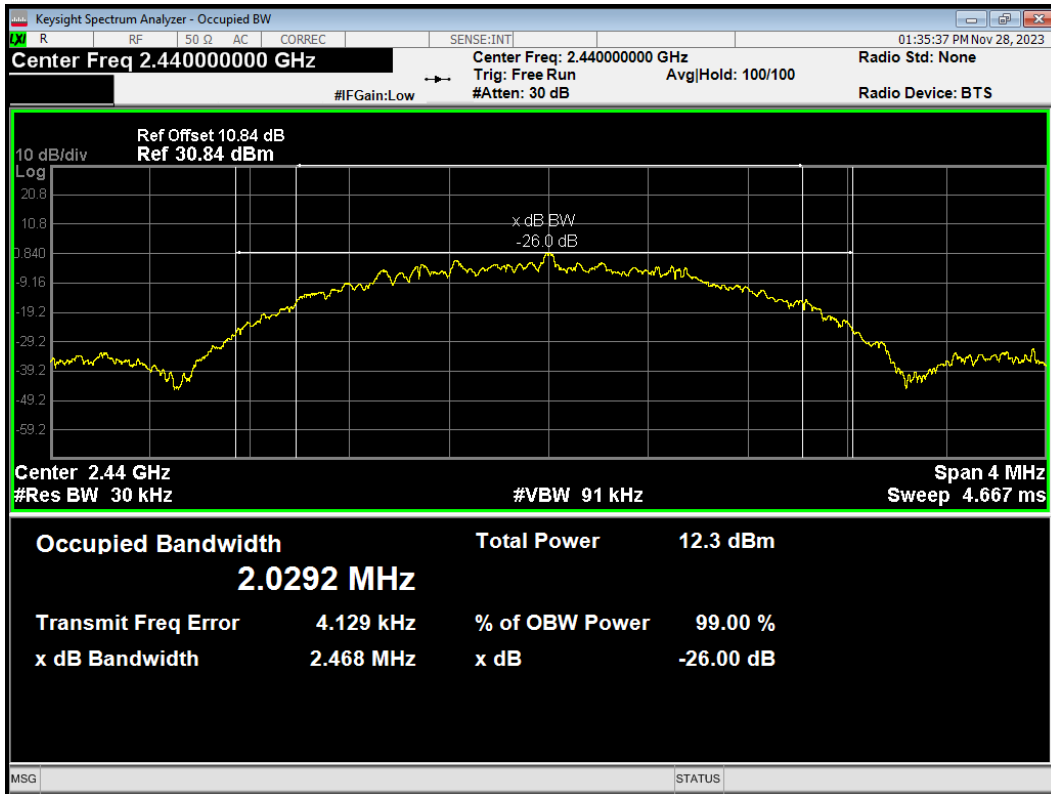

OBW Bluetooth LE(2M) 2480MHz

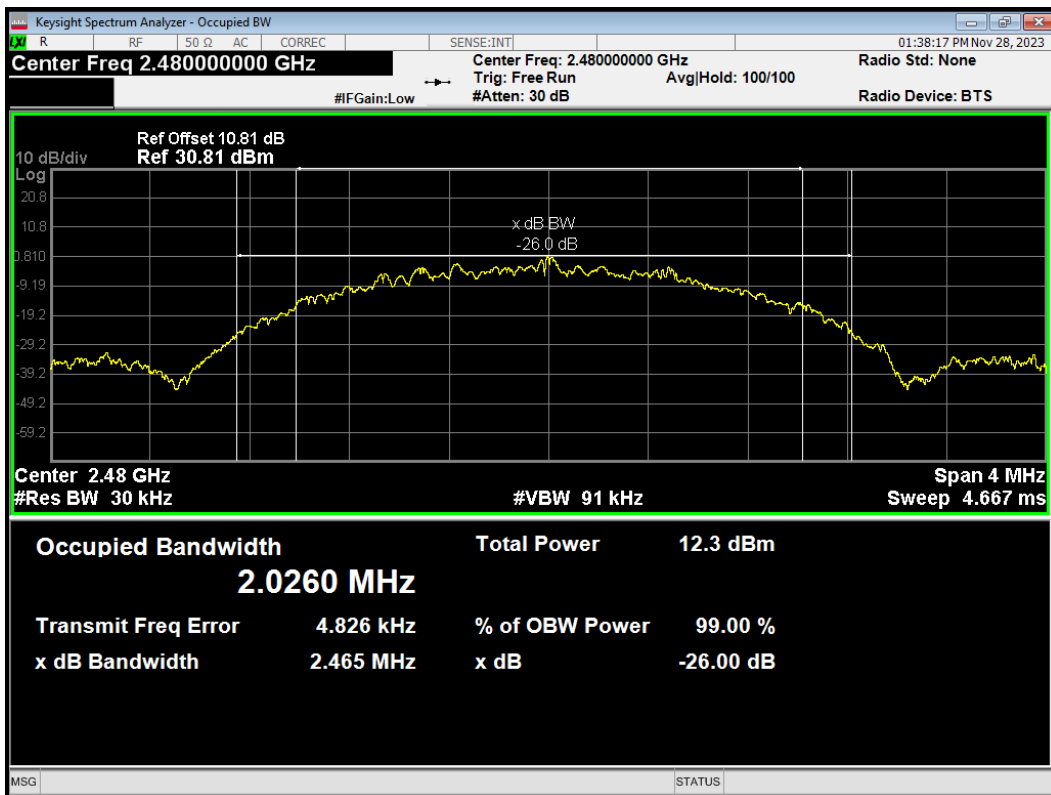

6 dB bandwidth

-6dB Bandwidth Bluetooth LE(1M) 2402MHz

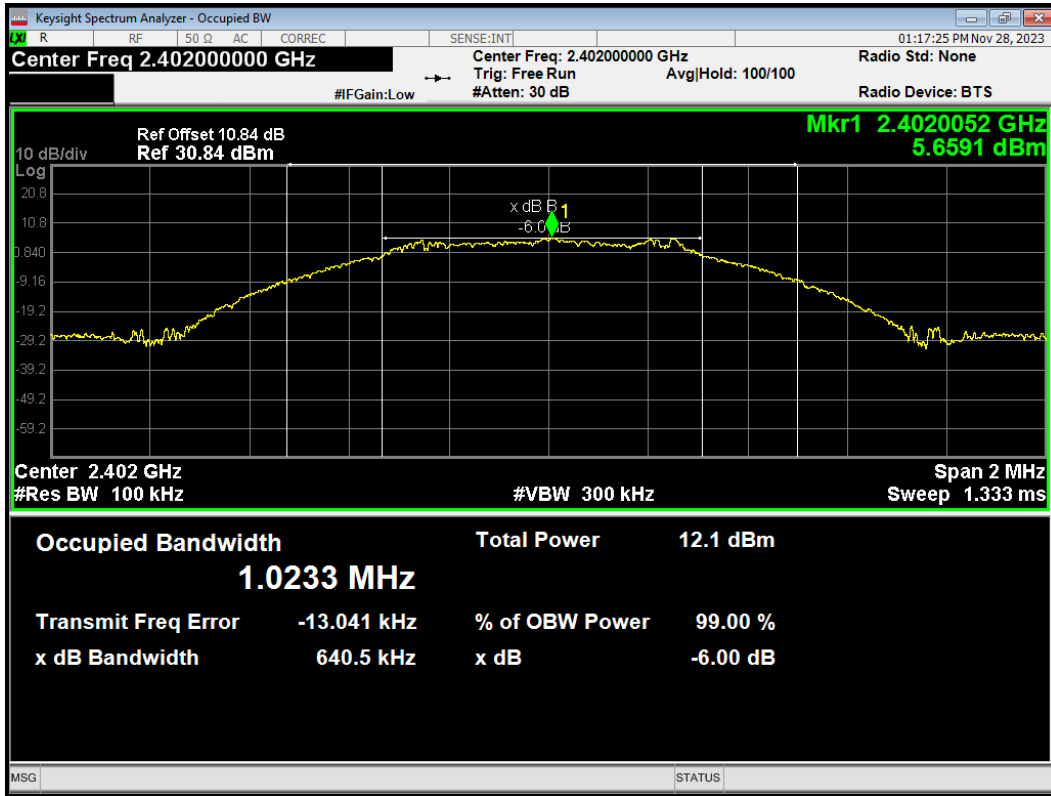

-6dB Bandwidth Bluetooth LE(1M) 2440MHz

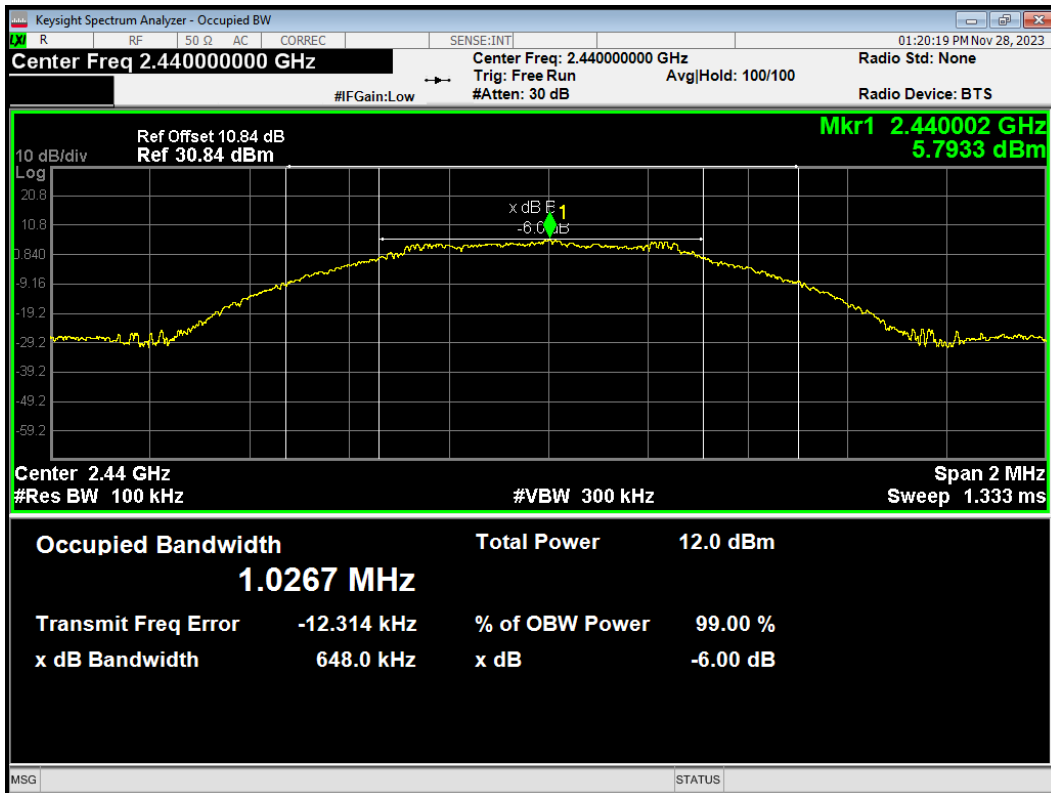



-6dB Bandwidth Bluetooth LE(1M) 2480MHz

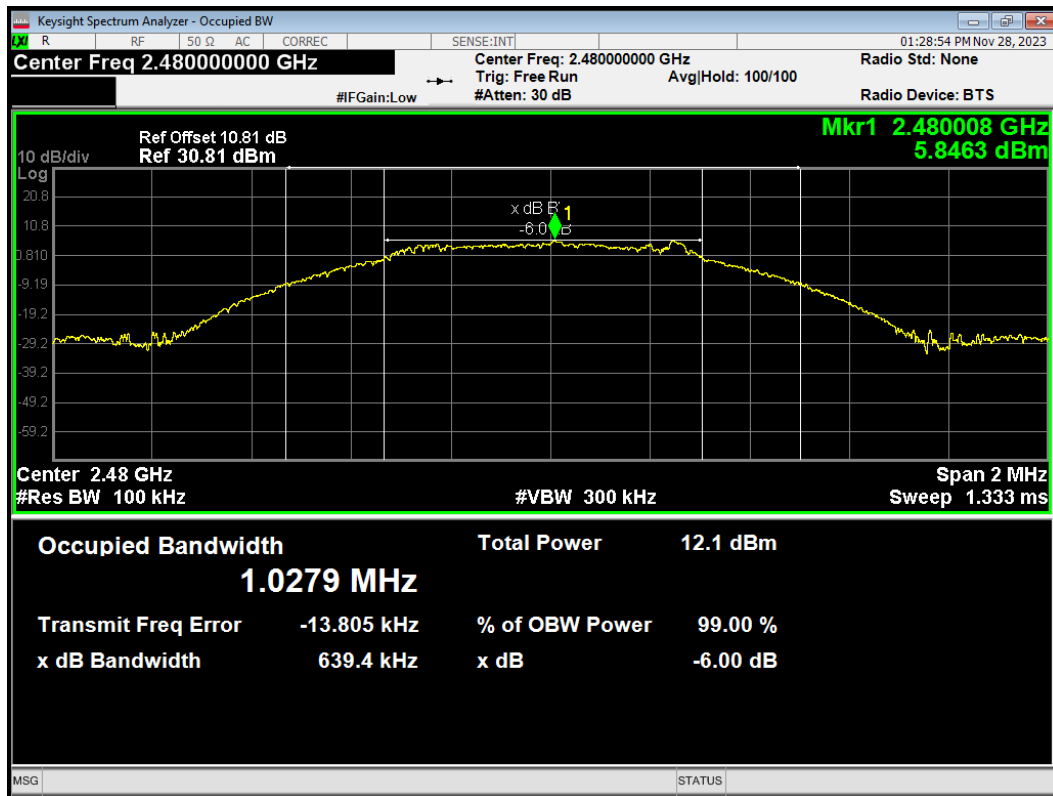

-6dB Bandwidth Bluetooth LE(2M) 2402MHz

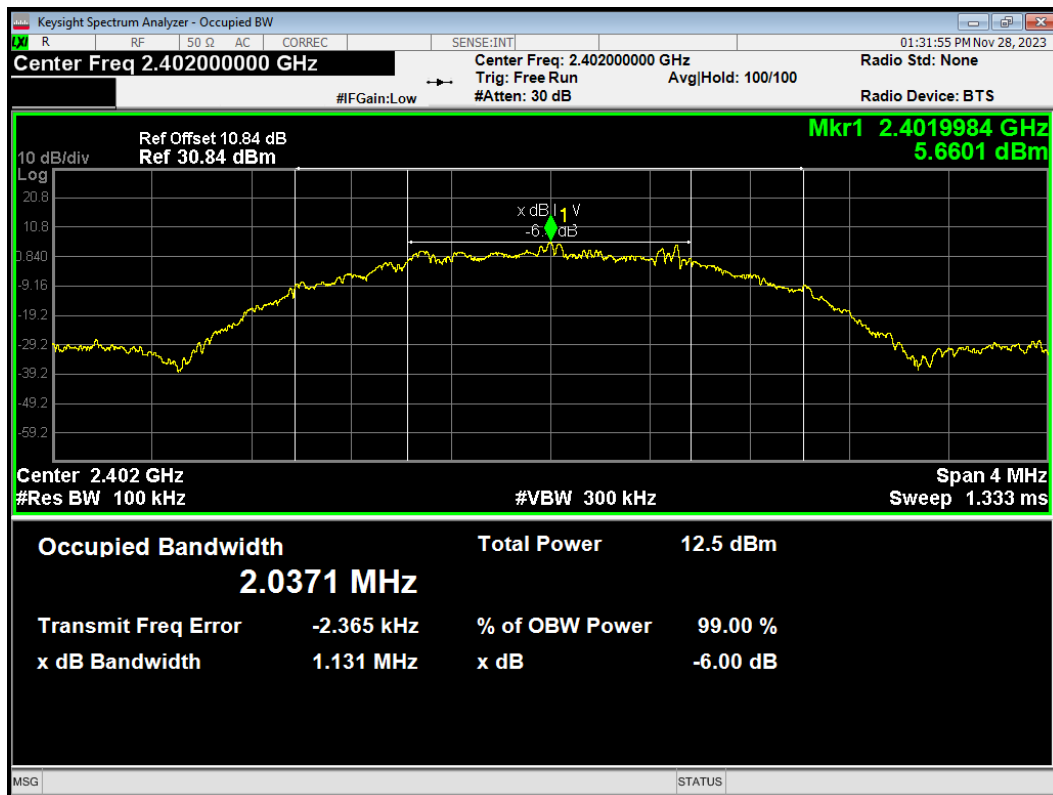

-6dB Bandwidth Bluetooth LE(2M) 2440MHz

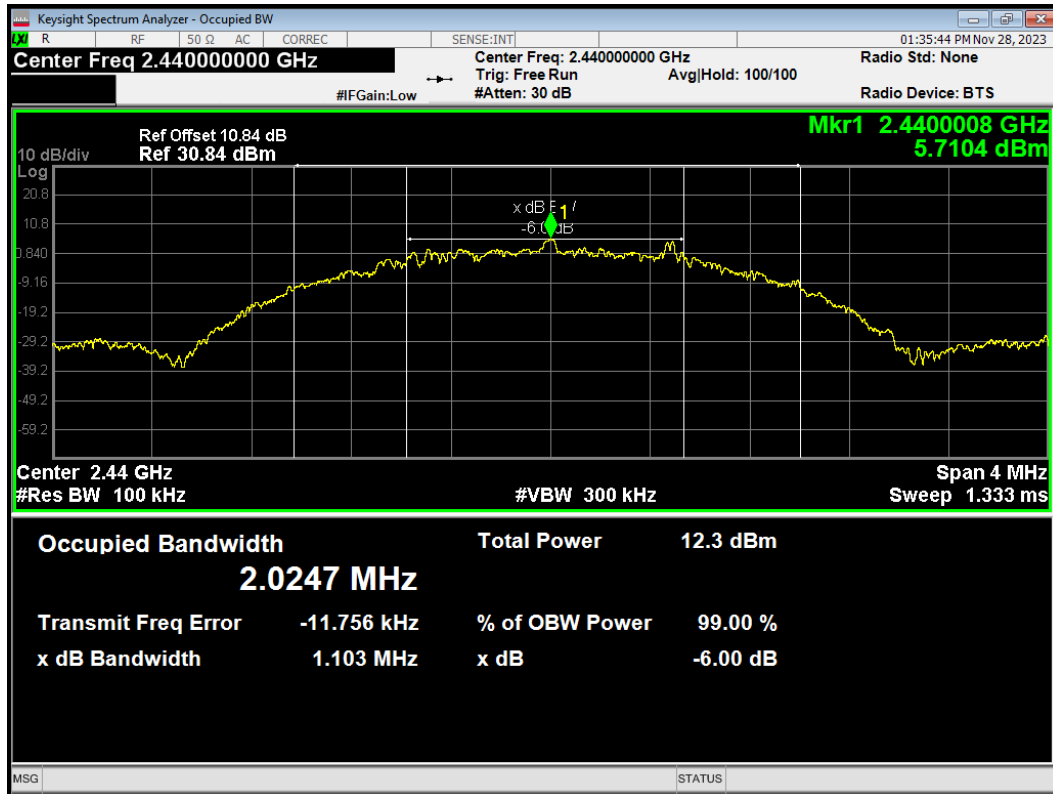

-6dB Bandwidth Bluetooth LE(2M) 2480MHz

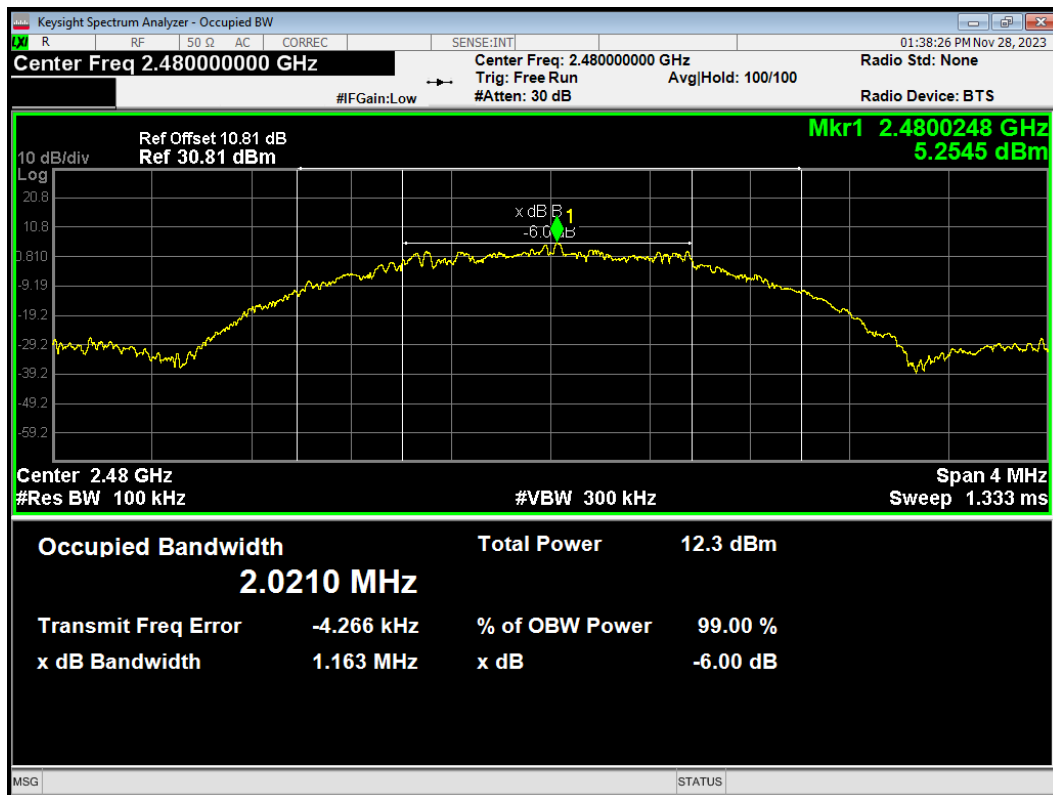

### 5.3. Band Edge

#### Ambient Condition

Temperature	Relative humidity
15°C ~ 35°C	20% ~ 80%

#### Method of Measurement

The EUT was connected to the spectrum analyzer through an external attenuator (20dB) and a known loss cable the band edge of the lowest and highest channels were measured. The peak detector is used and RBW is set to 100 kHz and VBW is set to 300 kHz on spectrum analyzer. Spectrum analyzer plots are included on the following pages.

#### Test Setup

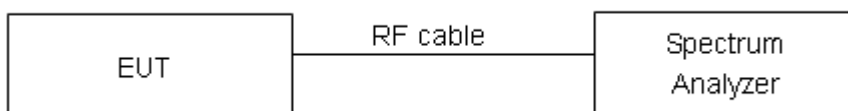

#### Limits

Rule Part 15.247(d) specifies that “In any 100 kHz bandwidth outside the frequency band in which the spread spectrum or digitally modulated intentional radiator is operating, the radio frequency power that is produced by the intentional radiator shall be at least 20 dB below that in the 100 kHz bandwidth within the band that contains the highest level of the desired power, based on either an RF conducted or a radiated measurement, provided the transmitter demonstrates compliance with the peak conducted power limits.” If the transmitter complies with the conducted power limits based on the use of RMS averaging over a time interval, as permitted under paragraph (b)(3) of this section, the attenuation required under this paragraph shall be 30 dB instead of 20 dB.”

#### Measurement Uncertainty

The assessed measurement uncertainty to ensure 95% confidence level for the normal distribution is with the coverage factor  $k = 1.96$ .

Frequency	Uncertainty
2GHz-3GHz	1.407 dB

Test Results: PASS

Band Edge Bluetooth LE(1M) 2402MHz Ref

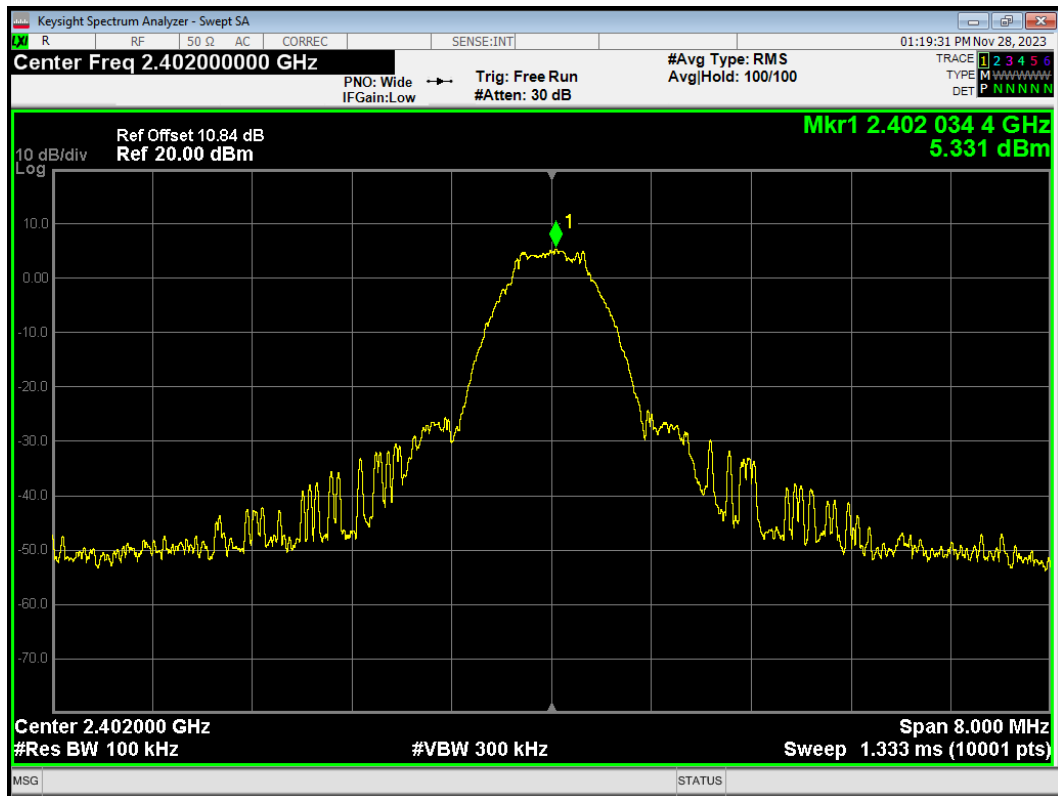

Band Edge Bluetooth LE(1M) 2402MHz Emission

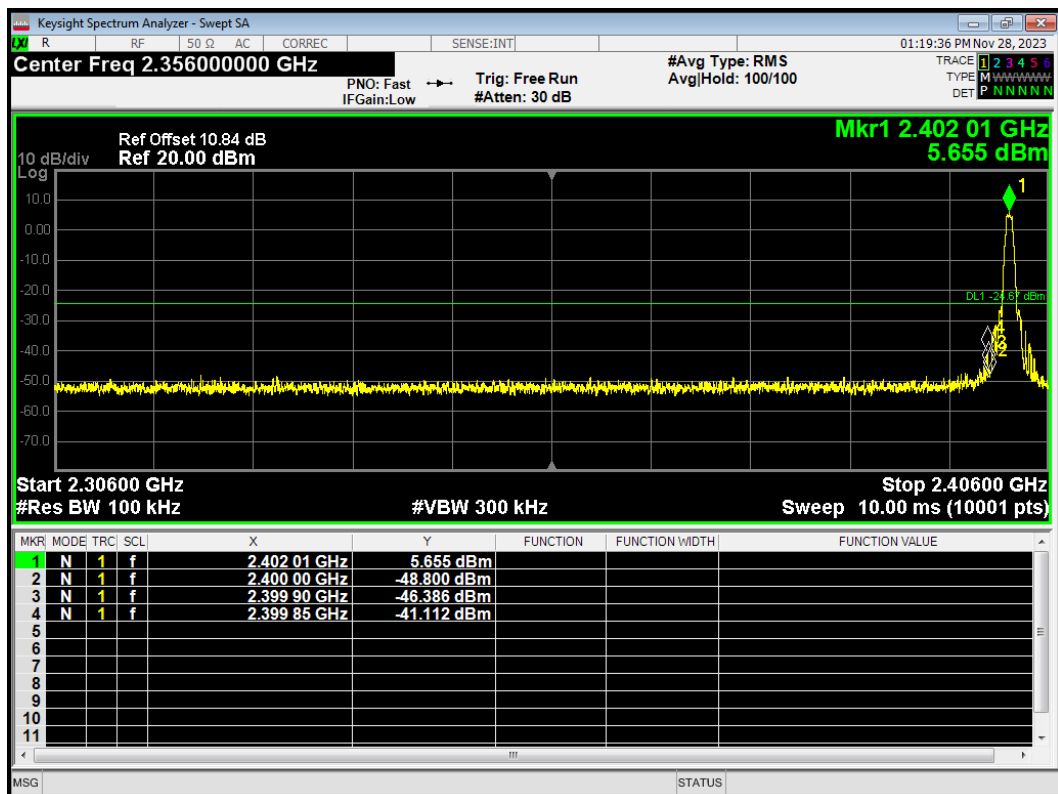

Band Edge Bluetooth LE(1M) 2480MHz Ref

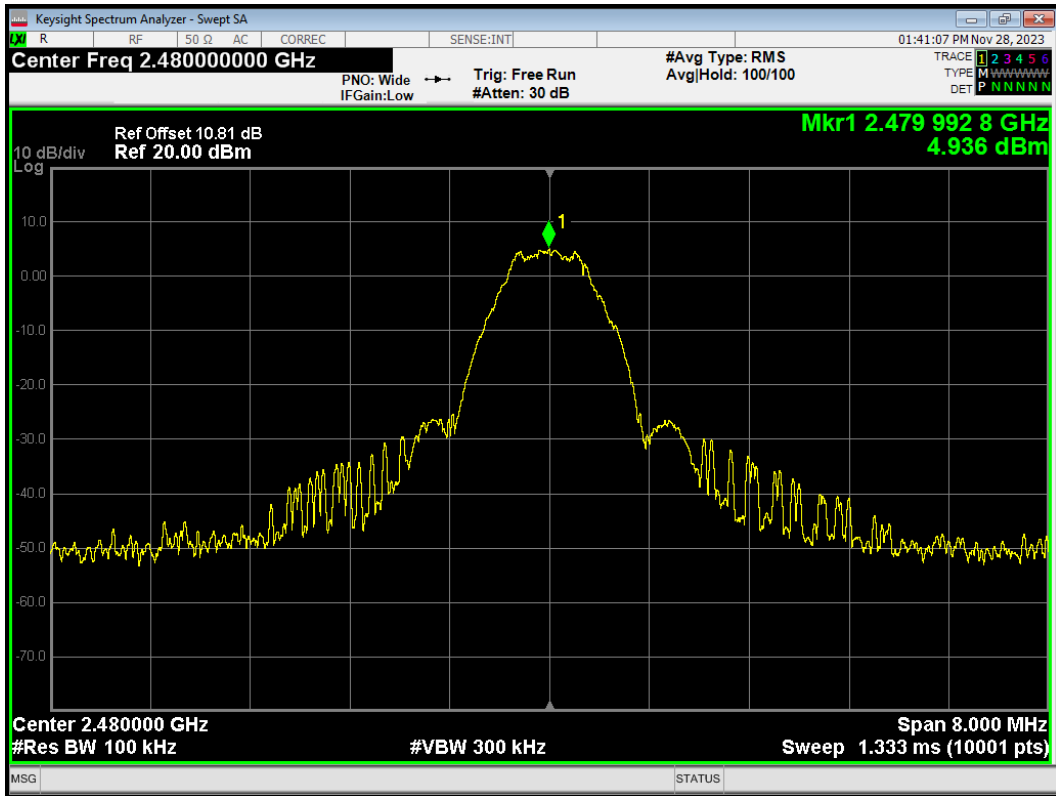

Band Edge Bluetooth LE(1M) 2480MHz Emission

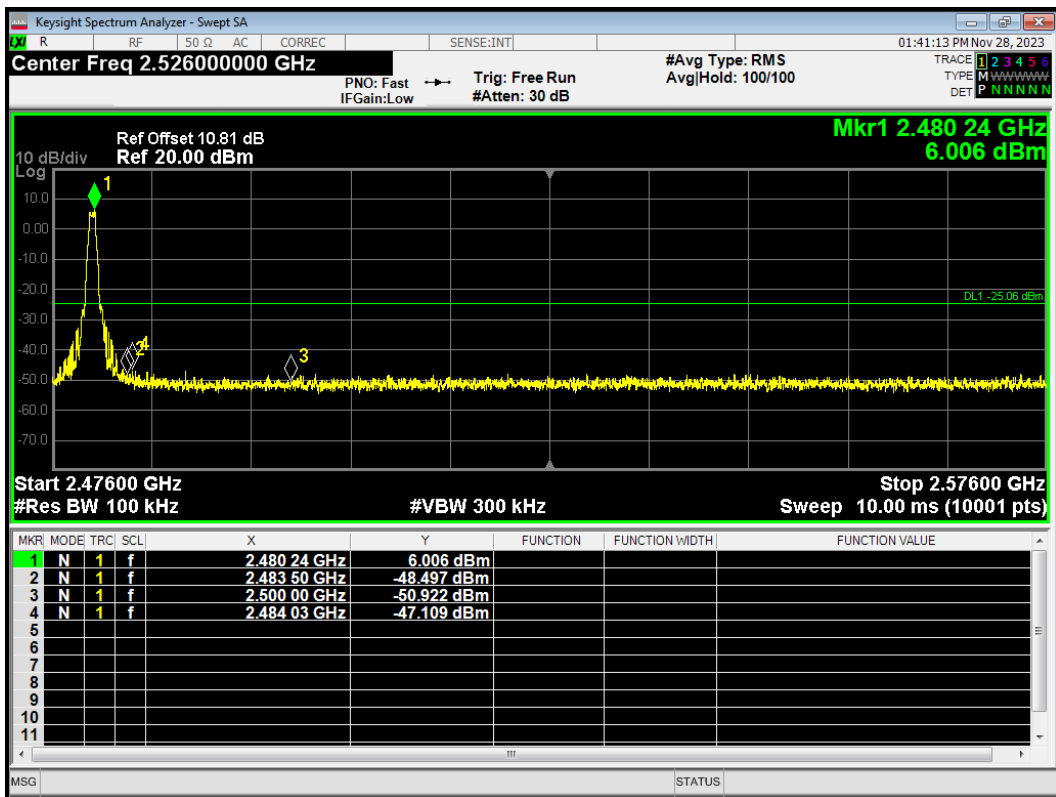

Band Edge Bluetooth LE(2M) 2402MHz Ref

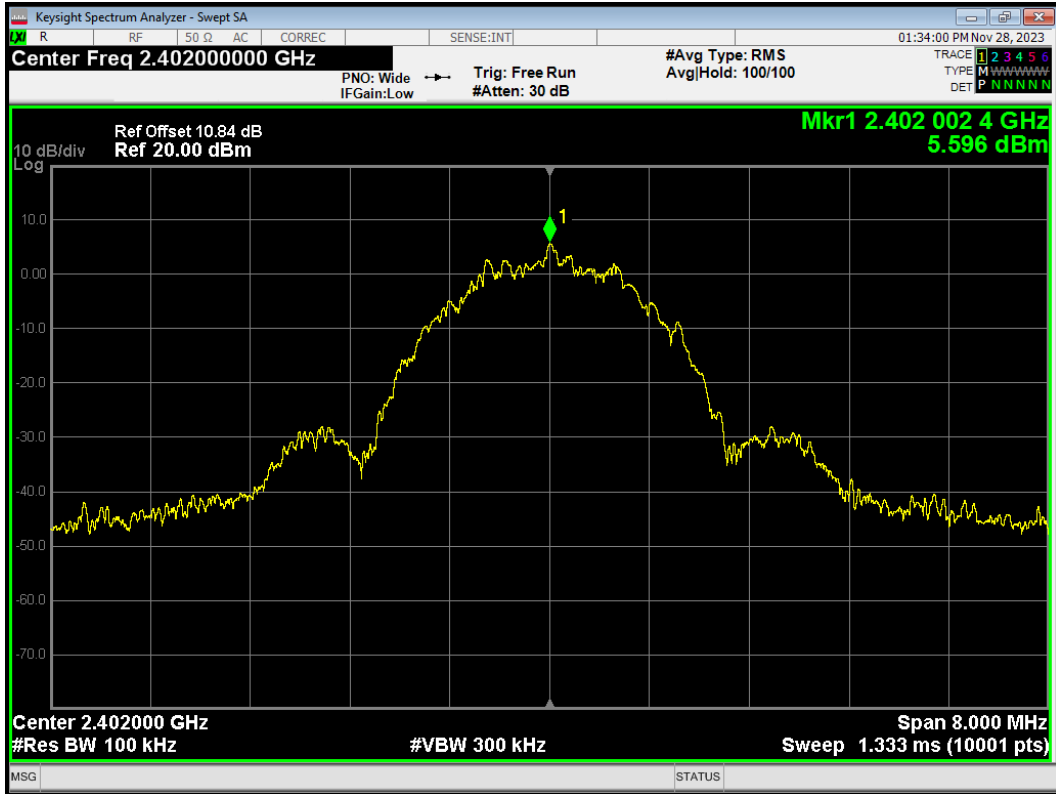

Band Edge Bluetooth LE(2M) 2402MHz Emission

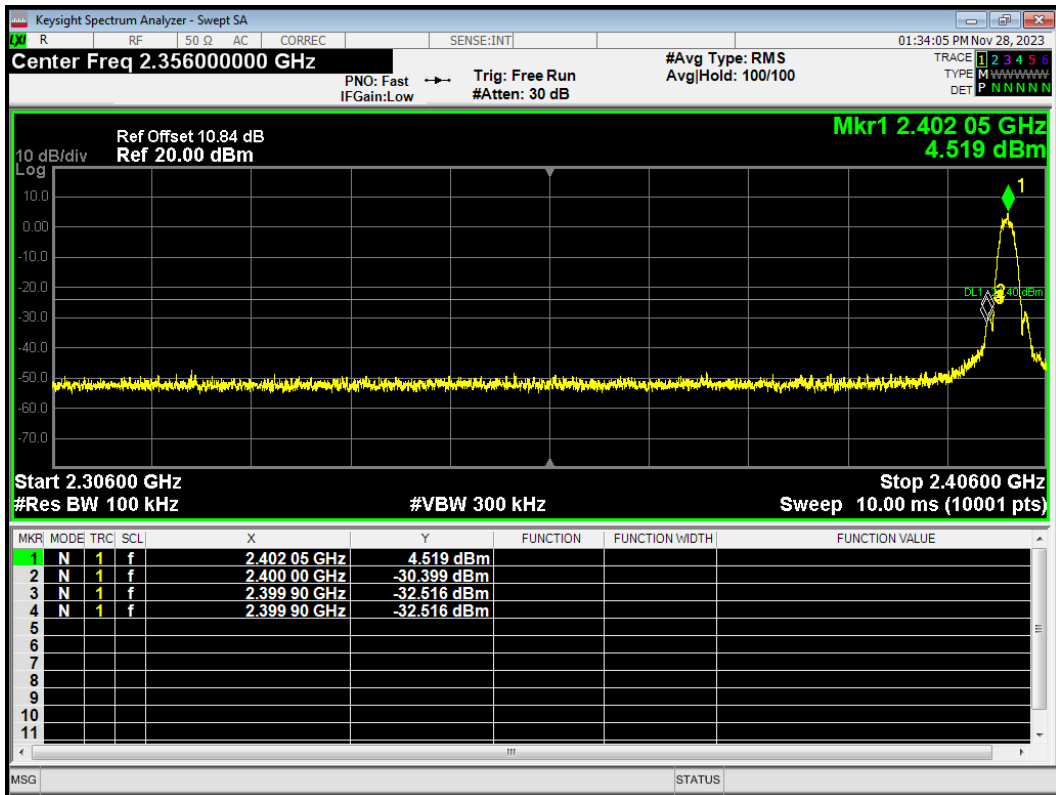

Band Edge Bluetooth LE(2M) 2480MHz Ref

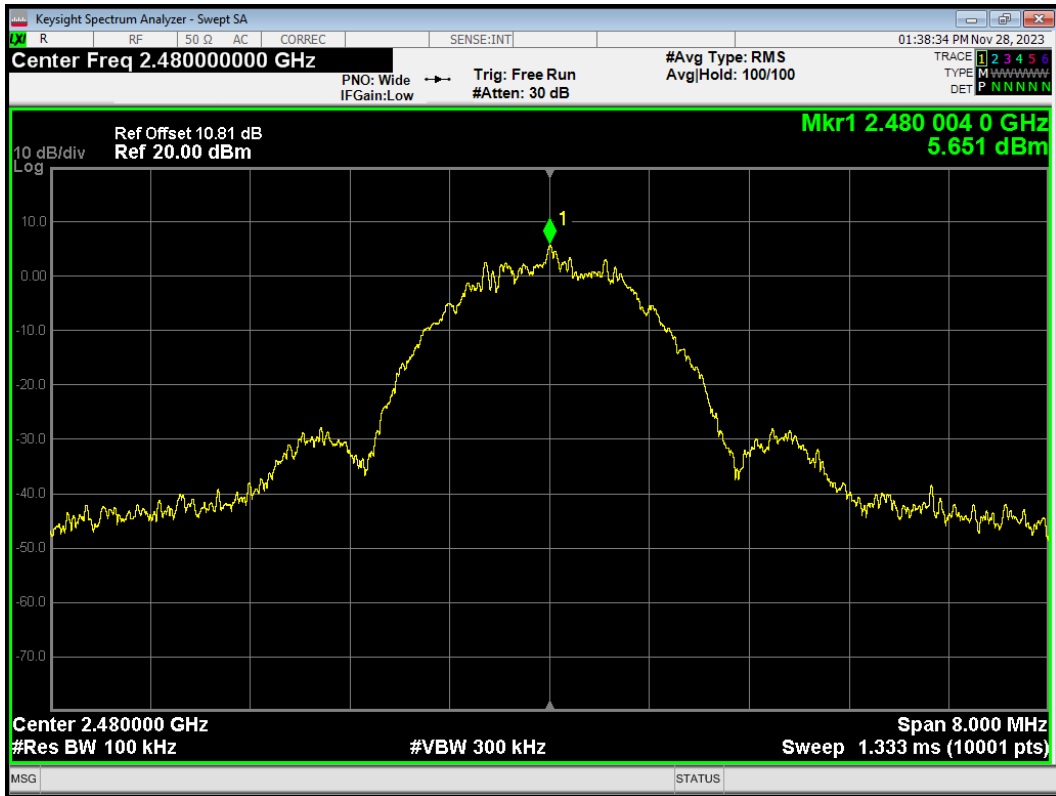

Band Edge Bluetooth LE(2M) 2480MHz Emission

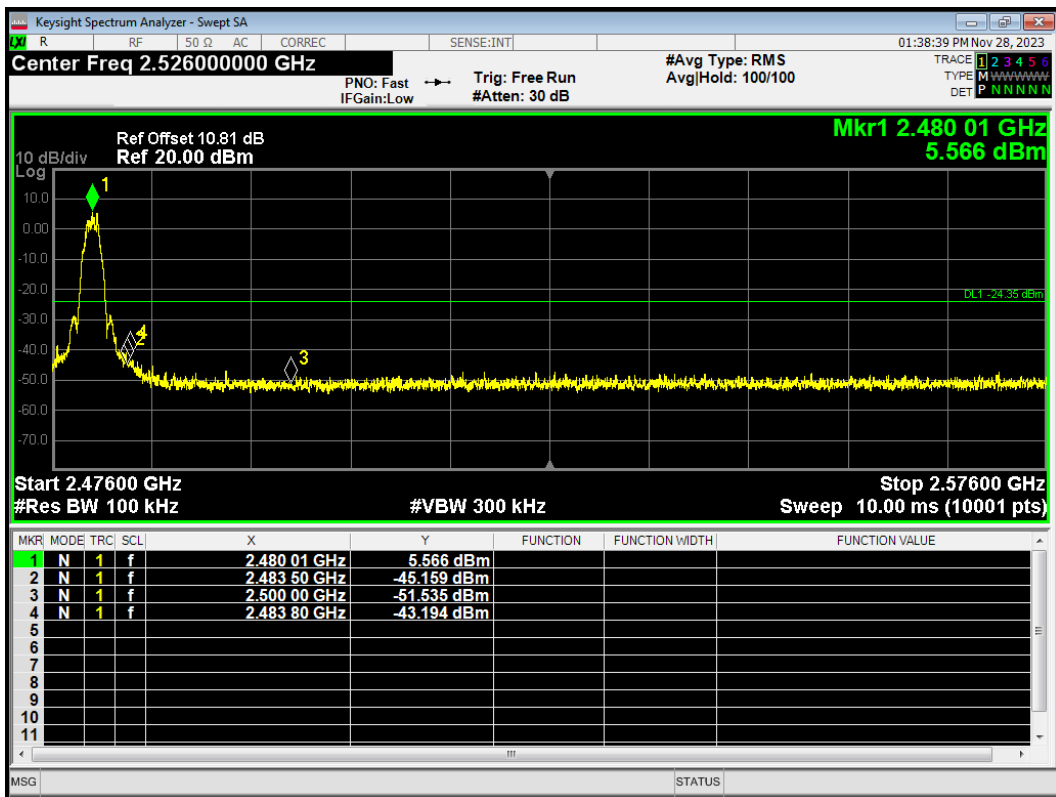

## 5.4. Power Spectral Density

### Ambient Condition

Temperature	Relative humidity
15°C ~ 35°C	20% ~ 80%

### Method of Measurement

During the process of the testing, The EUT was connected to Spectrum Analyzer with a known loss. The EUT is max power transmission with proper modulation.

Method AVGPSD-2 was used for this test.

- a) Measure the duty cycle (D) of the transmitter output signal as described in 11.6
- b) Set instrument center frequency to DTS channel center frequency
- c) Set span to at least 1.5 times the OBW
- d) Set RBW to:  $3\text{kHz} \leq \text{RBW} \leq 100\text{kHz}$
- e) Set  $\text{VBW} \geq [3 \times \text{RBW}]$
- f) Detector = power averaging (rms) or sample detector (when rms not available)
- g) Ensure that the number of measurement points in the sweep  $\geq [2 \times \text{span}/\text{RBW}]$
- h) Sweep time = auto couple
- i) Do not use sweep triggering; allow sweep to "free run"
- j) Employ trace averaging (rms) mode over a minimum of 100 traces
- k) Use the peak marker function to determine the maximum amplitude level
- l) Add  $[10 \log(1/D)]$ , where D is the duty cycle measured in step a), to the measured PSD to compute the average PSD during the actual transmission time
- m) If measured value exceeds requirement specified by regulatory agency then reduce RBW (but no less than 3 kHz) and repeat (note that this may require zooming in on the emission of interest and reducing the span to meet the minimum measurement point requirement as the RBW is reduced)

### Test setup

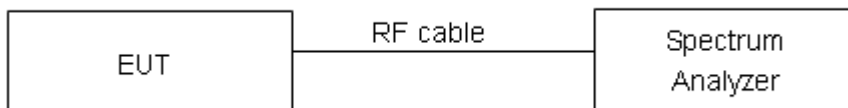



**Limits**

Rule Part 15.247(e) specifies that” For digitally modulated systems, the power spectral density conducted from the intentional radiator to the antenna shall not be greater than 8 dBm in any 3 kHz band during any time interval of continuous transmission. ”

Limits	$\leq 8 \text{ dBm} / 3\text{kHz}$
--------	------------------------------------

**Measurement Uncertainty**

The assessed measurement uncertainty to ensure 95% confidence level for the normal distribution is with the coverage factor  $k = 2$ ,  $U = 0.75\text{dB}$ .

**Test Results:**

Test Mode	Carrier frequency (MHz) / Channel	Read Value (dBm / 3kHz)	Power Spectral Density (dBm / 3kHz)	Limit (dBm / 3kHz)	Conclusion
Bluetooth (Low Energy) (1M)	2402/CH0	-14.55	-13.87	8	PASS
	2440/CH19	-14.60	-13.92	8	PASS
	2480/CH39	-14.83	-14.15	8	PASS
Bluetooth (Low Energy) (2M)	2402/CH0	-19.68	-17.29	8	PASS
	2440/CH19	-19.89	-17.50	8	PASS
	2480/CH39	-19.70	-17.31	8	PASS

Note: Power Spectral Density =Read Value+Duty cycle correction factor

PSD Bluetooth LE(1M) 2402MHz

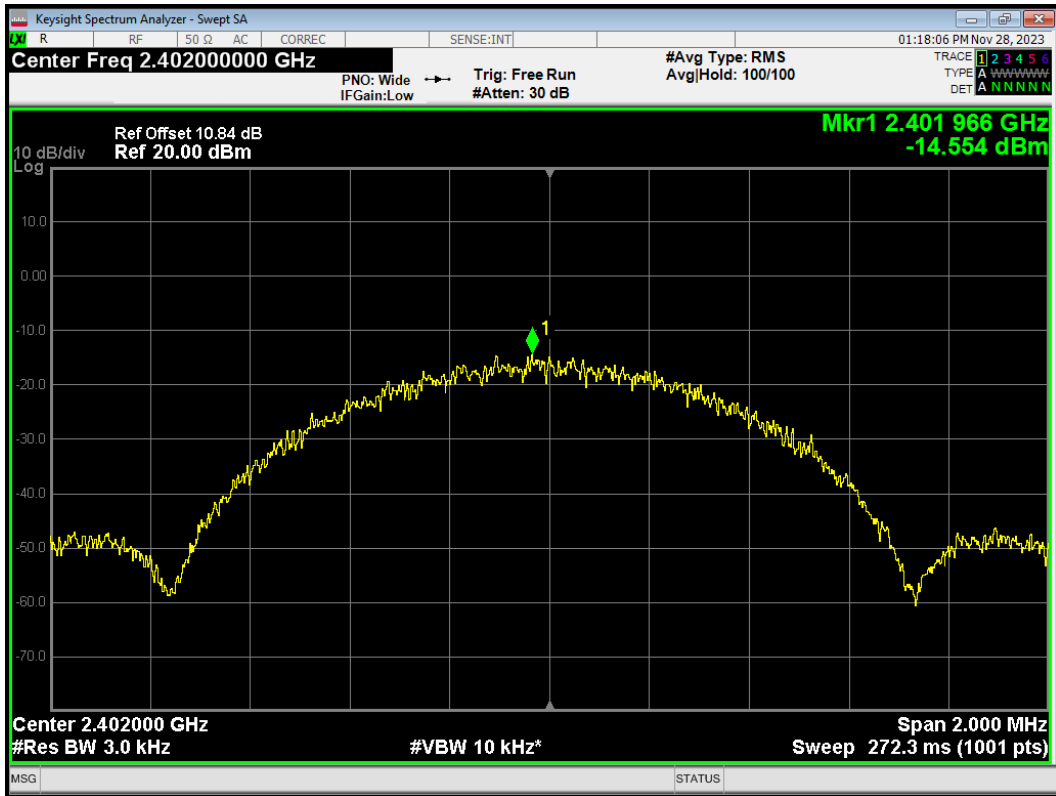

PSD Bluetooth LE(1M) 2440MHz

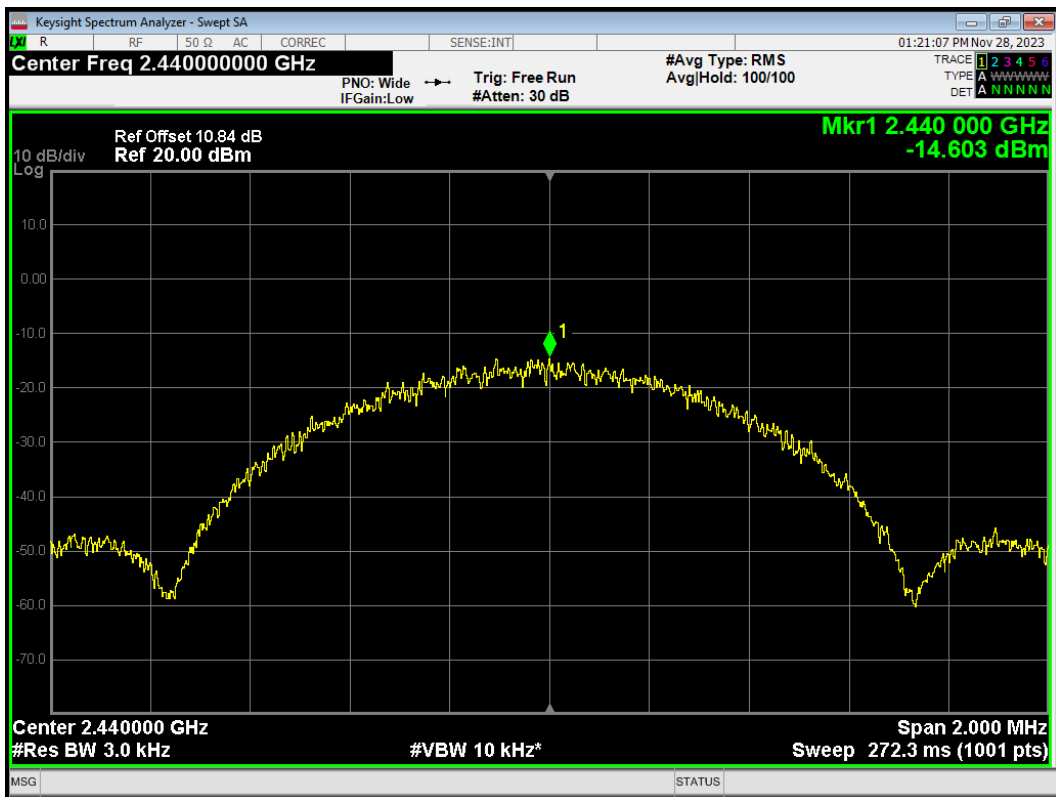

PSD Bluetooth LE(1M) 2480MHz

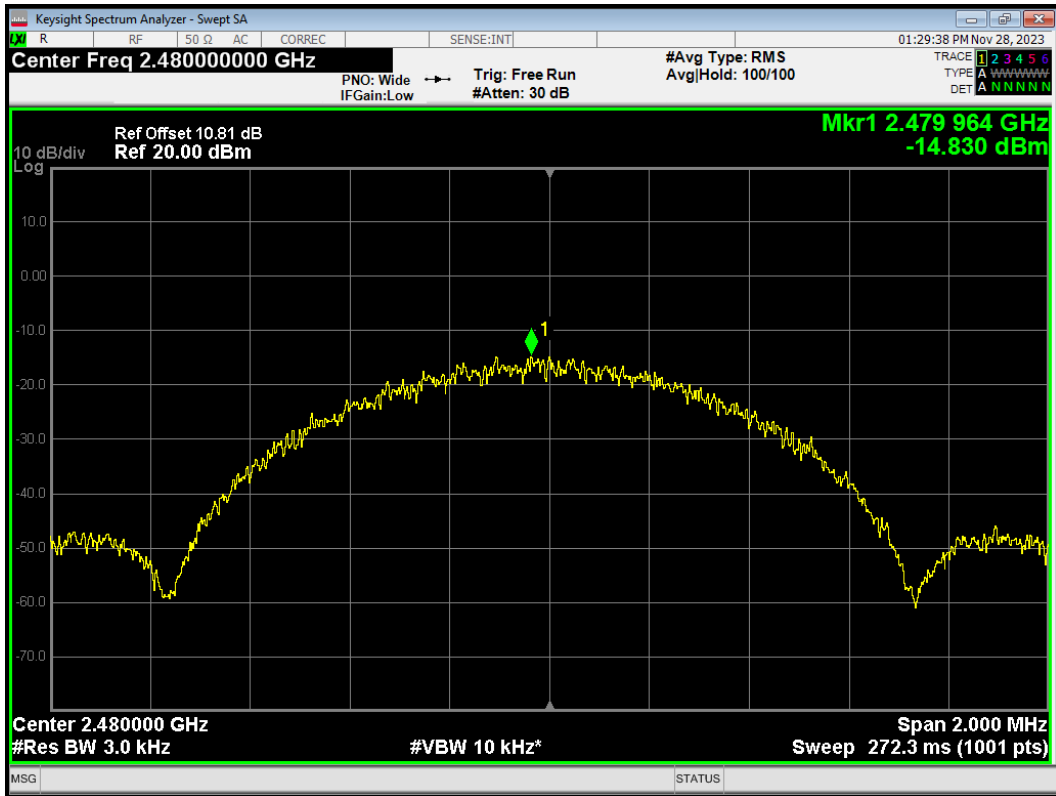

PSD Bluetooth LE(2M) 2402MHz

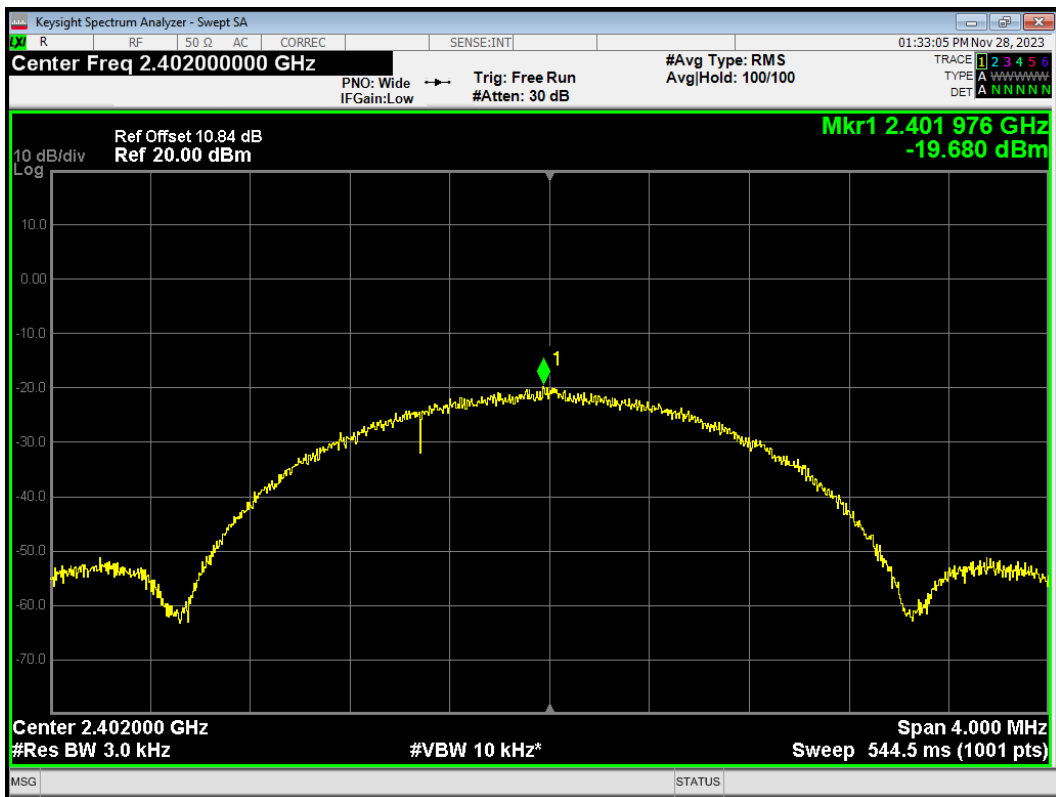

PSD Bluetooth LE(2M) 2440MHz

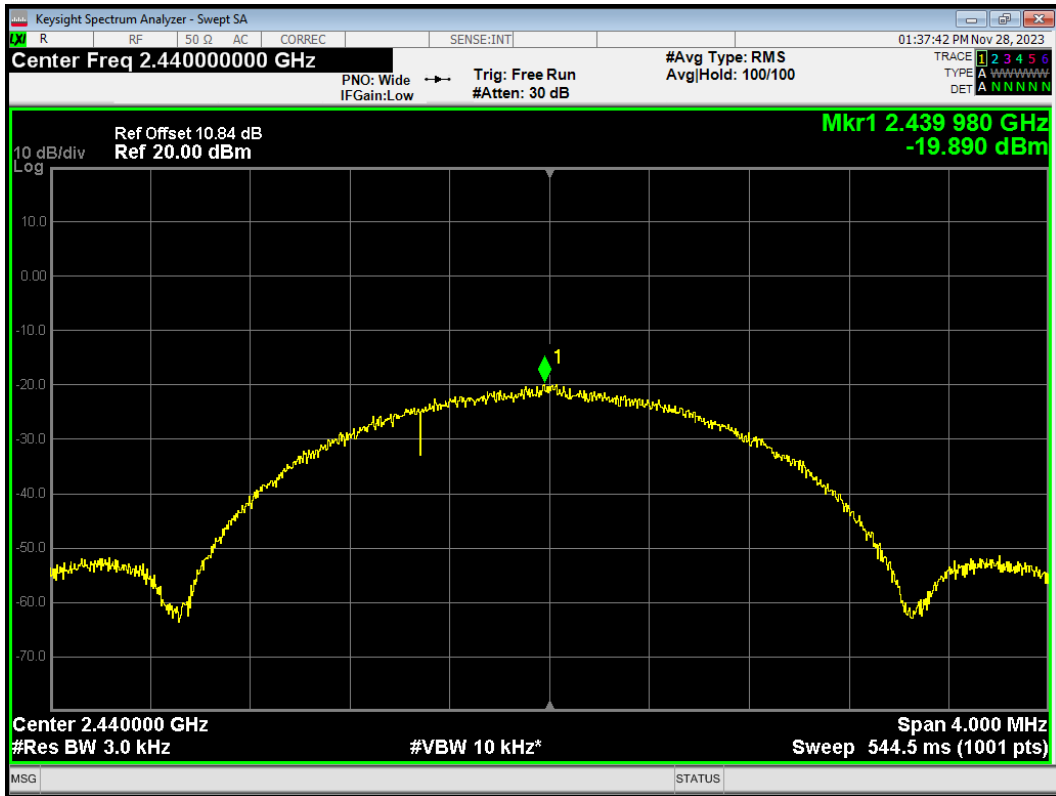

PSD Bluetooth LE(2M) 2480MHz

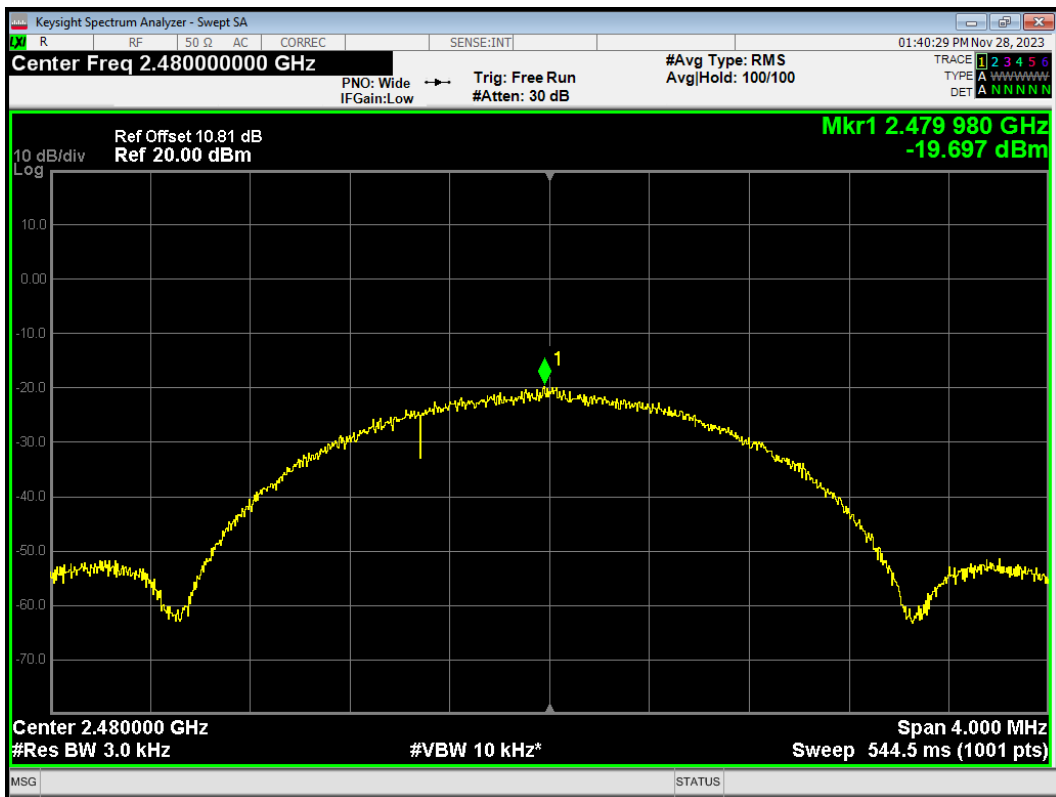

## 5.5. Spurious RF Conducted Emissions

### Ambient Condition

Temperature	Relative humidity
15°C ~ 35°C	20% ~ 80%

### Method of Measurement

The EUT was connected to the spectrum analyzer with a known loss. The spectrum analyzer scans from 30MHz to the 10th harmonic of the carrier. The peak detector is used. Set RBW to 100 kHz and VBW to 300 kHz, Sweep is set to AUTO.

The test is in transmitting mode.

### Test Setup



### Limits

Rule Part 15.247(d) pacifies that “In any 100 kHz bandwidth outside the frequency band in which the spread spectrum or digitally modulated intentional radiator is operating, the radio frequency power that is produced by the intentional radiator shall be at least 20 dB below that in the 100 kHz bandwidth within the band that contains the highest level of the desired power, based on either an RF conducted or a radiated measurement, provided the transmitter demonstrates compliance with the peak conducted power limits. If the transmitter complies with the conducted power limits based on the use of RMS averaging over a time interval, as permitted under paragraph (b)(3) of this section, the attenuation required under this paragraph shall be 30 dB instead of 20 dB. ”

Test Mode	Carrier frequency (MHz)	Reference value (dBm)	Limit
Bluetooth (Low Energy) (1M)	2402	6.040	-23.96
	2440	6.040	-23.96
	2480	5.730	-24.27
Bluetooth (Low Energy) (2M)	2402	5.800	-24.20
	2440	5.750	-24.25
	2480	5.420	-24.58

### Measurement Uncertainty

The assessed measurement uncertainty to ensure 95% confidence level for the normal distribution is with the coverage factor  $k = 1.96$ .

Frequency	Uncertainty
100kHz-2GHz	0.684 dB
2GHz-26GHz	1.407 dB

Test Results:

Tx. Spurious Bluetooth LE(1M) 2402MHz Ref

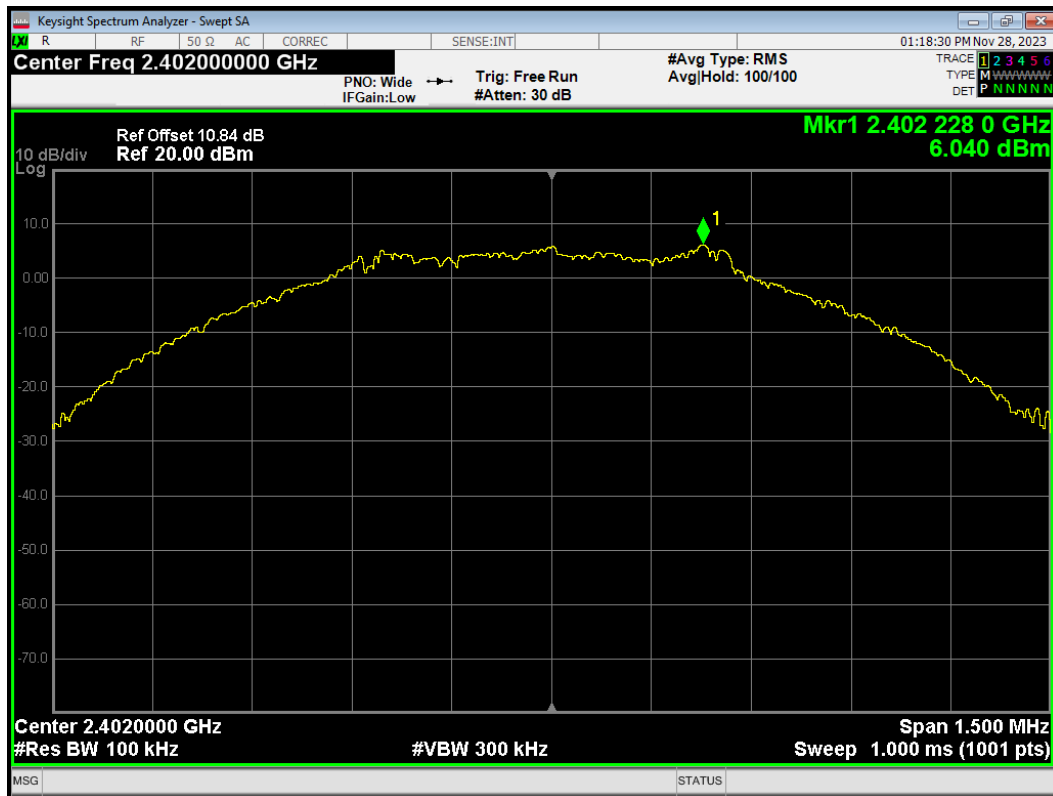

Tx. Spurious Bluetooth LE(1M) 2402MHz Emission

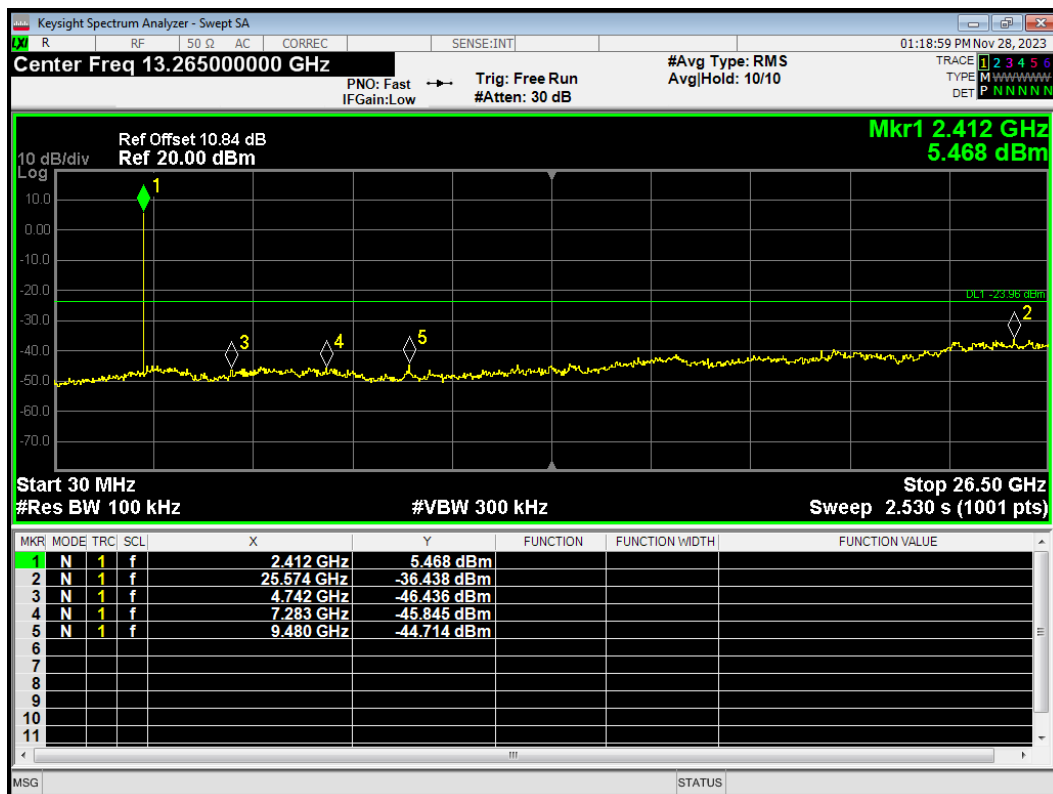



Tx. Spurious Bluetooth LE(1M) 2440MHz Ref



Tx. Spurious Bluetooth LE(1M) 2440MHz Emission

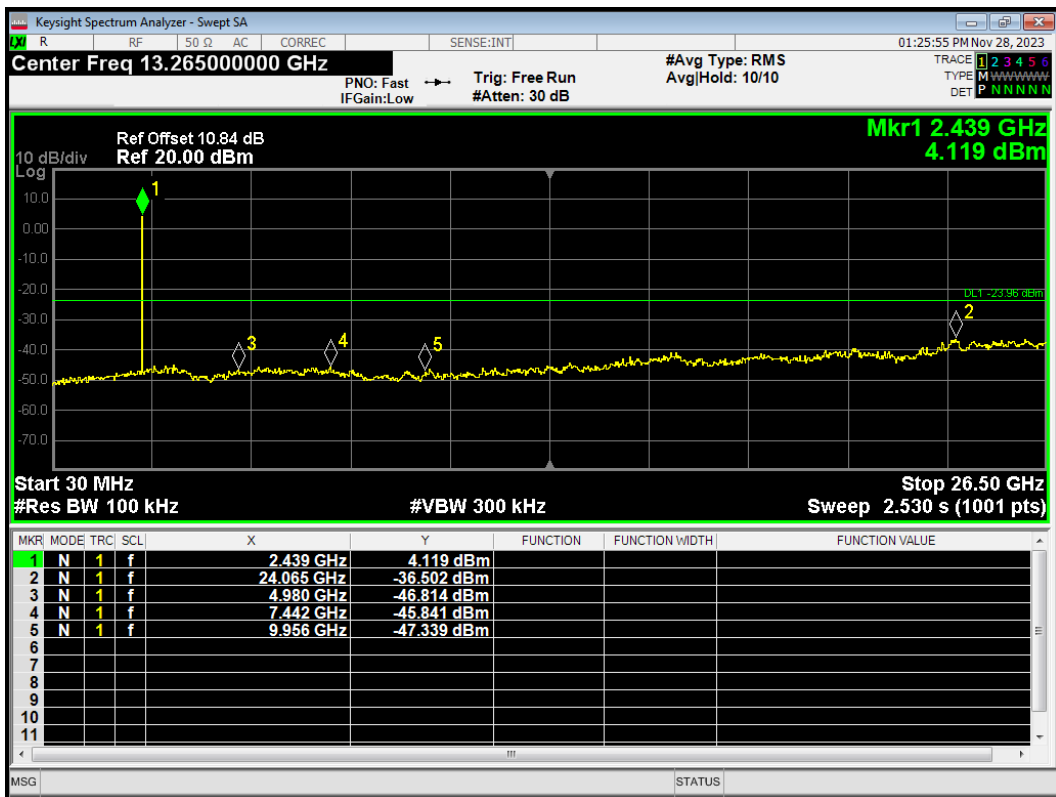

Tx. Spurious Bluetooth LE(1M) 2480MHz Ref

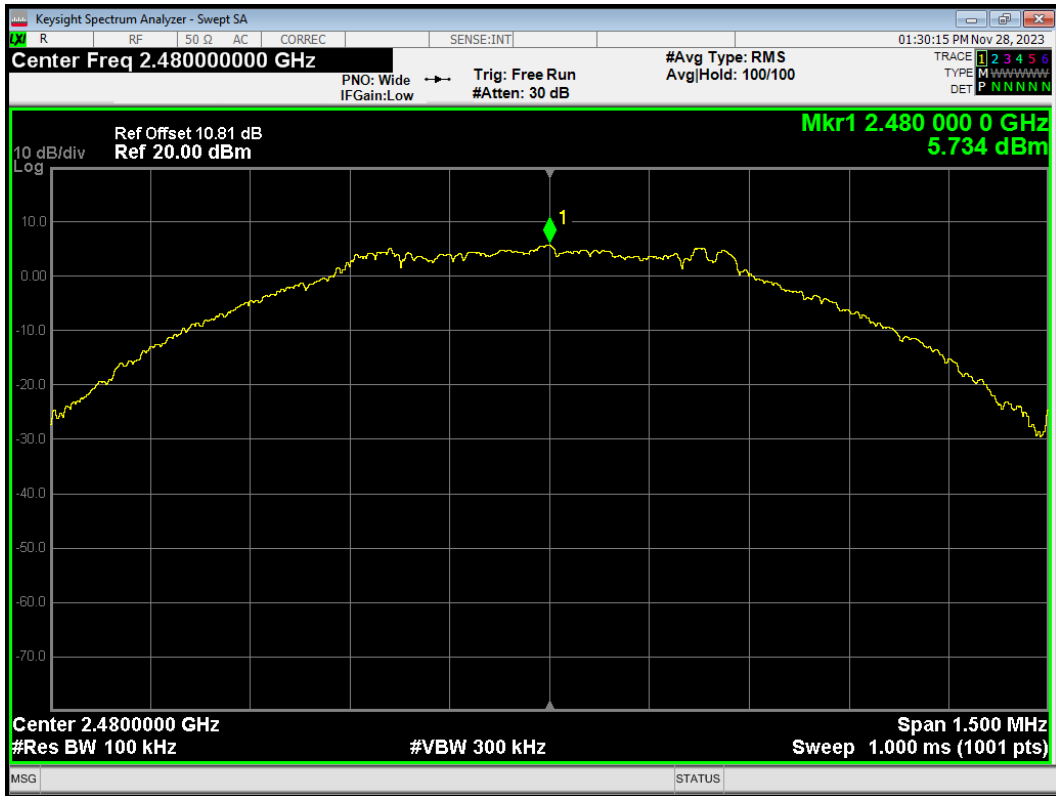

Tx. Spurious Bluetooth LE(1M) 2480MHz Emission

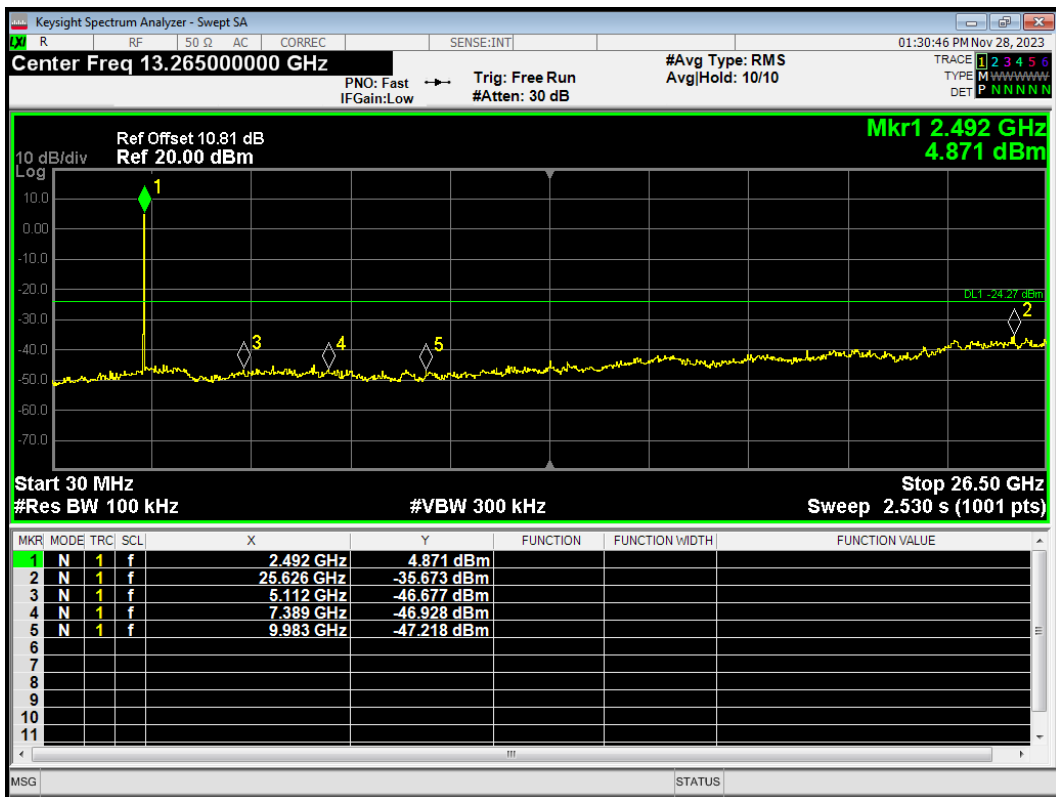

Tx. Spurious Bluetooth LE(2M) 2402MHz Ref

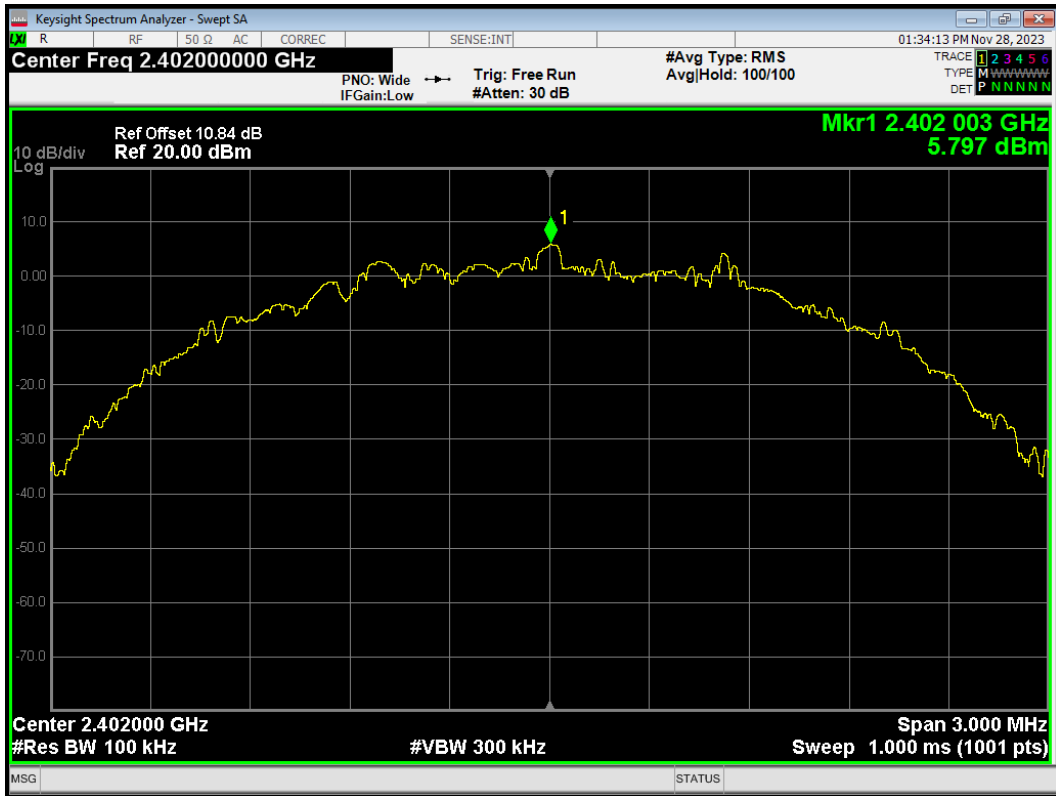

Tx. Spurious Bluetooth LE(2M) 2402MHz Emission

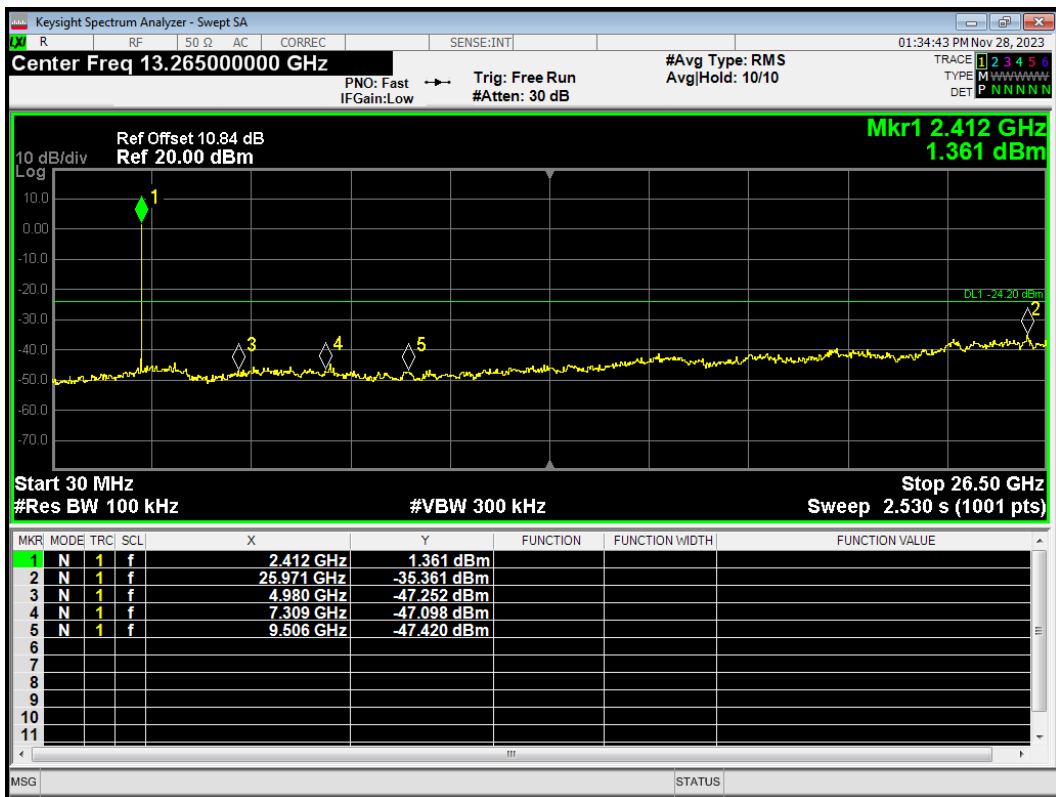

Tx. Spurious Bluetooth LE(2M) 2440MHz Ref

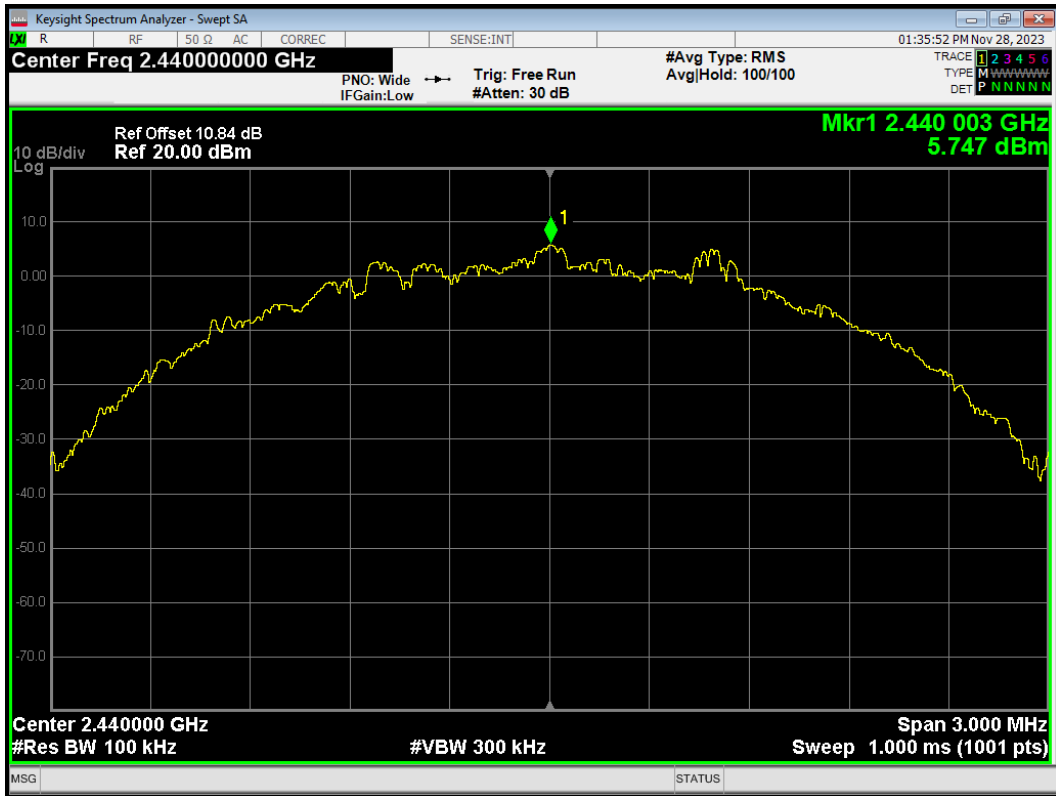

Tx. Spurious Bluetooth LE(2M) 2440MHz Emission

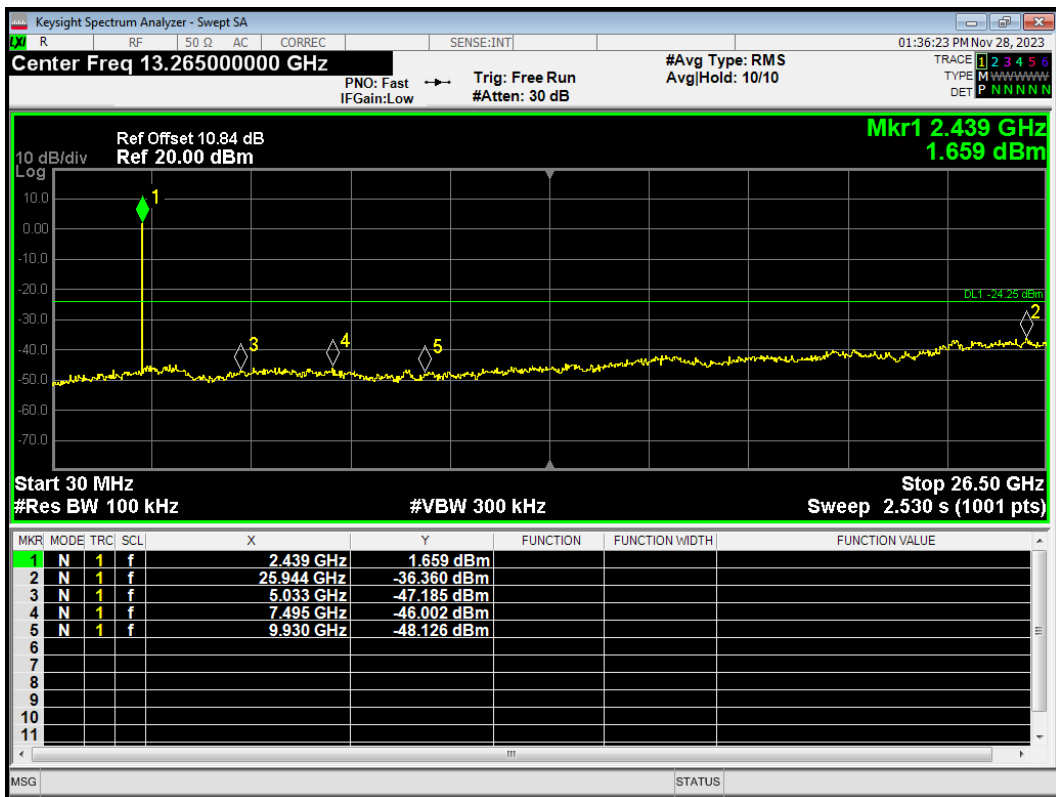

Tx. Spurious Bluetooth LE(2M) 2480MHz Ref

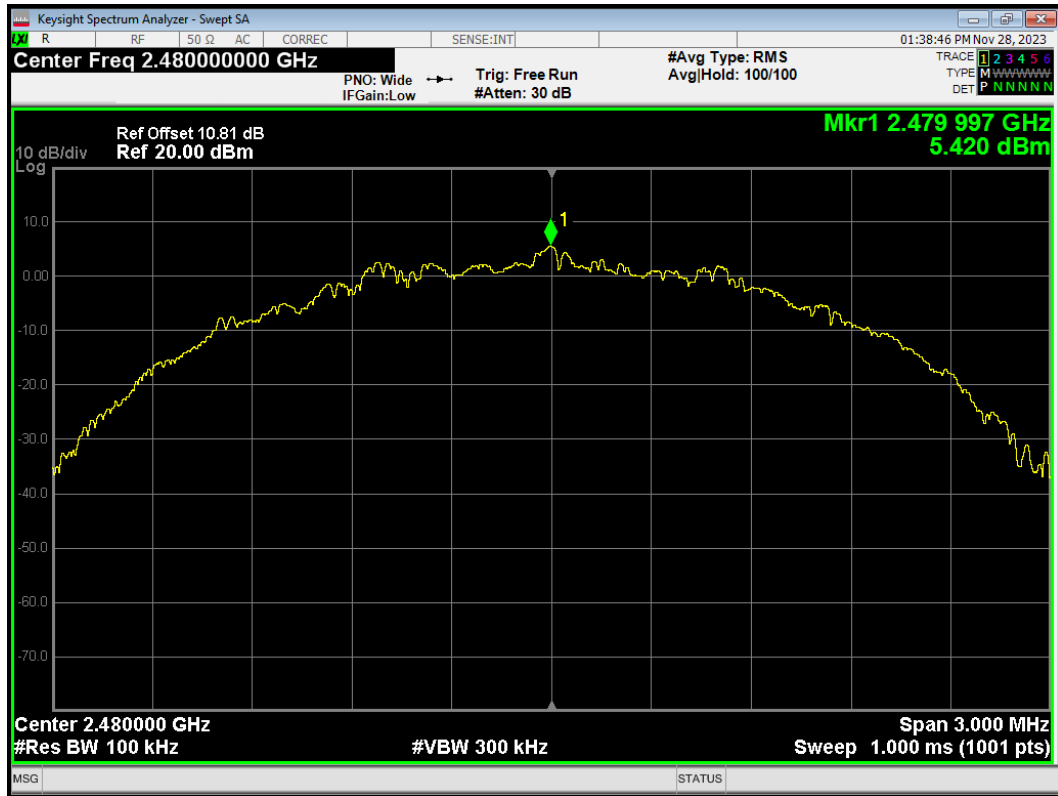

Tx. Spurious Bluetooth LE(2M) 2480MHz Emission

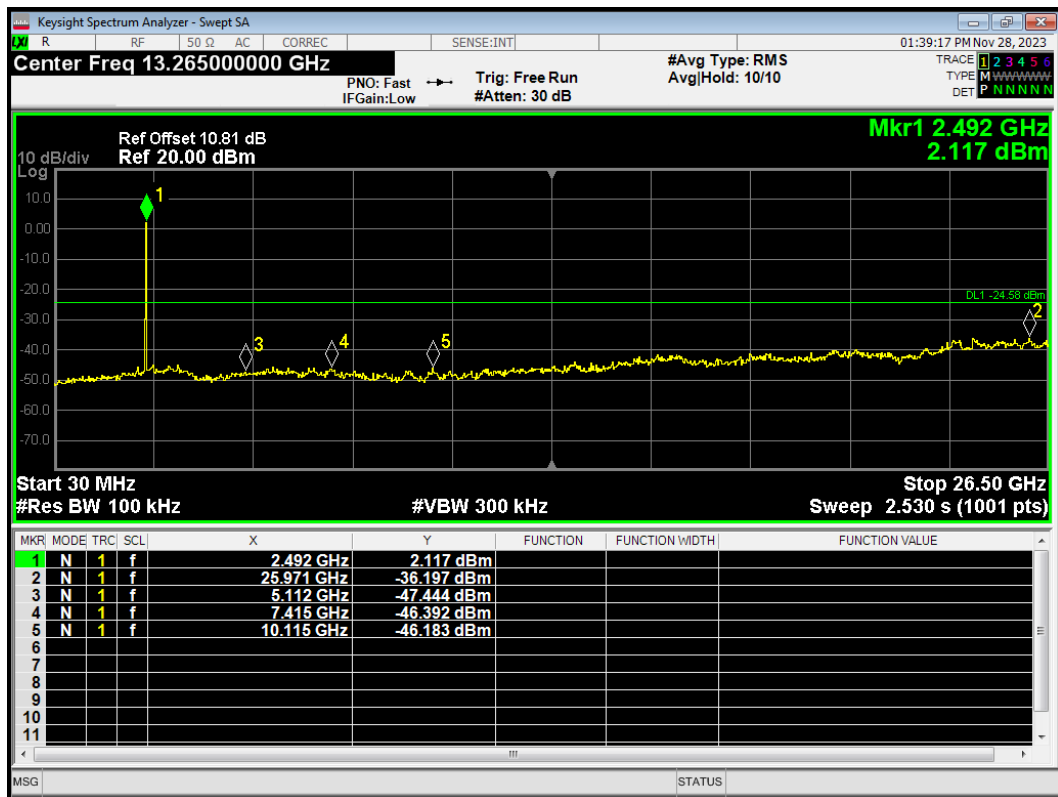

## 5.6. Unwanted Emission

### Ambient Condition

Temperature	Relative humidity
15°C ~ 35°C	20% ~ 80%

### Method of Measurement

The test set-up was made in accordance to the general provisions of ANSI C63.10.

The Equipment Under Test (EUT) was set up on a non-conductive table in the semi-anechoic chamber. The test was performed at the distance of 3 m between the EUT and the receiving antenna.

The turntable shall be rotated from 0 to 360 degrees for detecting the maximum of radiated spurious signal level. The measurements shall be repeated with orthogonal polarization of the test antenna. The data of cable loss and antenna factor has been calibrated in full testing frequency range before the testing. Sweep the Restricted Band and the emissions less than 20 dB below the permissible value are reported.

The radiated emissions measurements were made in a typical installation configuration.

Sweep the whole frequency band through the range from 9 kHz to the 10th harmonic of the carrier, and the emissions less than 20 dB below the permissible value are reported.

This method refer to ANSI C63.10.

The procedure for peak unwanted emissions measurements above 1000 MHz is as follows:

Set the spectrum analyzer in the following:

9kHz~150 kHz

RBW=200Hz, VBW=1kHz/ Sweep=AUTO

150 kHz~30MHz

RBW=9KHz, VBW=30KHz,/ Sweep=AUTO

Below 1GHz

RBW=100kHz / VBW=300kHz / Sweep=AUTO

a) Peak emission levels are measured by setting the instrument as follows:

Above 1GHz

PEAK: RBW=1MHz VBW=3MHz/ Sweep=AUTO

b) Average emission levels are measured by setting the instrument as follows:

Above 1GHz

AVERAGE: RBW=1MHz / VBW=3MHz / Sweep=AUTO

c) Detector: The measurements employing a CISPR quasi-peak detector except for the frequency bands 9-90 kHz, 110-490 kHz and above 1000 MHz. Radiated emission limits in these three bands are based on measurements employing an average detector.

d) Averaging type = power (i.e., rms) (As an alternative, the detector and averaging type may be set for linear voltage averaging. Some instruments require linear display mode to use linear voltage

averaging. Log or dB averaging shall not be used.)

e) Sweep time = auto.

f) Perform a trace average of at least 100 traces if the transmission is continuous. If the transmission is not continuous, then the number of traces shall be increased by a factor of  $1 / D$ , where  $D$  is the duty cycle. For example, with 50% duty cycle, at least 200 traces shall be averaged. (If a specific emission is demonstrated to be continuous—i.e., 100% duty cycle—then rather than turning ON and OFF with the transmit cycle, at least 100 traces shall be averaged.)

g) If tests are performed with the EUT transmitting at a duty cycle less than 98%, then a correction factor shall be added to the measurement results prior to comparing with the emission limit, to compute the emission level that would have been measured had the test been performed at 100% duty cycle. The correction factor is computed as follows:

1) If power averaging (rms) mode was used in the preceding step e), then the correction factor is  $[10 \log (1 / D)]$ , where  $D$  is the duty cycle. For example, if the transmit duty cycle was 50%, then 3 dB shall be added to the measured emission levels.

2) If linear voltage averaging mode was used in the preceding step e), then the correction factor is  $[20 \log (1 / D)]$ , where  $D$  is the duty cycle. For example, if the transmit duty cycle was 50%, then 6 dB shall be added to the measured emission levels.

3) If a specific emission is demonstrated to be continuous (100% duty cycle) rather than turning ON and OFF with the transmit cycle, then no duty cycle correction is required for that emission.

The test is in transmitting mode.

**Test Setup**

**9KHz~ 30MHz**

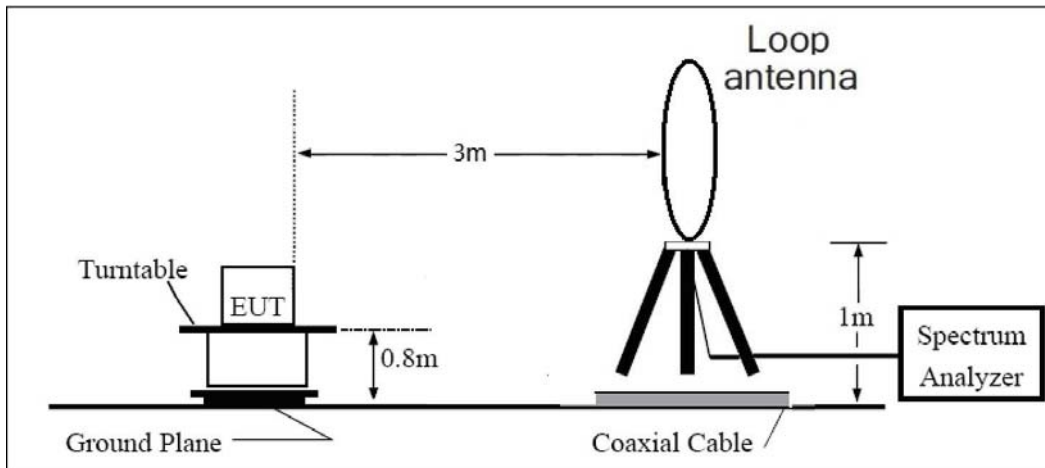

**30MHz~ 1GHz**

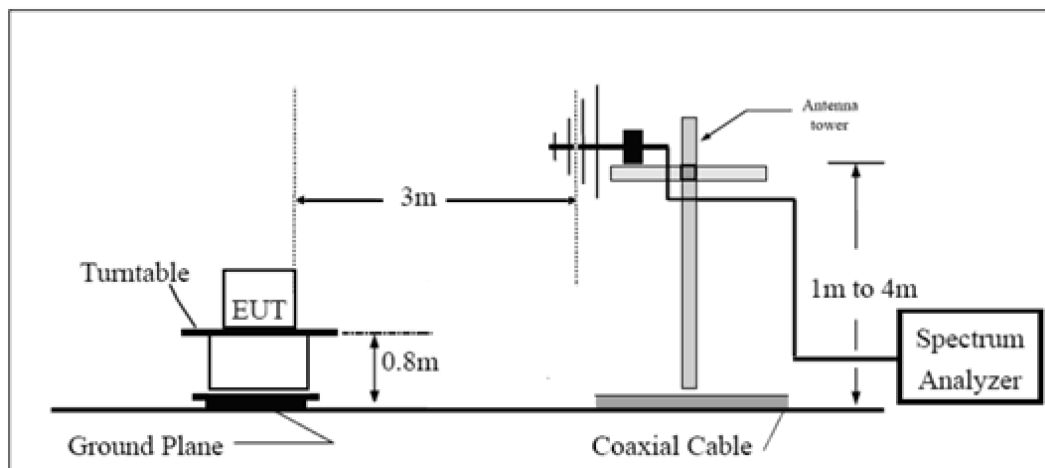

**Above 1GHz**

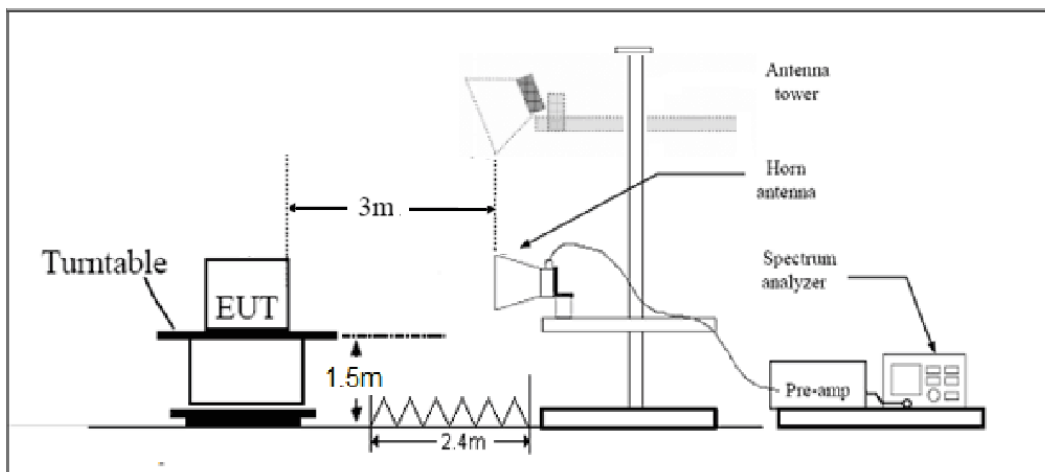

Note: Area side:2.4mX3.6m



### Limits

Rule Part 15.247(d) specifies that “In addition, radiated emissions which fall in the restricted bands, as defined in § 15.205(a), must also comply with the radiated emission limits specified in § 15.209(a) (see § 15.205(c)).”

Limit in restricted band

Frequency of emission (MHz)	Field strength( $\mu\text{V}/\text{m}$ )	Field strength( $\text{dB}\mu\text{V}/\text{m}$ )
0.009–0.490	2400/F(kHz)	/
0.490–1.705	24000/F(kHz)	/
1.705–30.0	30	/
30-88	100	40
88-216	150	43.5
216-960	200	46
Above960	500	54

### §15.35(b)

There is also a limit on the radio frequency emissions, as measured using instrumentation with a peak detector function, corresponding to 20 dB above the maximum permitted average limit.

Peak Limit=74  $\text{dB}\mu\text{V}/\text{m}$

Average Limit=54  $\text{dB}\mu\text{V}/\text{m}$

Spurious Radiated Emissions are permitted in any of the frequency bands listed below:

MHz	MHz	MHz	GHz
0.090-0.110	16.42-16.423	399.9-410	4.5-5.15
<sup>1</sup> 0.495-0.505	16.69475-16.69525	608-614	5.35-5.46
2.1735-2.1905	16.80425-16.80475	960-1240	7.25-7.75
4.125-4.128	25.5-25.67	1300-1427	8.025-8.5
4.17725-4.17775	37.5-38.25	1435-1626.5	9.0-9.2
4.20725-4.20775	73-74.6	1645.5-1646.5	9.3-9.5
6.215-6.218	74.8-75.2	1660-1710	10.6-12.7
6.26775-6.26825	108-121.94	1718.8-1722.2	13.25-13.4
6.31175-6.31225	123-138	2200-2300	14.47-14.5
8.291-8.294	149.9-150.05	2310-2390	15.35-16.2
8.362-8.366	156.52475-156.52525	2483.5-2500	17.7-21.4
8.37625-8.38675	156.7-156.9	2690-2900	22.01-23.12
8.41425-8.41475	162.0125-167.17	3260-3267	23.6-24.0
12.29-12.293	167.72-173.2	3332-3339	31.2-31.8
12.51975-12.52025	240-285	3345.8-3358	36.43-36.5
12.57675-12.57725	322-335.4	3600-4400	( <sup>2</sup> )
13.36-13.41			

### Measurement Uncertainty

The assessed measurement uncertainty to ensure 95% confidence level for the normal distribution is with the coverage factor  $k = 1.96$ .

Frequency	Uncertainty
9KHz-30MHz	3.55 dB
30MHz-200MHz	4.17 dB
200MHz-1GHz	4.84 dB
1-18GHz	4.35 dB
18-26.5GHz	5.90 dB
26.5GHz~40GHz	5.92 dB

**Test Results:**

A symbol ( $\text{dB } \mu\text{V/m}$ ) in the test plot below means (dB $\mu\text{V/m}$ )

**After the pretest, Bluetooth LE (2M) was selected as the worst Mode for Bluetooth LE.**

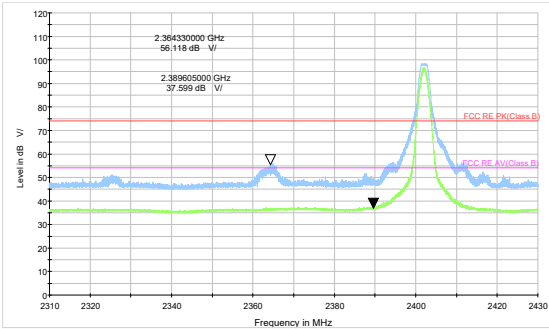

Bluetooth LE (2M) Channel 0 Peak+ Average

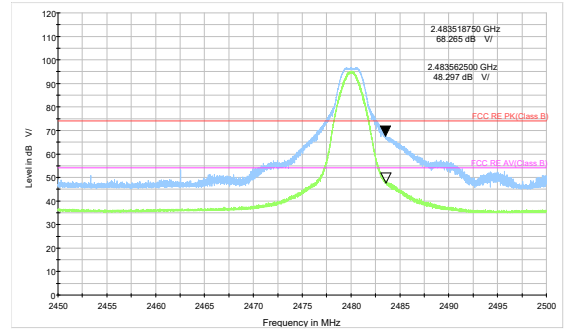

Bluetooth LE (2M) Channel 39 Peak+Average

**Result of RE**

**Test result**

Sweep the whole frequency band through the range from 9kHz to the 10th harmonic of the carrier, the Emissions in the frequency band 9kHz-30MHz are more than 20dB below the limit are not reported.

The following graphs display the maximum values of horizontal and vertical by software. For above 1GHz, Blue trace uses the peak detection, Green trace uses the average detection.

**Continuous TX mode:**

**Bluetooth LE**

During the test, the Radiates Emission from 30MHz to 1GHz was performed in all modes with all channels, Bluetooth LE (2M)-Channel 19 are selected as the worst condition. The test data of the worst-case condition was recorded in this report.

A symbol ( $\text{dB } \mu\text{V/m}$ ) in the test plot below means (dB $\mu\text{V/m}$ )

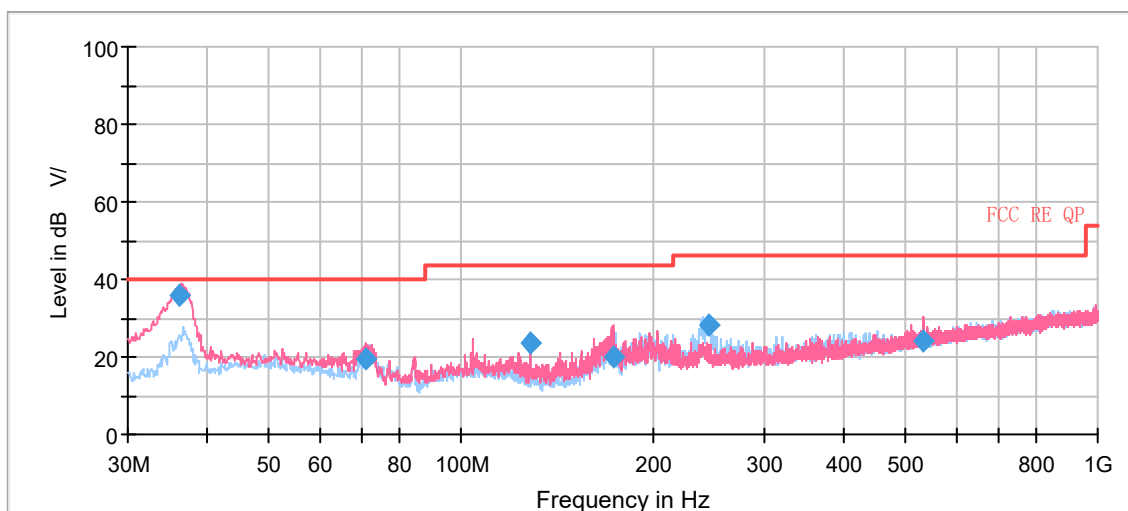

Radiates Emission from 30MHz to 1GHz

Frequency (MHz)	Quasi-Peak (dB $\mu\text{V/m}$ )	Limit (dB $\mu\text{V/m}$ )	Margin (dB)	Height (cm)	Polarization	Azimuth (deg)	Correct Factor (dB)
36.146250	35.84	40.00	4.16	100.0	V	146.0	18.5
71.100000	19.50	40.00	20.50	100.0	V	284.0	16.1
128.495000	23.83	43.50	19.67	100.0	V	52.0	15.9
173.796250	20.04	43.50	23.46	100.0	V	126.0	19.8
245.091250	28.11	46.00	17.89	125.0	H	193.0	19.8
533.268750	23.87	46.00	22.13	100.0	V	187.0	25.9

**Remark: 1. Correction Factor = Antenna factor + Insertion loss (cable loss + amplifier gain)  
 2. Margin = Limit – Quasi-Peak**

Bluetooth LE (2M)-Channel 0

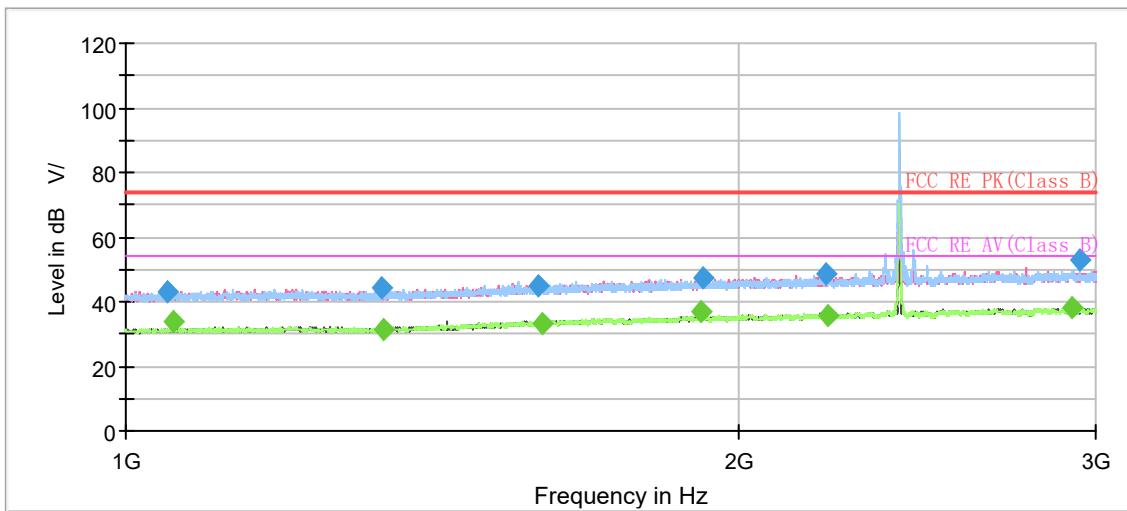

Note: The signal beyond the limit is carrier.  
Radiates Emission from 1GHz to 3GHz

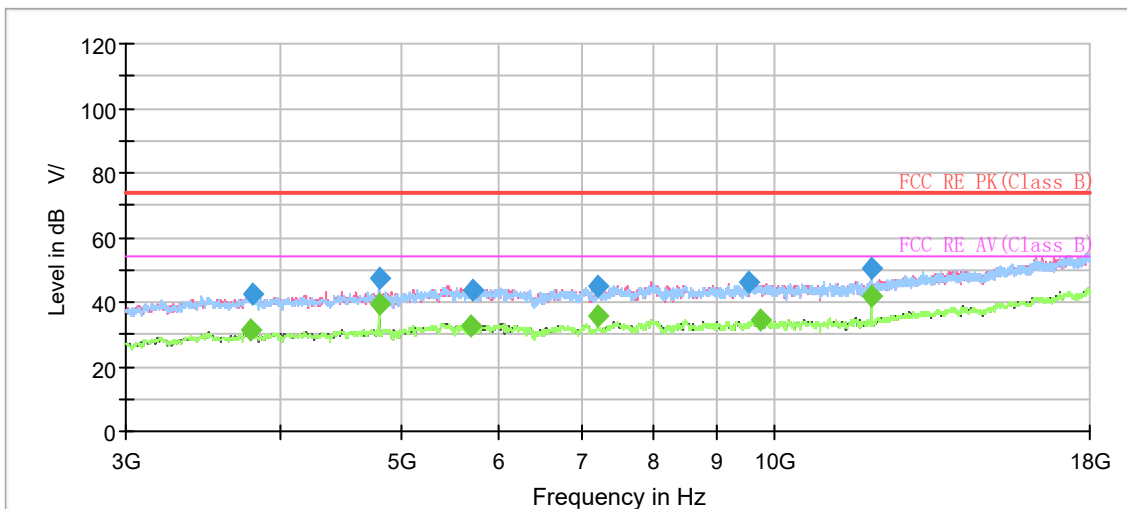

Radiates Emission from 3GHz to 18GHz

Frequency (MHz)	MaxPeak (dB $\mu$ V/m)	Average (dB $\mu$ V/m)	Limit (dB $\mu$ V/m)	Margin (dB)	Meas. Time (ms)	Height (cm)	Pol	Azimuth (deg)	Corr. (dB/m)
1048.000000	42.83	---	74.00	31.17	500.0	200.0	V	56.0	-8.2
1055.250000	---	33.77	54.00	20.23	500.0	100.0	V	342.0	-8.1
1335.750000	44.09	---	74.00	29.91	500.0	100.0	H	165.0	-6.3
1338.750000	---	31.41	54.00	22.59	500.0	100.0	V	0.0	-6.2
1596.500000	45.16	---	74.00	28.84	500.0	200.0	H	55.0	-4.6
1604.250000	---	33.51	54.00	20.49	500.0	200.0	V	271.0	-4.5
1920.000000	---	37.12	54.00	16.88	500.0	200.0	V	357.0	-2.7
1923.250000	47.11	---	74.00	26.89	500.0	100.0	H	276.0	-2.6
2212.000000	48.31	---	74.00	25.69	500.0	200.0	V	200.0	-1.5
2215.500000	---	35.96	54.00	18.04	500.0	100.0	V	152.0	-1.4
2917.500000	---	38.19	54.00	15.81	500.0	200.0	V	235.0	1.6
2947.500000	52.62	---	74.00	21.38	500.0	200.0	H	25.0	1.6

**Remark: 1. Correction Factor = Antenna factor + Insertion loss (cable loss + amplifier gain)**

**2. Margin = Limit -MAX Peak/ Average**

Bluetooth LE (2M)-Channel 19

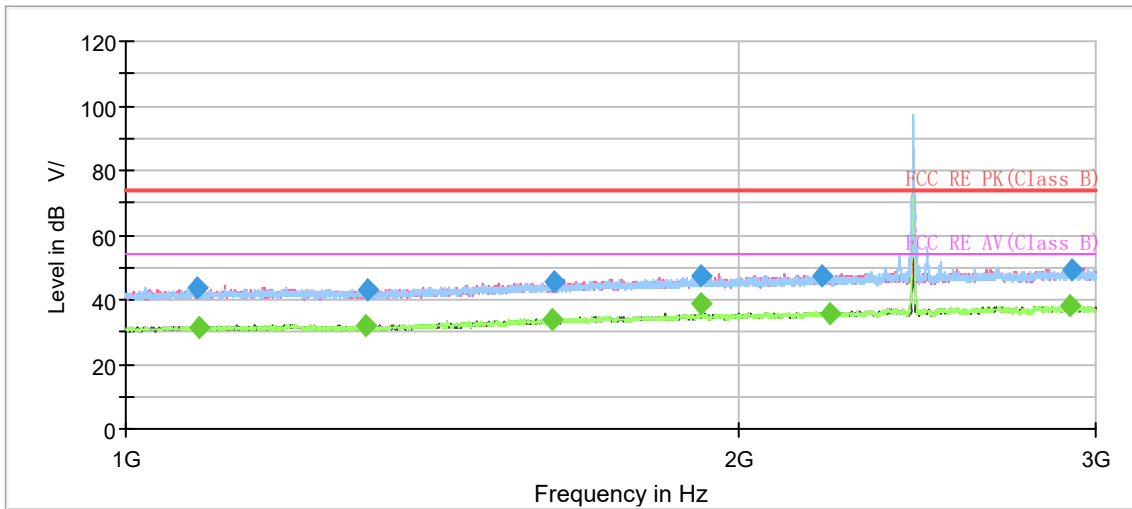

Note: The signal beyond the limit is carrier.  
Radiates Emission from 1GHz to 3GHz

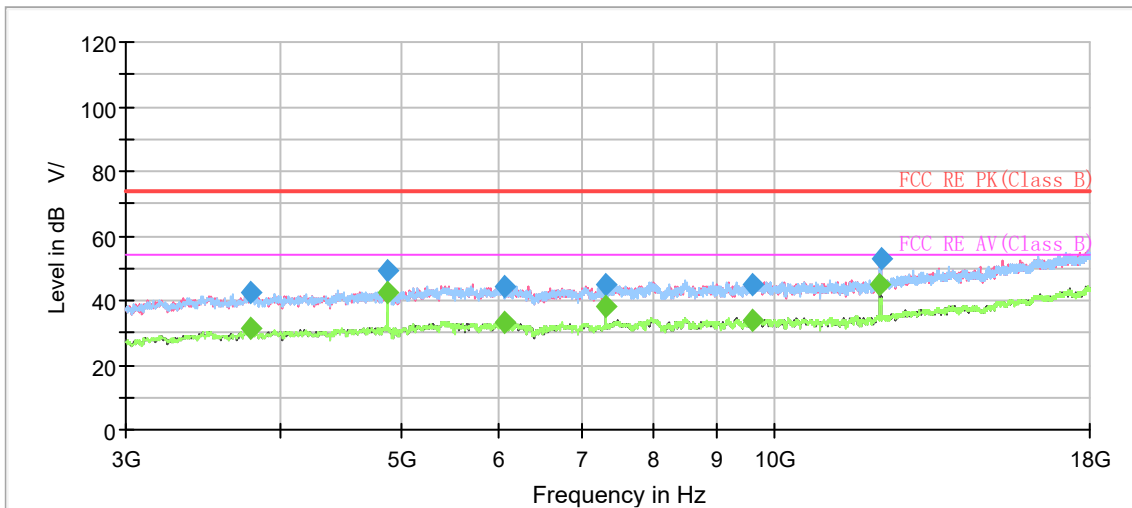

Radiates Emission from 3GHz to 18GHz

Frequency (MHz)	MaxPeak (dB $\mu$ V/m)	Average (dB $\mu$ V/m)	Limit (dB $\mu$ V/m)	Margin (dB)	Meas. Time (ms)	Height (cm)	Pol	Azimuth (deg)	Corr. (dB/m)
1084.750000	43.92	---	74.00	30.08	500.0	100.0	V	356.0	-7.8
1085.500000	---	31.28	54.00	22.72	500.0	100.0	V	31.0	-7.8
1312.250000	---	31.83	54.00	22.17	500.0	100.0	H	337.0	-6.3
1316.500000	43.17	---	74.00	30.83	500.0	100.0	H	315.0	-6.3
1621.250000	---	33.61	54.00	20.39	500.0	200.0	H	1.0	-4.4
1624.500000	45.28	---	74.00	28.72	500.0	100.0	V	179.0	-4.4
1920.250000	---	38.49	54.00	15.51	500.0	200.0	V	0.0	-2.7
1920.250000	47.55	---	74.00	26.45	500.0	100.0	H	150.0	-2.7
2201.000000	47.64	---	74.00	26.36	500.0	100.0	H	349.0	-1.6
2221.250000	---	35.90	54.00	18.10	500.0	100.0	V	314.0	-1.4
2916.250000	---	38.02	54.00	15.98	500.0	200.0	H	0.0	1.6
2920.000000	49.48	---	74.00	24.52	500.0	200.0	V	106.0	1.7
12197.941830	---	44.70	54.00	9.30	500.0	200.0	V	0.0	4.5

**Remark: 1. Correction Factor = Antenna factor + Insertion loss (cable loss + amplifier gain)**  
**2. Margin = Limit –MAX Peak/ Average**



Bluetooth LE (2M)-Channel 39

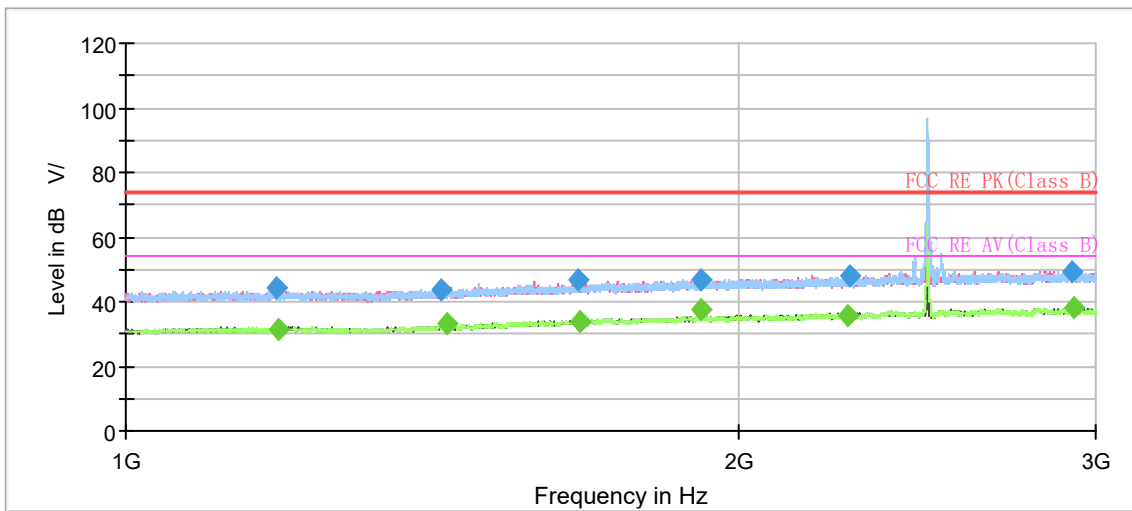

Note: The signal beyond the limit is carrier.  
Radiates Emission from 1GHz to 3GHz

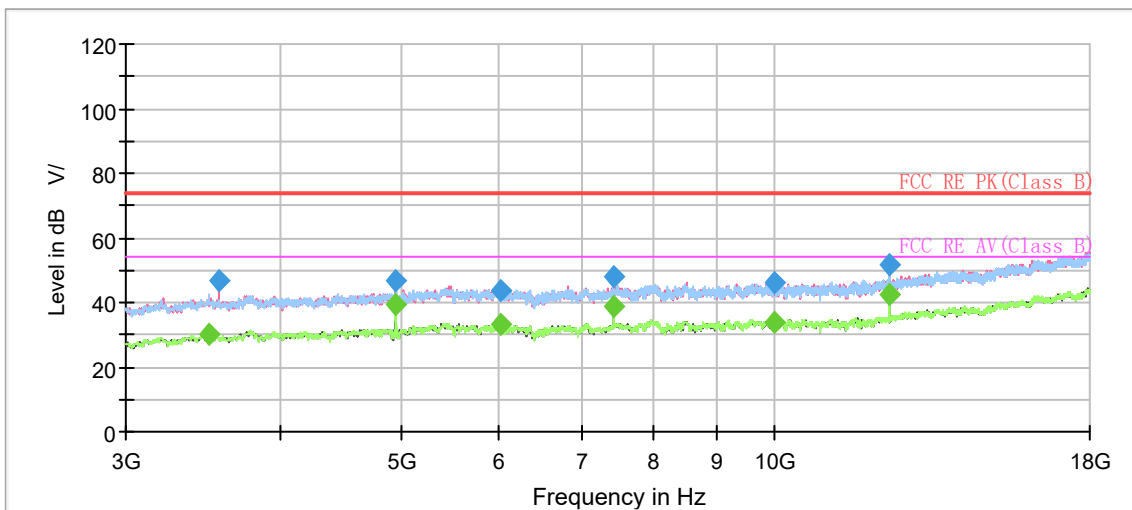

Radiates Emission from 3GHz to 18GHz

Frequency (MHz)	MaxPeak (dB $\mu$ V/m)	Average (dB $\mu$ V/m)	Limit (dB $\mu$ V/m)	Margin (dB)	Meas. Time (ms)	Height (cm)	Pol	Azimuth (deg)	Corr. (dB/m)
1185.250000	44.14	---	74.00	29.86	500.0	200.0	V	234.0	-7.1
1188.000000	---	31.33	54.00	22.67	500.0	200.0	V	336.0	-7.1
1428.250000	43.71	---	74.00	30.29	500.0	100.0	H	176.0	-5.4
1440.000000	---	32.93	54.00	21.07	500.0	200.0	H	52.0	-5.4
1670.750000	46.51	---	74.00	27.49	500.0	100.0	H	349.0	-4.2
1672.000000	---	33.64	54.00	20.36	500.0	200.0	V	258.0	-4.2
1918.250000	46.79	---	74.00	27.21	500.0	100.0	V	274.0	-2.7
1920.000000	---	37.25	54.00	16.75	500.0	200.0	V	0.0	-2.7
2265.250000	---	35.60	54.00	18.40	500.0	200.0	V	347.0	-1.5
2271.750000	48.06	---	74.00	25.94	500.0	200.0	V	234.0	-1.4
2923.250000	49.04	---	74.00	24.96	500.0	100.0	V	19.0	1.7
2924.000000	---	38.24	54.00	15.76	500.0	100.0	V	36.0	1.8

**Remark: 1. Correction Factor = Antenna factor + Insertion loss (cable loss + amplifier gain)**

**2. Margin = Limit -MAX Peak/ Average**

During the test, the Radiates Emission from 18GHz to 26.5GHz was performed in all modes with all channels, Bluetooth LE (2M)-Channel 19 are selected as the worst condition. The test data of the worst-case condition was recorded in this report.

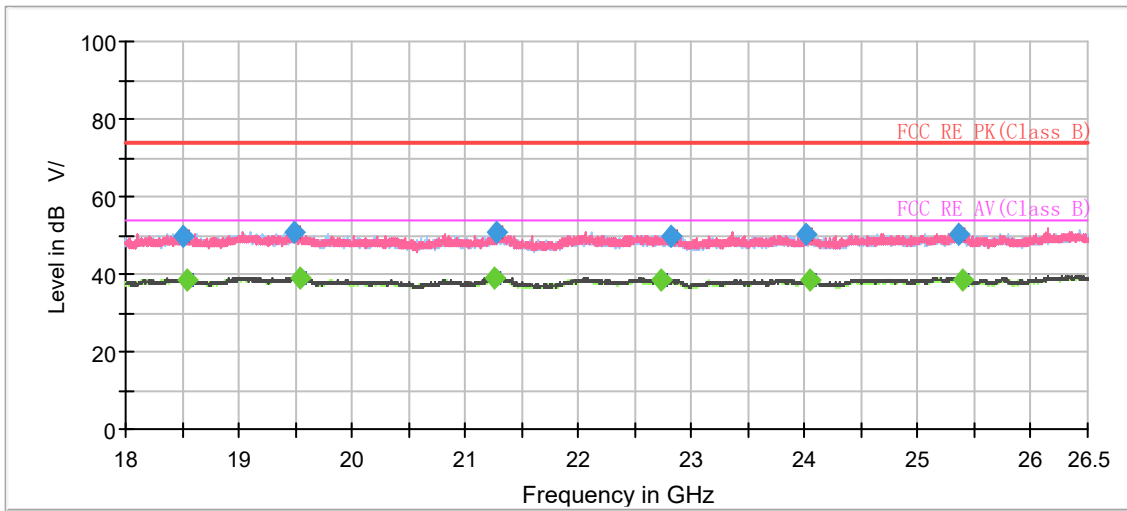

Radiates Emission from 18GHz to 26.5GHz

Frequency (MHz)	MaxPeak (dBμV/m)	Average (dBμV/m)	Limit (dBμV/m)	Margin (dB)	Meas. Time (ms)	Height (cm)	Pol	Azimuth (deg)	Corr. (dB/m)
18502.562500	49.62	---	74.00	24.38	500.0	100.0	H	57.0	-3.0
18539.750000	---	38.61	54.00	15.39	500.0	100.0	V	273.0	-3.0
19497.062500	50.82	---	74.00	23.18	500.0	100.0	V	297.0	-2.7
19545.937500	---	39.04	54.00	14.96	500.0	200.0	H	294.0	-2.9
21251.250000	---	39.04	54.00	14.96	500.0	200.0	H	276.0	-2.1
21269.312500	50.65	---	74.00	23.35	500.0	100.0	V	309.0	-2.0
22738.750000	---	38.24	54.00	15.76	500.0	200.0	H	318.0	-1.7
22821.625000	49.80	---	74.00	24.20	500.0	200.0	H	189.0	-1.6
24007.375000	50.06	---	74.00	23.94	500.0	100.0	V	138.0	-1.2
24049.875000	---	38.36	54.00	15.64	500.0	100.0	H	14.0	-1.3
25357.812500	50.04	---	74.00	23.96	500.0	200.0	V	187.0	-0.2
25387.562500	---	38.60	54.00	15.40	500.0	100.0	H	32.0	-0.3

**Remark: 1. Correction Factor = Antenna factor + Insertion loss (cable loss + amplifier gain)  
 2. Margin = Limit –MAX Peak/ Average**

## 5.7. Conducted Emission

### Ambient Condition

Temperature	Relative humidity
15°C ~ 35°C	20% ~ 80%

### Methods of Measurement

The EUT is placed on a non-metallic table of 80cm height above the horizontal metal reference ground plane. During the test, the EUT was operating in its typical mode. The test method is according to ANSI C63.10. Connect the AC power line of the EUT to the L.I.S.N. Use EMI receiver to detect the average and Quasi-peak value. RBW is set to 9 kHz, VBW is set to 30kHz.

The measurement result should include both L line and N line.

The test is in transmitting mode.

### Test Setup

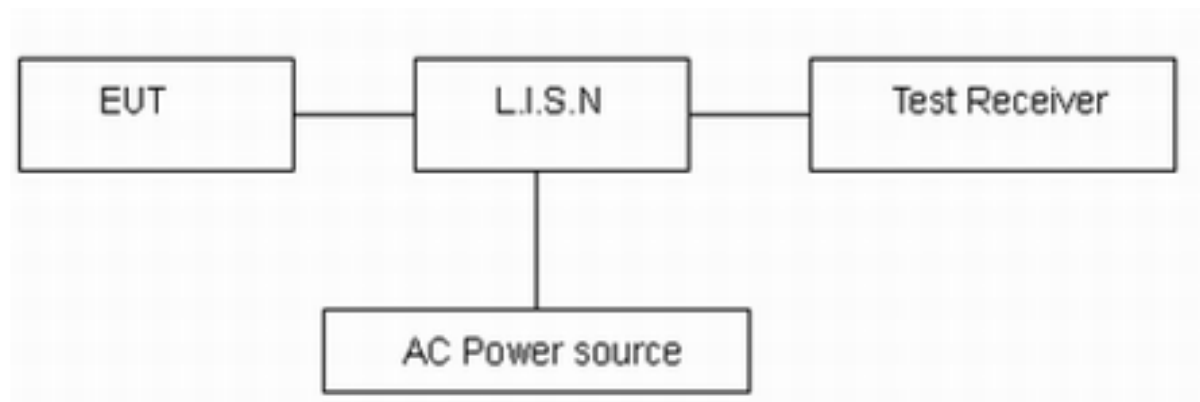

Note: AC Power source is used to change the voltage 120V/60Hz.

### Limits

Frequency (MHz)	Conducted Limits(dBμV)	
	Quasi-peak	Average
0.15 - 0.5	66 to 56 *	56 to 46*
0.5 - 5	56	46
5 - 30	60	50

\*: Decreases with the logarithm of the frequency.

### Measurement Uncertainty

The assessed measurement uncertainty to ensure 95% confidence level for the normal distribution is with the coverage factor  $k = 1.96$ ,  $U = 2.69$  dB.

**Test Results:**

Following plots, Blue trace uses the peak detection and Green trace uses the average detection.

**Bluetooth LE**

During the test, the Conducted Emission was performed in all modes with all channels, Bluetooth LE-Channel (2M) 19 are selected as the worst condition. The test data of the worst-case condition was recorded in this report.

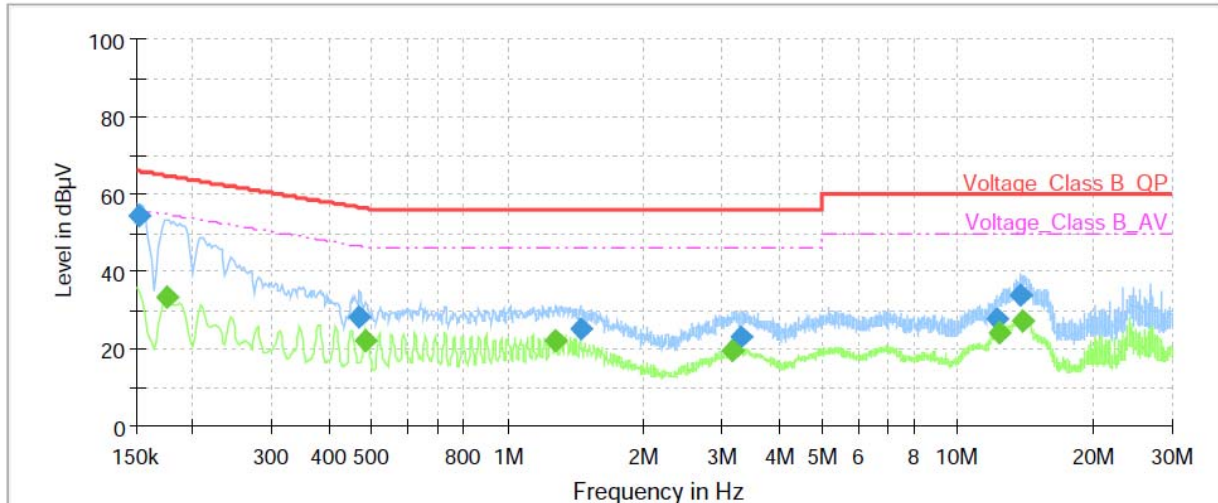

Frequency (MHz)	MaxPeak (dBµV/m)	Average (dBµV/m)	Limit (dBµV/m)	Margin (dB)	Meas. Time (ms)	Height (cm)	Pol	Azimuth (deg)	Corr. (dB/m)
0.15	54.49	---	65.88	11.39	1000.0	9.000	L1	ON	21.0
0.17	---	33.51	54.73	21.22	1000.0	9.000	L1	ON	21.1
0.47	28.25	---	56.52	28.27	1000.0	9.000	L1	ON	20.9
0.49	---	22.28	46.25	23.97	1000.0	9.000	L1	ON	20.9
1.28	---	21.95	46.00	24.05	1000.0	9.000	L1	ON	20.0
1.45	24.94	---	56.00	31.06	1000.0	9.000	L1	ON	19.9
3.16	---	19.74	46.00	26.26	1000.0	9.000	L1	ON	19.5
3.32	22.97	---	56.00	33.03	1000.0	9.000	L1	ON	19.5
12.22	27.66	---	60.00	32.34	1000.0	9.000	L1	ON	19.6
12.35	---	24.07	50.00	25.93	1000.0	9.000	L1	ON	19.6
13.88	33.86	---	60.00	26.14	1000.0	9.000	L1	ON	19.6
14.02	---	27.36	50.00	22.64	1000.0	9.000	L1	ON	19.6

**Remark: Correct factor=cable loss + LISN factor**

L line Conducted Emission from 150 KHz to 30 MHz

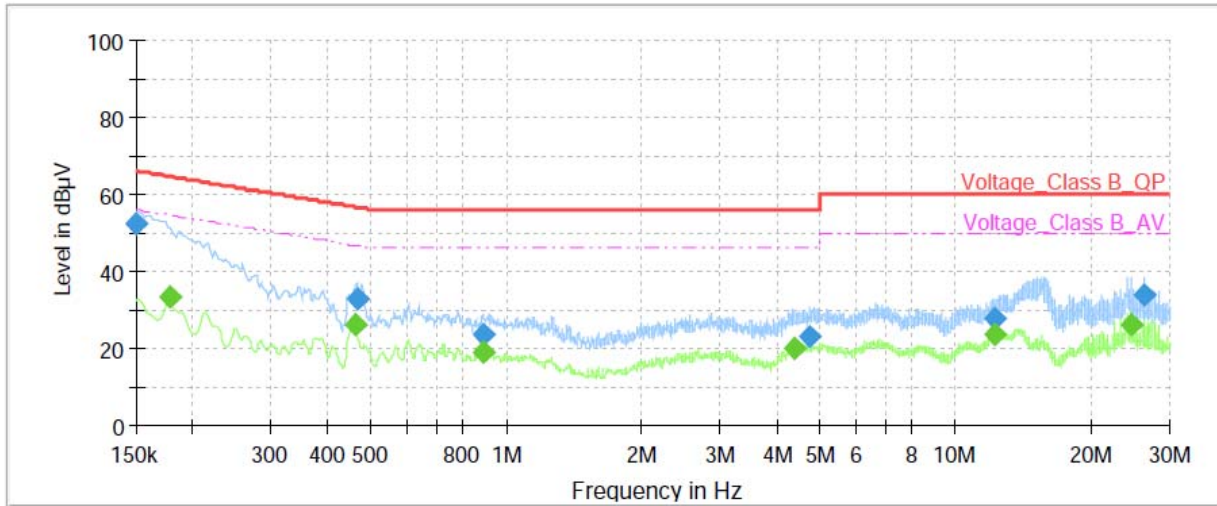

Frequency (MHz)	MaxPeak (dBµV/m)	Average (dBµV/m)	Limit (dBµV/m)	Margin (dB)	Meas. Time (ms)	Height (cm)	Pol	Azimuth (deg)	Corr. (dB/m)
0.15	52.06	---	66.00	13.94	1000.0	9.000	N	ON	21.0
0.18	---	33.16	54.52	21.36	1000.0	9.000	N	ON	21.1
0.46	---	26.07	46.68	20.61	1000.0	9.000	N	ON	20.9
0.47	33.00	---	56.60	23.60	1000.0	9.000	N	ON	20.9
0.89	23.39	---	56.00	32.61	1000.0	9.000	N	ON	20.3
0.89	---	19.19	46.00	26.81	1000.0	9.000	N	ON	20.3
4.38	---	20.07	46.00	25.93	1000.0	9.000	N	ON	19.5
4.74	23.04	---	56.00	32.96	1000.0	9.000	N	ON	19.5
12.30	27.57	---	60.00	32.43	1000.0	9.000	N	ON	19.6
12.30	---	23.62	50.00	26.38	1000.0	9.000	N	ON	19.6
24.73	---	26.10	50.00	23.90	1000.0	9.000	N	ON	19.8
26.18	33.84	---	60.00	26.16	1000.0	9.000	N	ON	19.8

**Remark: Correct factor=cable loss + LISN factor**

N line Conducted Emission from 150 KHz to 30 MHz

## 6. Main Test Instruments

Name	Manufacturer	Type	Serial Number	Calibration Date	Expiration Date
Power Sensor	R&S	NRP18S	101954	2023-05-12	2024-05-11
Spectrum Analyzer	KEYSIGHT	N9020A	MY51330870	2023-05-12	2024-05-11
Conducted Emission					
Artificial main network	R&S	ENV216	102191	2022-12-10	2024-12-09
EMI Test Receiver	R&S	ESR	101667	2023-05-12	2024-05-11
Software	R&S	EMC32	10.35.10	/	/
Unwanted Emission					
EMI Test Receiver	R&S	ESR	102389	2023-05-12	2024-05-11
Signal Analyzer	R&S	FSV40	101186	2023-05-12	2024-05-11
Loop Antenna	SCHWARZBECK	FMZB1519	1519-047	2023-04-16	2026-04-15
TRILOG Broadband Antenna	SCHWARZBECK	VULB 9163	1023	2023-07-14	2026-07-13
Horn Antenna	R&S	HF907	102723	2021-07-24	2024-07-23
Amplifier	R&S	SCU18	10034	2023-05-12	2024-05-11
Horn Antenna	ETS-Lindgren	3160-09	00102643	2021-10-10	2024-10-09
Amplifier	Micro Wave	KLNA-1804 0050	220826001	2023-09-01	2024-08-31
Software	R&S	EMC32	9.26.01	/	/

## ANNEX A: The EUT Appearance

The EUT Appearance are submitted separately.



## ANNEX B: Test Setup Photos

The Test Setup Photos are submitted separately.

\*\*\*\*\* END OF REPORT \*\*\*\*\*