

### 5.4. Power Spectral Density

#### Ambient Condition

Temperature	Relative humidity
15°C ~ 35°C	20% ~ 80%

#### Method of Measurement

During the process of the testing, The EUT was connected to Spectrum Analyzer with a known loss. The EUT is max power transmission with proper modulation.

Method AVGPS-2 was used for this test.

- a) Measure the duty cycle (D) of the transmitter output signal as described in 11.6
- b) Set instrument center frequency to DTS channel center frequency
- c) Set span to at least 1.5 times the OBW
- d) Set RBW to:  $3\text{kHz} \leq \text{RBW} \leq 100\text{kHz}$
- e) Set VBW  $\geq [3 \times \text{RBW}]$
- f) Detector= power averaging (rms) or sample detector (when rms not available)
- g) Ensure that the number of measurement points in the sweep  $\geq [2 \times \text{span}/\text{RBW}]$
- h) Sweep time =auto couple
- i) Do not use sweep triggering; allow sweep to "free run"
- j) Employ trace averaging (rms) mode over a minimum of 100 traces
- k) Use the peak marker function to determine the maximum amplitude level
- l) Add  $[10 \log(1/ D)]$ , where D is the duty cycle measured in step a), to the measured PSD to compute the average PSD during the actual transmission time
- m) If measured value exceeds requirement specified by regulatory agency then reduce RBW (but no less than 3 kHz) and repeat (note that this may require zooming in on the emission of interest and reducing the span to meet the minimum measurement point requirement as the RBW is reduced)

#### Test setup

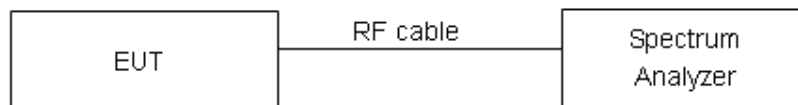

#### Limits

Rule Part 15.247(e) specifies that” For digitally modulated systems, the power spectral density conducted from the intentional radiator to the antenna shall not be greater than 8 dBm in any 3 kHz band during any time interval of continuous transmission. ”

Limits	$\leq 8 \text{ dBm} / 3\text{kHz}$
--------	------------------------------------

### Measurement Uncertainty

The assessed measurement uncertainty to ensure 95% confidence level for the normal distribution is with the coverage factor  $k = 2$ ,  $U = 0.75\text{dB}$ .

**Test Results:**

Test Mode	Carrier frequency (MHz) / Channel	Read Value (dBm / 30kHz)	Power Spectral Density (dBm / 3kHz)	Limit (dBm / 3kHz)	Conclusion
802.11b	2412/CH 1	-3.85	-13.36	8	PASS
	2437/CH 6	-3.07	-12.58	8	PASS
	2462/CH11	-5.74	-15.25	8	PASS
802.11g	2412/CH 1	-8.47	-16.07	8	PASS
	2437/CH 6	-8.12	-15.72	8	PASS
	2462/CH11	-9.11	-16.71	8	PASS
802.11n HT20	2412/CH 1	-8.61	-17.81	8	PASS
	2437/CH 6	-7.21	-16.41	8	PASS
	2462/CH11	-11.50	-20.70	8	PASS
802.11n HT40	2422/CH3	-13.25	-22.43	8	PASS
	2437/CH6	-10.46	-19.64	8	PASS
	2452/CH9	-12.83	-22.01	8	PASS
802.11ax HE20	2412/CH 1	-10.36	-19.34	8	PASS
	2437/CH 6	-9.90	-18.88	8	PASS
	2462/CH11	-12.41	-21.39	8	PASS
802.11ax HE40	2422/CH3	-14.25	-23.23	8	PASS
	2437/CH6	-12.49	-21.47	8	PASS
	2452/CH9	-14.89	-23.87	8	PASS

Note: Power Spectral Density (dBm/3kHz) =Read Value+Duty cycle correction factor + 10\*log10(3/30)

Test Mode	Carrier frequency (MHz) / Channel	Read Value (dBm / 3kHz)	Power Spectral Density (dBm / 3kHz)	Limit (dBm / 3kHz)	Conclusion
Bluetooth (Low Energy) (1M)	2402/CH0	-15.58	-14.87	8	PASS
	2440/CH19	-15.73	-15.02	8	PASS
	2480/CH39	-15.01	-14.30	8	PASS
Bluetooth (Low Energy) (2M)	2402/CH0	-19.53	-17.07	8	PASS
	2440/CH19	-20.12	-17.66	8	PASS
	2480/CH39	-19.40	-16.94	8	PASS
Bluetooth (Low Energy) (S=2)	2402/CH0	-11.05	-10.64	8	PASS
	2440/CH19	-11.92	-11.51	8	PASS
	2480/CH39	-10.76	-10.35	8	PASS
Bluetooth (Low Energy) (S=8)	2402/CH0	-1.30	-1.18	8	PASS
	2440/CH19	-1.27	-1.15	8	PASS
	2480/CH39	-0.25	-0.13	8	PASS

Note: Power Spectral Density =Read Value+Duty cycle correction factor

PSD 802.11ax(HE20) 2412MHz

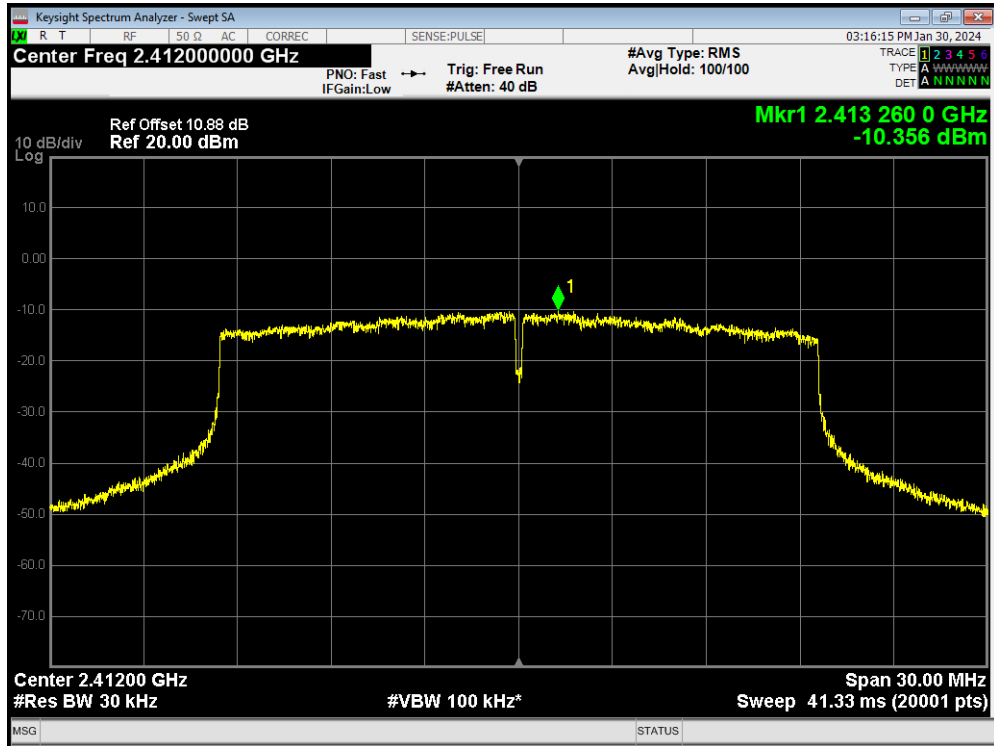

PSD 802.11ax(HE20) 2437MHz

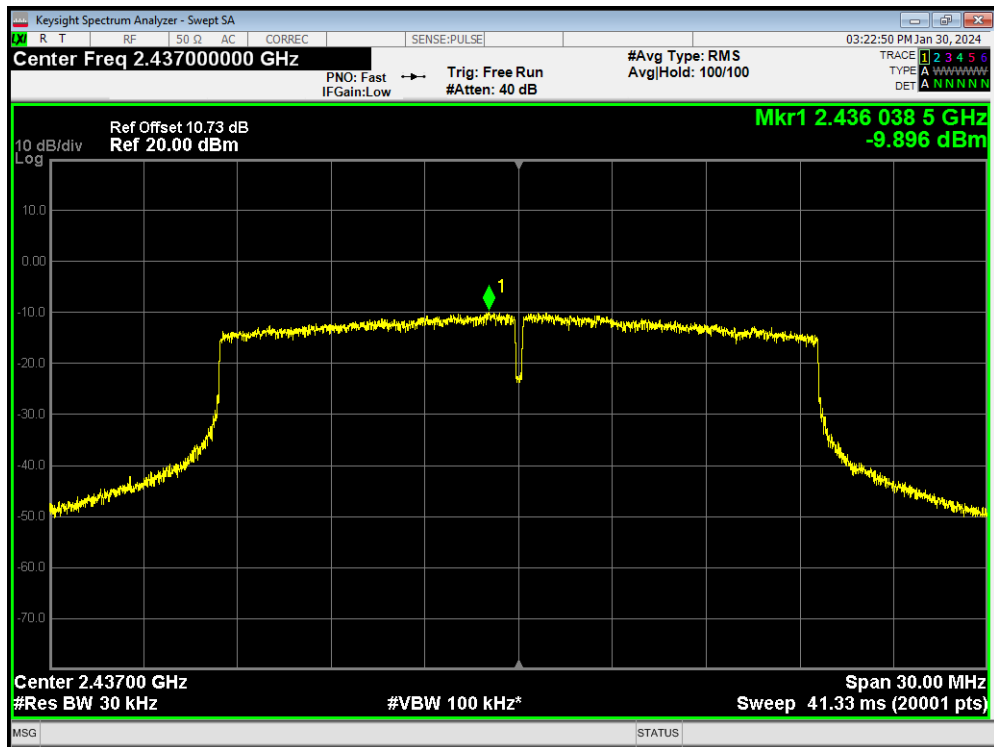

PSD 802.11ax(HE20) 2462MHz

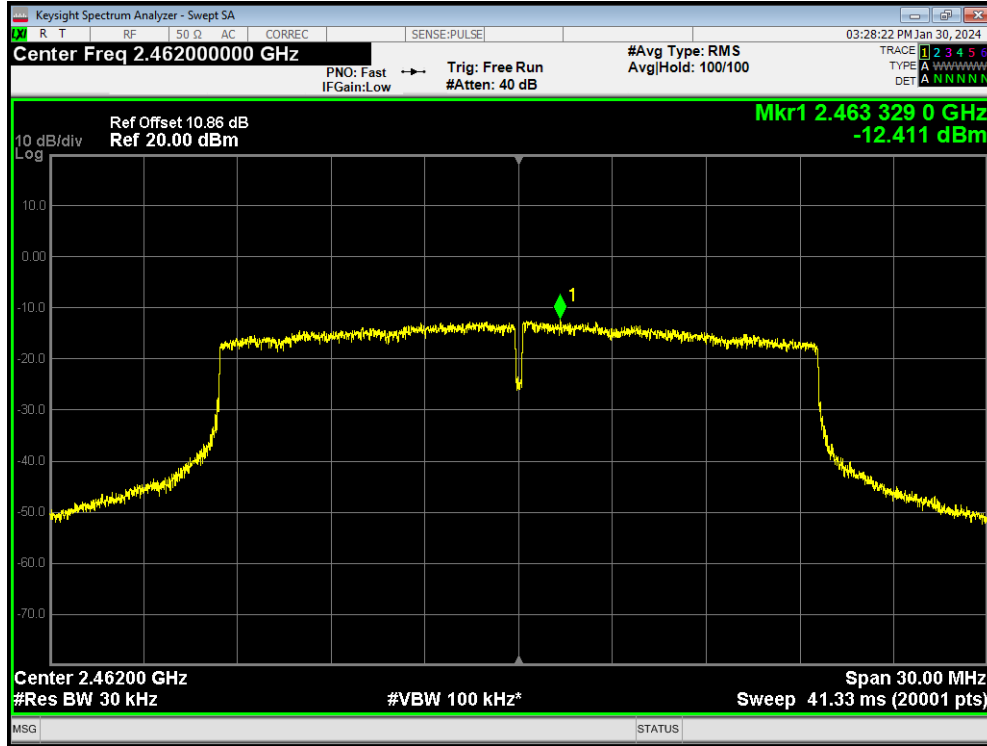

PSD 802.11ax(HE40) 2422MHz

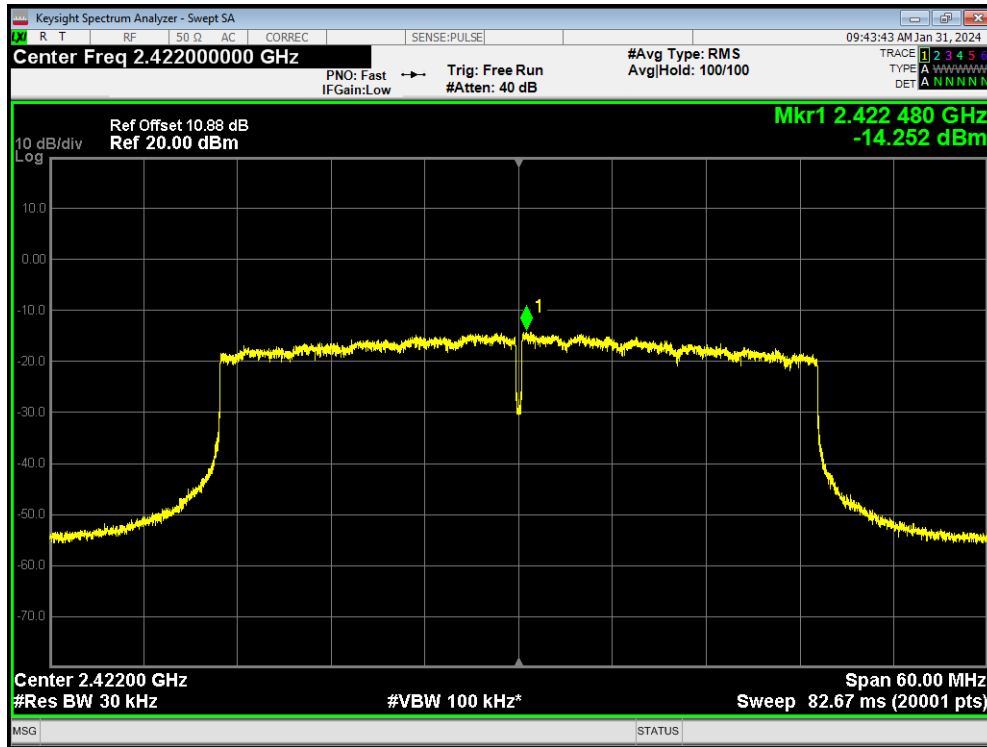

PSD 802.11ax(HE40) 2437MHz

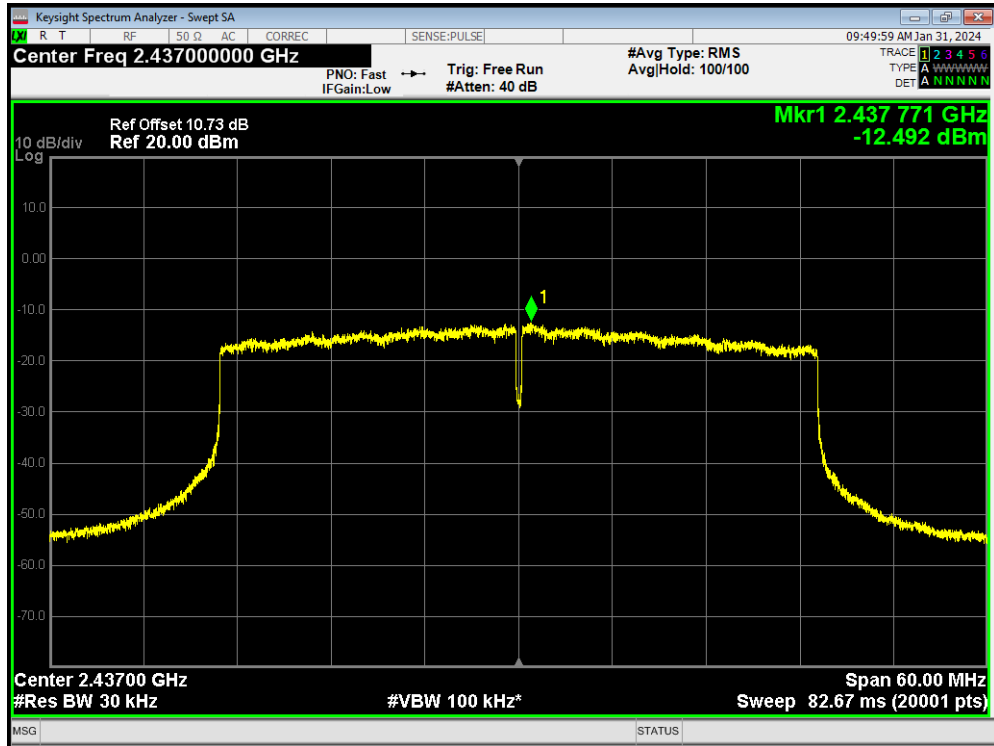

PSD 802.11ax(HE40) 2452MHz

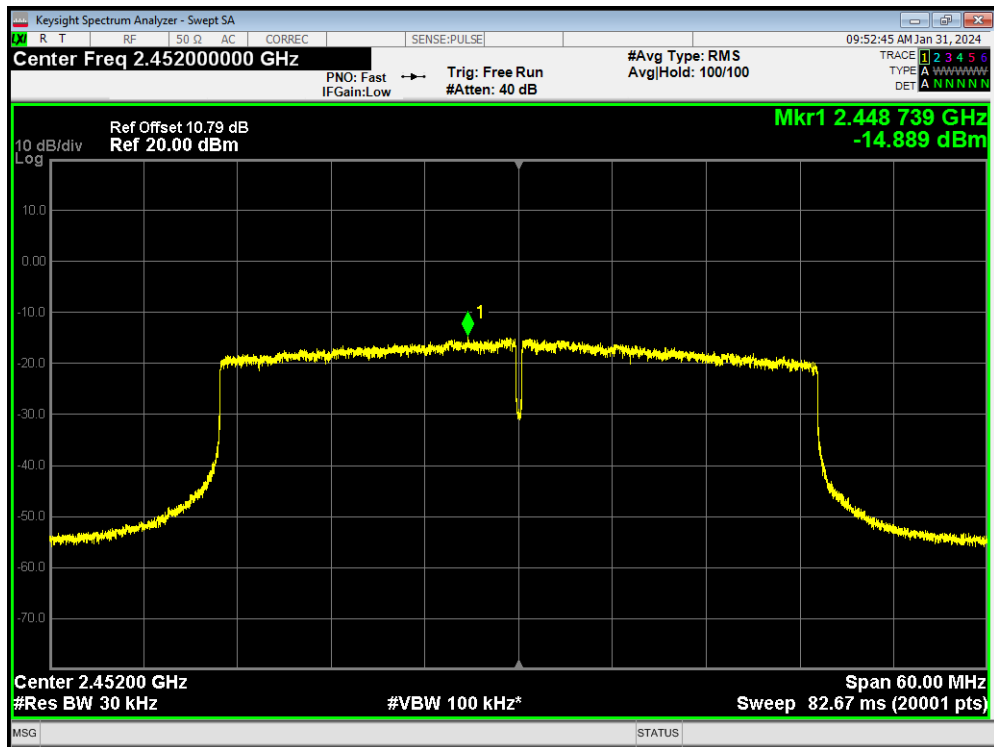

PSD 802.11b 2412MHz

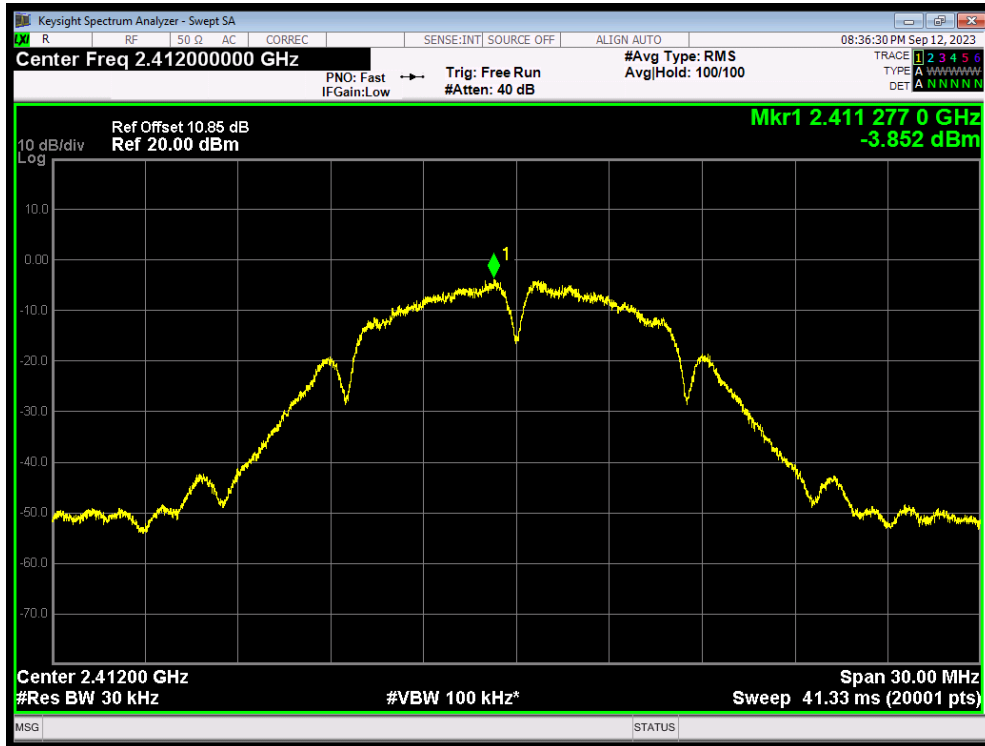

PSD 802.11b 2437MHz

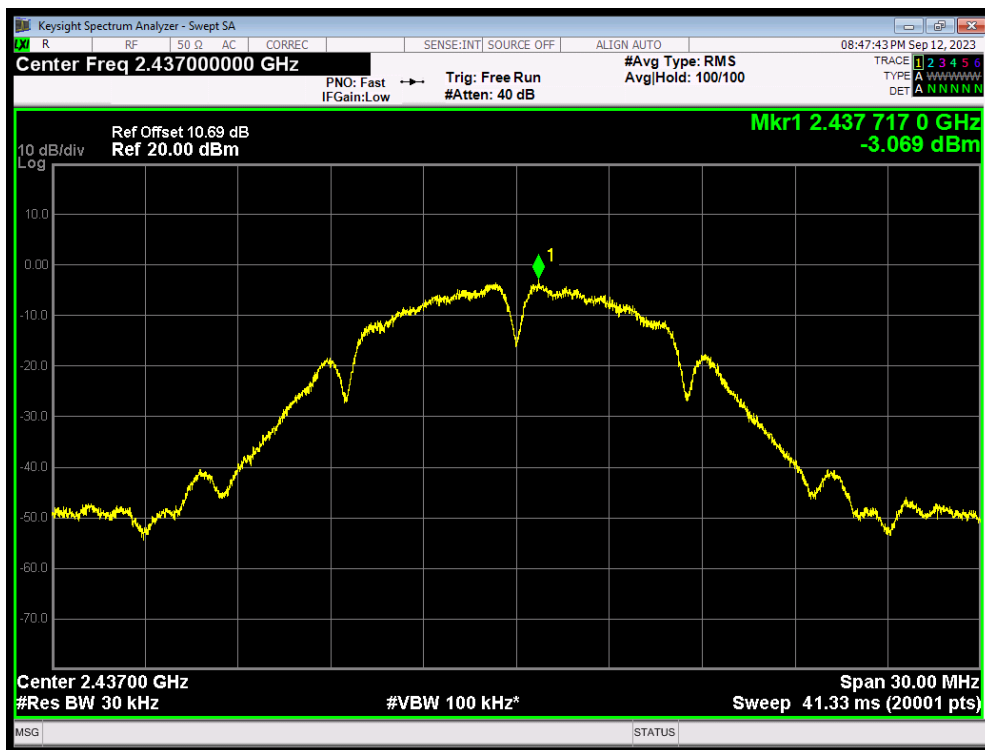



PSD 802.11b 2462MHz

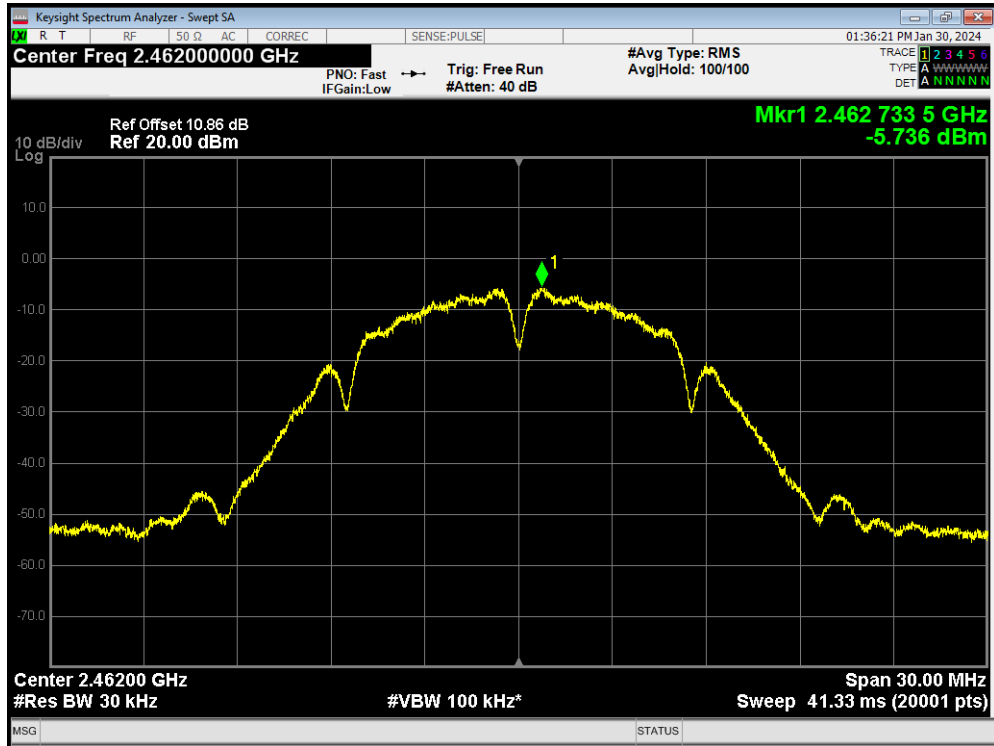

PSD 802.11g 2412MHz

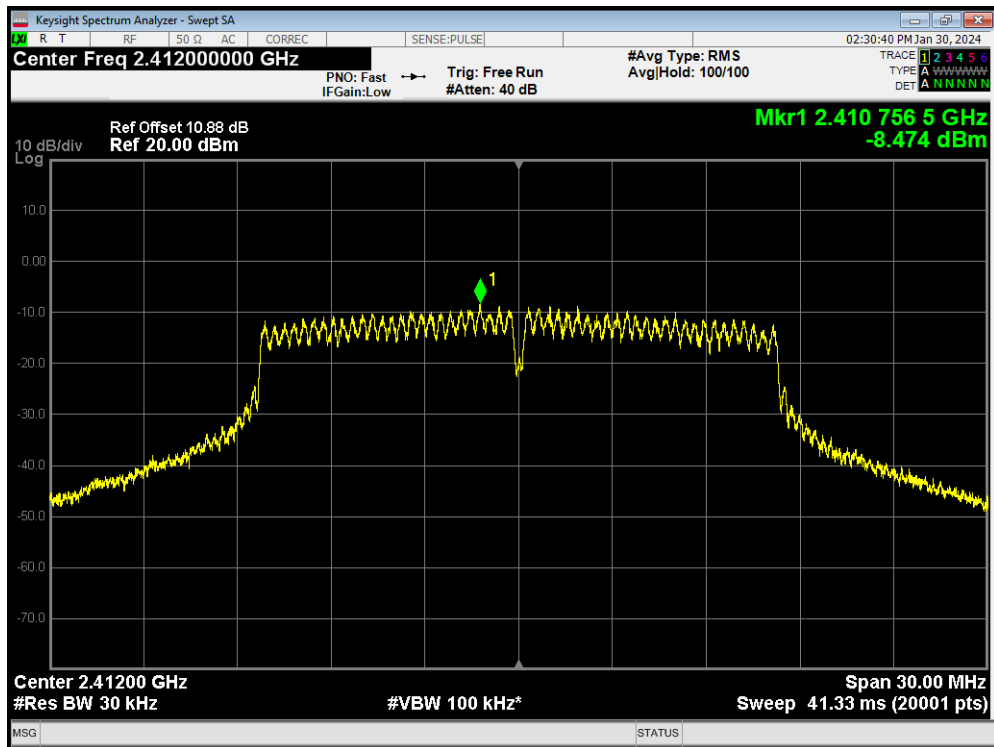

PSD 802.11g 2437MHz

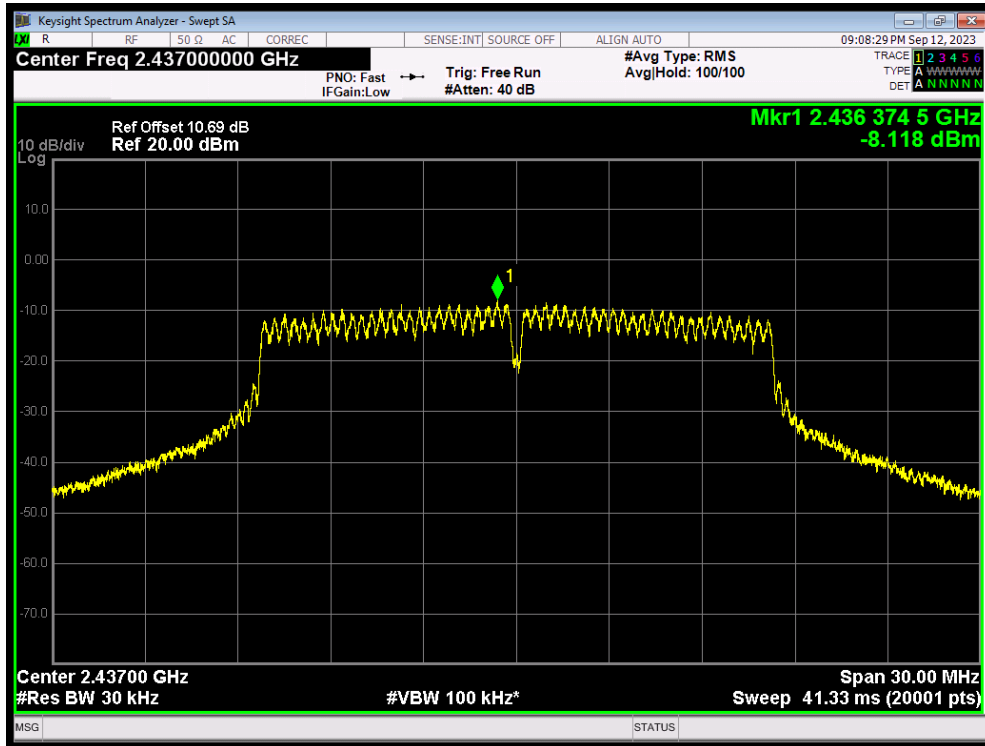

PSD 802.11g 2462MHz

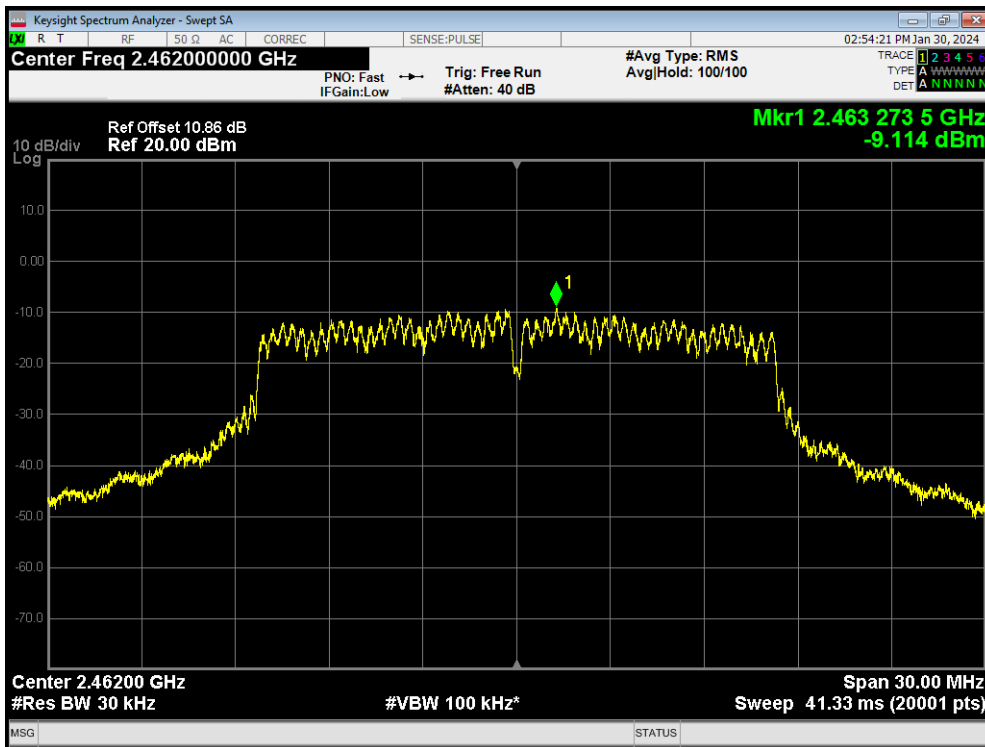

PSD 802.11n(HT20) 2412MHz

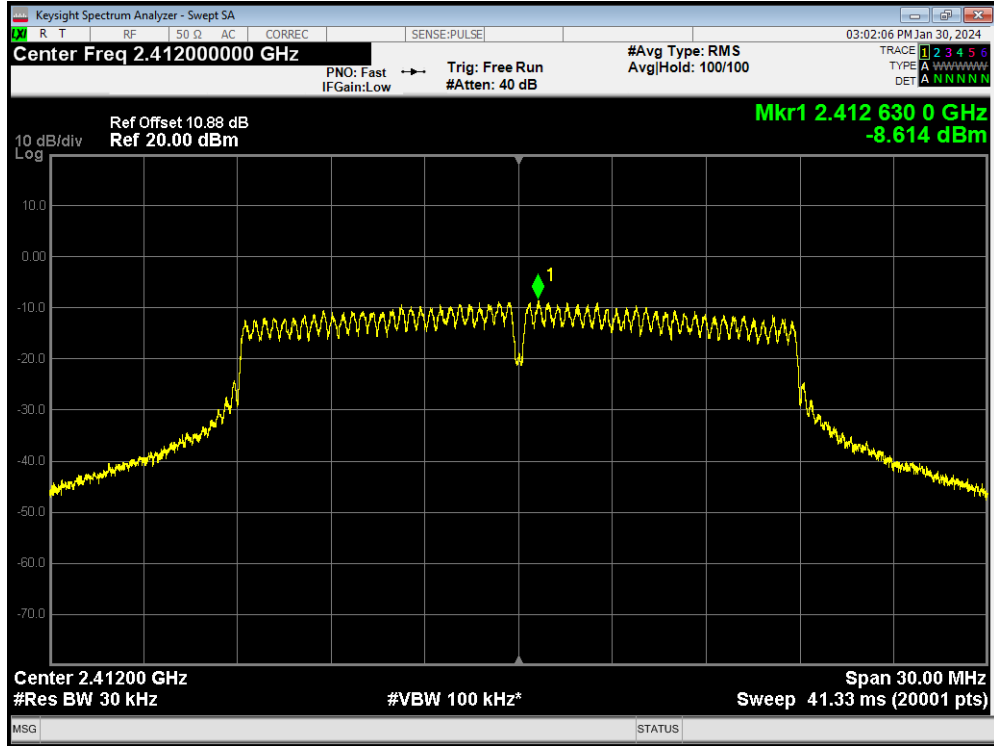

PSD 802.11n(HT20) 2437MHz

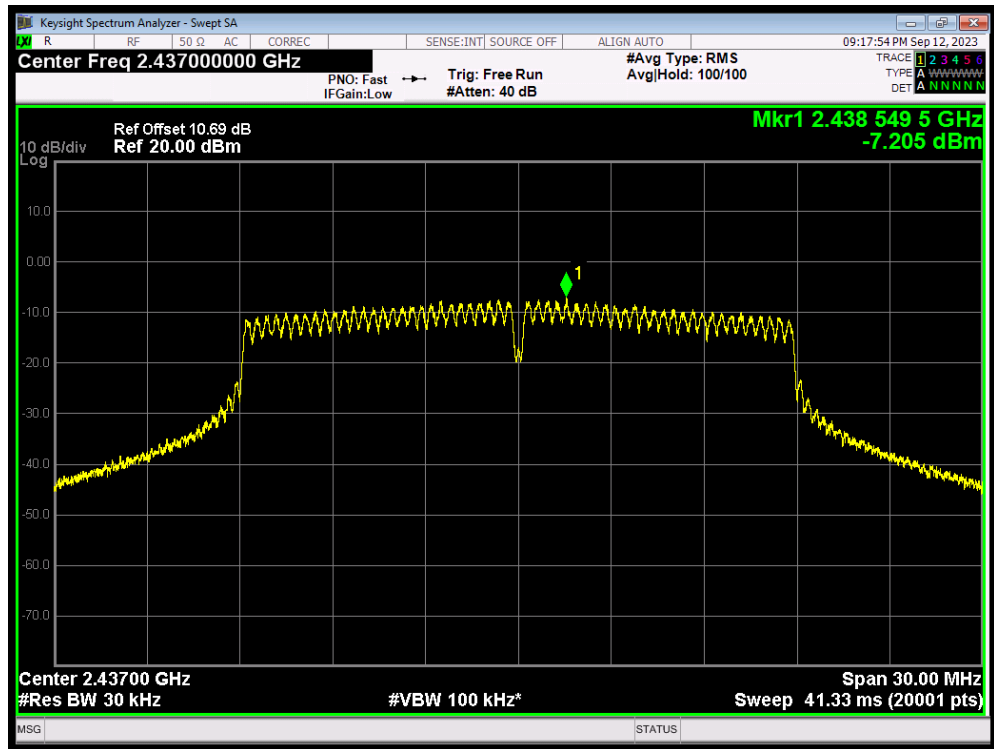

PSD 802.11n(HT20) 2462MHz

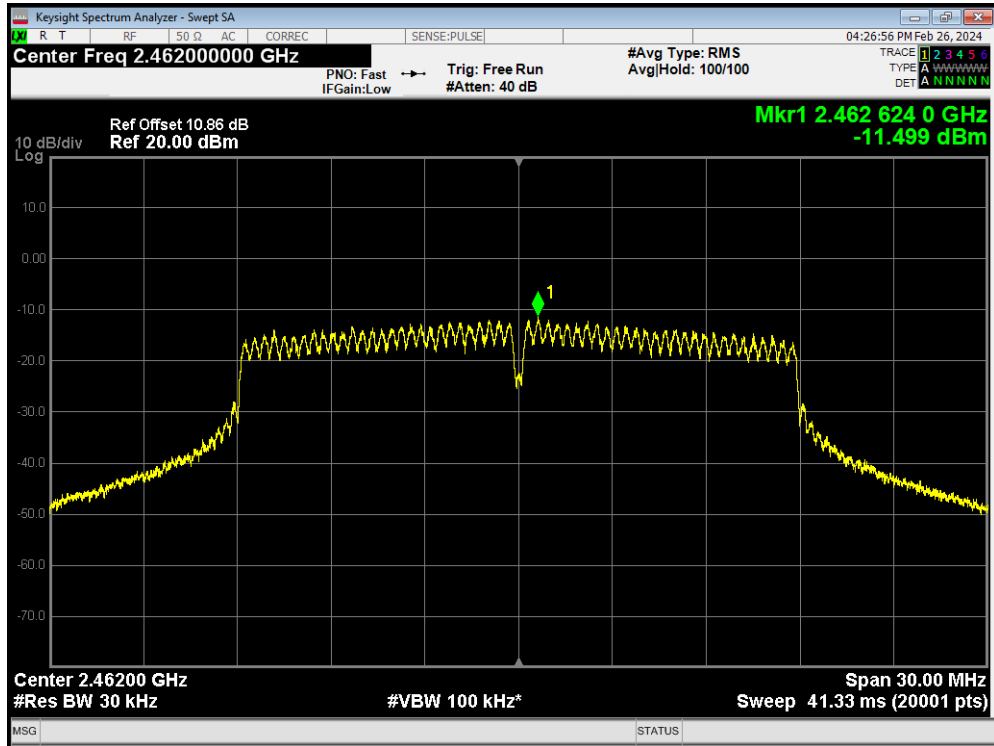

PSD 802.11n(HT40) 2422MHz

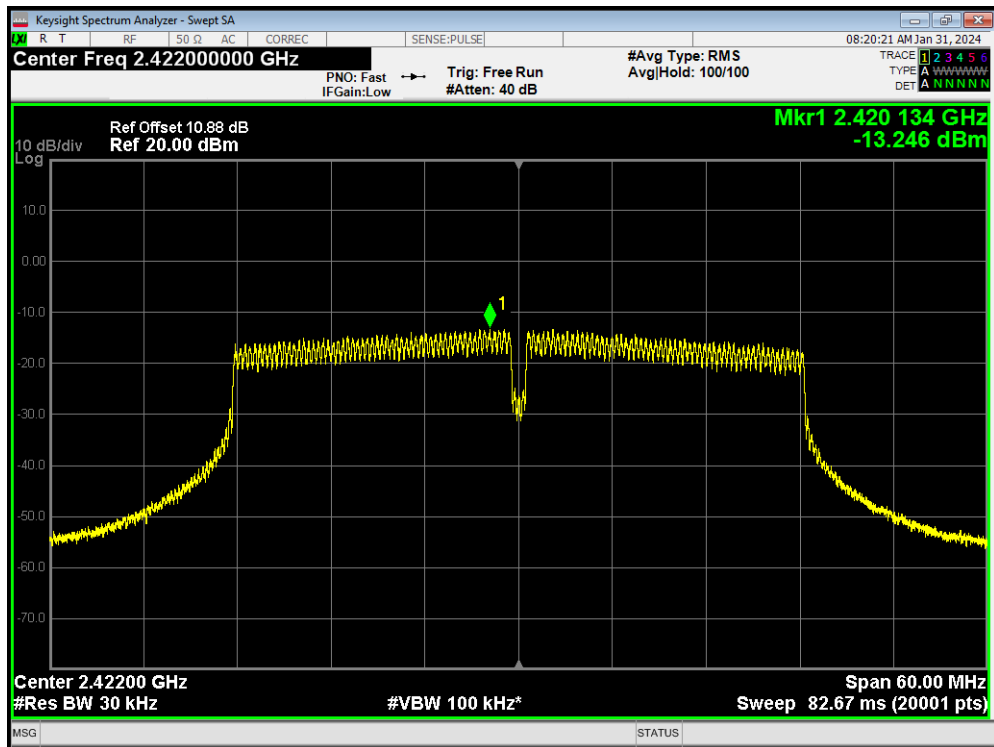

PSD 802.11n(HT40) 2437MHz

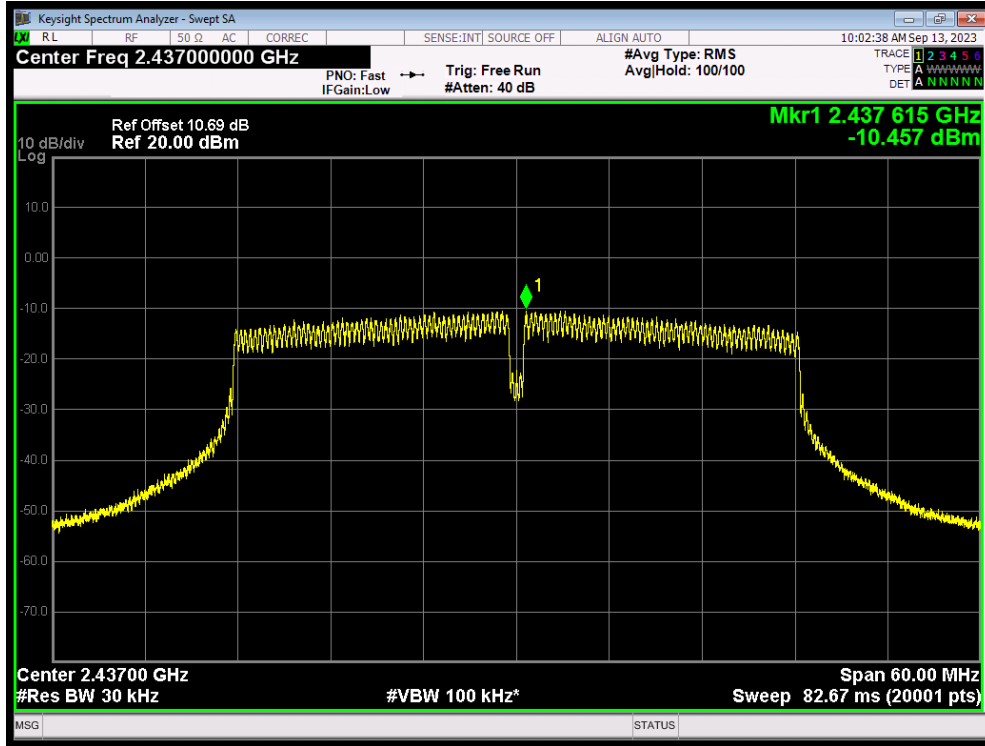

PSD 802.11n(HT40) 2452MHz

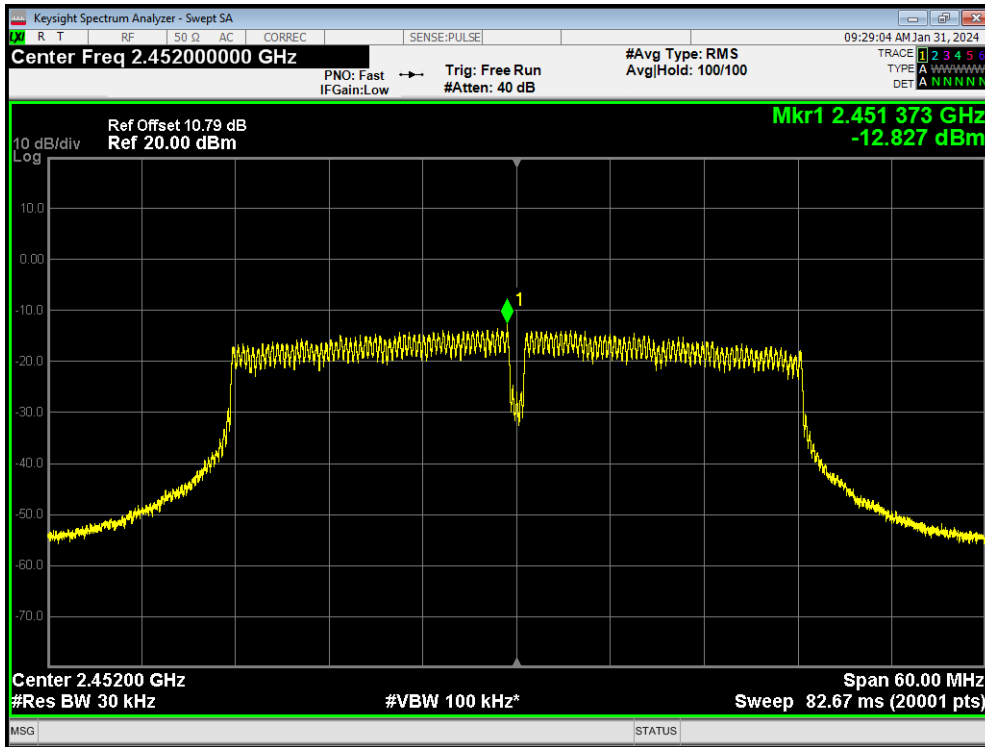

PSD Bluetooth LE(1M) 2402MHz

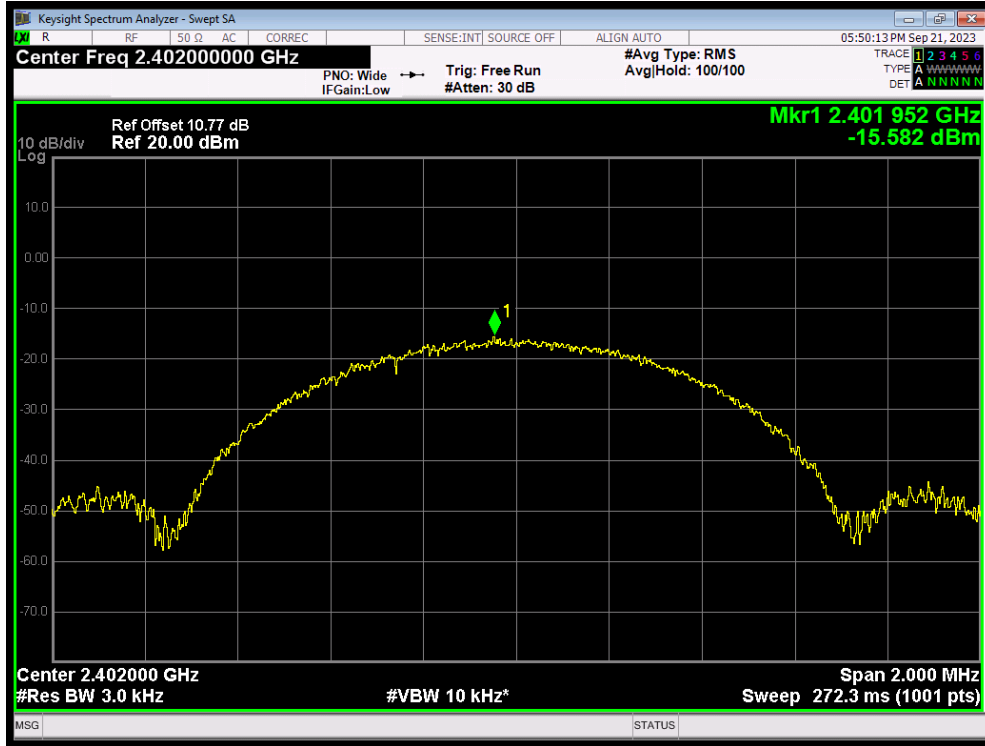

PSD Bluetooth LE(1M) 2440MHz



PSD Bluetooth LE(1M) 2480MHz

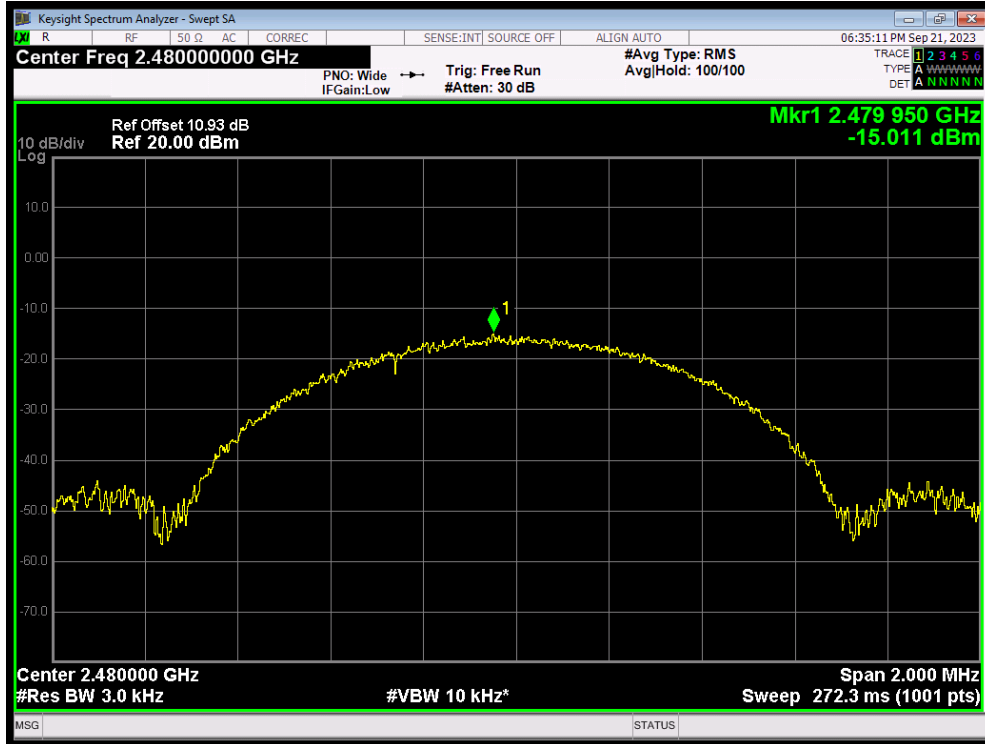

PSD Bluetooth LE(2M) 2402MHz

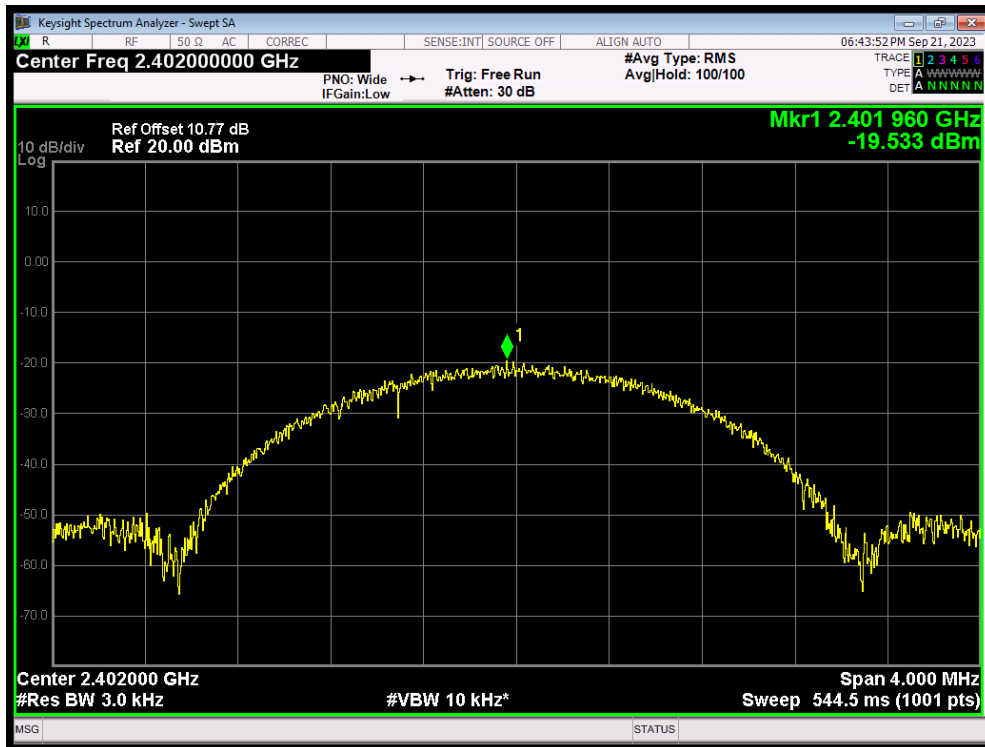

PSD Bluetooth LE(2M) 2440MHz

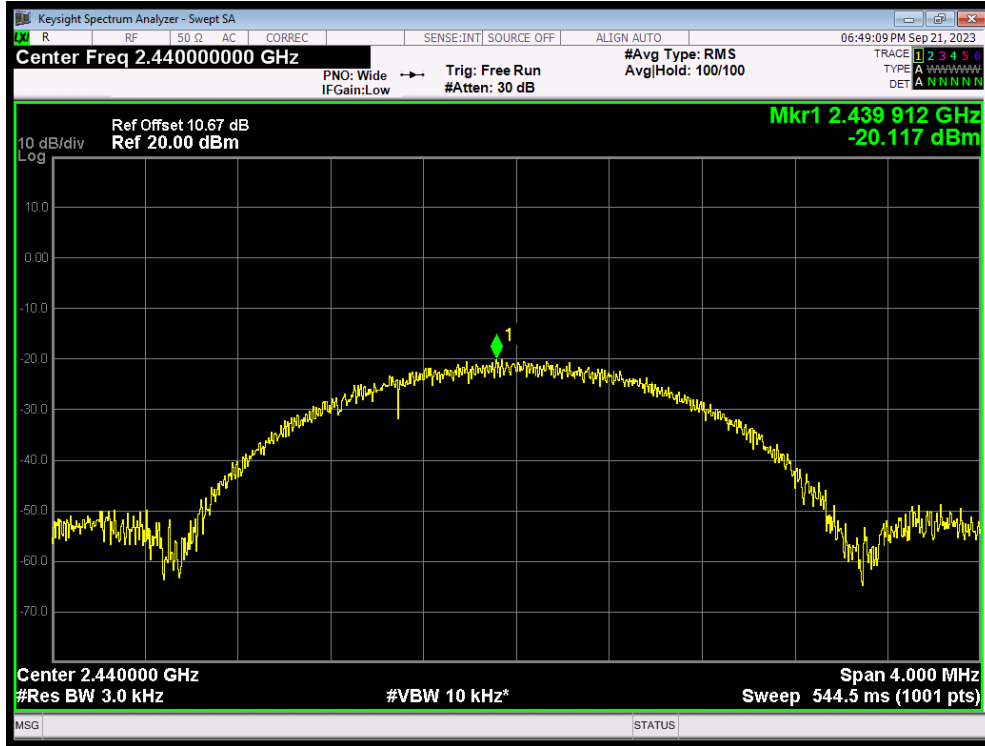

PSD Bluetooth LE(2M) 2480MHz

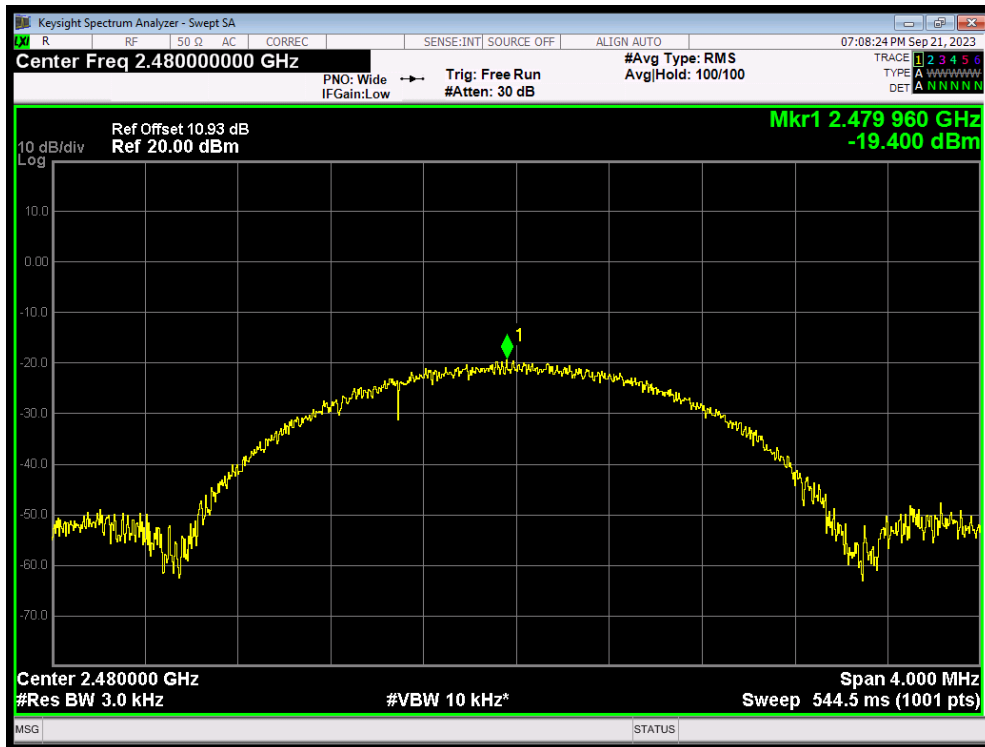



PSD NVNT Bluetooth LE(S=2) 2402MHz

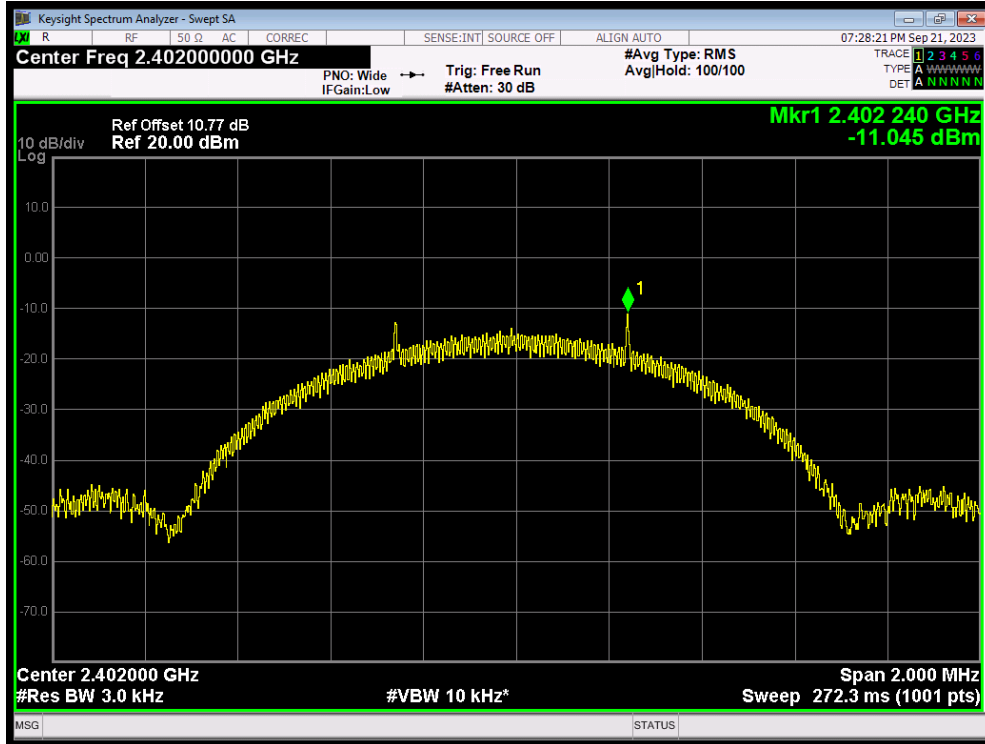

PSD NVNT Bluetooth LE(S=2) 2440MHz

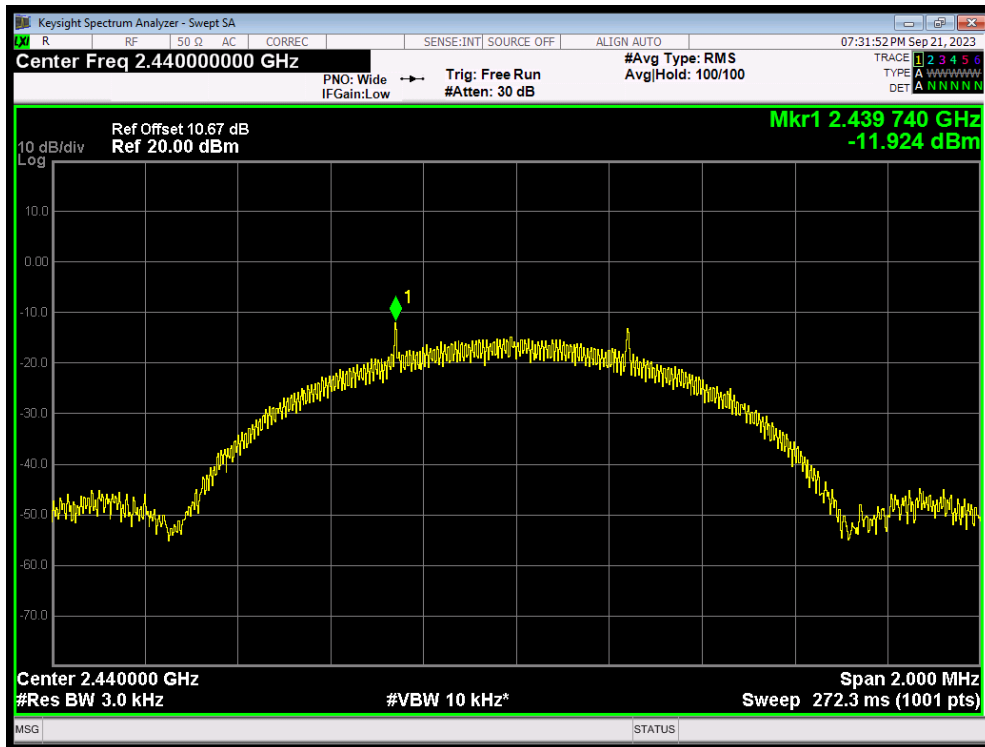

PSD NVNT Bluetooth LE(S=2) 2480MHz

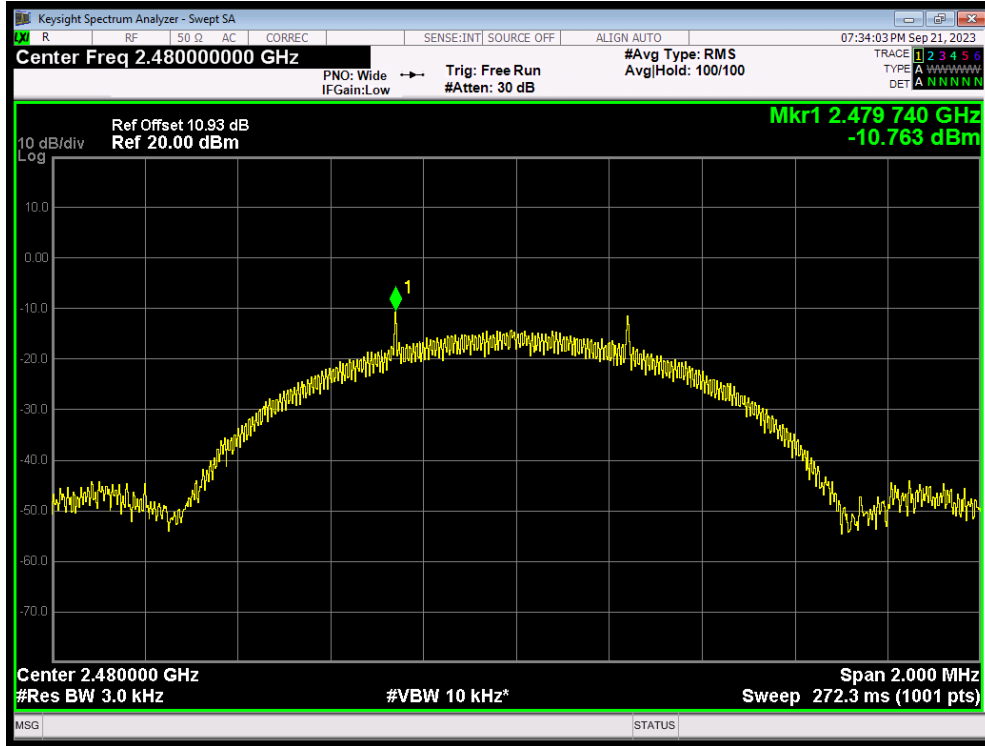

PSD Bluetooth LE(S=8) 2402MHz

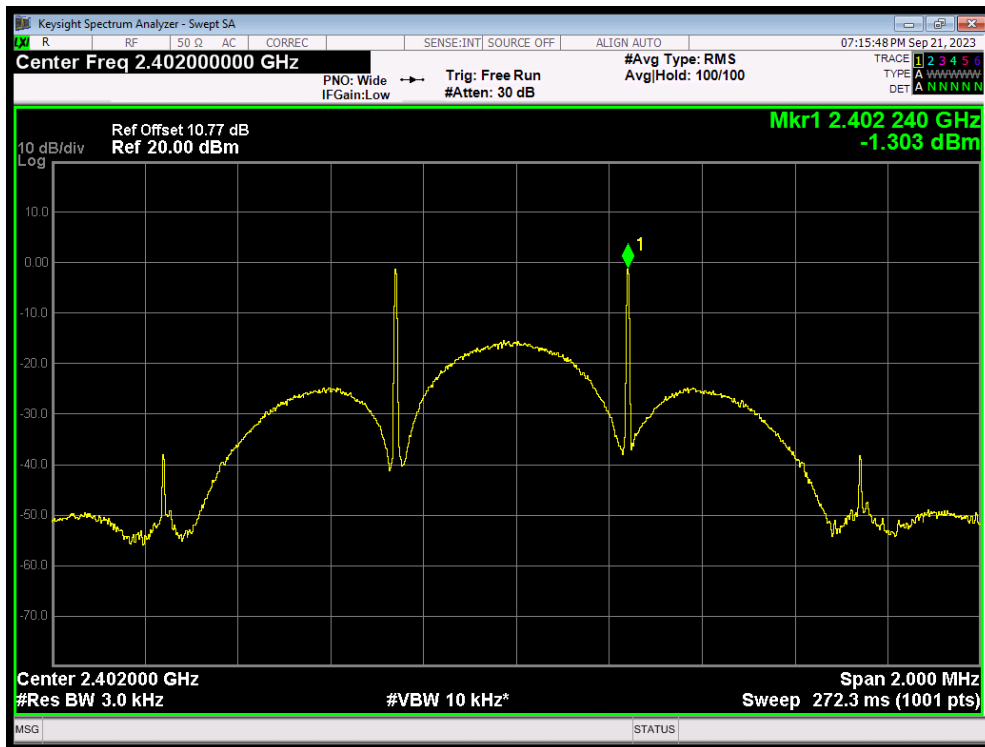

PSD Bluetooth LE(S=8) 2440MHz

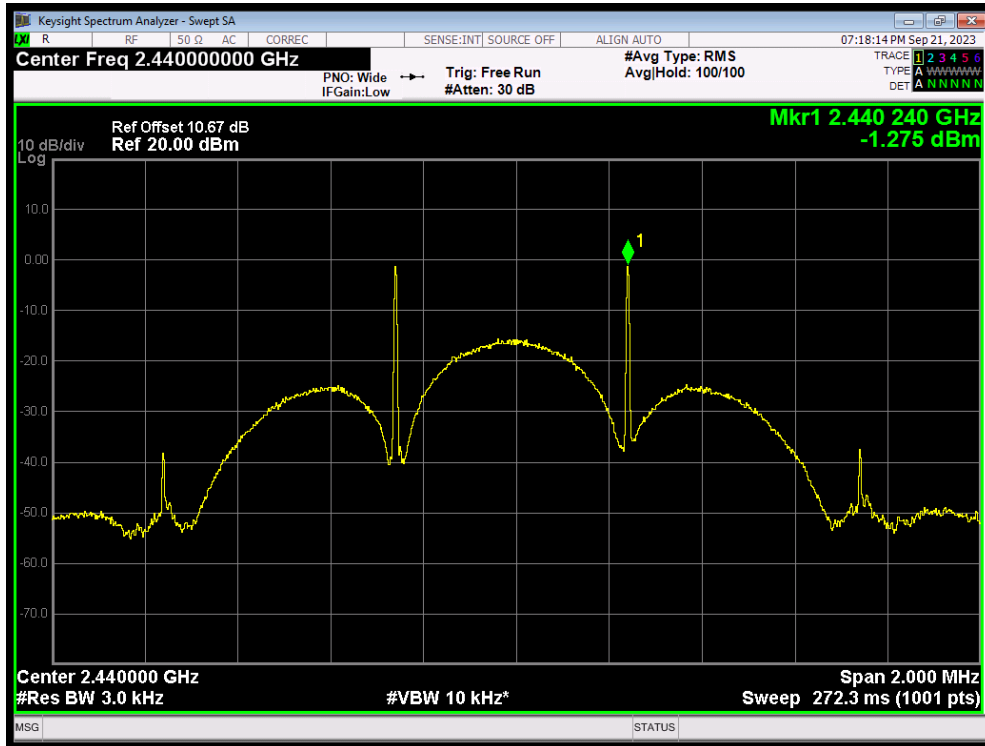

PSD Bluetooth LE(S=8) 2480MHz

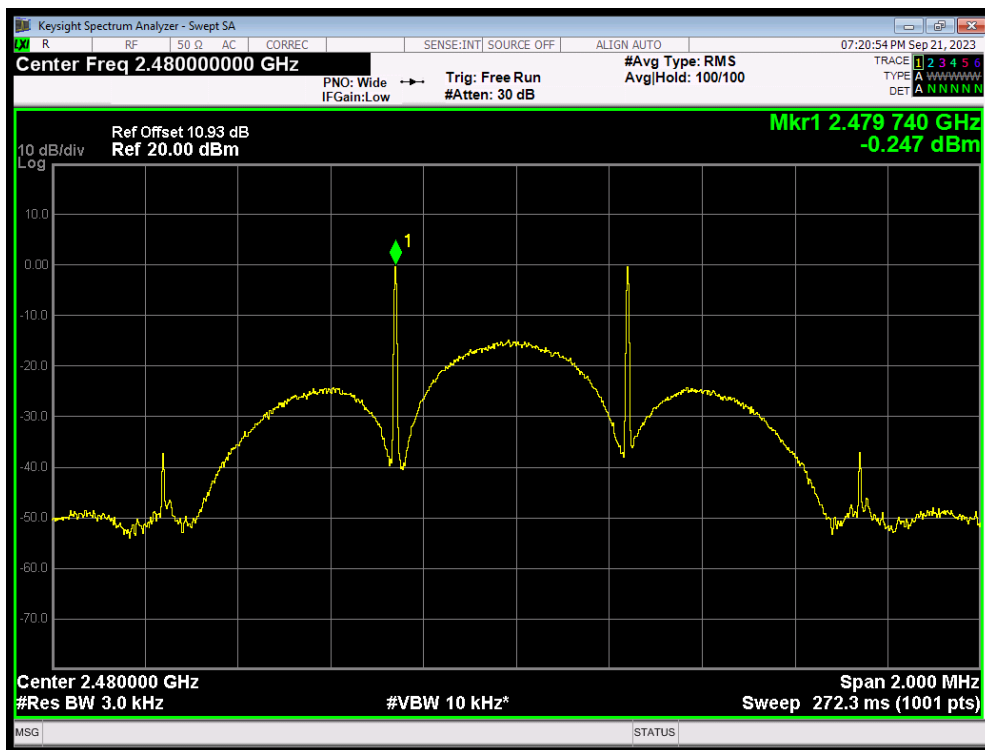

## 5.5. Spurious RF Conducted Emissions

### Ambient Condition

Temperature	Relative humidity
15°C ~ 35°C	20% ~ 80%

### Method of Measurement

The EUT was connected to the spectrum analyzer with a known loss. The spectrum analyzer scans from 30MHz to the 10th harmonic of the carrier. The peak detector is used. Set RBW to 100 kHz and VBW to 300 kHz, Sweep is set to AUTO.

The test is in transmitting mode.

### Test Setup



### Limits

Rule Part 15.247(d) specifies that “In any 100 kHz bandwidth outside the frequency band in which the spread spectrum or digitally modulated intentional radiator is operating, the radio frequency power that is produced by the intentional radiator shall be at least 20 dB below that in the 100 kHz bandwidth within the band that contains the highest level of the desired power, based on either an RF conducted or a radiated measurement, provided the transmitter demonstrates compliance with the peak conducted power limits. If the transmitter complies with the conducted power limits based on the use of RMS averaging over a time interval, as permitted under paragraph (b)(3) of this section, the attenuation required under this paragraph shall be 30 dB instead of 20 dB.”

Test Mode	Carrier frequency (MHz)	Reference value (dBm)	Limit
802.11b	2412	10.040	-19.96
	2437	10.600	-19.40
	2462	8.130	-21.87
802.11g	2412	5.530	-24.47
	2437	6.590	-23.41
	2462	4.000	-26.00
802.11n HT20	2412	4.610	-25.39
	2437	5.810	-24.19
	2462	1.620	-28.38
802.11n HT40	2422	1.170	-28.83
	2437	3.730	-26.27
	2452	-1.170	-31.17
802.11ax HE20	2412	2.870	-27.13
	2437	3.610	-26.39
	2462	2.620	-27.38
802.11ax HE40	2422	-0.040	-30.04
	2437	2.870	-27.13
	2452	0.450	-29.55
Bluetooth (Low Energy) (1M)	2402	6.180	-23.82
	2440	5.160	-24.84
	2480	6.670	-23.33
Bluetooth (Low Energy) (2M)	2402	5.030	-24.97
	2440	4.630	-25.37
	2480	5.530	-24.47
Bluetooth (Low Energy) (S=2)	2402	5.820	-24.18
	2440	5.950	-24.05
	2480	6.660	-23.34
Bluetooth (Low Energy) (S=8)	2402	3.240	-26.76
	2440	3.050	-26.95
	2480	3.800	-26.20

### Measurement Uncertainty

The assessed measurement uncertainty to ensure 95% confidence level for the normal distribution is with the coverage factor  $k = 1.96$ .

Frequency	Uncertainty
100kHz-2GHz	0.684 dB
2GHz-26GHz	1.407 dB

Test Results:

Tx. Spurious 802.11ax(HE20) 2412MHz Ref

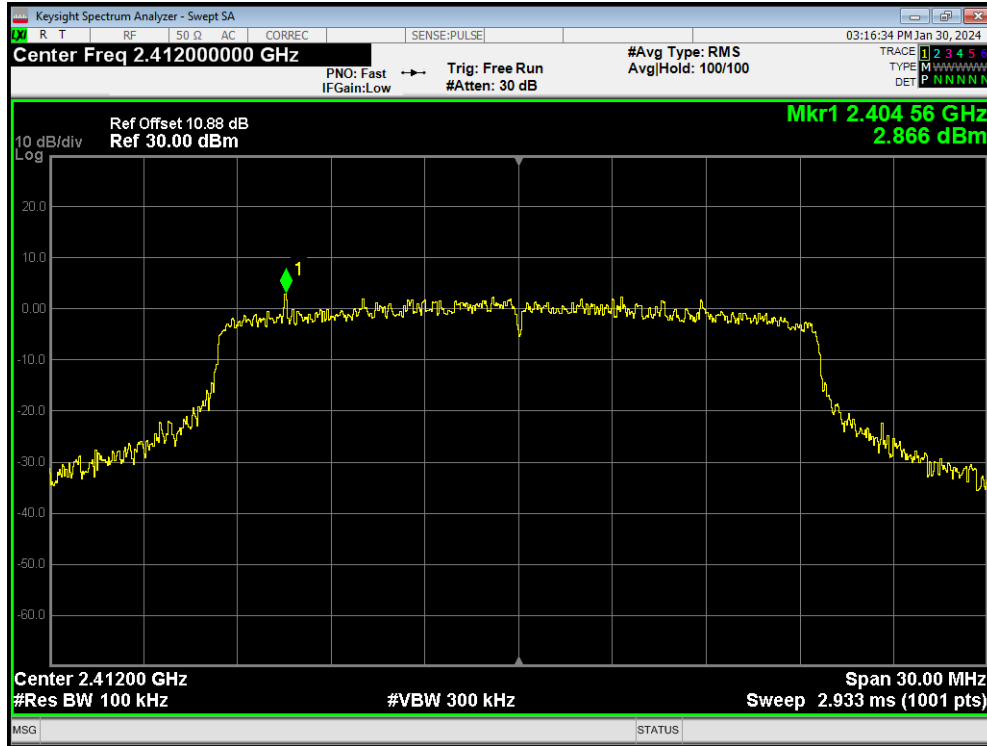

Tx. Spurious 802.11ax(HE20) 2412MHz Emission

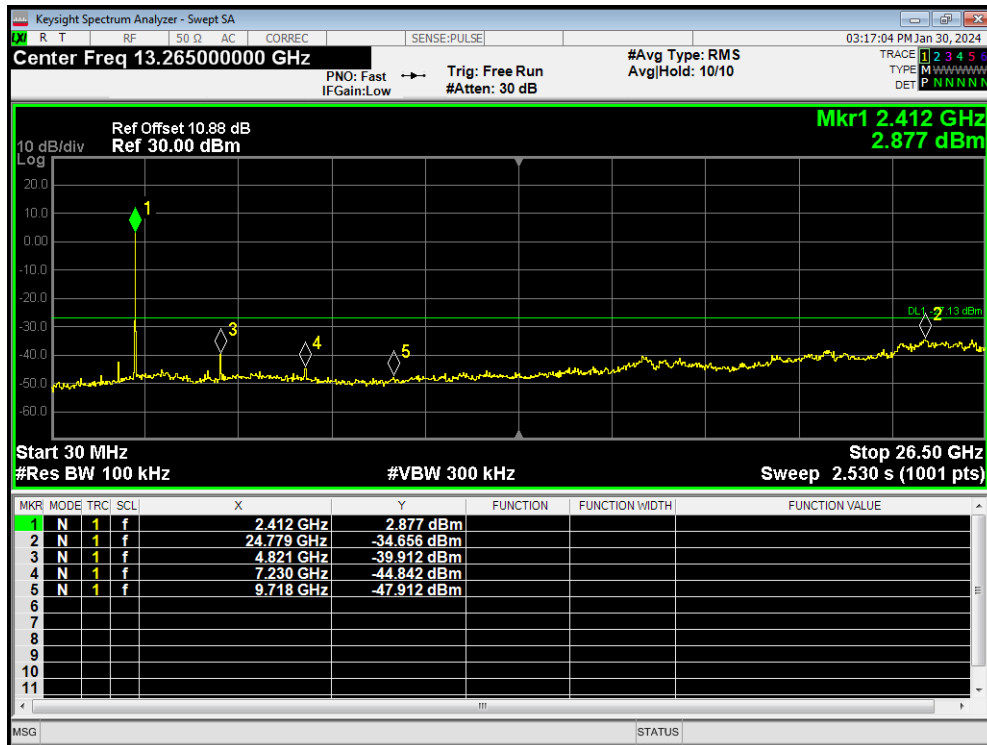

Tx. Spurious 802.11ax(HE20) 2437MHz Ref

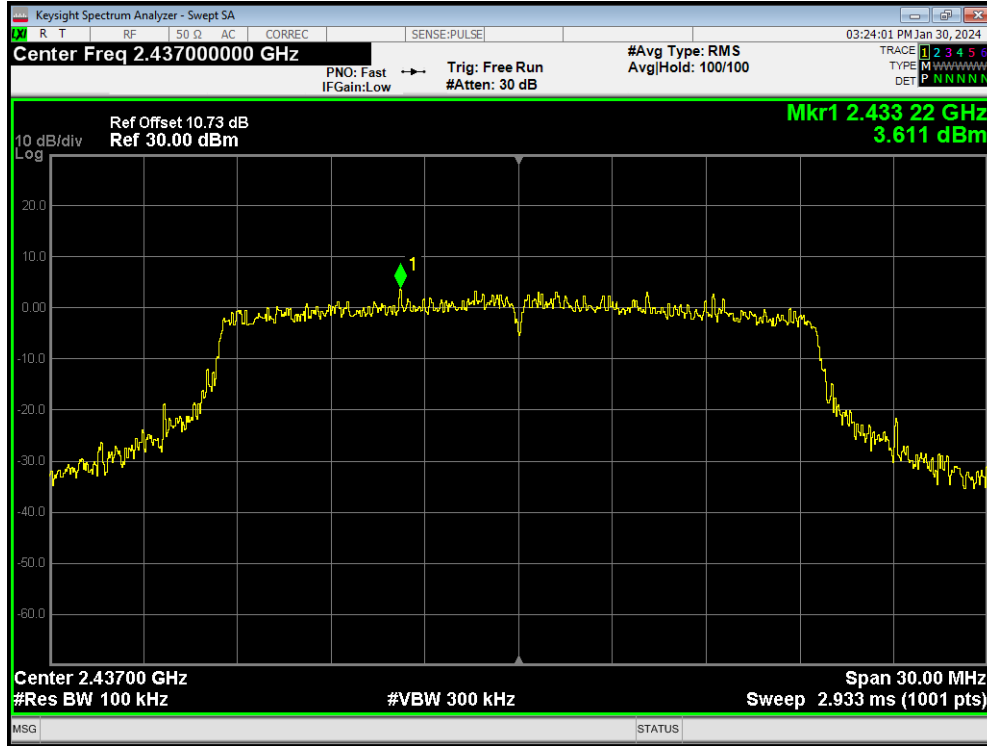

Tx. Spurious 802.11ax(HE20) 2437MHz Emission

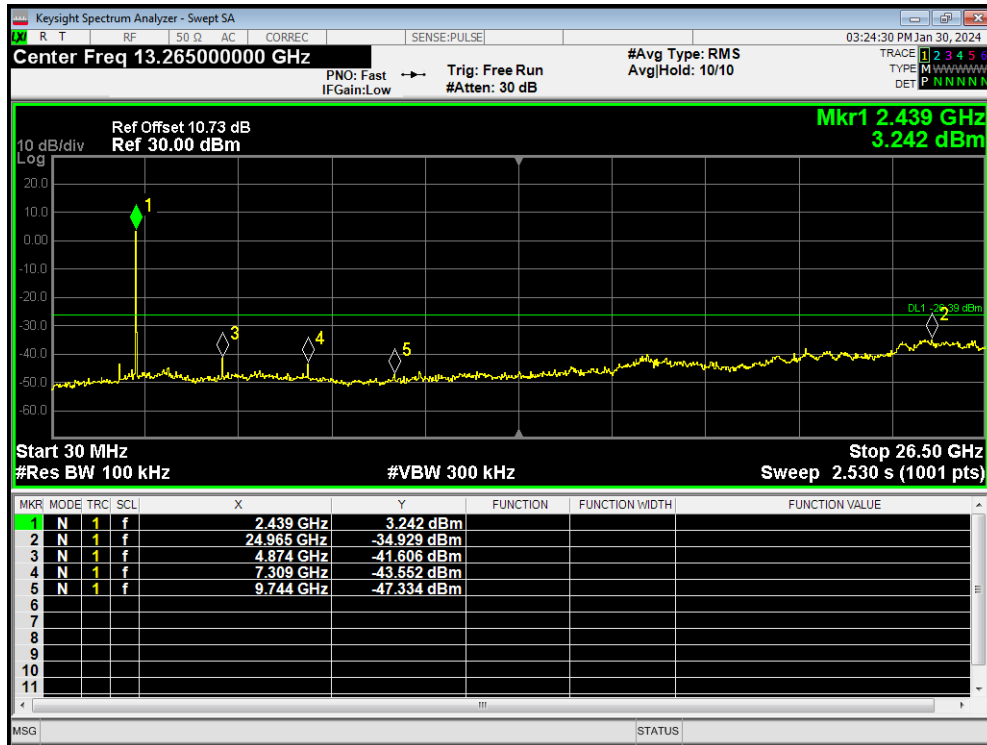

Tx. Spurious 802.11ax(HE20) 2462MHz Ref

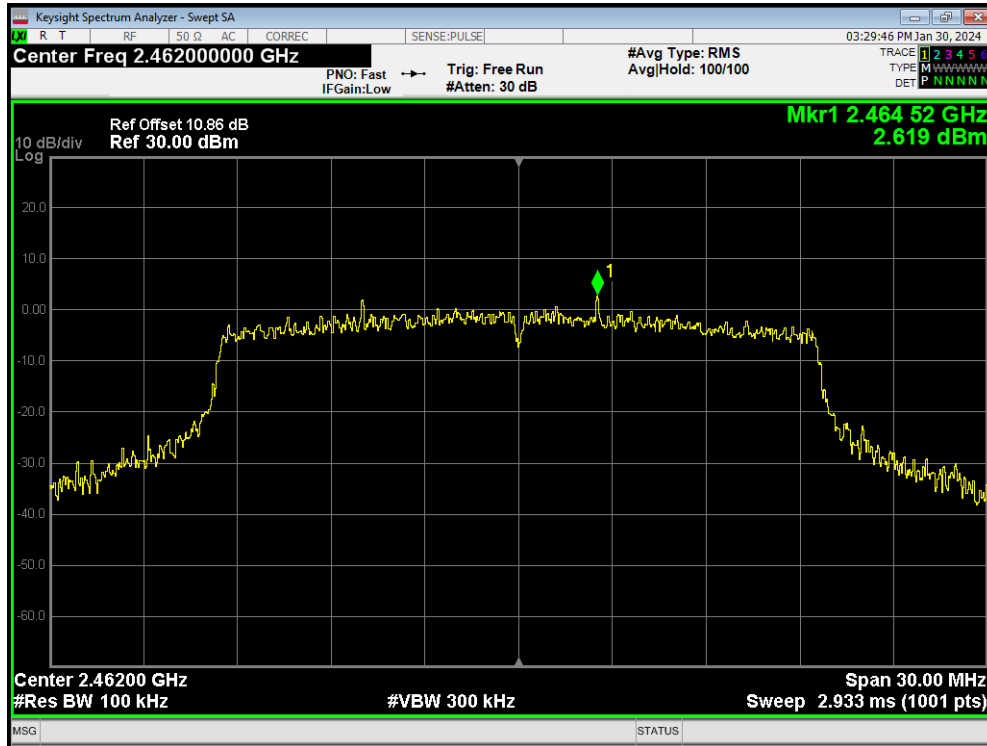

Tx. Spurious 802.11ax(HE20) 2462MHz Emission

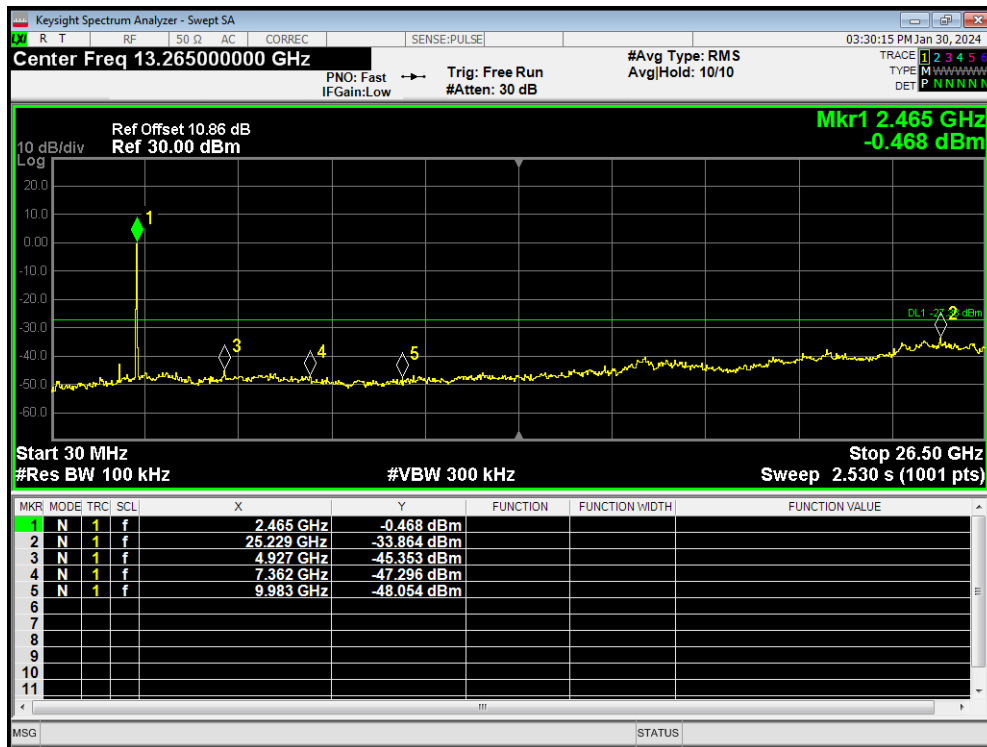



Tx. Spurious 802.11ax(HE40) 2422MHz Ref

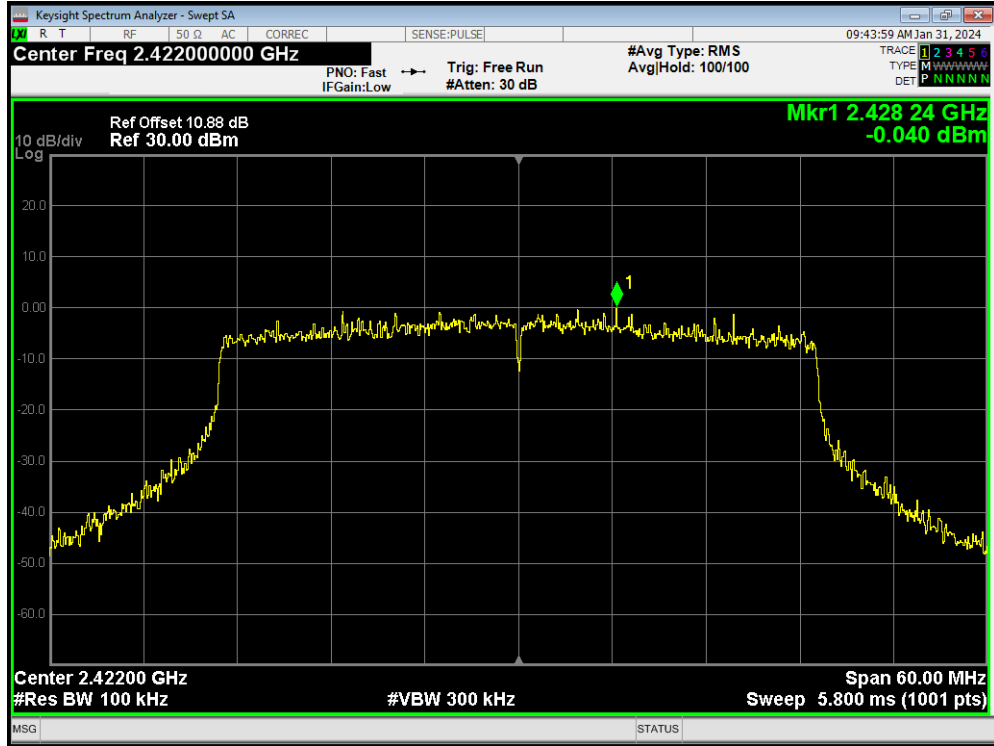

Tx. Spurious 802.11ax(HE40) 2422MHz Emission

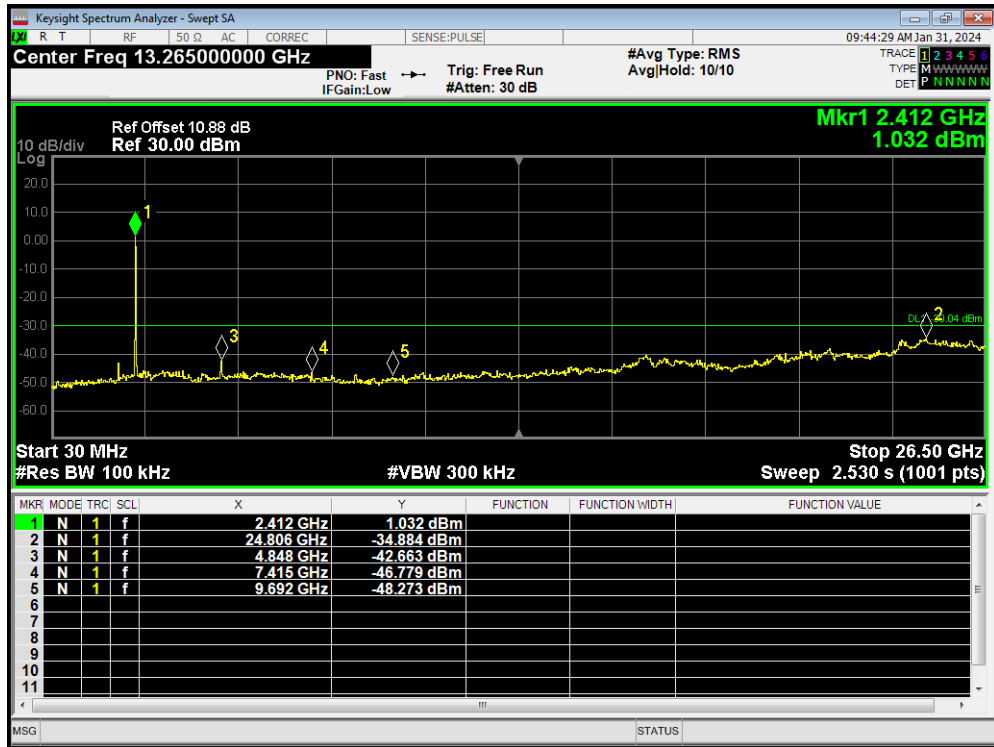

Tx. Spurious 802.11ax(HE40) 2437MHz Ref

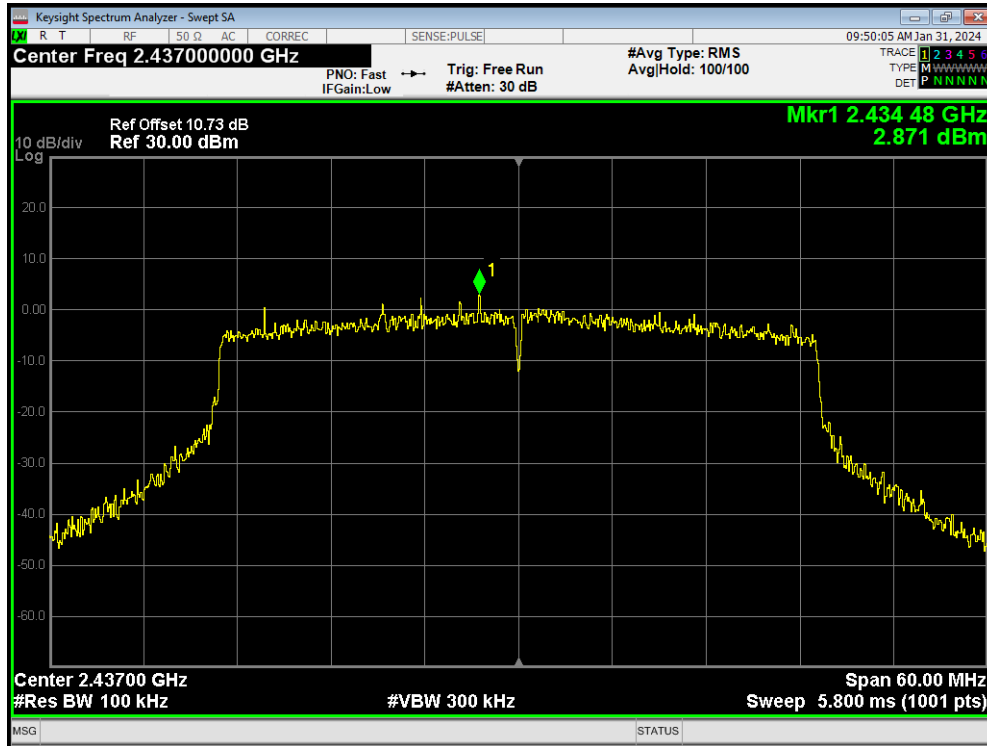

Tx. Spurious 802.11ax(HE40) 2437MHz Emission

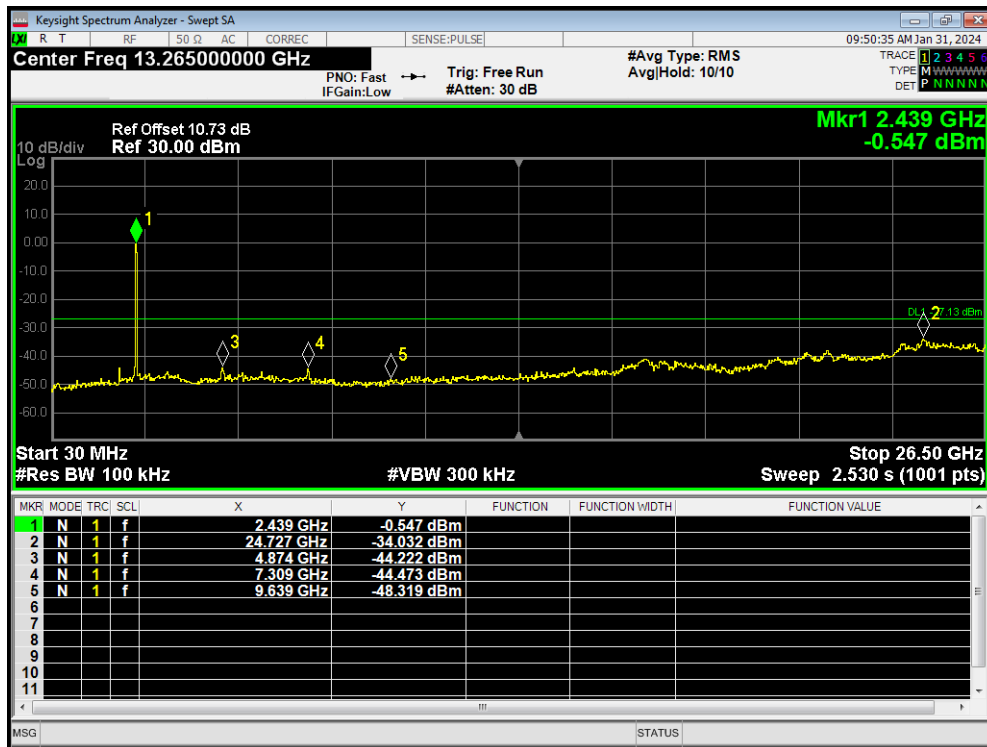

Tx. Spurious 802.11ax(HE40) 2452MHz Ref

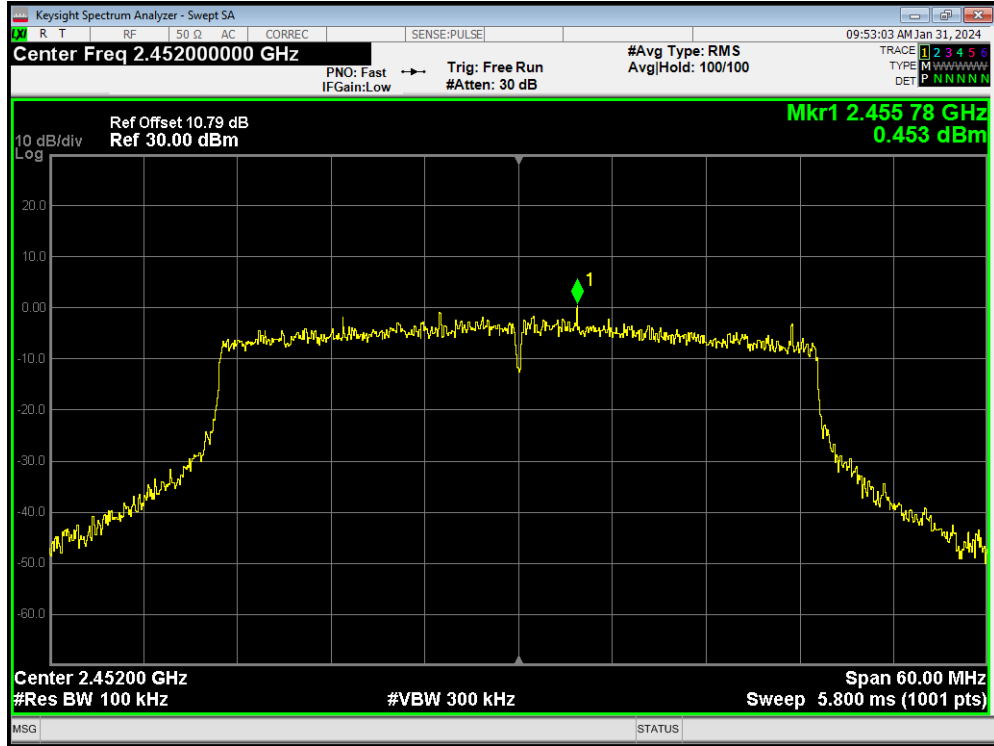

Tx. Spurious 802.11ax(HE40) 2452MHz Emission

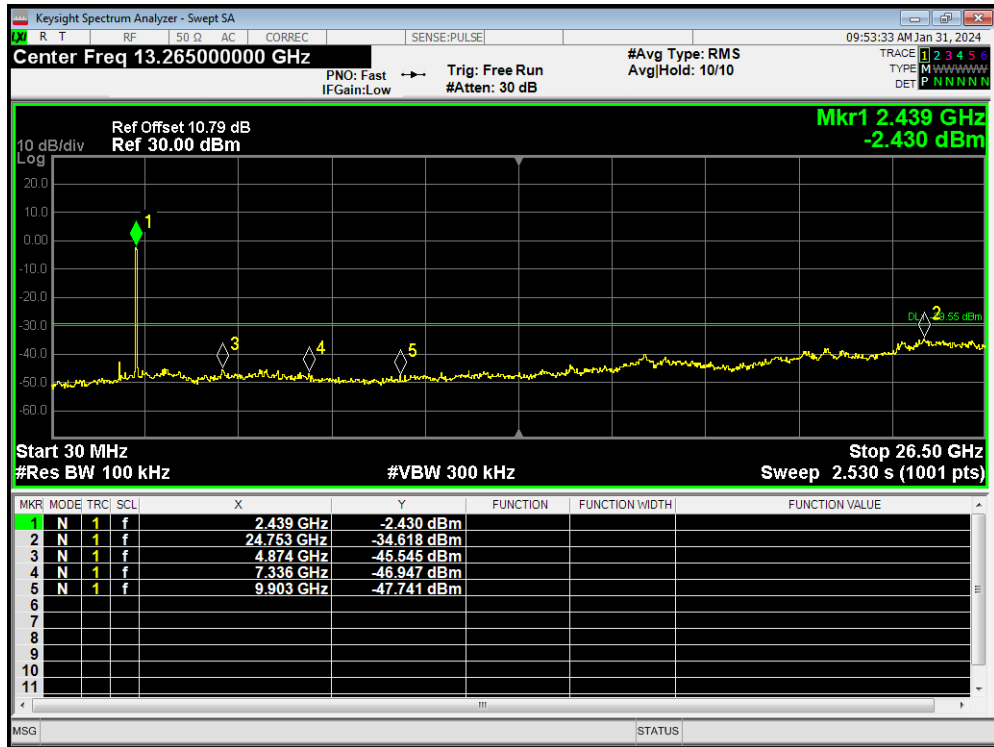

Tx. Spurious 802.11b 2412MHz Ref

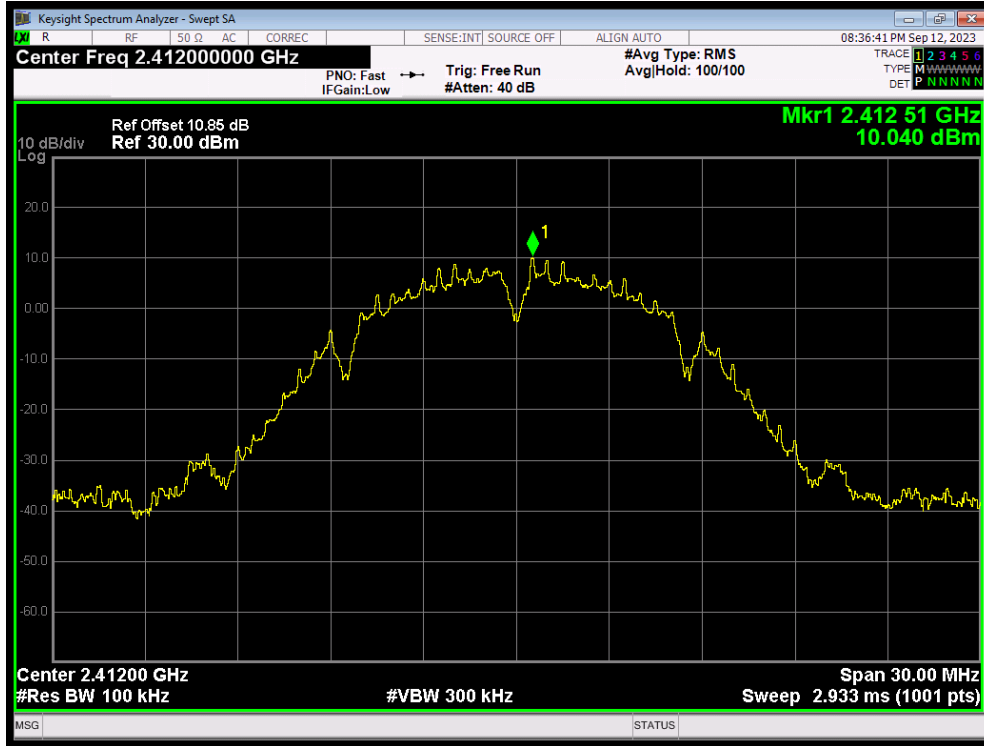

Tx. Spurious 802.11b 2412MHz Emission

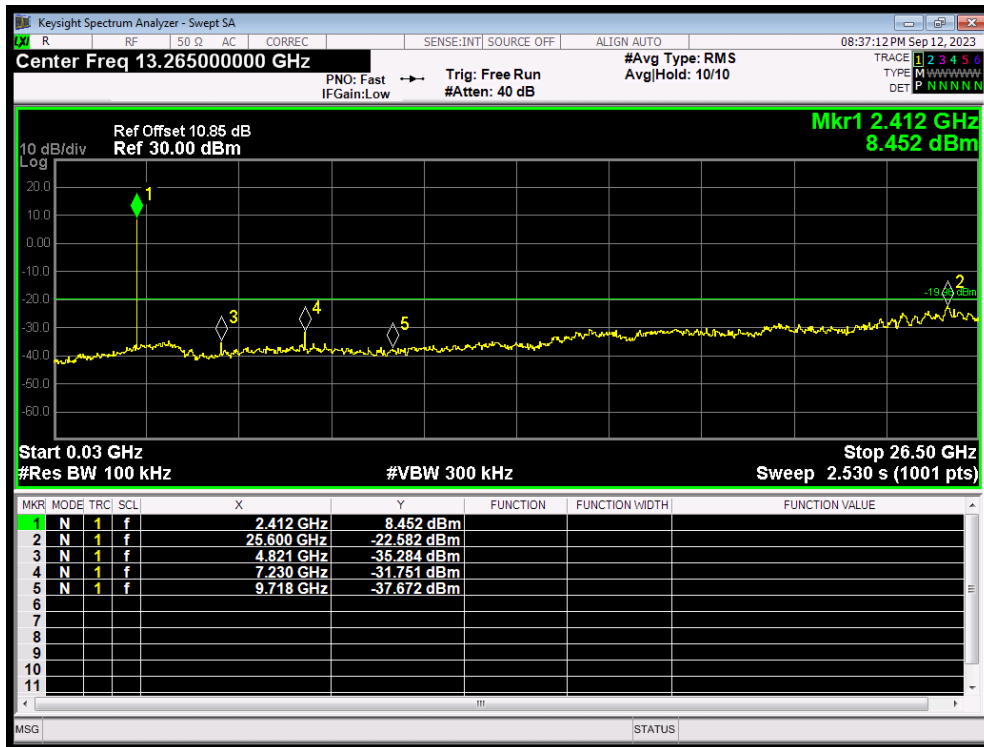

Tx. Spurious 802.11b 2437MHz Ref

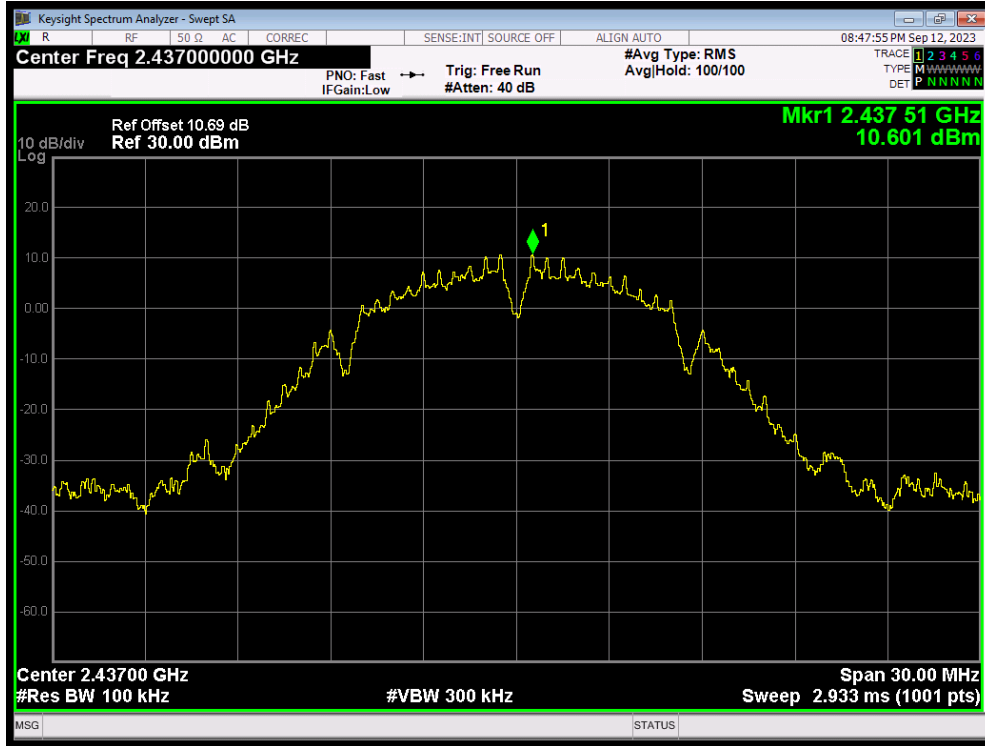

Tx. Spurious 802.11b 2437MHz Emission

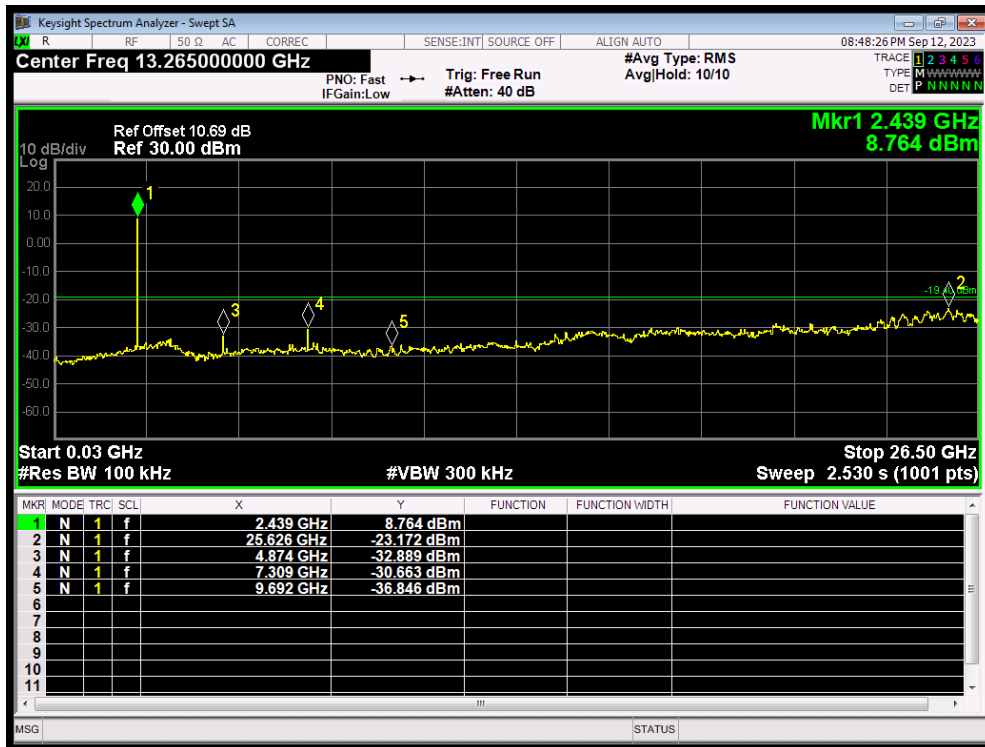

Tx. Spurious 802.11b 2462MHz Ref

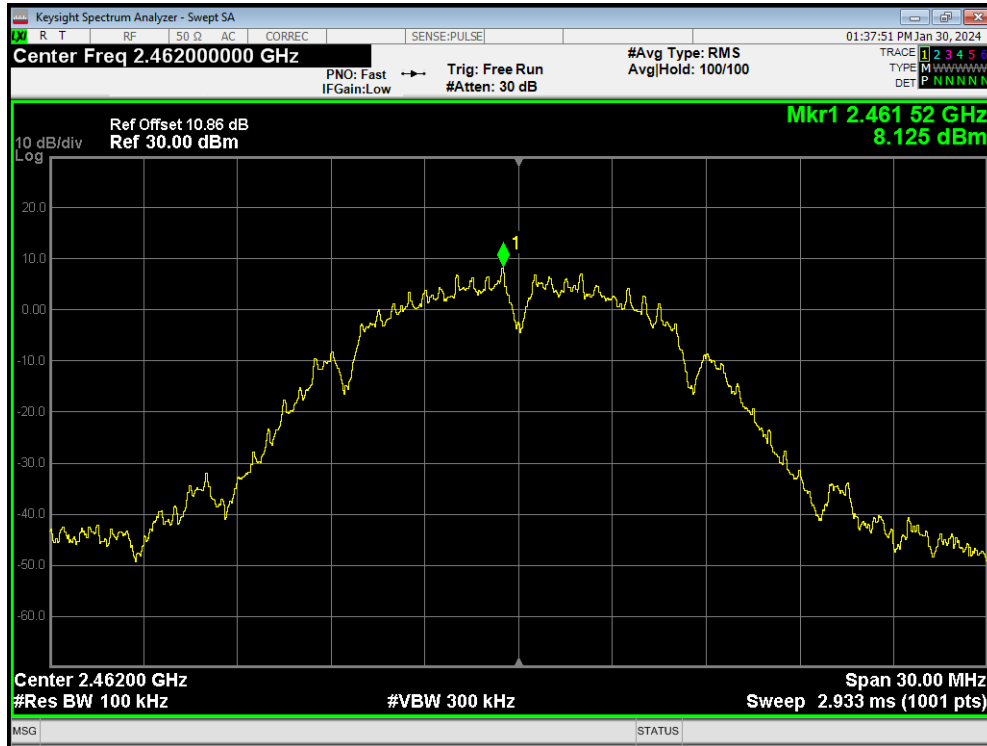

Tx. Spurious 802.11b 2462MHz Emission

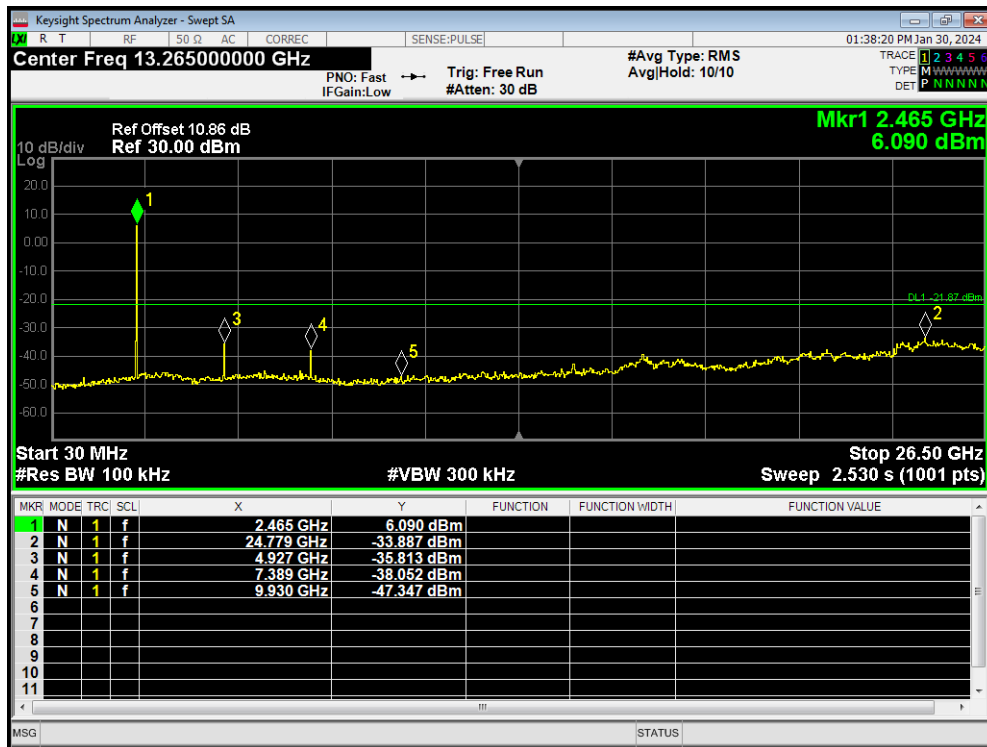

Tx. Spurious 802.11g 2412MHz Ref

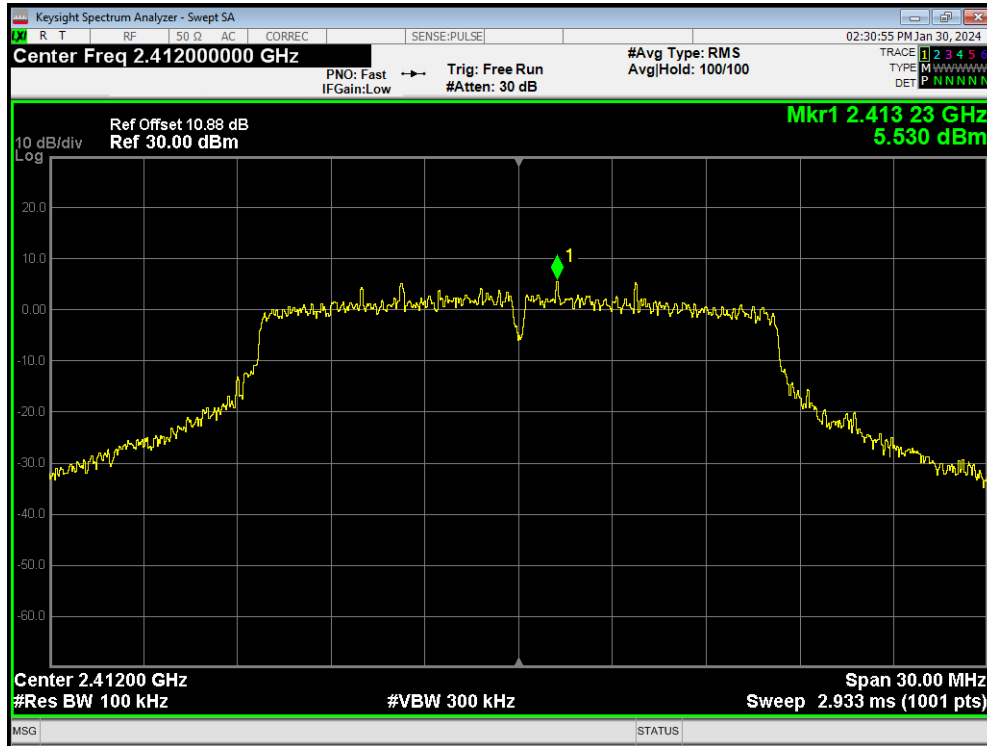

Tx. Spurious 802.11g 2412MHz Emission

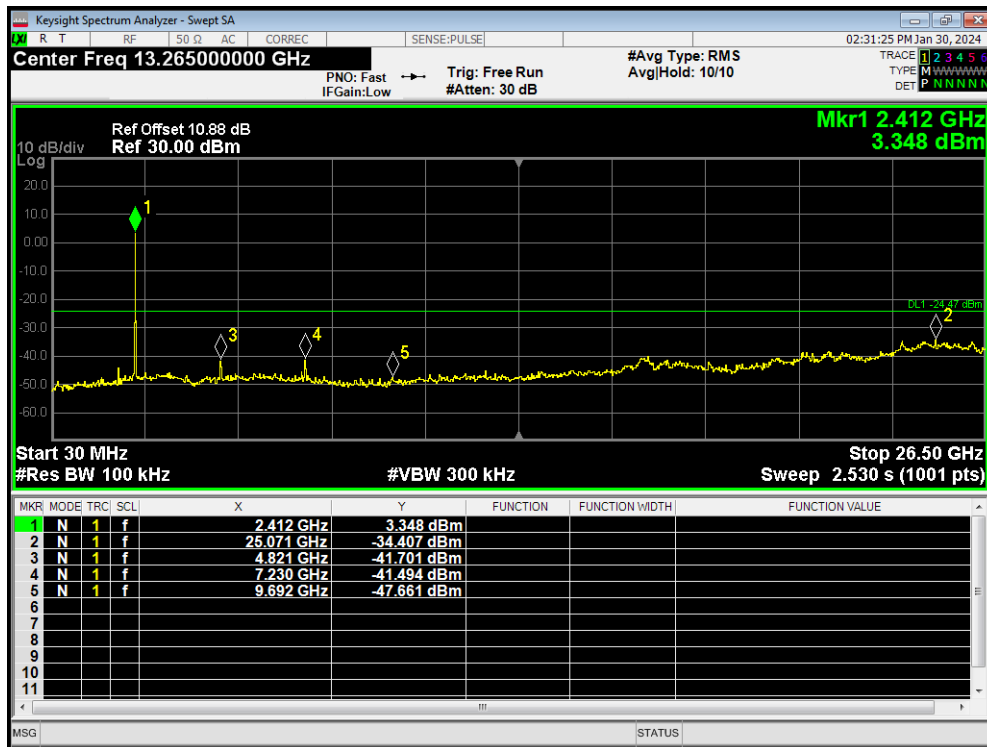

Tx. Spurious 802.11g 2437MHz Ref

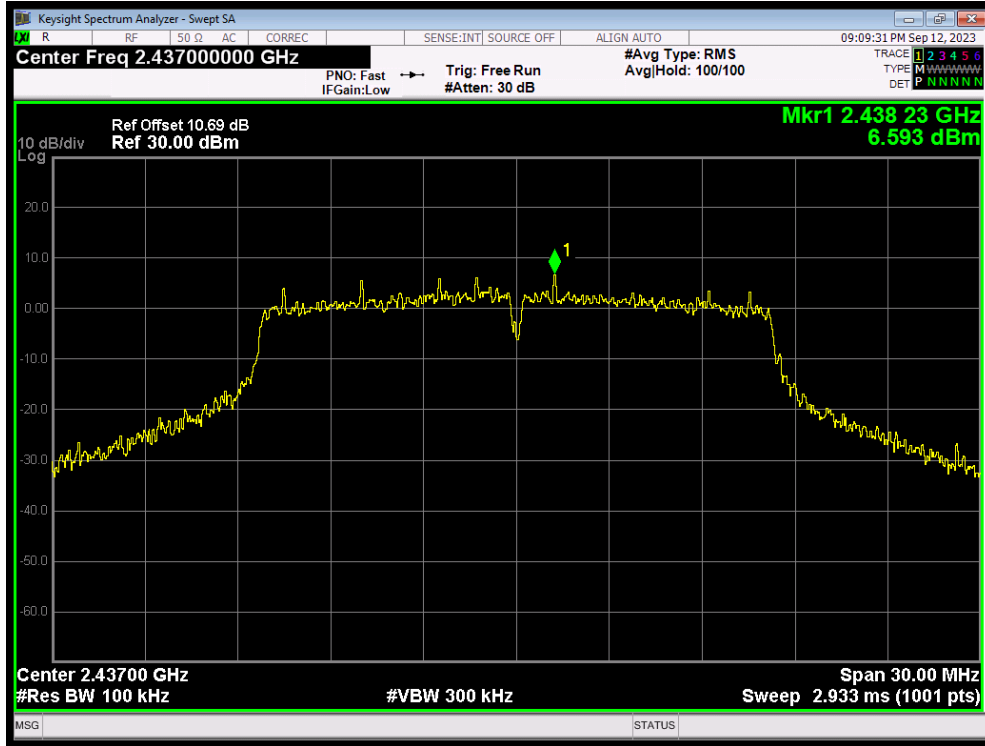

Tx. Spurious 802.11g 2437MHz Emission

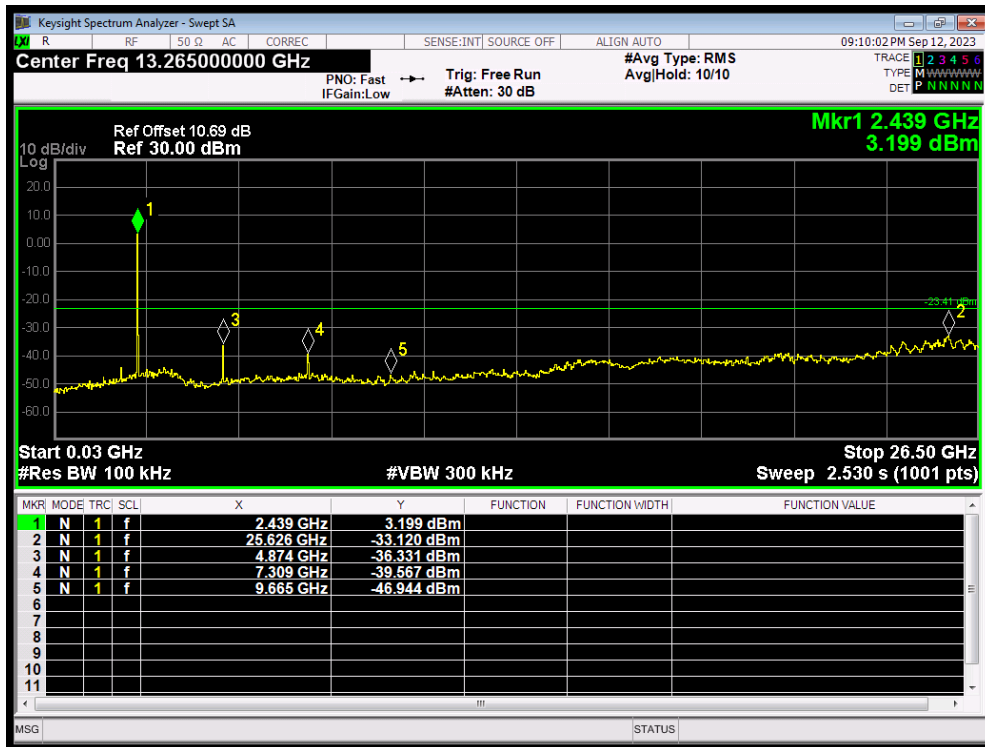



Tx. Spurious 802.11g 2462MHz Ref

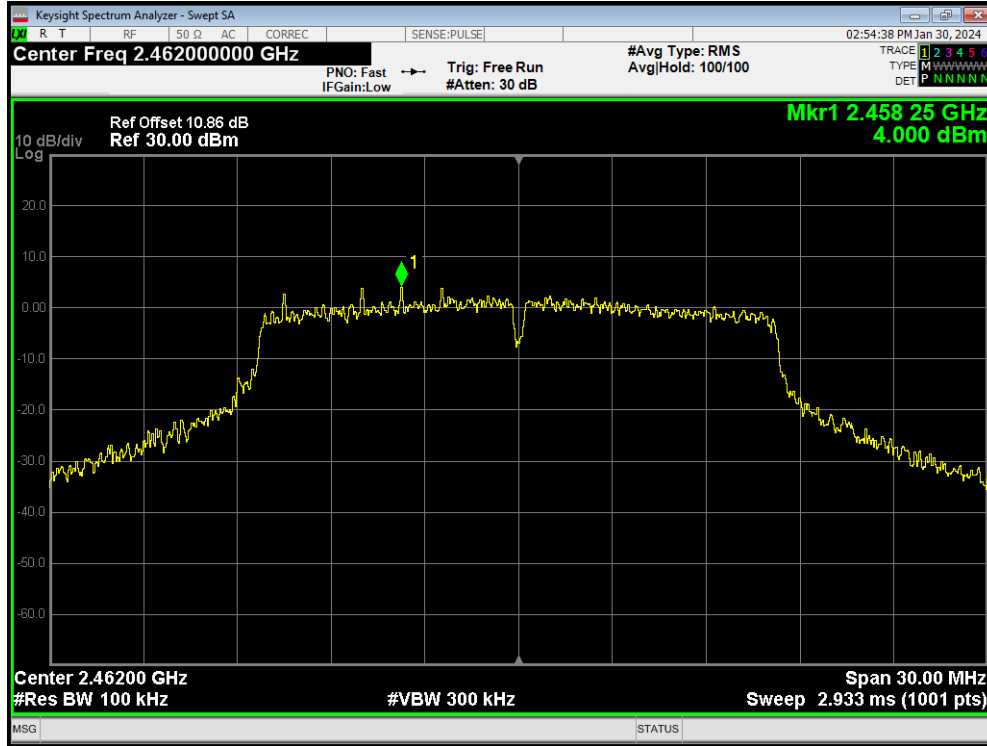

Tx. Spurious 802.11g 2462MHz Emission

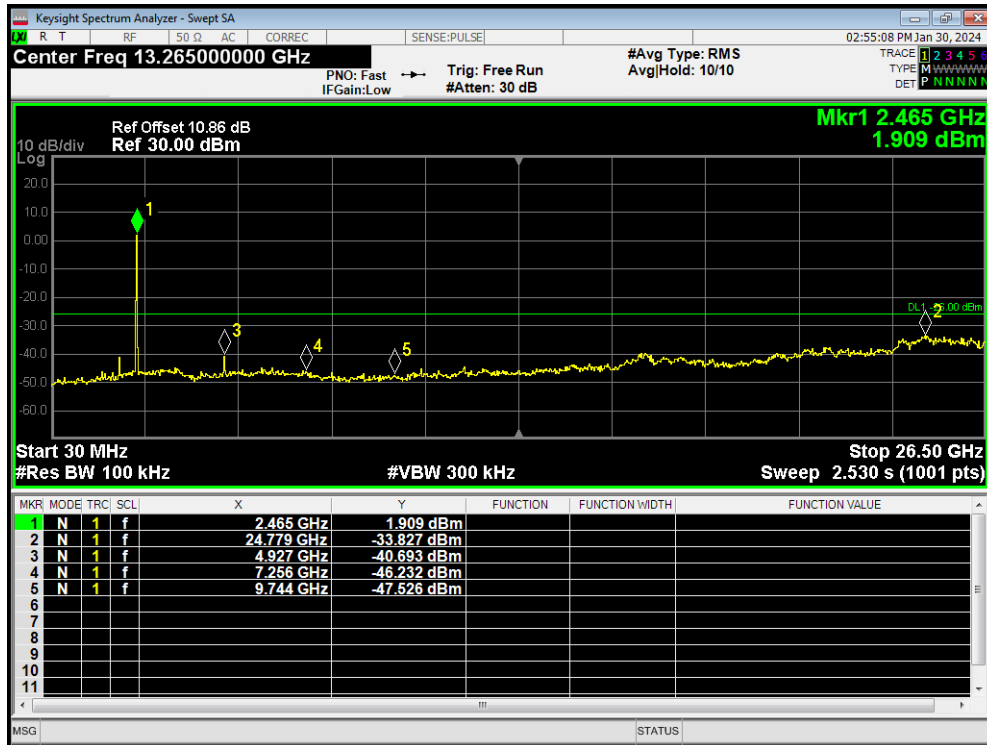

Tx. Spurious 802.11n(HT20) 2412MHz Ref

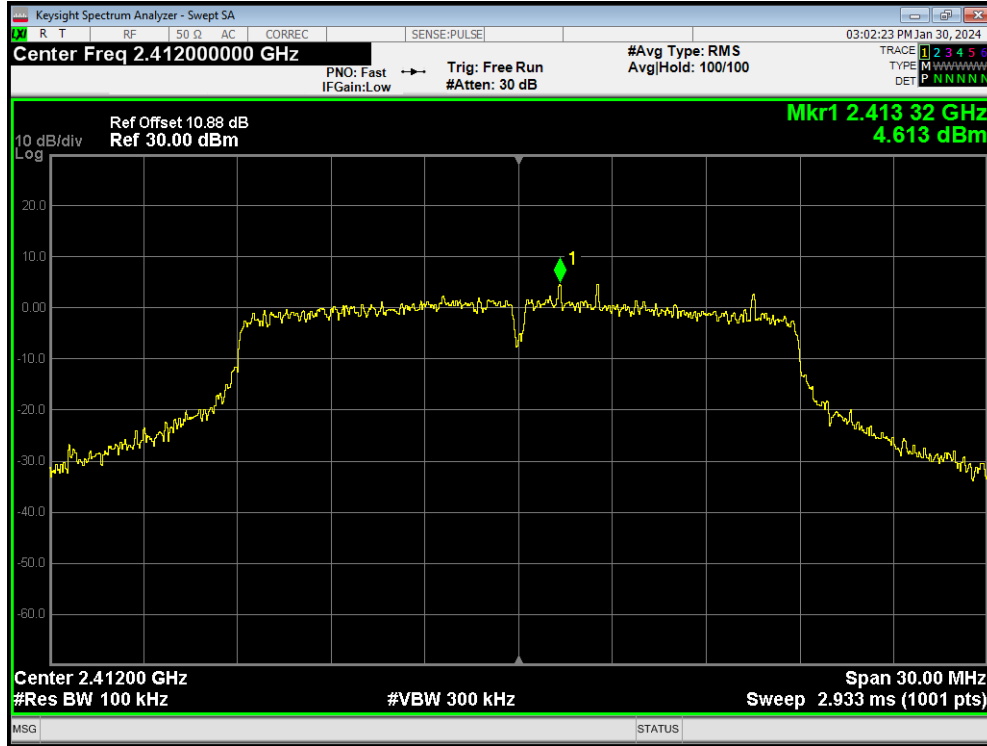

Tx. Spurious 802.11n(HT20) 2412MHz Emission

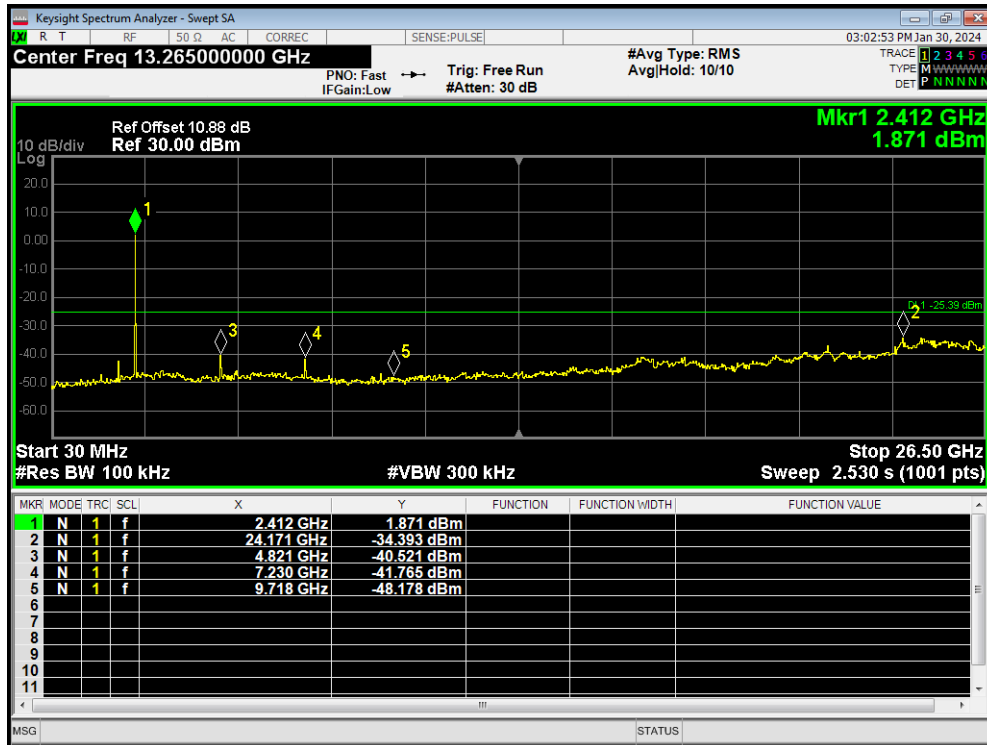

Tx. Spurious 802.11n(HT20) 2437MHz Ref

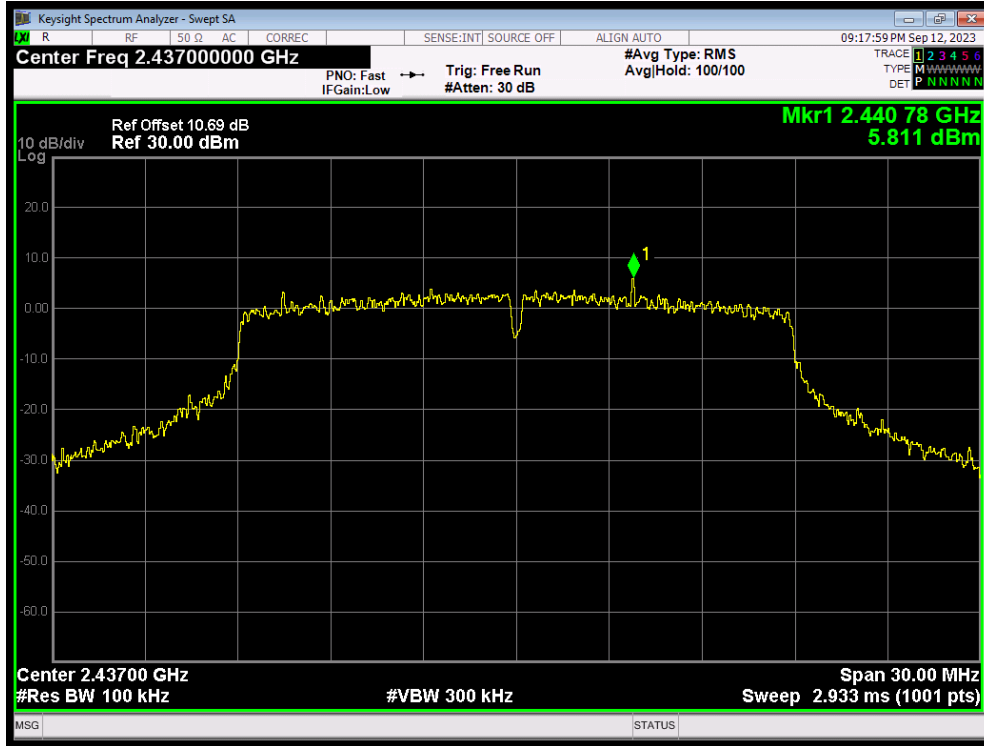

Tx. Spurious 802.11n(HT20) 2437MHz Emission

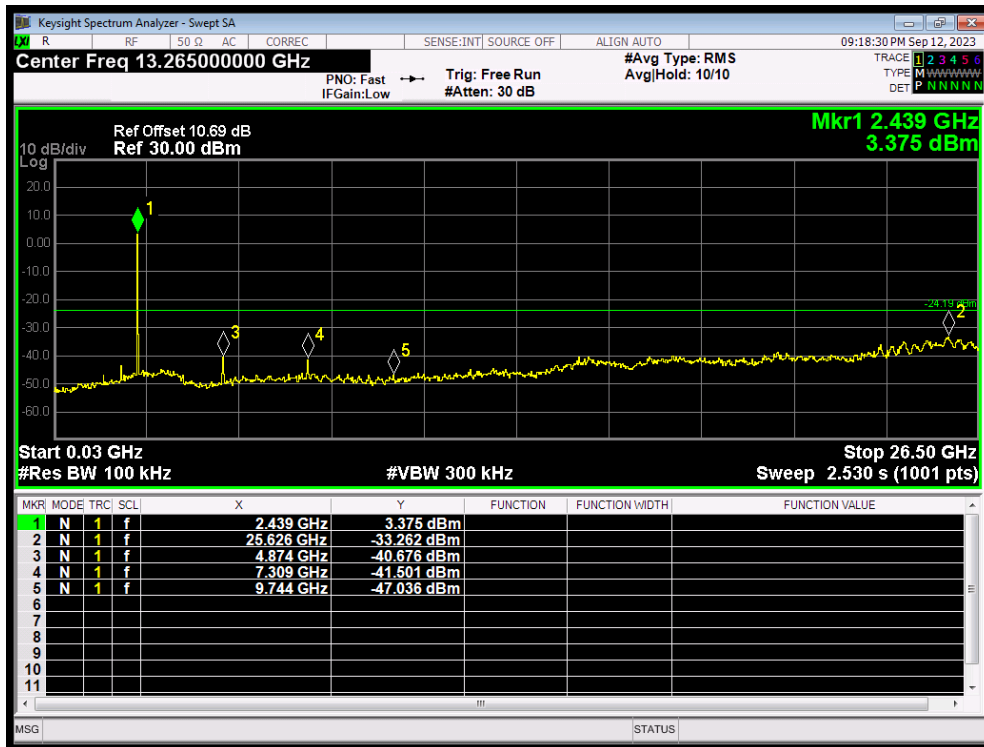

Tx. Spurious 802.11n(HT20) 2462MHz Ref

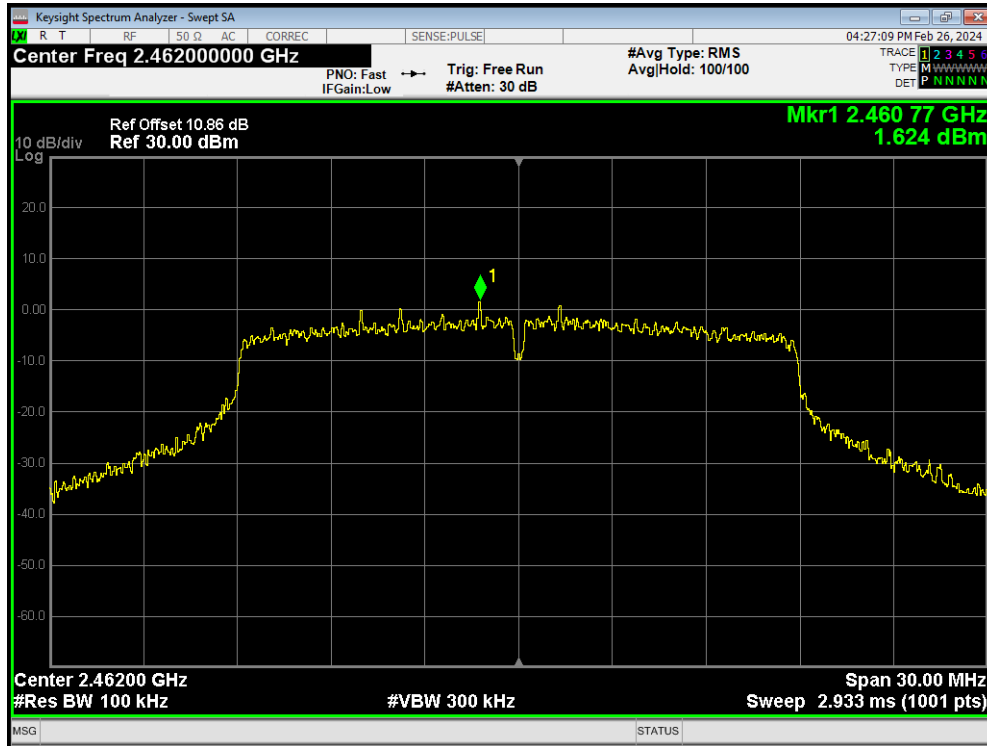

Tx. Spurious 802.11n(HT20) 2462MHz Emission

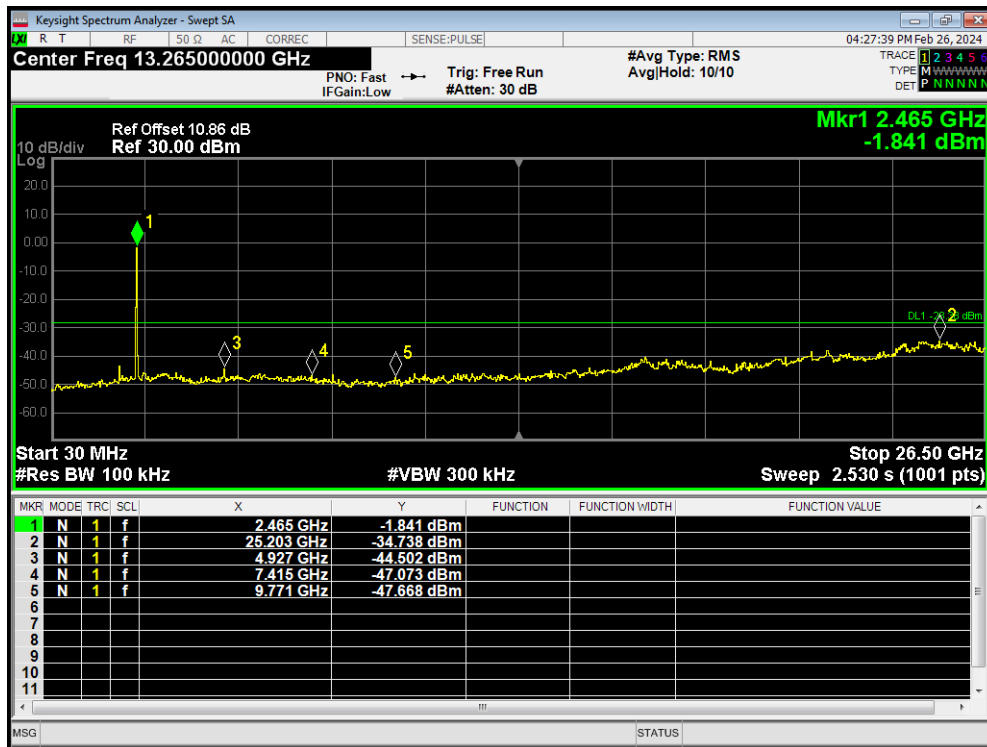

Tx. Spurious 802.11n(HT40) 2422MHz Ref

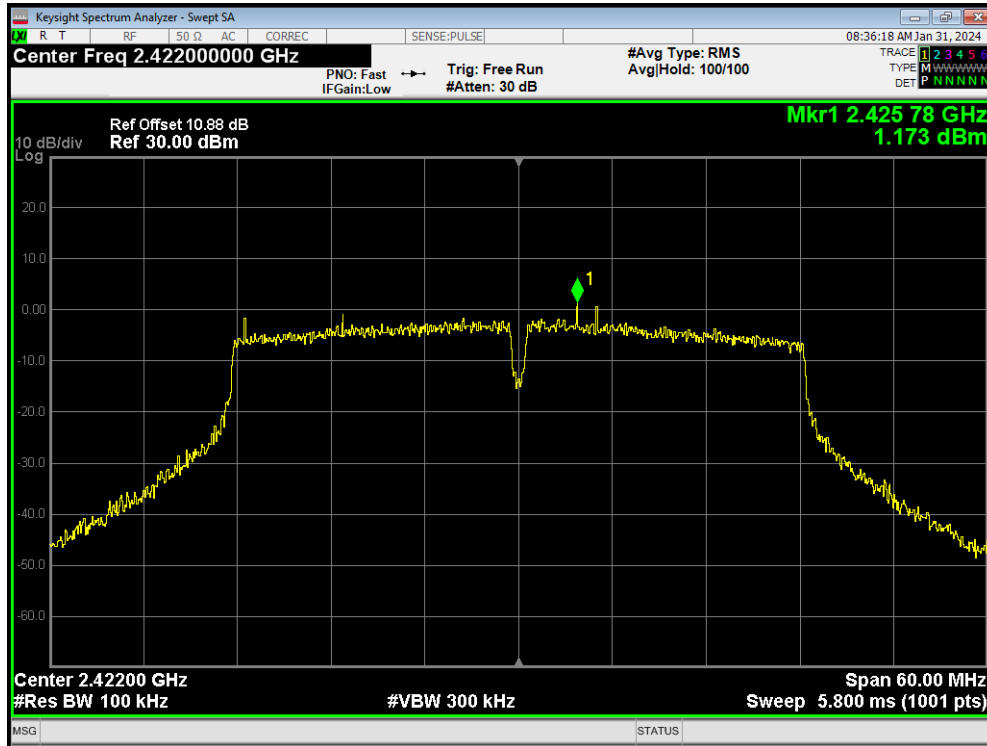

Tx. Spurious 802.11n(HT40) 2422MHz Emission

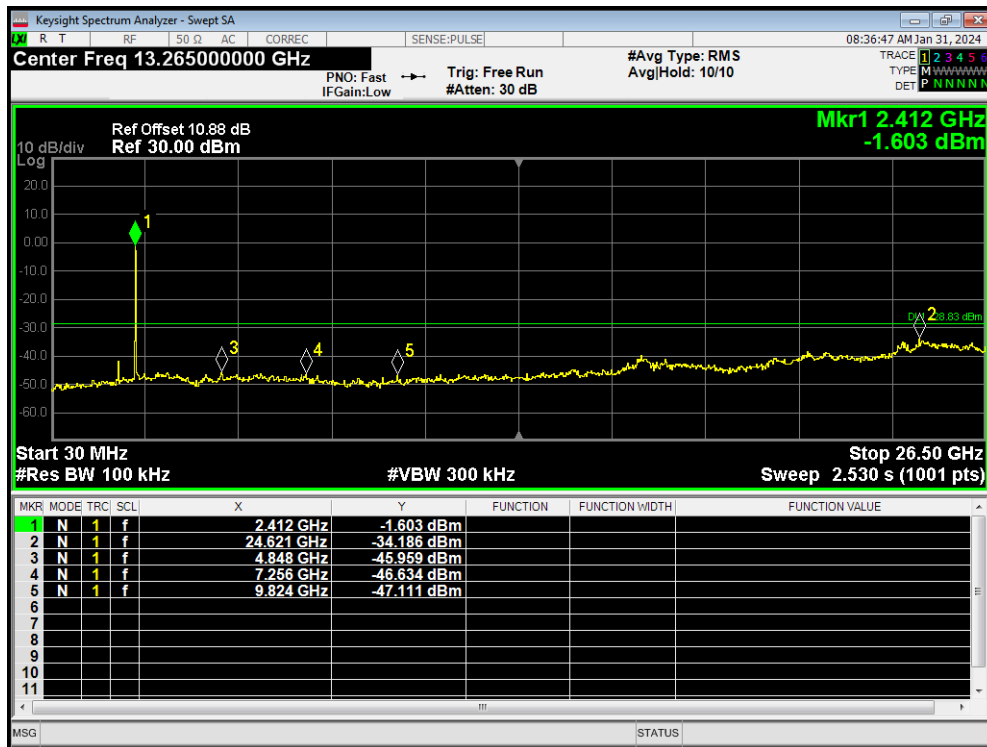

Tx. Spurious 802.11n(HT40) 2437MHz Ref

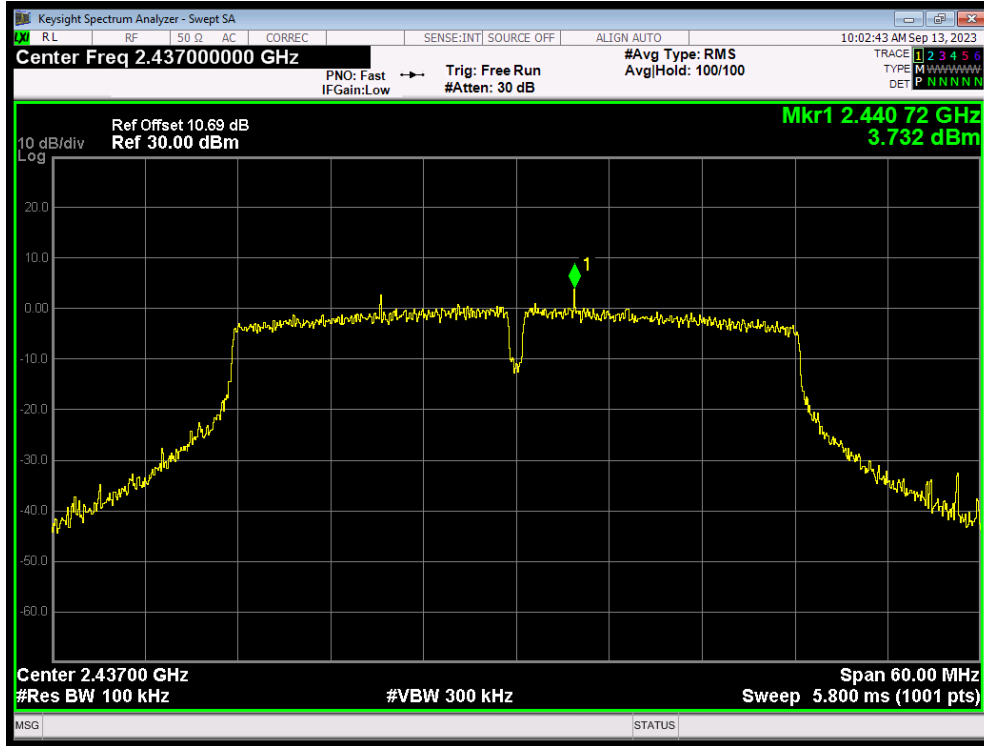

Tx. Spurious 802.11n(HT40) 2437MHz Emission

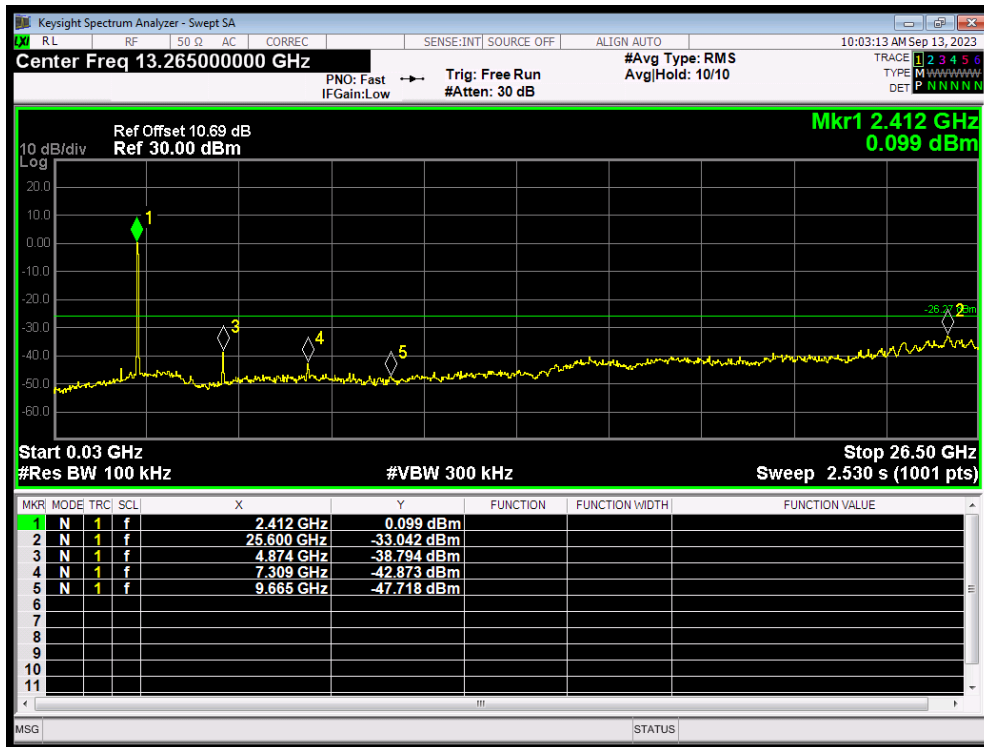

Tx. Spurious 802.11n(HT40) 2452MHz Ref

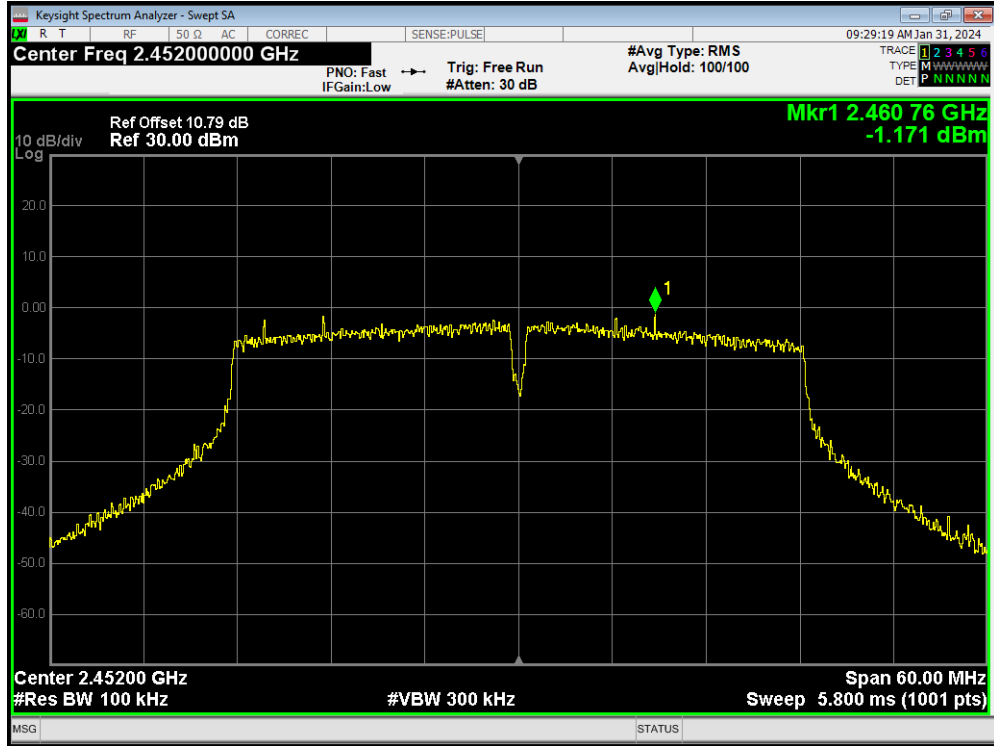

Tx. Spurious 802.11n(HT40) 2452MHz Emission

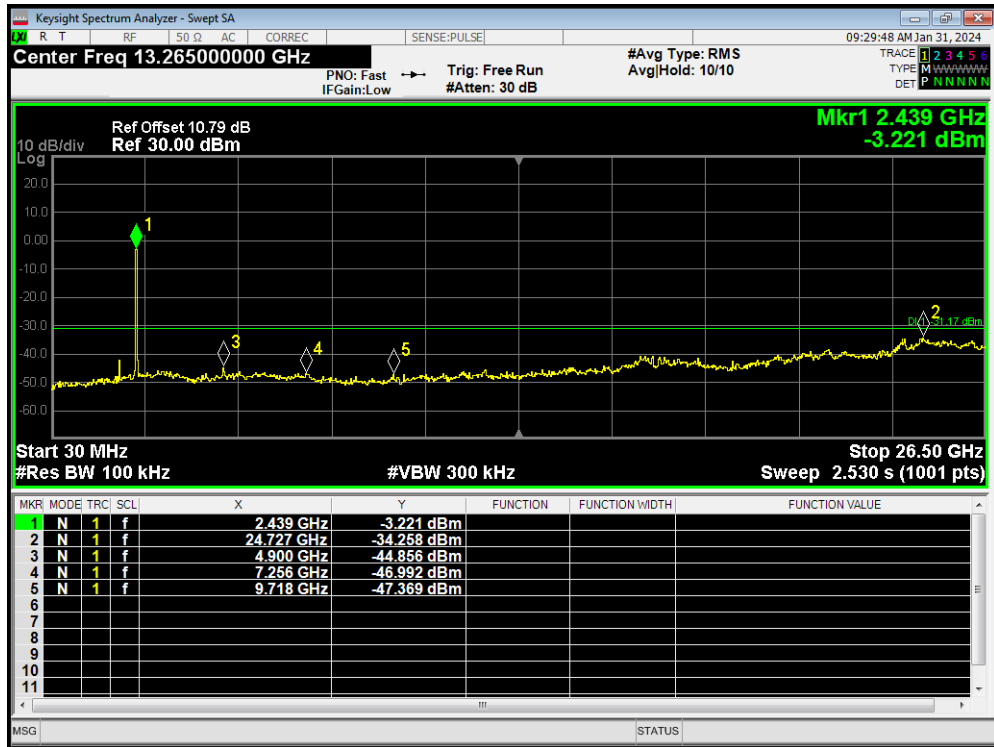

Tx. Spurious Bluetooth LE(1M) 2402MHz Ref

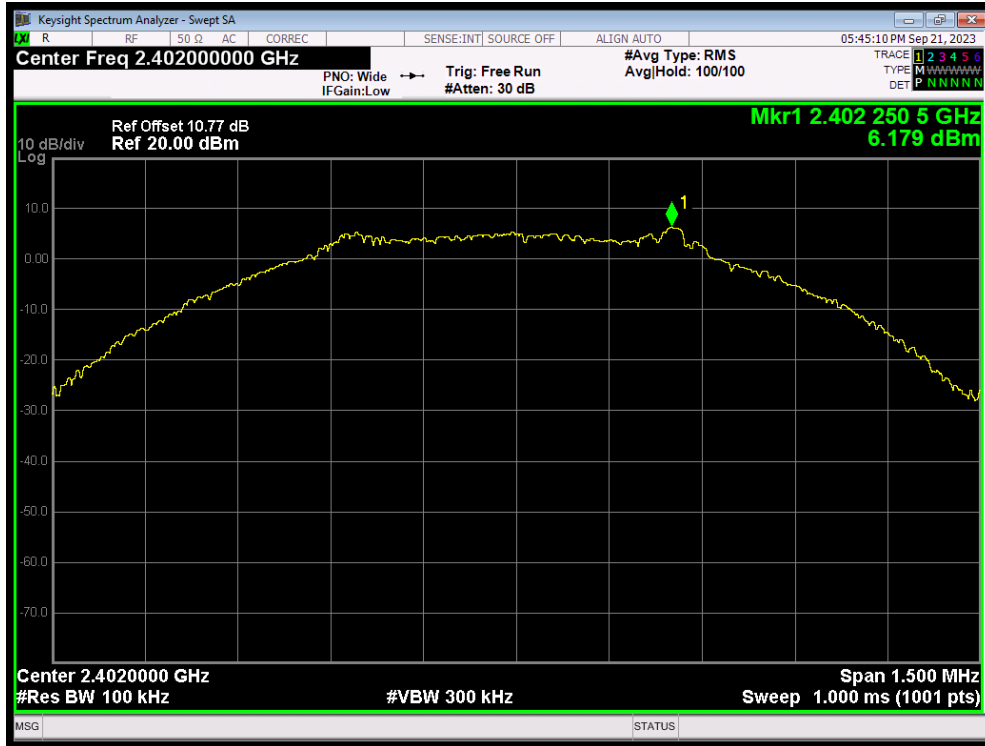

Tx. Spurious Bluetooth LE(1M) 2402MHz Emission

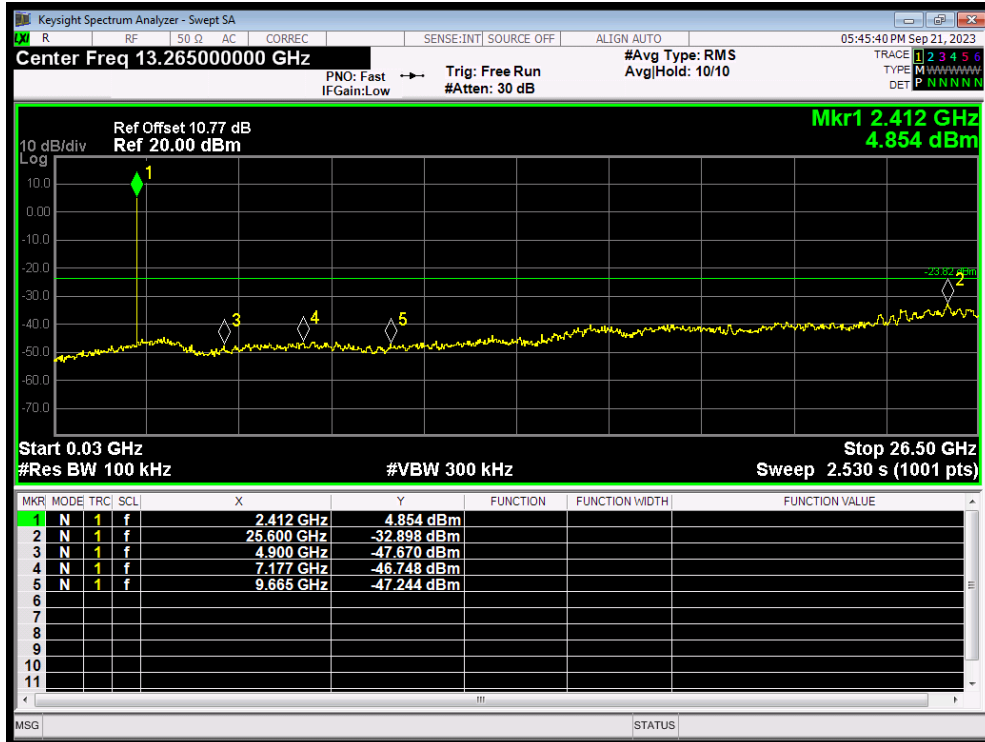



Tx. Spurious Bluetooth LE(1M) 2440MHz Ref

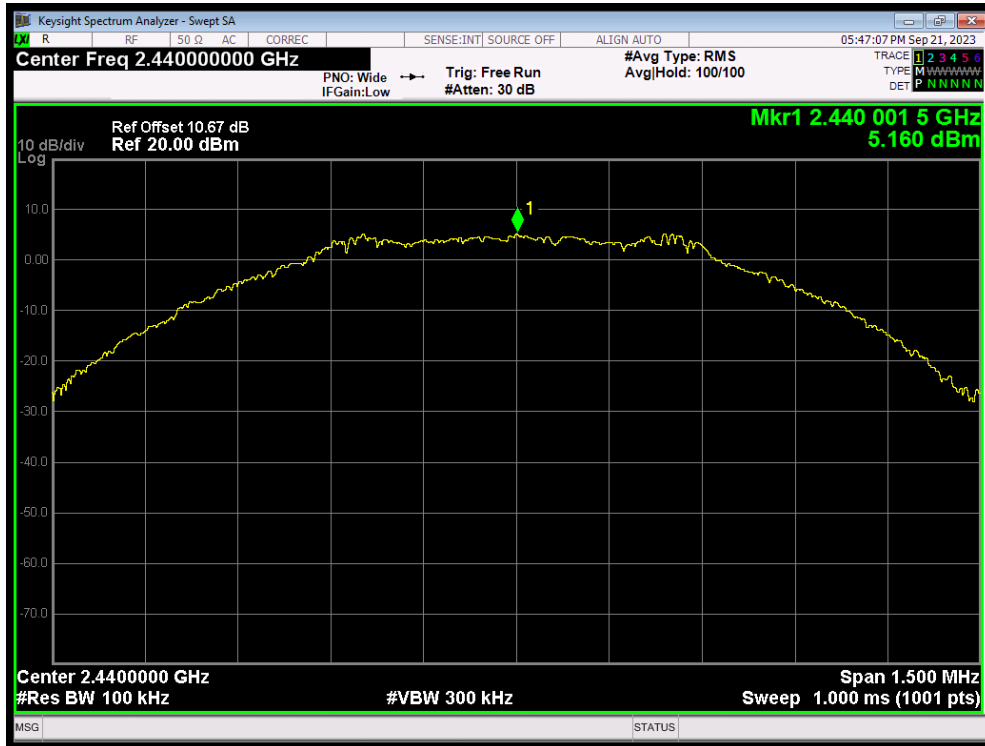

Tx. Spurious Bluetooth LE(1M) 2440MHz Emission

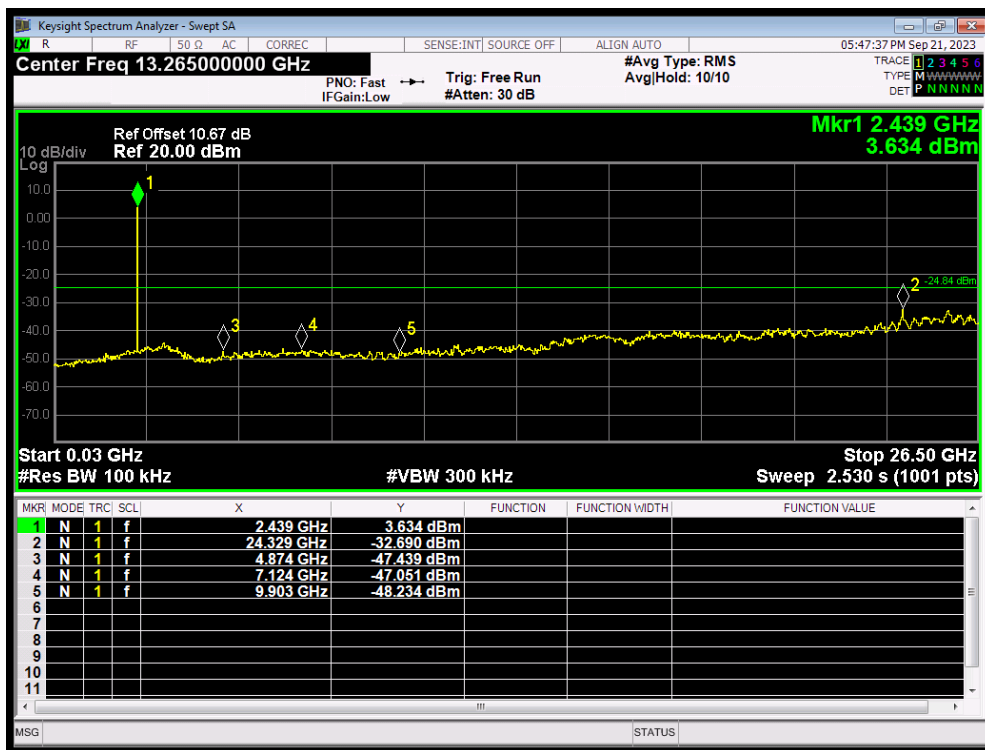

Tx. Spurious Bluetooth LE(1M) 2480MHz Ref

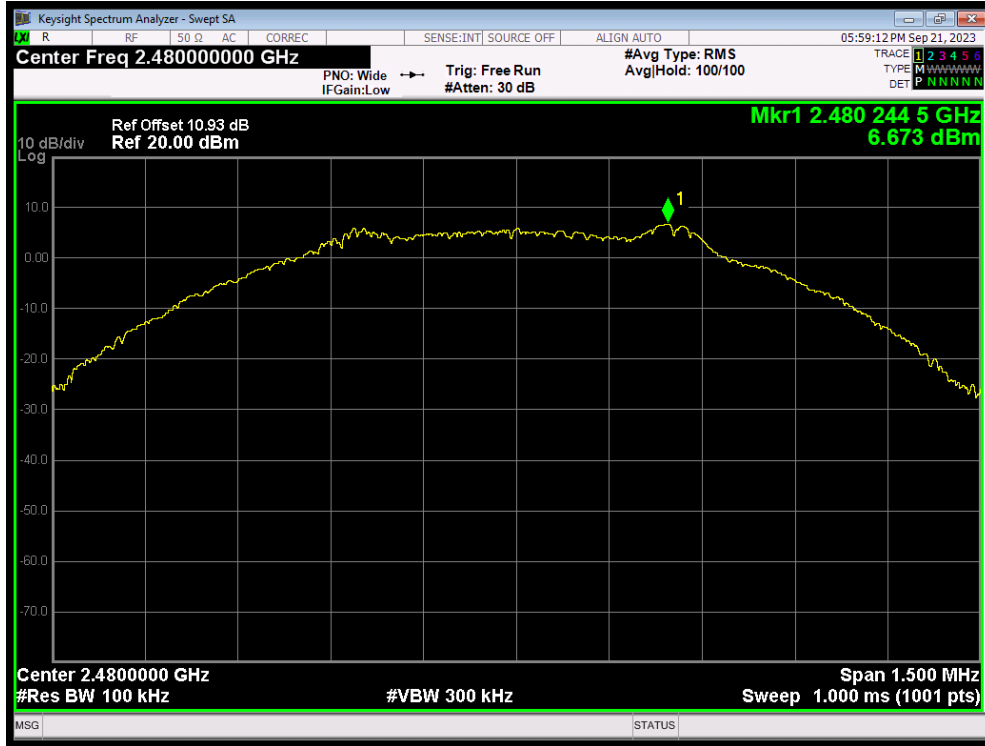

Tx. Spurious Bluetooth LE(1M) 2480MHz Emission

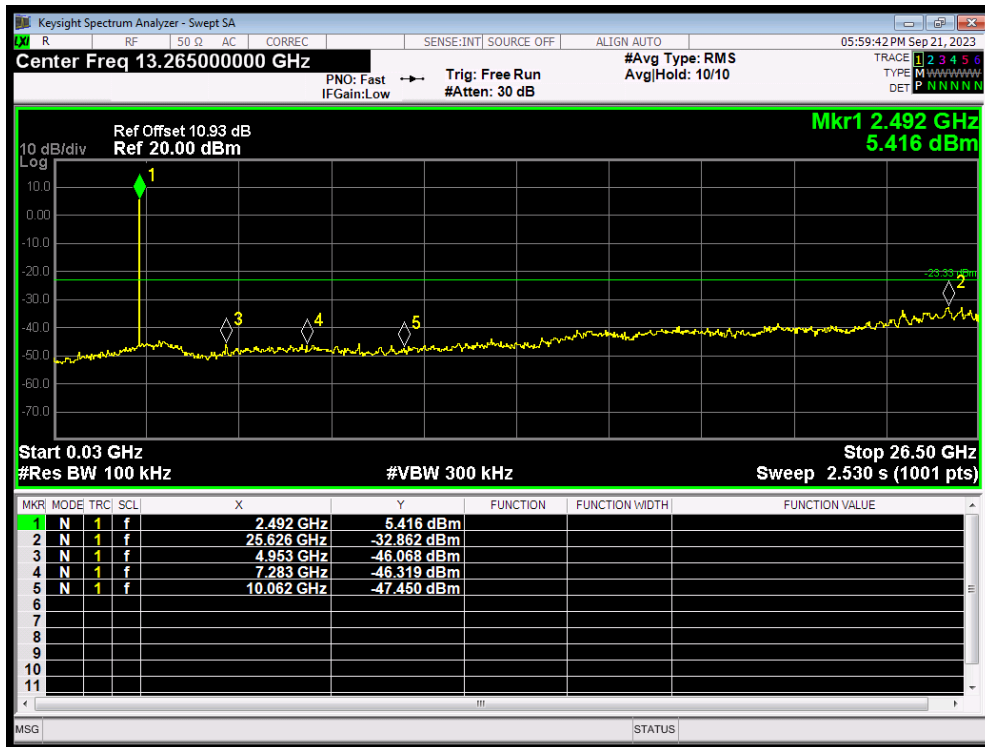

Tx. Spurious Bluetooth LE(2M) 2402MHz Ref



Tx. Spurious Bluetooth LE(2M) 2402MHz Emission

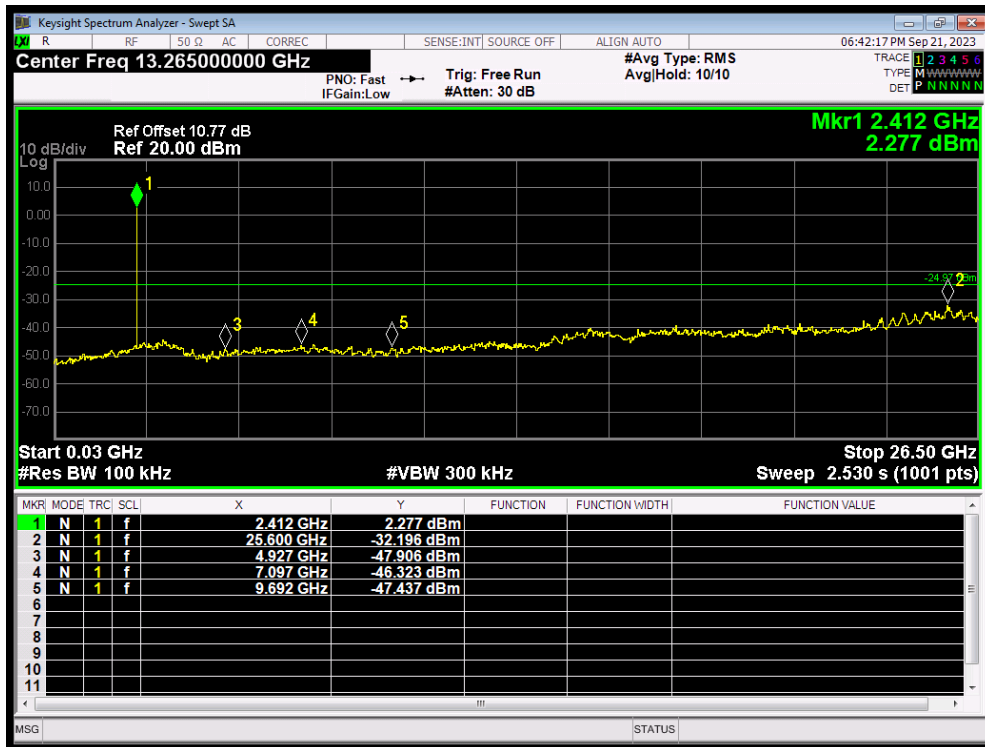

Tx. Spurious Bluetooth LE(2M) 2440MHz Ref



Tx. Spurious Bluetooth LE(2M) 2440MHz Emission

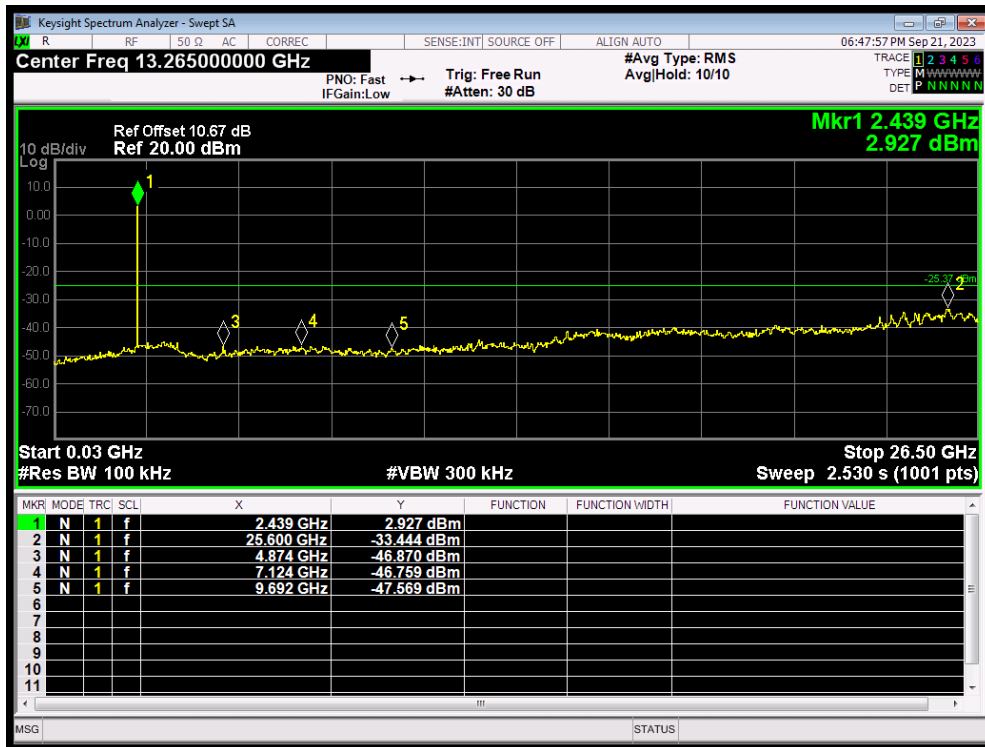

Tx. Spurious Bluetooth LE(2M) 2480MHz Ref



Tx. Spurious Bluetooth LE(2M) 2480MHz Emission

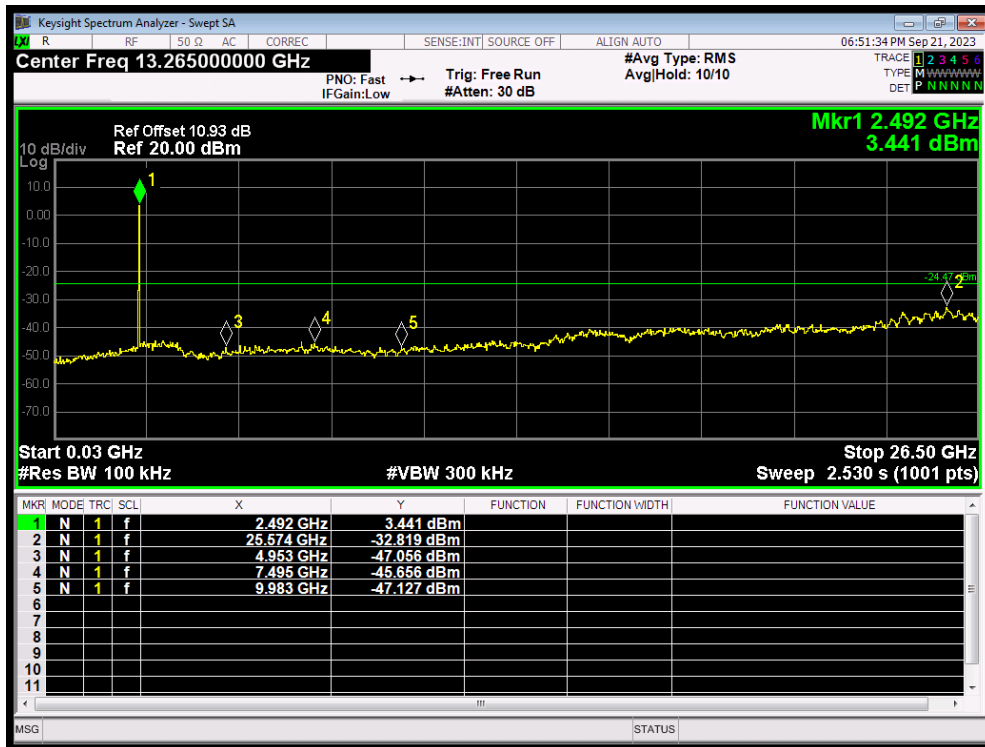

Tx. Spurious Bluetooth LE(S=2) 2402MHz Ref

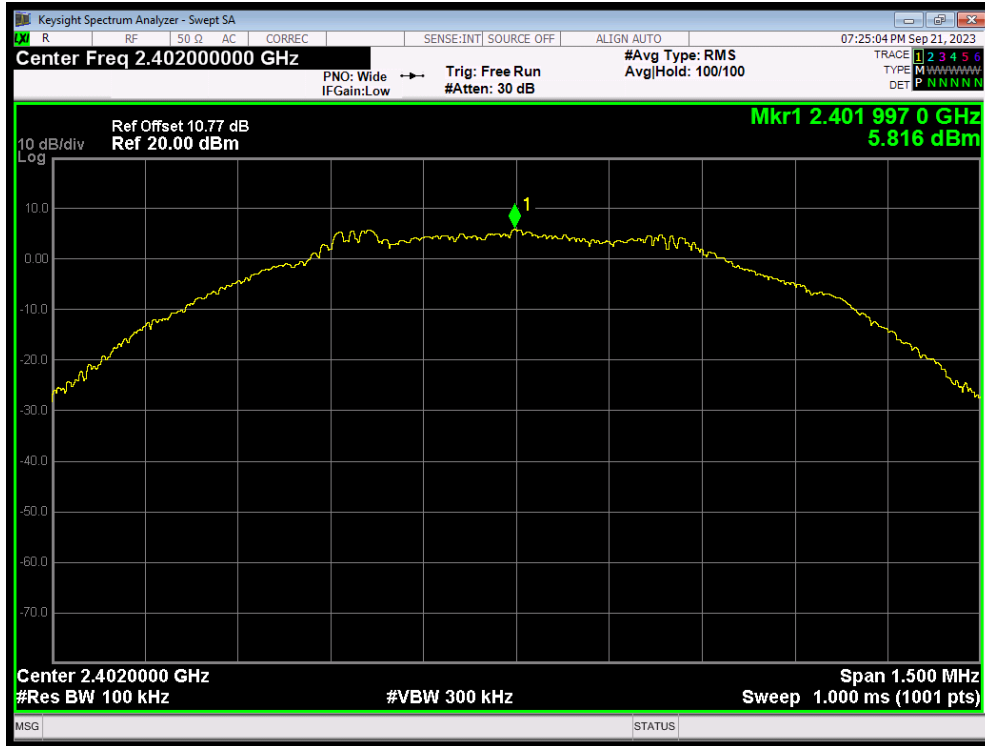

Tx. Spurious Bluetooth LE(S=2) 2402MHz Emission

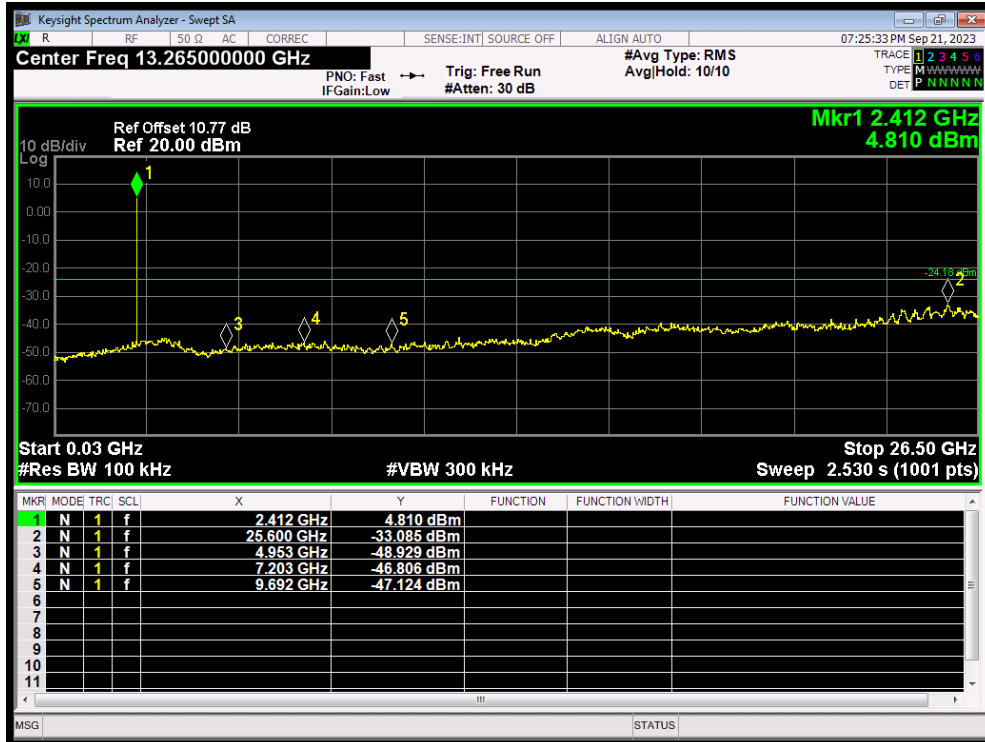

Tx. Spurious Bluetooth LE(S=2) 2440MHz Ref



Tx. Spurious Bluetooth LE(S=2) 2440MHz Emission

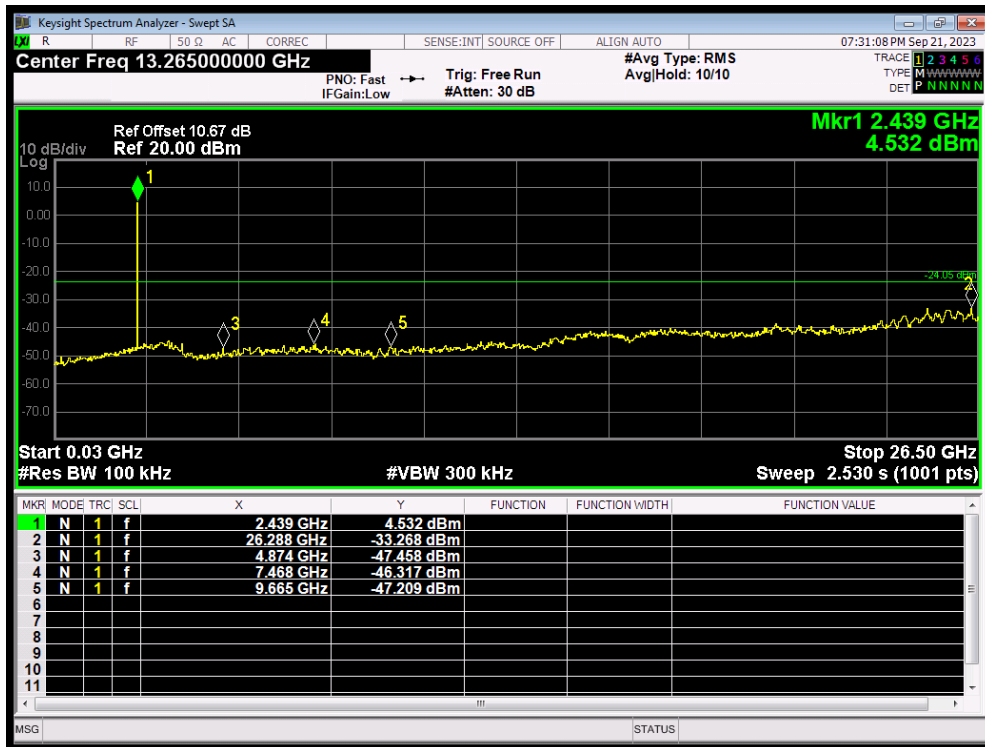

Tx. Spurious Bluetooth LE(S=2) 2480MHz Ref

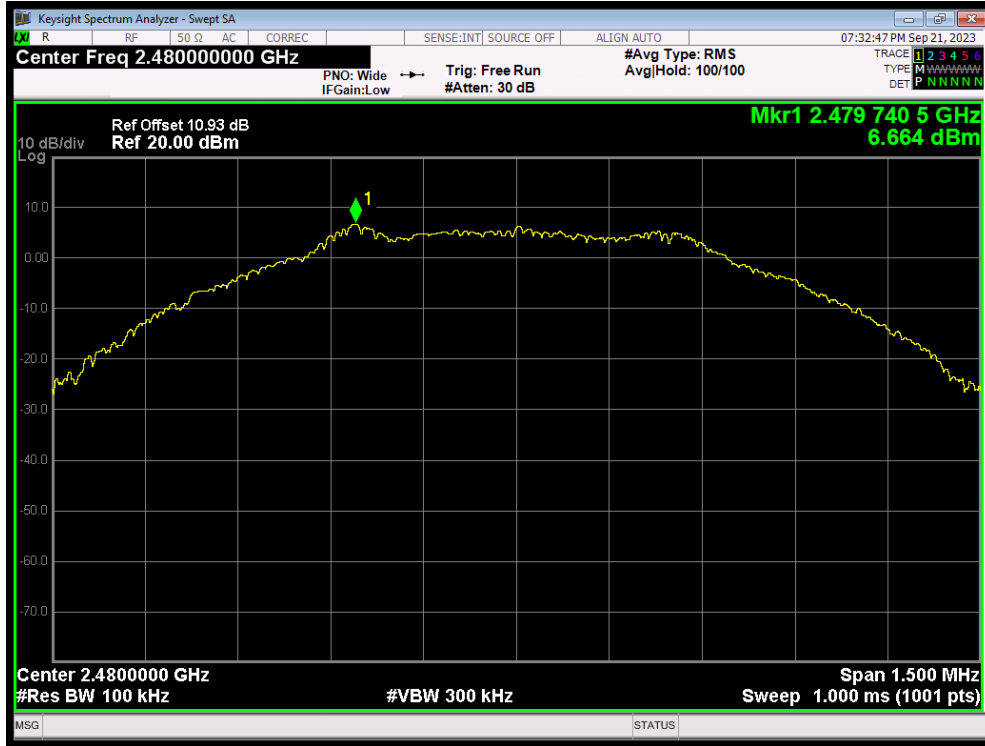

Tx. Spurious Bluetooth LE(S=2) 2480MHz Emission

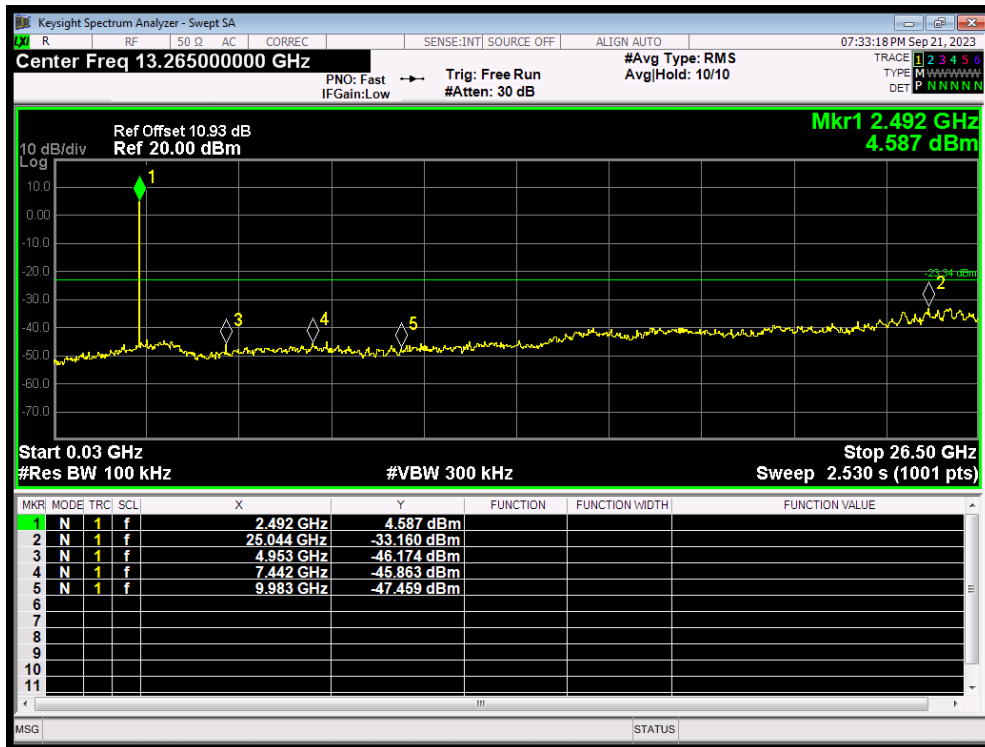



Tx. Spurious Bluetooth LE(S=8) 2402MHz Ref

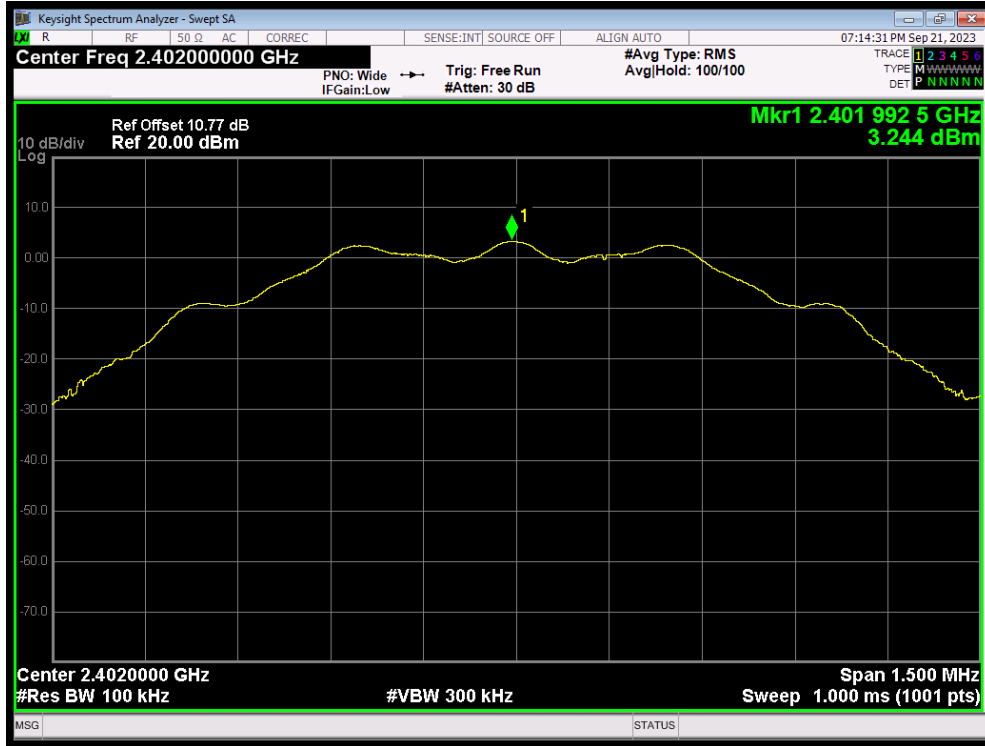

Tx. Spurious Bluetooth LE(S=8) 2402MHz Emission

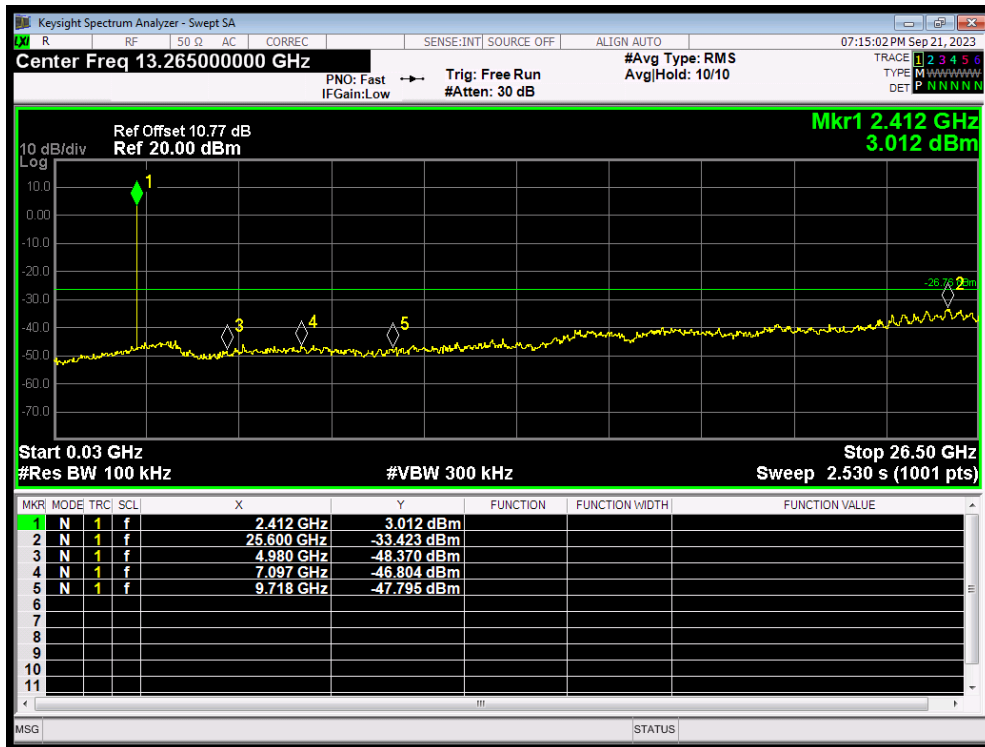

Tx. Spurious Bluetooth LE(S=8) 2440MHz Ref

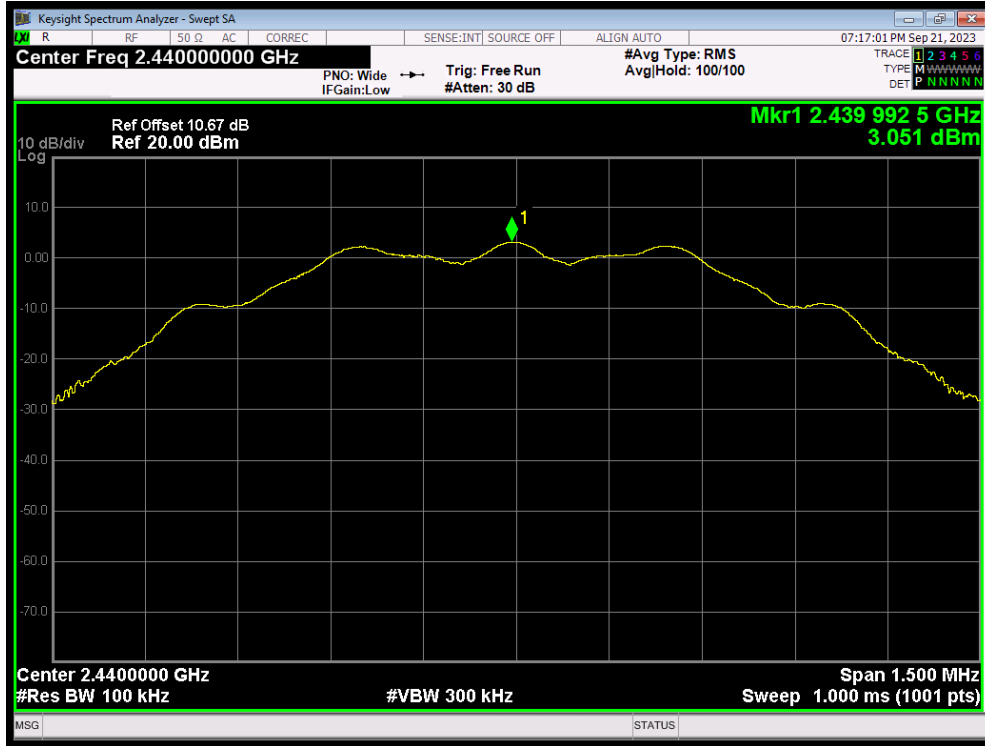

Tx. Spurious Bluetooth LE(S=8) 2440MHz Emission

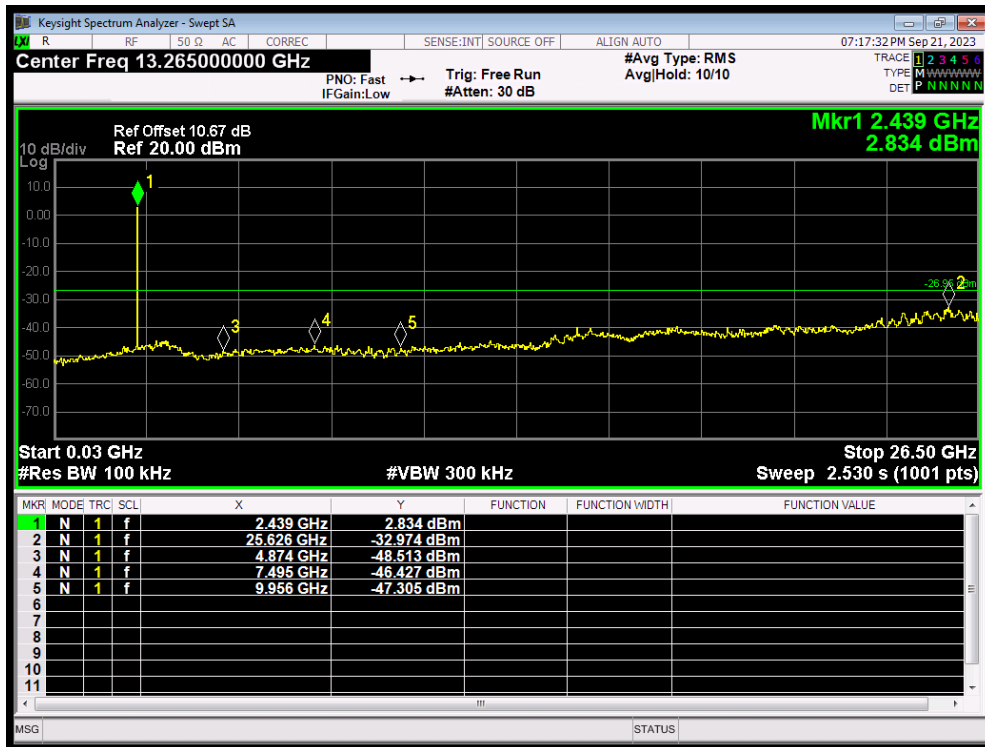

Tx. Spurious Bluetooth LE(S=8) 2480MHz Ref

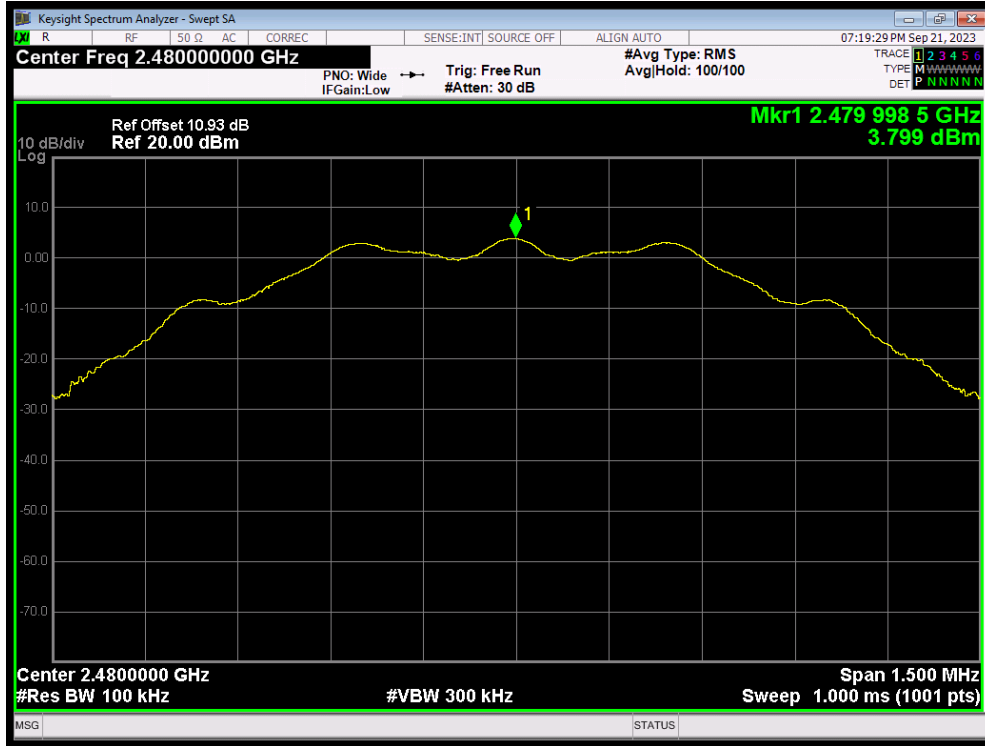

Tx. Spurious Bluetooth LE(S=8) 2480MHz Emission

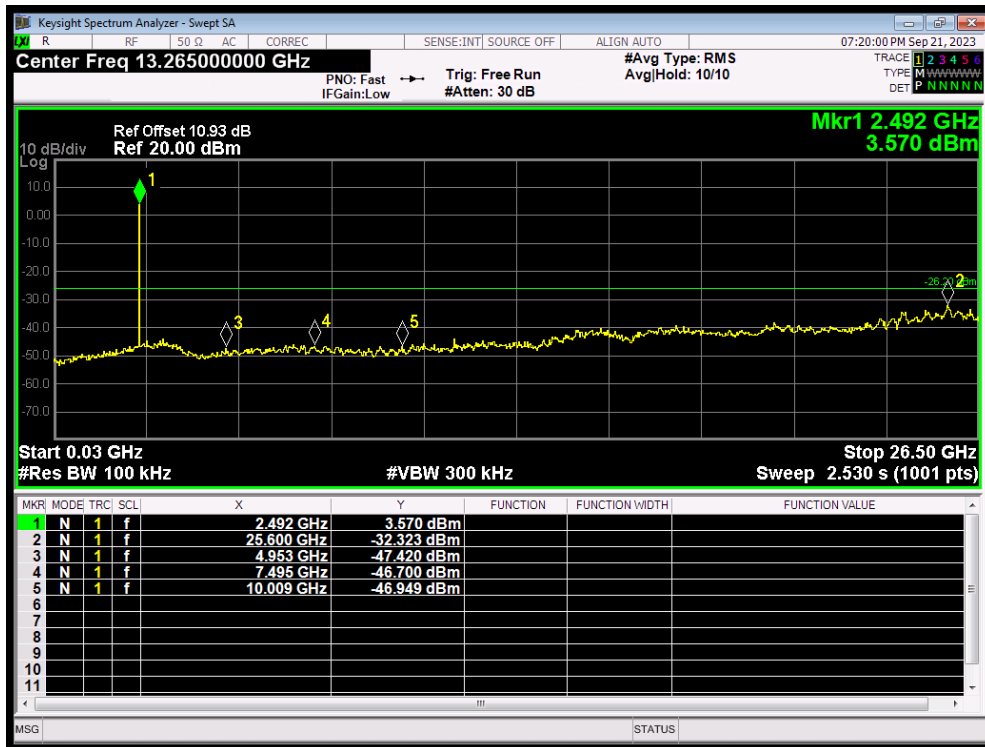

## 5.6. Unwanted Emission

### Ambient Condition

Temperature	Relative humidity
15°C ~ 35°C	20% ~ 80%

### Method of Measurement

The test set-up was made in accordance to the general provisions of ANSI C63.10. The Equipment Under Test (EUT) was set up on a non-conductive table in the semi-anechoic chamber. The test was performed at the distance of 3 m between the EUT and the receiving antenna.

The turntable shall be rotated from 0 to 360 degrees for detecting the maximum of radiated spurious signal level. The measurements shall be repeated with orthogonal polarization of the test antenna. The data of cable loss and antenna factor has been calibrated in full testing frequency range before the testing. Sweep the Restricted Band and the emissions less than 20 dB below the permissible value are reported.

The radiated emissions measurements were made in a typical installation configuration. Sweep the whole frequency band through the range from 9 kHz to the 10th harmonic of the carrier, and the emissions less than 20 dB below the permissible value are reported.

This method refer to ANSI C63.10.

The procedure for peak unwanted emissions measurements above 1000 MHz is as follows:

Set the spectrum analyzer in the following:

9kHz~150 kHz

RBW=200Hz, VBW=1kHz/ Sweep=AUTO

150 kHz~30MHz

RBW=9KHz, VBW=30KHz,/ Sweep=AUTO

Below 1GHz

RBW=100kHz / VBW=300kHz / Sweep=AUTO

a) Peak emission levels are measured by setting the instrument as follows:

Above 1GHz

PEAK: RBW=1MHz VBW=3MHz/ Sweep=AUTO

b) Average emission levels are measured by setting the instrument as follows:

Above 1GHz

AVERAGE: RBW=1MHz / VBW=3MHz / Sweep=AUTO

c) Detector: The measurements employing a CISPR quasi-peak detector except for the frequency bands 9-90 kHz, 110-490 kHz and above 1000 MHz. Radiated emission limits in these three bands are based on measurements employing an average detector.

d) Averaging type = power (i.e., rms) (As an alternative, the detector and averaging type may be set for linear voltage averaging. Some instruments require linear display mode to use linear voltage

averaging. Log or dB averaging shall not be used.)

e) Sweep time = auto.

f) Perform a trace average of at least 100 traces if the transmission is continuous. If the transmission is not continuous, then the number of traces shall be increased by a factor of  $1 / D$ , where  $D$  is the duty cycle. For example, with 50% duty cycle, at least 200 traces shall be averaged. (If a specific emission is demonstrated to be continuous—i.e., 100% duty cycle—then rather than turning ON and OFF with the transmit cycle, at least 100 traces shall be averaged.)

g) If tests are performed with the EUT transmitting at a duty cycle less than 98%, then a correction factor shall be added to the measurement results prior to comparing with the emission limit, to compute the emission level that would have been measured had the test been performed at 100% duty cycle. The correction factor is computed as follows:

1) If power averaging (rms) mode was used in the preceding step e), then the correction factor is  $[10 \log (1 / D)]$ , where  $D$  is the duty cycle. For example, if the transmit duty cycle was 50%, then 3 dB shall be added to the measured emission levels.

2) If linear voltage averaging mode was used in the preceding step e), then the correction factor is  $[20 \log (1 / D)]$ , where  $D$  is the duty cycle. For example, if the transmit duty cycle was 50%, then 6 dB shall be added to the measured emission levels.

3) If a specific emission is demonstrated to be continuous (100% duty cycle) rather than turning ON and OFF with the transmit cycle, then no duty cycle correction is required for that emission.

The test is in transmitting mode.

**Test Setup**

**9KHz~ 30MHz**

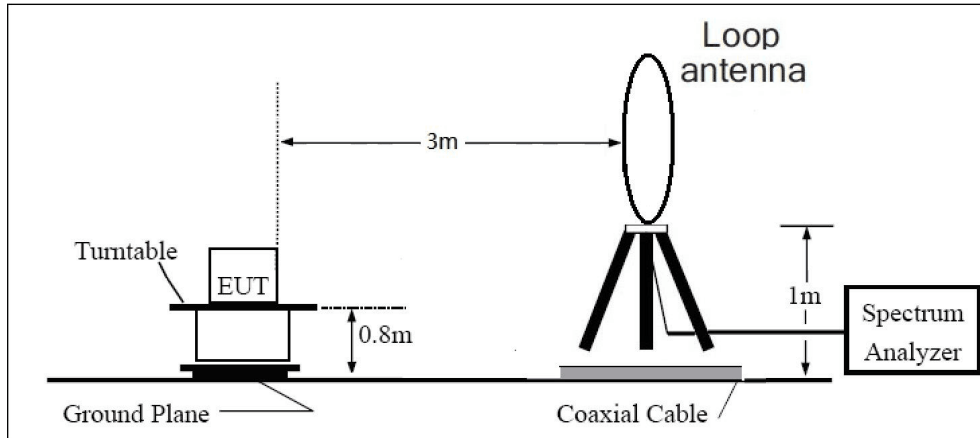

**30MHz~ 1GHz**

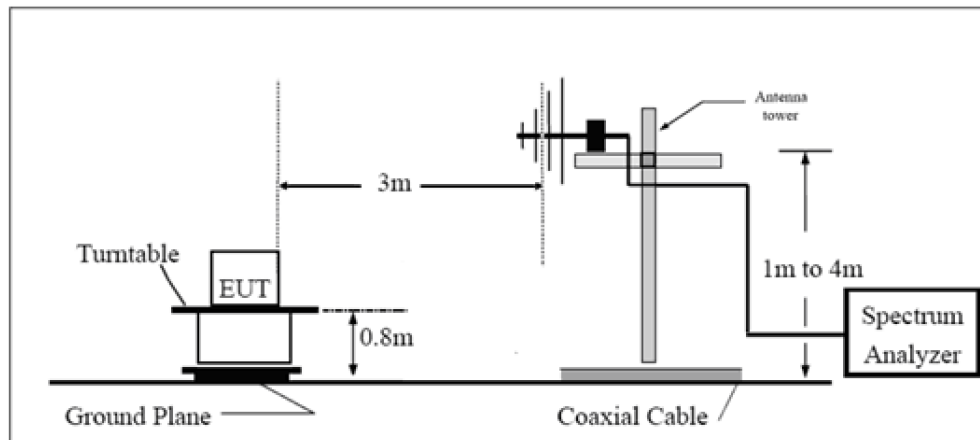

**Above 1GHz**

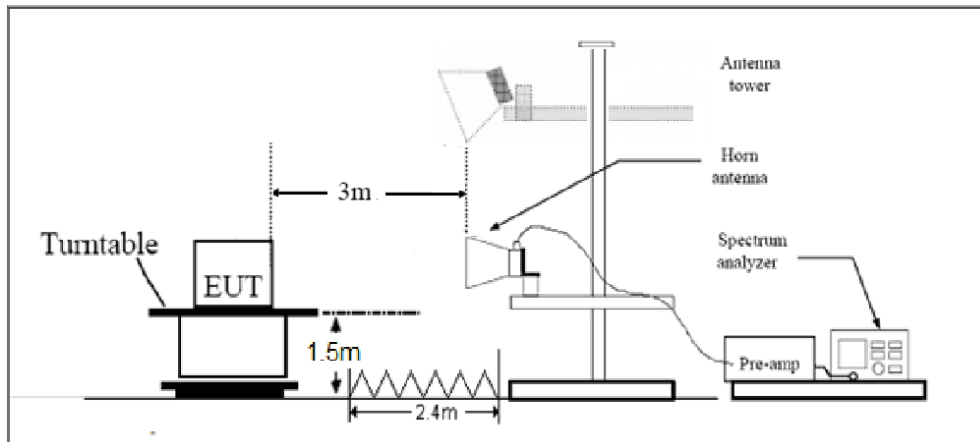

Note: Area side:2.4mX3.6m

### Limits

Rule Part 15.247(d) specifies that “In addition, radiated emissions which fall in the restricted bands, as defined in § 15.205(a), must also comply with the radiated emission limits specified in § 15.209(a) (see § 15.205(c)).”

Limit in restricted band

Frequency of emission (MHz)	Field strength( $\mu\text{V}/\text{m}$ )	Field strength( $\text{dB}\mu\text{V}/\text{m}$ )
0.009–0.490	2400/F(kHz)	/
0.490–1.705	24000/F(kHz)	/
1.705–30.0	30	/
30-88	100	40
88-216	150	43.5
216-960	200	46
Above960	500	54

### §15.35(b)

There is also a limit on the radio frequency emissions, as measured using instrumentation with a peak detector function, corresponding to 20 dB above the maximum permitted average limit.

Peak Limit=74  $\text{dB}\mu\text{V}/\text{m}$

Average Limit=54  $\text{dB}\mu\text{V}/\text{m}$

Spurious Radiated Emissions are permitted in any of the frequency bands listed below:

MHz	MHz	MHz	GHz
0.090-0.110	16.42-16.423	399.9-410	4.5-5.15
<sup>1</sup> 0.495-0.505	16.69475-16.69525	608-614	5.35-5.46
2.1735-2.1905	16.80425-16.80475	960-1240	7.25-7.75
4.125-4.128	25.5-25.67	1300-1427	8.025-8.5
4.17725-4.17775	37.5-38.25	1435-1626.5	9.0-9.2
4.20725-4.20775	73-74.6	1645.5-1646.5	9.3-9.5
6.215-6.218	74.8-75.2	1660-1710	10.6-12.7
6.26775-6.26825	108-121.94	1718.8-1722.2	13.25-13.4
6.31175-6.31225	123-138	2200-2300	14.47-14.5
8.291-8.294	149.9-150.05	2310-2390	15.35-16.2
8.362-8.366	156.52475-156.52525	2483.5-2500	17.7-21.4
8.37625-8.38675	156.7-156.9	2690-2900	22.01-23.12
8.41425-8.41475	162.0125-167.17	3260-3267	23.6-24.0
12.29-12.293	167.72-173.2	3332-3339	31.2-31.8
12.51975-12.52025	240-285	3345.8-3358	36.43-36.5
12.57675-12.57725	322-335.4	3600-4400	( <sup>2</sup> )
13.36-13.41			

### Measurement Uncertainty

The assessed measurement uncertainty to ensure 95% confidence level for the normal distribution is with the coverage factor  $k = 1.96$ .

Frequency	Uncertainty
9KHz-30MHz	3.55 dB
30MHz-200MHz	4.17 dB
200MHz-1GHz	4.84 dB
1-18GHz	4.35 dB
18-26.5GHz	5.90 dB
26.5GHz~40GHz	5.92 dB



**Test Results:**

The following graphs display the maximum values of horizontal and vertical by software. Blue trace uses the peak detection, Green trace uses the average detection.

A symbol ( $\text{dB}\frac{\text{dBm}}{\text{m}}$ ) in the test plot below means ( $\text{dB}\mu\text{V}/\text{m}$ )

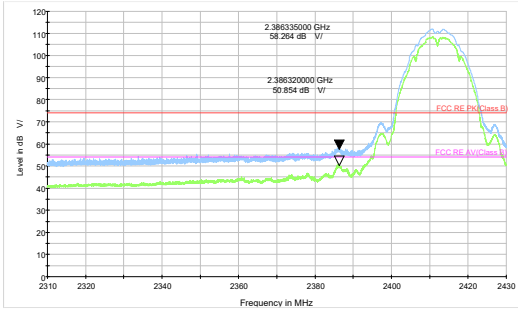

802.11b-Channel 1 Peak+ Average

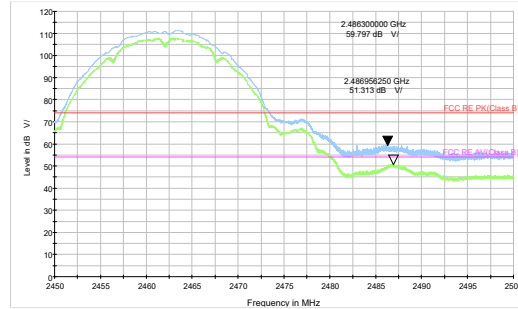

802.11b-Channel 11 Peak+ Average

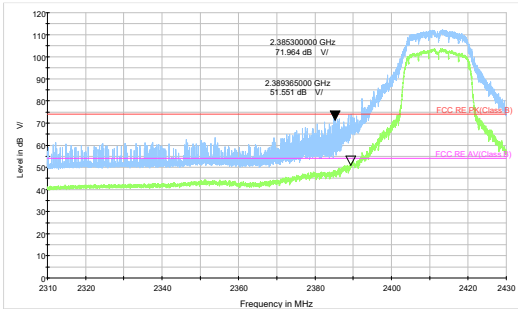

802.11g-Channel 1 Peak+ Average

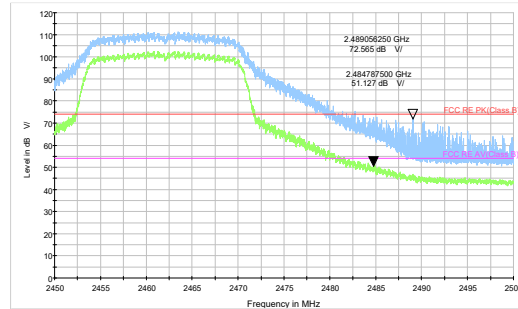

802.11g-Channel 11 Peak+ Average

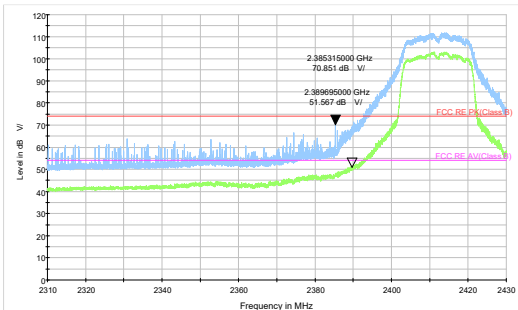

802.11n HT20-Channel 1 Peak+ Average

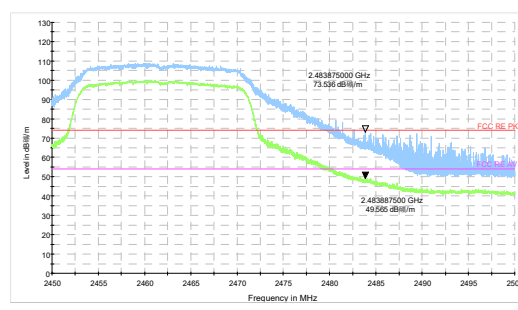

802.11n HT20-Channel 11 Peak+ Average

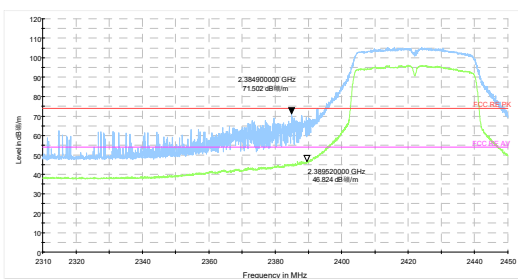

802.11n HT40-Channel 3 Peak+ Average

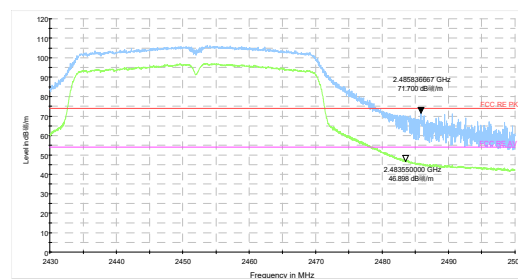

802.11n HT40-Channel 9 Peak+ Average

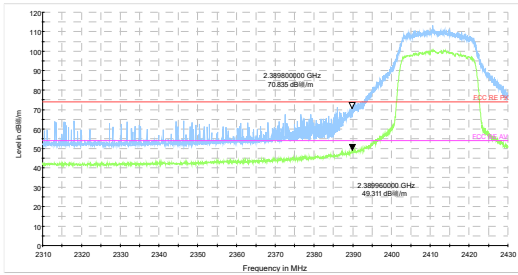

802.11ax HE20-Channel 1 Peak+ Average

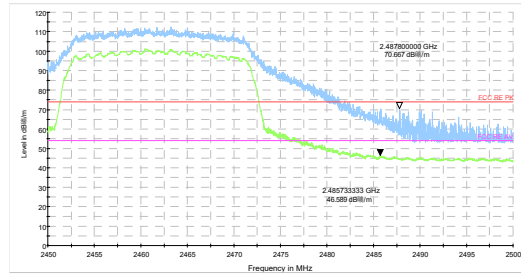

802.11ax HE20-Channel 11 Peak+ Average

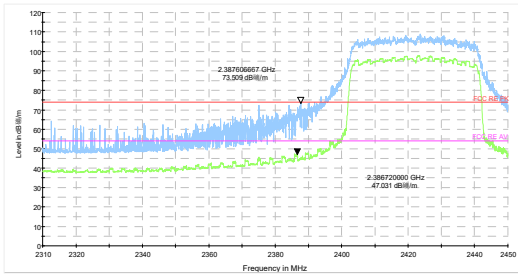

802.11ax HE40-Channel 3 Peak+ Average

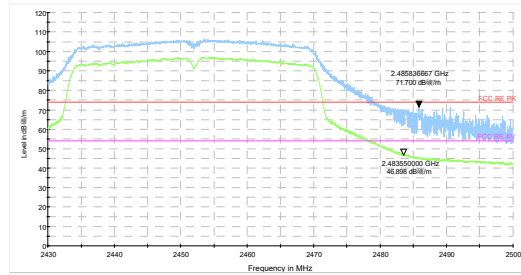

802.11ax HE40-Channel 9 Peak+ Average

After the pretest, Bluetooth LE (1M) was selected as the worst Mode for Bluetooth LE.

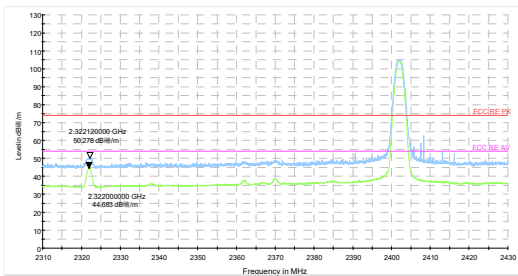

Bluetooth LE (1M) Channel 0 Peak+ Average

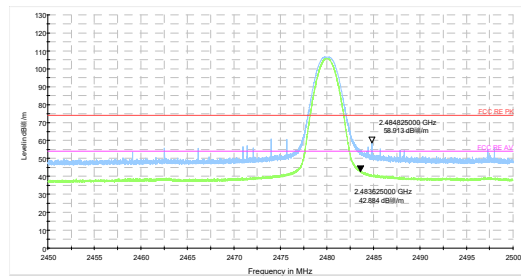

Bluetooth LE (1M) Channel 39 Peak+ Average

**Result of RE**

**Test result**

The following graphs display the maximum values of horizontal and vertical by software.  
 For above 1GHz, Blue trace uses the peak detection, Green trace uses the average detection.

**Continuous TX mode:**

**Wi-Fi 2.4G**

During the test, the Radiates Emission from 30MHz to 1GHz was performed in all modes with all channels, 802.11n(HT40), Channel 6 are selected as the worst condition. The test data of the worst-case condition was recorded in this report.

A symbol (dB<sub>μ</sub>V/m) in the test plot below means (dB<sub>μ</sub>V/m)

A symbol (dB<sub>V</sub>/m) in the test plot below means (dB<sub>V</sub>/m)

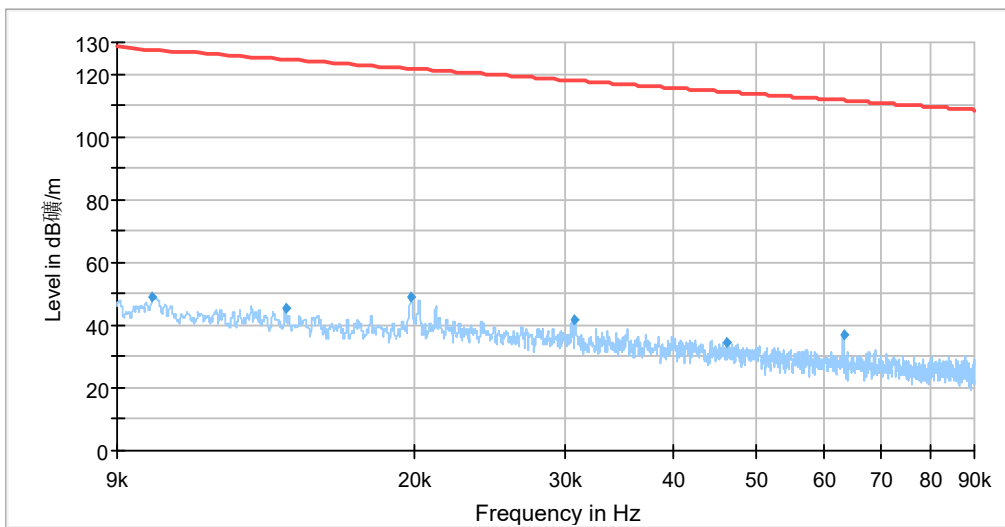

Radiates Emission from 9kHz to 90kHz

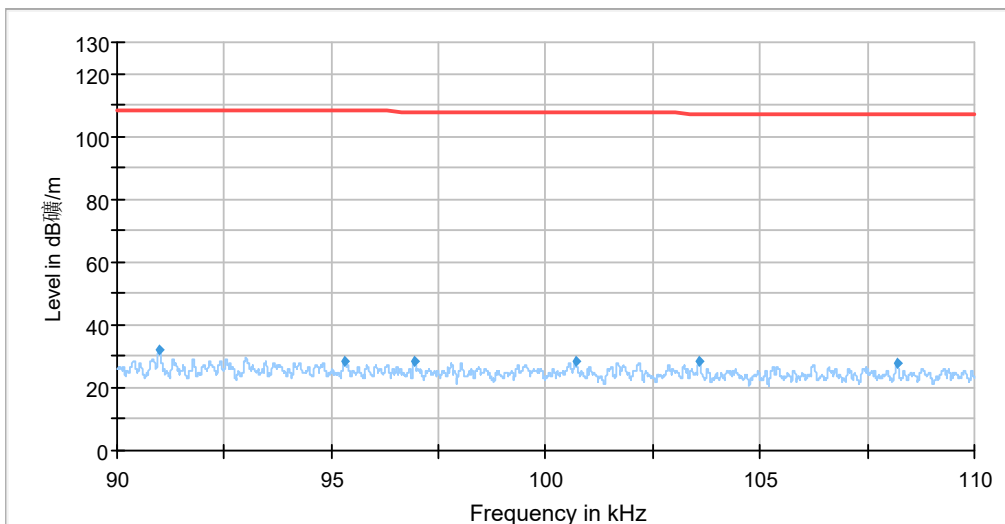

Radiates Emission from 90kHz to 110kHz