



Antenna

F7G250 Datasheet

Antenna Services

Version: 3.1

Date: 2023-03-30

Status:Preliminary

Contents

Contents.....	2
1 Product Description.....	3
2 Product Features.....	3
3 Product Specifications	4
4 Overall Performance	5
4.1. Test Environment	5
4.2. Data-WIFI.....	6
4.3. Radiation Pattern-WIFI.....	10
5 Product Size	17

1 Product Description

The antenna is designed for superior performance, and can be widely used for wireless applications.

We provide comprehensive antenna design support such as simulation, testing and manufacturing for custom antenna solutions to meet your specific application needs.

2 Product Features

- Wi-Fi
- High efficiency
- Excellent performance

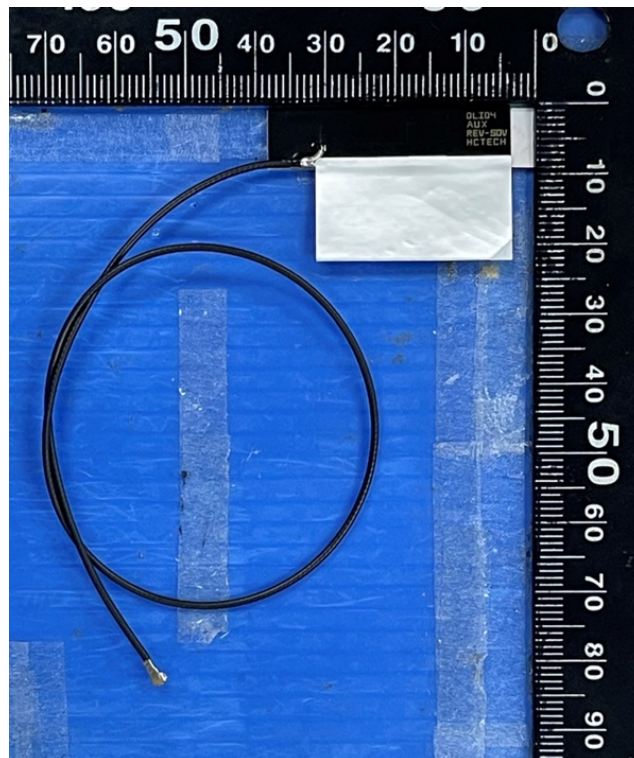

3 Product Specifications

- WIFI

Passive Electrical Specifications

Frequency Range	2.4–2.5 GHz, 5.15–5.85 GHz, 5.925–7.125 GHz
Input Impedence	50 Ω
VSWR	2.4GHz: ≤ 3.0 , 5GHz: ≤ 3.0 6GHz: ≤ 3.0 7GHz: ≤ 3.0
Peak Gain	2.4GHz: ≤ 1.61 dBi, 5GHz: ≤ 4.22 dBi 6GHz: ≤ 5.23 dBi 7GHz: ≤ 5.89 dBi
Antenna Type	PIFA

Mechanical Specifications

Antenna Size	35 mm x 9 mm
Casing	ABS
Connector Type	Caimei NGFF Connector for 1.13 cable
Working Temperature	-40 °C to +85 °C
Radome Color	Black
IP Rating	IP55

4 Overall Performance

4.1. Test Environment

- E5071C ENA Series Network Analyzer
- ETS-LINDGREN AMS-8500 Chamber
- Quad-Ridged Horn Antenna (EMCO 3164-08)
- Rotational Platform with step motor



4.2. Data-WIFI

- VSWR

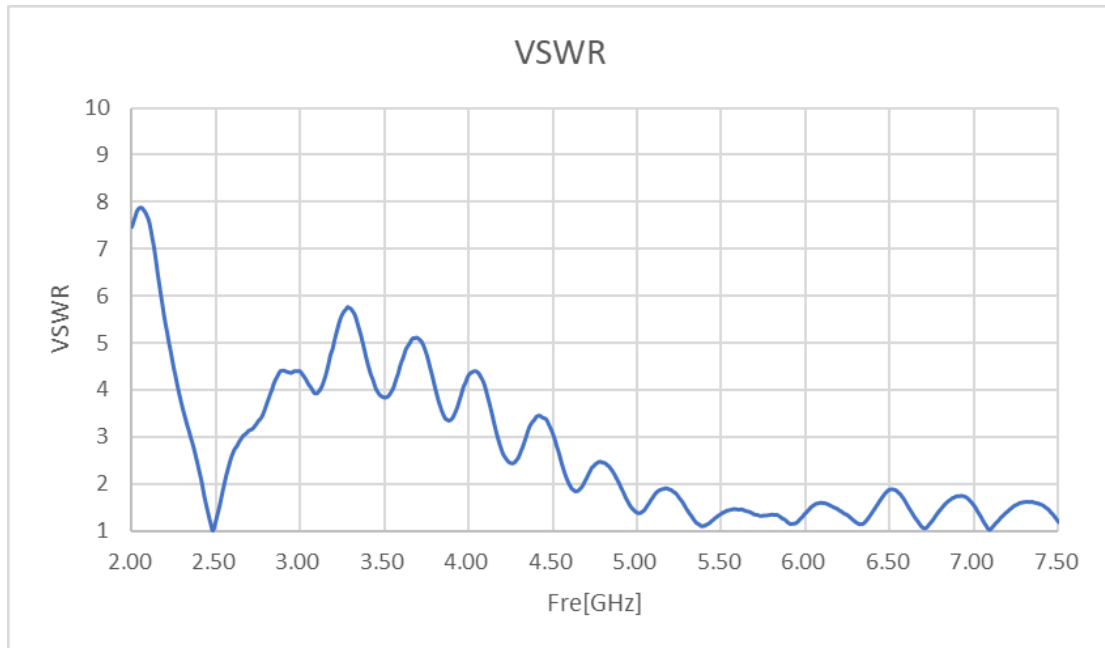

Frequency (MHz)	2400	2500	5150	5885	6125	7125
VSWR	2.27	1.25	1.90	1.20	1.58	1.19

- Efficiency

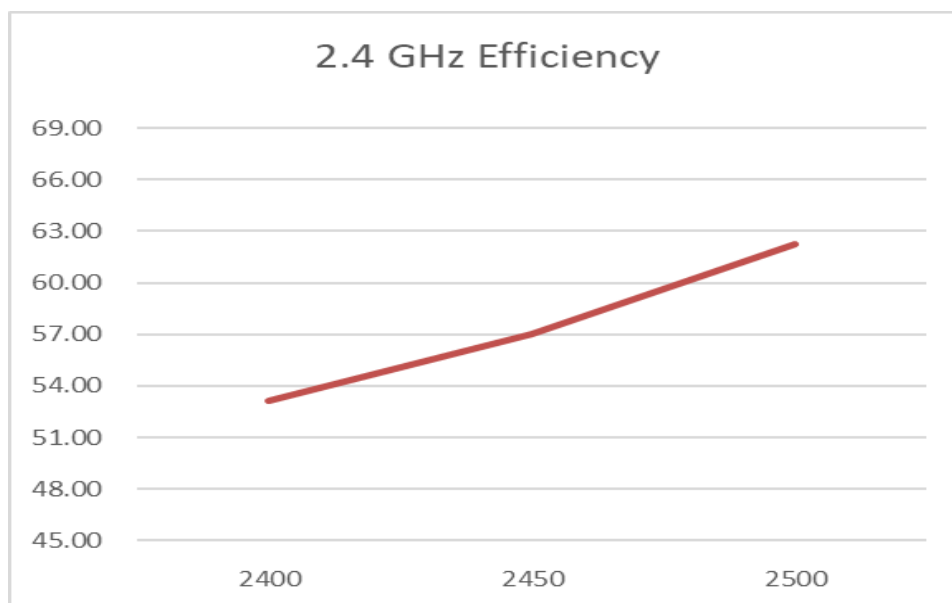

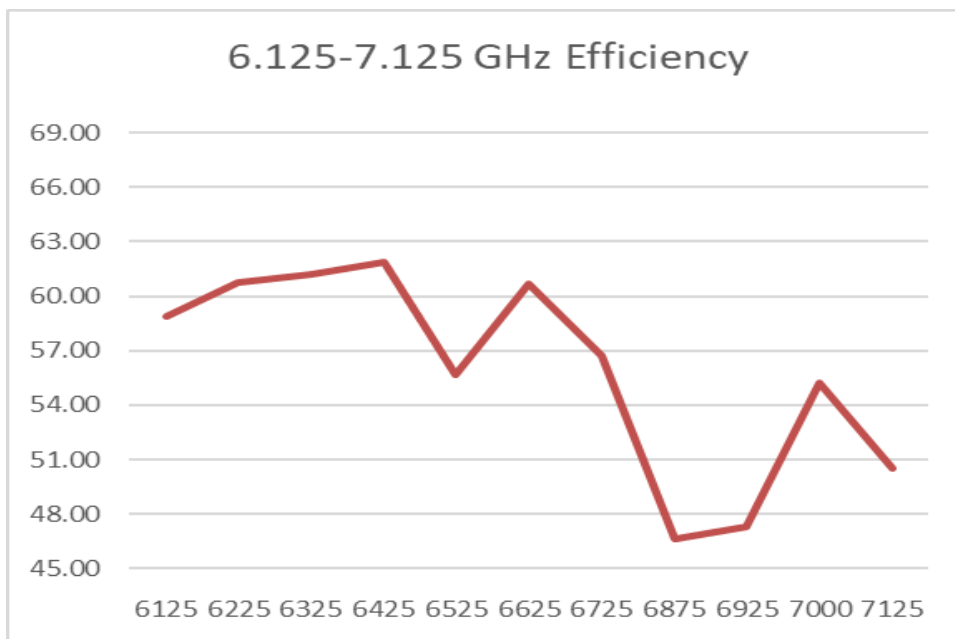
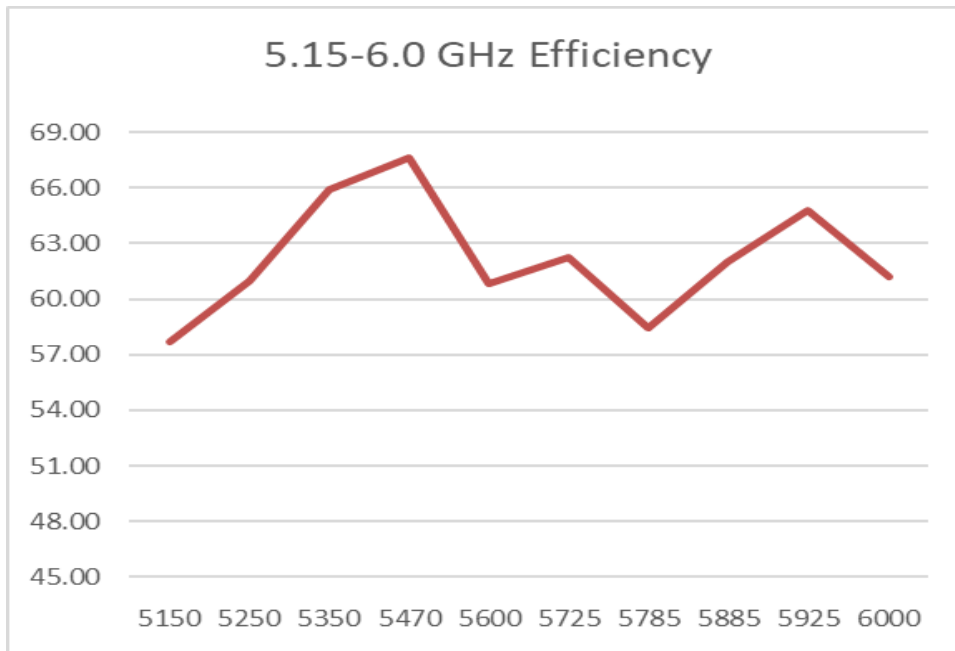

Frequency (MHz)	2400	2500	5150	5885	6125	7125
Efficiency (%)	53.13	62.23	57.67	62.05	58.92	50.49

- Gain

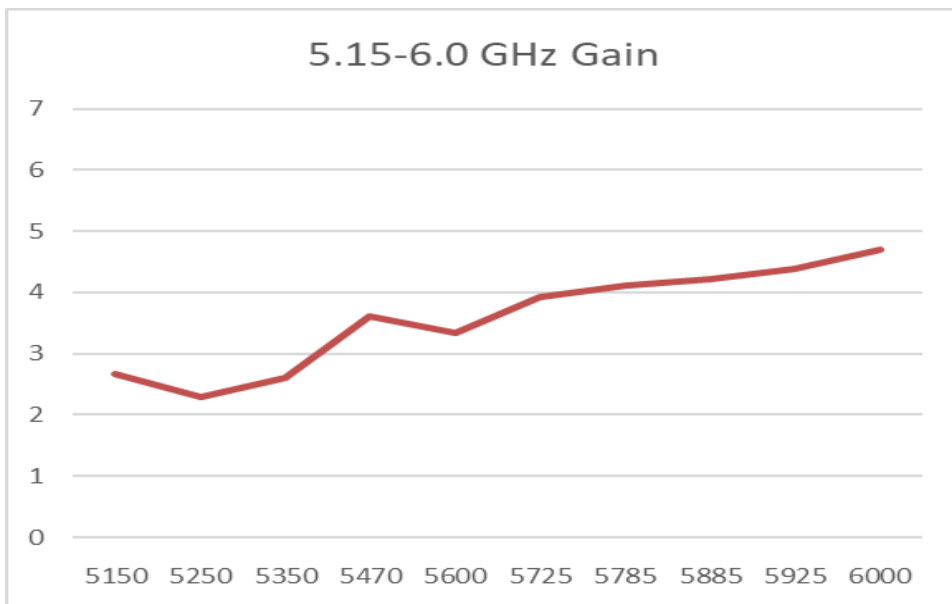
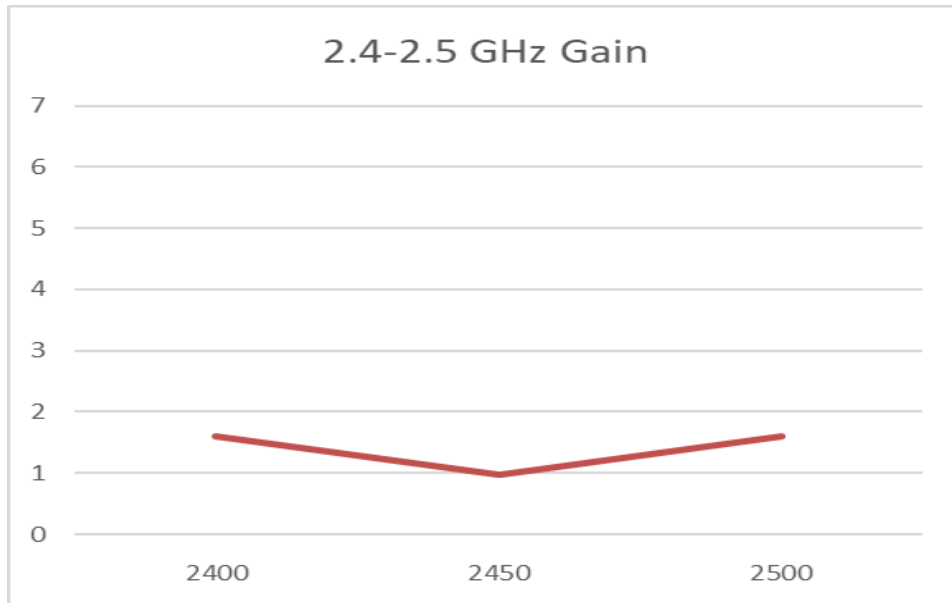

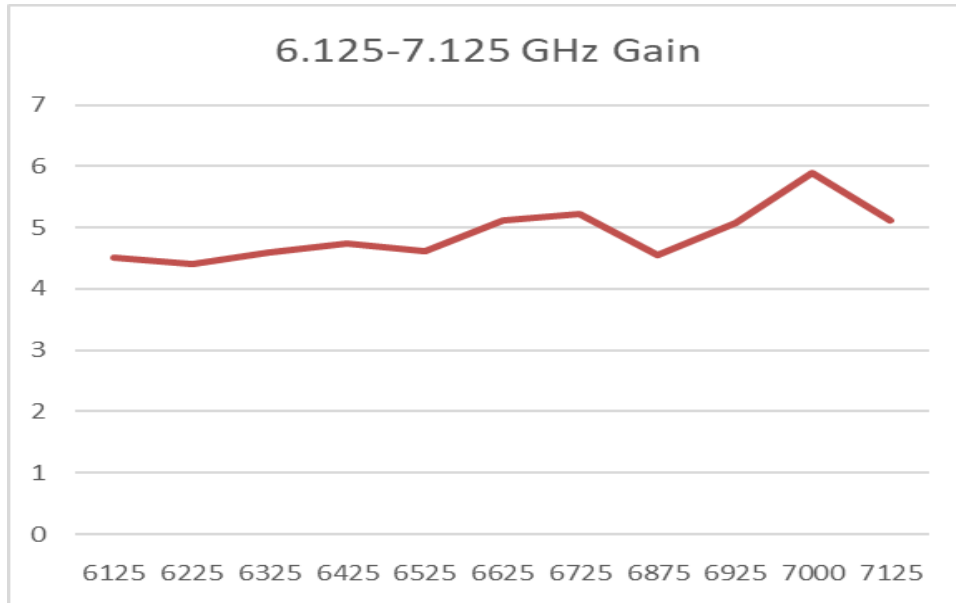

Frequency (MHz)	2400-2483.5	5150-5250	5250-5350	5470-5725	5725-5885	5925-6425	6425-6525	6525-6875	6875-7125
Peak Gain (dBi)	1.61	2.66	2.61	3.93	4.22	4.74	4.74	5.23	5.89

4.3. Radiation Pattern-WIFI



2400 MHz

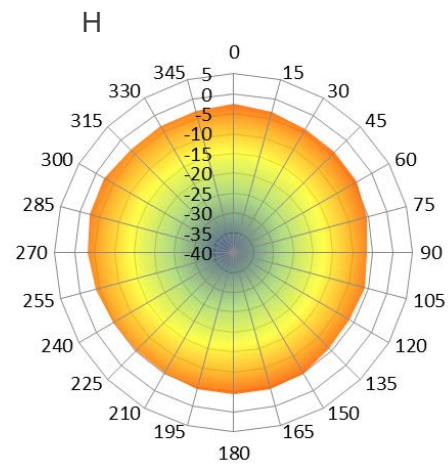
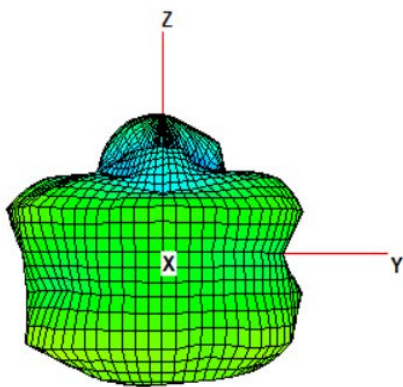

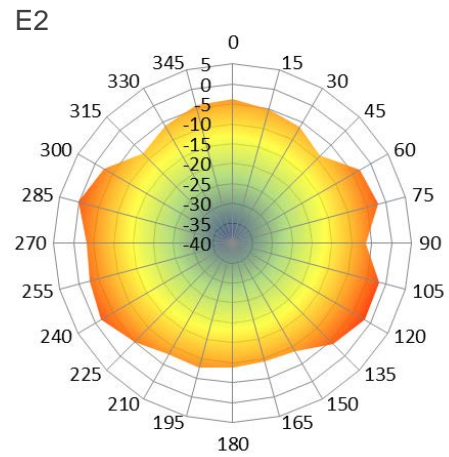
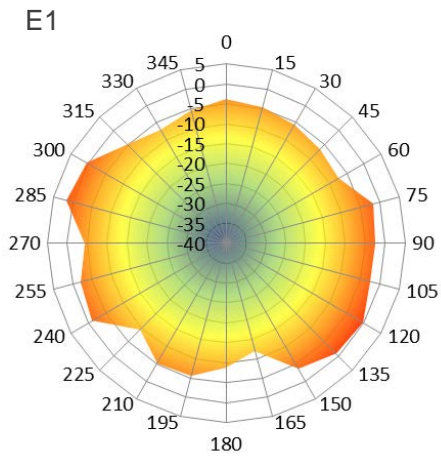

2500 MHz

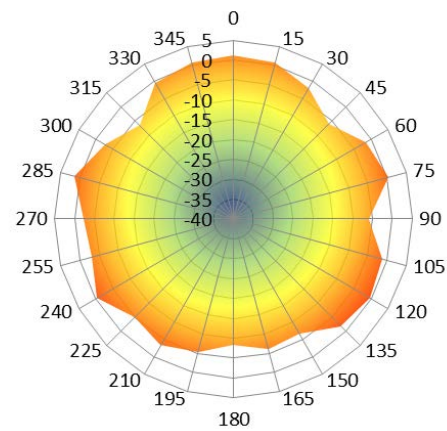
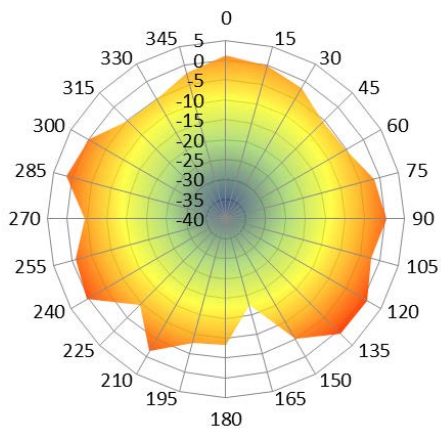
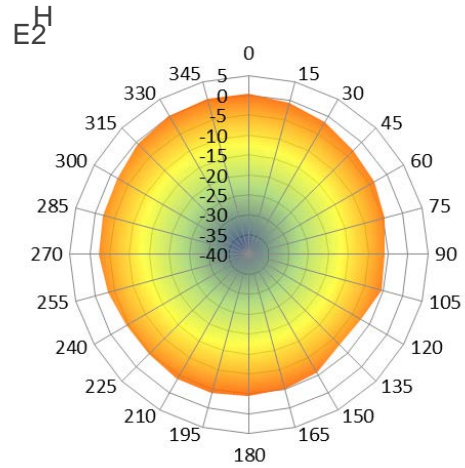
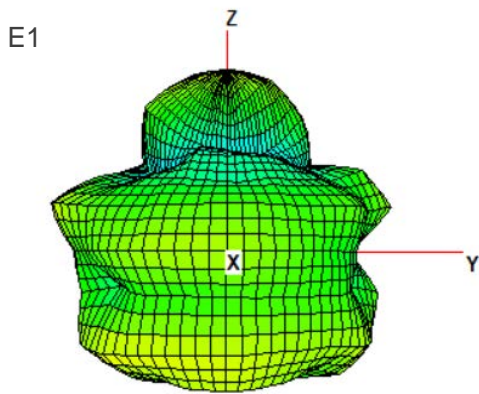

5150 MHz

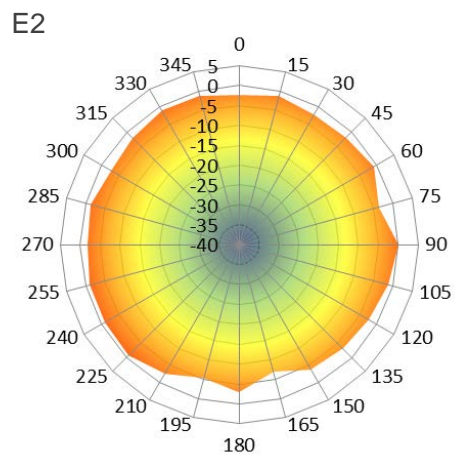
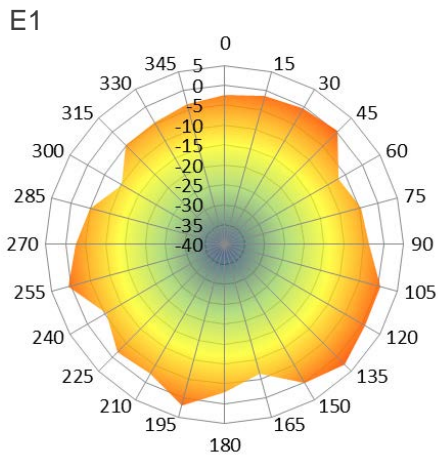
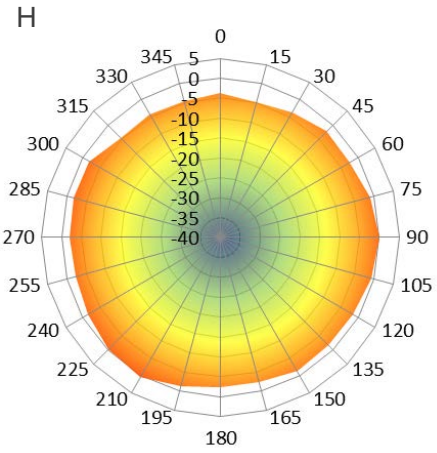
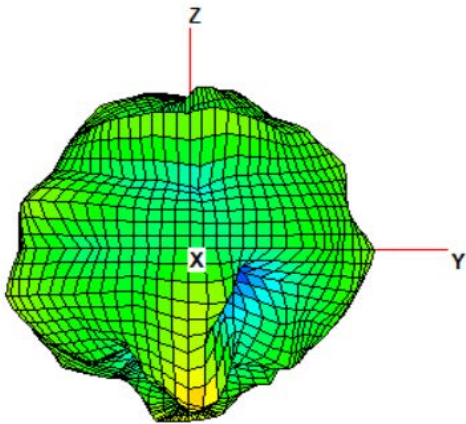

5350 MHz

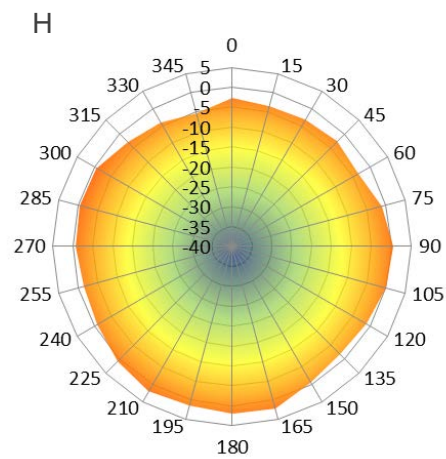
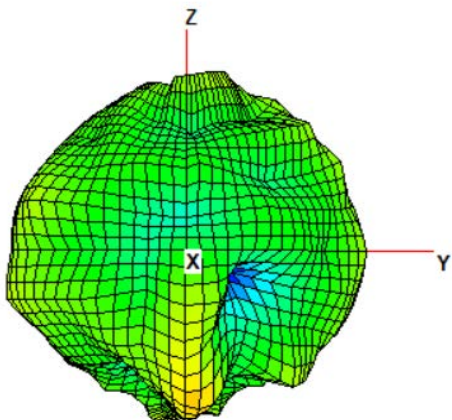

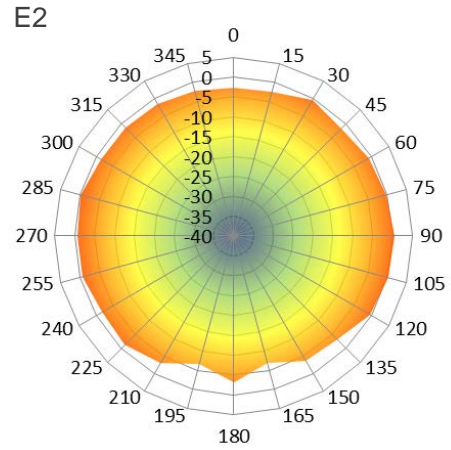
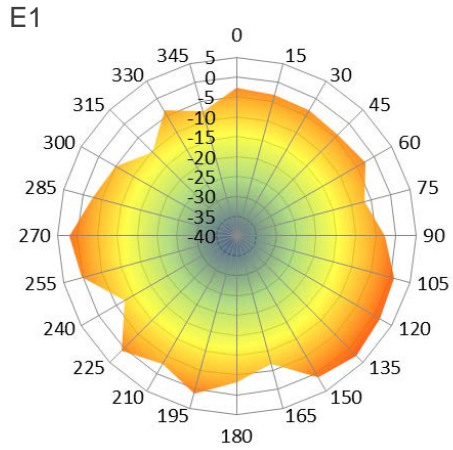

5725 MHz

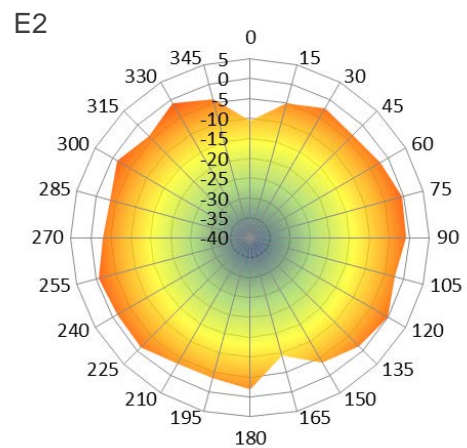
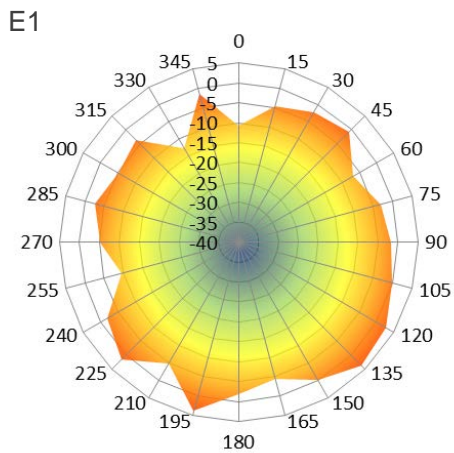
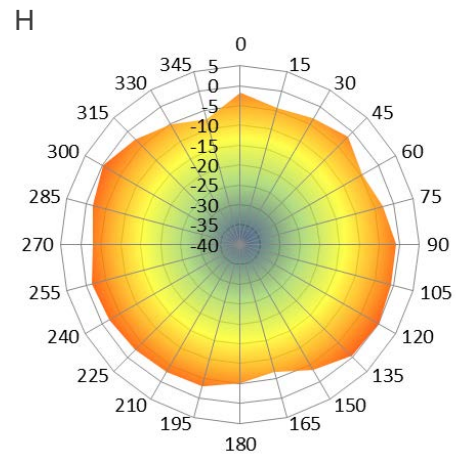
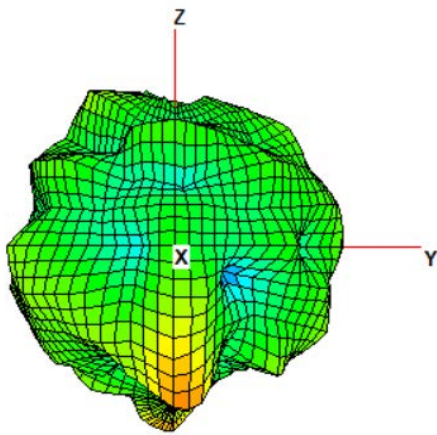

5850 MHz

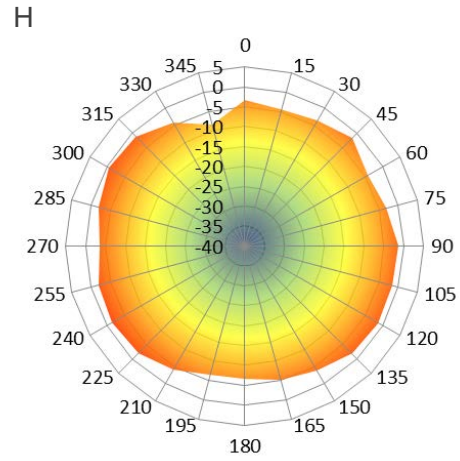
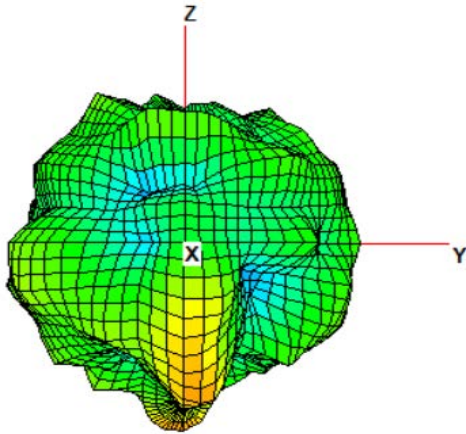

E1

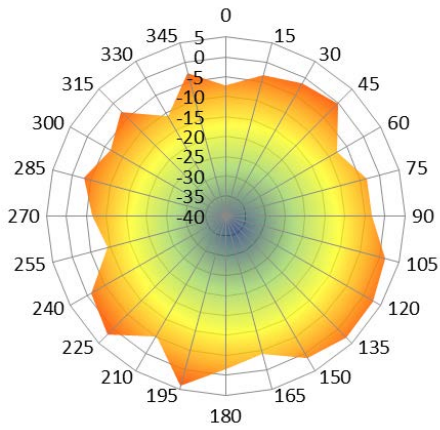

E2

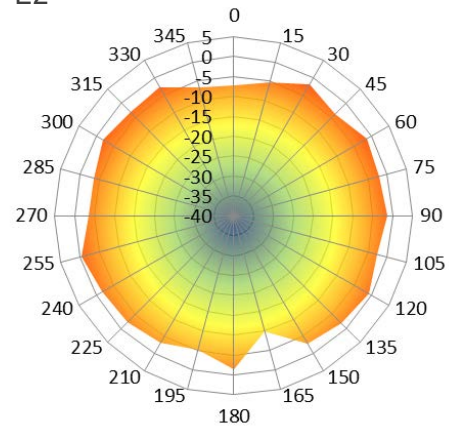

5925MHz

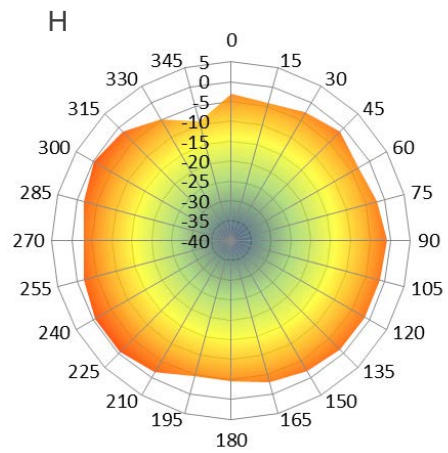
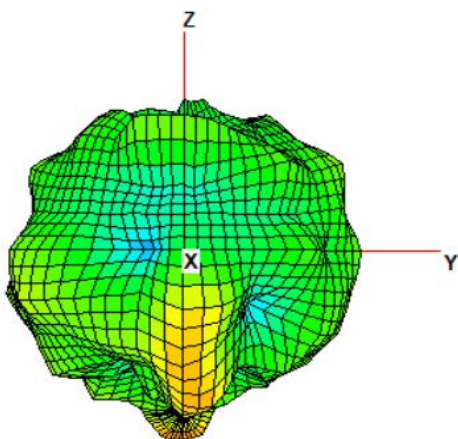

E1

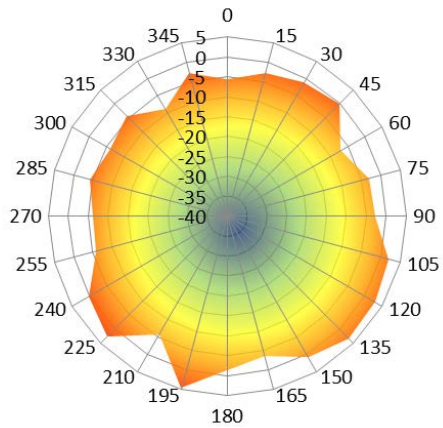

E2

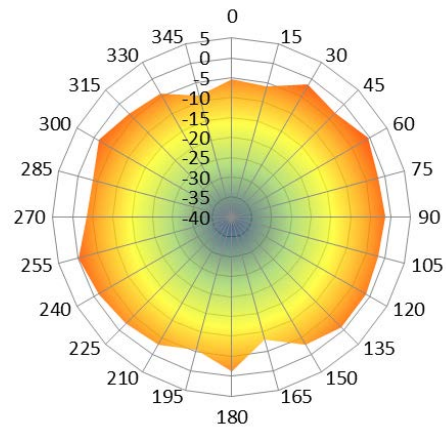

6425MHz

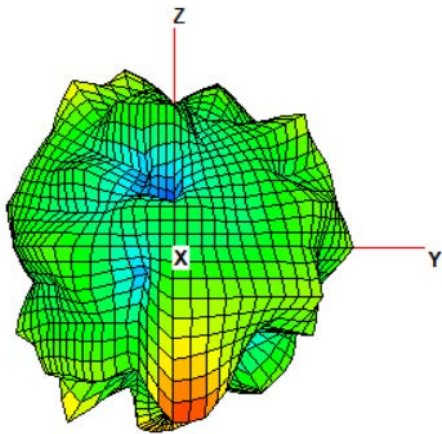

H

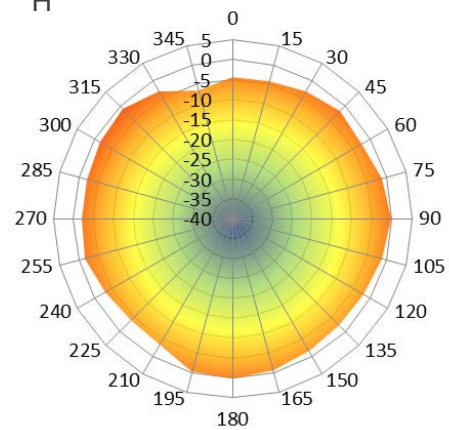

E1

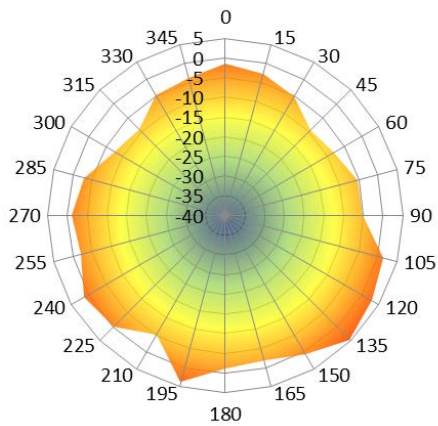

E2

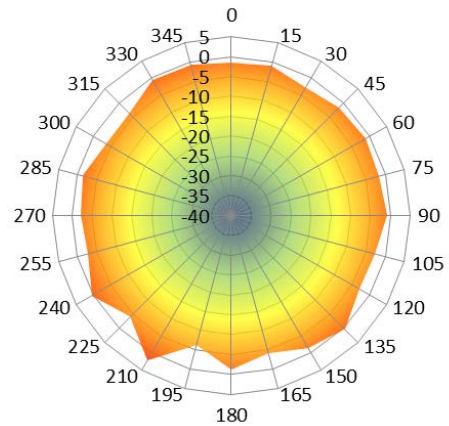

6725MHz

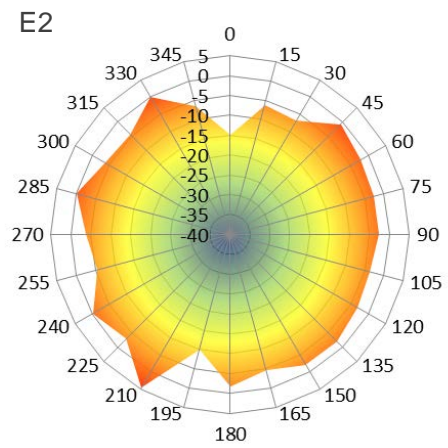
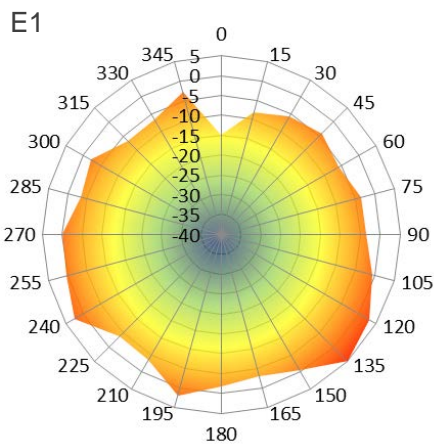
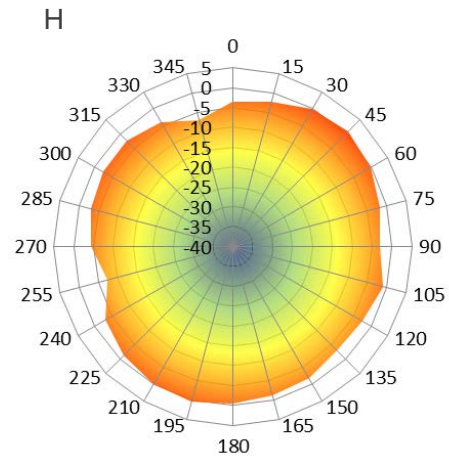
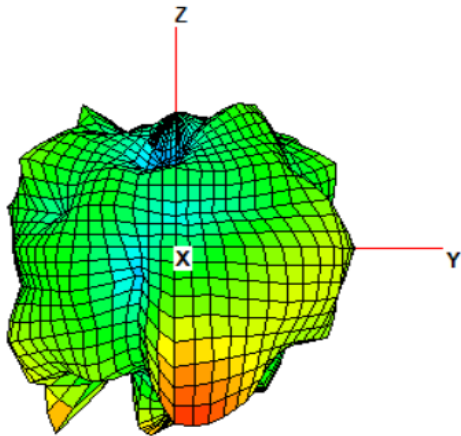

7000MHz

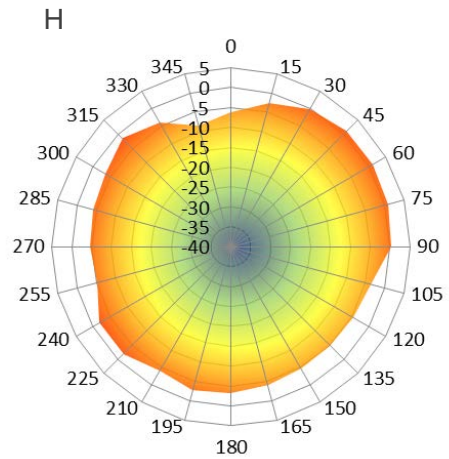
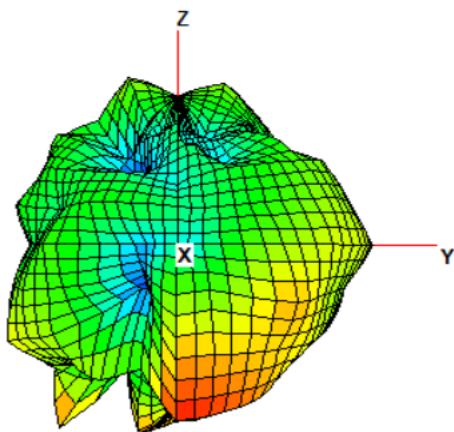

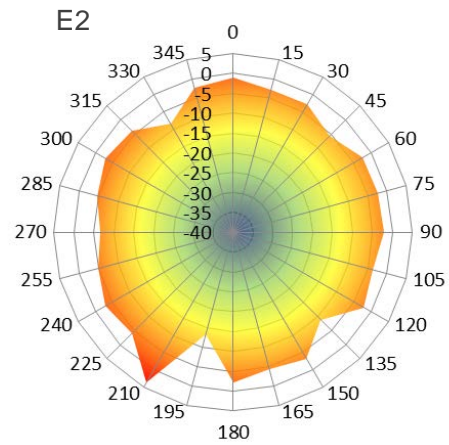
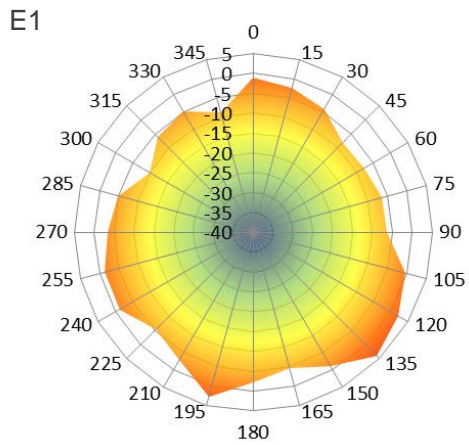

5 Product Size

RoHS

