

Report No.: XEWA2302000005RG03  
 Rev.: 01  
 Page: 1 of 305

# TEST REPORT

**Application No.:** XEWA2302000005RG  
**Applicant:** Quectel Wireless Solutions Co., Ltd.  
**Address of Applicant:** Building 5, Shanghai Business Park Phase III (Area B), No.1016 Tianlin Road, Minhang District, Shanghai, China 200233  
**Manufacturer:** Quectel Wireless Solutions Co., Ltd.  
**Address of Manufacturer:** Building 5, Shanghai Business Park Phase III (Area B), No.1016 Tianlin Road, Minhang District, Shanghai, China 200233  
**EUT Description:** Wi-Fi & Bluetooth Module  
**Model No.:** FC66E-B  
**Trade Mark:** Quectel  
**FCC ID:** XMR2023FC66EB  
**Standards:** FCC 47 CFR Part 2, Subpart J  
 FCC 47 CFR Part 15, Subpart C  
**Date of Receipt:** 2023/03/03  
**Date of Test:** 2023/03/22 to 2023/05/06  
**Date of Issue:** 2023/05/06

<b>Test Result :</b>	<b>PASS *</b>
----------------------	---------------

\* In the configuration tested, the EUT detailed in this report complied with the standards specified above.

Authorized Signature:



Peter Tan  
 Regulatory Technical Manager



Unless otherwise agreed in writing, this document is issued by the Company subject to its General Conditions of Service printed overleaf, available on request or accessible at <http://www.sgs.com/en/Terms-and-Conditions.aspx> and, for electronic format documents, subject to Terms and Conditions for Electronic Documents at <http://www.sgs.com/en/Terms-and-Conditions/Terms-e-Documents.aspx>. Attention is drawn to the limitation of liability, indemnification and jurisdiction issues defined therein. Any holder of this document is advised that information contained hereon reflects the Company's findings at the time of its intervention only and within the limits of Client's instructions, if any. The Company's sole responsibility is to its Client and this document does not exonerate parties to a transaction from exercising all their rights and obligations under the transaction documents. This document cannot be reproduced except in full, without prior written approval of the Company. Any unauthorized alteration, forgery or falsification of the content or appearance of this document is unlawful and offenders may be prosecuted to the fullest extent of the law. Unless otherwise stated the results shown in this test report refer only to the sample(s) tested and such sample(s) are retained for 30 days only.  
 Attention: To check the authenticity of testing/inspection report & certificate, please contact us at telephone: (86-755) 8307 1443, or email: [CN.Doccheck@sgs.com](mailto:CN.Doccheck@sgs.com)  
 1/F, Unit D, Building 1, Kanghong Orange Science Park, No.137, Keyuan 3rd Road, Fengdong New Town, Xi'an, Shaanxi, China 710086 t (86-29) 6282 7885 www.sgs.com.cn  
 中国·西安·沣东新城科源三路137号康鸿橙方科技园1号楼D单元1层 邮编: 710086 t (86-29) 6282 7885 sgs.china@sgs.com

# 1 Version

Revision Record				
Version	Chapter	Date	Modifier	Remark
01		2023/05/06		Original

<b>Prepared By</b>	 <hr/> (Leah Chen) / Test Engineer
<b>Checked By</b>	 <hr/> (Andy Yao) / Reviewer



Unless otherwise agreed in writing, this document is issued by the Company subject to its General Conditions of Service printed overleaf, available on request or accessible at <http://www.sgs.com/en/Terms-and-Conditions.aspx> and, for electronic format documents, subject to Terms and Conditions for Electronic Documents at <http://www.sgs.com/en/Terms-and-Conditions/Terms-e-Documents.aspx>. Attention is drawn to the limitation of liability, indemnification and jurisdiction issues defined therein. Any holder of this document is advised that information contained hereon reflects the Company's findings at the time of its intervention only and within the limits of Client's instructions, if any. The Company's sole responsibility is to its Client and this document does not exonerate parties to a transaction from exercising all their rights and obligations under the transaction documents. This document cannot be reproduced except in full, without prior written approval of the Company. Any unauthorized alteration, forgery or falsification of the content or appearance of this document is unlawful and offenders may be prosecuted to the fullest extent of the law. Unless otherwise stated the results shown in this test report refer only to the sample(s) tested and such sample(s) are retained for 30 days only.

Attention: To check the authenticity of testing/inspection report & certificate, please contact us at telephone: (86-755) 8307 1443, or email: [CN.Doccheck@sgs.com](mailto:CN.Doccheck@sgs.com)

SGS-CSTC Standards Technical Services (Xi'an) Co., Ltd. | 1/F, Unit D, Building 1, Kanghong Orange Science Park, No.137, Keyuan 3rd Road, Fengdong New Town, Xi'an, Shaanxi, China | 710086 | t (86-29) 6282 7885 | www.sgsgroup.com.cn  
 中国·西安·沣东新城科源三路137号康鸿橙方科技园1号楼D单元1层 | 邮编: 710086 | t (86-29) 6282 7885 | sgs.china@sgs.com

## 2 Test Summary

Test Item	FCC Rule No.	Test Method	Test Result	Result
Antenna Requirement	15.203/15.247(b)	--	Clause 4.1	PASS
AC Power Line Conducted Emission	15.207	ANSI C63.10-2020 Section 6.2	Clause 4.2	PASS
Duty Cycle	--	--	Clause 4.3	For Report Purpose
Conducted Output Power	15.247 (b)(3)	ANSI C63.10-2020 Section 11.9.1.2	Clause 4.4	PASS
DTS (6 dB) Bandwidth & 99% Occupied Bandwidth	15.247 (a)(2)	ANSI C63.10-2020 Section 11.8 Option 2 / 6.9.3	Clause 4.5	PASS
Power Spectral Density	15.247 (e)	ANSI C63.10-2020 Section 11.10.2	Clause 4.6	PASS
Band-edge for RF Conducted Emissions	15.247(d)	ANSI C63.10-2020 Section 11.11	Clause 4.7	PASS
RF Conducted Spurious Emissions	15.247(d)	ANSI C63.10-2020 Section 11.11	Clause 4.8	PASS
Radiated Spurious Emissions	15.247(d);15.205/15.209	ANSI C63.10-2020 Section 11.12	Clause 4.9	PASS
Restricted bands around fundamental frequency (Radiated Emission)	15.247(d);15.205/15.209	ANSI C63.10-2020 Section 11.12	Clause 4.10	PASS



## Contents

1	Version .....	2
2	Test Summary .....	3
3	General Information .....	5
3.1	Details of Client.....	5
3.2	Test Location .....	5
3.3	Test Facility .....	5
3.4	General Description of EUT .....	6
3.5	Test Environment and Mode .....	8
3.6	Description of Support Units .....	8
3.7	Worst-case configuration and mode.....	8
4	Test results and Measurement Data.....	9
4.1	Antenna Requirement .....	9
4.2	AC Power Line Conducted Emissions.....	11
4.3	Duty Cycle.....	15
4.4	Conducted Output Power .....	16
4.5	DTS (6 dB) Bandwidth & 99% Occupied Bandwidth .....	17
4.6	Power Spectral Density.....	18
4.7	Band-edge for RF Conducted Emissions .....	19
4.8	RF Conducted Spurious Emissions.....	20
4.9	Radiated Spurious Emissions .....	21
4.10	Restricted bands around fundamental frequency.....	25
5	Measurement Uncertainty (95% confidence levels, k=2).....	28
6	Equipment List.....	29
7	Photographs - Setup Photos.....	31



Unless otherwise agreed in writing, this document is issued by the Company subject to its General Conditions of Service printed overleaf, available on request or accessible at <http://www.sgs.com/en/Terms-and-Conditions.aspx> and, for electronic format documents, subject to Terms and Conditions for Electronic Documents at <http://www.sgs.com/en/Terms-and-Conditions/Terms-e-Documents.aspx>. Attention is drawn to the limitation of liability, indemnification and jurisdiction issues defined therein. Any holder of this document is advised that information contained hereon reflects the Company's findings at the time of its intervention only and within the limits of Client's instructions, if any. The Company's sole responsibility is to its Client and this document does not exonerate parties to a transaction from exercising all their rights and obligations under the transaction documents. This document cannot be reproduced except in full, without prior written approval of the Company. Any unauthorized alteration, forgery or falsification of the content or appearance of this document is unlawful and offenders may be prosecuted to the fullest extent of the law. Unless otherwise stated the results shown in this test report refer only to the sample(s) tested and such sample(s) are retained for 30 days only.

Attention: To check the authenticity of testing / inspection report & certificate, please contact us at telephone: (86-755) 8307 1443, or email: [CN.Doccheck@sgs.com](mailto:CN.Doccheck@sgs.com)

SGS-CSTC Standards Technical Services (Xi'an) Co., Ltd. 1/F, Unit D, Building 1, Kanghong Orange Science Park, No.137, Keyuan 3rd Road, Fengdong New Town, Xi'an, Shaanxi, China 710086 t (86-29) 6282 7885 www.sgsgroup.com.cn  
 中国·西安·沣东新城科源三路137号康鸿橙方科技园1号楼D单元1层 邮编: 710086 t (86-29) 6282 7885 sgs.china@sgs.com

Report No.: XEWA2302000005RG03

Rev.: 01

Page: 5 of 305

### 3 General Information

#### 3.1 Details of Client

Applicant:	Quectel Wireless Solutions Co., Ltd.
Address of Applicant:	Building 5, Shanghai Business Park Phase III (Area B), No.1016 Tianlin Road, Minhang District, Shanghai, China 200233
Manufacturer:	Quectel Wireless Solutions Co., Ltd.
Address of Manufacturer:	Building 5, Shanghai Business Park Phase III (Area B), No.1016 Tianlin Road, Minhang District, Shanghai, China 200233

#### 3.2 Test Location

Company:	SGS-CSTC Standards Technical Services (Xi'an) Co., Ltd.
Address:	1/F, Unit D, Building 1, Kanghong Orange Science Park, No.137, Keyuan 3rd Road, Fengdong New Town, Xi' an, Shaanxi China
Post code:	710086
Test engineer:	Qiang Zhang, Ken Liu

#### 3.3 Test Facility

The test facility is recognized, certified, or accredited by the following organizations:

**•A2LA (Certificate No. 4854.01)**

SGS-CSTC Standards Technical Services (Xi'an) Co., Ltd. is accredited by the American Association for Laboratory Accreditation(A2LA). Certificate No. 4854.01.

**• Innovation, Science and Economic Development Canada**

SGS-CSTC Standards Technical Services (Xi'an) Co., Ltd. has been recognized by ISED as an accredited testing laboratory.

CAB identifier: CN0095.

IC#: 25613.

**• FCC –Designation Number: CN1337**

SGS-CSTC Standards Technical Services (Xi'an) Co., Ltd. has been recognized as an accredited testing laboratory.

Designation Number: CN1337.

Test Firm Registration Number: 917410



Unless otherwise agreed in writing, this document is issued by the Company subject to its General Conditions of Service printed overleaf, available on request or accessible at <http://www.sgs.com/en/Terms-and-Conditions.aspx> and, for electronic format documents, subject to Terms and Conditions for Electronic Documents at <http://www.sgs.com/en/Terms-and-Conditions/Terms-e-Documents.aspx>. Attention is drawn to the limitation of liability, indemnification and jurisdiction issues defined therein. Any holder of this document is advised that information contained hereon reflects the Company's findings at the time of its intervention only and within the limits of Client's instructions, if any. The Company's sole responsibility is to its Client and this document does not exonerate parties to a transaction from exercising all their rights and obligations under the transaction documents. This document cannot be reproduced except in full, without prior written approval of the Company. Any unauthorized alteration, forgery or falsification of the content or appearance of this document is unlawful and offenders may be prosecuted to the fullest extent of the law. Unless otherwise stated the results shown in this test report refer only to the sample(s) tested and such sample(s) are retained for 30 days only.  
 Attention: To check the authenticity of testing /inspection report & certificate, please contact us at telephone: (86-755) 8307 1443, or email: [CN.Doccheck@sgs.com](mailto:CN.Doccheck@sgs.com)  
 1/F, Unit D, Building 1, Kanghong Orange Science Park, No.137, Keyuan 3rd Road, Fengdong New Town, Xi'an, Shaanxi, China 710086 t (86-29) 6282 7885 www.sgs.com.cn  
 中国·西安·沣东新城科源三路137号康鸿橙方科技园1号楼D单元1层 邮编: 710086 t (86-29) 6282 7885 sgs.china@sgs.com

### 3.4 General Description of EUT

EUT Description:	Wi-Fi & Bluetooth Module		
Model No.:	FC66E-B		
Trade Mark:	Quectel		
Hardware Version:	R1.0		
Software Version:	/		
SN:	RF Conducted	P1Q21KN17000009	
	RSE & AC power line	E1722KU07000861	
Operation Frequency:	802.11b/g/n(HT20)/ax(HE20):	2412MHz to 2462MHz	
	802.11n(HT40)/ax(HE40):	2422MHz to 2452MHz	
Modulation Type:	802.11b:	DSSS (DBPSK, DQPSK, CCK)	
	802.11g/n:	OFDM (BPSK, QPSK, 16QAM, 64QAM)	
	802.11ax:	OFDM/OFDMA (BPSK, QPSK, 16QAM, 64QAM, 256QAM, 1024QAM)	
Number of Channels:	802.11b/g/n(HT20)/ax(HE20): 11 802.11n(HT40)/ax(HE40): 7		
Channel Spacing:	5MHz		
Smart System:	<input type="checkbox"/> SISO	802.11b/g/n/ax	
	<input checked="" type="checkbox"/> MIMO	802.11n/ax: 2Tx & 2Rx	
	<input checked="" type="checkbox"/> Diversity	802.11b/g: 2Tx & 2Rx	
Antenna Type:	<input checked="" type="checkbox"/> External, <input type="checkbox"/> Integrated		
Antenna Gain:	1.32dBi(Ant0); 1.61dBi(Ant1)		
	Note: The antenna gain are derived from the gain information report provided by the manufacturer.		
RF Cable:	1.2dB		
Remark:	As above information is provided and confirmed by the applicant. SGS is not liable to the accuracy, suitability, reliability or/and integrity of the information.		

Antenna Information				
	Brand Name	Model Name	Peak Gain	Type
Ant 0	HIGH-TEK HARNESS ENTERPRISE	F7G280	1.32dBi	PIFA Antenna
Ant 1	HIGH-TEK HARNESS ENTERPRISE	F7G250	1.61dBi	PIFA Antenna



Operation Frequency of each channel (802.11b/g/n HT20 /ax HE20)							
Channel	Frequency	Channel	Frequency	Channel	Frequency	Channel	Frequency
1	2412MHz	4	2427MHz	7	2442MHz	10	2457MHz
2	2417MHz	5	2432MHz	8	2447MHz	11	2462MHz
3	2422MHz	6	2437MHz	9	2452MHz		

Operation Frequency of each channel (802.11n HT40/ax HE40)							
Channel	Frequency	Channel	Frequency	Channel	Frequency	Channel	Frequency
3	2422MHz	6	2437MHz	9	2452MHz		
4	2427MHz	7	2442MHz				
5	2432MHz	8	2447MHz				

**Remark:**

In section 15.31(m), regards to the operating frequency range over 10 MHz, the Lowest frequency, the middle frequency, and the highest frequency of channel were selected to perform the test, and the selected channel see below:

Channel	Frequency for 802.11 b/g/n (HT20)/ax (HE20)	Frequency for 802.11n (HT40) /ax(HE40)
The Lowest channel	2412MHz	2422MHz
The Middle channel	2437MHz	2437MHz
The Highest channel	2462MHz	2452MHz



Unless otherwise agreed in writing, this document is issued by the Company subject to its General Conditions of Service printed overleaf, available on request or accessible at <http://www.sgs.com/en/Terms-and-Conditions.aspx> and, for electronic format documents, subject to Terms and Conditions for Electronic Documents at <http://www.sgs.com/en/Terms-and-Conditions/Terms-e-Documents.aspx>. Attention is drawn to the limitation of liability, indemnification and jurisdiction issues defined therein. Any holder of this document is advised that information contained hereon reflects the Company's findings at the time of its intervention only and within the limits of Client's instructions, if any. The Company's sole responsibility is to its Client and this document does not exonerate parties to a transaction from exercising all their rights and obligations under the transaction documents. This document cannot be reproduced except in full, without prior written approval of the Company. Any unauthorized alteration, forgery or falsification of the content or appearance of this document is unlawful and offenders may be prosecuted to the fullest extent of the law. Unless otherwise stated the results shown in this test report refer only to the sample(s) tested and such sample(s) are retained for 30 days only.

### 3.5 Test Environment and Mode

<b>Environment Parameter</b>	96~101 kPa Selected Values During Tests	
<b>Relative Humidity</b>	40-60 % RH Ambient	
<b>Value</b>	<b>Temperature(°C)</b>	<b>Voltage(V)</b>
NTNV	22~25	2.0
Remark: NV: Normal Voltage NT: Normal Temperature		

### 3.6 Description of Support Units

Description	Manufacturer	Model No.
Mother board	Quectel	5G-EVB Q1-A7138
Adapter	Shenzhen Keyu Power Supply Technology Co.,Ltd	KA1801A-0503000DE
Remark: all above the information of table are provided by client.		

### 3.7 Worst-case configuration and mode

Low data rate was used to test on antenna port conducted tests and radiated spurious emissions since it has the highest maximum power. Following are the worst-case data rates set for test:

Modulation Type	SISO - Data Rate	CDD/MIMO - Data Rate
802.11b	/	2 Mbps
802.11g	/	12 Mbps
802.11n (HT 20)	/	MCS0 (13 Mbps)
802.11n (HT 40)	/	MCS0 (27 Mbps)
802.11ax (HE 20)	/	MCS0 (16 Mbps)
802.11ax (HE 40)	/	MCS0 (32 Mbps)





## 4 Test results and Measurement Data

### 4.1 Antenna Requirement

<b>Standard requirement:</b>	47 CFR Part 15C Section 15.203 /247(b)
<p>15.203 requirement:          An intentional radiator shall be designed to ensure that no antenna other than that furnished by the responsible party shall be used with the device. The use of a permanently attached antenna or of an antenna that uses a unique coupling to the intentional radiator, the manufacturer may design the unit so that a broken antenna can be replaced by the user, but the use of a standard antenna jack or electrical connector is prohibited.</p> <p>15.247(b) (4) requirement:          The conducted output power limit specified in paragraph (b) of this section is based on the use of antennas with directional gains that do not exceed 6 dBi. Except as shown in paragraph (c) of this section, if transmitting antennas of directional gain greater than 6 dBi are used, the conducted output power from the intentional radiator shall be reduced below the stated values in paragraphs (b)(1), (b)(2), and (b)(3) of this section, as appropriate, by the amount in dB that the directional gain of the antenna exceeds 6 dBi.</p>	
<p>The antenna is External Antenna on the main PCB and no consideration of replacement.          The best case gain of the antenna is 1.32dBi(Ant0); 1.61dBi(Ant1).*</p>	
<p><b>*Note:</b>  <i>The antenna gain are derived from the gain information report provided by the manufacturer.</i></p> <p><b>Remark:</b>  <i>As above information is provided and confirmed by the applicant. SGS is not liable to the accuracy, suitability, reliability or/and integrity of the information.</i></p>	



**Cyclic Delay Diversity (CDD) System:**

FCC KDB 662911 D01 Multiple Transmitter Output v02r01

If all antennas have the same gain,  $G_{ANT}$ , Directional gain =  $G_{ANT}$  + Array Gain, where Array Gain is as follows.

- For power spectral density (PSD) measurements on all devices,  
 Array Gain =  $10 \log(N_{ANT}/N_{SS} = 1)$  dB.
- For power measurements on IEEE 802.11 devices:  
 Array Gain = 0 dB (i.e., no array gain) for  $N_{ANT} \leq 4$ ;

For power, the directional gain may be calculated by using the formulas applicable to equal gain antennas with  $G_{ANT}$  set equal to the gain of the antenna having the highest gain.

For PSD, the directional gain calculation is following F)2)f)ii) of KDB 662911 D01 v02r01.

**The Power and PSD limit should be modified if the directional gain of eut is over 6dbi.**

The EUT supports CDD System.

Unequal antenna gain:

ANT Gain0 (dBi)	ANT Gain1 (dBi)	Directional gain For Power (dBi)	Directional gain For PSD (dBi)	Power Limit Reduction (dBm)	PSD Limit Reduction (dBm)
1.32	1.61	1.61	4.48	0	0

Power Limit Reduction = Directional gain – 6dBi, (Directional gain < 6dBi) =0

PSD Limit Reduction = Directional gain – 6dBi, (Directional gain < 6dBi) =0



Unless otherwise agreed in writing, this document is issued by the Company subject to its General Conditions of Service printed overleaf, available on request or accessible at <http://www.sgs.com/en/Terms-and-Conditions.aspx> and, for electronic format documents, subject to Terms and Conditions for Electronic Documents at <http://www.sgs.com/en/Terms-and-Conditions/Terms-e-Documents.aspx>. Attention is drawn to the limitation of liability, indemnification and jurisdiction issues defined therein. Any holder of this document is advised that information contained hereon reflects the Company's findings at the time of its intervention only and within the limits of Client's instructions, if any. The Company's sole responsibility is to its Client and this document does not exonerate parties to a transaction from exercising all their rights and obligations under the transaction documents. This document cannot be reproduced except in full, without prior written approval of the Company. Any unauthorized alteration, forgery or falsification of the content or appearance of this document is unlawful and offenders may be prosecuted to the fullest extent of the law. Unless otherwise stated the results shown in this test report refer only to the sample(s) tested and such sample(s) are retained for 30 days only.

## 4.2 AC Power Line Conducted Emissions

Test Requirement:	47 CFR Part 15C Section 15.207		
Test Method:	ANSI C63.10-2020 Section 6.2		
Test Frequency Range:	150kHz to 30MHz		
Receiver Setup:	RBW = 9kHz, VBW = 30kHz		
Limit:	Frequency range (MHz)	Limit (dBuV)	
		Quasi-peak	Average
	0.15-0.5	66 to 56*	56 to 46*
	0.5-5	56	46
	5-30	60	50
* Decreases with the logarithm of the frequency.			
Test Procedure:	<p>1) The mains terminal disturbance voltage test was conducted in a shielded room.</p> <p>2) The EUT was connected to AC power source through a LISN 1 (Line Impedance Stabilization Network) which provides a 50Ω/50μH + 5Ω linear impedance. The power cables of all other units of the EUT were connected to a second LISN 2, which was bonded to the ground reference plane in the same way as the LISN 1 for the unit being measured. A multiple socket outlet strip was used to connect multiple power cables to a single LISN provided the rating of the LISN was not exceeded.</p> <p>3) The tabletop EUT was placed upon a non-metallic table 0.8m above the ground reference plane. And for floor-standing arrangement, the EUT was placed on the horizontal ground reference plane,</p> <p>4) The test was performed with a vertical ground reference plane. The rear of the EUT shall be 0.4 m from the vertical ground reference plane. The vertical ground reference plane was bonded to the horizontal ground reference plane. The LISN 1 was placed 0.8 m from the boundary of the unit under test and bonded to a ground reference plane for LISNs mounted on top of the ground reference plane. This distance was between the closest points of the LISN 1 and the EUT. All other units of the EUT and associated equipment was at least 0.8 m from the LISN 2. In order to find the maximum emission, the relative positions of equipment and all of the interface cables must be changed according to ANSI C63.10-2020 on conducted measurement.</p>		



Unless otherwise agreed in writing, this document is issued by the Company subject to its General Conditions of Service printed overleaf, available on request or accessible at <http://www.sgs.com/en/Terms-and-Conditions.aspx> and, for electronic format documents, subject to Terms and Conditions for Electronic Documents at <http://www.sgs.com/en/Terms-and-Conditions/Terms-e-Documents.aspx>. Attention is drawn to the limitation of liability, indemnification and jurisdiction issues defined therein. Any holder of this document is advised that information contained hereon reflects the Company's findings at the time of its intervention only and within the limits of Client's instructions, if any. The Company's sole responsibility is to its Client and this document does not exonerate parties to a transaction from exercising all their rights and obligations under the transaction documents. This document cannot be reproduced except in full, without prior written approval of the Company. Any unauthorized alteration, forgery or falsification of the content or appearance of this document is unlawful and offenders may be prosecuted to the fullest extent of the law. Unless otherwise stated the results shown in this test report refer only to the sample(s) tested and such sample(s) are retained for 30 days only.

Attention: To check the authenticity of testing / inspection report & certificate, please contact us at telephone: (86-755) 8307 1443, or email: [CN.Doccheck@sgs.com](mailto:CN.Doccheck@sgs.com)

SGS-CSTC Standards Technical Services (Xi'an) Co., Ltd. | 1/F, Unit D, Building 1, Kanghong Orange Science Park, No.137, Keyuan 3rd Road, Fengdong New Town, Xi'an, Shaanxi, China | 710086 | t (86-29) 6282 7885 | www.sgsgroup.com.cn  
 中国·西安·沣东新城科源三路137号康鸿橙方科技园1号楼D单元1层 | 邮编: 710086 | t (86-29) 6282 7885 | sgs.china@sgs.com

<p>Test Setup:</p>	
<p>Exploratory Test Mode:</p>	<p>Transmitting with all kind of modulations, data rates at lowest, middle and highest channel. Charge + Transmitting mode.</p>
<p>Final Test Mode:</p>	<p>Refer to section 3.7 for details. Only the worst case is recorded in the report.</p>
<p>Instruments Used:</p>	<p>Refer to section 6 for details.</p>
<p>Test Results:</p>	<p>Pass</p>



Unless otherwise agreed in writing, this document is issued by the Company subject to its General Conditions of Service printed overleaf, available on request or accessible at <http://www.sgs.com/en/Terms-and-Conditions.aspx> and, for electronic format documents, subject to Terms and Conditions for Electronic Documents at <http://www.sgs.com/en/Terms-and-Conditions/Terms-e-Documents.aspx>. Attention is drawn to the limitation of liability, indemnification and jurisdiction issues defined therein. Any holder of this document is advised that information contained hereon reflects the Company's findings at the time of its intervention only and within the limits of Client's instructions, if any. The Company's sole responsibility is to its Client and this document does not exonerate parties to a transaction from exercising all their rights and obligations under the transaction documents. This document cannot be reproduced except in full, without prior written approval of the Company. Any unauthorized alteration, forgery or falsification of the content or appearance of this document is unlawful and offenders may be prosecuted to the fullest extent of the law. Unless otherwise stated the results shown in this test report refer only to the sample(s) tested and such sample(s) are retained for 30 days only.  
Attention: To check the authenticity of testing/inspection report & certificate, please contact us at telephone: (86-755) 8307 1443, or email: [CN.Doccheck@sgs.com](mailto:CN.Doccheck@sgs.com)

SGS-CSTC Standards Technical Services (Xi'an) Co., Ltd. 1/F, Unit D, Building 1, Kanghong Orange Science Park, No.137, Keyuan 3rd Road, Fengdong New Town, Xi'an, Shaanxi, China 710086 t (86-29) 6282 7885 www.sgsgroup.com.cn  
中国·西安·沣东新城科源三路137号康鸿橙方科技园1号楼D单元1层 邮编: 710086 t (86-29) 6282 7885 sgs.china@sgs.com

Measurement Data

An initial pre-scan was performed on the live and neutral lines with peak detector. Quasi-Peak and Average measurement were performed at the frequencies with maximized peak emission were detected.

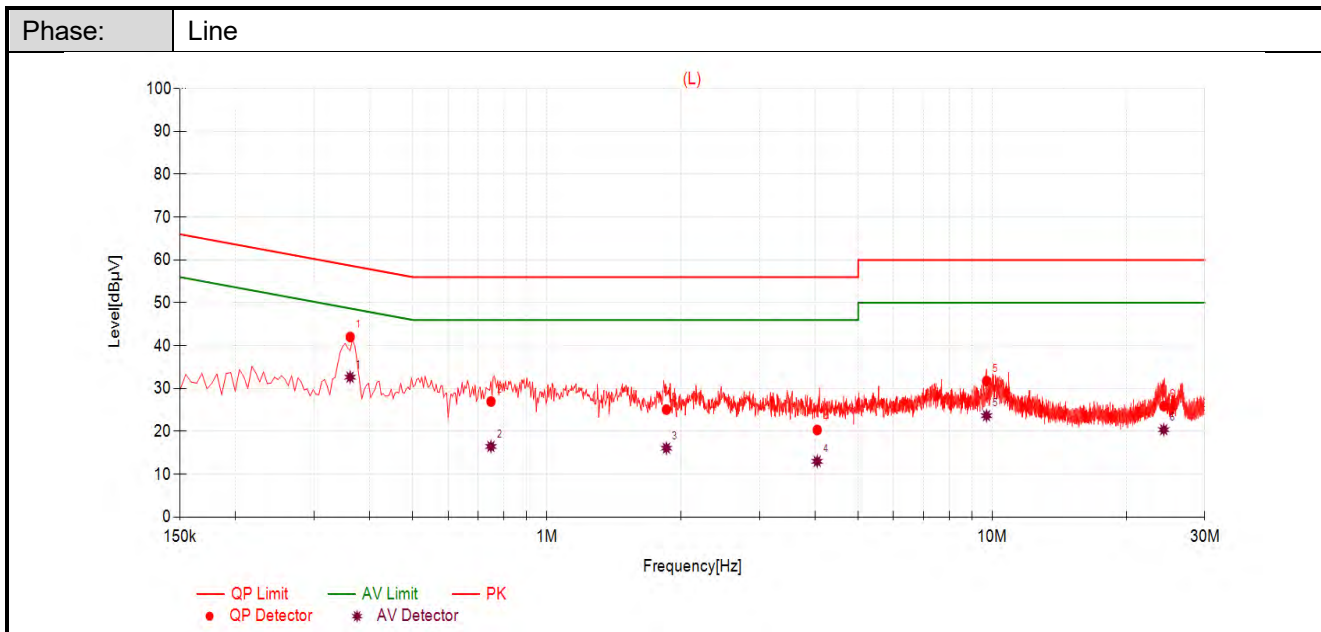

Data List											
NO.	Freq. [MHz]	Factor [dB]	QP Reading [dBµV]	QP Value [dBµV]	QP Limit [dBµV]	QP Margin [dB]	AV Reading [dBµV]	AV Value [dBµV]	AV Limit [dBµV]	AV Margin [dB]	Verdict
1	0.3615	9.87	32.16	42.03	58.69	16.66	22.79	32.66	48.69	16.03	PASS
2	0.7487	9.93	17.05	26.98	56.00	29.02	6.56	16.49	46.00	29.51	PASS
3	1.8547	9.85	15.25	25.10	56.00	30.90	6.23	16.08	46.00	29.92	PASS
4	4.0446	9.83	10.51	20.34	56.00	35.66	3.19	13.02	46.00	32.98	PASS
5	9.7084	9.92	21.83	31.75	60.00	28.25	13.74	23.66	50.00	26.34	PASS
6	24.2726	10.27	15.65	25.92	60.00	34.08	10.13	20.40	50.00	29.60	PASS

Remark:  
 1. The following Quasi-Peak and Average measurements were performed on the EUT:  
 2. Value = Reading[dBµV] + Factor(Lisn factor[dB] + cable loss[dB]).  
 3. Margin = Limit[dBµV] – Value[dBµV]



Unless otherwise agreed in writing, this document is issued by the Company subject to its General Conditions of Service printed overleaf, available on request or accessible at <http://www.sgs.com/en/Terms-and-Conditions.aspx> and, for electronic format documents, subject to Terms and Conditions for Electronic Documents at <http://www.sgs.com/en/Terms-and-Conditions/Terms-e-Documents.aspx>. Attention is drawn to the limitation of liability, indemnification and jurisdiction issues defined therein. Any holder of this document is advised that information contained hereon reflects the Company's findings at the time of its intervention only and within the limits of Client's instructions, if any. The Company's sole responsibility is to its Client and this document does not exonerate parties to a transaction from exercising all their rights and obligations under the transaction documents. This document cannot be reproduced except in full, without prior written approval of the Company. Any unauthorized alteration, forgery or falsification of the content or appearance of this document is unlawful and offenders may be prosecuted to the fullest extent of the law. Unless otherwise stated the results shown in this test report refer only to the sample(s) tested and such sample(s) are retained for 30 days only.  
 Attention: To check the authenticity of testing / inspection report & certificate, please contact us at telephone: (86-755) 8307 1443, or email: CN.Doccheck@sgs.com  
 SGS-CSTC Standards Technical Services (Xi'an) Co., Ltd. 1/F, Unit D, Building 1, Kanghong Orange Science Park, No.137, Keyuan 3rd Road, Fengdong New Town, Xi'an, Shaanxi, China 710086 t (86-29) 6282 7885 www.sgs.com.cn  
 中国·西安·沣东新城科源三路137号康鸿橙方科技园1号楼D单元1层 邮编: 710086 t (86-29) 6282 7885 sgs.china@sgs.com

Phase: Neutral

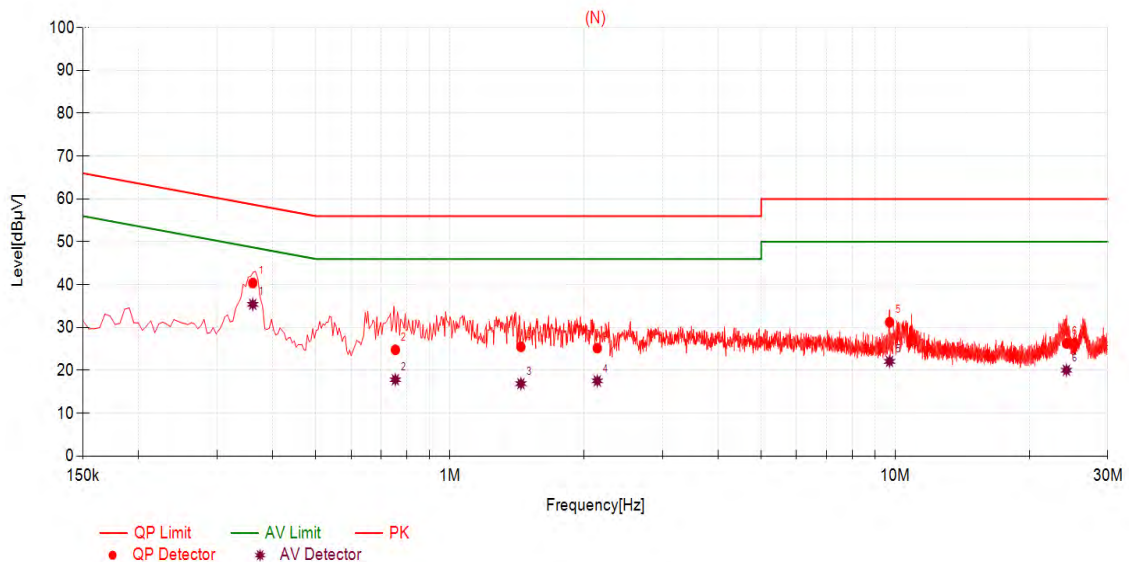

Data List											
NO.	Freq. [MHz]	Factor [dB]	QP Reading [dBµV]	QP Value [dBµV]	QP Limit [dBµV]	QP Margin [dB]	AV Reading [dBµV]	AV Value [dBµV]	AV Limit [dBµV]	AV Margin [dB]	Verdict
1	0.3608	9.79	30.60	40.39	58.71	18.32	25.62	35.41	48.71	13.30	PASS
2	0.7542	9.83	14.98	24.81	56.00	31.19	7.99	17.82	46.00	28.18	PASS
3	1.4435	9.82	15.69	25.51	56.00	30.49	7.09	16.91	46.00	29.09	PASS
4	2.1420	9.87	15.34	25.21	56.00	30.79	7.69	17.56	46.00	28.44	PASS
5	9.7086	10.06	21.18	31.24	60.00	28.76	12.04	22.10	50.00	27.90	PASS
6	24.2286	10.29	16.02	26.31	60.00	33.69	9.75	20.04	50.00	29.96	PASS

Remark:

- The following Quasi-Peak and Average measurements were performed on the EUT:
- Value = Reading [dBµV] + Factor (Lisn factor [dB] + cable loss [dB]).
- Marginal = Limit [dBµV] – Value [dBµV]



Report No.: XEWA2302000005RG03  
Rev.: 01  
Page: 15 of 305

### 4.3 Duty Cycle

The detailed test data see: **Appendix**



Unless otherwise agreed in writing, this document is issued by the Company subject to its General Conditions of Service printed overleaf, available on request or accessible at <http://www.sgs.com/en/Terms-and-Conditions.aspx> and, for electronic format documents, subject to Terms and Conditions for Electronic Documents at <http://www.sgs.com/en/Terms-and-Conditions/Terms-e-Documents.aspx>. Attention is drawn to the limitation of liability, indemnification and jurisdiction issues defined therein. Any holder of this document is advised that information contained hereon reflects the Company's findings at the time of its intervention only and within the limits of Client's instructions, if any. The Company's sole responsibility is to its Client and this document does not exonerate parties to a transaction from exercising all their rights and obligations under the transaction documents. This document cannot be reproduced except in full, without prior written approval of the Company. Any unauthorized alteration, forgery or falsification of the content or appearance of this document is unlawful and offenders may be prosecuted to the fullest extent of the law. Unless otherwise stated the results shown in this test report refer only to the sample(s) tested and such sample(s) are retained for 30 days only.  
**Attention:** To check the authenticity of testing/inspection report & certificate, please contact us at telephone: (86-755) 8307 1443, or email: [CN.Doccheck@sgs.com](mailto:CN.Doccheck@sgs.com)

SGS-CSTC Standards Technical Services (Xi'an) Co., Ltd. 1/F, Unit D, Building 1, Kanghong Orange Science Park, No.137, Keyuan 3rd Road, Fengdong New Town, Xi'an, Shaanxi, China 710086 t (86-29) 6282 7885 www.sgsgroup.com.cn  
中国·西安·沣东新城科源三路137号康鸿橙方科技园1号楼D单元1层 邮编: 710086 t (86-29) 6282 7885 sgs.china@sgs.com

### 4.4 Conducted Output Power

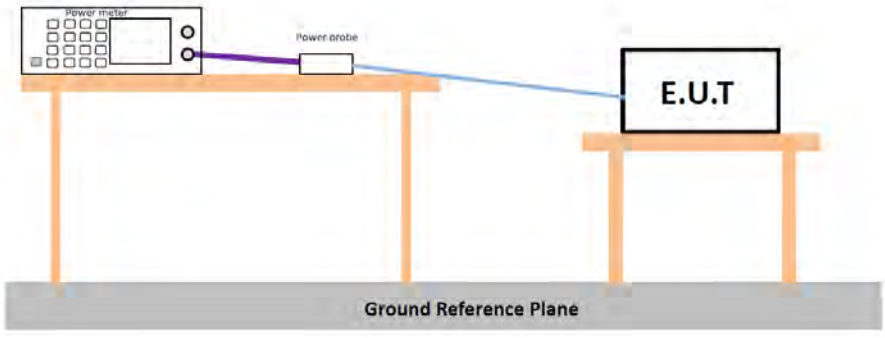
Test Requirement:	47 CFR Part 15C Section 15.247 (b)(3)
Test Method:	ANSI C63.10-2020 Section 11.9.1.2
Test Setup:	 <p>* Test with power meter (Detector function: Peak)</p>
Test Instruments:	Refer to section 6 for details.
Exploratory Test Mode:	Transmitting with all kind of modulations, data rates
Final Test Mode:	Refer to section 3.7 for details.
Limit:	30dBm
Test Results:	Pass
The detailed test data see: <b>Appendix</b>	





### 4.5 DTS (6 dB) Bandwidth & 99% Occupied Bandwidth

Test Requirement:	47 CFR Part 15C Section 15.247 (a)(2)
Test Method:	ANSI C63.10-2020 Section 11.8 Option 2 / 6.9.3
Test Setup:	
Instruments Used:	Refer to section 6 for details.
Exploratory Test Mode:	Transmitting with all kind of modulations, data rates
Final Test Mode:	Refer to section 3.7 for details.
Limit:	≥ 500 kHz
Test Results:	Pass
The detailed test data see: <b>Appendix</b>	



### 4.6 Power Spectral Density

Test Requirement:	47 CFR Part 15C Section 15.247 (e)
Test Method:	ANSI C63.10-2020 Section 11.10.2
Test Setup:	
Test Instruments:	Refer to section 6 for details.
Exploratory Test Mode:	Transmitting with all kind of modulations, data rates
Final Test Mode:	Refer to section 3.7 for details.
Limit:	≤8.00dBm/3kHz
Test Results:	Pass
The detailed test data see: <b>Appendix</b>	



### 4.7 Band-edge for RF Conducted Emissions

Test Requirement:	47 CFR Part 15C Section 15.247 (d)
Test Method:	ANSI C63.10-2020 Section 11.11
Test Setup:	
Instruments Used:	Refer to section 6 for details.
Exploratory Test Mode:	Transmitting with all kind of modulations, data rates
Final Test Mode:	Refer to section 3.7 for details.
Limit:	In any 100 kHz bandwidth outside the frequency band in which the spread spectrum intentional radiator is operating, the radio frequency power that is produced by the intentional radiator shall be at least 20 dB below that in the 100 kHz bandwidth within the band that contains the highest level of the desired power, based on either an RF conducted or a radiated measurement.
Test Results:	Pass
The detailed test data see: <b>Appendix</b>	



### 4.8 RF Conducted Spurious Emissions

Test Requirement:	47 CFR Part 15C Section 15.247 (d)
Test Method:	ANSI C63.10-2020 Section 11.11
Test Setup:	
Instruments Used:	Refer to section 6 for details.
Exploratory Test Mode:	Transmitting with all kind of modulations, data rates
Final Test Mode:	Refer to section 3.7 for details.
Limit:	In any 100 kHz bandwidth outside the frequency band in which the spread spectrum intentional radiator is operating, the radio frequency power that is produced by the intentional radiator shall be at least 20 dB below that in the 100 kHz bandwidth within the band that contains the highest level of the desired power, based on either an RF conducted or a radiated measurement.
Test Results:	Pass
The detailed test data see: <b>Appendix</b>	



### 4.9 Radiated Spurious Emissions

Test Requirement:	47 CFR Part 15C Section 15.209 and 15.205				
Test Method:	ANSI C63.10-2020 Section 11.12				
Test Site:	Measurement Distance: 3m (Semi-Anechoic Chamber)				
Test Frequency:	9kHz ~ 25GHz				
Receiver Setup:	Frequency	Detector	RBW	VBW	Remark
	0.009MHz-0.090MHz	Peak	10kHz	30kHz	Peak
	0.009MHz-0.090MHz	Average	10kHz	30kHz	Average
	0.090MHz-0.110MHz	Quasi-peak	10kHz	30kHz	Quasi-peak
	0.110MHz-0.490MHz	Peak	10kHz	30kHz	Peak
	0.110MHz-0.490MHz	Average	10kHz	30kHz	Average
	0.490MHz -30MHz	Quasi-peak	10kHz	30kHz	Quasi-peak
	30MHz-1GHz	Quasi-peak	120kHz	300kHz	Quasi-peak
Above 1GHz	Peak	1MHz	3MHz	Peak	
	Peak	1MHz	3MHz	Peak	
Limit:	Frequency	Field strength (microvolt/meter)	Limit (dBuV/m)	Remark	Measurement distance (m)
	0.009MHz-0.490MHz	2400/F(kHz)	-	-	300
	0.490MHz-1.705MHz	24000/F(kHz)	-	-	30
	1.705MHz-30MHz	30	-	-	30
	30MHz-88MHz	100	40.0	Quasi-peak	3
	88MHz-216MHz	150	43.5	Quasi-peak	3
	216MHz-960MHz	200	46.0	Quasi-peak	3
	960MHz-1GHz	500	54.0	Quasi-peak	3
	Above 1GHz	500	54.0	Average	3
<p>Remark: 15.35(b), Unless otherwise specified, the limit on peak radio frequency emissions is 20dB above the maximum permitted average emission limit applicable to the equipment under test. This peak limit applies to the total peak emission level radiated by the device.</p>					



Unless otherwise agreed in writing, this document is issued by the Company subject to its General Conditions of Service printed overleaf, available on request or accessible at <http://www.sgs.com/en/Terms-and-Conditions.aspx> and, for electronic format documents, subject to Terms and Conditions for Electronic Documents at <http://www.sgs.com/en/Terms-and-Conditions/Terms-e-Documents.aspx>. Attention is drawn to the limitation of liability, indemnification and jurisdiction issues defined therein. Any holder of this document is advised that information contained hereon reflects the Company's findings at the time of its intervention only and within the limits of Client's instructions, if any. The Company's sole responsibility is to its Client and this document does not exonerate parties to a transaction from exercising all their rights and obligations under the transaction documents. This document cannot be reproduced except in full, without prior written approval of the Company. Any unauthorized alteration, forgery or falsification of the content or appearance of this document is unlawful and offenders may be prosecuted to the fullest extent of the law. Unless otherwise stated the results shown in this test report refer only to the sample(s) tested and such sample(s) are retained for 30 days only.

Attention: To check the authenticity of testing / inspection report & certificate, please contact us at telephone: (86-755) 8307 1443, or email: [CN.Doccheck@sgs.com](mailto:CN.Doccheck@sgs.com)

SGS-CSTC Standards Technical Services (Xi'an) Co., Ltd. 1/F, Unit D, Building 1, Kanghong Orange Science Park, No.137, Keyuan 3rd Road, Fengdong New Town, Xi'an, Shaanxi, China 710086 t (86-29) 6282 7885 www.sgsgroup.com.cn  
 中国·西安·沣东新城科源三路137号康鸿橙方科技园1号楼D单元1层 邮编: 710086 t (86-29) 6282 7885 sgs.china@sgs.com

Test Setup:

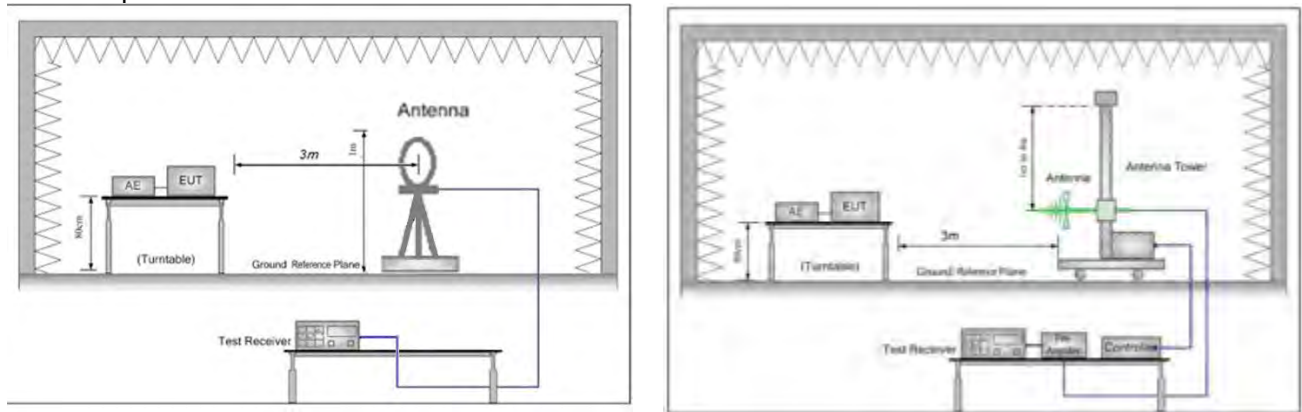

Figure 1. Below 30MHz

Figure 2. 30MHz to 1GHz

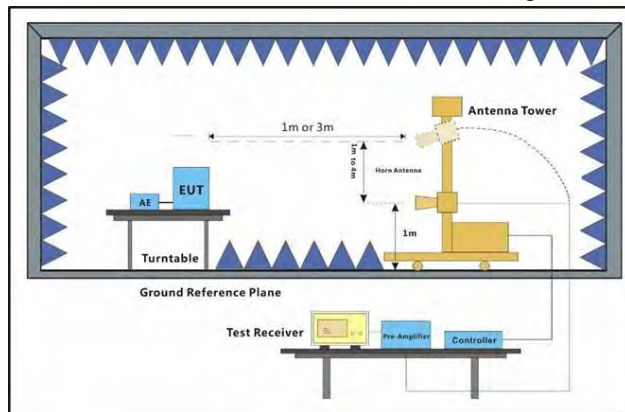

Figure 3. Above 1 GHz

Test Procedure:

- For below 1GHz, the EUT was placed on the top of a rotating table 0.8 meters above the ground at a 3 or 10 meter semi-anechoic chamber. The table was rotated 360 degrees to determine the position of the highest radiation.
- For above 1GHz, the EUT was placed on the top of a rotating table 1.5 meters above the ground at a 3 meter semi-anechoic chamber. The table was rotated 360 degrees to determine the position of the highest radiation (Distance from antenna to EUT is 1m for measurements >18GHz).
- The EUT was set 3 or 10 meters away from the interference-receiving antenna, which was mounted on the top of a variable-height antenna tower.
- The antenna height is varied from one meter to four meters above the ground to determine the maximum value of the field strength. Both horizontal and vertical polarizations of the antenna are set to make the measurement.
- For each suspected emission, the EUT was arranged to its worst case and then the antenna was tuned to heights from 1 meter to 4 meters (for the test



	<p>frequency of below 30MHz, the antenna was tuned to heights 1 meter) and the rotatable table was turned from 0 degrees to 360 degrees to find the maximum reading.</p> <p>f. The test-receiver system was set to Peak Detect Function and Specified Bandwidth with Maximum Hold Mode.</p> <p>g. Test the EUT in the lowest channel, the middle channel ,the Highest channel.</p> <p>h. The radiation measurements are performed in X, Y, Z axis positioning for Transmitting mode, And found the X axis positioning which it is worse case.</p> <p>i. Repeat above procedures until all frequencies measured was complete.</p> <p>j. The low frequency, which started from 9 kHz to 30MHz, was pre-scanned and the result which was 20dB lower than the limit line was not reported</p> <p>k. The disturbance above 18GHz was very low, and the harmonics were the highest point could be found when testing, so only the harmonics had been displayed.</p> <p>l. At a measurement distance of 1 meter the limit line was increased by <math>20 \cdot \text{LOG}(3/1) = 9.54 \text{ dB}</math>.</p>
<p>Test Configuration:</p>	<p>Measurements below 30MHz</p> <ul style="list-style-type: none"> <li>• RBW = 10 kHz</li> <li>• VBW = 30 kHz</li> <li>• Detector = Peak &amp; Average &amp; Quasi-peak</li> <li>• Trace mode = max hold</li> </ul> <p>Measurements Below 1000MHz</p> <ul style="list-style-type: none"> <li>• RBW = 120 kHz</li> <li>• VBW = 300 kHz</li> <li>• Detector = Quasi-peak</li> <li>• Trace mode = max hold</li> </ul> <p>Peak Measurements Above 1000 MHz</p> <ul style="list-style-type: none"> <li>• RBW = 1 MHz</li> <li>• VBW <math>\geq</math> 3 MHz</li> <li>• Detector = Peak</li> <li>• Sweep time = auto</li> <li>• Trace mode = max hold</li> </ul> <p>Average Measurements Above 1000MHz</p> <ul style="list-style-type: none"> <li>• RBW = 1 MHz</li> <li>• VBW = 10 Hz, when duty cycle is no less than 98 percent.</li> <li>• VBW <math>\geq</math> 1/T, when duty cycle is less than 98 percent where T is the minimum transmission duration over which the transmitter is on and is transmitting at its maximum power control level for the tested mode of operation.</li> </ul>
<p>Exploratory Test Mode:</p>	<p>Transmitting with all kind of modulations, data rates.          Charge + Transmitting mode.</p>
<p>Final Test Mode:</p>	<p>Refer to section 3.7 for details.</p>
<p>Instruments Used:</p>	<p>Refer to section 6 for details.</p>





Report No.: XEWA2302000005RG03  
Rev.: 01  
Page: 24 of 305

Test Results:	Pass
The detailed test data see: <b>Appendix</b>	



Unless otherwise agreed in writing, this document is issued by the Company subject to its General Conditions of Service printed overleaf, available on request or accessible at <http://www.sgs.com/en/Terms-and-Conditions.aspx> and, for electronic format documents, subject to Terms and Conditions for Electronic Documents at <http://www.sgs.com/en/Terms-and-Conditions/Terms-e-Documents.aspx>. Attention is drawn to the limitation of liability, indemnification and jurisdiction issues defined therein. Any holder of this document is advised that information contained hereon reflects the Company's findings at the time of its intervention only and within the limits of Client's instructions, if any. The Company's sole responsibility is to its Client and this document does not exonerate parties to a transaction from exercising all their rights and obligations under the transaction documents. This document cannot be reproduced except in full, without prior written approval of the Company. Any unauthorized alteration, forgery or falsification of the content or appearance of this document is unlawful and offenders may be prosecuted to the fullest extent of the law. Unless otherwise stated the results shown in this test report refer only to the sample(s) tested and such sample(s) are retained for 30 days only.

Attention: To check the authenticity of testing/inspection report & certificate, please contact us at telephone: (86-755) 8307 1443, or email: [CN.Doccheck@sgs.com](mailto:CN.Doccheck@sgs.com)

SGS-CSTC Standards Technical Services (Xi'an) Co., Ltd. 1/F, Unit D, Building 1, Kanghong Orange Science Park, No.137, Keyuan 3rd Road, Fengdong New Town, Xi'an, Shaanxi, China 710086 t (86-29) 6282 7885 www.sgs.com.cn  
中国·西安·沣东新城科源三路137号康鸿橙方科技园1号楼D单元1层 邮编: 710086 t (86-29) 6282 7885 sgs.china@sgs.com



### 4.10 Restricted bands around fundamental frequency

Test Requirement:	47 CFR Part 15C Section 15.209 and 15.205		
Test Method:	ANSI C63.10-2020 Section 11.12		
Test Site:	Measurement Distance: 3m (Semi-Anechoic Chamber)		
Limit:	Frequency	Limit (dBuV/m)	Remark
	30MHz-88MHz	40.0	Quasi-peak
	88MHz-216MHz	43.5	Quasi-peak
	216MHz-960MHz	46.0	Quasi-peak
	960MHz-1GHz	54.0	Quasi-peak
Above 1GHz		54.0	Average Value
		74.0	Peak Value

Test Setup:

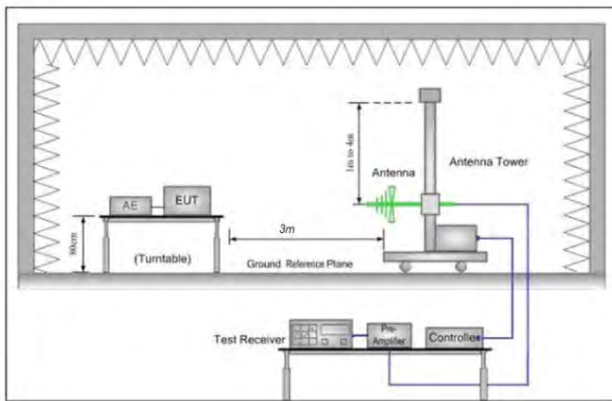

Figure 1. 30MHz to 1GHz

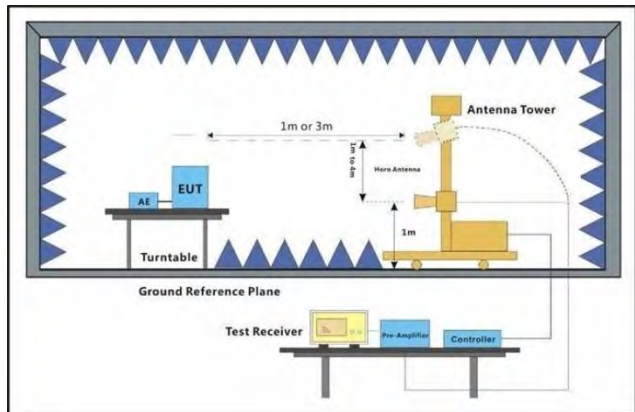

Figure 2. Above 1 GHz



<p>Test Procedure:</p>	<ol style="list-style-type: none"> <li>a. For below 1GHz, the EUT was placed on the top of a rotating table 0.8 meters above the ground at a 3 or 10 meter semi-anechoic chamber. The table was rotated 360 degrees to determine the position of the highest radiation.</li> <li>b. For above 1GHz, the EUT was placed on the top of a rotating table 1.5 meters above the ground at a 3 meter semi-anechoic chamber. The table was rotated 360 degrees to determine the position of the highest radiation.</li> <li>c. The EUT was set 3 or 10 meters away from the interference-receiving antenna, which was mounted on the top of a variable-height antenna tower.</li> <li>d. The antenna height is varied from one meter to four meters above the ground to determine the maximum value of the field strength. Both horizontal and vertical polarizations of the antenna are set to make the measurement.</li> <li>e. For each suspected emission, the EUT was arranged to its worst case and then the antenna was tuned to heights from 1 meter to 4 meters and the rotatable table was turned from 0 degrees to 360 degrees to find the maximum reading.</li> <li>f. The test-receiver system was set to Peak Detect Function and Specified Bandwidth with Maximum Hold Mode.</li> <li>g. Place a marker at the end of the restricted band closest to the transmit frequency to show compliance. Also measure any emissions in the restricted bands. Save the spectrum analyzer plot. Repeat for each power and modulation for lowest and highest channel</li> <li>h. Test the EUT in the lowest channel , the Highest channel</li> <li>i. The radiation measurements are performed in X, Y, Z axis positioning for Transmitting mode,And found the X axis positioning which it is worse case.</li> <li>j. Repeat above procedures until all frequencies measured was complete.</li> </ol>
<p>Test Configuration:</p>	<p>Measurements Below 1000MHz</p> <ul style="list-style-type: none"> <li>• RBW = 120 kHz</li> <li>• VBW = 300 kHz</li> <li>• Detector = Quasi-peak</li> <li>• Trace mode = max hold</li> </ul> <p>Peak Measurements Above 1000 MHz</p> <ul style="list-style-type: none"> <li>• RBW = 1 MHz</li> <li>• VBW ≥ 3 MHz</li> <li>• Detector = Peak</li> <li>• Sweep time = auto</li> <li>• Trace mode = max hold</li> </ul> <p>Average Measurements Above 1000MHz</p> <ul style="list-style-type: none"> <li>• RBW = 1 MHz</li> <li>• VBW = 10 Hz, when duty cycle is no less than 98 percent.</li> <li>• VBW ≥ 1/T, when duty cycle is less than 98 percent where T is the minimum transmission duration over which the transmitter is on and is transmitting at its maximum power control level for the tested mode of operation.</li> </ul>
<p>Exploratory Test Mode:</p>	<p>Transmitting with all kind of modulations, data rates.        Charge + Transmitting mode.</p>



Unless otherwise agreed in writing, this document is issued by the Company subject to its General Conditions of Service printed overleaf, available on request or accessible at <http://www.sgs.com/en/Terms-and-Conditions.aspx> and, for electronic format documents, subject to Terms and Conditions for Electronic Documents at <http://www.sgs.com/en/Terms-and-Conditions/Terms-e-Documents.aspx>. Attention is drawn to the limitation of liability, indemnification and jurisdiction issues defined therein. Any holder of this document is advised that information contained hereon reflects the Company's findings at the time of its intervention only and within the limits of Client's instructions, if any. The Company's sole responsibility is to its Client and this document does not exonerate parties to a transaction from exercising all their rights and obligations under the transaction documents. This document cannot be reproduced except in full, without prior written approval of the Company. Any unauthorized alteration, forgery or falsification of the content or appearance of this document is unlawful and offenders may be prosecuted to the fullest extent of the law. Unless otherwise stated the results shown in this test report refer only to the sample(s) tested and such sample(s) are retained for 30 days only.

Attention: To check the authenticity of testing /inspection report & certificate, please contact us at telephone: (86-755) 8307 1443, or email: [CN.Doccheck@sgs.com](mailto:CN.Doccheck@sgs.com)

SGS-CSTC Standards Technical Services (Xi'an) Co., Ltd. 1/F, Unit D, Building 1, Kangning Orange Science Park, No.137, Keyuan 3rd Road, Fengdong New Town, Xi'an, Shaanxi, China 710086 t (86-29) 6282 7885 www.sgs.com.cn  
 中国·西安·沣东新城科源三路137号康鸿橙方科技园1号楼D单元1层 邮编: 710086 t (86-29) 6282 7885 sgs.china@sgs.com

Report No.: XEWA2302000005RG03  
 Rev.: 01  
 Page: 27 of 305

Final Test Mode:	Refer to section 3.7 for details.
Instruments Used:	Refer to section 6 for details.
Test Results:	Pass
The detailed test data see: <b>Appendix</b>	



Unless otherwise agreed in writing, this document is issued by the Company subject to its General Conditions of Service printed overleaf, available on request or accessible at <http://www.sgs.com/en/Terms-and-Conditions.aspx> and, for electronic format documents, subject to Terms and Conditions for Electronic Documents at <http://www.sgs.com/en/Terms-and-Conditions/Terms-e-Documents.aspx>. Attention is drawn to the limitation of liability, indemnification and jurisdiction issues defined therein. Any holder of this document is advised that information contained hereon reflects the Company's findings at the time of its intervention only and within the limits of Client's instructions, if any. The Company's sole responsibility is to its Client and this document does not exonerate parties to a transaction from exercising all their rights and obligations under the transaction documents. This document cannot be reproduced except in full, without prior written approval of the Company. Any unauthorized alteration, forgery or falsification of the content or appearance of this document is unlawful and offenders may be prosecuted to the fullest extent of the law. Unless otherwise stated the results shown in this test report refer only to the sample(s) tested and such sample(s) are retained for 30 days only.

Attention: To check the authenticity of testing/inspection report & certificate, please contact us at telephone: (86-755) 8307 1443, or email: [CN.Doccheck@sgs.com](mailto:CN.Doccheck@sgs.com)

## 5 Measurement Uncertainty (95% confidence levels, k=2)

No.	Item	Measurement Uncertainty
1	Radio Frequency	$\pm 7.25 \times 10^{-8}$ GHz
2	Duty cycle	$\pm 0.37\%$
3	Occupied Bandwidth	$\pm 0.2\%$
4	RF conducted power	$\pm 0.21$ dB
5	RF power density	$\pm 2.84$ dB
6	Conducted Spurious emissions	$\pm 0.75$ dB
7	Conduction Emission	$\pm 3.0$ dB (150kHz to 30MHz)
8	Radiated Emission	$\pm 4.6$ dB (9kHz to 30MHz)
		$\pm 4.9$ dB (30MHz to 1GHz)
		$\pm 4.9$ dB (1GHz to 6GHz)
		$\pm 4.7$ dB (6GHz to 18GHz)
		$\pm 5.26$ dB (Above 18GHz)

**Remark:**

The  $U_{lab}$  (lab Uncertainty) is less than  $U_{CISPR/ETSI}$  (CISPR/ETSI Uncertainty), so the test results  
 – compliance is deemed to occur if no measured disturbance level exceeds the disturbance limit;  
 – non-compliance is deemed to occur if any measured disturbance level exceeds the disturbance limit.



## 6 Equipment List

RF Test System					
Test Equipment	Manufacturer	Model No.	Inventory No.	Cal. date (yyyy/mm/dd)	Cal.Due date (yyyy/mm/dd)
MXA signal analyzer	Agilent	N9020A	XAW01-06-07	2023/02/16	2024/02/15
MXG vector signal Generator	Agilent	N5182B	XAW01-07-16	2023/02/16	2024/02/15
Measurement Software	Tonscend	JS1120-3 (3.2.18)	XAW02-14-01	NCR	NCR
RF control unit	Tonscend	JS0806-2	XAW03-37-01	NCR	NCR
Power Meter	Anritsu	ML2495A	XAW01-25-03	2023/02/16	2024/02/15
Power Supply	Agilent	66311b	XAW01-17-01	2023/02/16	2024/02/15
Temperature and humidity meter	MingGao	T809	XAW01-01-16	2022/09/18	2023/09/17

CE Test System					
Test Equipment	Manufacturer	Model No.	Inventory No.	Cal. date (yyyy/mm/dd)	Cal.Due date (yyyy/mm/dd)
Shielding Room	Brilliant-emc	N/A	XAW04-03-01	N/A	N/A
Test receiver	ROHDE&SCHWARZ	ESR	XAW01-08-01	2022/09/08	2023/09/07
Artificial network	ROHDE&SCHWARZ	ENV216	XAW01-04-01	2022/06/30	2023/06/29
Temperature and humidity meter	MingGao	TH101B	XAW01-01-02	2022/09/18	2023/09/17
Measurement Software	Tonscend	TS+ V4.0.0.0	XAW02-07-01	NCR	NCR
Radio communication analyzer	ROHDE&SCHWARZ	CMW 500	XAW01-03-02	2023/02/16	2024/02/15
Artificial network	ROHDE&SCHWARZ	ENV216	XAW01-04-02	2022/06/30	2023/06/29



Report No.: XEWA2302000005RG03  
 Rev.: 01  
 Page: 30 of 305

RSE Test System					
Test Equipment	Manufacturer	Model No.	Inventory No.	Cal. date (yyyy/mm/d)	Cal. Due date (yyyy/mm/d)
Semi-Anechoic Chamber	Brilliant-emc	N/A	XAW03-35-01	2021/09/09	2024/09/08
MXA signal analyzer	Keysight	N9020A	XAW01-06-01	2023/02/16	2024/02/15
Spectrum Analyzer	ROHDE &SCHWARZ	FSV3044	XAW01-13-05	2022/05/24	2023/05/23
Test receiver	ROHDE &SCHWARZ	ESR	XAW01-08-01	2022/09/08	2023/09/07
Receiving antenna (30MHz-3GHz)	Schwarzbeck	VULB 9163	XAW01-09-01	2022/07/28	2024/07/27
Receiving antenna(1GHz~18GHz)	Schwarzbeck	BBHA 9120D	XAW01-09-02	2022/07/28	2024/07/27
Receiving antenna (15GHz~40GHz)	Schwarzbeck	BBHA 9170	XAW01-09-03	2022/07/23	2024/07/22
Directional antenna rack controller	Max-Full	MF-7802BS	XAW03-03-01	NCR	NCR
High-speed antenna rack controller	Max-Full	MF-7802	XAW03-04-01	NCR	NCR
Filter bank	Tonscend	JS0806-F	XAW03-05-01	NCR	NCR
Filter bank	Tonscend	JS0806s	XAW03-05-02	NCR	NCR
Amplifier	Tonscend	TAP9K3G32	XAW01-41-01	2022/05/24	2023/05/23
Amplifier	Tonscend	TAP01018048	XAW01-41-02	2022/09/14	2023/09/13
Amplifier	Tonscend	TAP18040048	XAW01-41-03	2022/09/14	2023/09/13
Amplifier	Shanghai Steed	YX28980930	XAW01-41-06	2022/09/14	2023/09/13
Temperature and humidity meter	MingGao	TH101B	XAW01-01-02	2022/09/18	2023/09/17
Radio communication analyzer	ROHDE&SCHWARZ	CMW 500	XAW01-03-02	2023/02/16	2024/02/15
Measurement Software	Tonscend	TS+ V4.0.0.0	XAW02-05-01	NCR	NCR
Loop Antenna	Schwarzbeck	FMZB 1519B	XAW01-48-02	2022/05/26	2023/05/25



Unless otherwise agreed in writing, this document is issued by the Company subject to its General Conditions of Service printed overleaf, available on request or accessible at <http://www.sgs.com/en/Terms-and-Conditions.aspx> and, for electronic format documents, subject to Terms and Conditions for Electronic Documents at <http://www.sgs.com/en/Terms-and-Conditions/Terms-e-Documents.aspx>. Attention is drawn to the limitation of liability, indemnification and jurisdiction issues defined therein. Any holder of this document is advised that information contained hereon reflects the Company's findings at the time of its intervention only and within the limits of Client's instructions, if any. The Company's sole responsibility is to its Client and this document does not exonerate parties to a transaction from exercising all their rights and obligations under the transaction documents. This document cannot be reproduced except in full, without prior written approval of the Company. Any unauthorized alteration, forgery or falsification of the content or appearance of this document is unlawful and offenders may be prosecuted to the fullest extent of the law. Unless otherwise stated the results shown in this test report refer only to the sample(s) tested and such sample(s) are retained for 30 days only.

Attention: To check the authenticity of testing/inspection report & certificate, please contact us at telephone: (86-755) 8307 1443, or email: [CN.Doccheck@sgs.com](mailto:CN.Doccheck@sgs.com)

SGS-CSTC Standards Technical Services (Xi'an) Co., Ltd. | 1/F, Unit D, Building 1, Kanghong Orange Science Park, No.137, Keyuan 3rd Road, Fengdong New Town, Xi'an, Shaanxi, China | 710086 | t (86-29) 6282 7885 | www.sgsgroup.com.cn  
 中国·西安·沣东新城科源三路137号康鸿橙方科技园1号楼D单元1层 | 邮编: 710086 | t (86-29) 6282 7885 | sgs.china@sgs.com

Report No.: XEWA2302000005RG03

Rev.: 01

Page: 31 of 305

## 7 Photographs - Setup Photos

Refer to Appendix A.2 WLAN Setup Photos.



Unless otherwise agreed in writing, this document is issued by the Company subject to its General Conditions of Service printed overleaf, available on request or accessible at <http://www.sgs.com/en/Terms-and-Conditions.aspx> and, for electronic format documents, subject to Terms and Conditions for Electronic Documents at <http://www.sgs.com/en/Terms-and-Conditions/Terms-e-Documents.aspx>. Attention is drawn to the limitation of liability, indemnification and jurisdiction issues defined therein. Any holder of this document is advised that information contained hereon reflects the Company's findings at the time of its intervention only and within the limits of Client's instructions, if any. The Company's sole responsibility is to its Client and this document does not exonerate parties to a transaction from exercising all their rights and obligations under the transaction documents. This document cannot be reproduced except in full, without prior written approval of the Company. Any unauthorized alteration, forgery or falsification of the content or appearance of this document is unlawful and offenders may be prosecuted to the fullest extent of the law. Unless otherwise stated the results shown in this test report refer only to the sample(s) tested and such sample(s) are retained for 30 days only.  
Attention: To check the authenticity of testing / inspection report & certificate, please contact us at telephone: (86-755) 8307 1443, or email: [CN.Doccheck@sgs.com](mailto:CN.Doccheck@sgs.com)

SGS-CSTC Standards Technical Services (Xi'an) Co., Ltd. 1/F, Unit D, Building 1, Kanghong Orange Science Park, No.137, Keyuan 3rd Road, Fengdong New Town, Xi'an, Shaanxi, China 710086 t (86-29) 6282 7885 www.sgsgroup.com.cn  
中国·西安·沣东新城科源三路137号康鸿橙方科技园1号楼D单元1层 邮编: 710086 t (86-29) 6282 7885 sgs.china@sgs.com

Report No.: XEWA2302000005RG03

Rev.: 01

Page: 32 of 305

# Appendix



Unless otherwise agreed in writing, this document is issued by the Company subject to its General Conditions of Service printed overleaf, available on request or accessible at <http://www.sgs.com/en/Terms-and-Conditions.aspx> and, for electronic format documents, subject to Terms and Conditions for Electronic Documents at <http://www.sgs.com/en/Terms-and-Conditions/Terms-e-Documents.aspx>.

Attention is drawn to the limitation of liability, indemnification and jurisdiction issues defined therein. Any holder of this document is advised that information contained hereon reflects the Company's findings at the time of its intervention only and within the limits of Client's instructions, if any. The Company's sole responsibility is to its Client and this document does not exonerate parties to a transaction from exercising all their rights and obligations under the transaction documents. This document cannot be reproduced except in full, without prior written approval of the Company. Any unauthorized alteration, forgery or falsification of the content or appearance of this document is unlawful and offenders may be prosecuted to the fullest extent of the law. Unless otherwise stated the results shown in this test report refer only to the sample(s) tested and such sample(s) are retained for 30 days only.

Attention: To check the authenticity of testing/inspection report & certificate, please contact us at telephone: (86-755) 8307 1443, or email: [CN.Doccheck@sgs.com](mailto:CN.Doccheck@sgs.com)



**DTS Bandwidth  
 Test Result**

TestMode	Antenna	Frequency[MHz]	DTS BW [MHz]	FL[MHz]	FH[MHz]	Limit[MHz]	Verdict
11b-CDD	Ant1	2412	8.320	2408.160	2416.480	0.5	PASS
	Ant0	2412	7.680	2407.920	2415.600	0.5	PASS
	Ant1	2437	8.040	2432.960	2441.000	0.5	PASS
	Ant0	2437	7.560	2432.920	2440.480	0.5	PASS
	Ant1	2462	8.040	2458.440	2466.480	0.5	PASS
	Ant0	2462	6.400	2459.160	2465.560	0.5	PASS
11g-CDD	Ant1	2412	13.800	2404.520	2418.320	0.5	PASS
	Ant0	2412	15.680	2404.440	2420.120	0.5	PASS
	Ant1	2437	15.680	2428.840	2444.520	0.5	PASS
	Ant0	2437	14.800	2429.080	2443.880	0.5	PASS
	Ant1	2462	15.280	2454.480	2469.760	0.5	PASS
	Ant0	2462	15.880	2454.240	2470.120	0.5	PASS
11n20MIMO	Ant1	2412	13.400	2403.200	2416.600	0.5	PASS
	Ant0	2412	10.680	2408.200	2418.880	0.5	PASS
	Ant1	2437	16.360	2428.200	2444.560	0.5	PASS
	Ant0	2437	15.640	2428.480	2444.120	0.5	PASS
	Ant1	2462	11.560	2454.440	2466.000	0.5	PASS
	Ant0	2462	14.480	2455.640	2470.120	0.5	PASS
11n40MIMO	Ant1	2422	33.280	2403.760	2437.040	0.5	PASS
	Ant0	2422	26.960	2410.640	2437.600	0.5	PASS
	Ant1	2437	35.600	2418.840	2454.440	0.5	PASS
	Ant0	2437	35.440	2419.080	2454.520	0.5	PASS
	Ant1	2452	36.320	2433.840	2470.160	0.5	PASS
	Ant0	2452	35.120	2434.400	2469.520	0.5	PASS
11ax20MIMO	Ant1	2412	17.280	2402.800	2420.080	0.5	PASS
	Ant0	2412	18.080	2402.880	2420.960	0.5	PASS
	Ant1	2437	13.520	2428.560	2442.080	0.5	PASS
	Ant0	2437	17.720	2427.760	2445.480	0.5	PASS
	Ant1	2462	15.640	2454.480	2470.120	0.5	PASS
	Ant0	2462	15.680	2455.360	2471.040	0.5	PASS
11ax40MIMO	Ant1	2422	32.240	2404.800	2437.040	0.5	PASS
	Ant0	2422	36.160	2403.440	2439.600	0.5	PASS
	Ant1	2437	35.680	2418.760	2454.440	0.5	PASS
	Ant0	2437	34.160	2419.080	2453.240	0.5	PASS
	Ant1	2452	36.160	2434.800	2470.960	0.5	PASS
	Ant0	2452	37.760	2433.120	2470.880	0.5	PASS



Unless otherwise agreed in writing, this document is issued by the Company subject to its General Conditions of Service printed overleaf, available on request or accessible at <http://www.sgs.com/en/Terms-and-Conditions.aspx> and, for electronic format documents, subject to Terms and Conditions for Electronic Documents at <http://www.sgs.com/en/Terms-and-Conditions/Terms-e-Documents.aspx>. Attention is drawn to the limitation of liability, indemnification and jurisdiction issues defined therein. Any holder of this document is advised that information contained hereon reflects the Company's findings at the time of its intervention only and within the limits of Client's instructions, if any. The Company's sole responsibility is to its Client and this document does not exonerate parties to a transaction from exercising all their rights and obligations under the transaction documents. This document cannot be reproduced except in full, without prior written approval of the Company. Any unauthorized alteration, forgery or falsification of the content or appearance of this document is unlawful and offenders may be prosecuted to the fullest extent of the law. Unless otherwise stated the results shown in this test report refer only to the sample(s) tested and such sample(s) are retained for 30 days only.

Attention: To check the authenticity of testing / inspection report & certificate, please contact us at telephone: (86-755) 8307 1443, or email: [CN.Doccheck@sgs.com](mailto:CN.Doccheck@sgs.com)

SGS-CSTC Standards Technical Services (Xi'an) Co., Ltd. 1/F, Unit D, Building 1, Kanghong Orange Science Park, No.137, Keyuan 3rd Road, Fengdong New Town, Xi'an, Shaanxi, China 710086 t (86-29) 6282 7885 www.sgs.com.cn  
 中国·西安·沣东新城科源三路137号康鸿橙方科技园1号楼D单元1层 邮编: 710086 t (86-29) 6282 7885 sgs.china@sgs.com

Report No.: XEWA2302000005RG03  
 Rev.: 01  
 Page: 34 of 305

Test Graphs



Unless otherwise agreed in writing, this document is issued by the Company subject to its General Conditions of Service printed overleaf, available on request or accessible at <http://www.sgs.com/en/Terms-and-Conditions.aspx> and, for electronic format documents, subject to Terms and Conditions for Electronic Documents at <http://www.sgs.com/en/Terms-and-Conditions/Terms-e-Documents.aspx>. Attention is drawn to the limitation of liability, indemnification and jurisdiction issues defined therein. Any holder of this document is advised that information contained hereon reflects the Company's findings at the time of its intervention only and within the limits of Client's instructions, if any. The Company's sole responsibility is to its Client and this document does not exonerate parties to a transaction from exercising all their rights and obligations under the transaction documents. This document cannot be reproduced except in full, without prior written approval of the Company. Any unauthorized alteration, forgery or falsification of the content or appearance of this document is unlawful and offenders may be prosecuted to the fullest extent of the law. Unless otherwise stated the results shown in this test report refer only to the sample(s) tested and such sample(s) are retained for 30 days only.

Attention: To check the authenticity of testing/inspection report & certificate, please contact us at telephone: (86-755) 83071443, or email: CN.Doccheck@sgs.com

SGS-CSTC Standards Technical Services (Xi'an) Co., Ltd. 1/F, Unit D, Building 1, Kanghong Orange Science Park, No.137, Keyuan 3rd Road, Fengsong New Town, Xi'an, Shaanxi, China 710086 t (86-29) 6282 7885 www.sgs.com.cn  
 中国·西安·沣东新城科源三路137号康鸿橙方科技园1号楼D单元1层 邮编: 710086 t (86-29) 6282 7885 sgs.china@sgs.com

11b-CDD Ant1 2437



11b-CDD Ant0 2437



Unless otherwise agreed in writing, this document is issued by the Company subject to its General Conditions of Service printed overleaf, available on request or accessible at <http://www.sgs.com/en/Terms-and-Conditions.aspx> and, for electronic format documents, subject to Terms and Conditions for Electronic Documents at <http://www.sgs.com/en/Terms-and-Conditions/Terms-e-Documents.aspx>. Attention is drawn to the limitation of liability, indemnification and jurisdiction issues defined therein. Any holder of this document is advised that information contained hereon reflects the Company's findings at the time of its intervention only and within the limits of Client's instructions, if any. The Company's sole responsibility is to its Client and this document does not exonerate parties to a transaction from exercising all their rights and obligations under the transaction documents. This document cannot be reproduced except in full, without prior written approval of the Company. Any unauthorized alteration, forgery or falsification of the content or appearance of this document is unlawful and offenders may be prosecuted to the fullest extent of the law. Unless otherwise stated the results shown in this test report refer only to the sample(s) tested and such sample(s) are retained for 30 days only.

Attention: To check the authenticity of testing / inspection report & certificate, please contact us at telephone: (86-755) 8307 1443, or email: [CN.Doccheck@sgs.com](mailto:CN.Doccheck@sgs.com)  
 1/F, Unit D, Building 1, Kanghong Orange Science Park, No.137, Keyuan 3rd Road, Fengdong New Town, Xi'an, Shaanxi, China 710086 t (86-29) 6282 7885 www.sgs.com.cn  
 中国·西安·沣东新城科源三路137号康鸿橙方科技园1号楼D单元1层 邮编: 710086 t (86-29) 6282 7885 sgs.china@sgs.com

11b-CDD\_Ant1\_2462



11b-CDD\_Ant0\_2462



Unless otherwise agreed in writing, this document is issued by the Company subject to its General Conditions of Service printed overleaf, available on request or accessible at <http://www.sgs.com/en/Terms-and-Conditions.aspx> and, for electronic format documents, subject to Terms and Conditions for Electronic Documents at <http://www.sgs.com/en/Terms-and-Conditions/Terms-e-Documents.aspx>. Attention is drawn to the limitation of liability, indemnification and jurisdiction issues defined therein. Any holder of this document is advised that information contained hereon reflects the Company's findings at the time of its intervention only and within the limits of Client's instructions, if any. The Company's sole responsibility is to its Client and this document does not exonerate parties to a transaction from exercising all their rights and obligations under the transaction documents. This document cannot be reproduced except in full, without prior written approval of the Company. Any unauthorized alteration, forgery or falsification of the content or appearance of this document is unlawful and offenders may be prosecuted to the fullest extent of the law. Unless otherwise stated the results shown in this test report refer only to the sample(s) tested and such sample(s) are retained for 30 days only.

Attention: To check the authenticity of testing/inspection report & certificate, please contact us at telephone: (86-755) 83071443, or email: [CN.Doccheck@sgs.com](mailto:CN.Doccheck@sgs.com)  
 V/F, Unit D, Building 1, Kanghong Orange Science Park, No.137, Keyuan 3rd Road, Fengdong New Town, Xi'an, Shaanxi, China 710086 t (86-29) 6282 7885 www.sgs.com.cn  
 中国·西安·沣东新城科源三路137号康鸿橙方科技园1号楼D单元1层 邮编: 710086 t (86-29) 6282 7885 sgs.china@sgs.com

11g-CDD Ant1 2412



11g-CDD Ant0 2412



Unless otherwise agreed in writing, this document is issued by the Company subject to its General Conditions of Service printed overleaf, available on request or accessible at <http://www.sgs.com/en/Terms-and-Conditions.aspx> and, for electronic format documents, subject to Terms and Conditions for Electronic Documents at <http://www.sgs.com/en/Terms-and-Conditions/Terms-e-Documents.aspx>. Attention is drawn to the limitation of liability, indemnification and jurisdiction issues defined therein. Any holder of this document is advised that information contained hereon reflects the Company's findings at the time of its intervention only and within the limits of Client's instructions, if any. The Company's sole responsibility is to its Client and this document does not exonerate parties to a transaction from exercising all their rights and obligations under the transaction documents. This document cannot be reproduced except in full, without prior written approval of the Company. Any unauthorized alteration, forgery or falsification of the content or appearance of this document is unlawful and offenders may be prosecuted to the fullest extent of the law. Unless otherwise stated the results shown in this test report refer only to the sample(s) tested and such sample(s) are retained for 30 days only.

11g-CDD Ant1 2437



11g-CDD Ant0 2437



Unless otherwise agreed in writing, this document is issued by the Company subject to its General Conditions of Service printed overleaf, available on request or accessible at <http://www.sgs.com/en/Terms-and-Conditions.aspx> and, for electronic format documents, subject to Terms and Conditions for Electronic Documents at <http://www.sgs.com/en/Terms-and-Conditions/Terms-e-Documents.aspx>. Attention is drawn to the limitation of liability, indemnification and jurisdiction issues defined therein. Any holder of this document is advised that information contained hereon reflects the Company's findings at the time of its intervention only and within the limits of Client's instructions, if any. The Company's sole responsibility is to its Client and this document does not exonerate parties to a transaction from exercising all their rights and obligations under the transaction documents. This document cannot be reproduced except in full, without prior written approval of the Company. Any unauthorized alteration, forgery or falsification of the content or appearance of this document is unlawful and offenders may be prosecuted to the fullest extent of the law. Unless otherwise stated the results shown in this test report refer only to the sample(s) tested and such sample(s) are retained for 30 days only.

11g-CDD Ant1\_2462



11g-CDD\_Ant0\_2462



Unless otherwise agreed in writing, this document is issued by the Company subject to its General Conditions of Service printed overleaf, available on request or accessible at <http://www.sgs.com/en/Terms-and-Conditions.aspx> and, for electronic format documents, subject to Terms and Conditions for Electronic Documents at <http://www.sgs.com/en/Terms-and-Conditions/Terms-e-Documents.aspx>. Attention is drawn to the limitation of liability, indemnification and jurisdiction issues defined therein. Any holder of this document is advised that information contained hereon reflects the Company's findings at the time of its intervention only and within the limits of Client's instructions, if any. The Company's sole responsibility is to its Client and this document does not exonerate parties to a transaction from exercising all their rights and obligations under the transaction documents. This document cannot be reproduced except in full, without prior written approval of the Company. Any unauthorized alteration, forgery or falsification of the content or appearance of this document is unlawful and offenders may be prosecuted to the fullest extent of the law. Unless otherwise stated the results shown in this test report refer only to the sample(s) tested and such sample(s) are retained for 30 days only.

Attention: To check the authenticity of testing/inspection report & certificate, please contact us at telephone: (86-755) 8307 1443, or email: [CN.Doccheck@sgs.com](mailto:CN.Doccheck@sgs.com)

11n20MIMO\_Ant1\_2412



11n20MIMO\_Ant0\_2412



Unless otherwise agreed in writing, this document is issued by the Company subject to its General Conditions of Service printed overleaf, available on request or accessible at <http://www.sgs.com/en/Terms-and-Conditions.aspx> and, for electronic format documents, subject to Terms and Conditions for Electronic Documents at <http://www.sgs.com/en/Terms-and-Conditions/Terms-e-Documents.aspx>. Attention is drawn to the limitation of liability, indemnification and jurisdiction issues defined therein. Any holder of this document is advised that information contained hereon reflects the Company's findings at the time of its intervention only and within the limits of Client's instructions, if any. The Company's sole responsibility is to its Client and this document does not exonerate parties to a transaction from exercising all their rights and obligations under the transaction documents. This document cannot be reproduced except in full, without prior written approval of the Company. Any unauthorized alteration, forgery or falsification of the content or appearance of this document is unlawful and offenders may be prosecuted to the fullest extent of the law. Unless otherwise stated the results shown in this test report refer only to the sample(s) tested and such sample(s) are retained for 30 days only.

Attention: To check the authenticity of testing / inspection report & certificate, please contact us at telephone: (86-755) 8307 1443, or email: [CN.Doccheck@sgs.com](mailto:CN.Doccheck@sgs.com)  
 1/F, Unit D, Building 1, Kanghong Orange Science Park, No.137, Keyuan 3rd Road, Fengdong New Town, Xi'an, Shaanxi, China 710086 t (86-29) 6282 7885 www.sgs.com.cn  
 中国·西安·沣东新城科源三路137号康鸿橙方科技园1号楼D单元1层 邮编: 710086 t (86-29) 6282 7885 sgs.china@sgs.com



11n20MIMO\_Ant1\_2437



11n20MIMO\_Ant0\_2437



Unless otherwise agreed in writing, this document is issued by the Company subject to its General Conditions of Service printed overleaf, available on request or accessible at <http://www.sgs.com/en/Terms-and-Conditions.aspx> and, for electronic format documents, subject to Terms and Conditions for Electronic Documents at <http://www.sgs.com/en/Terms-and-Conditions/Terms-e-Documents.aspx>. Attention is drawn to the limitation of liability, indemnification and jurisdiction issues defined therein. Any holder of this document is advised that information contained hereon reflects the Company's findings at the time of its intervention only and within the limits of Client's instructions, if any. The Company's sole responsibility is to its Client and this document does not exonerate parties to a transaction from exercising all their rights and obligations under the transaction documents. This document cannot be reproduced except in full, without prior written approval of the Company. Any unauthorized alteration, forgery or falsification of the content or appearance of this document is unlawful and offenders may be prosecuted to the fullest extent of the law. Unless otherwise stated the results shown in this test report refer only to the sample(s) tested and such sample(s) are retained for 30 days only.

11n20MIMO\_Ant1\_2462



11n20MIMO\_Ant0\_2462



Unless otherwise agreed in writing, this document is issued by the Company subject to its General Conditions of Service printed overleaf, available on request or accessible at <http://www.sgs.com/en/Terms-and-Conditions.aspx> and, for electronic format documents, subject to Terms and Conditions for Electronic Documents at <http://www.sgs.com/en/Terms-and-Conditions/Terms-e-Documents.aspx>. Attention is drawn to the limitation of liability, indemnification and jurisdiction issues defined therein. Any holder of this document is advised that information contained hereon reflects the Company's findings at the time of its intervention only and within the limits of Client's instructions, if any. The Company's sole responsibility is to its Client and this document does not exonerate parties to a transaction from exercising all their rights and obligations under the transaction documents. This document cannot be reproduced except in full, without prior written approval of the Company. Any unauthorized alteration, forgery or falsification of the content or appearance of this document is unlawful and offenders may be prosecuted to the fullest extent of the law. Unless otherwise stated the results shown in this test report refer only to the sample(s) tested and such sample(s) are retained for 30 days only.

11n40MIMO\_Ant1\_2422



11n40MIMO\_Ant0\_2422

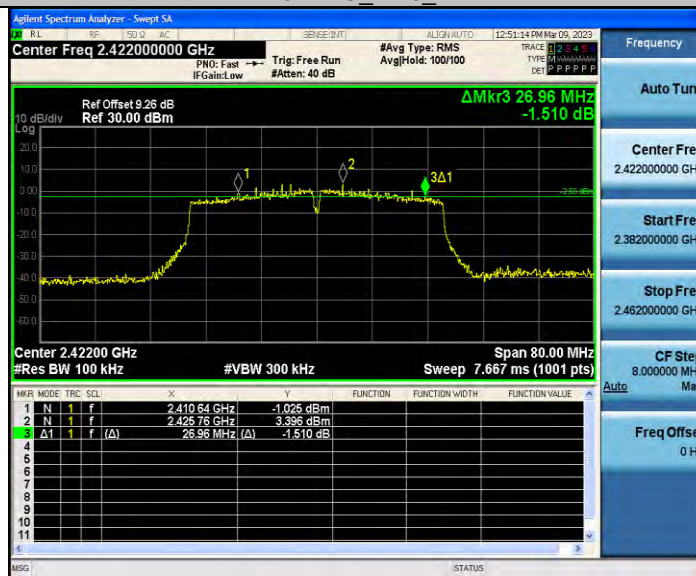

Unless otherwise agreed in writing, this document is issued by the Company subject to its General Conditions of Service printed overleaf, available on request or accessible at <http://www.sgs.com/en/Terms-and-Conditions.aspx> and, for electronic format documents, subject to Terms and Conditions for Electronic Documents at <http://www.sgs.com/en/Terms-and-Conditions/Terms-e-Documents.aspx>. Attention is drawn to the limitation of liability, indemnification and jurisdiction issues defined therein. Any holder of this document is advised that information contained hereon reflects the Company's findings at the time of its intervention only and within the limits of Client's instructions, if any. The Company's sole responsibility is to its Client and this document does not exonerate parties to a transaction from exercising all their rights and obligations under the transaction documents. This document cannot be reproduced except in full, without prior written approval of the Company. Any unauthorized alteration, forgery or falsification of the content or appearance of this document is unlawful and offenders may be prosecuted to the fullest extent of the law. Unless otherwise stated the results shown in this test report refer only to the sample(s) tested and such sample(s) are retained for 30 days only.

Attention: To check the authenticity of testing / inspection report & certificate, please contact us at telephone: (86-755) 8307 1443, or email: [CN.Doccheck@sgs.com](mailto:CN.Doccheck@sgs.com)  
 SGS-CSTC Standards Technical Services (Xi'an) Co., Ltd. | 1/F, Unit D, Building 1, Kanghong Orange Science Park, No.137, Keyuan 3rd Road, Fengdong New Town, Xi'an, Shaanxi, China | 710086 | t (86-29) 6282 7885 | www.sgs.com.cn  
 中国·西安·沣东新城科源三路137号康鸿橙方科技园1号楼D单元1层 | 邮编: 710086 | t (86-29) 6282 7885 | sgs.china@sgs.com

11n40MIMO Ant1 2437



11n40MIMO Ant0 2437



Unless otherwise agreed in writing, this document is issued by the Company subject to its General Conditions of Service printed overleaf, available on request or accessible at <http://www.sgs.com/en/Terms-and-Conditions.aspx> and, for electronic format documents, subject to Terms and Conditions for Electronic Documents at <http://www.sgs.com/en/Terms-and-Conditions/Terms-e-Documents.aspx>. Attention is drawn to the limitation of liability, indemnification and jurisdiction issues defined therein. Any holder of this document is advised that information contained hereon reflects the Company's findings at the time of its intervention only and within the limits of Client's instructions, if any. The Company's sole responsibility is to its Client and this document does not exonerate parties to a transaction from exercising all their rights and obligations under the transaction documents. This document cannot be reproduced except in full, without prior written approval of the Company. Any unauthorized alteration, forgery or falsification of the content or appearance of this document is unlawful and offenders may be prosecuted to the fullest extent of the law. Unless otherwise stated the results shown in this test report refer only to the sample(s) tested and such sample(s) are retained for 30 days only.

11n40MIMO Ant1 2452



11n40MIMO Ant0 2452



Unless otherwise agreed in writing, this document is issued by the Company subject to its General Conditions of Service printed overleaf, available on request or accessible at <http://www.sgs.com/en/Terms-and-Conditions.aspx> and, for electronic format documents, subject to Terms and Conditions for Electronic Documents at <http://www.sgs.com/en/Terms-and-Conditions/Terms-e-Documents.aspx>. Attention is drawn to the limitation of liability, indemnification and jurisdiction issues defined therein. Any holder of this document is advised that information contained hereon reflects the Company's findings at the time of its intervention only and within the limits of Client's instructions, if any. The Company's sole responsibility is to its Client and this document does not exonerate parties to a transaction from exercising all their rights and obligations under the transaction documents. This document cannot be reproduced except in full, without prior written approval of the Company. Any unauthorized alteration, forgery or falsification of the content or appearance of this document is unlawful and offenders may be prosecuted to the fullest extent of the law. Unless otherwise stated the results shown in this test report refer only to the sample(s) tested and such sample(s) are retained for 30 days only.

11ax20MIMO\_Ant1\_2412



11ax20MIMO\_Ant0\_2412



Unless otherwise agreed in writing, this document is issued by the Company subject to its General Conditions of Service printed overleaf, available on request or accessible at <http://www.sgs.com/en/Terms-and-Conditions.aspx> and, for electronic format documents, subject to Terms and Conditions for Electronic Documents at <http://www.sgs.com/en/Terms-and-Conditions/Terms-e-Documents.aspx>. Attention is drawn to the limitation of liability, indemnification and jurisdiction issues defined therein. Any holder of this document is advised that information contained hereon reflects the Company's findings at the time of its intervention only and within the limits of Client's instructions, if any. The Company's sole responsibility is to its Client and this document does not exonerate parties to a transaction from exercising all their rights and obligations under the transaction documents. This document cannot be reproduced except in full, without prior written approval of the Company. Any unauthorized alteration, forgery or falsification of the content or appearance of this document is unlawful and offenders may be prosecuted to the fullest extent of the law. Unless otherwise stated the results shown in this test report refer only to the sample(s) tested and such sample(s) are retained for 30 days only.

Attention: To check the authenticity of testing / inspection report & certificate, please contact us at telephone: (86-755) 8307 1443, or email: [CN.Doccheck@sgs.com](mailto:CN.Doccheck@sgs.com)

SGS-CSTC Standards Technical Services (Xi'an) Co., Ltd. | 1/F, Unit D, Building 1, Kanghong Orange Science Park, No.137, Keyuan 3rd Road, Fengdong New Town, Xi'an, Shaanxi, China | 710086 | t (86-29) 6282 7885 | www.sgs.com.cn  
 中国·西安·沣东新城科源三路137号康鸿橙方科技园1号楼D单元1层 | 邮编: 710086 | t (86-29) 6282 7885 | sgs.china@sgs.com

11ax20MIMO\_Ant1\_2437



11ax20MIMO\_Ant0\_2437



Unless otherwise agreed in writing, this document is issued by the Company subject to its General Conditions of Service printed overleaf, available on request or accessible at <http://www.sgs.com/en/Terms-and-Conditions.aspx> and, for electronic format documents, subject to Terms and Conditions for Electronic Documents at <http://www.sgs.com/en/Terms-and-Conditions/Terms-e-Documents.aspx>. Attention is drawn to the limitation of liability, indemnification and jurisdiction issues defined therein. Any holder of this document is advised that information contained hereon reflects the Company's findings at the time of its intervention only and within the limits of Client's instructions, if any. The Company's sole responsibility is to its Client and this document does not exonerate parties to a transaction from exercising all their rights and obligations under the transaction documents. This document cannot be reproduced except in full, without prior written approval of the Company. Any unauthorized alteration, forgery or falsification of the content or appearance of this document is unlawful and offenders may be prosecuted to the fullest extent of the law. Unless otherwise stated the results shown in this test report refer only to the sample(s) tested and such sample(s) are retained for 30 days only.

Attention: To check the authenticity of testing / inspection report & certificate, please contact us at telephone: (86-755) 8307 1443, or email: [CN.Doccheck@sgs.com](mailto:CN.Doccheck@sgs.com)

SGS-CSTC Standards Technical Services (Xi'an) Co., Ltd. | 1/F, Unit D, Building 1, Kanghong Orange Science Park, No.137, Keyuan 3rd Road, Fengdong New Town, Xi'an, Shaanxi, China | 710086 | t (86-29) 6282 7885 | [www.sgsgroup.com.cn](http://www.sgsgroup.com.cn)  
 中国·西安·沣东新城科源三路137号康鸿橙方科技园1号楼D单元1层 | 邮编: 710086 | t (86-29) 6282 7885 | [sgs.china@sgs.com](mailto:sgs.china@sgs.com)

11ax20MIMO\_Ant1\_2462



11ax20MIMO\_Ant0\_2462



Unless otherwise agreed in writing, this document is issued by the Company subject to its General Conditions of Service printed overleaf, available on request or accessible at <http://www.sgs.com/en/Terms-and-Conditions.aspx> and, for electronic format documents, subject to Terms and Conditions for Electronic Documents at <http://www.sgs.com/en/Terms-and-Conditions/Terms-e-Documents.aspx>. Attention is drawn to the limitation of liability, indemnification and jurisdiction issues defined therein. Any holder of this document is advised that information contained hereon reflects the Company's findings at the time of its intervention only and within the limits of Client's instructions, if any. The Company's sole responsibility is to its Client and this document does not exonerate parties to a transaction from exercising all their rights and obligations under the transaction documents. This document cannot be reproduced except in full, without prior written approval of the Company. Any unauthorized alteration, forgery or falsification of the content or appearance of this document is unlawful and offenders may be prosecuted to the fullest extent of the law. Unless otherwise stated the results shown in this test report refer only to the sample(s) tested and such sample(s) are retained for 30 days only.

Attention: To check the authenticity of testing/inspection report & certificate, please contact us at telephone: (86-755) 83071443, or email: [CN.Doccheck@sgs.com](mailto:CN.Doccheck@sgs.com)  
 1/F, Unit D, Building 1, Kanghong Orange Science Park, No.137, Keyuan 3rd Road, Fengdong New Town, Xi'an, Shaanxi, China 710086 t (86-29) 6282 7885 www.sgs.com.cn  
 中国·西安·沣东新城科源三路137号康鸿橙方科技园1号楼D单元1层 邮编: 710086 t (86-29) 6282 7885 sgs.china@sgs.com



11ax40MIMO\_Ant1\_2422



11ax40MIMO\_Ant0\_2422



Unless otherwise agreed in writing, this document is issued by the Company subject to its General Conditions of Service printed overleaf, available on request or accessible at <http://www.sgs.com/en/Terms-and-Conditions.aspx> and, for electronic format documents, subject to Terms and Conditions for Electronic Documents at <http://www.sgs.com/en/Terms-and-Conditions/Terms-e-Documents.aspx>. Attention is drawn to the limitation of liability, indemnification and jurisdiction issues defined therein. Any holder of this document is advised that information contained hereon reflects the Company's findings at the time of its intervention only and within the limits of Client's instructions, if any. The Company's sole responsibility is to its Client and this document does not exonerate parties to a transaction from exercising all their rights and obligations under the transaction documents. This document cannot be reproduced except in full, without prior written approval of the Company. Any unauthorized alteration, forgery or falsification of the content or appearance of this document is unlawful and offenders may be prosecuted to the fullest extent of the law. Unless otherwise stated the results shown in this test report refer only to the sample(s) tested and such sample(s) are retained for 30 days only.

Attention: To check the authenticity of testing / inspection report & certificate, please contact us at telephone: (86-755) 8307 1443, or email: [CN.Doccheck@sgs.com](mailto:CN.Doccheck@sgs.com)

SGS-CSTC Standards Technical Services (Xi'an) Co., Ltd. | Wireless Laboratory

1/F, Unit D, Building 1, Kanghong Orange Science Park, No.137, Keyuan 3rd Road, Fengdong New Town, Xi'an, Shaanxi, China | 710086 | t (86-29) 6282 7885 | www.sgs.com.cn

中国·西安·沣东新城科源三路137号康鸿橙方科技园1号楼D单元1层 | 邮编: 710086 | t (86-29) 6282 7885 | sgs.china@sgs.com

11ax40MIMO Ant1 2437



11ax40MIMO Ant0 2437



Unless otherwise agreed in writing, this document is issued by the Company subject to its General Conditions of Service printed overleaf, available on request or accessible at <http://www.sgs.com/en/Terms-and-Conditions.aspx> and, for electronic format documents, subject to Terms and Conditions for Electronic Documents at <http://www.sgs.com/en/Terms-and-Conditions/Terms-e-Documents.aspx>. Attention is drawn to the limitation of liability, indemnification and jurisdiction issues defined therein. Any holder of this document is advised that information contained hereon reflects the Company's findings at the time of its intervention only and within the limits of Client's instructions, if any. The Company's sole responsibility is to its Client and this document does not exonerate parties to a transaction from exercising all their rights and obligations under the transaction documents. This document cannot be reproduced except in full, without prior written approval of the Company. Any unauthorized alteration, forgery or falsification of the content or appearance of this document is unlawful and offenders may be prosecuted to the fullest extent of the law. Unless otherwise stated the results shown in this test report refer only to the sample(s) tested and such sample(s) are retained for 30 days only.

Attention: To check the authenticity of testing / inspection report & certificate, please contact us at telephone: (86-755) 8307 1443, or email: [CN.Doccheck@sgs.com](mailto:CN.Doccheck@sgs.com)

SGS-CSTC Standards Technical Services (Xi'an) Co., Ltd. | 1/F, Unit D, Building 1, Kanghong Orange Science Park, No.137, Keyuan 3rd Road, Fengdong New Town, Xi'an, Shaanxi, China | 710086 | t (86-29) 6282 7885 | www.sgs.com.cn  
 中国·西安·沣东新城科源三路137号康鸿橙方科技园1号楼D单元1层 | 邮编: 710086 | t (86-29) 6282 7885 | sgs.china@sgs.com

11ax40MIMO\_Ant1\_2452



11ax40MIMO\_Ant0\_2452



Unless otherwise agreed in writing, this document is issued by the Company subject to its General Conditions of Service printed overleaf, available on request or accessible at <http://www.sgs.com/en/Terms-and-Conditions.aspx> and, for electronic format documents, subject to Terms and Conditions for Electronic Documents at <http://www.sgs.com/en/Terms-and-Conditions/Terms-e-Documents.aspx>. Attention is drawn to the limitation of liability, indemnification and jurisdiction issues defined therein. Any holder of this document is advised that information contained hereon reflects the Company's findings at the time of its intervention only and within the limits of Client's instructions, if any. The Company's sole responsibility is to its Client and this document does not exonerate parties to a transaction from exercising all their rights and obligations under the transaction documents. This document cannot be reproduced except in full, without prior written approval of the Company. Any unauthorized alteration, forgery or falsification of the content or appearance of this document is unlawful and offenders may be prosecuted to the fullest extent of the law. Unless otherwise stated the results shown in this test report refer only to the sample(s) tested and such sample(s) are retained for 30 days only.

### Occupied Channel Bandwidth Test Result

TestMode	Antenna	Channel Frequency[MHz]	OCB [MHz]	FL[MHz]	FH[MHz]	Verdict
11b-CDD	Ant1	2412	13.388	2405.3734	2418.7614	For Report Purpose
	Ant0	2412	13.444	2405.3006	2418.7446	
	Ant1	2437	13.234	2430.0054	2443.2394	
	Ant0	2437	13.263	2430.2014	2443.4644	
	Ant1	2462	12.114	2456.0933	2468.2073	
	Ant0	2462	12.406	2456.1769	2468.5829	
11g-CDD	Ant1	2412	16.579	2403.5844	2420.1634	
	Ant0	2412	16.409	2403.8150	2420.2240	
	Ant1	2437	16.769	2428.5712	2445.3402	
	Ant0	2437	16.413	2428.7625	2445.1755	
	Ant1	2462	16.658	2453.7436	2470.4016	
	Ant0	2462	16.396	2453.8309	2470.2269	
11n20MIMO	Ant1	2412	17.771	2402.9864	2420.7574	
	Ant0	2412	17.654	2403.1839	2420.8379	
	Ant1	2437	17.867	2427.9985	2445.8655	
	Ant0	2437	17.622	2428.1433	2445.7653	
	Ant1	2462	17.771	2453.1882	2470.9592	
	Ant0	2462	17.615	2453.2170	2470.8320	
11n40MIMO	Ant1	2422	35.777	2403.7246	2439.5016	
	Ant0	2422	35.910	2404.0326	2439.9426	
	Ant1	2437	36.233	2418.6948	2454.9278	
	Ant0	2437	35.934	2418.9776	2454.9116	
	Ant1	2452	36.490	2433.7908	2470.2808	
	Ant0	2452	36.178	2433.9233	2470.1013	
11ax20MIMO	Ant1	2412	19.018	2402.4961	2421.5141	
	Ant0	2412	18.981	2402.4775	2421.4585	
	Ant1	2437	19.168	2427.4096	2446.5776	
	Ant0	2437	18.883	2427.5069	2446.3899	
	Ant1	2462	18.931	2452.6181	2471.5491	
	Ant0	2462	18.936	2452.5799	2471.5159	
11ax40MIMO	Ant1	2422	37.798	2402.9842	2440.7822	
	Ant0	2422	37.567	2403.2533	2440.8203	
	Ant1	2437	38.033	2417.9911	2456.0241	
	Ant0	2437	37.633	2418.1566	2455.7896	
	Ant1	2452	38.134	2432.9608	2471.0948	
	Ant0	2452	37.796	2433.0919	2470.8879	



Unless otherwise agreed in writing, this document is issued by the Company subject to its General Conditions of Service printed overleaf, available on request or accessible at <http://www.sgs.com/en/Terms-and-Conditions.aspx> and, for electronic format documents, subject to Terms and Conditions for Electronic Documents at <http://www.sgs.com/en/Terms-and-Conditions/Terms-e-Document.aspx>. Attention is drawn to the limitation of liability, indemnification and jurisdiction issues defined therein. Any holder of this document is advised that information contained hereon reflects the Company's findings at the time of its intervention only and within the limits of Client's instructions, if any. The Company's sole responsibility is to its Client and this document does not exonerate parties to a transaction from exercising all their rights and obligations under the transaction documents. This document cannot be reproduced except in full, without prior written approval of the Company. Any unauthorized alteration, forgery or falsification of the content or appearance of this document is unlawful and offenders may be prosecuted to the fullest extent of the law. Unless otherwise stated the results shown in this test report refer only to the sample(s) tested and such sample(s) are retained for 30 days only.

Attention: To check the authenticity of testing/inspection report & certificate, please contact us at telephone: (86-755) 8307 1443, or email: CN.Doccheck@sgs.com

SGS-CSTC Standards Technical Services (Xi'an) Co., Ltd. | V/F, Unit D, Building 1, Kanghong Orange Science Park, No.137, Keyuan 3rd Road, Fengdong New Town, Xi'an, Shaanxi, China | 710086 | t (86-29) 6282 7885 | www.sgs.com.cn  
 中国·西安·沣东新城科源三路137号康鸿橙方科技园1号楼D单元1层 | 邮编: 710086 | t (86-29) 6282 7885 | sgs.china@sgs.com

Report No.: XEWA2302000005RG03  
 Rev.: 01  
 Page: 53 of 305

Test Graphs



Unless otherwise agreed in writing, this document is issued by the Company subject to its General Conditions of Service printed overleaf, available on request or accessible at <http://www.sgs.com/en/Terms-and-Conditions.aspx> and, for electronic format documents, subject to Terms and Conditions for Electronic Documents at <http://www.sgs.com/en/Terms-and-Conditions/Terms-e-Documents.aspx>. Attention is drawn to the limitation of liability, indemnification and jurisdiction issues defined therein. Any holder of this document is advised that information contained hereon reflects the Company's findings at the time of its intervention only and within the limits of Client's instructions, if any. The Company's sole responsibility is to its Client and this document does not exonerate parties to a transaction from exercising all their rights and obligations under the transaction documents. This document cannot be reproduced except in full, without prior written approval of the Company. Any unauthorized alteration, forgery or falsification of the content or appearance of this document is unlawful and offenders may be prosecuted to the fullest extent of the law. Unless otherwise stated the results shown in this test report refer only to the sample(s) tested and such sample(s) are retained for 30 days only.

Attention: To check the authenticity of testing / inspection report & certificate, please contact us at telephone: (86-755) 8307 1443, or email: [CN.Doccheck@sgs.com](mailto:CN.Doccheck@sgs.com)

SGS-CSTC Standards Technical Services (Xi'an) Co., Ltd. 710086 t (86-29) 6282 7885 www.sgs.com.cn  
 1/F, Unit D, Building 1, Kanghong Orange Science Park, No.137, Keyuan 3rd Road, Fengdong New Town, Xi'an, Shaanxi, China  
 中国·西安·沣东新城科源三路137号康鸿橙方科技园1号楼D单元1层 邮编: 710086 t (86-29) 6282 7885 sgs.china@sgs.com

11b-CDD Ant1 2437



11b-CDD Ant0 2437



Unless otherwise agreed in writing, this document is issued by the Company subject to its General Conditions of Service printed overleaf, available on request or accessible at <http://www.sgs.com/en/Terms-and-Conditions.aspx> and, for electronic format documents, subject to Terms and Conditions for Electronic Documents at <http://www.sgs.com/en/Terms-and-Conditions/Terms-e-Documents.aspx>. Attention is drawn to the limitation of liability, indemnification and jurisdiction issues defined therein. Any holder of this document is advised that information contained hereon reflects the Company's findings at the time of its intervention only and within the limits of Client's instructions, if any. The Company's sole responsibility is to its Client and this document does not exonerate parties to a transaction from exercising all their rights and obligations under the transaction documents. This document cannot be reproduced except in full, without prior written approval of the Company. Any unauthorized alteration, forgery or falsification of the content or appearance of this document is unlawful and offenders may be prosecuted to the fullest extent of the law. Unless otherwise stated the results shown in this test report refer only to the sample(s) tested and such sample(s) are retained for 30 days only.

11b-CDD Ant1 2462



11b-CDD Ant0 2462



Unless otherwise agreed in writing, this document is issued by the Company subject to its General Conditions of Service printed overleaf, available on request or accessible at <http://www.sgs.com/en/Terms-and-Conditions.aspx> and, for electronic format documents, subject to Terms and Conditions for Electronic Documents at <http://www.sgs.com/en/Terms-and-Conditions/Terms-e-Documents.aspx>. Attention is drawn to the limitation of liability, indemnification and jurisdiction issues defined therein. Any holder of this document is advised that information contained hereon reflects the Company's findings at the time of its intervention only and within the limits of Client's instructions, if any. The Company's sole responsibility is to its Client and this document does not exonerate parties to a transaction from exercising all their rights and obligations under the transaction documents. This document cannot be reproduced except in full, without prior written approval of the Company. Any unauthorized alteration, forgery or falsification of the content or appearance of this document is unlawful and offenders may be prosecuted to the fullest extent of the law. Unless otherwise stated the results shown in this test report refer only to the sample(s) tested and such sample(s) are retained for 30 days only.

Attention: To check the authenticity of testing / inspection report & certificate, please contact us at telephone: (86-755) 8307 1443, or email: [CN.Doccheck@sgs.com](mailto:CN.Doccheck@sgs.com)

11g-CDD Ant1 2412



11g-CDD\_Ant0\_2412



Unless otherwise agreed in writing, this document is issued by the Company subject to its General Conditions of Service printed overleaf, available on request or accessible at <http://www.sgs.com/en/Terms-and-Conditions.aspx> and, for electronic format documents, subject to Terms and Conditions for Electronic Documents at <http://www.sgs.com/en/Terms-and-Conditions/Terms-e-Documents.aspx>. Attention is drawn to the limitation of liability, indemnification and jurisdiction issues defined therein. Any holder of this document is advised that information contained hereon reflects the Company's findings at the time of its intervention only and within the limits of Client's instructions, if any. The Company's sole responsibility is to its Client and this document does not exonerate parties to a transaction from exercising all their rights and obligations under the transaction documents. This document cannot be reproduced except in full, without prior written approval of the Company. Any unauthorized alteration, forgery or falsification of the content or appearance of this document is unlawful and offenders may be prosecuted to the fullest extent of the law. Unless otherwise stated the results shown in this test report refer only to the sample(s) tested and such sample(s) are retained for 30 days only.

Attention: To check the authenticity of testing / inspection report & certificate, please contact us at telephone: (86-755) 8307 1443, or email: [CN.Doccheck@sgs.com](mailto:CN.Doccheck@sgs.com)

SGS-CSTC Standards Technical Services (Xi'an) Co., Ltd. | 1/F, Unit D, Building 1, Kanghong Orange Science Park, No.137, Keyuan 3rd Road, Fengdong New Town, Xi'an, Shaanxi, China | 710086 | t (86-29) 6282 7885 | www.sgs.com.cn  
 中国·西安·沣东新城科源三路137号康鸿橙方科技园1号楼D单元1层 | 邮编: 710086 | t (86-29) 6282 7885 | sgs.china@sgs.com



11g-CDD Ant1 2437



11g-CDD\_Ant0\_2437

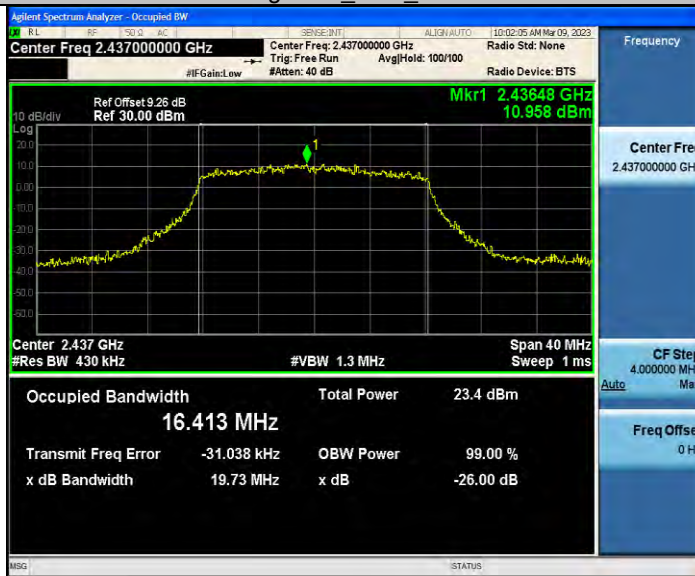

Unless otherwise agreed in writing, this document is issued by the Company subject to its General Conditions of Service printed overleaf, available on request or accessible at <http://www.sgs.com/en/Terms-and-Conditions.aspx> and, for electronic format documents, subject to Terms and Conditions for Electronic Documents at <http://www.sgs.com/en/Terms-and-Conditions/Terms-e-Documents.aspx>. Attention is drawn to the limitation of liability, indemnification and jurisdiction issues defined therein. Any holder of this document is advised that information contained hereon reflects the Company's findings at the time of its intervention only and within the limits of Client's instructions, if any. The Company's sole responsibility is to its Client and this document does not exonerate parties to a transaction from exercising all their rights and obligations under the transaction documents. This document cannot be reproduced except in full, without prior written approval of the Company. Any unauthorized alteration, forgery or falsification of the content or appearance of this document is unlawful and offenders may be prosecuted to the fullest extent of the law. Unless otherwise stated the results shown in this test report refer only to the sample(s) tested and such sample(s) are retained for 30 days only.

11g-CDD Ant1\_2462



11g-CDD\_Ant0\_2462



Unless otherwise agreed in writing, this document is issued by the Company subject to its General Conditions of Service printed overleaf, available on request or accessible at <http://www.sgs.com/en/Terms-and-Conditions.aspx> and, for electronic format documents, subject to Terms and Conditions for Electronic Documents at <http://www.sgs.com/en/Terms-and-Conditions/Terms-e-Documents.aspx>. Attention is drawn to the limitation of liability, indemnification and jurisdiction issues defined therein. Any holder of this document is advised that information contained hereon reflects the Company's findings at the time of its intervention only and within the limits of Client's instructions, if any. The Company's sole responsibility is to its Client and this document does not exonerate parties to a transaction from exercising all their rights and obligations under the transaction documents. This document cannot be reproduced except in full, without prior written approval of the Company. Any unauthorized alteration, forgery or falsification of the content or appearance of this document is unlawful and offenders may be prosecuted to the fullest extent of the law. Unless otherwise stated the results shown in this test report refer only to the sample(s) tested and such sample(s) are retained for 30 days only.

11n20MIMO\_Ant1\_2412



11n20MIMO\_Ant0\_2412



Unless otherwise agreed in writing, this document is issued by the Company subject to its General Conditions of Service printed overleaf, available on request or accessible at <http://www.sgs.com/en/Terms-and-Conditions.aspx> and, for electronic format documents, subject to Terms and Conditions for Electronic Documents at <http://www.sgs.com/en/Terms-and-Conditions/Terms-e-Documents.aspx>. Attention is drawn to the limitation of liability, indemnification and jurisdiction issues defined therein. Any holder of this document is advised that information contained hereon reflects the Company's findings at the time of its intervention only and within the limits of Client's instructions, if any. The Company's sole responsibility is to its Client and this document does not exonerate parties to a transaction from exercising all their rights and obligations under the transaction documents. This document cannot be reproduced except in full, without prior written approval of the Company. Any unauthorized alteration, forgery or falsification of the content or appearance of this document is unlawful and offenders may be prosecuted to the fullest extent of the law. Unless otherwise stated the results shown in this test report refer only to the sample(s) tested and such sample(s) are retained for 30 days only.

Attention: To check the authenticity of testing / inspection report & certificate, please contact us at telephone: (86-755) 8307 1443, or email: [CN.Doccheck@sgs.com](mailto:CN.Doccheck@sgs.com)

SGS-CSTC Standards Technical Services (Xi'an) Co., Ltd. | 1/F, Unit D, Building 1, Kanghong Orange Science Park, No.137, Keyuan 3rd Road, Fengdong New Town, Xi'an, Shaanxi, China | 710086 | t (86-29) 6282 7885 | www.sgs.com.cn  
 中国·西安·沣东新城科源三路137号康鸿橙方科技园1号楼D单元1层 | 邮编: 710086 | t (86-29) 6282 7885 | sgs.china@sgs.com

11n20MIMO\_Ant1\_2437



11n20MIMO\_Ant0\_2437



Unless otherwise agreed in writing, this document is issued by the Company subject to its General Conditions of Service printed overleaf, available on request or accessible at <http://www.sgs.com/en/Terms-and-Conditions.aspx> and, for electronic format documents, subject to Terms and Conditions for Electronic Documents at <http://www.sgs.com/en/Terms-and-Conditions/Terms-e-Documents.aspx>. Attention is drawn to the limitation of liability, indemnification and jurisdiction issues defined therein. Any holder of this document is advised that information contained hereon reflects the Company's findings at the time of its intervention only and within the limits of Client's instructions, if any. The Company's sole responsibility is to its Client and this document does not exonerate parties to a transaction from exercising all their rights and obligations under the transaction documents. This document cannot be reproduced except in full, without prior written approval of the Company. Any unauthorized alteration, forgery or falsification of the content or appearance of this document is unlawful and offenders may be prosecuted to the fullest extent of the law. Unless otherwise stated the results shown in this test report refer only to the sample(s) tested and such sample(s) are retained for 30 days only.

11n20MIMO\_Ant1\_2462



11n20MIMO\_Ant0\_2462



Unless otherwise agreed in writing, this document is issued by the Company subject to its General Conditions of Service printed overleaf, available on request or accessible at <http://www.sgs.com/en/Terms-and-Conditions.aspx> and, for electronic format documents, subject to Terms and Conditions for Electronic Documents at <http://www.sgs.com/en/Terms-and-Conditions/Terms-e-Documents.aspx>. Attention is drawn to the limitation of liability, indemnification and jurisdiction issues defined therein. Any holder of this document is advised that information contained hereon reflects the Company's findings at the time of its intervention only and within the limits of Client's instructions, if any. The Company's sole responsibility is to its Client and this document does not exonerate parties to a transaction from exercising all their rights and obligations under the transaction documents. This document cannot be reproduced except in full, without prior written approval of the Company. Any unauthorized alteration, forgery or falsification of the content or appearance of this document is unlawful and offenders may be prosecuted to the fullest extent of the law. Unless otherwise stated the results shown in this test report refer only to the sample(s) tested and such sample(s) are retained for 30 days only.

11n40MIMO\_Ant1\_2422



11n40MIMO\_Ant0\_2422

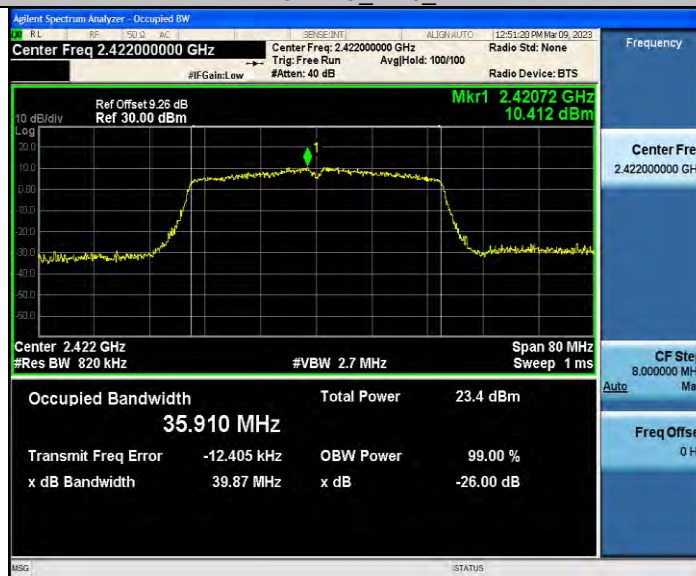

Unless otherwise agreed in writing, this document is issued by the Company subject to its General Conditions of Service printed overleaf, available on request or accessible at <http://www.sgs.com/en/Terms-and-Conditions.aspx> and, for electronic format documents, subject to Terms and Conditions for Electronic Documents at <http://www.sgs.com/en/Terms-and-Conditions/Terms-e-Documents.aspx>. Attention is drawn to the limitation of liability, indemnification and jurisdiction issues defined therein. Any holder of this document is advised that information contained hereon reflects the Company's findings at the time of its intervention only and within the limits of Client's instructions, if any. The Company's sole responsibility is to its Client and this document does not exonerate parties to a transaction from exercising all their rights and obligations under the transaction documents. This document cannot be reproduced except in full, without prior written approval of the Company. Any unauthorized alteration, forgery or falsification of the content or appearance of this document is unlawful and offenders may be prosecuted to the fullest extent of the law. Unless otherwise stated the results shown in this test report refer only to the sample(s) tested and such sample(s) are retained for 30 days only.

Attention: To check the authenticity of testing / inspection report & certificate, please contact us at telephone: (86-755) 8307 1443, or email: [CN.Doccheck@sgs.com](mailto:CN.Doccheck@sgs.com)

SGS-CSTC Standards Technical Services (Xi'an) Co., Ltd. W/F, Unit D, Building 1, Kanghong Orange Science Park, No.137, Keyuan 3rd Road, Fengdong New Town, Xi'an, Shaanxi, China 710086 t (86-29) 6282 7885 www.sgs.com.cn  
 中国·西安·沣东新城科源三路137号康鸿橙方科技园1号楼D单元1层 邮编: 710086 t (86-29) 6282 7885 sgs.china@sgs.com

11n40MIMO Ant1 2437



11n40MIMO Ant0 2437

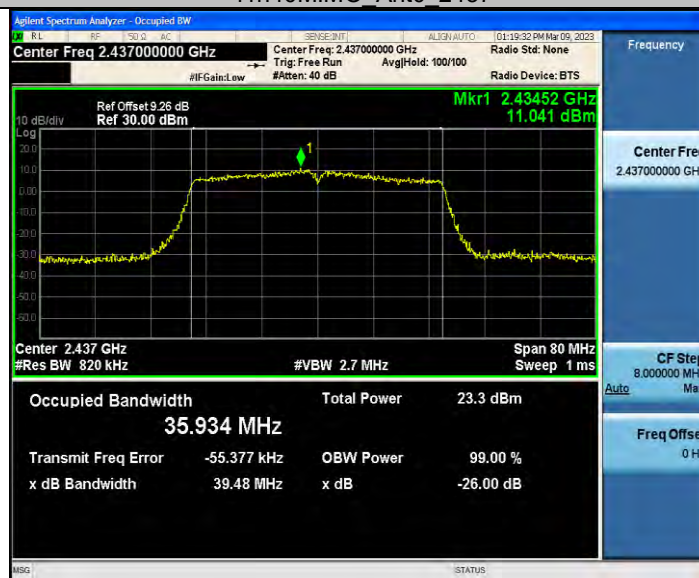

Unless otherwise agreed in writing, this document is issued by the Company subject to its General Conditions of Service printed overleaf, available on request or accessible at <http://www.sgs.com/en/Terms-and-Conditions.aspx> and, for electronic format documents, subject to Terms and Conditions for Electronic Documents at <http://www.sgs.com/en/Terms-and-Conditions/Terms-e-Documents.aspx>. Attention is drawn to the limitation of liability, indemnification and jurisdiction issues defined therein. Any holder of this document is advised that information contained hereon reflects the Company's findings at the time of its intervention only and within the limits of Client's instructions, if any. The Company's sole responsibility is to its Client and this document does not exonerate parties to a transaction from exercising all their rights and obligations under the transaction documents. This document cannot be reproduced except in full, without prior written approval of the Company. Any unauthorized alteration, forgery or falsification of the content or appearance of this document is unlawful and offenders may be prosecuted to the fullest extent of the law. Unless otherwise stated the results shown in this test report refer only to the sample(s) tested and such sample(s) are retained for 30 days only.

Attention: To check the authenticity of testing / inspection report & certificate, please contact us at telephone: (86-755) 8307 1443, or email: [CN.Doccheck@sgs.com](mailto:CN.Doccheck@sgs.com)

SGS-CSTC Standards Technical Services (Xi'an) Co., Ltd. | 1/F, Unit D, Building 1, Kanghong Orange Science Park, No.137, Keyuan 3rd Road, Fengdong New Town, Xi'an, Shaanxi, China | 710086 | t (86-29) 6282 7885 | www.sgsgroup.com.cn  
 中国·西安·沣东新城科源三路137号康鸿橙方科技园1号楼D单元1层 | 邮编: 710086 | t (86-29) 6282 7885 | sgs.china@sgs.com

11n40MIMO\_Ant1\_2452



11n40MIMO\_Ant0\_2452



Unless otherwise agreed in writing, this document is issued by the Company subject to its General Conditions of Service printed overleaf, available on request or accessible at <http://www.sgs.com/en/Terms-and-Conditions.aspx> and, for electronic format documents, subject to Terms and Conditions for Electronic Documents at <http://www.sgs.com/en/Terms-and-Conditions/Terms-e-Documents.aspx>. Attention is drawn to the limitation of liability, indemnification and jurisdiction issues defined therein. Any holder of this document is advised that information contained hereon reflects the Company's findings at the time of its intervention only and within the limits of Client's instructions, if any. The Company's sole responsibility is to its Client and this document does not exonerate parties to a transaction from exercising all their rights and obligations under the transaction documents. This document cannot be reproduced except in full, without prior written approval of the Company. Any unauthorized alteration, forgery or falsification of the content or appearance of this document is unlawful and offenders may be prosecuted to the fullest extent of the law. Unless otherwise stated the results shown in this test report refer only to the sample(s) tested and such sample(s) are retained for 30 days only.



11ax20MIMO\_Ant1\_2412



11ax20MIMO\_Ant0\_2412



Unless otherwise agreed in writing, this document is issued by the Company subject to its General Conditions of Service printed overleaf, available on request or accessible at <http://www.sgs.com/en/Terms-and-Conditions.aspx> and, for electronic format documents, subject to Terms and Conditions for Electronic Documents at <http://www.sgs.com/en/Terms-and-Conditions/Terms-e-Documents.aspx>. Attention is drawn to the limitation of liability, indemnification and jurisdiction issues defined therein. Any holder of this document is advised that information contained hereon reflects the Company's findings at the time of its intervention only and within the limits of Client's instructions, if any. The Company's sole responsibility is to its Client and this document does not exonerate parties to a transaction from exercising all their rights and obligations under the transaction documents. This document cannot be reproduced except in full, without prior written approval of the Company. Any unauthorized alteration, forgery or falsification of the content or appearance of this document is unlawful and offenders may be prosecuted to the fullest extent of the law. Unless otherwise stated the results shown in this test report refer only to the sample(s) tested and such sample(s) are retained for 30 days only.

11ax20MIMO\_Ant1\_2437



11ax20MIMO\_Ant0\_2437

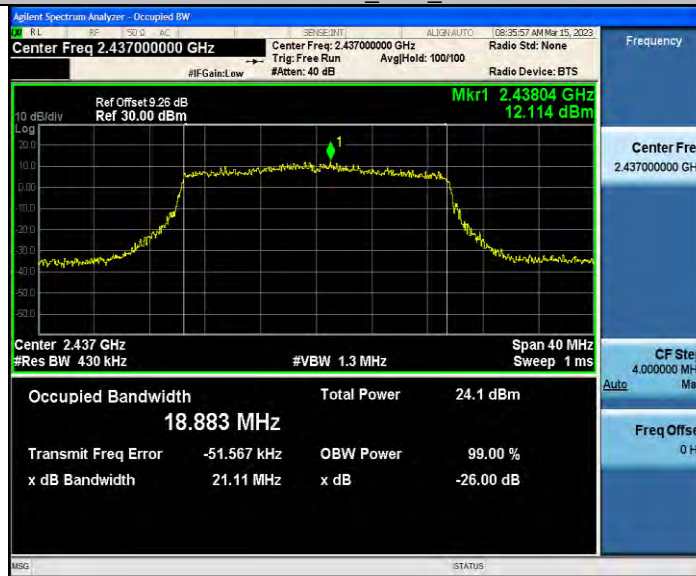

Unless otherwise agreed in writing, this document is issued by the Company subject to its General Conditions of Service printed overleaf, available on request or accessible at <http://www.sgs.com/en/Terms-and-Conditions.aspx> and, for electronic format documents, subject to Terms and Conditions for Electronic Documents at <http://www.sgs.com/en/Terms-and-Conditions/Terms-e-Documents.aspx>. Attention is drawn to the limitation of liability, indemnification and jurisdiction issues defined therein. Any holder of this document is advised that information contained hereon reflects the Company's findings at the time of its intervention only and within the limits of Client's instructions, if any. The Company's sole responsibility is to its Client and this document does not exonerate parties to a transaction from exercising all their rights and obligations under the transaction documents. This document cannot be reproduced except in full, without prior written approval of the Company. Any unauthorized alteration, forgery or falsification of the content or appearance of this document is unlawful and offenders may be prosecuted to the fullest extent of the law. Unless otherwise stated the results shown in this test report refer only to the sample(s) tested and such sample(s) are retained for 30 days only.

Attention: To check the authenticity of testing / inspection report & certificate, please contact us at telephone: (86-755) 8307 1443, or email: [CN.Doccheck@sgs.com](mailto:CN.Doccheck@sgs.com)

SGS-CSTC Standards Technical Services (Xi'an) Co., Ltd. | W/F, Unit D, Building 1, Kanghong Orange Science Park, No.137, Keyuan 3rd Road, Fengdong New Town, Xi'an, Shaanxi, China | 710086 | t (86-29) 6282 7885 | www.sgs.com.cn  
 中国·西安·沣东新城科源三路137号康鸿橙方科技园1号楼D单元1层 | 邮编: 710086 | t (86-29) 6282 7885 | sgs.china@sgs.com

11ax20MIMO\_Ant1\_2462



11ax20MIMO\_Ant0\_2462



Unless otherwise agreed in writing, this document is issued by the Company subject to its General Conditions of Service printed overleaf, available on request or accessible at <http://www.sgs.com/en/Terms-and-Conditions.aspx> and, for electronic format documents, subject to Terms and Conditions for Electronic Documents at <http://www.sgs.com/en/Terms-and-Conditions/Terms-e-Documents.aspx>. Attention is drawn to the limitation of liability, indemnification and jurisdiction issues defined therein. Any holder of this document is advised that information contained hereon reflects the Company's findings at the time of its intervention only and within the limits of Client's instructions, if any. The Company's sole responsibility is to its Client and this document does not exonerate parties to a transaction from exercising all their rights and obligations under the transaction documents. This document cannot be reproduced except in full, without prior written approval of the Company. Any unauthorized alteration, forgery or falsification of the content or appearance of this document is unlawful and offenders may be prosecuted to the fullest extent of the law. Unless otherwise stated the results shown in this test report refer only to the sample(s) tested and such sample(s) are retained for 30 days only.

Attention: To check the authenticity of testing / inspection report & certificate, please contact us at telephone: (86-755) 8307 1443, or email: [CN.Doccheck@sgs.com](mailto:CN.Doccheck@sgs.com)

SGS-CSTC Standards Technical Services (Xi'an) Co., Ltd. | 1/F, Unit D, Building 1, Kanghong Orange Science Park, No.137, Keyuan 3rd Road, Fengdong New Town, Xi'an, Shaanxi, China | 710086 | t (86-29) 6282 7885 | www.sgs.com.cn  
 中国·西安·沣东新城科源三路137号康鸿橙方科技园1号楼D单元1层 | 邮编: 710086 | t (86-29) 6282 7885 | sgs.china@sgs.com

11ax40MIMO\_Ant1\_2422



11ax40MIMO\_Ant0\_2422

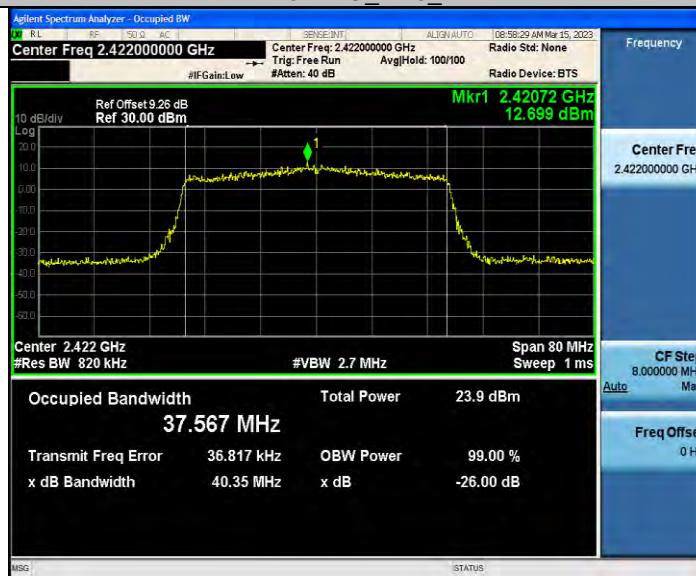

Unless otherwise agreed in writing, this document is issued by the Company subject to its General Conditions of Service printed overleaf, available on request or accessible at <http://www.sgs.com/en/Terms-and-Conditions.aspx> and, for electronic format documents, subject to Terms and Conditions for Electronic Documents at <http://www.sgs.com/en/Terms-and-Conditions/Terms-e-Documents.aspx>. Attention is drawn to the limitation of liability, indemnification and jurisdiction issues defined therein. Any holder of this document is advised that information contained hereon reflects the Company's findings at the time of its intervention only and within the limits of Client's instructions, if any. The Company's sole responsibility is to its Client and this document does not exonerate parties to a transaction from exercising all their rights and obligations under the transaction documents. This document cannot be reproduced except in full, without prior written approval of the Company. Any unauthorized alteration, forgery or falsification of the content or appearance of this document is unlawful and offenders may be prosecuted to the fullest extent of the law. Unless otherwise stated the results shown in this test report refer only to the sample(s) tested and such sample(s) are retained for 30 days only.

Attention: To check the authenticity of testing / inspection report & certificate, please contact us at telephone: (86-755) 8307 1443, or email: [CN.Doccheck@sgs.com](mailto:CN.Doccheck@sgs.com)

SGS-CSTC Standards Technical Services (Xi'an) Co., Ltd. 1/F, Unit D, Building 1, Kanghong Orange Science Park, No.137, Keyuan 3rd Road, Fengdong New Town, Xi'an, Shaanxi, China 710086 t (86-29) 6282 7885 www.sgs.com.cn  
 中国·西安·沣东新城科源三路137号康鸿橙方科技园1号楼D单元1层 邮编: 710086 t (86-29) 6282 7885 sgs.china@sgs.com

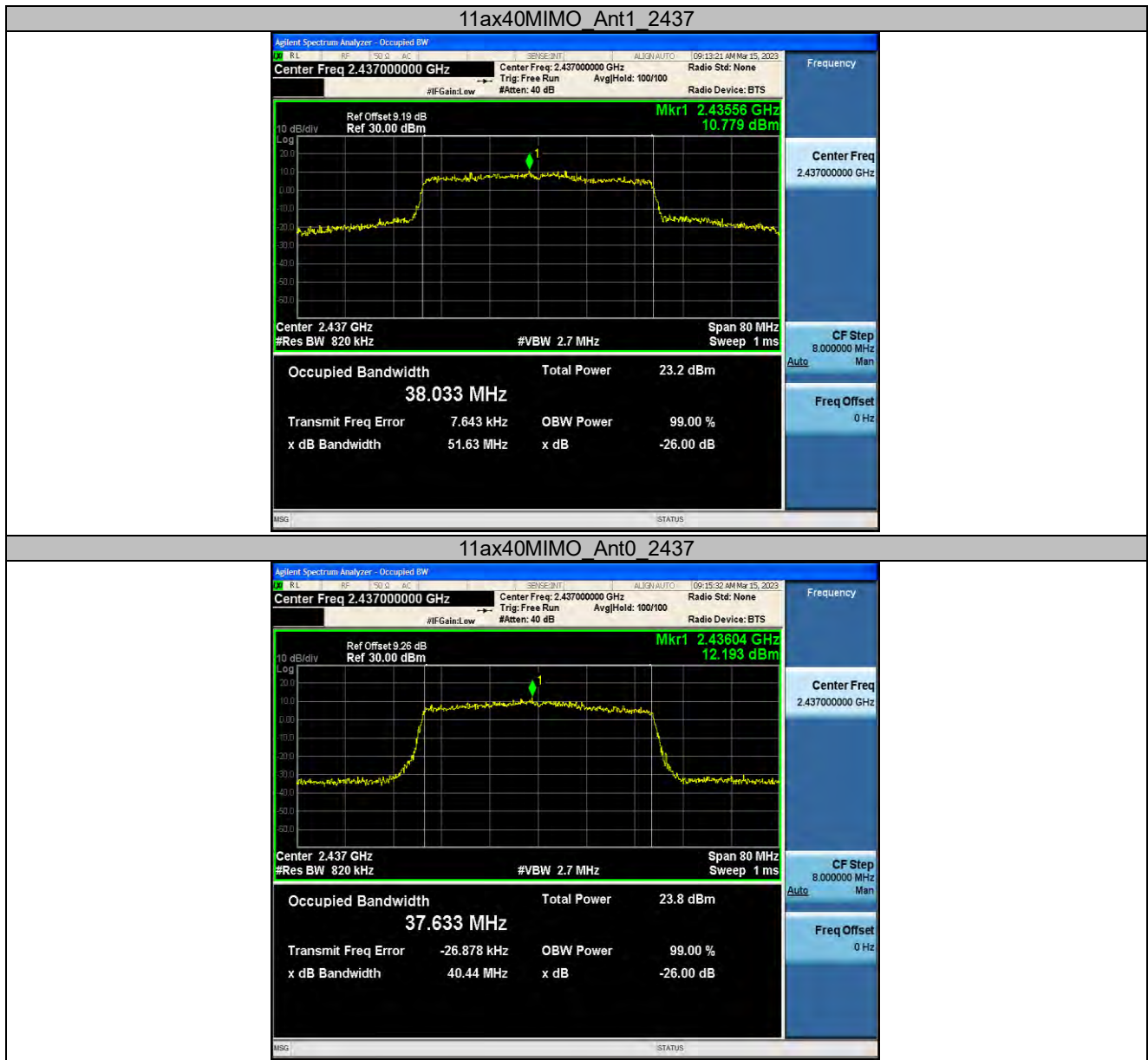

Unless otherwise agreed in writing, this document is issued by the Company subject to its General Conditions of Service printed overleaf, available on request or accessible at <http://www.sgs.com/en/Terms-and-Conditions.aspx> and, for electronic format documents, subject to Terms and Conditions for Electronic Documents at <http://www.sgs.com/en/Terms-and-Conditions/Terms-e-Documents.aspx>. Attention is drawn to the limitation of liability, indemnification and jurisdiction issues defined therein. Any holder of this document is advised that information contained hereon reflects the Company's findings at the time of its intervention only and within the limits of Client's instructions, if any. The Company's sole responsibility is to its Client and this document does not exonerate parties to a transaction from exercising all their rights and obligations under the transaction documents. This document cannot be reproduced except in full, without prior written approval of the Company. Any unauthorized alteration, forgery or falsification of the content or appearance of this document is unlawful and offenders may be prosecuted to the fullest extent of the law. Unless otherwise stated the results shown in this test report refer only to the sample(s) tested and such sample(s) are retained for 30 days only.

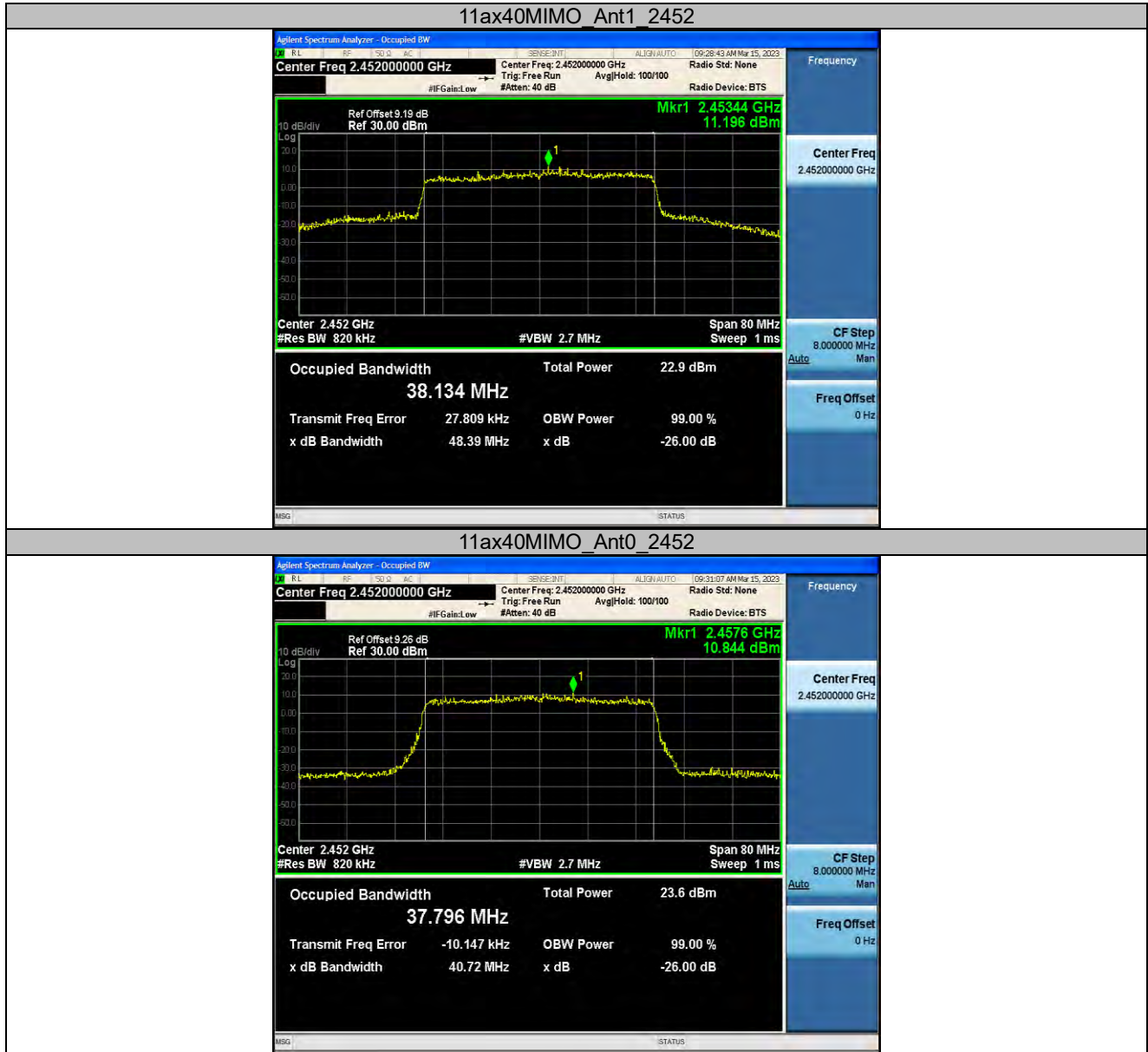

Unless otherwise agreed in writing, this document is issued by the Company subject to its General Conditions of Service printed overleaf, available on request or accessible at <http://www.sgs.com/en/Terms-and-Conditions.aspx> and, for electronic format documents, subject to Terms and Conditions for Electronic Documents at <http://www.sgs.com/en/Terms-and-Conditions/Terms-e-Documents.aspx>. Attention is drawn to the limitation of liability, indemnification and jurisdiction issues defined therein. Any holder of this document is advised that information contained hereon reflects the Company's findings at the time of its intervention only and within the limits of Client's instructions, if any. The Company's sole responsibility is to its Client and this document does not exonerate parties to a transaction from exercising all their rights and obligations under the transaction documents. This document cannot be reproduced except in full, without prior written approval of the Company. Any unauthorized alteration, forgery or falsification of the content or appearance of this document is unlawful and offenders may be prosecuted to the fullest extent of the law. Unless otherwise stated the results shown in this test report refer only to the sample(s) tested and such sample(s) are retained for 30 days only.

Attention: To check the authenticity of testing / inspection report & certificate, please contact us at telephone: (86-755) 8307 1443, or email: [CN.Doccheck@sgs.com](mailto:CN.Doccheck@sgs.com)

SGS-CSTC Standards Technical Services (Xi'an) Co., Ltd. | 1/F, Unit D, Building 1, Kanghong Orange Science Park, No.137, Keyuan 3rd Road, Fengdong New Town, Xi'an, Shaanxi, China | 710086 | t (86-29) 6282 7885 | www.sgsgroup.com.cn  
 中国·西安·沣东新城科源三路137号康鸿橙方科技园1号楼D单元1层 | 邮编: 710086 | t (86-29) 6282 7885 | sgs.china@sgs.com

**Maximum conducted output power  
Test Result Peak**

TestMode	Antenna	Frequency[MHz]	Peak Power[dBm]	Conducted Limit[dBm]	Verdict
11b-CDD	Ant1	2412	20.03	≤30.00	PASS
	Ant0	2412	19.40	≤30.00	PASS
	total	2412	22.74	≤30.00	PASS
	Ant1	2437	20.07	≤30.00	PASS
	Ant0	2437	19.60	≤30.00	PASS
	total	2437	22.85	≤30.00	PASS
	Ant1	2462	20.12	≤30.00	PASS
	Ant0	2462	19.56	≤30.00	PASS
	total	2462	22.86	≤30.00	PASS
11g-CDD	Ant1	2412	21.54	≤30.00	PASS
	Ant0	2412	21.47	≤30.00	PASS
	total	2412	24.52	≤30.00	PASS
	Ant1	2437	21.61	≤30.00	PASS
	Ant0	2437	21.54	≤30.00	PASS
	total	2437	24.59	≤30.00	PASS
	Ant1	2462	21.62	≤30.00	PASS
	Ant0	2462	21.48	≤30.00	PASS
	total	2462	24.56	≤30.00	PASS
11n20MIMO	Ant1	2412	22.22	≤30.00	PASS
	Ant0	2412	21.38	≤30.00	PASS
	total	2412	24.83	≤30.00	PASS
	Ant1	2437	20.75	≤30.00	PASS
	Ant0	2437	22.74	≤30.00	PASS
	total	2437	24.87	≤30.00	PASS
	Ant1	2462	22.78	≤30.00	PASS
	Ant0	2462	20.78	≤30.00	PASS
	total	2462	24.90	≤30.00	PASS
11n40MIMO	Ant1	2422	22.49	≤30.00	PASS
	Ant0	2422	21.30	≤30.00	PASS
	total	2422	24.95	≤30.00	PASS
	Ant1	2437	22.37	≤30.00	PASS
	Ant0	2437	21.20	≤30.00	PASS
	total	2437	24.83	≤30.00	PASS
	Ant1	2452	20.89	≤30.00	PASS
	Ant0	2452	22.47	≤30.00	PASS
	total	2452	24.76	≤30.00	PASS
11ax20MIMO	Ant1	2412	22.42	≤30.00	PASS
	Ant0	2412	20.41	≤30.00	PASS
	total	2412	24.54	≤30.00	PASS
	Ant1	2437	21.21	≤30.00	PASS
	Ant0	2437	22.45	≤30.00	PASS
	total	2437	24.88	≤30.00	PASS
	Ant1	2462	21.35	≤30.00	PASS
	Ant0	2462	20.72	≤30.00	PASS
	total	2462	24.06	≤30.00	PASS



Unless otherwise agreed in writing, this document is issued by the Company subject to its General Conditions of Service printed overleaf, available on request or accessible at <http://www.sgs.com/en/Terms-and-Conditions.aspx> and, for electronic format documents, subject to Terms and Conditions for Electronic Documents at <http://www.sgs.com/en/Terms-and-Conditions/Terms-e-Documents.aspx>. Attention is drawn to the limitation of liability, indemnification and jurisdiction issues defined therein. Any holder of this document is advised that information contained hereon reflects the Company's findings at the time of its intervention only and within the limits of Client's instructions, if any. The Company's sole responsibility is to its Client and this document does not exonerate parties to a transaction from exercising all their rights and obligations under the transaction documents. This document cannot be reproduced except in full, without prior written approval of the Company. Any unauthorized alteration, forgery or falsification of the content or appearance of this document is unlawful and offenders may be prosecuted to the fullest extent of the law. Unless otherwise stated the results shown in this test report refer only to the sample(s) tested and such sample(s) are retained for 30 days only.

Report No.: XEWA2302000005RG03

Rev.: 01

Page: 72 of 305

11ax40MIMO	Ant1	2422	20.84	≤30.00	PASS
	Ant0	2422	21.62	≤30.00	PASS
	total	2422	24.26	≤30.00	PASS
	Ant1	2437	22.38	≤30.00	PASS
	Ant0	2437	19.87	≤30.00	PASS
	total	2437	24.31	≤30.00	PASS
	Ant1	2452	20.78	≤30.00	PASS
	Ant0	2452	21.84	≤30.00	PASS
	total	2452	24.35	≤30.00	PASS



Unless otherwise agreed in writing, this document is issued by the Company subject to its General Conditions of Service printed overleaf, available on request or accessible at <http://www.sgs.com/en/Terms-and-Conditions.aspx> and, for electronic format documents, subject to Terms and Conditions for Electronic Documents at <http://www.sgs.com/en/Terms-and-Conditions/Terms-e-Documents.aspx>.

Attention is drawn to the limitation of liability, indemnification and jurisdiction issues defined therein. Any holder of this document is advised that information contained hereon reflects the Company's findings at the time of its intervention only and within the limits of Client's instructions, if any. The Company's sole responsibility is to its Client and this document does not exonerate parties to a transaction from exercising all their rights and obligations under the transaction documents. This document cannot be reproduced except in full, without prior written approval of the Company. Any unauthorized alteration, forgery or falsification of the content or appearance of this document is unlawful and offenders may be prosecuted to the fullest extent of the law. Unless otherwise stated the results shown in this test report refer only to the sample(s) tested and such sample(s) are retained for 30 days only.

Attention: To check the authenticity of testing/inspection report & certificate, please contact us at telephone: (86-755) 8307 1443, or email: [CN.Doccheck@sgs.com](mailto:CN.Doccheck@sgs.com)



Report No.: XEWA2302000005RG03

Rev.: 01

Page: 73 of 305

**Test Result for AX Part RU**

Test Mode	Frequency[MHz]	Ru Size	Ru Index	ANT1 Peak Power[dBm]	ANT0 Peak Power[dBm]	Total Peak Power[dBm]	Conducted Limit[dBm]	Verdict
11ax20MIMO	2412	26Tone	RU0	21.93	22.86	25.43	≤30.00	PASS
		52Tone	RU37	21.52	21.68	24.61	≤30.00	PASS
		106Tone	RU53	22.02	21.15	24.62	≤30.00	PASS
	2437	26Tone	RU4	20.78	21.47	24.15	≤30.00	PASS
		52Tone	RU38	21.52	20.45	24.03	≤30.00	PASS
		106Tone	RU53	21.36	21.52	24.45	≤30.00	PASS
	2462	26Tone	RU8	21.68	20.47	24.13	≤30.00	PASS
		52Tone	RU40	21.02	21.52	24.29	≤30.00	PASS
		106Tone	RU54	21.78	20.02	24.00	≤30.00	PASS
11ax40MIMO	2422	242Tone	RU61	20.45	21.32	23.92	≤30.00	PASS
	2437	242Tone	RU61	21.32	21.11	24.23	≤30.00	PASS
	2452	242Tone	RU62	20.78	21.37	24.10	≤30.00	PASS



Unless otherwise agreed in writing, this document is issued by the Company subject to its General Conditions of Service printed overleaf, available on request or accessible at <http://www.sgs.com/en/Terms-and-Conditions.aspx> and, for electronic format documents, subject to Terms and Conditions for Electronic Documents at <http://www.sgs.com/en/Terms-and-Conditions/Terms-e-Documents.aspx>. Attention is drawn to the limitation of liability, indemnification and jurisdiction issues defined therein. Any holder of this document is advised that information contained hereon reflects the Company's findings at the time of its intervention only and within the limits of Client's instructions, if any. The Company's sole responsibility is to its Client and this document does not exonerate parties to a transaction from exercising all their rights and obligations under the transaction documents. This document cannot be reproduced except in full, without prior written approval of the Company. Any unauthorized alteration, forgery or falsification of the content or appearance of this document is unlawful and offenders may be prosecuted to the fullest extent of the law. Unless otherwise stated the results shown in this test report refer only to the sample(s) tested and such sample(s) are retained for 30 days only.

SGS-CSTC Standards Technical Services (Xi'an) Co., Ltd.  
Wireless Laboratory

Attention: To check the authenticity of testing / inspection report & certificate, please contact us at telephone: (86-755) 8307 1443, or email: [CN.Doccheck@sgs.com](mailto:CN.Doccheck@sgs.com)  
 1/F, Unit D, Building 1, Kanghong Orange Science Park, No.137, Keyuan 3rd Road, Fengdong New Town, Xi'an, Shaanxi, China 710086 t (86-29) 6282 7885 www.sgs.com.cn  
 中国·西安·沣东新城科源三路137号康鸿橙方科技园1号楼D单元1层 邮编: 710086 t (86-29) 6282 7885 sgs.china@sgs.com

**Maximum power spectral density  
 Test Result**

TestMode	Antenna	Frequency[MHz]	Result[dBm/3-100kHz]	Limit[dBm/3kHz]	Verdict
11b-CDD	Ant1	2412	-6.07	≤8.00	PASS
	Ant0	2412	-6.24	≤8.00	PASS
	total	2412	-3.14	≤8.00	PASS
	Ant1	2437	-6.43	≤8.00	PASS
	Ant0	2437	-6.86	≤8.00	PASS
	total	2437	-3.63	≤8.00	PASS
	Ant1	2462	-5.31	≤8.00	PASS
	Ant0	2462	-6.06	≤8.00	PASS
	total	2462	-2.66	≤8.00	PASS
11g-CDD	Ant1	2412	-10.28	≤8.00	PASS
	Ant0	2412	-10.29	≤8.00	PASS
	total	2412	-7.27	≤8.00	PASS
	Ant1	2437	-9.48	≤8.00	PASS
	Ant0	2437	-10.55	≤8.00	PASS
	total	2437	-6.97	≤8.00	PASS
	Ant1	2462	-8.07	≤8.00	PASS
	Ant0	2462	-8.67	≤8.00	PASS
	total	2462	-5.35	≤8.00	PASS
11n20MIMO	Ant1	2412	-9.19	≤8.00	PASS
	Ant0	2412	-9.34	≤8.00	PASS
	total	2412	-6.25	≤8.00	PASS
	Ant1	2437	-8.2	≤8.00	PASS
	Ant0	2437	-9.41	≤8.00	PASS
	total	2437	-5.75	≤8.00	PASS
	Ant1	2462	-6.76	≤8.00	PASS
	Ant0	2462	-9.22	≤8.00	PASS
	total	2462	-4.81	≤8.00	PASS
11n40MIMO	Ant1	2422	-9.97	≤8.00	PASS
	Ant0	2422	-9.01	≤8.00	PASS
	total	2422	-6.45	≤8.00	PASS
	Ant1	2437	-10.96	≤8.00	PASS
	Ant0	2437	-12.99	≤8.00	PASS
	total	2437	-8.85	≤8.00	PASS
	Ant1	2452	-12.82	≤8.00	PASS
	Ant0	2452	-12.64	≤8.00	PASS
	total	2452	-9.72	≤8.00	PASS
11ax20MIMO	Ant1	2412	-11.76	≤8.00	PASS
	Ant0	2412	-10.88	≤8.00	PASS
	total	2412	-8.29	≤8.00	PASS
	Ant1	2437	-9.88	≤8.00	PASS
	Ant0	2437	-10.67	≤8.00	PASS
	total	2437	-7.25	≤8.00	PASS
	Ant1	2462	-8.03	≤8.00	PASS
	Ant0	2462	-10.47	≤8.00	PASS
	total	2462	-6.07	≤8.00	PASS
11ax40MIMO	Ant1	2422	-13.48	≤8.00	PASS
	Ant0	2422	-13.95	≤8.00	PASS
	total	2422	-10.70	≤8.00	PASS



Unless otherwise agreed in writing, this document is issued by the Company subject to its General Conditions of Service printed overleaf, available on request or accessible at <http://www.sgs.com/en/Terms-and-Conditions.aspx> and, for electronic format documents, subject to Terms and Conditions for Electronic Documents at <http://www.sgs.com/en/Terms-and-Conditions/Terms-e-Documents.aspx>. Attention is drawn to the limitation of liability, indemnification and jurisdiction issues defined therein. Any holder of this document is advised that information contained hereon reflects the Company's findings at the time of its intervention only and within the limits of Client's instructions, if any. The Company's sole responsibility is to its Client and this document does not exonerate parties to a transaction from exercising all their rights and obligations under the transaction documents. This document cannot be reproduced except in full, without prior written approval of the Company. Any unauthorized alteration, forgery or falsification of the content or appearance of this document is unlawful and offenders may be prosecuted to the fullest extent of the law. Unless otherwise stated the results shown in this test report refer only to the sample(s) tested and such sample(s) are retained for 30 days only.

Attention: To check the authenticity of testing/inspection report & certificate, please contact us at telephone: (86-755) 8307 1443, or email: [CN.Doccheck@sgs.com](mailto:CN.Doccheck@sgs.com)

SGS-CSTC Standards Technical Services (Xi'an) Co., Ltd. 1/F, Unit D, Building 1, Kanghong Orange Science Park, No.137, Keyuan 3rd Road, Fengdong New Town, Xi'an, Shaanxi, China 710086 t (86-29) 6282 7885 www.sgs.com.cn  
 中国·西安·沣东新城科源三路137号康鸿橙方科技园1号楼D单元1层 邮编: 710086 t (86-29) 6282 7885 sgs.china@sgs.com

Report No.: XEWA2302000005RG03

Rev.: 01

Page: 75 of 305

	Ant1	2437	-12.52	≤8.00	PASS
	Ant0	2437	-14.56	≤8.00	PASS
	total	2437	-10.41	≤8.00	PASS
	Ant1	2452	-13.96	≤8.00	PASS
	Ant0	2452	-14.68	≤8.00	PASS
	total	2452	-11.29	≤8.00	PASS



Unless otherwise agreed in writing, this document is issued by the Company subject to its General Conditions of Service printed overleaf, available on request or accessible at <http://www.sgs.com/en/Terms-and-Conditions.aspx> and, for electronic format documents, subject to Terms and Conditions for Electronic Documents at <http://www.sgs.com/en/Terms-and-Conditions/Terms-e-Documents.aspx>. Attention is drawn to the limitation of liability, indemnification and jurisdiction issues defined therein. Any holder of this document is advised that information contained hereon reflects the Company's findings at the time of its intervention only and within the limits of Client's instructions, if any. The Company's sole responsibility is to its Client and this document does not exonerate parties to a transaction from exercising all their rights and obligations under the transaction documents. This document cannot be reproduced except in full, without prior written approval of the Company. Any unauthorized alteration, forgery or falsification of the content or appearance of this document is unlawful and offenders may be prosecuted to the fullest extent of the law. Unless otherwise stated the results shown in this test report refer only to the sample(s) tested and such sample(s) are retained for 30 days only.

Attention: To check the authenticity of testing/inspection report & certificate, please contact us at telephone: (86-755) 8307 1443, or email: [CN.Doccheck@sgs.com](mailto:CN.Doccheck@sgs.com)

SGS-CSTC Standards Technical Services (Xi'an) Co., Ltd. 1/F, Unit D, Building 1, Kanghong Orange Science Park, No.137, Keyuan 3rd Road, Fengdong New Town, Xi'an, Shaanxi, China 710086 t (86-29) 6282 7885 www.sgs.com.cn  
 中国·西安·沣东新城科源三路137号康鸿橙方科技园1号楼D单元1层 邮编: 710086 t (86-29) 6282 7885 sgs.china@sgs.com

Report No.: XEWA2302000005RG03

Rev.: 01

Page: 76 of 305

**Test Result for AX Part RU**

TestMode	Antenna	Frequency[MHz]	RuSize	RuIndex	Result [dBm/3kHz]	Limit [dBm/3kHz]	Verdict
11ax20MIMO	Ant1	2412	26Tone	RU0	-6.68	≤8.00	PASS
			52Tone	RU37	-8.03	≤8.00	PASS
			106Tone	RU53	-11	≤8.00	PASS
	Ant0	2412	26Tone	RU0	-5.23	≤8.00	PASS
			52Tone	RU37	-9.69	≤8.00	PASS
			106Tone	RU53	-12.01	≤8.00	PASS
	total	2412	26Tone	RU0	-2.88	≤8.00	PASS
			52Tone	RU37	-5.77	≤8.00	PASS
			106Tone	RU53	-8.47	≤8.00	PASS
	Ant1	2437	26Tone	RU4	-7.79	≤8.00	PASS
			52Tone	RU38	-8.5	≤8.00	PASS
			106Tone	RU53	-11.32	≤8.00	PASS
	Ant0	2437	26Tone	RU4	-5.95	≤8.00	PASS
			52Tone	RU38	-9.45	≤8.00	PASS
			106Tone	RU53	-11.58	≤8.00	PASS
	total	2437	26Tone	RU4	-3.76	≤8.00	PASS
			52Tone	RU38	-5.94	≤8.00	PASS
			106Tone	RU53	-8.44	≤8.00	PASS
	Ant1	2462	26Tone	RU8	-4.85	≤8.00	PASS
			52Tone	RU40	-7.43	≤8.00	PASS
			106Tone	RU54	-11.26	≤8.00	PASS
	Ant0	2462	26Tone	RU8	-6.17	≤8.00	PASS
			52Tone	RU40	-8.19	≤8.00	PASS
			106Tone	RU54	-10.55	≤8.00	PASS
total	2462	26Tone	RU8	-2.45	≤8.00	PASS	
		52Tone	RU40	-4.78	≤8.00	PASS	
		106Tone	RU54	-7.88	≤8.00	PASS	
11ax40MIMO	Ant1	2422	242Tone	RU61	-13.92	≤8.00	PASS
	Ant0	2422	242Tone	RU61	-15.42	≤8.00	PASS
	total	2422	242Tone	RU61	-11.60	≤8.00	PASS
	Ant1	2437	242Tone	RU61	-13.81	≤8.00	PASS
	Ant0	2437	242Tone	RU61	-15.09	≤8.00	PASS
	total	2437	242Tone	RU61	-11.39	≤8.00	PASS
	Ant1	2452	242Tone	RU62	-15.19	≤8.00	PASS
	Ant0	2452	242Tone	RU62	-14.7	≤8.00	PASS
total	2452	242Tone	RU62	-11.93	≤8.00	PASS	



Unless otherwise agreed in writing, this document is issued by the Company subject to its General Conditions of Service printed overleaf, available on request or accessible at <http://www.sgs.com/en/Terms-and-Conditions.aspx> and, for electronic format documents, subject to Terms and Conditions for Electronic Documents at <http://www.sgs.com/en/Terms-and-Conditions/Terms-e-Document.aspx>. Attention is drawn to the limitation of liability, indemnification and jurisdiction issues defined therein. Any holder of this document is advised that information contained hereon reflects the Company's findings at the time of its intervention only and within the limits of Client's instructions, if any. The Company's sole responsibility is to its Client and this document does not exonerate parties to a transaction from exercising all their rights and obligations under the transaction documents. This document cannot be reproduced except in full, without prior written approval of the Company. Any unauthorized alteration, forgery or falsification of the content or appearance of this document is unlawful and offenders may be prosecuted to the fullest extent of the law. Unless otherwise stated the results shown in this test report refer only to the sample(s) tested and such sample(s) are retained for 30 days only.

Test Graphs

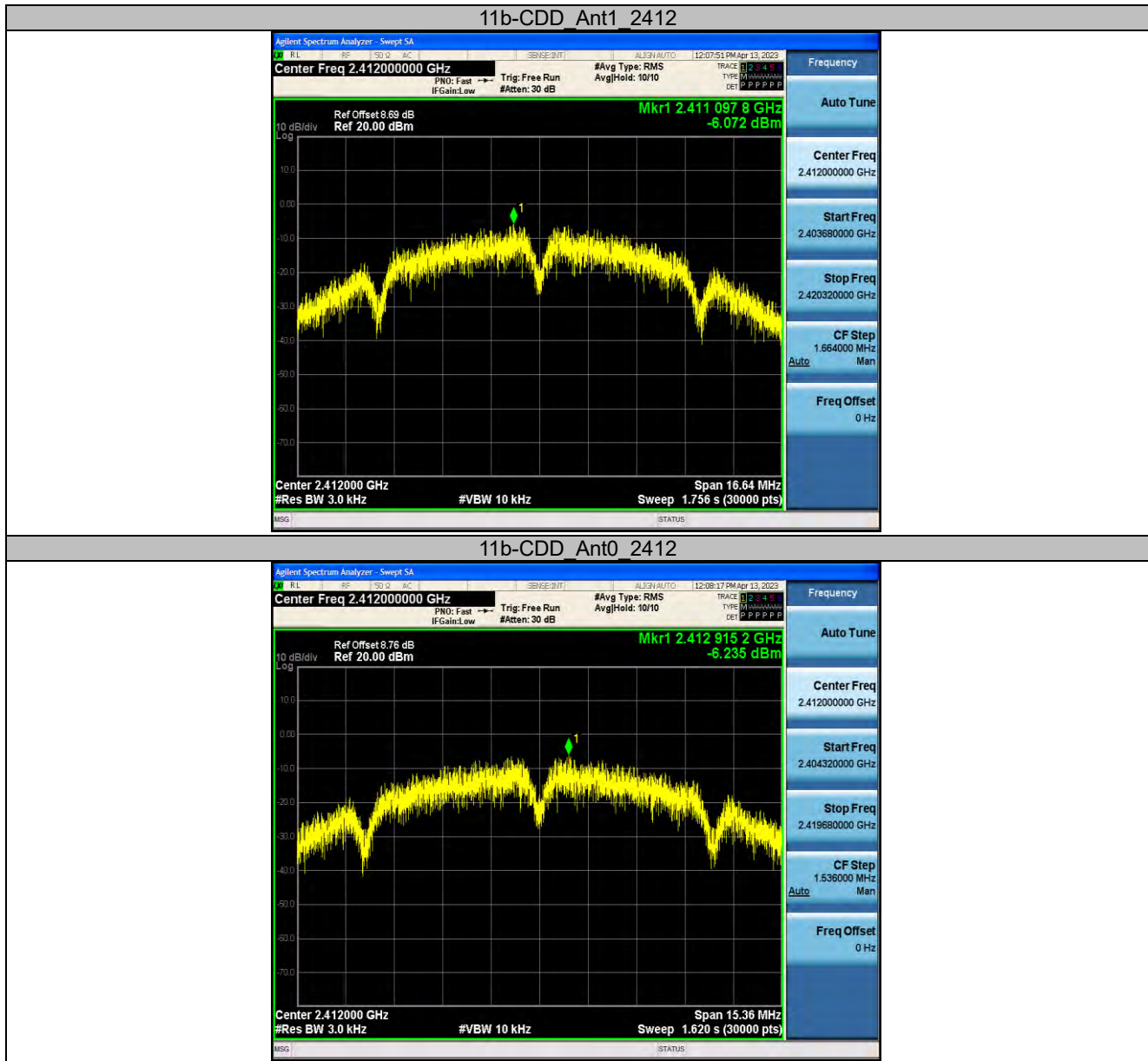

Unless otherwise agreed in writing, this document is issued by the Company subject to its General Conditions of Service printed overleaf, available on request or accessible at <http://www.sgs.com/en/Terms-and-Conditions.aspx> and, for electronic format documents, subject to Terms and Conditions for Electronic Documents at <http://www.sgs.com/en/Terms-and-Conditions/Terms-e-Documents.aspx>. Attention is drawn to the limitation of liability, indemnification and jurisdiction issues defined therein. Any holder of this document is advised that information contained hereon reflects the Company's findings at the time of its intervention only and within the limits of Client's instructions, if any. The Company's sole responsibility is to its Client and this document does not exonerate parties to a transaction from exercising all their rights and obligations under the transaction documents. This document cannot be reproduced except in full, without prior written approval of the Company. Any unauthorized alteration, forgery or falsification of the content or appearance of this document is unlawful and offenders may be prosecuted to the fullest extent of the law. Unless otherwise stated the results shown in this test report refer only to the sample(s) tested and such sample(s) are retained for 30 days only.

Attention: To check the authenticity of testing / inspection report & certificate, please contact us at telephone: (86-755) 8307 1443, or email: [CN.Doccheck@sgs.com](mailto:CN.Doccheck@sgs.com)

SGS-CSTC Standards Technical Services (Xi'an) Co., Ltd. 1/F, Unit D, Building 1, Kanghong Orange Science Park, No.137, Keyuan 3rd Road, Fengdong New Town, Xi'an, Shaanxi, China 710086 t (86-29) 6282 7885 www.sgsgroup.com.cn  
 中国·西安·沣东新城科源三路137号康鸿橙方科技园1号楼D单元1层 邮编: 710086 t (86-29) 6282 7885 sgs.china@sgs.com