



Antenna Datasheet

Product OC: YEBT038WFA

Version: 1.0

Date: 2023-10-16

Status: Preliminary

Product Name: External WIFI Antenna

Key Features:

Frequency band: 2400–2500 MHz, 5150–5850 MHz

Peak efficiency: 56.74 %

Dimensions: Φ 13mm * 195mm

RoHS Compliant

Overview

Quectel Wi-Fi antenna covers 2.4 GHz and 5 GHz dual-bands, fully satisfying customers' requirements for Wi-Fi 5 and Wi-Fi 6. There are various antenna types, including built-in FPC/PCB antenna, ceramic patch antenna, and other external antennas of different shapes or sizes. The antenna performance meets the customers' demands for efficiency, gain, and radiation and ensures the superior experience of the customers' products in use.

Contents

Overview.....	1
Contents.....	2
1 Specification.....	3
1.1. Electrical.....	3
1.2. Mechanical, Environmental.....	4
2 Drawing.....	5
3 Detailed Performance.....	6
3.1. S-Parameter Test.....	6
3.1.1. VSWR.....	6
3.1.2. Return Loss.....	7
3.2. Radiation Performance Test.....	8
3.2.1. Efficiency.....	8
3.2.2. Average Gain.....	9
3.2.3. Peak Gain.....	10
3.2.4. 3D & 2D Radiation Pattern.....	11
3.2.4.1. Test Condition: Free Space.....	11
Contact Us.....	14
Legal Notices.....	15
Revision History.....	17

1 Specification

Test Condition: Free Space

1.1. Electrical

Electrical	
Frequency Range	2400–2500 MHz, 5150–5850 MHz
Impedance	50 Ω
Polarization	Linear
Radiation Pattern	Omni-directional
Antenna Type	Dipole

Band Specification	Band	Wi-Fi 2G	Wi-Fi 5G			
	Freq. (MHz)	2400 - 2500	5150 - 5250	5250 - 5350	5470 - 5725	5725 - 5850
Max. VSWR		1.4	2.7	2.7	2.6	2.4
Max. Return Loss (dB)		-14.8	-6.8	-6.7	-7.2	-7.6
AVG Eff. (%)		50.8	36.1	34.1	34.0	35.7
AVG AVG Gain (dB)		-3.0	-4.4	-4.7	-4.7	-4.5
Max. Peak Gain (dBi)		-0.1	-0.9	-1.4	-0.3	0.4
VSWR		≤ 2.7				
Return Loss		≤ -6.7 dB				
Peak Gain		≤ 0.4 dBi				

1.2. Mechanical, Environmental

Mechanical	
Antenna Dimensions	Φ13 * 195mm
Material & Color	PC+PBT & Black
Connector Type	RP SMA Male
Mounting Type	Terminal
Weight	Typ.18g
Environmental	
Operation Temperature	-40 °C to +85 °C
Storage Temperature	-40 °C to +85 °C
RoHS Compliant	Yes

2 Drawing

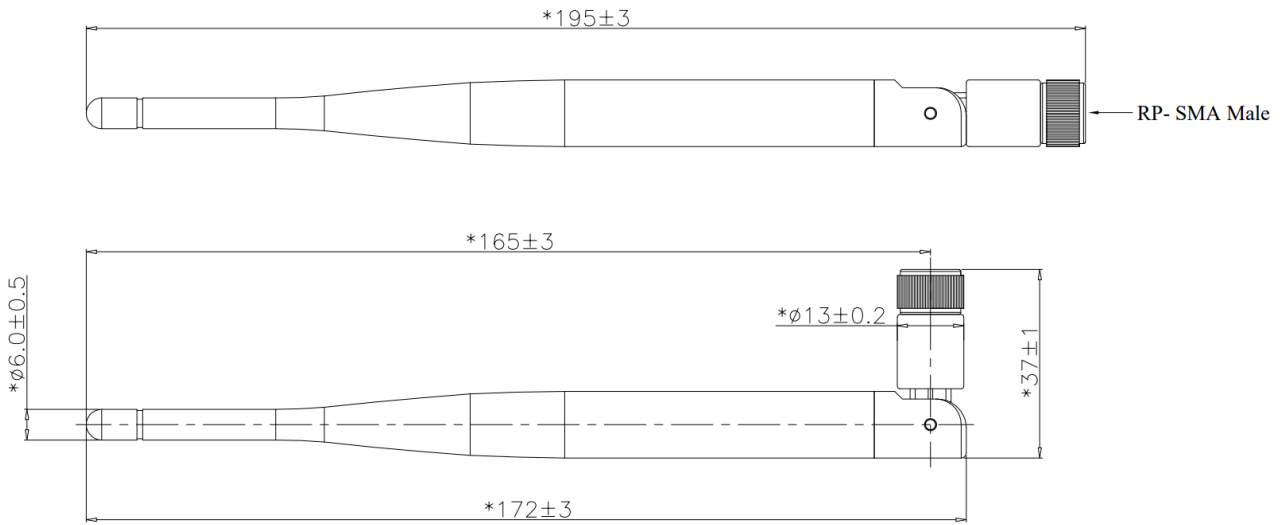

3 Detailed Performance

- Network Analyzer: Keysight E5071C (Device number: QTB6331E; Calibration date: 2022-06-24)
- Chamber: OTA RayZone 2800 GTS (Device number: QTA0709; Calibration date: 2023-07-14)
- Testing Software: Libra

3.1. S-Parameter Test

3.1.1. VSWR

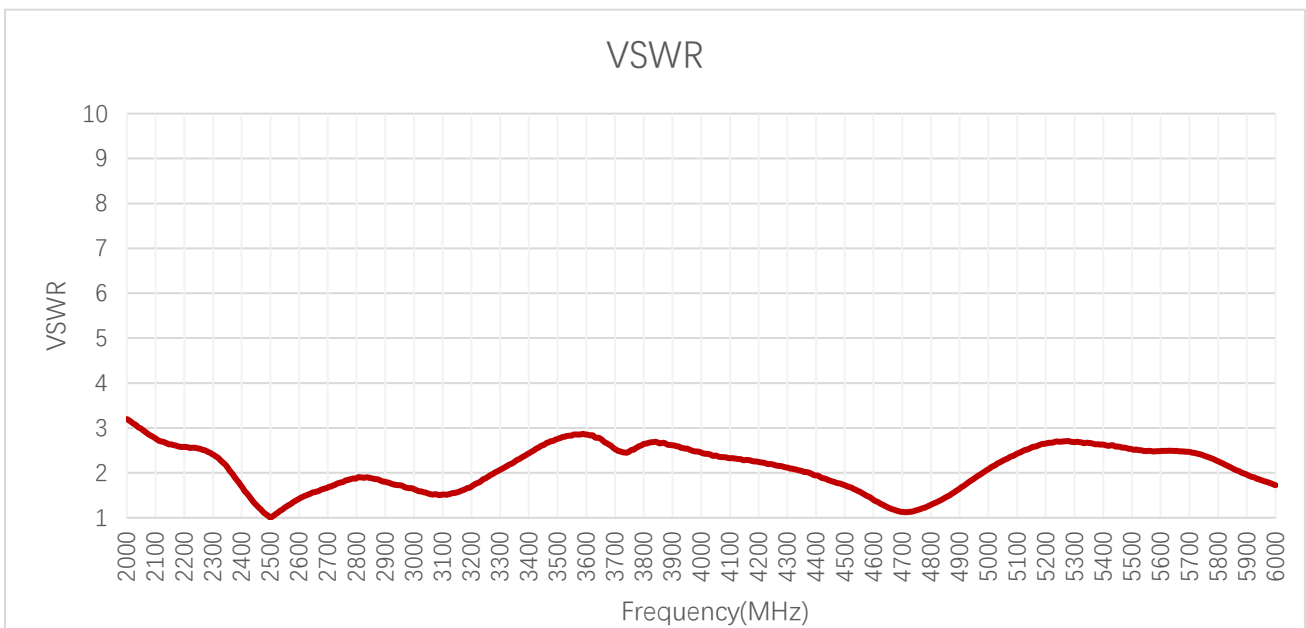

VSWR

Frequency (MHz)	2400	2500	5150	5250	5350	5470	5725	5850
VSWR	1.7	1.0	2.6	2.7	2.7	2.6	2.4	2.1

3.1.2. Return Loss

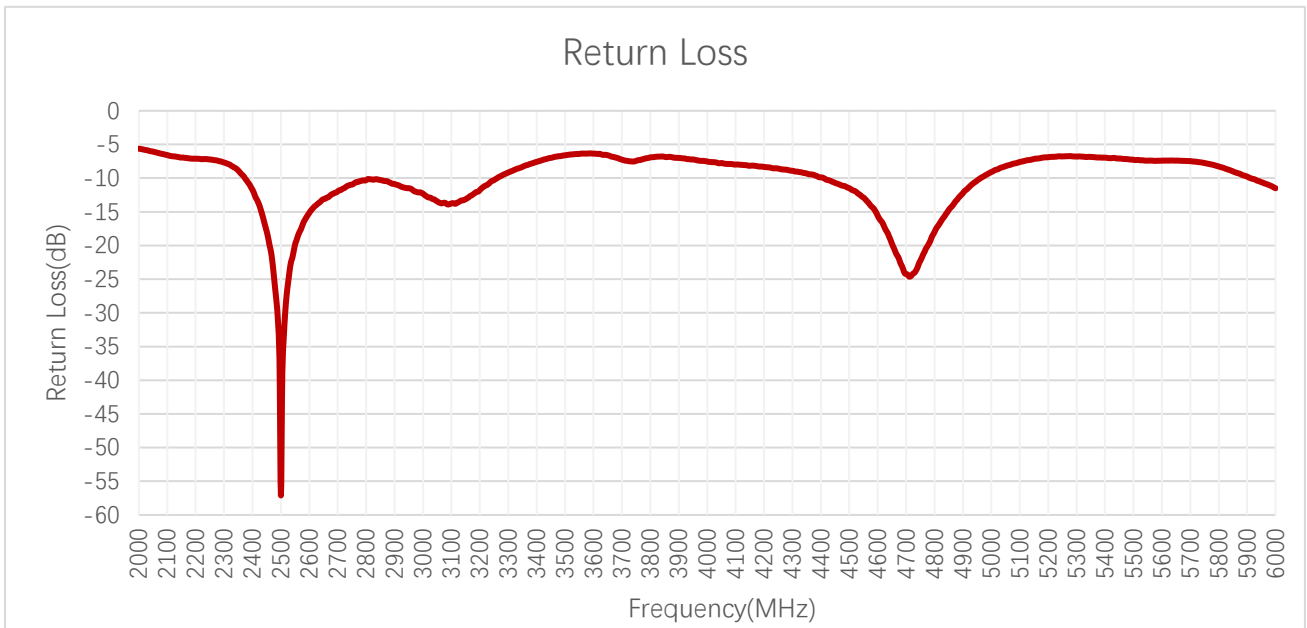

Return Loss (dB)

Frequency (MHz)	2400	2500	5150	5250	5350	5470	5725	5850
Return Loss (dB)	-11.7	-57.1	-7.2	-6.8	-6.9	-7.2	-7.6	-9.0

3.2. Radiation Performance Test

3.2.1. Efficiency

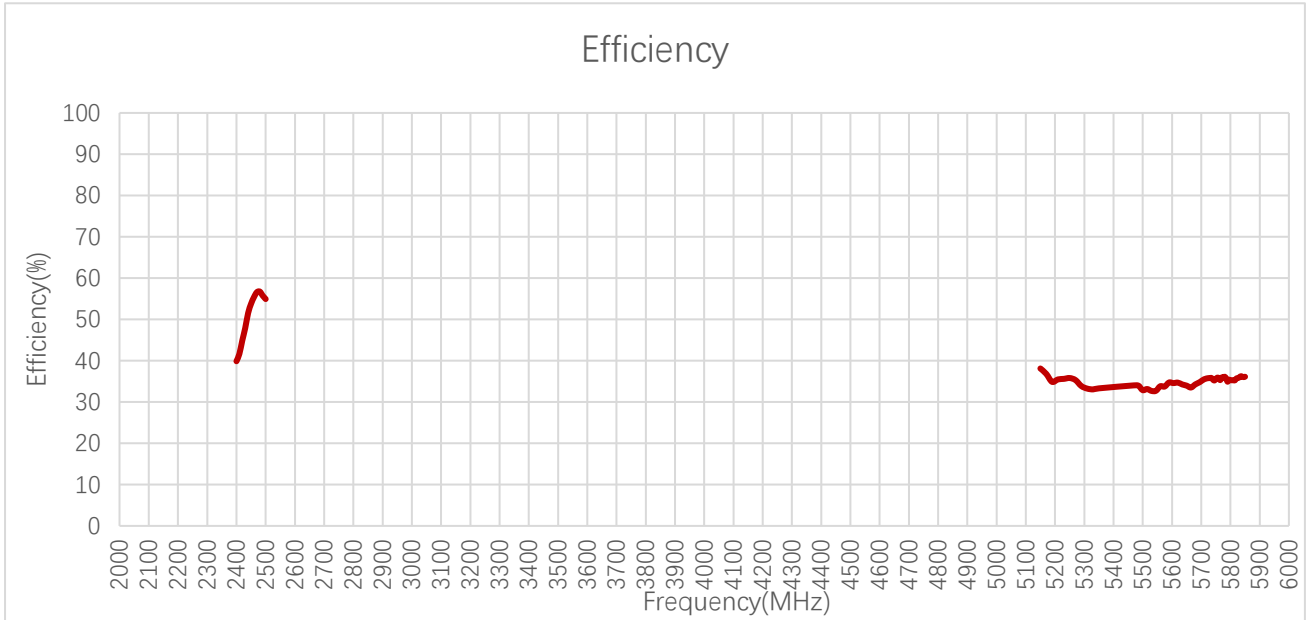

Efficiency (%)

Frequency (MHz)	2400	2500	5150	5250	5350	5470	5725	5850
Efficiency (%)	39.9	54.9	38.1	38.8	33.3	34.0	35.8	36.1

3.2.2. Average Gain

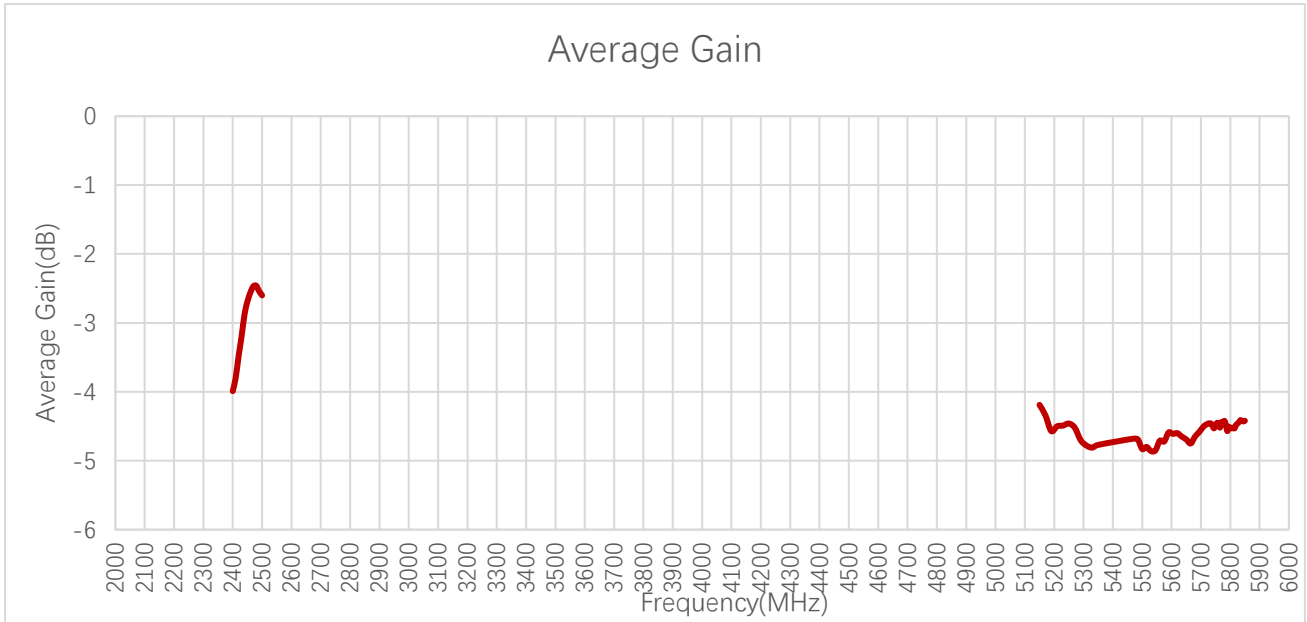

Average Gain (dB)

Frequency (MHz)	2400	2500	5150	5250	5350	5470	5725	5850
Average Gain (dB)	-4.0	-2.6	-4.2	-4.5	-4.8	-4.7	-4.5	-4.4

3.2.3. Peak Gain

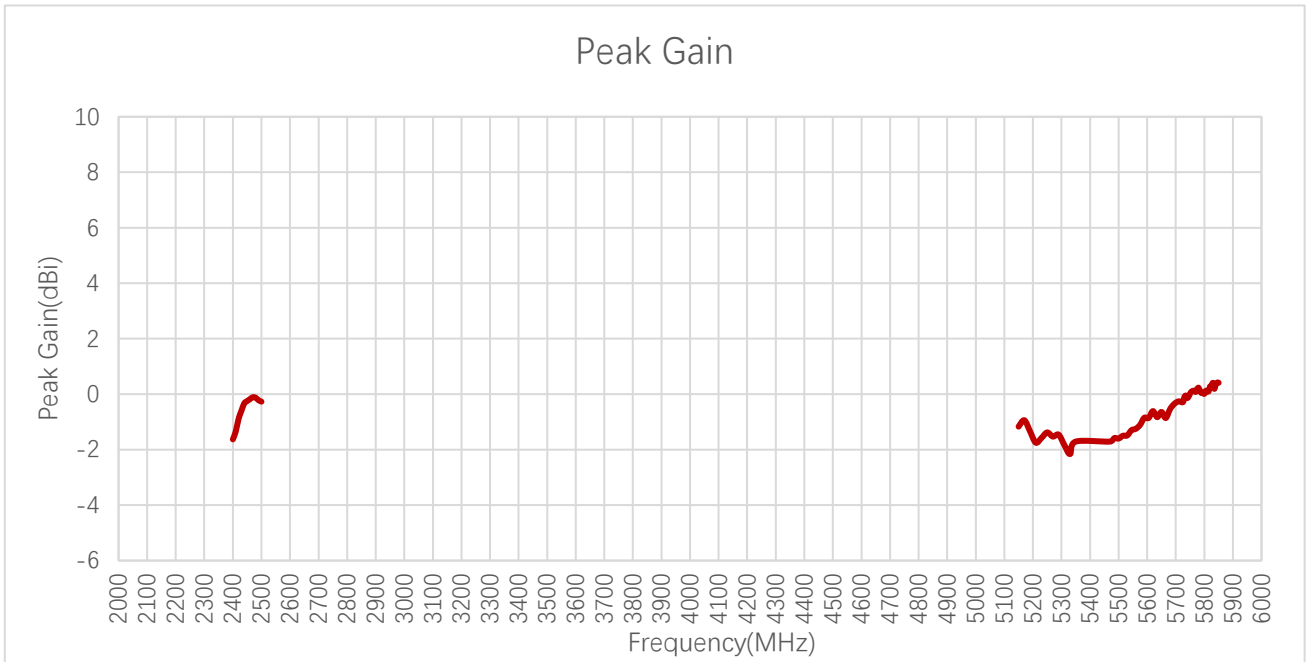

Peak Gain (dBi)

Frequency (MHz)	2400	2500	5150	5250	5350	5470	5725	5850
Peak Gain (dBi)	-1.6	-0.3	-1.2	-1.4	-1.7	-1.7	-0.3	0.4

3.2.4. 3D & 2D Radiation Pattern

3.2.4.1. Test Condition: Free Space

- Test Chamber: HF-G-1

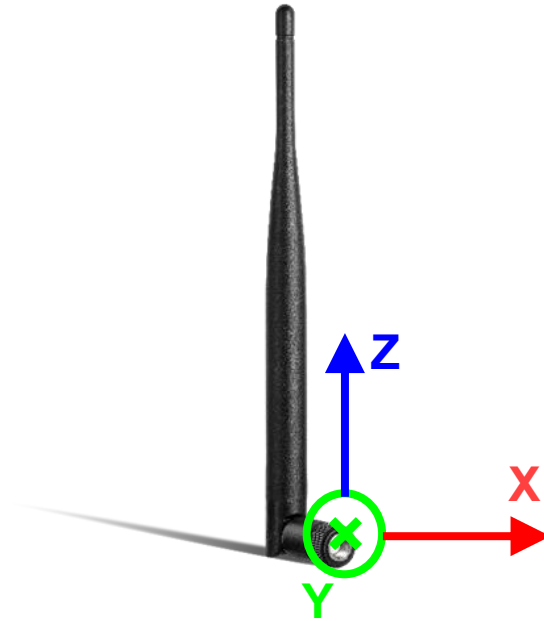

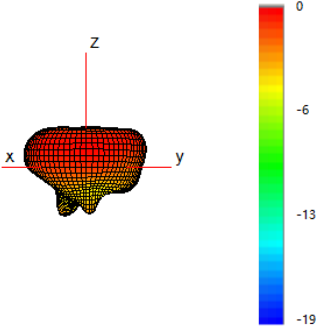
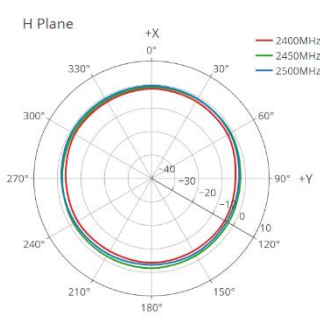
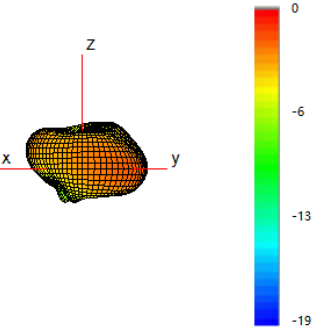
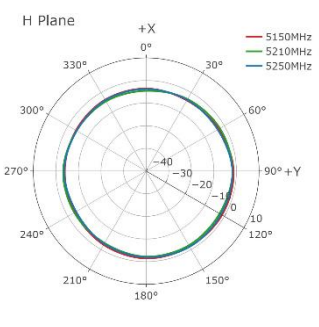
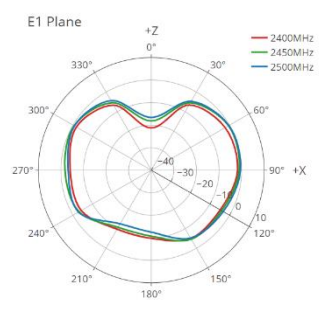
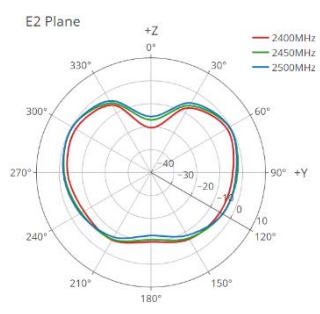
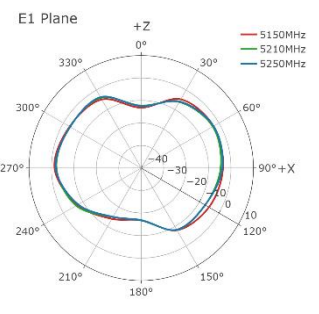
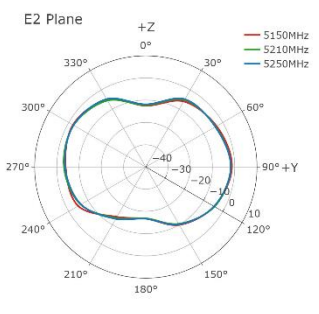
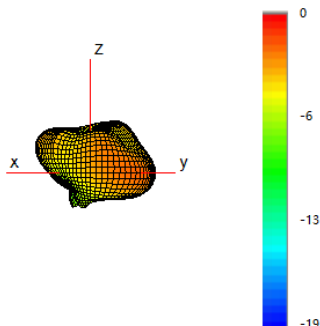
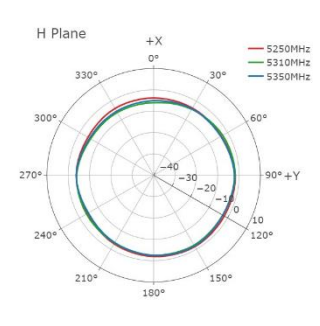
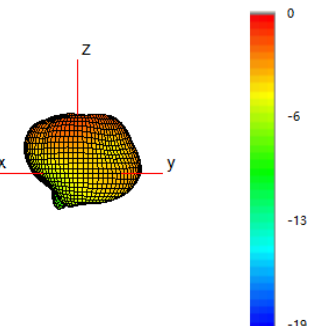
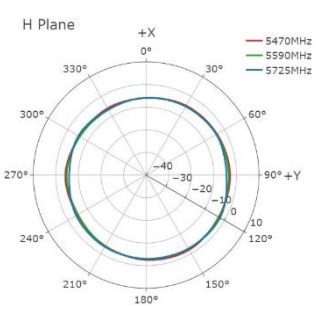
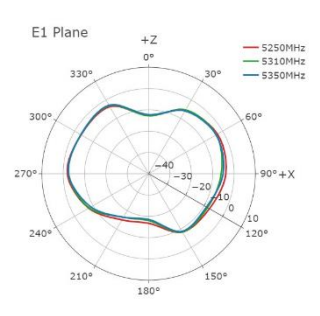
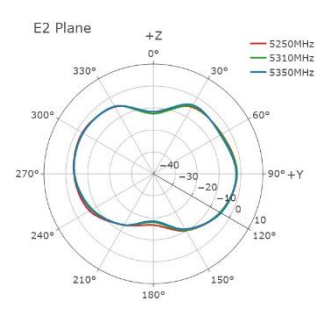
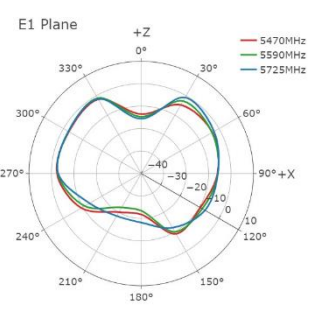
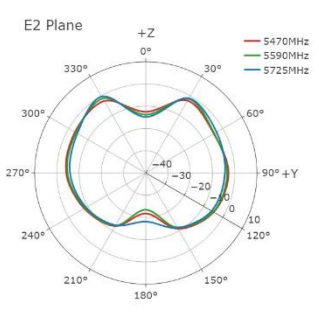
<p style="text-align: center;">2450 MHz</p>		<p style="text-align: center;">5210 MHz</p>	
			
			
<p style="text-align: center;">5310 MHz</p>		<p style="text-align: center;">5590 MHz</p>	
			
			
<p style="text-align: center;">5785MHz</p>			

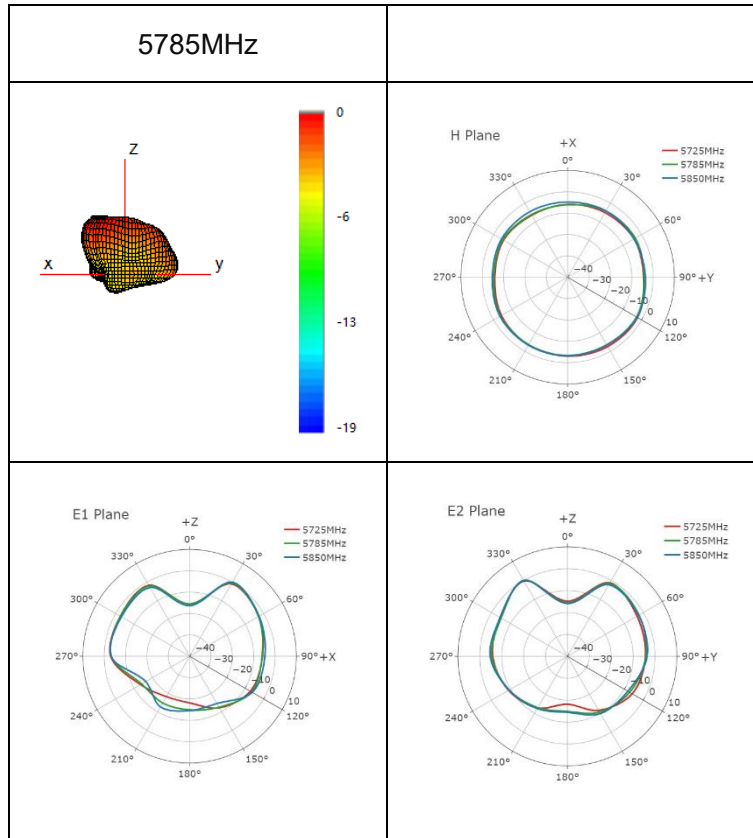

Contact Us

At Quectel, our aim is to provide timely and comprehensive services to our customers. If you require any assistance, please contact our headquarters:

Quectel Wireless Solutions Co., Ltd.

Building 5, Shanghai Business Park Phase III (Area B), No.1016 Tianlin Road, Minhang District, Shanghai 200233, China

Tel: +86 21 5108 6236

Email: info@quectel.com

Or our local offices. For more information, please visit:

<http://www.quectel.com/support/sales.htm>.

For technical support, or to report documentation errors, please visit:

<http://www.quectel.com/support/technical.htm>.

Or email us at: support@quectel.com.

Legal Notices

We offer information as a service to you. The provided information is based on your requirements and we make every effort to ensure its quality. You agree that you are responsible for using independent analysis and evaluation in designing intended products, and we provide reference designs for illustrative purposes only. Before using any hardware, software or service guided by this document, please read this notice carefully. Even though we employ commercially reasonable efforts to provide the best possible experience, you hereby acknowledge and agree that this document and related services hereunder are provided to you on an “as available” basis. We may revise or restate this document from time to time at our sole discretion without any prior notice to you.

Use and Disclosure Restrictions

License Agreements

Documents and information provided by us shall be kept confidential, unless specific permission is granted. They shall not be accessed or used for any purpose except as expressly provided herein.

Copyright

Our and third-party products hereunder may contain copyrighted material. Such copyrighted material shall not be copied, reproduced, distributed, merged, published, translated, or modified without prior written consent. We and the third party have exclusive rights over copyrighted material. No license shall be granted or conveyed under any patents, copyrights, trademarks, or service mark rights. To avoid ambiguities, purchasing in any form cannot be deemed as granting a license other than the normal non-exclusive, royalty-free license to use the material. We reserve the right to take legal action for noncompliance with abovementioned requirements, unauthorized use, or other illegal or malicious use of the material.

Trademarks

Except as otherwise set forth herein, nothing in this document shall be construed as conferring any rights to use any trademark, trade name or name, abbreviation, or counterfeit product thereof owned by Quectel or any third party in advertising, publicity, or other aspects.

Third-Party Rights

This document may refer to hardware, software and/or documentation owned by one or more third parties (“third-party materials”). Use of such third-party materials shall be governed by all restrictions and obligations applicable thereto.

We make no warranty or representation, either express or implied, regarding the third-party materials, including but not limited to any implied or statutory, warranties of merchantability or fitness for a particular purpose, quiet enjoyment, system integration, information accuracy, and non-infringement of any third-party intellectual property rights with regard to the licensed technology or use thereof. Nothing herein constitutes a representation or warranty by us to either develop, enhance, modify, distribute, market, sell, offer for sale, or otherwise maintain production of any our products or any other hardware, software, device, tool, information, or product. We moreover disclaim any and all warranties arising from the course of dealing or usage of trade.

Privacy Policy

To implement module functionality, certain device data are uploaded to Quectel's or third-party's servers, including carriers, chipset suppliers or customer-designated servers. Quectel, strictly abiding by the relevant laws and regulations, shall retain, use, disclose or otherwise process relevant data for the purpose of performing the service only or as permitted by applicable laws. Before data interaction with third parties, please be informed of their privacy and data security policy.

Disclaimer

- a) We acknowledge no liability for any injury or damage arising from the reliance upon the information.
- b) We shall bear no liability resulting from any inaccuracies or omissions, or from the use of the information contained herein.
- c) While we have made every effort to ensure that the functions and features under development are free from errors, it is possible that they could contain errors, inaccuracies, and omissions. Unless otherwise provided by valid agreement, we make no warranties of any kind, either implied or express, and exclude all liability for any loss or damage suffered in connection with the use of features and functions under development, to the maximum extent permitted by law, regardless of whether such loss or damage may have been foreseeable.
- d) We are not responsible for the accessibility, safety, accuracy, availability, legality, or completeness of information, advertising, commercial offers, products, services, and materials on third-party websites and third-party resources.

Copyright © Quectel Wireless Solutions Co., Ltd. 2023. All rights reserved.

Revision History

Version	Date	Author	Note
-	2023-10-16	Sly Liu Lucky Feng Aria Chu	Creation of the document
1.0	2023-10-16	Sly Liu Lucky Feng Aria Chu	First official release

QUECTEL

www.quectel.com