

# RF MEASUREMENT REPORT

---

**FCC ID:** XMR2023EM160RGL  
**Applicant:** Quectel Wireless Solutions Co., Ltd  
**Product:** LTE-A Cat 16 M.2 Module  
**Model No.:** EM160R-GL  
**Brand Name:** QUECTEL  
**FCC Rule(s):** Part 96  
**Result:** Complies  
**Received Date:** 2024-01-05  
**Test Date:** 2020-06-19 ~ 2020-08-15 (LTE Band 48)  
2024-01-11 ~ 2024-01-18 (LTE Band 42/43)

**Reviewed By:**

\_\_\_\_\_  
Sunny Sun

**Approved By:**

\_\_\_\_\_  
Robin Wu



The test results relate only to the samples tested.

This equipment has been shown to be capable of compliance with the applicable technical standards as indicated in the measurement report and was tested in accordance with the measurement procedures specified in ANSI C63.26-2015. Test results reported herein relate only to the item(s) tested.

The test report shall not be reproduced except in full without the written approval of MRT Technology (Suzhou) Co., Ltd.

---

### Revision History

Report No.	Version	Description	Issue Date	Note
2401RSU007-U3	V01	Initial Report	2024-01-30	Valid

Note: This report is prepared for FCC Class II permissive supplement to FCC ID: XMR2023EM160RGL adding new antenna and enabling LTE Band 42/43 via SW.

---

## CONTENTS

Description	Page
<b>1. General Information.....</b>	<b>5</b>
1.1. Applicant .....	5
1.2. Manufacturer .....	5
1.3. Testing Facility .....	5
1.4. Product Information.....	6
1.5. Radio Specification .....	6
1.6. Description of Available Antennas.....	7
1.7. Test Methodology .....	7
<b>2. Test Configuration .....</b>	<b>8</b>
2.1. Test System Connection Diagram.....	8
2.2. Test Environment Condition .....	8
<b>3. Measuring Instrument .....</b>	<b>9</b>
<b>4. Decision Rules and Measurement Uncertainty.....</b>	<b>12</b>
4.1. Decision Rules .....	12
4.2. Measurement Uncertainty.....	12
<b>5. Test Result.....</b>	<b>13</b>
5.1. Summary.....	13
5.2. Occupied Bandwidth Measurement.....	14
5.2.1. Test Limit .....	14
5.2.2. Test Procedure.....	14
5.2.3. Test Setting .....	14
5.2.4. Test Setup .....	14
5.2.5. Test Result .....	14
5.3. Frequency Stability Measurement .....	15
5.3.1. Test Limit .....	15
5.3.2. Test Procedure.....	15
5.3.3. Test Setting .....	15
5.3.4. Test Setup .....	16
5.3.5. Test Result .....	16
5.4. Equivalent Isotropically Radiated Power Measurement .....	17
5.4.1. Test Limit .....	17
5.4.2. Test Procedure.....	17
5.4.3. Test Setting .....	17
5.4.4. Test Setup .....	18

5.4.5.	Test Result .....	18
5.5.	Band Edge Measurement .....	19
5.5.1.	Test Limit .....	19
5.5.2.	Test Procedure .....	19
5.5.3.	Test Setting .....	19
5.5.4.	Test Setup .....	20
5.5.5.	Test Result .....	20
5.6.	Conducted Spurious Emissions Measurement.....	21
5.6.1.	Test Limit .....	21
5.6.2.	Test Procedure .....	21
5.6.3.	Test Setting .....	21
5.6.4.	Test Setup .....	21
5.6.5.	Test Result .....	21
5.7.	Radiated Spurious Emissions Measurement.....	22
5.7.1.	Test Limit .....	22
5.7.2.	Test Procedure .....	22
5.7.3.	Test Setting .....	22
5.7.4.	Test Setup .....	23
5.7.5.	Test Result .....	24
5.8.	End User Device Additional Requirement (CBSD Protocol) Measurement.....	25
5.8.1.	Test Limit .....	25
5.8.2.	Test Procedure .....	25
5.8.3.	Test Setting .....	25
5.8.4.	Test Result .....	25
<b>Appendix A - Test Result .....</b>		<b>26</b>
A.1	Occupied Bandwidth Test Result.....	26
A.2	Frequency Stability Test Result .....	29
A.3	Equivalent Isotropically Radiated Power Test Result .....	30
A.4	Band Edge Test Result .....	42
A.5	Conducted Spurious Emissions Test Result .....	60
A.6	Radiated Spurious Emissions Test Result .....	63
A.7	End User Device Additional Requirement (CBSD Protocol) Test Result .....	66
<b>Appendix B - Test Setup Photograph .....</b>		<b>68</b>
<b>Appendix C - EUT Photograph .....</b>		<b>69</b>

**1. General Information**

**1.1. Applicant**

Quectel Wireless Solutions Company Limited  
 Building 5, Shanghai Business Park Phase III (Area B), No.1016 Tianlin Road, Minhang District,  
 Shanghai, China 200233

**1.2. Manufacturer**

Quectel Wireless Solutions Company Limited  
 Building 5, Shanghai Business Park Phase III (Area B), No.1016 Tianlin Road, Minhang District,  
 Shanghai, China 200233

**1.3. Testing Facility**

<input checked="" type="checkbox"/>	<p><b>Test Site – MRT Suzhou Laboratory</b></p> <p><b>Laboratory Location (Suzhou - Wuzhong)</b>                      D8 Building, No.2 Tian’edang Rd., Wuzhong Economic Development Zone, Suzhou, China</p> <p><b>Laboratory Location (Suzhou - SIP)</b>                      4b Building, Liando U Valley, No.200 Xingpu Rd., Shengpu Town, Suzhou Industrial Park, China</p> <p><b>Laboratory Accreditations</b></p> <p>A2LA: 3628.01 <span style="float: right;">CNAS: L10551</span></p> <p>FCC: CN1166 <span style="float: right;">ISED: CN0001</span></p> <p>VCCI: <input type="checkbox"/>R-20025 <input type="checkbox"/>G-20034 <input type="checkbox"/>C-20020 <input type="checkbox"/>T-20020  <input type="checkbox"/>R-20141 <input type="checkbox"/>G-20134 <input type="checkbox"/>C-20103 <input type="checkbox"/>T-20104</p>
<input type="checkbox"/>	<p><b>Test Site – MRT Shenzhen Laboratory</b></p> <p><b>Laboratory Location (Shenzhen)</b>                      1G, Building A, Junxiangda Building, Zhongshanyuan Road West, Nanshan District, Shenzhen, China</p> <p><b>Laboratory Accreditations</b></p> <p>A2LA: 3628.02 <span style="float: right;">CNAS: L10551</span></p> <p>FCC: CN1284 <span style="float: right;">ISED: CN0105</span></p>
<input type="checkbox"/>	<p><b>Test Site – MRT Taiwan Laboratory</b></p> <p><b>Laboratory Location (Taiwan)</b>                      No. 38, Fuxing 2nd Rd., Guishan Dist., Taoyuan City 333, Taiwan (R.O.C.)</p> <p><b>Laboratory Accreditations</b></p> <p>TAF: 3261</p> <p>FCC: 291082, TW3261 <span style="float: right;">ISED: TW3261</span></p>

#### 1.4. Product Information

Product Name	LTE-A Cat 16 M.2 Module
Model No.	EM160R-GL
Brand Name	Quectel
IMEI	865361050122902 (Conducted) 865361050122894 (Radiated)
3GPP Specification	WCDMA Band II/IV/V LTE Band 2, 4, 5, 7, 12, 13, 14, 25, 26, 30, 38, 41, 42, 43, 48, 66
Temperature Operating Range	-25 ~ 75 °C
Power Supply Rating	3.1 ~ 4.4Vdc, typical 3.7Vdc
Remark: The information of EUT was provided by the manufacturer, and the accuracy of the information shall be the responsibility of the manufacturer.	

#### 1.5. Radio Specification

E-UTRA Specification	
TX & Rx Frequency Range	Band 42: 3550 ~ 3600 MHz, Band 43: 3600 ~ 3700 MHz Band 48: 3550 ~ 3700 MHz
Modulation	UL up to 64QAM & DL up to 256QAM
Device Type	End User Device
Power Class	3

**1.6. Description of Available Antennas**

Technology	Frequency Range (MHz)	Antenna Type	Model	Max Peak Gain (dBi)
LTE Band 42	3400 ~ 3600	PIFA	Y0QUE00ABDA	2.35
LTE Band 43	3600 ~ 3800		Y0QUE00ABDA	1.94
LTE Band 48	3550 ~ 3700		Y0QUE00ABCA	1.00

Note 1: All antenna information (Antenna type and Peak Gain) is provided by the manufacturer.

Note 2: The typical antennas used to calculate the ERP (EIRP).

**1.7. Test Methodology**

According to the specifications of the manufacturer, the EUT must comply with the requirements of the following standards:

- ANSI C63.26:2015
- FCC CFR 47 Part Part 96
- FCC KDB 971168 D01 v03r01: Power Meas License Digital Systems
- FCC KDB 971168 D02 v02r01: Misc Rev Approv License Devices
- FCC KDB 412172 D01 v01r01: Determining ERP and EIRP
- FCC KDB 940660 D01 v03 Part 96 CBRS Eqpt
- WINNF-TS-0122 V1.0.2: Test and Certification for Citizens Broadband Radio Service (CBRS);  
Conformance and Performance Test Technical Specification; CBS/D/DP as Unit Under Test (UUT)

## 2. Test Configuration

### 2.1. Test System Connection Diagram

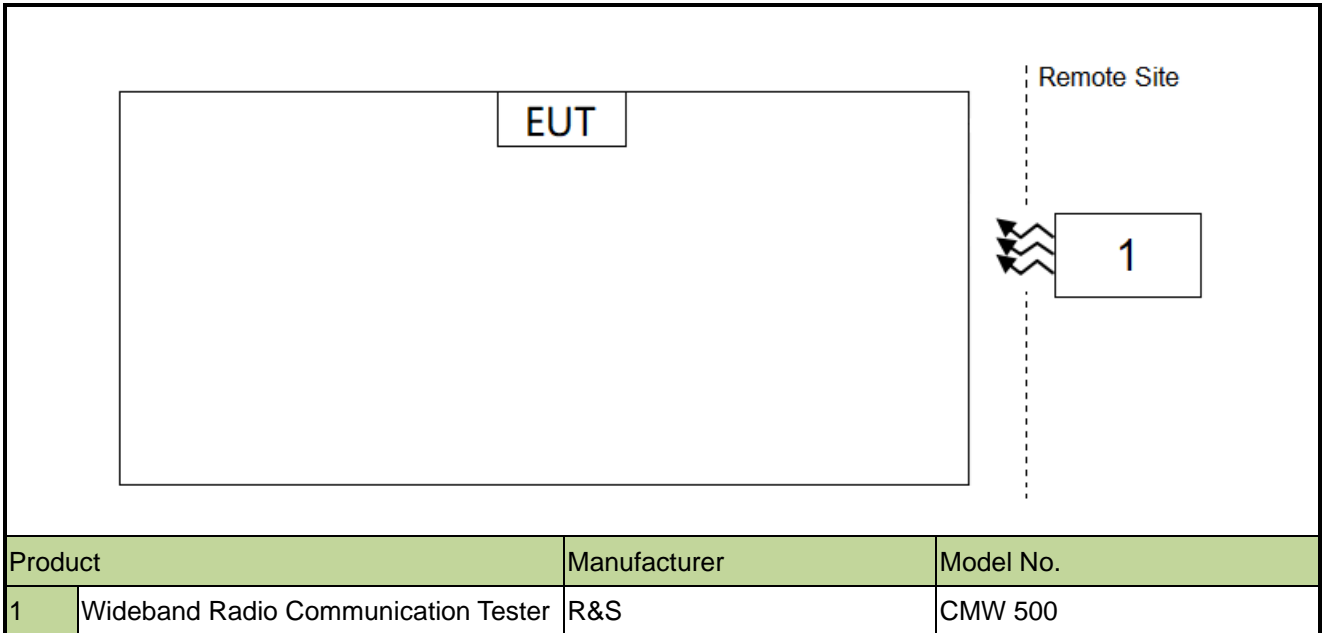

### 2.2. Test Environment Condition

Ambient Temperature	15 ~ 35°C
Relative Humidity	20% ~ 75%RH



### 3. Measuring Instrument

#### Previous test equipment:

Radiated Emission - AC1

Instrument	Manufacturer	Type No.	Asset No.	Cali. Interval	Cali. Due Date
EMI Test Receiver	R&S	ESR7	MRTSUE06001	1 year	2021/08/01
Wideband Radio Communication Tester	R&S	CMW 500	MRTSUE06243	1 year	2020/11/07
PXA Signal Analyzer	Keysight	9030B	MRTSUE06395	1 year	2020/09/03
Loop Antenna	Schwarzbeck	FMZB 1519	MRTSUE06025	1 year	2020/11/10
Bilog Period Antenna	Schwarzbeck	VULB 9168	MRTSUE06172	1 year	2021/03/31
Broad Band Horn Antenna	Schwarzbeck	BBHA 9120D	MRTSUE06023	1 year	2020/10/13
Broad Band Horn Antenna	Schwarzbeck	BBHA 9170	MRTSUE06597	1 year	2021/02/23
Microwave System Amplifier	Agilent	83017A	MRTSUE06076	1 year	2020/11/15
Preamplifier	Schwarzbeck	BBV 9721	MRTSUE06121	1 year	2021/06/11
Thermohyrometer	Testo	608-H1	MRTSUE06403	1 year	2021/08/08
Anechoic Chamber	TDK	Chamber-AC1	MRTSUE06212	1 year	2021/04/30

Radiated Emission - AC2

Instrument	Manufacturer	Type No.	Asset No.	Cali. Interval	Cali. Due Date
Spectrum Analyzer	Keysight	N9038A	MRTSUE06125	1 year	2021/08/01
Wideband Radio Communication Tester	R&S	CMW 500	MRTSUE06243	1 year	2020/11/07
Loop Antenna	Schwarzbeck	FMZB 1519	MRTSUE06025	1 year	2020/11/10
Bilog Period Antenna	Schwarzbeck	VULB 9162	MRTSUE06022	1 year	2020/10/13
Horn Antenna	Schwarzbeck	BBHA9120D	MRTSUE06171	1 year	2020/10/27
Broad Band Horn Antenna	Schwarzbeck	BBHA 9170	MRTSUE06597	1 year	2021/02/23
Broadband Coaxial Preamplifier	Schwarzbeck	BBV 9718	MRTSUE06176	1 year	2020/11/15
Preamplifier	Schwarzbeck	BBV 9721	MRTSUE06121	1 year	2021/06/11
Temperature/Humidity Meter	Minggao	ETH529	MRTSUE06170	1 year	2020/12/15
Anechoic Chamber	RIKEN	Chamber-AC2	MRTSUE06213	1 year	2021/04/30

## Conducted Test Equipment

Instrument	Manufacturer	Type No.	Asset No.	Cali. Interval	Cali. Due Date
EXA Signal Analyzer	Agilent	N9020A	MRTSUE06106	1 year	2021/04/15
EXA Signal Analyzer	Keysight	N9010B	MRTSUE06452	1 year	2021/07/11
Signal Analyzer	R&S	FSV40	MRTSUE06218	1 year	2021/04/15
Wideband Radio Communication Tester	R&S	CMW 500	MRTSUE06243	1 year	2020/11/07
Power Meter	Agilent	U2021XA	MRTSUE06030	1 year	2020/11/18
USB wideband power sensor	Keysight	U2021XA	MRTSUE06446	1 year	2021/06/30
USB wideband power sensor	Keysight	U2021XA	MRTSUE06447	1 year	2021/06/30
Bluetooth Test Set	Anritsu	MT8852B-042	MRTSUE06389	1 year	2021/06/13
Audio Analyzer	Agilent	U8903B	MRTSUE06143	1 year	2021/06/13
Modulation Analyzer	HP	8901A	MRTSUE06098	1 year	2020/10/10
Wideband Radio Communication Tester	R&S	CMW 500	MRTSUE06243	1 year	2020/11/07
DC Power Supply	GWINSTEK	DPS-3303C	MRTSUE06064	N/A	N/A
Temperature & Humidity Chamber	BAOYT	BYH-150CL	MRTSUE06051	1 year	2020/11/07
Thermohygrometer	testo	608-H1	MRTSUE06401	1 year	2021/08/08

Software	Version	Function
EMI Software	V3	EMI Test Software

**Current test equipment:**

Instrument	Manufacturer	Model No.	Asset No.	Cali. Interval	Cali. Due Date	Test Site
Communication Tester	R&S	CMW500	MRTSUE06243	1 year	2024-09-27	SIP-SR1
Thermohygrometer	testo	622	MRTSUE06629	1 year	2024-12-21	SIP-SR1
Communication Tester	R&S	CMW500	MRTSUE06881	1 year	2024-05-23	SIP-SR1
Signal Analyzer	Keysight	N9010B	MRTSUE06559	1 year	2024-12-17	SIP-SR1
DC POWER MODULE	Keysight	N6743B	MRTSUE06905	N/A	N/A	SIP-SR1
DC POWER MODULE	Keysight	N6743B	MRTSUE06906	N/A	N/A	SIP-SR1
Signal Analyzer	Keysight	N9021B	MRTSUE06915	1 year	2024-12-17	SIP-SR1
Temperature Chamber	BAOYT	BYG-80CL	MRTSUE06932	1 year	2024-02-12	SIP-SR1
Shielding Room	MIX-BEP	SIP-SR1	MRTSUE06948	N/A	N/A	SIP-SR1
Directional Coupler	MVE	MVE4816-10	MRTSUE11117	1 year	2024-08-24	SIP
Radio Communication Analyzer	Anritsu	MT8821C	MRTSUE06960	1 year	2024-07-06	WZ-SR6
TRILOG Antenna	Schwarzbeck	VULB 9162	MRTSUE06022	1 year	2024-05-15	WZ-AC2
Loop Antenna	Schwarzbeck	FMZB 1519	MRTSUE06025	1 year	2024-09-17	WZ-AC2
EMI Test Receiver	Agilent	N9038A	MRTSUE06125	1 year	2024-05-23	WZ-AC2
Horn Antenna	Schwarzbeck	BBHA 9120D	MRTSUE06171	1 year	2024-10-11	WZ-AC2
Preamplifier	Schwarzbeck	BBV 9718	MRTSUE06176	1 year	2024-05-07	WZ-AC2
Anechoic Chamber	RIKEN	WZ-AC2	MRTSUE06213	1 year	2024-04-20	WZ-AC2
Horn Antenna	Schwarzbeck	BBHA 9170	MRTSUE06597	1 year	2024-11-04	WZ-AC2
Preamplifier	EMCI	EMC184045SE	MRTSUE06640	1 year	2025-01-11	WZ-AC2
Preamplifier	EMCI	EMC051845SE	MRTSUE06987	1 year	2024-09-07	WZ-AC2
Thermohygrometer	testo	608-H1	MRTSUE11038	1 year	2024-10-25	WZ-AC2
Thermohygrometer	testo	608-H1	MRTSUE11263	1 year	2024-11-07	WZ-AC2
Directional Coupler	MVE	MVE4912-10	MRTSUE07051	1 year	2024-08-23	WZ
Attenuator	MVE	MVE2365	MRTSUE07070	1 year	2024-11-27	WZ
Attenuator	MVE	MVE2365	MRTSUE07071	1 year	2024-11-27	WZ

Software	Version	Function
EMI Software	V3.0.0	EMI Test Software
Controller_MF 7802	2.03C	RE Antenna & Turntable

## 4. Decision Rules and Measurement Uncertainty

### 4.1. Decision Rules

The Decision Rule is based on Simple Acceptance in accordance with ISO Guide 98-4: 2012 Clause 8.2. (Measurement uncertainty is not taken into account when stating conformity with a specified requirement.)

### 4.2. Measurement Uncertainty

Where relevant, the following test uncertainty levels have been estimated for tests performed on the EUT as specified in CISPR 16-4-2. This uncertainty represents an expanded uncertainty expressed at approximately the 95% confidence level using a coverage factor of  $k = 2$ .

<b>Radiated Spurious Emissions</b>
<p>The maximum measurement uncertainty is evaluated as:</p> <p>Coaxial: 9kHz~30MHz: 2.59dB</p> <p>Coplanar: 9kHz~30MHz: 2.60dB</p> <p>Horizontal: 30MHz~200MHz: 3.85dB 200MHz~1GHz: 4.36dB 1GHz~40GHz: 4.98dB</p> <p>Vertical: 30MHz~200MHz: 4.06dB 200MHz~1GHz: 5.28dB 1GHz~40GHz: 4.91dB</p>
<b>Conducted Spurious Emissions</b>
<p>Measuring Uncertainty for a Level of Confidence of 95% (<math>U=2Uc(y)</math>): 1.47dB</p>
<b>Output Power</b>
<p>Measuring Uncertainty for a Level of Confidence of 95% (<math>U=2Uc(y)</math>): 0.66dB</p>
<b>Occupied Bandwidth</b>
<p>Measuring Uncertainty for a Level of Confidence of 95% (<math>U=2Uc(y)</math>): 69.28kHz</p>
<b>Frequency Stability</b>
<p>Measuring Uncertainty for a Level of Confidence of 95% (<math>U=2Uc(y)</math>): 8.04Hz</p>

## 5. Test Result

### 5.1. Summary

FCC Part Section(s)	Test Description	Test Condition	Test Result
2.1049	Occupied Bandwidth	Conducted	Pass
2.1055	Frequency Stability		Pass
96.41(b)	Equivalent Isotropic Radiated Power		Pass
2.1051 96.41(e)	Spurious Emissions; Band Edge Emissions		Pass
2.1053, 96.41(e)	Spurious Emissions	Radiated	Pass
96.47	End User Device Additional Requirements (CBSD Protocol)		Pass

#### Notes:

- 1) The analyzer plots shown in this section were all taken with a correction table loaded into the analyzer. The correction table was used to account for the losses of the cables and attenuators used as part of the system to connect the EUT to the analyzer at all frequencies of interest.
- 2) All supported modulation types were evaluated. The worst-case emission of modulation was selected. Therefore, the Frequency Stability, Occupied Bandwidth, Channel Band Edge, Radiated & Conducted Spurious Emission were presented worst-case in the test report.
- 3) For radiated emission tests, every axis (X, Y, Z) was also verified. The test results shown in the following sections represent the worst-case emissions.
- 4) LTE Band 48 (3550 ~ 3700 MHz) overlaps the entire frequency range of LTE Band 42 (3550 ~ 3600 MHz). Therefore, test data provided in this report covers Band 42 as well as Band 48.  
 LTE Band 48 (3550 ~ 3700 MHz) overlaps the entire frequency range of LTE Band 43 (3600 ~ 3700 MHz). Therefore, test data provided in this report covers Band 43 as well as Band 48.

## 5.2. Occupied Bandwidth Measurement

### 5.2.1. Test Limit

The occupied bandwidth, that is the frequency bandwidth such that, below its lower and above its upper frequency limits, the mean powers radiated are each equal to 0.5 percent of the total mean power radiated by a given emission shall be measured.

### 5.2.2. Test Procedure

ANSI C63.26-2015 - Section 5.4

### 5.2.3. Test Setting

1. Set center frequency to the nominal EUT channel center frequency
2. RBW = The nominal RBW shall be in the range of 1% to 5% of the anticipated OBW
3.  $VBW \geq 3 \times RBW$
4. Detector = Peak
5. Trace mode = max hold
6. Sweep = auto couple
7. Allow the trace to stabilize
8. Use the 99% power bandwidth function of the instrument and report the measured bandwidth.

### 5.2.4. Test Setup

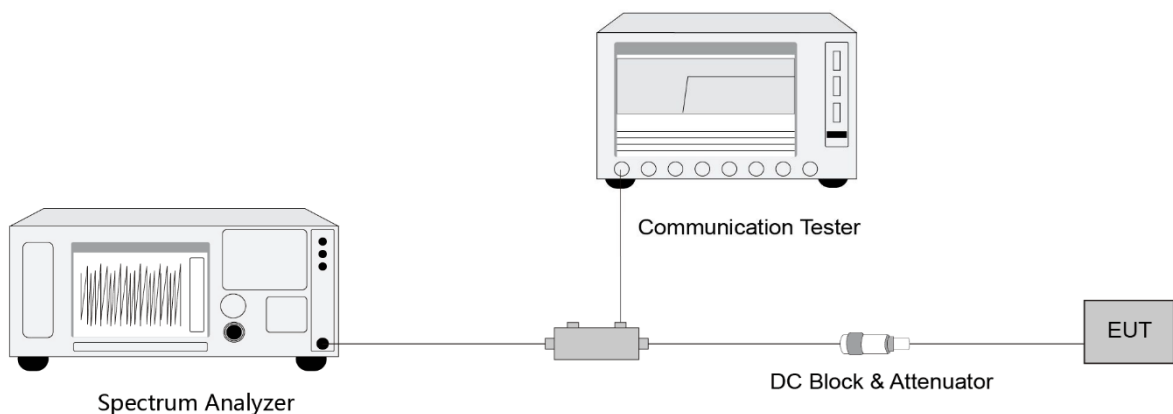

### 5.2.5. Test Result

Refer to Appendix A.1.

### **5.3. Frequency Stability Measurement**

#### **5.3.1. Test Limit**

The frequency stability shall be measured by variation of ambient temperature and variation of primary supply voltage to ensure that the fundamental emission stays within the authorized frequency block. The frequency stability of the transmitter shall be maintained within  $\pm 0.00025\%$  ( $\pm 2.5\text{ppm}$ ) of the center frequency.

#### **5.3.2. Test Procedure**

ANSI C63.26-2015 - Section 5.4 & 5.6

#### **5.3.3. Test Setting**

1. Use the occupied bandwidth function of the instrument and record the low edge for low channel occupancy bandwidth and the high edge for high channel occupancy bandwidth.
2. Change the temperature of equipment and repeat Steps 1.
3. Change the Voltage of equipment and repeat Steps 1.
4. Use the frequency error function of the instrument and record the frequency error.
5. Change the temperature of equipment and repeat Steps 4.
6. Change the Voltage of equipment and repeat Steps 4.

#### **Frequency Stability Under Temperature Variations:**

The equipment under test was connected to an external AC or DC power supply and input rated voltage. RF output was connected to a frequency counter or spectrum analyzer via feed through attenuators. The EUT was placed inside the temperature chamber. Set the spectrum analyzer RBW low enough to obtain the desired frequency resolution and measure EUT 20°C operating frequency as reference frequency. Turn EUT off and set the chamber temperature to highest. After the temperature stabilized for approximately 30 minutes recorded the frequency. Repeat step measure with 10°C decreased per stage until the lowest temperature reached.

#### **Frequency Stability Under Voltage Variations:**

Set chamber temperature to 20°C. Use a variable AC power supply / DC power source to power the EUT and set the voltage to rated voltage. Set the spectrum analyzer RBW low enough to obtain the desired frequency resolution and recorded the frequency.

Reduce the input voltage to specify extreme voltage variation ( $\pm 15\%$ ) and endpoint, record the maximum frequency change.

### 5.3.4. Test Setup

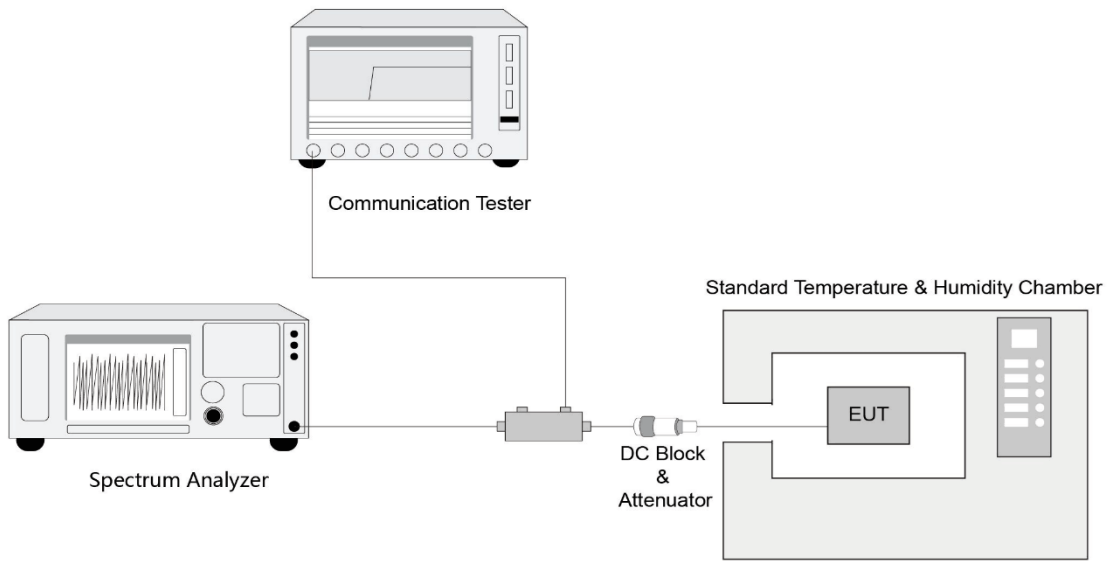

### 5.3.5. Test Result

Refer to Appendix A.2.



## 5.4. Equivalent Isotropically Radiated Power Measurement

### 5.4.1. Test Limit

The maximum effective isotropic radiated power (EIRP) End User Device is 23dBm/10MHz

### 5.4.2. Test Procedure

ANSI C63.26-2015 - Section 5.2.4.4.2 & 5.2.5.5

### 5.4.3. Test Setting

When the fundamental condition for average power measurements cannot be realized (i.e., the EUT can not be configured to transmit at full-power on a continuous basis (i.e., duty cycle < 98%) and the instrumentation cannot be configured to measure only during active full-power transmissions), then the following procedure can be used if the EUT duty cycle is constant (i.e., duty cycle variations are less than or equal to  $\pm 2\%$ ).

- a) Set span to 2 × to 3 × the OBW.
- b) Set RBW = 1% to 5% of the OBW.
- c) Set VBW  $\geq 3 \times$  RBW.
- d) Set number of measurement points in sweep  $\geq 2 \times$  span / RBW.
- e) Sweep time:
  - 1) Set = auto-couple, or
  - 2) Set  $\geq [10 \times (\text{number of points in sweep}) \times (\text{transmission symbol period})]$  for single sweep (automation-compatible) measurement.
- f) Detector = power averaging (rms).
- g) Set sweep trigger to “free run.”
- h) Trace average at least 100 traces in power averaging (rms) mode if sweep is set to auto-couple. To accurately determine the average power over the on and off time of the transmitter, it can be necessary to increase the number of traces to be averaged above 100, or if using a manually configured sweep time, increase the sweep time.
- i) Using the marker function to identify the maximum PSD.
- j) Add  $10 \log (1/\text{duty cycle})$  to the measured power level to compute the average power during continuous transmission. For example, add  $[10 \log (1/0.25)] = 6 \text{ dB}$  if the duty cycle is a constant 25%.

The relevant equation for determining the maximum ERP or EIRP from the measured RF output power is given in Equation (1) as follows:

$$\text{ERP or EIRP} = P_{\text{Meas}} + G_T \quad (1)$$

where

ERP or EIRP effective radiated power or equivalent isotropically radiated power, respectively (expressed in the same units as  $P_{\text{Meas}}$ , e.g., dBm or dBW)

$P_{\text{Meas}}$  measured transmitter output power or PSD, in dBm or dBW

$G_T$  gain of the transmitting antenna, in dBd (ERP) or dBi (EIRP)

For devices utilizing multiple antennas, see 6.4 for guidance with respect to determining the effective array transmit antenna gain term to be used in the above equation.

#### 5.4.4. Test Setup

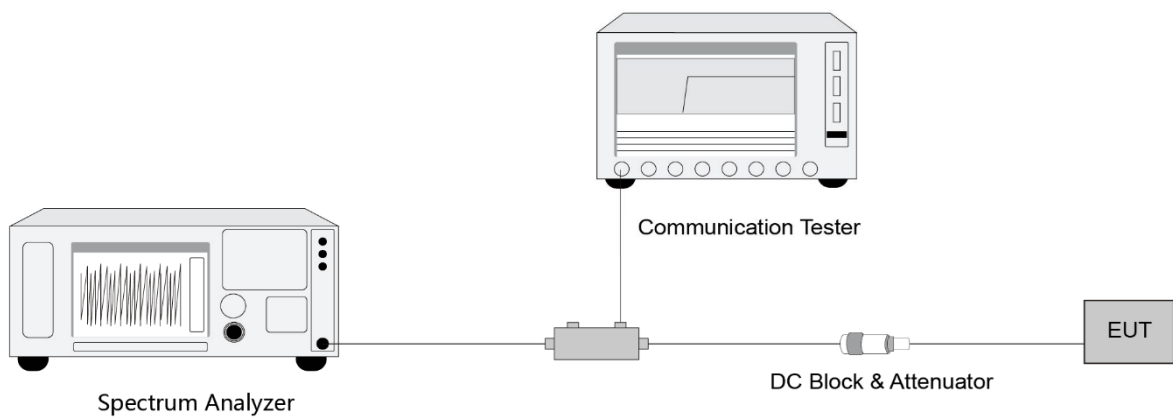

#### 5.4.5. Test Result

Refer to Appendix A.3.

## 5.5. Band Edge Measurement

### 5.5.1. Test Limit

All out of band emissions are measured with a spectrum analyzer connected to the antenna terminal of the EUT while the EUT is operating at its maximum duty cycle, at maximum power, and at the appropriate frequencies. All data rates were investigated to determine the worst-case configuration. All modes of operation were investigated, and the worst-case configuration results are reported in this section.

The conducted power of any emission outside the fundamental emission (whether in or outside of the authorized band) shall not exceed  $-13$  dBm/MHz within 0-10 megahertz above the upper SAS-assigned channel edge and within 0-10 megahertz below the lower SAS-assigned channel edge. At all frequencies greater than 10 megahertz above the upper SAS assigned channel edge and less than 10 MHz below the lower SAS assigned channel edge, the conducted power of any emission shall not exceed  $-25$  dBm/MHz. The conducted power of any emissions below 3530 MHz or above 3720 MHz shall not exceed  $-40$  dBm/MHz.

### 5.5.2. Test Procedure

ANSI C63.26-2015 - Section 5.7

### 5.5.3. Test Setting

1. Set the analyzer frequency to low, middle, high channel.
2.  $RBW \geq$  The nominal RBW shall be in the range of 1% of the anticipated OBW (in the 1MHz band immediately outside and adjacent to the band edge). For improvement of the accuracy in the measurement of the average power of a noise-like emission, a RBW narrower than the specified reference bandwidth can be used (generally limited to no less than 1% of the OBW), provided that a subsequent integration is performed over the full required measurement bandwidth. This integration should be performed using the spectrum analyzer's band power functions.
3.  $VBW \geq 3*RBW$
4. Sweep time = auto
5. Detector = power averaging (rms)
6. Set sweep trigger to "free run."
7. User gate triggered such that the analyzer only sweeps when the device is transmitting at full power
8. Trace average at least 100 traces in power averaging (rms) mode if sweep is set to auto-couple. To accurately determine the average power over the on and off time of the transmitter, it can be necessary to increase the number of traces to be averaged above 100, or if using a manually configured sweep time,

increase the sweep time.

9. Used power integration when using a measurement bandwidth smaller than the specified bandwidth.

#### 5.5.4. Test Setup

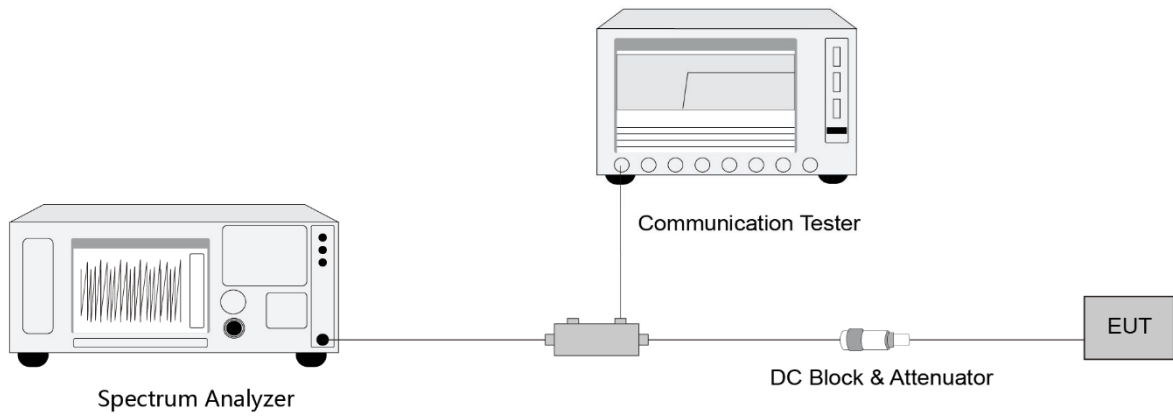

#### 5.5.5. Test Result

Refer to Appendix A.4.

## **5.6. Conducted Spurious Emissions Measurement**

### **5.6.1. Test Limit**

The level of the carrier and the various conducted spurious and harmonic frequencies is measured by means of a calibrated spectrum analyzer. The spectrum is scanned from the lowest frequency generated in the equipment up to a frequency including its 10<sup>th</sup> harmonic. All out of band emissions are measured with a spectrum analyzer connected to the antenna terminal of the EUT while the EUT is operating at its maximum duty cycle, at maximum power, and at the appropriate frequencies. All data rates were investigated to determine the worst-case configuration. All modes of operation were investigated, and the worst-case configuration results are reported in this section.

The conducted power of any emissions below 3530MHz or above 3720MHz shall not exceed -40dBm/MHz.

### **5.6.2. Test Procedure**

ANSI C63.26-2015 - Section 5.7

### **5.6.3. Test Setting**

1. Set the analyzer frequency to low, mid, high channel.
2. RBW = 1MHz
3. VBW  $\geq$  3\*RBW
4. Sweep time = auto
5. Detector = power averaging (rms)
6. Set sweep trigger to "free run."
7. User gate triggered such that the analyzer only sweeps when the device is transmitting at full power.
8. Trace average at least 100 traces in power averaging (rms) mode if sweep is set to auto-couple. To accurately determine the average power over the on and off time of the transmitter, it can be necessary to increase the number of traces to be averaged above 100, or if using a manually configured sweep time, increase the sweep time.

### **5.6.4. Test Setup**

### **5.6.5. Test Result**

Refer to Appendix A.5.

## 5.7. Radiated Spurious Emissions Measurement

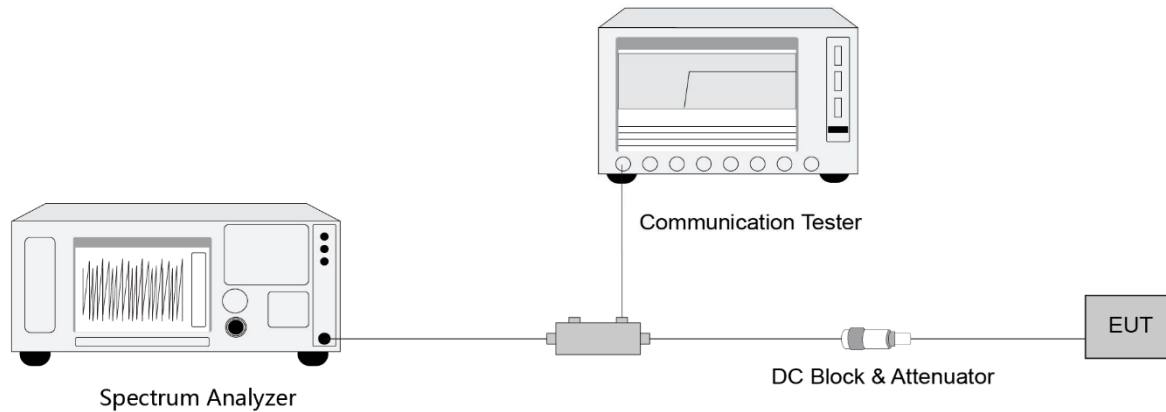

### 5.7.1. Test Limit

Out of band emissions: The power of any emissions below 3530 MHz or above 3720 MHz shall not exceed  $-40\text{dBm/MHz}$ .

$E \text{ (dB}\mu\text{V/m)} = \text{EIRP (dBm)} - 20 \log D + 104.8$ ; where D is the measurement distance in meters. The emission limit equal to  $55.3\text{dB}\mu\text{V/m}$ .

### 5.7.2. Test Procedure

ANSI C63.26-2015 - Section 5.2.7 & 5.5

### 5.7.3. Test Setting

1. RBW = 1MHz
2. VBW  $\geq 3 \times$  RBW
3. Sweep time  $\geq 10 \times$  (number of points in sweep)  $\times$  (transmission symbol period)
4. Detector = Peak
5. Trace mode = max hold
6. The trace was allowed to stabilize

### 5.7.4. Test Setup

#### Below 1GHz Test Setup:

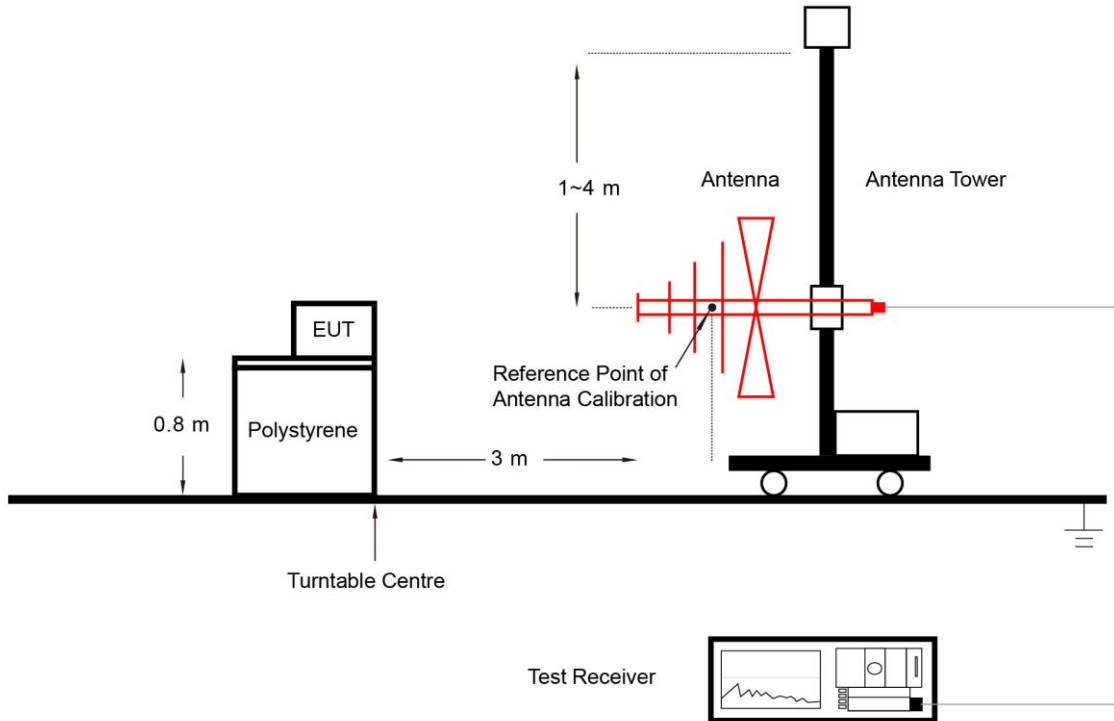

#### Above 1GHz Test Setup:

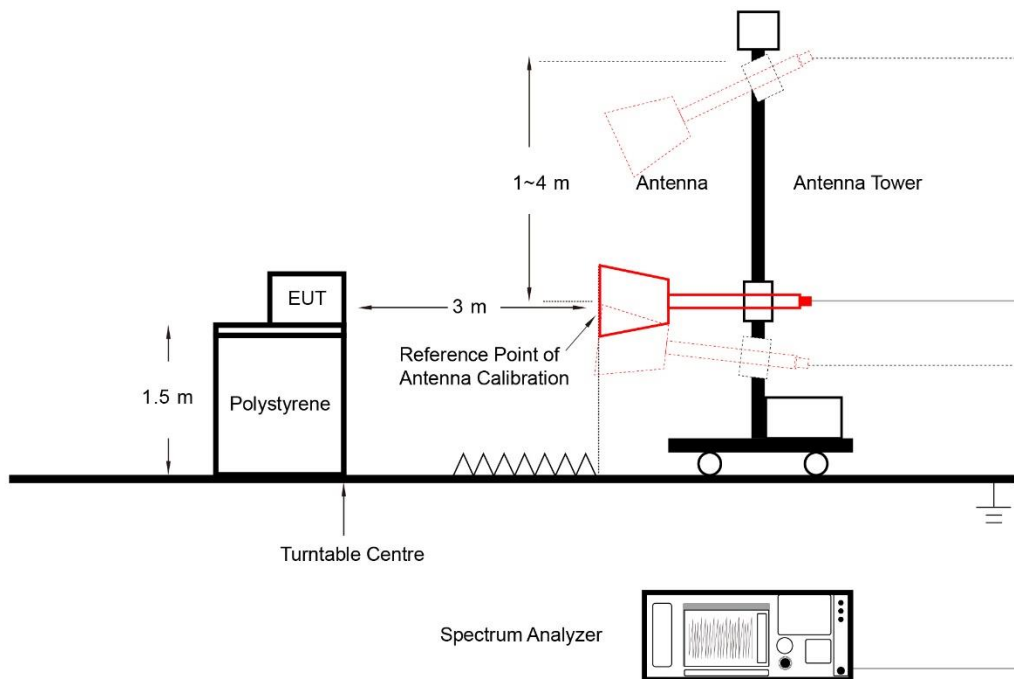

### 5.7.5. Test Result

Refer to Appendix A.6.



## **5.8. End User Device Additional Requirement (CBSD Protocol) Measurement**

### **5.8.1. Test Limit**

End User Devices may operate only if they can positively receive and decode an authorization signal transmitted by aCBSD, including the frequencies and power limits for their operation.

An End User Device must discontinue operations, change frequencies, or change its operational power level within 10 seconds of receiving instructions from its associated CBSD

### **5.8.2. Test Procedure**

KDB 940660 D01 v02, WINNF-TS-0122 V1.0.2

### **5.8.3. Test Setting**

The EUT was connected via an RF cable to a certified CBSD (Sercomm Corp. FCC ID: P27-SCE4255W) and spectrum analyzer. The following procedure is performed by applying WINNF-TS-0122 CBRS CBSD Test Specification.

#### Step 1:

- a. Setup WINNF.PT.C.HBT.1 with 3570 ~ 3590MHz and power level at 6 dBm/MHz.
- b. Enable Smallcell service from EPC Manage Tool.
- c. Check EUT Tx frequency and power.
- d. Disable Smallcell service from EPC Manage Tool and check EUT stop transmission within 10s.

#### Step 2:

- a. Setup WINNF.PT.C.HBT.1 with 3670 ~ 3690MHz and power level at 11 dBm/MHz.
- b. Enable Smallcell service from EPC Manage Tool.
- c. Check EUT Tx frequency and power.
- d. Disable Smallcell service from EPC Manage Tool and check EUT stop transmission within 10s.

### **5.8.4. Test Result**

Refer to Appendix A.7.

## Appendix A - Test Result

### A.1 Occupied Bandwidth Test Result

Test Site	SIP- TR3	Test Engineer	Candy Luo
Test Date	2020/06/26	Test Band	Band 42 & 43/48

Modulation	Frequency (MHz)	Bandwidth (MHz)	99% Bandwidth (MHz)
QPSK	3625.0	5	4.46
		10	8.95
		15	13.39
		20	17.87
16QAM	3625.0	5	4.46
		10	8.93
		15	13.43
		20	17.88
64QAM	3625.0	5	4.46
		10	8.95
		15	13.43
		20	17.88

99% Bandwidth - QPSK

5MHz Channel Bandwidth

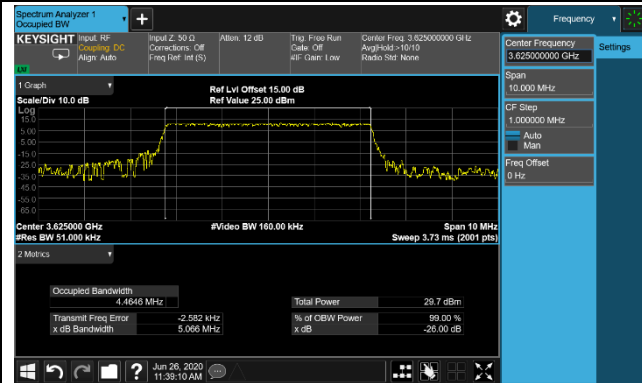

10MHz Channel Bandwidth

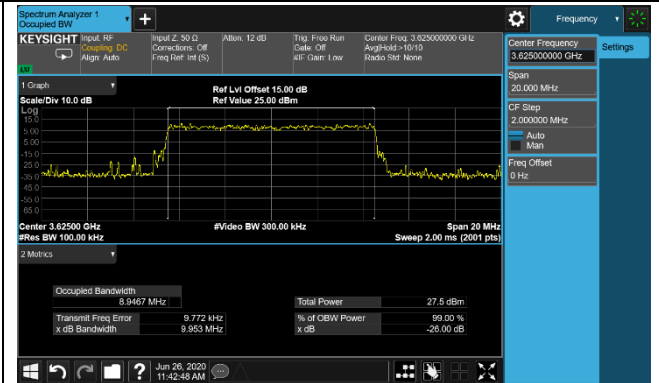

15MHz Channel Bandwidth

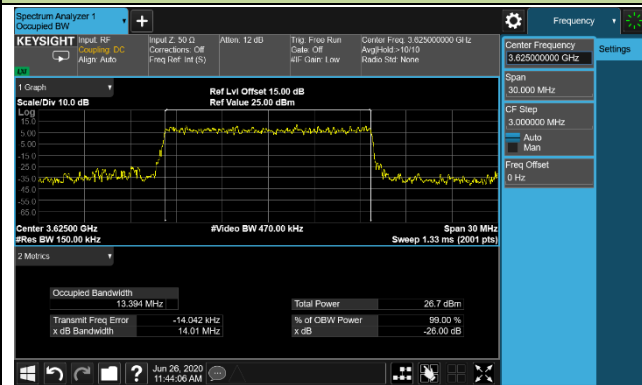

20MHz Channel Bandwidth

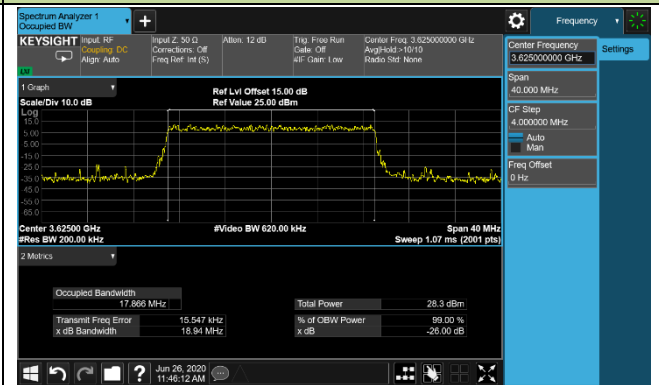

99% Bandwidth - 16QAM

5MHz Channel Bandwidth

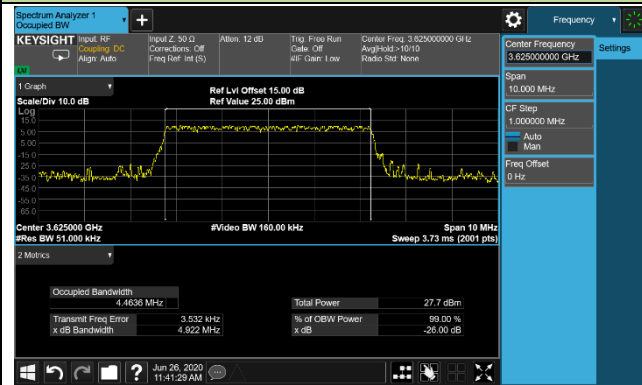

10MHz Channel Bandwidth

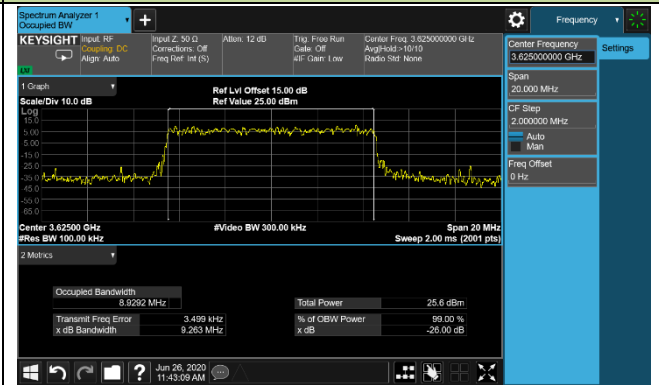

15MHz Channel Bandwidth

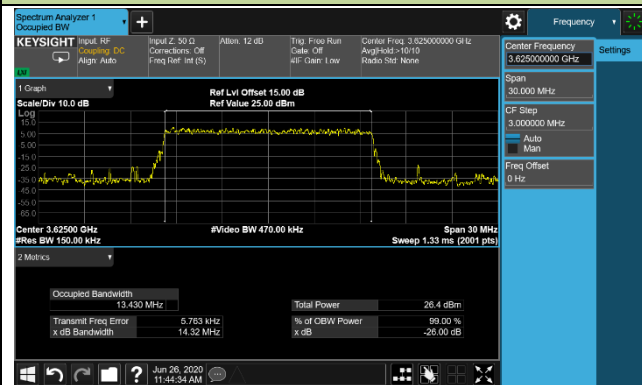

20MHz Channel Bandwidth

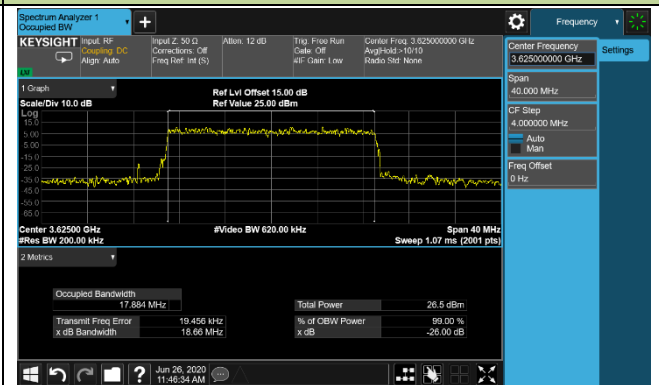

99% Bandwidth - 64QAM

5MHz Channel Bandwidth

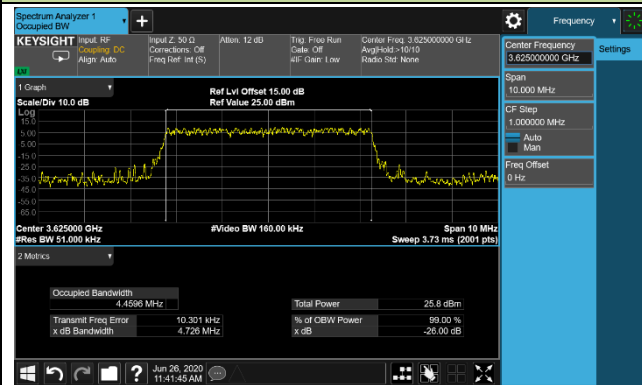

10MHz Channel Bandwidth

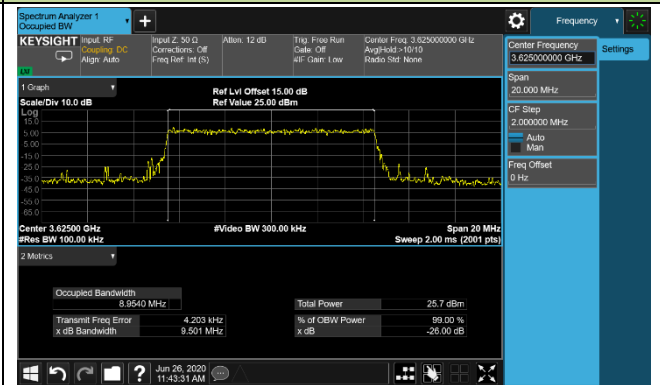

15MHz Channel Bandwidth

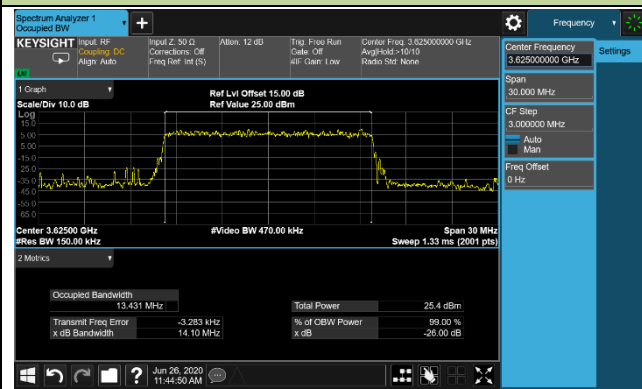

20MHz Channel Bandwidth

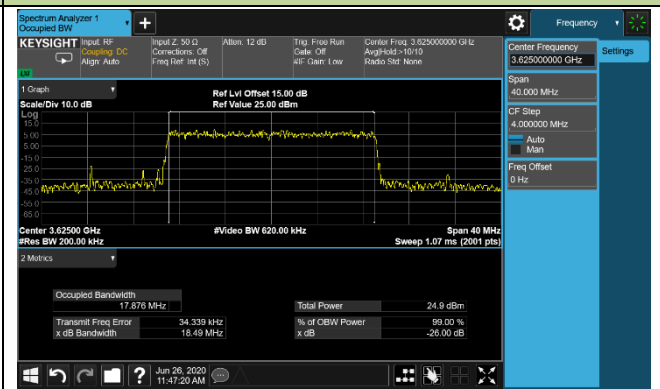

**A.2 Frequency Stability Test Result**

Test Site	WZ-TR3	Test Engineer	Candy Luo
Test Date	2020/06/19	Test Band	Band 42 & 43/48

Power (Vdc)	Temp. (°C)	Frequency Tolerance (ppm)
3.8	- 30	0.0023
	- 20	0.0024
	- 10	0.0027
	0	0.0022
	+ 10	0.0028
	+ 20 (Ref)	0.0023
	+ 30	0.0021
	+ 40	0.0020
	+ 50	0.0023
4.4	+ 20	0.0026
3.3	+ 20	0.0018

**A.3 Equivalent Isotropically Radiated Power Test Result**

Test Site	SIP-SR1	Test Engineer	Yoniter Yang
Test Date	2024-01-21 ~2024-01-22	Test Band	Band 42 & 43/48

Frequency (MHz)	Channel Bandwidth (MHz)	RB Size	RB Offset	Output Power (dBm/10MHz)	EIRP (dBm/10MHz)	Limit (dBm/10MHz)
QPSK						
3552.50	5	1	0	21.53	22.53	<23.00
3625.00				21.57	22.57	<23.00
3697.50				21.28	22.28	<23.00
3552.50	5	1	12	21.75	22.75	<23.00
3625.00				21.82	22.82	<23.00
3697.50				21.55	22.55	<23.00
3552.50	5	1	24	21.51	22.51	<23.00
3625.00				21.51	22.51	<23.00
3697.50				21.28	22.28	<23.00
3552.50	5	25	0	20.76	21.76	<23.00
3625.00				20.73	21.73	<23.00
3697.50				20.50	21.50	<23.00
3555.00	10	1	0	21.51	22.51	<23.00
3625.00				21.58	22.58	<23.00
3695.00				21.24	22.24	<23.00
3555.00	10	1	24	21.57	22.57	<23.00
3625.00				21.63	22.63	<23.00
3695.00				21.33	22.33	<23.00
3555.00	10	1	49	21.60	22.60	<23.00
3625.00				21.58	22.58	<23.00
3695.00				21.32	22.32	<23.00
3555.00	10	50	0	20.53	21.53	<23.00
3625.00				20.58	21.58	<23.00
3695.00				20.26	21.26	<23.00

Note: The EIRP (dBm/10MHz) = Output Power (dBm/10MHz) + Antenna Gain (dBi)

Frequency (MHz)	Channel Bandwidth (MHz)	RB Size	RB Offset	Output Power (dBm/10MHz)	EIRP (dBm/10MHz)	Limit (dBm/10MHz)
<b>QPSK</b>						
3557.50	15	1	0	21.76	22.76	<23.00
3625.00				21.84	22.84	<23.00
3692.50				21.54	22.54	<23.00
3557.50	15	1	37	21.85	22.85	<23.00
3625.00				21.85	22.85	<23.00
3692.50				21.55	22.55	<23.00
3557.50	15	1	74	21.83	22.83	<23.00
3625.00				21.79	22.79	<23.00
3692.50				21.59	22.59	<23.00
3557.50	15	75	0	19.78	20.78	<23.00
3625.00				19.70	20.70	<23.00
3692.50				19.53	20.53	<23.00
3560.00	20	1	0	21.74	22.74	<23.00
3625.00				21.80	22.80	<23.00
3690.00				21.55	22.55	<23.00
3560.00	20	1	49	21.77	22.77	<23.00
3625.00				21.77	22.77	<23.00
3690.00				21.47	22.47	<23.00
3560.00	20	1	99	21.76	22.76	<23.00
3625.00				21.72	22.72	<23.00
3690.00				21.52	22.52	<23.00
3560.00	20	100	0	18.41	19.41	<23.00
3625.00				18.34	19.34	<23.00
3690.00				18.27	19.27	<23.00

Note: The EIRP (dBm/10MHz) = Output Power (dBm/10MHz) + Antenna Gain (dBi)

Frequency (MHz)	Channel Bandwidth (MHz)	RB Size	RB Offset	Output Power (dBm/10MHz)	EIRP (dBm/10MHz)	Limit (dBm/10MHz)
16QAM						
3552.50	5	1	0	20.74	21.74	<23.00
3625.00				20.84	21.84	<23.00
3697.50				20.50	21.50	<23.00
3552.50	5	1	12	20.95	21.95	<23.00
3625.00				21.02	22.02	<23.00
3697.50				20.76	21.76	<23.00
3552.50	5	1	24	20.76	21.76	<23.00
3625.00				20.74	21.74	<23.00
3697.50				20.52	21.52	<23.00
3552.50	5	25	0	19.82	20.82	<23.00
3625.00				19.77	20.77	<23.00
3697.50				19.56	20.56	<23.00
3555.00	10	1	0	20.78	21.78	<23.00
3625.00				20.83	21.83	<23.00
3695.00				20.48	21.48	<23.00
3555.00	10	1	24	20.85	21.85	<23.00
3625.00				20.85	21.85	<23.00
3695.00				20.53	21.53	<23.00
3555.00	10	1	49	20.74	21.74	<23.00
3625.00				20.76	21.76	<23.00
3695.00				20.48	21.48	<23.00
3555.00	10	50	0	19.50	20.50	<23.00
3625.00				19.51	20.51	<23.00
3695.00				19.23	20.23	<23.00
Note: The EIRP (dBm/10MHz) = Output Power (dBm/10MHz) + Antenna Gain (dBi)						



Frequency (MHz)	Channel Bandwidth (MHz)	RB Size	RB Offset	Output Power (dBm/10MHz)	EIRP (dBm/10MHz)	Limit (dBm/10MHz)
<b>16QAM</b>						
3557.50	15	1	0	21.06	22.06	<23.00
3625.00				21.10	22.10	<23.00
3692.50				20.81	21.81	<23.00
3557.50	15	1	37	21.10	22.10	<23.00
3625.00				21.15	22.15	<23.00
3692.50				20.82	21.82	<23.00
3557.50	15	1	74	21.06	22.06	<23.00
3625.00				21.05	22.05	<23.00
3692.50				20.83	21.83	<23.00
3557.50	15	75	0	18.84	19.84	<23.00
3625.00				18.63	19.63	<23.00
3692.50				18.51	19.51	<23.00
3560.00	20	1	0	20.97	21.97	<23.00
3625.00				21.03	22.03	<23.00
3690.00				20.81	21.81	<23.00
3560.00	20	1	49	21.02	22.02	<23.00
3625.00				21.08	22.08	<23.00
3690.00				20.76	21.76	<23.00
3560.00	20	1	99	21.00	22.00	<23.00
3625.00				21.02	22.02	<23.00
3690.00				20.79	21.79	<23.00
3560.00	20	100	0	17.35	18.35	<23.00
3625.00				17.39	18.39	<23.00
3690.00				17.13	18.13	<23.00
Note: The EIRP (dBm/10MHz) = Output Power (dBm/10MHz) + Antenna Gain (dBi)						

Frequency (MHz)	Channel Bandwidth (MHz)	RB Size	RB Offset	Output Power (dBm/10MHz)	EIRP (dBm/10MHz)	Limit (dBm/10MHz)
<b>64QAM</b>						
3552.50	5	1	0	19.75	20.75	<23.00
3625.00				19.81	20.81	<23.00
3697.50				19.48	20.48	<23.00
3552.50	5	1	12	19.97	20.97	<23.00
3625.00				20.02	21.02	<23.00
3697.50				19.77	20.77	<23.00
3552.50	5	1	24	19.81	20.81	<23.00
3625.00				19.76	20.76	<23.00
3697.50				19.55	20.55	<23.00
3552.50	5	25	0	18.82	19.82	<23.00
3625.00				18.80	19.80	<23.00
3697.50				18.56	19.56	<23.00
3555.00	10	1	0	19.84	20.84	<23.00
3625.00				19.90	20.90	<23.00
3695.00				19.58	20.58	<23.00
3555.00	10	1	24	19.96	20.96	<23.00
3625.00				19.94	20.94	<23.00
3695.00				19.59	20.59	<23.00
3555.00	10	1	49	19.87	20.87	<23.00
3625.00				19.86	20.86	<23.00
3695.00				19.60	20.60	<23.00
3555.00	10	50	0	18.56	19.56	<23.00
3625.00				18.56	19.56	<23.00
3695.00				18.25	19.25	<23.00
Note: The EIRP (dBm/10MHz) = Output Power (dBm/10MHz) + Antenna Gain (dBi)						

Frequency (MHz)	Channel Bandwidth (MHz)	RB Size	RB Offset	Output Power (dBm/10MHz)	EIRP (dBm/10MHz)	Limit (dBm/10MHz)
<b>64QAM</b>						
3557.50	15	1	0	20.01	21.01	<23.00
3625.00				20.08	21.08	<23.00
3692.50				19.77	20.77	<23.00
3557.50	15	1	37	20.07	21.07	<23.00
3625.00				20.10	21.10	<23.00
3692.50				19.80	20.80	<23.00
3557.50	15	1	74	20.05	21.05	<23.00
3625.00				20.00	21.00	<23.00
3692.50				19.82	20.82	<23.00
3557.50	15	75	0	17.89	18.89	<23.00
3625.00				17.76	18.76	<23.00
3692.50				17.52	18.52	<23.00
3560.00	20	1	0	20.03	21.03	<23.00
3625.00				20.07	21.07	<23.00
3690.00				19.81	20.81	<23.00
3560.00	20	1	49	20.05	21.05	<23.00
3625.00				20.07	21.07	<23.00
3690.00				19.77	20.77	<23.00
3560.00	20	1	99	20.04	21.04	<23.00
3625.00				20.02	21.02	<23.00
3690.00				19.81	20.81	<23.00
3560.00	20	100	0	16.37	17.37	<23.00
3625.00				16.32	17.32	<23.00
3690.00				16.20	17.20	<23.00
Note: The EIRP (dBm/10MHz) = Output Power (dBm/10MHz) + Antenna Gain (dBi)						

Test Site	SIP-SR1	Test Engineer	Yoniter Yang
Test Date	2024-01-21 ~2024-01-22	Test Band	Band 42 & 43/48 (report only)

Frequency (MHz)	Channel Bandwidth (MHz)	RB Size	RB Offset	Output Power (dBm)	EIRP (dBm)	Limit (dBm)
QPSK						
3552.50	5	1	0	20.63	21.63	N/A
3625.00				21.27	22.27	N/A
3697.50				21.07	22.07	N/A
3552.50	5	1	12	21.19	22.19	N/A
3625.00				21.59	22.59	N/A
3697.50				21.33	22.33	N/A
3552.50	5	1	24	21.61	22.61	N/A
3625.00				21.32	22.32	N/A
3697.50				21.06	22.06	N/A
3552.50	5	25	0	20.13	21.13	N/A
3625.00				20.47	21.47	N/A
3697.50				20.29	21.29	N/A
3555.00	10	1	0	21.70	22.70	N/A
3625.00				21.32	22.32	N/A
3695.00				21.12	22.12	N/A
3555.00	10	1	24	21.65	22.65	N/A
3625.00				21.46	22.46	N/A
3695.00				21.11	22.11	N/A
3555.00	10	1	49	21.58	22.58	N/A
3625.00				21.50	22.50	N/A
3695.00				21.08	22.08	N/A
3555.00	10	50	0	20.46	21.46	N/A
3625.00				20.25	21.25	N/A
3695.00				20.02	21.02	N/A

Note: The EIRP (dBm) = Output Power (dBm) + Antenna Gain (dBi)

Frequency (MHz)	Channel Bandwidth (MHz)	RB Size	RB Offset	Output Power (dBm)	EIRP (dBm)	Limit (dBm)
<b>QPSK</b>						
3557.50	15	1	0	21.16	22.16	N/A
3625.00				21.64	22.64	N/A
3692.50				21.60	22.60	N/A
3557.50	15	1	37	21.20	22.20	N/A
3625.00				21.06	22.06	N/A
3692.50				21.45	22.45	N/A
3557.50	15	1	74	21.27	22.27	N/A
3625.00				21.14	22.14	N/A
3692.50				21.46	22.46	N/A
3557.50	15	75	0	20.21	21.21	N/A
3625.00				20.69	21.69	N/A
3692.50				20.33	21.33	N/A
3560.00	20	1	0	21.29	22.29	N/A
3625.00				21.69	22.69	N/A
3690.00				21.68	22.68	N/A
3560.00	20	1	49	21.20	22.20	N/A
3625.00				21.07	22.07	N/A
3690.00				21.47	22.47	N/A
3560.00	20	1	99	21.35	22.35	N/A
3625.00				21.23	22.23	N/A
3690.00				21.46	22.46	N/A
3560.00	20	100	0	20.63	21.63	N/A
3625.00				20.62	21.62	N/A
3690.00				20.27	21.27	N/A
Note: The EIRP (dBm) = Output Power (dBm) + Antenna Gain (dBi)						

Frequency (MHz)	Channel Bandwidth (MHz)	RB Size	RB Offset	Output Power (dBm)	EIRP (dBm)	Limit (dBm)
<b>16QAM</b>						
3552.50	5	1	0	20.83	21.83	N/A
3625.00				20.34	21.34	N/A
3697.50				20.13	21.13	N/A
3552.50	5	1	12	21.14	22.14	N/A
3625.00				20.70	21.70	N/A
3697.50				20.40	21.40	N/A
3552.50	5	1	24	20.84	21.84	N/A
3625.00				20.40	21.40	N/A
3697.50				20.06	21.06	N/A
3552.50	5	25	0	19.80	20.80	N/A
3625.00				19.51	20.51	N/A
3697.50				19.34	20.34	N/A
3555.00	10	1	0	20.76	21.76	N/A
3625.00				20.25	21.25	N/A
3695.00				20.36	21.36	N/A
3555.00	10	1	24	20.78	21.78	N/A
3625.00				20.39	21.39	N/A
3695.00				20.33	21.33	N/A
3555.00	10	1	49	20.69	21.69	N/A
3625.00				20.42	21.42	N/A
3695.00				20.30	21.30	N/A
3555.00	10	50	0	19.47	20.47	N/A
3625.00				19.21	20.21	N/A
3695.00				19.93	20.93	N/A
Note: The EIRP (dBm) = Output Power (dBm) + Antenna Gain (dBi)						

Frequency (MHz)	Channel Bandwidth (MHz)	RB Size	RB Offset	Output Power (dBm)	EIRP (dBm)	Limit (dBm)
<b>16QAM</b>						
3557.50	15	1	0	20.74	21.74	N/A
3625.00				20.89	21.89	N/A
3692.50				20.78	21.78	N/A
3557.50	15	1	37	20.79	21.79	N/A
3625.00				21.01	22.01	N/A
3692.50				20.66	21.66	N/A
3557.50	15	1	74	20.89	21.89	N/A
3625.00				21.12	22.12	N/A
3692.50				20.67	21.67	N/A
3557.50	15	75	0	19.75	20.75	N/A
3625.00				19.69	20.69	N/A
3692.50				19.39	20.39	N/A
3560.00	20	1	0	20.95	21.95	N/A
3625.00				20.79	21.79	N/A
3690.00				20.93	21.93	N/A
3560.00	20	1	49	20.81	21.81	N/A
3625.00				20.90	21.90	N/A
3690.00				20.72	21.72	N/A
3560.00	20	1	99	20.83	21.83	N/A
3625.00				21.02	22.02	N/A
3690.00				20.74	21.74	N/A
3560.00	20	100	0	19.67	20.67	N/A
3625.00				19.62	20.62	N/A
3690.00				19.28	20.28	N/A
Note: The EIRP (dBm) = Output Power (dBm) + Antenna Gain (dBi)						

Frequency (MHz)	Channel Bandwidth (MHz)	RB Size	RB Offset	Output Power (dBm)	EIRP (dBm)	Limit (dBm)
<b>64QAM</b>						
3552.50	5	1	0	20.21	21.21	N/A
3625.00				19.58	20.58	N/A
3697.50				19.16	20.16	N/A
3552.50	5	1	12	20.46	21.46	N/A
3625.00				19.99	20.99	N/A
3697.50				19.45	20.45	N/A
3552.50	5	1	24	20.15	21.15	N/A
3625.00				19.68	20.68	N/A
3697.50				19.11	20.11	N/A
3552.50	5	25	0	18.79	19.79	N/A
3625.00				18.46	19.46	N/A
3697.50				18.33	19.33	N/A
3555.00	10	1	0	19.66	20.66	N/A
3625.00				19.64	20.64	N/A
3695.00				19.19	20.19	N/A
3555.00	10	1	24	19.64	20.64	N/A
3625.00				19.74	20.74	N/A
3695.00				19.15	20.15	N/A
3555.00	10	1	49	19.60	20.60	N/A
3625.00				19.79	20.79	N/A
3695.00				19.14	20.14	N/A
3555.00	10	50	0	18.47	19.47	N/A
3625.00				18.20	19.20	N/A
3695.00				17.99	18.99	N/A
Note: The EIRP (dBm) = Output Power (dBm) + Antenna Gain (dBi)						



Frequency (MHz)	Channel Bandwidth (MHz)	RB Size	RB Offset	Output Power (dBm)	EIRP (dBm)	Limit (dBm)
<b>64QAM</b>						
3557.50	15	1	0	20.12	21.12	N/A
3625.00				19.70	20.70	N/A
3692.50				19.91	20.91	N/A
3557.50	15	1	37	20.16	21.16	N/A
3625.00				19.81	20.81	N/A
3692.50				19.74	20.74	N/A
3557.50	15	1	74	20.24	21.24	N/A
3625.00				19.97	20.97	N/A
3692.50				19.71	20.71	N/A
3557.50	15	75	0	18.73	19.73	N/A
3625.00				18.74	19.74	N/A
3692.50				18.40	19.40	N/A
3560.00	20	1	0	19.90	20.90	N/A
3625.00				20.09	21.09	N/A
3690.00				19.95	20.95	N/A
3560.00	20	1	49	19.71	20.71	N/A
3625.00				20.22	21.22	N/A
3690.00				19.75	20.75	N/A
3560.00	20	1	99	19.80	20.80	N/A
3625.00				20.38	21.38	N/A
3690.00				19.76	20.76	N/A
3560.00	20	100	0	18.64	19.64	N/A
3625.00				18.65	19.65	N/A
3690.00				18.37	19.37	N/A
Note: The EIRP (dBm) = Output Power (dBm) + Antenna Gain (dBi)						

### A.4 Band Edge Test Result

Test Site	SR1-SR1	Test Engineer	Candy Luo
Test Date	2024/01/11	Test Band	Band 42/48

#### 5MHz Channel Bandwidth - 1RB

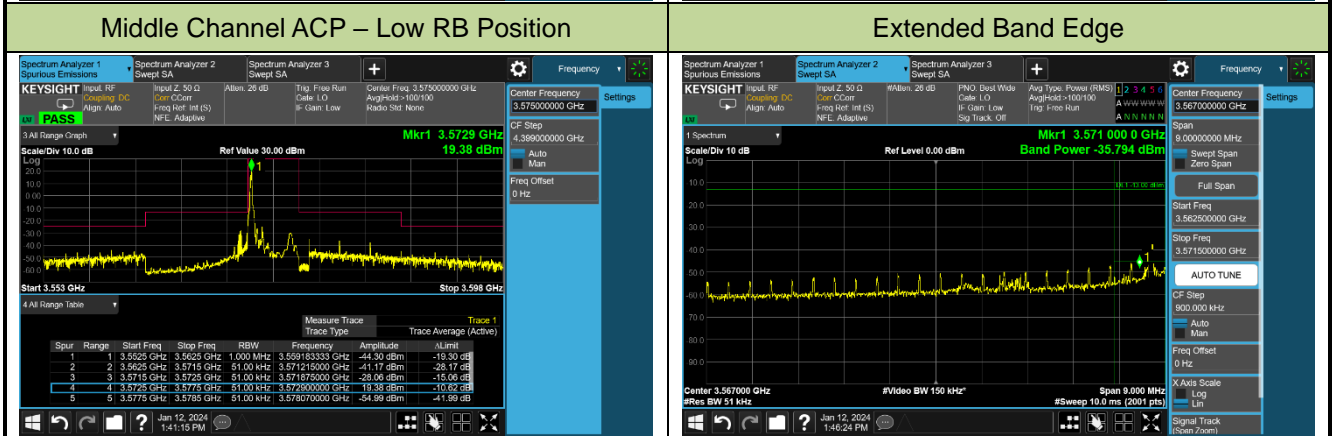
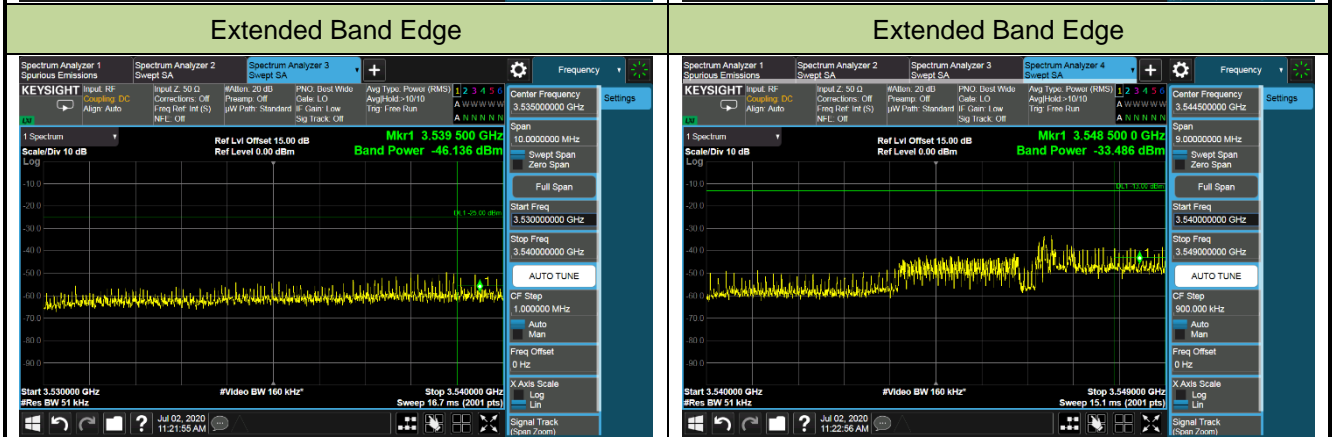
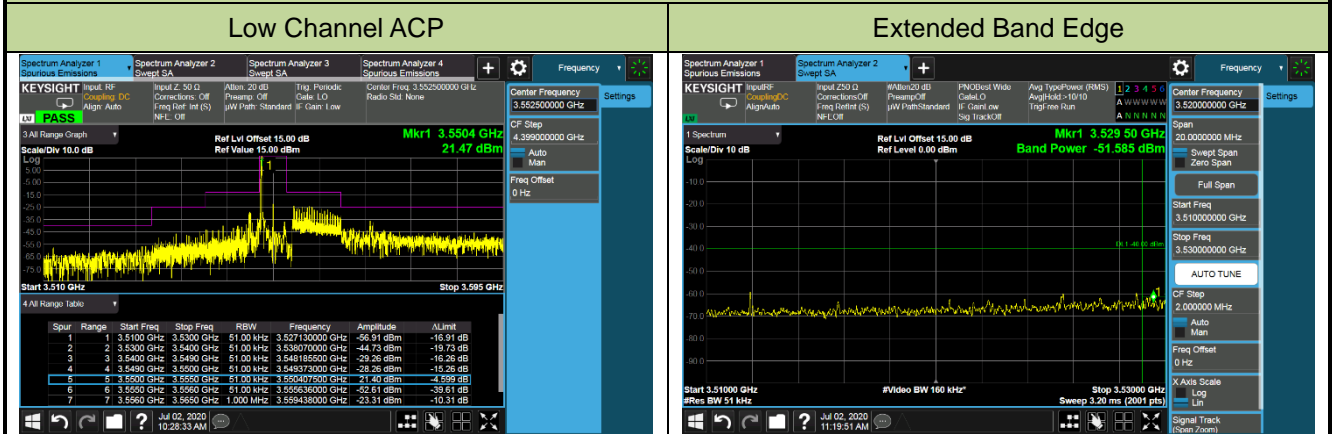

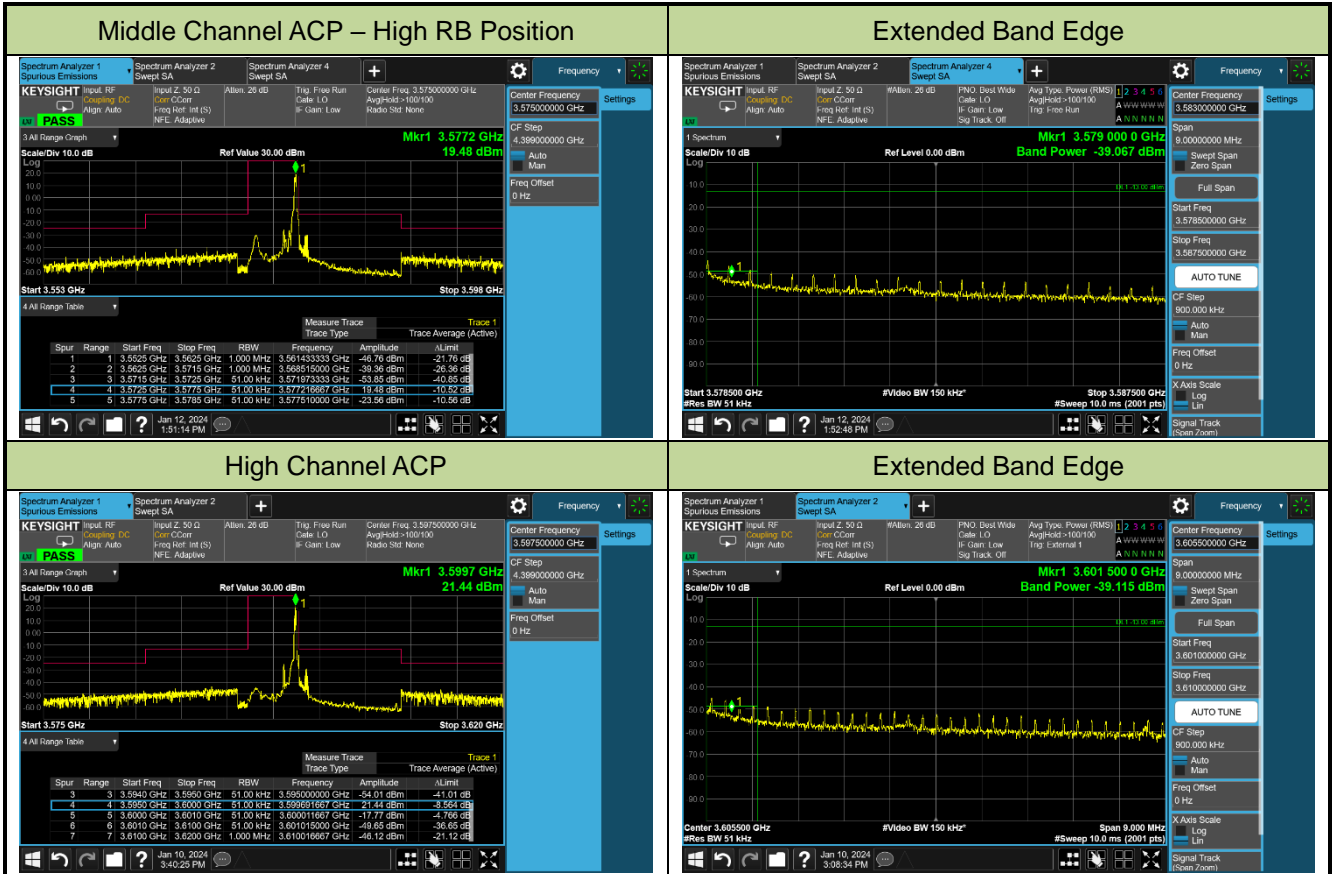

## 10MHz Channel Bandwidth – 1RB

## Low Channel ACP

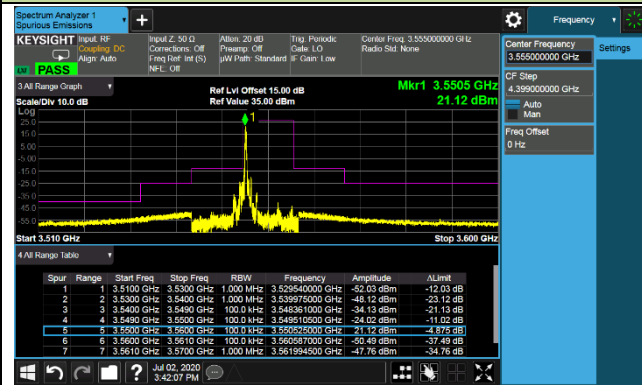

## Middle Channel ACP – Low RB Position

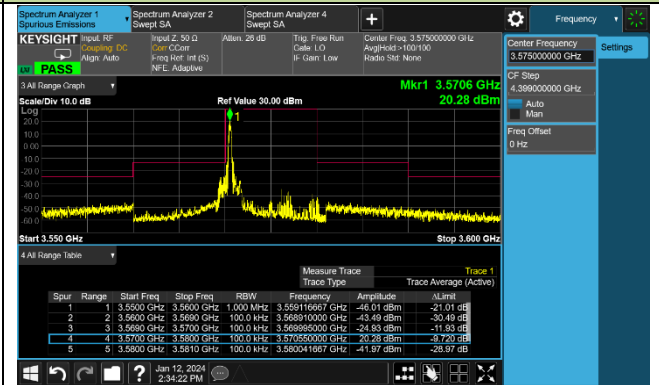

## Extended Band Edge

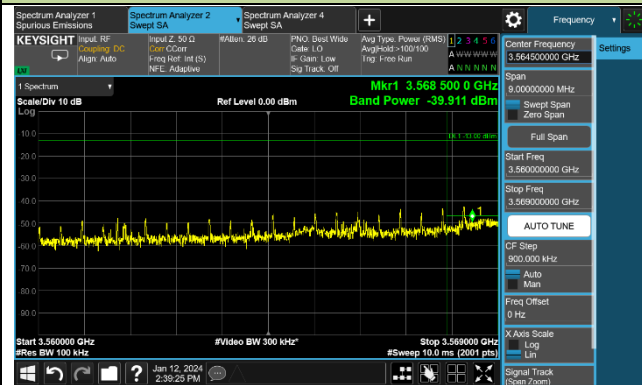

## Middle Channel ACP – High RB Position

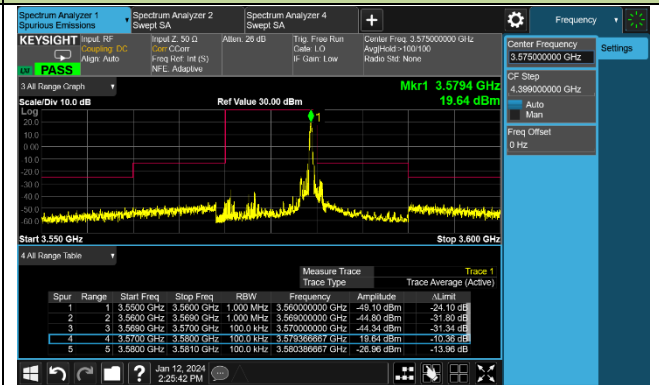

## Extended Band Edge

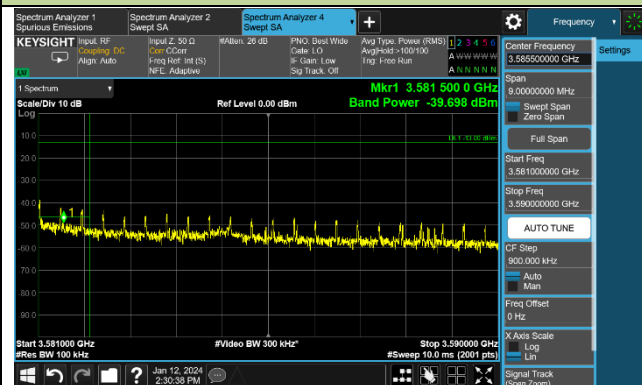

## High Channel ACP

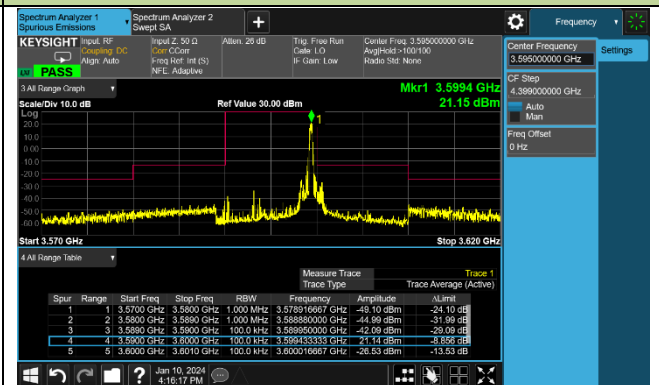

## Extended Band Edge

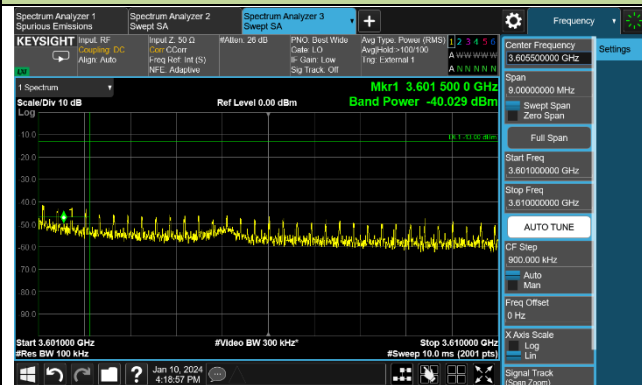

15MHz Channel Bandwidth – 1RB

Low Channel ACP

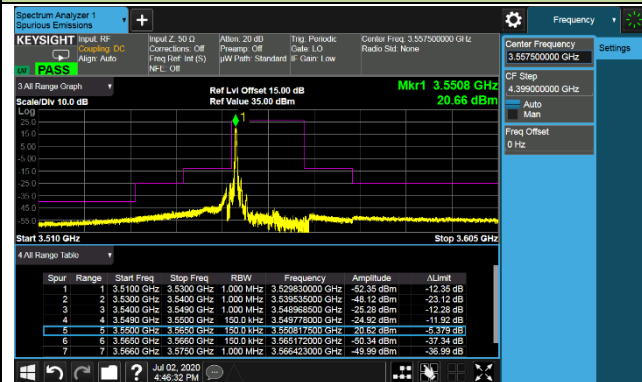

Middle Channel ACP – Low RB Position

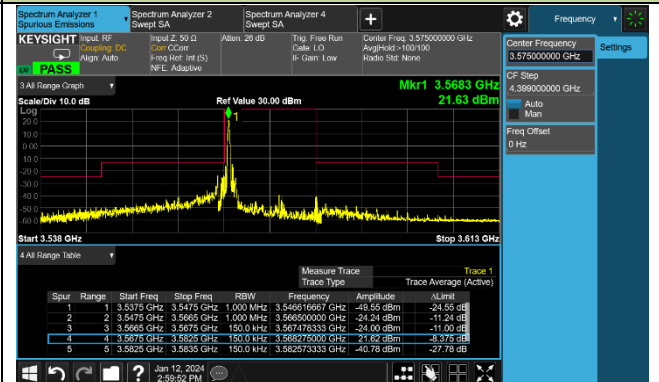

Middle Channel ACP – High RB Position

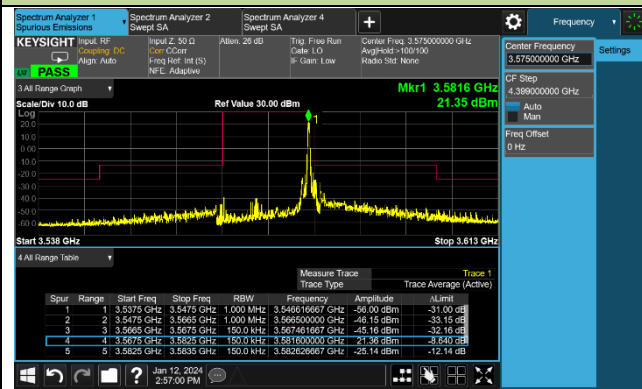

High Channel ACP

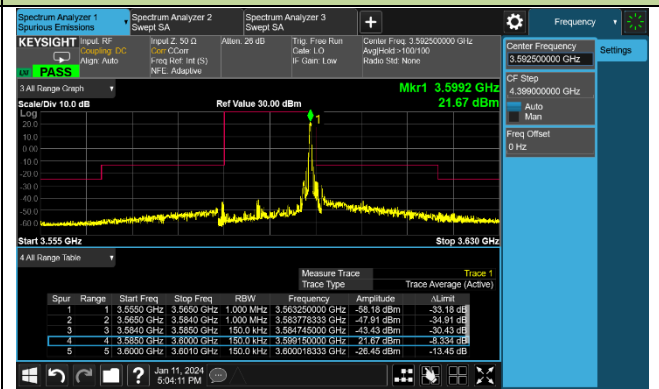

20MHz Channel Bandwidth – 1RB

Low Channel ACP

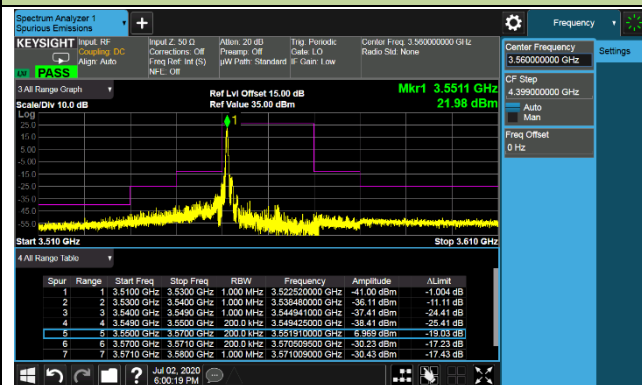

Middle Channel ACP – Low RB Position

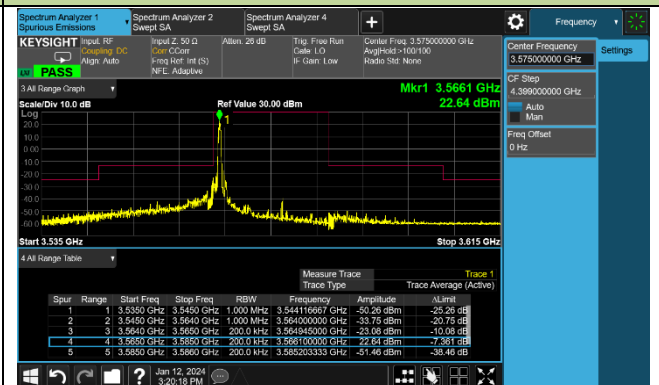

Middle Channel ACP – High RB Position

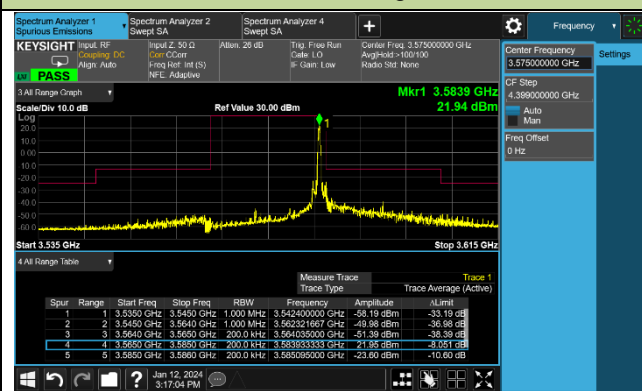

High Channel ACP

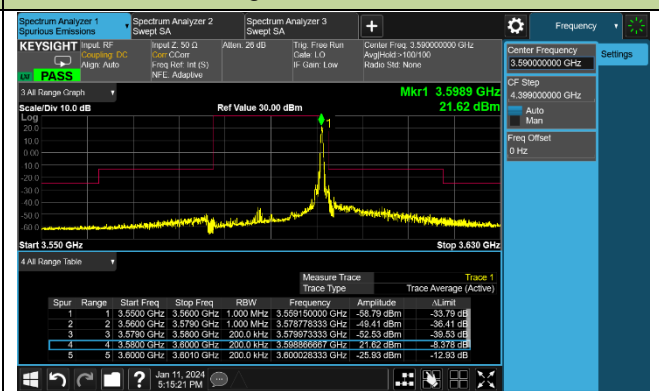

5MHz Channel Bandwidth – Full RB

Low Channel ACP

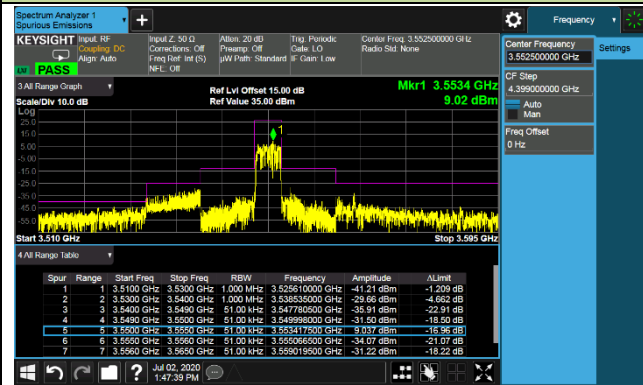

Extended Band Edge

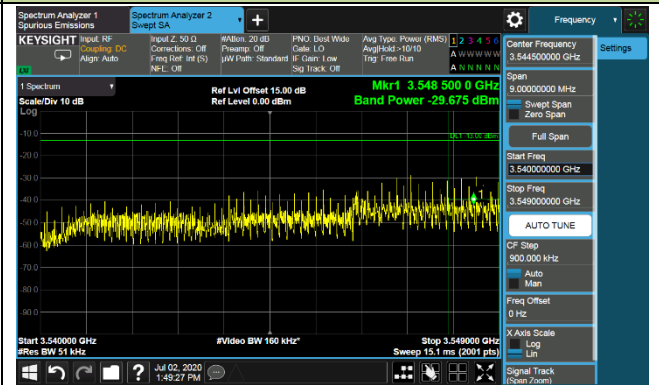

Extended Band Edge

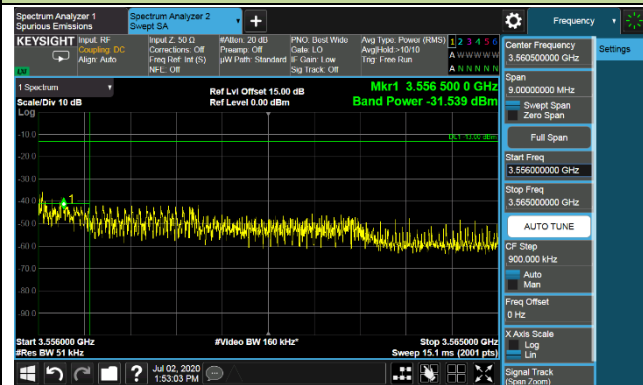

Middle Channel ACP

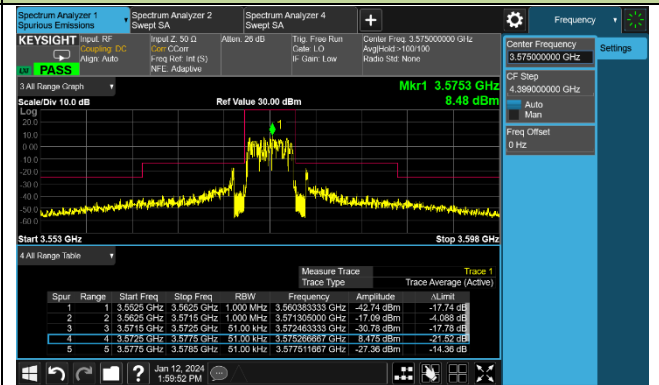

High Channel ACP

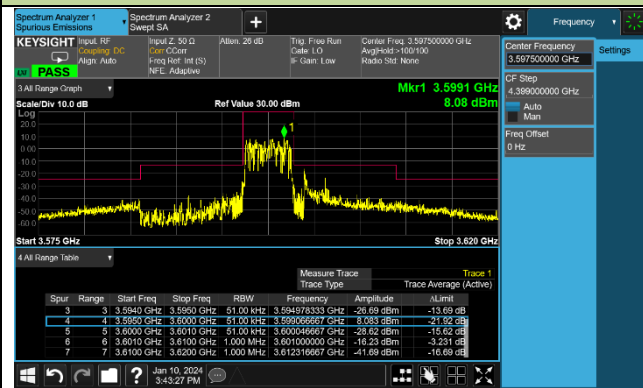

Extended Band Edge



### 10MHz Channel Bandwidth – Full RB

#### Low Channel ACP

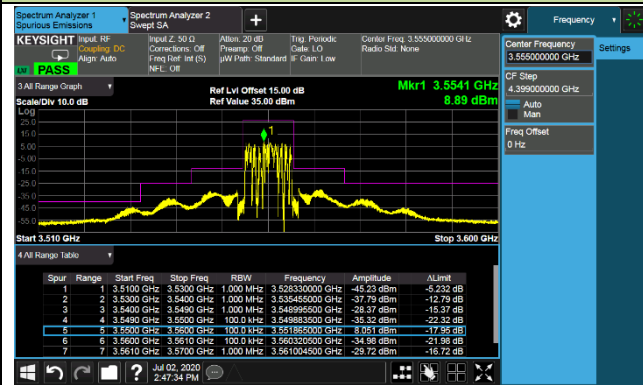

#### Middle Channel ACP

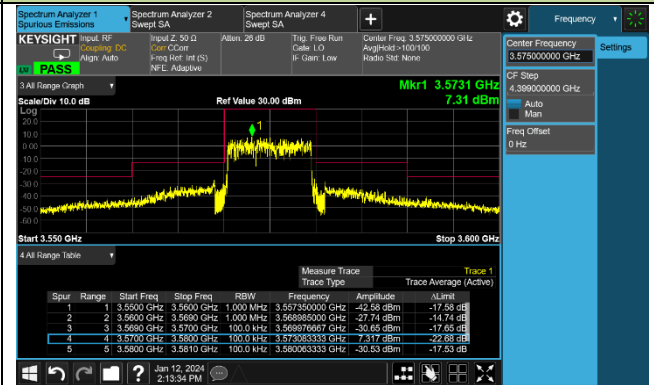

#### High Channel ACP

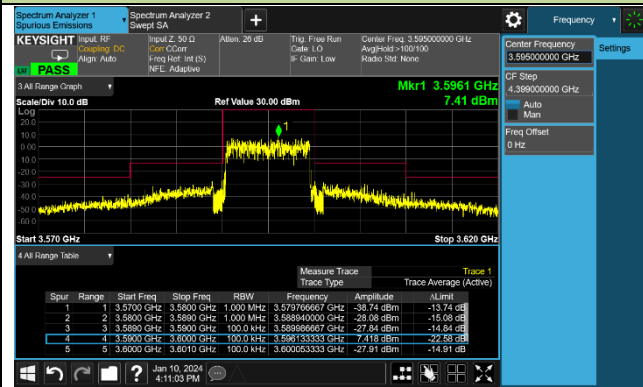



### 15MHz Channel Bandwidth – Full RB

#### Low Channel ACP



#### Middle Channel ACP



#### High Channel ACP

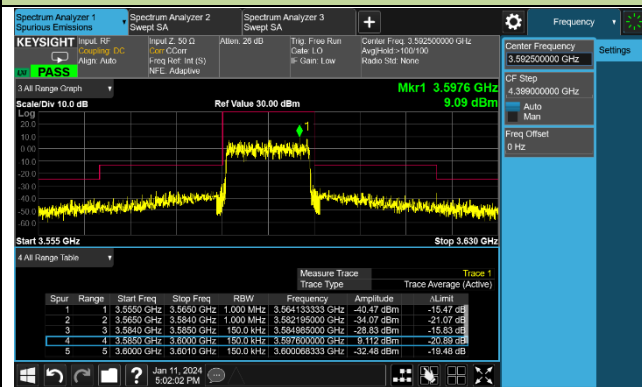

20MHz Channel Bandwidth – Full RB

Low Channel ACP

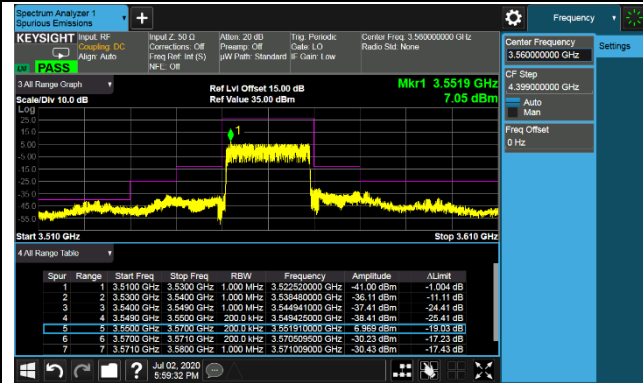

Middle Channel ACP

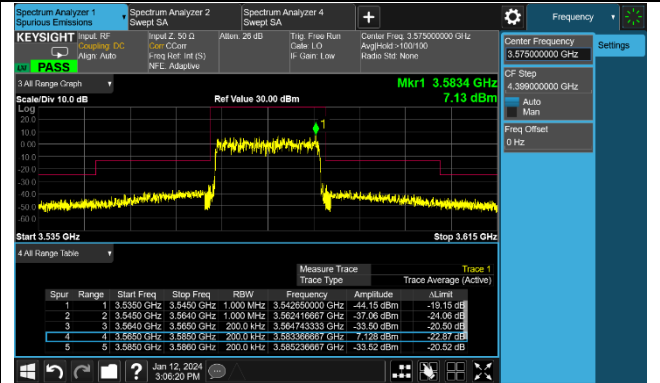

High Channel ACP

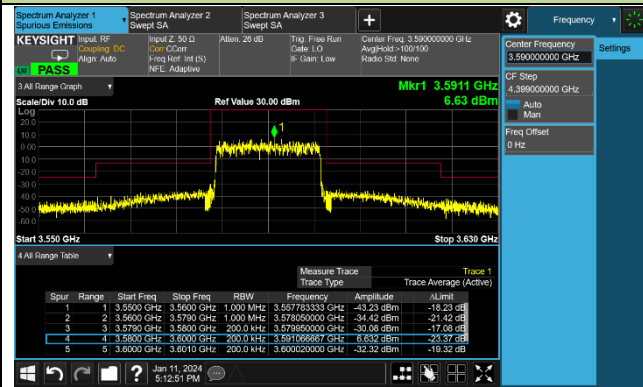

Test Site	SIP-SR1	Test Engineer	Yoniter Yang
Test Date	2024/01/11	Test Band	Band 43/48

