



FCC RF Test Report

APPLICANT : Quectel Wireless Solutions Co., Ltd.
EQUIPMENT : LTE Cat 1bis Module
BRAND NAME : Quectel
MODEL NAME : EG800Q-NA
FCC ID : XMR2023EG800QNA
STANDARD : 47 CFR Part 2, 22(H), 24(E), 27(L), 27(H), 27(F)
CLASSIFICATION : PCS Licensed Transmitter (PCB)
TEST DATE(S) : Jul. 27, 2023 ~ Sep. 08, 2023

We, Sporton International Inc. (Kunshan), would like to declare that the tested sample has been evaluated in accordance with the procedures given in ANSI C63.26-2015 and shown compliance with the applicable technical standards.

The test results in this report apply exclusively to the tested model / sample. Without written approval of Sporton International Inc. (Kunshan), the test report shall not be reproduced except in full.

Jason Jia

Approved by: Jason Jia



Sporton International Inc. (Kunshan)

**No. 1098, Pengxi North Road, Kunshan Economic Development Zone Jiangsu Province 215300
People's Republic of China**



TABLE OF CONTENTS

REVISION HISTORY...3
SUMMARY OF TEST RESULT...4
1 GENERAL DESCRIPTION...5
1.1 Applicant...5
1.2 Manufacturer...5
1.3 Product Feature of Equipment Under Test...5
1.4 Product Specification of Equipment Under Test...5
1.5 Modification of EUT...6
1.6 Maximum Conducted Power and Emission Designator...6
1.7 Testing Location...8
1.8 Test Software...8
1.9 Applicable Standards...8
2 TEST CONFIGURATION OF EQUIPMENT UNDER TEST...9
2.1 Test Mode...9
2.2 Connection Diagram of Test System...11
2.3 Support Unit used in test configuration and system...11
2.4 Measurement Results Explanation Example...11
2.5 Frequency List of Low/Middle/High Channels...12
3 CONDUCTED TEST ITEMS...15
3.1 Measuring Instruments...15
3.2 Test Setup...15
3.3 Test Result of Conducted Test...15
3.4 Conducted Output Power and ERP/EIRP...16
3.5 Peak-to-Average Ratio...17
3.6 Occupied Bandwidth...18
3.7 Conducted Band Edge...19
3.8 Conducted Spurious Emission...21
3.9 Frequency Stability...22
4 RADIATED TEST ITEMS...23
4.1 Measuring Instruments...23
4.2 Test Setup...23
4.3 Test Result of Radiated Test...24
4.4 Radiated Spurious Emission...25
5 LIST OF MEASURING EQUIPMENT...26
6 MEASUREMENT UNCERTAINTY...27
APPENDIX A. TEST RESULTS OF CONDUCTED TEST
APPENDIX B. TEST RESULTS OF RADIATED TEST
APPENDIX C. TEST SETUP PHOTOGRAPHS



REVISION HISTORY

REPORT NO.	VERSION	DESCRIPTION	ISSUED DATE
FG362719	Rev. 01	Initial issue of report	Sep. 25, 2023



SUMMARY OF TEST RESULT

Report Section	FCC Rule	Description	Limit	Result	Remark
3.4	§2.1046	Conducted Output Power	-	Report Only	-
	§22.913(a)(5)	Effective Radiated Power (Band 5)	ERP < 7 Watt	PASS	-
	§27.50(b)(10) §27.50(c)(10)	Effective Radiated Power (Band 12) (Band 13)	ERP < 3 Watt		-
	§24.232(c)	Equivalent Isotropic Radiated Power (Band 2)	EIRP < 2Watt		-
	§27.50(d)(4)	Equivalent Isotropic Radiated Power (Band 4) (Band 66)	EIRP < 1Watt		-
3.5	§24.232(d)	Peak-to-Average Ratio	<13 dB		PASS
3.6	§2.1049	Occupied Bandwidth	-	Report Only	-
3.7	§2.1051 §22.917(a) §24.238(a) §27.53(c)(2)(4) §27.53(g) §27.53(h)	Conducted Band Edge Measurement (Band 2) (Band 4) (Band 5) (Band 12) (Band 13) (Band 66)	< 43+10log ₁₀ (P[Watts])	PASS	-
3.8	§2.1051 §22.917(a) §24.238(a) §27.53(c)(2) §27.53(g) §27.53(h)	Conducted Spurious Emission (Band 2) (Band 4) (Band 5) (Band 12) (Band 13) (Band 66)	< 43+10log ₁₀ (P[Watts])	PASS	-
3.9	§2.1055 §22.355	Frequency Stability Temperature & Voltage	< 2.5 ppm for Part 22	PASS	-
	§2.1055 §24.235 §27.54		Within Authorized Band		
4.4	§2.1053 §22.917(a) §24.238(a) §27.53(c)(2) §27.53(f) §27.53(g) §27.53(h)	Radiated Spurious Emission (Band 2) (Band 4) (Band 5) (Band 12) (Band 13) (Band 66)	< 43+10log ₁₀ (P[Watts])	PASS	Under limit 21.71 dB at 1560.000 MHz

Conformity Assessment Condition:

- The test results (PASS/FAIL) with all measurement uncertainty excluded are presented against the regulation limits or in accordance with the requirements stipulated by the applicant/manufacturer who shall bear all the risks of non-compliance that may potentially occur if measurement uncertainty is taken into account.
- The measurement uncertainty please refer to each test result in the section "Measurement Uncertainty"

Disclaimer:

The product specifications of the EUT presented in the test report that may affect the test assessments are declared by the manufacturer who shall take full responsibility for the authenticity.



1 General Description

1.1 Applicant

Quectel Wireless Solutions Co., Ltd.

Building 5, Shanghai Business Park Phase III (Area B), No.1016 Tianlin Road, Minhang District, Shanghai 200233, China

1.2 Manufacturer

Quectel Wireless Solutions Co., Ltd.

Building 5, Shanghai Business Park Phase III (Area B), No.1016 Tianlin Road, Minhang District, Shanghai 200233, China

1.3 Product Feature of Equipment Under Test

Product Feature	
Equipment	LTE Cat 1bis Module
Brand Name	Quectel
Model Name	EG800Q-NA
FCC ID	XMR2023EG800QNA
IMEI Code	Conducted: 866784060003144 Radiation: 866784060002799
HW Version	R1.0
SW Version	N/A
EUT Stage	Identical Prototype

1.4 Product Specification of Equipment Under Test

Standards-related Product Specification	
Tx Frequency	LTE Band 2 : 1850 MHz ~ 1910 MHz LTE Band 4 : 1710 MHz ~ 1755 MHz LTE Band 5 : 824 MHz ~ 849 MHz LTE Band 12 : 699 MHz ~ 716 MHz LTE Band 13 : 777 MHz ~ 787 MHz LTE Band 66 : 1710 MHz ~ 1780 MHz
Rx Frequency	LTE Band 2 : 1930 MHz ~ 1990 MHz LTE Band 4 : 2110 MHz ~ 2155 MHz LTE Band 5 : 869 MHz ~ 894 MHz LTE Band 12 : 729 MHz ~ 746 MHz LTE Band 13 : 746 MHz ~ 756 MHz LTE Band 66 : 2110 MHz~ 2180 MHz
Bandwidth	LTE Band 2 : 1.4MHz / 3MHz / 5MHz / 10MHz / 15MHz / 20MHz LTE Band 4 : 1.4MHz / 3MHz / 5MHz / 10MHz / 15MHz / 20MHz LTE Band 5 : 1.4MHz / 3MHz / 5MHz / 10MHz LTE Band 12 : 1.4MHz / 3MHz / 5MHz / 10MHz LTE Band 13 : 5MHz / 10MHz



	LTE Band 66 : 1.4MHz / 3MHz / 5MHz / 10MHz / 15MHz / 20MHz
Maximum Output Power to Antenna	LTE Band 2 : 23.63 dBm LTE Band 4 : 23.44 dBm LTE Band 5 : 23.57 dBm LTE Band 12 : 23.47 dBm LTE Band 13 : 23.57 dBm LTE Band 66 : 23.58 dBm
Antenna Gain	LTE Band 2 : 1.59 dBi LTE Band 4 : 2.00 dBi LTE Band 5 : 2.53 dBi LTE Band 12 : 3.95 dBi LTE Band 13 : 4.45 dBi LTE Band 66 : 2.00 dBi
Type of Modulation	QPSK / 16QAM

Remark: This device support LTE category 1 bis.

1.5 Modification of EUT

No modifications are made to the EUT during all test items.

1.6 Maximum Conducted Power and Emission Designator

LTE Band 2		QPSK		16QAM	
BW (MHz)	Frequency Range (MHz)	Maximum Conducted power (W)	Emission Designator (99%OBW)	Maximum Conducted power (W)	Emission Designator (99%OBW)
1.4	1850.7 ~ 1909.3	0.2265	1M09G7D	0.1770	1M08W7D
3	1851.5 ~ 1908.5	0.2249	2M70G7D	0.1766	2M71W7D
5	1852.5 ~ 1907.5	0.2280	4M51G7D	0.1758	4M52W7D
10	1855.0 ~ 1905.0	0.2249	8M99G7D	0.1791	5M03W7D
15	1857.5 ~ 1902.5	0.2270	13M5G7D	0.1766	5M09W7D
20	1860.0 ~ 1900.0	0.2307	17M9G7D	0.1807	5M07W7D
LTE Band 4		QPSK		16QAM	
BW (MHz)	Frequency Range (MHz)	Maximum Conducted power (W)	Emission Designator (99%OBW)	Maximum Conducted power (W)	Emission Designator (99%OBW)
1.4	1710.7 ~ 1754.3	0.2198	1M10G7D	0.1782	1M10W7D
3	1711.5 ~ 1753.5	0.2198	2M72G7D	0.1791	2M72W7D
5	1712.5 ~ 1752.5	0.2168	4M50G7D	0.1795	4M47W7D
10	1715.0 ~ 1750.0	0.2173	9M05G7D	0.1762	5M05W7D
15	1717.5 ~ 1747.5	0.2193	13M5G7D	0.1803	5M03W7D
20	1720.0 ~ 1745.0	0.2208	17M9G7D	0.1858	5M03W7D



LTE Band 5		QPSK		16QAM	
BW (MHz)	Frequency Range (MHz)	Maximum Conducted power (W)	Emission Designator (99%OBW)	Maximum Conducted power (W)	Emission Designator (99%OBW)
1.4	824.7 ~ 848.3	0.2178	1M09G7D	0.1795	1M09W7D
3	825.5 ~ 847.5	0.2163	2M73G7D	0.1758	2M74W7D
5	826.5 ~ 846.5	0.2213	4M48G7D	0.1795	4M49W7D
10	829.0 ~ 844.0	0.2275	9M11G7D	0.1824	5M03W7D
LTE Band 12		QPSK		16QAM	
BW (MHz)	Frequency Range (MHz)	Maximum Conducted power (W)	Emission Designator (99%OBW)	Maximum Conducted power (W)	Emission Designator (99%OBW)
1.4	699.7 ~ 715.3	0.2183	1M09G7D	0.1795	1M10W7D
3	700.5 ~ 714.5	0.2183	2M70G7D	0.1770	2M72W7D
5	701.5 ~ 713.5	0.2213	4M49G7D	0.1726	4M48W7D
10	704.0 ~ 711.0	0.2223	8M97G7D	0.1816	5M03W7D
LTE Band 13		QPSK		16QAM	
BW (MHz)	Frequency Range (MHz)	Maximum Conducted power (W)	Emission Designator (99%OBW)	Maximum Conducted power (W)	Emission Designator (99%OBW)
5	779.5 ~ 784.5	0.2265	4M48G7D	0.1888	4M52W7D
10	782.0	0.2275	8M91G7D	0.1892	5M00W7D
LTE Band 66		QPSK		16QAM	
BW (MHz)	Frequency Range (MHz)	Maximum Conducted power (W)	Emission Designator (99%OBW)	Maximum Conducted power (W)	Emission Designator (99%OBW)
1.4	1710.7 ~ 1779.3	0.2275	1M10G7D	0.1816	1M10W7D
3	1711.5 ~ 1778.5	0.2265	2M72G7D	0.1782	2M72W7D
5	1712.5 ~ 1777.5	0.2183	4M50G7D	0.1807	4M47W7D
10	1715.0 ~ 1775.0	0.2228	9M05G7D	0.1786	5M05W7D
15	1717.5 ~ 1772.5	0.2178	13M5G7D	0.1795	5M03W7D
20	1720.0 ~ 1770.0	0.2280	17M9G7D	0.1858	5M03W7D

Note: LTE Band 66 overlaps the entire frequency range of LTE Band 4. Therefore, the test results provided in this report covers Band 66 as well as Band 4.



1.7 Testing Location

Sporton International Inc. (Kunshan) is accredited to ISO/IEC 17025:2017 by American Association for Laboratory Accreditation with Certificate Number 5145.02.

Test Firm	Sporton International Inc. (Kunshan)		
Test Site Location	No. 1098, Pengxi North Road, Kunshan Economic Development Zone Jiangsu Province 215300 People's Republic of China TEL : +86-512-57900158		
Test Site No.	Sporton Site No.	FCC Designation No.	FCC Test Firm Registration No.
	03CH04-KS TH01-KS	CN1257	314309

1.8 Test Software

Item	Site	Manufacture	Name	Version
1.	TH01-KS	SPORTON	FCC LTE_Ver2.0 Auto_china_210503	2.0
2.	03CH04-KS	AUDIX	E3	210616

1.9 Applicable Standards

According to the specifications of the manufacturer, the EUT must comply with the requirements of the following standards:

- 47 CFR Part 2, 22(H), 24(E), 27(L), 27(H), 27(F)
- ANSI C63.26-2015
- FCC KDB 971168 D01 Power Meas License Digital Systems v03r01
- FCC KDB 412172 D01 Determining ERP and EIRP v01r01

Remark:

1. All test items were verified and recorded according to the standards and without any deviation during the test.
2. This EUT has also been tested and complied with the requirements of FCC Part 15, Subpart B, recorded in a separate test report.



2 Test Configuration of Equipment Under Test

2.1 Test Mode

Antenna port conducted and radiated test items listed below are performed according to KDB 971168 D01 Power Meas License Digital Systems v03r01 with maximum output power.

Radiated measurements are performed by rotating the EUT in three different orthogonal test planes to find the maximum emission. (X Plane)

Test Items	Band	Bandwidth (MHz)						Modulation			RB #			Test Channel		
		1.4	3	5	10	15	20	QPSK	16QAM	64QAM	1	Half	Full	L	M	H
Max. Output Power	2	v	v	v	v	v	v	v	v	-	v		v	v	v	v
	4	v	v	v	v	v	v	v	v	-	v		v	v	v	v
	66	v	v	v	v	v	v	v	v	-	v		v	v	v	v
	5	v	v	v	v	-	-	v	v	-	v		v	v	v	v
	12	v	v	v	v	-	-	v	v	-	v		v	v	v	v
	13	-	-	v	v	-	-	v	v	-	v		v	v	v	v
Peak-to-Average Ratio	2						v	v		-			v		v	
	66						v	v		-			v		v	
	5				v	-	-	v		-			v		v	
	12				v	-	-	v		-			v		v	
	13	-	-		v	-	-	v		-			v		v	
26dB and 99% Bandwidth	2	v	v	v	v	v	v	v	v	-	v		v	v	v	v
	66	v	v	v	v	v	v	v	v	-	v		v	v	v	v
	5	v	v	v	v	-	-	v	v	-	v		v	v	v	v
	12	v	v	v	v	-	-	v	v	-	v		v		v	
	13	-	-	v	v	-	-	v	v	-	v		v		v	
Conducted Band Edge	2	v	v	v	v	v	v	v	v	-	v		v	v		v
	66	v	v	v	v	v	v	v	v	-	v		v	v		v
	5	v	v	v	v	-	-	v	v	-	v		v	v		v
	12	v	v	v	v	-	-	v	v	-	v		v	v		v
	13	-	-	v	v	-	-	v	v	-	v		v	v		v
Conducted Spurious Emission	2	v	v	v	v	v	v	v		-	v			v	v	v
	66	v	v	v	v	v	v	v		-	v			v	v	v
	5	v	v	v	v	-	-	v		-	v			v	v	v
	12	v	v	v	v	-	-	v		-	v			v	v	v
	13	-	-	v	v	-	-	v		-	v			v	v	v



Test Items	Band	Bandwidth (MHz)						Modulation			RB #			Test Channel		
		1.4	3	5	10	15	20	QPSK	16QAM	64QAM	1	Half	Full	L	M	H
Frequency Stability	2				v			v		-			v		v	
	66				v			v		-			v		v	
	5				v	-	-	v		-			v		v	
	12				v	-	-	v		-			v		v	
	13	-	-		v	-	-	v		-			v		v	
E.R.P / E.I.R.P	2	v	v	v	v	v	v	v	v	-	v		v	v	v	v
	4	v	v	v	v	v	v	v	v	-	v		v	v	v	v
	66	v	v	v	v	v	v	v	v	-	v		v	v	v	v
	5	v	v	v	v	-	-	v	v	-	v		v	v	v	v
	12	v	v	v	v	-	-	v	v	-	v		v	v	v	v
	13	-	-	v	v	-	-	v	v	-	v		v	v	v	v
Radiated Spurious Emission	2	Worst Case											v	v	v	
	66	Worst Case											v	v	v	
	5	Worst Case											v	v	v	
	12	Worst Case											v	v	v	
	13	Worst Case											v	v	v	
Note	<ol style="list-style-type: none"> The mark "v" means that this configuration is chosen for testing The mark "-" means that this bandwidth is not supported. The device is investigated from 30MHz to 10 times of fundamental signal for radiated spurious emission test under different RB size/offset and modulations in exploratory test. Subsequently, only the worst case emissions are reported. All test items are based on engineering evaluation. LTE Band 66 overlaps the entire frequency range of LTE Band 4. Therefore, the test results provided in this report covers Band 66 as well as Band 4. 															

2.2 Connection Diagram of Test System

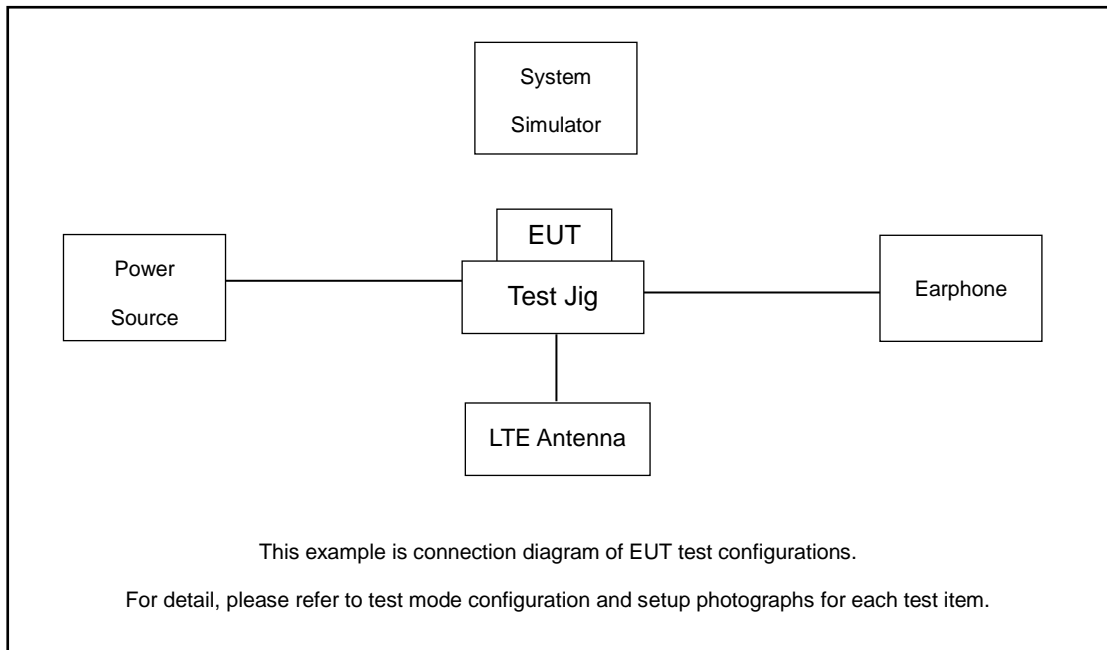

2.3 Support Unit used in test configuration and system

Item	Equipment	Trade Name	Model No.	FCC ID	Data Cable	Power Cord
1.	Power Supply	GWINSTEK	PSS-2002	N/A	N/A	Unshielded, 1.8 m
2.	LTE Base Station	Anritsu	MT8820C	N/A	N/A	Unshielded, 1.8 m
3.	Adapter	Queclink	N/A	N/A	N/A	N/A
4.	Antenna	N/A	N/A	N/A	N/A	N/A
5.	Test Jig	N/A	N/A	N/A	N/A	N/A

2.4 Measurement Results Explanation Example

For all conducted test items:

The offset level is set in the spectrum analyzer to compensate the RF cable loss between EUT conducted output port and spectrum analyzer. With the offset compensation, the spectrum analyzer reading level is exactly the EUT RF output level.

The spectrum analyzer offset is derived from RF cable loss.

$Offset = RF\ cable\ loss.$

Following shows an offset computation example with cable loss 5.4 dB.

Example :

$$Offset(dB) = RF\ cable\ loss(dB).$$

$$= 5.4\ (dB)$$



2.5 Frequency List of Low/Middle/High Channels

LTE Band 2 Channel and Frequency List				
BW [MHz]	Channel/Frequency(MHz)	Lowest	Middle	Highest
20	Channel	18700	18900	19100
	Frequency	1860	1880	1900
15	Channel	18675	18900	19125
	Frequency	1857.5	1880	1902.5
10	Channel	18650	18900	19150
	Frequency	1855	1880	1905
5	Channel	18625	18900	19175
	Frequency	1852.5	1880	1907.5
3	Channel	18615	18900	19185
	Frequency	1851.5	1880	1908.5
1.4	Channel	18607	18900	19193
	Frequency	1850.7	1880	1909.3

LTE Band 4 Channel and Frequency List				
BW [MHz]	Channel/Frequency(MHz)	Lowest	Middle	Highest
20	Channel	20050	20175	20300
	Frequency	1720	1732.5	1745
15	Channel	20025	20175	20325
	Frequency	1717.5	1732.5	1747.5
10	Channel	20000	20175	20350
	Frequency	1715	1732.5	1750
5	Channel	19975	20175	20375
	Frequency	1712.5	1732.5	1752.5
3	Channel	19965	20175	20385
	Frequency	1711.5	1732.5	1753.5
1.4	Channel	19957	20175	20393
	Frequency	1710.7	1732.5	1754.3



LTE Band 5 Channel and Frequency List				
BW [MHz]	Channel/Frequency(MHz)	Lowest	Middle	Highest
10	Channel	20450	20525	20600
	Frequency	829	836.5	844
5	Channel	20425	20525	20625
	Frequency	826.5	836.5	846.5
3	Channel	20415	20525	20635
	Frequency	825.5	836.5	847.5
1.4	Channel	20407	20525	20643
	Frequency	824.7	836.5	848.3

LTE Band 12 Channel and Frequency List				
BW [MHz]	Channel/Frequency(MHz)	Lowest	Middle	Highest
10	Channel	23060	23095	23130
	Frequency	704	707.5	711
5	Channel	23035	23095	23155
	Frequency	701.5	707.5	713.5
3	Channel	23025	23095	23165
	Frequency	700.5	707.5	714.5
1.4	Channel	23017	23095	23173
	Frequency	699.7	707.5	715.3

LTE Band 13 Channel and Frequency List				
BW [MHz]	Channel/Frequency(MHz)	Lowest	Middle	Highest
10	Channel	-	23230	-
	Frequency	-	782	-
5	Channel	23205	23230	23255
	Frequency	779.5	782	784.5



LTE Band 66 Channel and Frequency List				
BW [MHz]	Channel/Frequency(MHz)	Lowest	Middle	Highest
20	Channel	132072	132322	132572
	Frequency	1720	1745	1770
15	Channel	132047	132322	132597
	Frequency	1717.5	1745	1772.5
10	Channel	132022	132322	132622
	Frequency	1715	1745	1775
5	Channel	131997	132322	132647
	Frequency	1712.5	1745	1777.5
3	Channel	131987	132322	132657
	Frequency	1711.5	1745	1778.5
1.4	Channel	131979	132322	132665
	Frequency	1710.7	1745	1779.3

3 Conducted Test Items

3.1 Measuring Instruments

See list of measuring instruments of this test report.

3.2 Test Setup

3.2.1 Conducted Output Power



3.2.2 Peak-to-Average Ratio, Occupied Bandwidth, Conducted Band-Edge and Conducted Spurious Emission

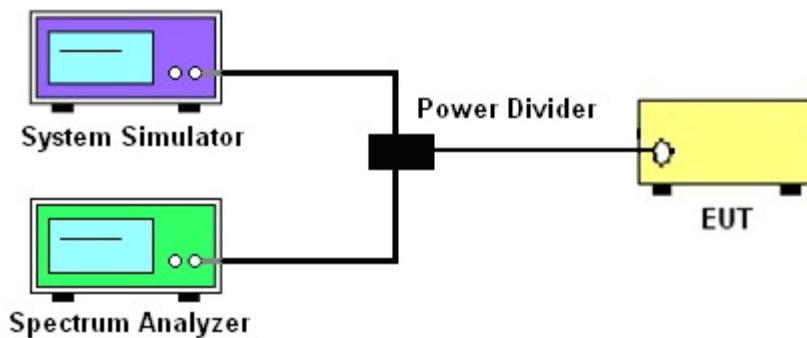

3.2.3 Frequency Stability



3.3 Test Result of Conducted Test

Please refer to Appendix A.



3.4 Conducted Output Power and ERP/EIRP

3.4.1 Description of the Conducted Output Power Measurement and ERP/EIRP Measurement

A system simulator was used to establish communication with the EUT. Its parameters were set to force the EUT transmitting at maximum output power. The measured power in the radio frequency on the transmitter output terminals shall be reported.

The ERP of mobile transmitters must not exceed 7 Watts for LTE Band 5.

The ERP of mobile transmitters must not exceed 3 Watts for LTE Band 12 and Band 13.

The EIRP of mobile transmitters must not exceed 2 Watts for LTE Band 2.

The EIRP of mobile transmitters must not exceed 1 Watts for LTE Band 4 and Band 66.

According to KDB 412172 D01 Power Approach,

$EIRP = P_T + G_T - L_C$, $ERP = EIRP - 2.15$, where

P_T = transmitter output power in dBm

G_T = gain of the transmitting antenna in dBi

L_C = signal attenuation in the connecting cable between the transmitter and antenna in dB

3.4.2 Test Procedures

1. The testing follows ANSI C63.26 Section 5.2
2. The transmitter output port was connected to the system simulator.
3. Set EUT at maximum power through the system simulator.
4. Select lowest, middle, and highest channels for each band and different modulation.
5. Measure and record the power level from the system simulator.



3.5 Peak-to-Average Ratio

3.5.1 Description of the PAR Measurement

Power Complementary Cumulative Distribution Function (CCDF) curves provide a means for characterizing the power peaks of a digitally modulated signal on a statistical basis. A CCDF curve depicts the probability of the peak signal amplitude exceeding the average power level. Most contemporary measurement instrumentation include the capability to produce CCDF curves for an input signal provided that the instrument's resolution bandwidth can be set wide enough to accommodate the entire input signal bandwidth. In measuring transmissions in this band using an average power technique, the peak-to-average ratio (PAR) of the transmission may not exceed 13 dB.

3.5.2 Test Procedures

1. The testing follows ANSI C63.26 Section 5.2.3.4 (CCDF).
2. The EUT was connected to spectrum and system simulator via a power divider.
3. Set the CCDF (Complementary Cumulative Distribution Function) option in spectrum analyzer.
4. The highest RF powers were measured and recorded the maximum PAPR level associated with a probability of 0.1 %.
5. Record the deviation as Peak to Average Ratio.



3.6 Occupied Bandwidth

3.6.1 Description of Occupied Bandwidth Measurement

The occupied bandwidth is the width of a frequency band such that, below the lower and above the upper frequency limits, the mean powers emitted are each equal to a specified percentage 0.5% of the total mean transmitted power.

The 26 dB emission bandwidth is defined as the frequency range between two points, one above and one below the carrier frequency, at which the spectral density of the emission is attenuated 26 dB below the maximum in-band spectral density of the modulated signal. Spectral density (power per unit bandwidth) is to be measured with a detector of resolution bandwidth equal to approximately 1.0% of the emission bandwidth.

3.6.2 Test Procedures

1. The testing follows ANSI C63.26 Section 5.4
2. The EUT was connected to spectrum analyzer and system simulator via a power divider.
3. The spectrum analyzer center frequency is set to the nominal EUT channel center frequency. The span range for the spectrum analyzer shall be between two and five times the anticipated OBW.
4. The nominal resolution bandwidth (RBW) shall be in the range of 1 to 5 % of the anticipated OBW, and the VBW shall be at least 3 times the RBW.
5. Set the detection mode to peak, and the trace mode to max hold.
6. Determine the reference value: Set the EUT to transmit a modulated signal. Allow the trace to stabilize. Set the spectrum analyzer marker to the highest level of the displayed trace.
(this is the reference value)
7. Determine the “-26 dB down amplitude” as equal to (Reference Value – X).
8. Place two markers, one at the lowest and the other at the highest frequency of the envelope of the spectral display such that each marker is at or slightly below the “-X dB down amplitude” determined in step 6. If a marker is below this “-X dB down amplitude” value it shall be placed as close as possible to this value. The OBW is the positive frequency difference between the two markers.
9. Use the 99 % power bandwidth function of the spectrum analyzer and report the measured bandwidth.



3.7 Conducted Band Edge

3.7.1 Description of Conducted Band Edge Measurement

22.917(a)

For operations in the 824 – 849 MHz band, the FCC limit is $43 + 10\log_{10}(P[\text{Watts}])$ dB below the transmitter power $P(\text{Watts})$ in a 100kHz bandwidth. However, in the 1MHz bands immediately outside and adjacent to the licensee's frequency block, a resolution bandwidth of at least one percent of the emission bandwidth of the fundamental emission of the transmitter may be employed.

24.238 (a)

For operations in the 1850-1910 and 1930-1990 MHz band, the FCC limit is $43 + 10\log_{10}(P[\text{Watts}])$ dB below the transmitter power $P(\text{Watts})$ in a 1MHz bandwidth. However, in the 1 MHz bands immediately outside and adjacent to the frequency block a resolution bandwidth of at least one percent of the emission bandwidth of the fundamental emission of the transmitter may be employed.

27.53 (c)

For operations in the 776-788 MHz band, the FCC limit is $43 + 10\log_{10}(P[\text{Watts}])$ dB below the transmitter power $P(\text{Watts})$ in a 100 kHz bandwidth. However, in the 100 kHz bands immediately outside and adjacent to the frequency block, a resolution bandwidth of at least 30 kHz may be employed. In addition, the power of any unwanted emissions in any 6.25 kHz bandwidth for all frequencies between 763-775 MHz and 793-806 MHz shall be attenuated below the transmitter power, P (dBW), by at least $65 + 10 \log_{10} p(\text{watts})$, dB, for mobile and portable equipment.

27.53 (g)

For operations in the 600MHz band and 698 -746 MHz band, the FCC limit is $43 + 10\log_{10}(P[\text{Watts}])$ dB below the transmitter power $P(\text{Watts})$ in a 100 kHz bandwidth. However, in the 100 kilohertz bands immediately outside and adjacent to a licensee's frequency block, a resolution bandwidth of at least 30 kHz may be employed.

27.53 (h)

For operations in the 1710 – 1755 MHz band, the FCC limit is $43 + 10\log_{10}(P[\text{Watts}])$ dB below the transmitter power $P(\text{Watts})$ in a 1 MHz bandwidth. However, in the 1MHz bands immediately outside and adjacent to the licensee's frequency block, a resolution bandwidth of at least one percent of the emission bandwidth of the fundamental emission of the transmitter may be employed.



3.7.2 Test Procedures

1. The testing follows ANSI C63.26 section 5.7
2. The EUT was connected to spectrum analyzer and system simulator via a power divider.
3. The band edges of low and high channels for the highest RF powers were measured.
4. Set RBW \geq 1% EBW in the 1MHz band immediately outside and adjacent to the band edge.
5. Beyond the 1 MHz band from the band edge, RBW=1MHz was used.
6. Set spectrum analyzer with RMS detector.
7. The RF fundamental frequency should be excluded against the limit line in the operating frequency band.
8. Checked that all the results comply with the emission limit line.

Example:

The limit line is derived from $43 + 10\log(P)$ dB below the transmitter power P(Watts)
= P(W)- [43 + 10log(P)] (dB)
= [30 + 10log(P)] (dBm) - [43 + 10log(P)] (dB) = -13dBm.

9. When using the integration method, the starting frequency of the integration shall be centered at one-half of the RBW away from the band edge.



3.8 Conducted Spurious Emission

3.8.1 Description of Conducted Spurious Emission Measurement

The power of any emission outside of the authorized operating frequency ranges must be lower than the transmitter power (P) by a factor of at least $43 + 10 \log (P)$ dB.

It is measured by means of a calibrated spectrum analyzer and scanned from 30 MHz up to a frequency including its 10th harmonic.

3.8.2 Test Procedures

1. The testing follows ANSI C63.26 section 5.7
2. The EUT was connected to spectrum analyzer and system simulator via a power divider.
3. The RF output of EUT was connected to the spectrum analyzer by RF cable and attenuator. The path loss was compensated to the results for each measurement.
4. The middle channel for the highest RF power within the transmitting frequency was measured.
5. The conducted spurious emission for the whole frequency range was taken.
6. Make the measurement with the spectrum analyzer's RBW = 1MHz, VBW = 3MHz.
7. Set spectrum analyzer with RMS detector.
8. Taking the record of maximum spurious emission.
9. The RF fundamental frequency should be excluded against the limit line in the operating frequency band.
10. The limit line is derived from $43 + 10\log(P)$ dB below the transmitter power P(Watts)
= $P(W) - [43 + 10\log(P)]$ (dB)
= $[30 + 10\log(P)]$ (dBm) - $[43 + 10\log(P)]$ (dB)
= -13dBm.



3.9 Frequency Stability

3.9.1 Description of Frequency Stability Measurement

The frequency stability shall be measured by variation of ambient temperature and variation of primary supply voltage to ensure that the fundamental emission stays within the authorized frequency block. The frequency stability of the transmitter shall be maintained within $\pm 0.00025\%$ ($\pm 2.5\text{ppm}$) of the center frequency.

3.9.2 Test Procedures for Temperature Variation

1. The testing follows ANSI C63.26 section 5.6.4
2. The EUT was set up in the thermal chamber and connected with the system simulator.
3. With power OFF, the temperature was decreased to -30°C and the EUT was stabilized before testing. Power was applied and the maximum change in frequency was recorded within one minute.
4. With power OFF, the temperature was raised in 10°C step up to 50°C . The EUT was stabilized at each step for at least half an hour. Power was applied and the maximum frequency change was recorded within one minute.

3.9.3 Test Procedures for Voltage Variation

1. The testing follows ANSI C63.26 section 5.6.5
2. The EUT was placed in a temperature chamber at $20\pm 5^{\circ}\text{C}$ and connected with the system simulator.
3. The power supply voltage to the EUT was varied from 85% to 115% of the nominal value for other than hand carried battery equipment.
4. For hand carried, battery powered equipment, reduce the primary ac or dc supply voltage to the battery operating end point, which shall be specified by the manufacturer.
5. The variation in frequency was measured for the worst case.

4 Radiated Test Items

4.1 Measuring Instruments

See list of measuring instruments of this test report.

4.2 Test Setup

4.2.1 For radiated test below 30MHz

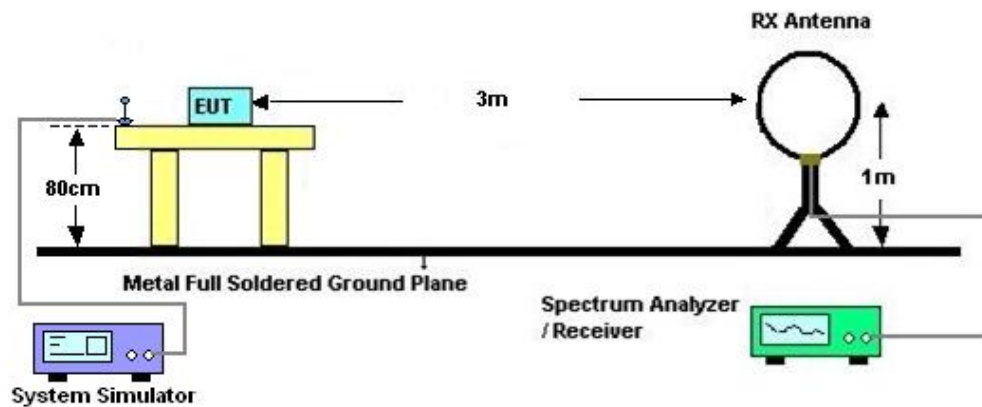

4.2.2 For radiated test from 30MHz to 1GHz

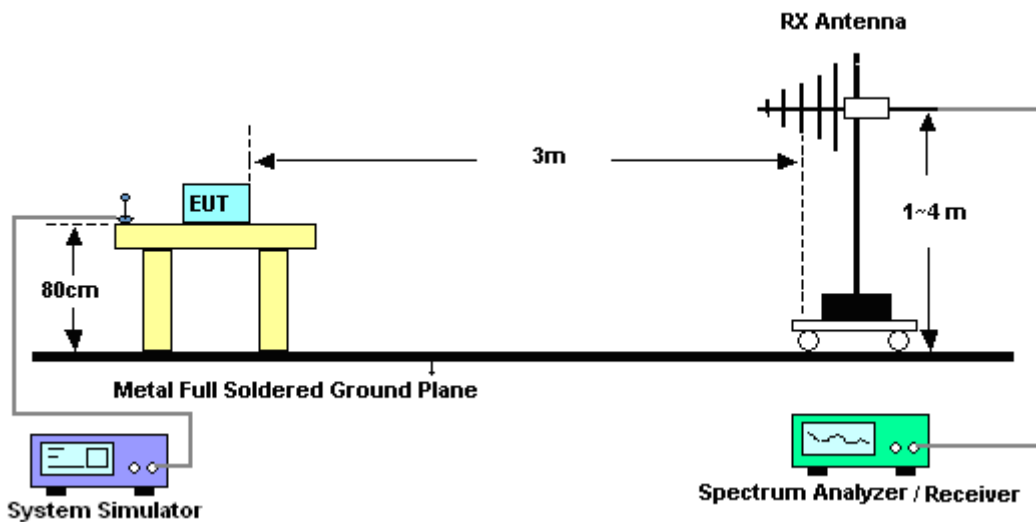

4.2.3 For radiated test above 1GHz

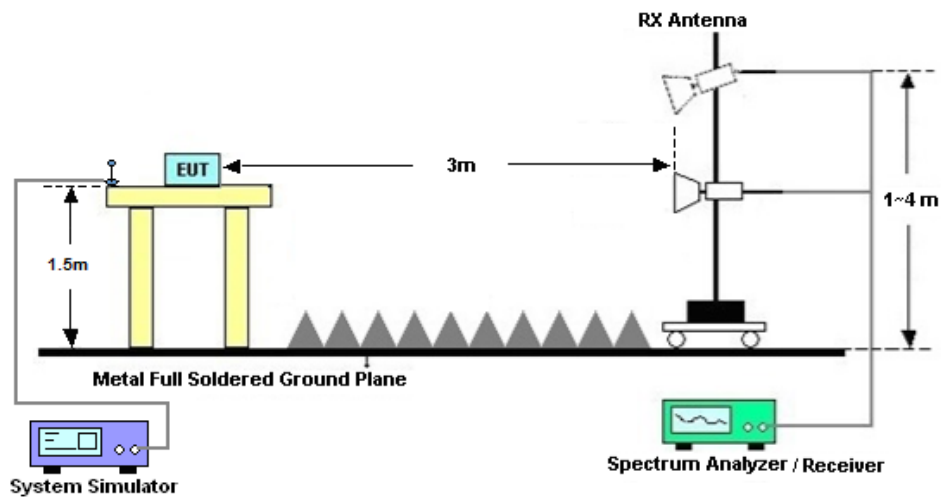

4.3 Test Result of Radiated Test

The low frequency, which started from 9 kHz to 30MHz, was pre-scanned and the result which was 20dB lower than the limit line was not reported.

Please refer to Appendix B.



4.4 Radiated Spurious Emission

4.4.1 Description of Radiated Spurious Emission

The radiated spurious emission was measured by substitution method according to ANSI C63.26. The power of any emission outside of the authorized operating frequency ranges must be attenuated below the transmitter power (P) by a factor of at least $43 + 10 \log (P)$ dB.

For LTE Band 13

For operations in the 746-758 MHz, 775-788 MHz, and 805-806 MHz bands, emissions in the band 1559-1610 MHz shall be limited to -70 dBW/MHz equivalent isotropically radiated power (EIRP) for wideband signals, and -80 dBW EIRP for discrete emissions of less than 700 Hz bandwidth.

The spectrum is scanned from 30 MHz up to a frequency including its 10th harmonic.

4.4.2 Test Procedures

1. The testing follows ANSI C63.26 Section 5.5
2. The EUT was placed on a turntable with 0.8 meter height for frequency below 1GHz and 1.5 meter height for frequency above 1GHz respectively above ground.
3. The EUT was set 3 meters from the receiving antenna mounted on the antenna tower.
4. The table was rotated 360 degrees to determine the position of the highest spurious emission.
5. The height of the receiving antenna is varied between 1m to 4m to search the maximum spurious emission for both horizontal and vertical polarizations.
6. During the measurement, the system simulator parameters were set to force the EUT transmitting at maximum output power.
7. Make the measurement with the spectrum analyzer's RBW = 1MHz, VBW = 3MHz, taking the record of maximum spurious emission.
8. A horn antenna was substituted in place of the EUT and was driven by a signal generator.
9. Tune the output power of signal generator to the same emission level with EUT maximum spurious emission.
10. $EIRP (dBm) = S.G. Power - Tx Cable Loss + Tx Antenna Gain$
11. $ERP (dBm) = EIRP - 2.15$
12. The RF fundamental frequency should be excluded against the limit line in the operating frequency band.

The limit line is derived from $43 + 10\log(P)$ dB below the transmitter power P(Watts)
 $= P(W) - [43 + 10\log(P)] (dB)$
 $= [30 + 10\log(P)] (dBm) - [43 + 10\log(P)] (dB)$
 $= -13dBm.$



5 List of Measuring Equipment

Instrument	Manufacturer	Model No.	Serial No.	Characteristics	Calibration Date	Test Date	Due Date	Remark
Spectrum Analyzer	R&S	FSV30	101338	10Hz~30GHz	May 16, 2023	Jul. 27, 2023~ Sep. 08, 2023	May 15, 2024	Conducted (TH01-KS)
Spectrum Analyzer	R&S	FSV40	101040	10Hz~40GHz	Oct. 12, 2022	Jul. 27, 2023~ Sep. 08, 2023	Oct. 11, 2023	Conducted (TH01-KS)
Power divider	STI	STI08-0055	-	0.5~40GHz	NCR	Jul. 27, 2023~ Sep. 08, 2023	NCR	Conducted (TH01-KS)
Temperature &	Hongzhan	LP-150U	H2014011440	-40~+150°C 20%~95%RH	Jul. 06, 2023	Jul. 27, 2023~ Sep. 08, 2023	Jul. 05, 2024	Conducted (TH01-KS)
EXA Spectrum Analyzer	Keysight	N9010B	MY57471079	10Hz-44G,MAX 30dB	Oct. 12, 2022	Aug. 01, 2023	Oct. 11, 2023	Radiation (03CH04-KS)
Bilog Antenna	TeseQ	CBL6111D	49922	30MHz-1GHz	Apr. 09, 2023	Aug. 01, 2023	Apr. 08, 2024	Radiation (03CH04-KS)
Loop Antenna	R&S	HFH2-Z2E	101125	9kHz~30MHz	Sep. 22, 2022	Aug. 01, 2023	Sep. 21, 2023	Radiation (03CH04-KS)
Horn Antenna	Schwarzbeck	BBHA9120D	1284	1GHz~18GHz	Oct. 16, 2022	Aug. 01, 2023	Oct. 15, 2023	Radiation (03CH04-KS)
SHF-EHF Horn	Com-power	AH-840	101070	18GHz~40GHz	Jan. 08, 2023	Aug. 01, 2023	Jan. 07, 2024	Radiation (03CH04-KS)
Amplifier	SONOMA	310N	380827	9KHz-1GHz	Jul 06, 2023	Aug. 01, 2023	Jul 05, 2024	Radiation (03CH04-KS)
Amplifier	MITEQ	EM18G40G GA	060728	18~40GHz	Jan. 05, 2023	Aug. 01, 2023	Jan. 04, 2024	Radiation (03CH04-KS)
high gain Amplifier	EM	EM01G18G A	060840	1Ghz-18Ghz	Oct. 12, 2022	Aug. 01, 2023	Oct. 11, 2023	Radiation (03CH04-KS)
Amplifier	Agilent	8449B	3008A02370	1Ghz-18Ghz	Oct. 12, 2022	Aug. 01, 2023	Oct. 11, 2023	Radiation (03CH04-KS)
AC Power Source	Chroma	61601	F104090004	N/A	NCR	Aug. 01, 2023	NCR	Radiation (03CH04-KS)
Turn Table	ChamPro	EM 1000-T	060762-T	0~360 degree	NCR	Aug. 01, 2023	NCR	Radiation (03CH04-KS)
Antenna Mast	ChamPro	EM 1000-A	060762-A	1 m~4 m	NCR	Aug. 01, 2023	NCR	Radiation (03CH04-KS)

NCR: No Calibration Required



6 Measurement Uncertainty

The measurement uncertainties shown below were calculated in accordance with the requirements of ANSI 63.26-2015. All the measurement uncertainty value were shown with a coverage K=2 to indicate 95% level of confidence. The measurement data show herein meets or exceeds the CISPR measurement uncertainty values specified in CISPR 16-4-2 and can be compared directly to specified limit to determine compliance.

Uncertainty of Conducted Measurement

Test Item	Uncertainty
Conducted Power	±0.46 dB
Conducted Emissions	±2.26 dB
Occupied Channel Bandwidth	±0.1 %

Uncertainty of Radiated Emission Measurement (30 MHz ~ 1000 MHz)

Measuring Uncertainty for a Level of Confidence of 95% (U = 2Uc(y))	6.28dB
---	--------

Uncertainty of Radiated Emission Measurement (1 GHz ~ 18GHz)

Measuring Uncertainty for a Level of Confidence of 95% (U = 2Uc(y))	4.90dB
---	--------

Uncertainty of Radiated Emission Measurement (18 GHz ~ 40GHz)

Measuring Uncertainty for a Level of Confidence of 95% (U = 2Uc(y))	5.26dB
---	--------



Appendix A. Test Results of Conducted Test

Test Engineer :	Smile Wang	Temperature :	22~23°C
		Relative Humidity :	40~42%

Conducted Output Power(Average power) and ERP/EIRP

LTE Band 2:

BW [MHz]	Modulation	RB Size	RB Offset	Power Low Ch. / Freq.	Power Middle Ch. / Freq.	Power High Ch. / Freq.	EIRP(W)		
							L	M	H
Channel				18700	18900	19100	EIRP(W)		
Frequency (MHz)				1860	1880	1900	L	M	H
20	QPSK	1	0	23.62	23.63	23.41	0.3319	0.3327	0.3162
20	QPSK	1	99	23.51	23.41	23.40	0.3236	0.3162	0.3155
20	QPSK	100	0	22.52	22.44	22.47	0.2576	0.2529	0.2547
20	16QAM	1	0	22.57	22.53	22.55	0.2606	0.2582	0.2594
Channel				18675	18900	19125	EIRP(W)		
Frequency (MHz)				1857.5	1880	1902.5	L	M	H
15	QPSK	1	0	23.41	23.56	23.45	0.3162	0.3273	0.3192
15	16QAM	1	0	22.45	22.47	22.41	0.2535	0.2547	0.2512
Channel				18650	18900	19150	EIRP(W)		
Frequency (MHz)				1855	1880	1905	L	M	H
10	QPSK	1	0	23.51	23.52	23.41	0.3236	0.3243	0.3162
10	16QAM	1	0	22.48	22.53	22.42	0.2553	0.2582	0.2518
Channel				18625	18900	19175	EIRP(W)		
Frequency (MHz)				1852.5	1880	1907.5	L	M	H
5	QPSK	1	0	23.55	23.58	23.52	0.3266	0.3289	0.3243
5	16QAM	1	0	22.41	22.45	22.43	0.2512	0.2535	0.2523
Channel				18615	18900	19185	EIRP(W)		
Frequency (MHz)				1851.5	1880	1908.5	L	M	H
3	QPSK	1	0	23.33	23.38	23.52	0.3105	0.3141	0.3243
3	16QAM	1	0	22.41	22.39	22.47	0.2512	0.2500	0.2547
Channel				18607	18900	19193	EIRP(W)		
Frequency (MHz)				1850.7	1880	1909.3	L	M	H
1.4	QPSK	1	0	23.55	23.41	23.47	0.3266	0.3162	0.3206
1.4	16QAM	1	0	22.43	22.48	22.35	0.2523	0.2553	0.2477



LTE Band 4:

BW [MHz]	Modulation	RB Size	RB Offset	Power Low Ch. / Freq.	Power Middle Ch. / Freq.	Power High Ch. / Freq.	EIRP(W)		
Channel				20050	20175	20300	EIRP(W)		
Frequency (MHz)				1720	1732.5	1745	L	M	H
20	QPSK	1	0	23.35	23.37	23.44	0.3428	0.3443	0.3499
20	QPSK	1	99	23.28	23.41	23.41	0.3373	0.3475	0.3475
20	QPSK	100	0	22.57	22.76	22.71	0.2864	0.2992	0.2958
20	16QAM	1	0	22.51	22.53	22.69	0.2825	0.2838	0.2944
Channel				20025	20175	20325	EIRP(W)		
Frequency (MHz)				1717.5	1732.5	1747.5	L	M	H
15	QPSK	1	0	23.41	23.39	23.32	0.3475	0.3459	0.3404
15	16QAM	1	0	22.56	22.51	22.55	0.2858	0.2825	0.2851
Channel				20000	20175	20350	EIRP(W)		
Frequency (MHz)				1715	1732.5	1750	L	M	H
10	QPSK	1	0	23.37	23.31	23.35	0.3443	0.3396	0.3428
10	16QAM	1	0	22.46	22.44	22.37	0.2793	0.2780	0.2735
Channel				19975	20175	20375	EIRP(W)		
Frequency (MHz)				1712.5	1732.5	1752.5	L	M	H
5	QPSK	1	0	23.32	23.36	23.34	0.3404	0.3436	0.3420
5	16QAM	1	0	22.31	22.54	22.51	0.2698	0.2844	0.2825
Channel				19965	20175	20385	EIRP(W)		
Frequency (MHz)				1711.5	1732.5	1753.5	L	M	H
3	QPSK	1	0	23.33	23.42	23.34	0.3412	0.3483	0.3420
3	16QAM	1	0	22.35	22.51	22.53	0.2723	0.2825	0.2838
Channel				19957	20175	20393	EIRP(W)		
Frequency (MHz)				1710.7	1732.5	1754.3	L	M	H
1.4	QPSK	1	0	23.42	23.39	23.41	0.3483	0.3459	0.3475
1.4	16QAM	1	0	22.41	22.42	22.51	0.2761	0.2767	0.2825



LTE Band 5:

BW [MHz]	Modulation	RB Size	RB Offset	Power Low Ch. / Freq.	Power Middle Ch. / Freq.	Power High Ch. / Freq.	ERP(W)		
Channel				20450	20525	20600	ERP(W)		
Frequency (MHz)				829	836.5	844	L	M	H
10	QPSK	1	0	23.31	23.57	23.45	0.2339	0.2483	0.2415
10	QPSK	1	49	23.24	23.41	23.44	0.2301	0.2393	0.2410
10	QPSK	50	0	22.57	22.73	22.69	0.1972	0.2046	0.2028
10	16QAM	1	0	22.54	22.53	22.61	0.1959	0.1954	0.1991
Channel				20425	20525	20625	ERP(W)		
Frequency (MHz)				826.5	836.5	846.5	L	M	H
5	QPSK	1	0	23.45	23.33	23.32	0.2415	0.2350	0.2344
5	16QAM	1	0	22.34	22.24	22.54	0.1871	0.1828	0.1959
Channel				20415	20525	20635	ERP(W)		
Frequency (MHz)				825.5	836.5	847.5	L	M	H
3	QPSK	1	0	23.31	23.31	23.35	0.2339	0.2339	0.2360
3	16QAM	1	0	22.45	22.44	22.37	0.1919	0.1914	0.1884
Channel				20407	20525	20643	ERP(W)		
Frequency (MHz)				824.7	836.5	848.3	L	M	H
1.4	QPSK	1	0	23.32	23.38	23.34	0.2344	0.2377	0.2355
1.4	16QAM	1	0	22.34	22.54	22.47	0.1871	0.1959	0.1928



LTE Band 12:

BW [MHz]	Modulation	RB Size	RB Offset	Power Low Ch. / Freq.	Power Middle Ch. / Freq.	Power High Ch. / Freq.	ERP(W)		
Channel				23060	23095	23130			
Frequency (MHz)				704	707.5	711	L	M	H
10	QPSK	1	0	23.45	23.32	23.47	0.3350	0.3251	0.3365
10	QPSK	1	49	23.24	23.41	23.31	0.3192	0.3319	0.3243
10	QPSK	50	0	22.53	22.57	22.65	0.2710	0.2735	0.2786
10	16QAM	1	0	22.59	22.53	22.42	0.2748	0.2710	0.2642
Channel				23035	23095	23155	ERP(W)		
Frequency (MHz)				701.5	707.5	713.5	L	M	H
5	QPSK	1	0	23.45	23.38	23.32	0.3350	0.3296	0.3251
5	16QAM	1	0	22.37	22.24	22.37	0.2612	0.2535	0.2612
Channel				23025	23095	23165	ERP(W)		
Frequency (MHz)				700.5	707.5	714.5	L	M	H
3	QPSK	1	0	23.39	23.31	23.35	0.3304	0.3243	0.3273
3	16QAM	1	0	22.45	22.48	22.34	0.2661	0.2679	0.2594
Channel				23017	23095	23173	ERP(W)		
Frequency (MHz)				699.7	707.5	715.3	L	M	H
1.4	QPSK	1	0	23.39	23.38	23.34	0.3304	0.3296	0.3266
1.4	16QAM	1	0	22.34	22.54	22.44	0.2594	0.2716	0.2655

LTE Band 13:

BW [MHz]	Modulation	RB Size	RB Offset	Power Low Ch. / Freq.	Power Middle Ch. / Freq.	Power High Ch. / Freq.	ERP(W)		
Channel				23230					
Frequency (MHz)				782				M	
10	QPSK	1	0		23.57			0.3864	
10	QPSK	1	49		23.38			0.3698	
10	QPSK	50	0		22.54			0.3048	
10	16QAM	1	0		22.77			0.3214	
Channel				23205	23230	23255	ERP(W)		
Frequency (MHz)				779.5	782	784.5	L	M	H
5	QPSK	1	0	23.55	23.42	23.53	0.3846	0.3733	0.3828
5	16QAM	1	0	22.76	22.73	22.62	0.3206	0.3184	0.3105



LTE Band 66:

BW [MHz]	Modulation	RB Size	RB Offset	Power Low Ch. / Freq.	Power Middle Ch. / Freq.	Power High Ch. / Freq.	EIRP(W)		
Channel				132072	132322	132572	EIRP(W)		
Frequency (MHz)				1720	1745	1770	L	M	H
20	QPSK	1	0	23.42	23.45	23.58	0.3483	0.3508	0.3614
20	QPSK	1	99	23.28	23.39	23.51	0.3373	0.3459	0.3556
20	QPSK	100	0	22.51	22.76	22.71	0.2825	0.2992	0.2958
20	16QAM	1	0	22.49	22.53	22.69	0.2812	0.2838	0.2944
Channel				132047	132322	132597	EIRP(W)		
Frequency (MHz)				1717.5	1745	1772.5	L	M	H
15	QPSK	1	0	23.38	23.31	23.32	0.3451	0.3396	0.3404
15	16QAM	1	0	22.28	22.51	22.54	0.2679	0.2825	0.2844
Channel				132022	132322	132622	EIRP(W)		
Frequency (MHz)				1715	1745	1775	L	M	H
10	QPSK	1	0	23.37	23.48	23.35	0.3443	0.3532	0.3428
10	16QAM	1	0	22.52	22.44	22.38	0.2831	0.2780	0.2742
Channel				131997	132322	132647	EIRP(W)		
Frequency (MHz)				1712.5	1745	1777.5	L	M	H
5	QPSK	1	0	23.39	23.36	23.34	0.3459	0.3436	0.3420
5	16QAM	1	0	22.31	22.57	22.51	0.2698	0.2864	0.2825
Channel				131987	132322	132657	EIRP(W)		
Frequency (MHz)				1711.5	1745	1778.5	L	M	H
3	QPSK	1	0	23.33	23.55	23.34	0.3412	0.3589	0.3420
3	16QAM	1	0	22.35	22.51	22.41	0.2723	0.2825	0.2761
Channel				131979	132322	132665	EIRP(W)		
Frequency (MHz)				1710.7	1745	1779.3	L	M	H
1.4	QPSK	1	0	23.57	23.39	23.41	0.3606	0.3459	0.3475
1.4	16QAM	1	0	22.48	22.42	22.59	0.2805	0.2767	0.2877



LTE Band 2

Peak-to-Average Ratio

Mode	LTE Band 2 / 20MHz		
Mod.	QPSK	16QAM	Limit: 13dB
RB Size	Full RB	Full RB	Result
Middle CH	5.22	6.26	PASS

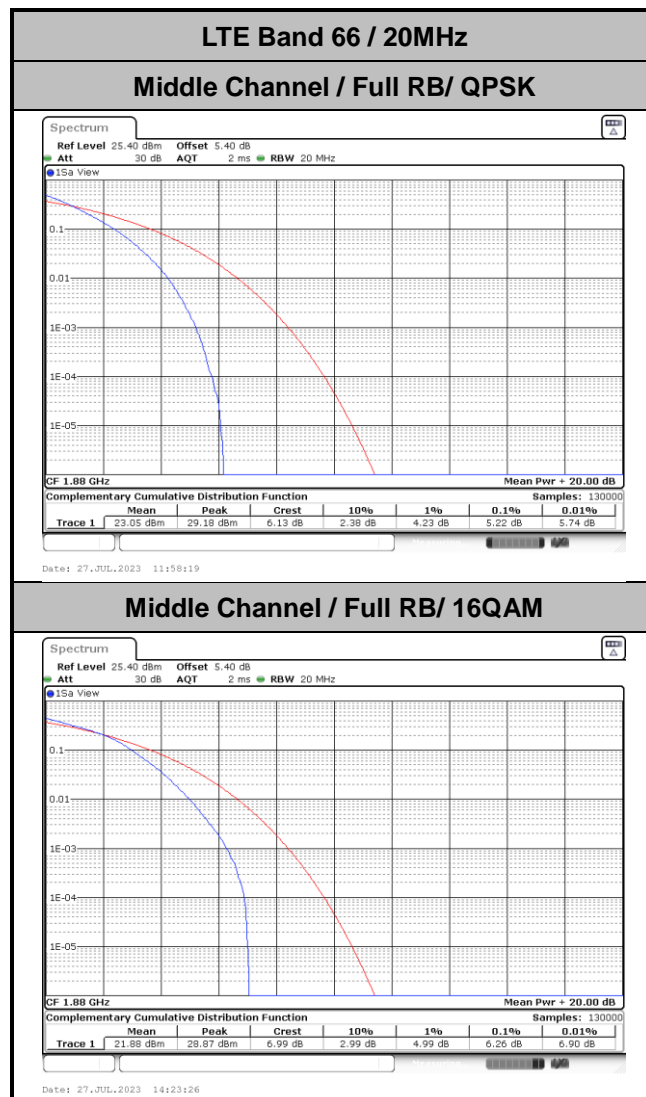



26dB Bandwidth

Mode	LTE Band 2 : 26dB BW(MHz) Full RB	
BW	1.4MHz	
Mod.	QPSK	16QAM
Middle CH	1.26	1.27
BW	3MHz	
Mod.	QPSK	16QAM
Middle CH	3.04	3.05
BW	5MHz	
Mod.	QPSK	16QAM
Middle CH	4.94	4.81
BW	10MHz	
Mod.	QPSK	16QAM
Middle CH	9.73	5.81
BW	15MHz	
Mod.	QPSK	16QAM
Middle CH	14.69	6.29
BW	20MHz	
Mod.	QPSK	16QAM
Middle CH	19.22	5.83



Mode	LTE Band 2 : 26dB BW(MHz) 1RB	
BW	3MHz	
Mod.	QPSK	16QAM
L CH 1RB	0.64	0.62
H CH 1RB	0.59	0.58
BW	5MHz	
Mod.	QPSK	16QAM
L CH 1RB	0.88	0.69
H CH 1RB	0.80	0.72
BW	10MHz	
Mod.	QPSK	16QAM
L CH 1RB	1.84	1.62
H CH 1RB	1.44	1.76
BW	15MHz	
Mod.	QPSK	16QAM
L CH 1RB	1.68	1.77
H CH 1RB	1.83	1.83
BW	20MHz	
Mod.	QPSK	16QAM
L CH 1RB	1.36	1.44
H CH 1RB	1.64	1.92



Full RB (Middle CH):

LTE Band 2

Middle Channel / 1.4MHz / QPSK

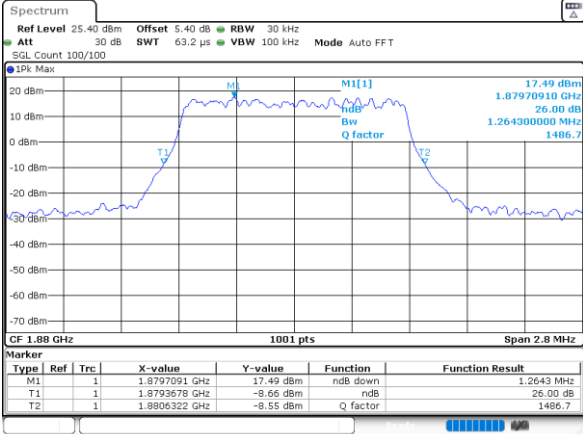

Date: 27_JUL_2023 11:57:56

Middle Channel / 1.4MHz / 16QAM

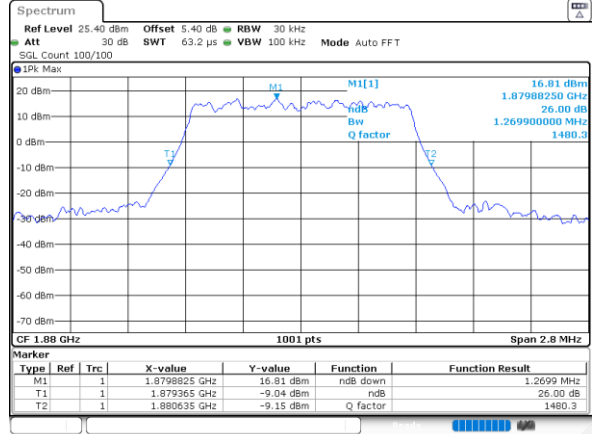

Date: 27_JUL_2023 13:09:138

LTE Band 2

Middle Channel / 3MHz / QPSK

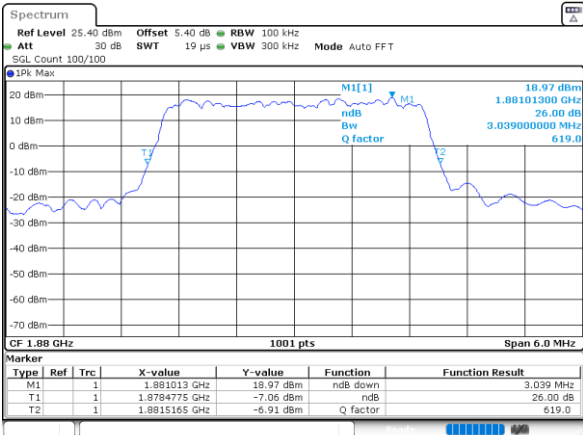

Date: 27_JUL_2023 11:57:14

Middle Channel / 3MHz / 16QAM

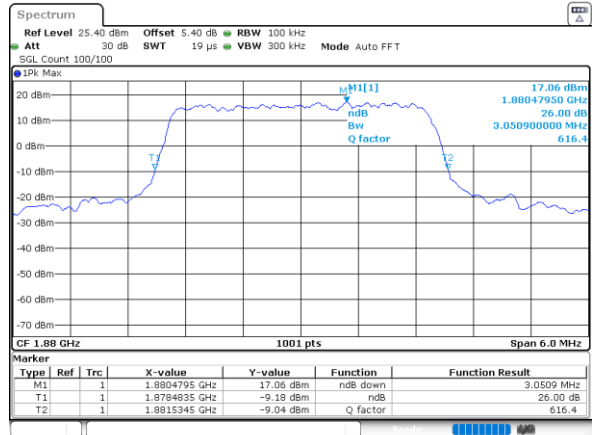

Date: 27_JUL_2023 13:08:555

LTE Band 2

Middle Channel / 5MHz / QPSK

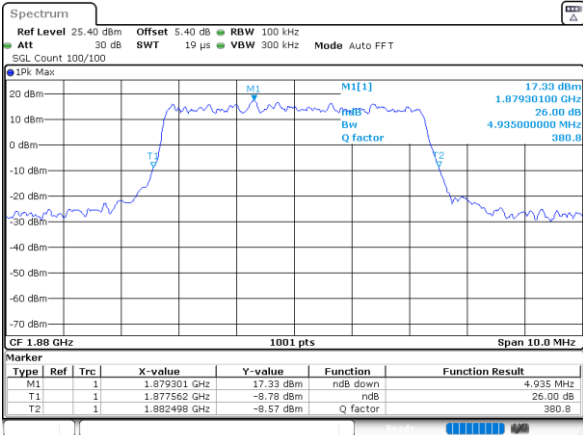

Date: 27_JUL_2023 11:56:33

Middle Channel / 5MHz / 16QAM

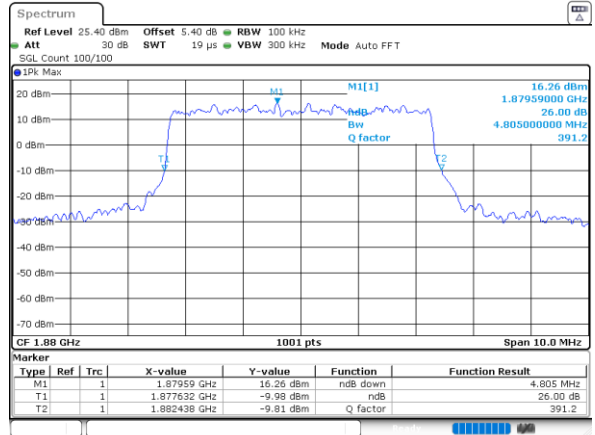

Date: 27_JUL_2023 13:08:113



LTE Band 2

Middle Channel / 10MHz / QPSK

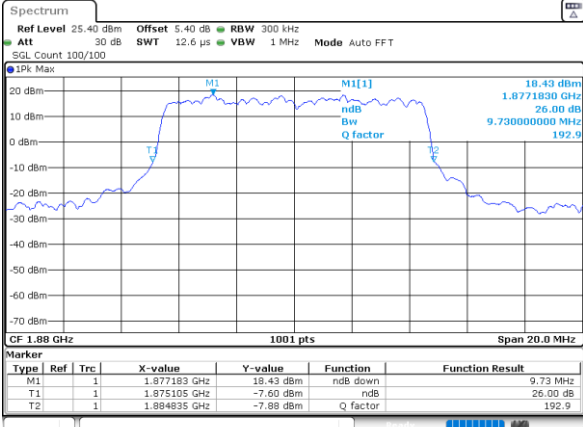

Date: 27_JUL_2023 11:55:49

Middle Channel / 10MHz / 16QAM

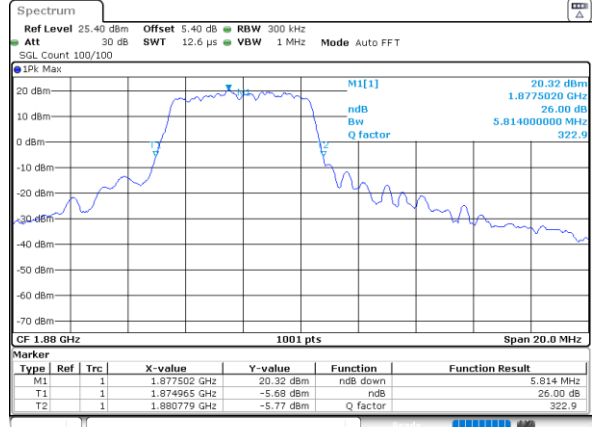

Date: 27_JUL_2023 14:06:136

LTE Band 2

Middle Channel / 15MHz / QPSK

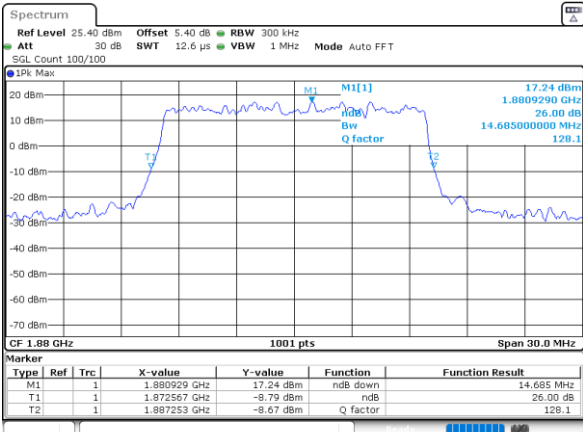

Date: 27_JUL_2023 11:55:06

Middle Channel / 15MHz / 16QAM

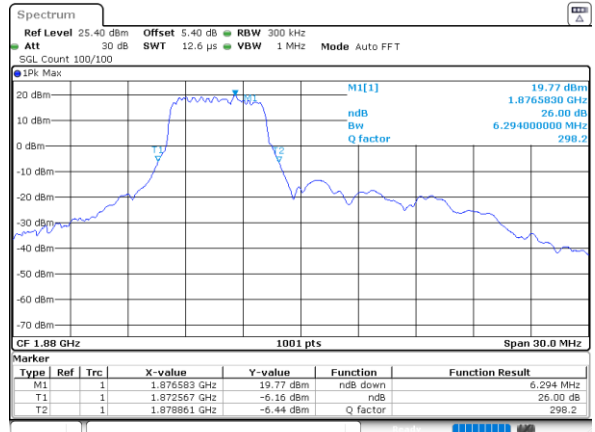

Date: 27_JUL_2023 14:14:20

LTE Band 2

Middle Channel / 20MHz / QPSK

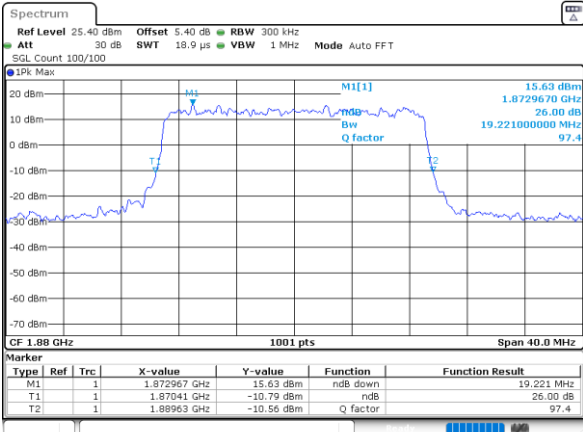

Date: 27_JUL_2023 11:54:24

Middle Channel / 20MHz / 16QAM

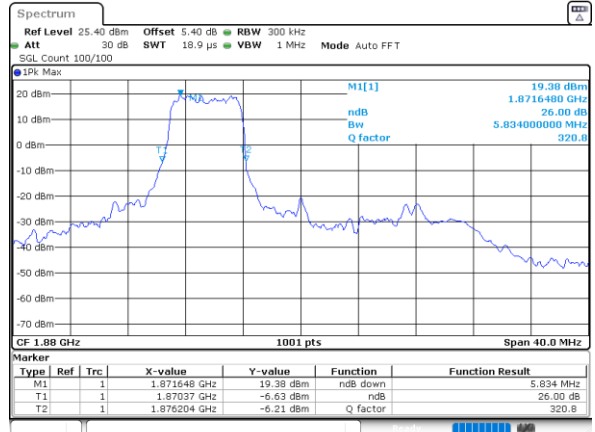

Date: 27_JUL_2023 14:18:131



1 RB (Low/High CH):

LTE Band 2

L CH / 3MHz / QPSK

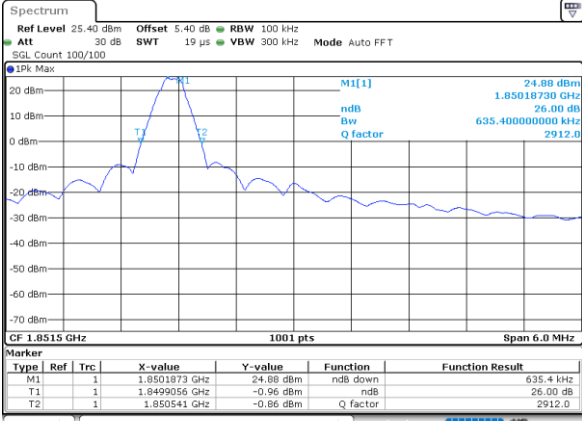

Date: 23_AUG_2023 09:38:57

L CH / 3MHz / 16QAM

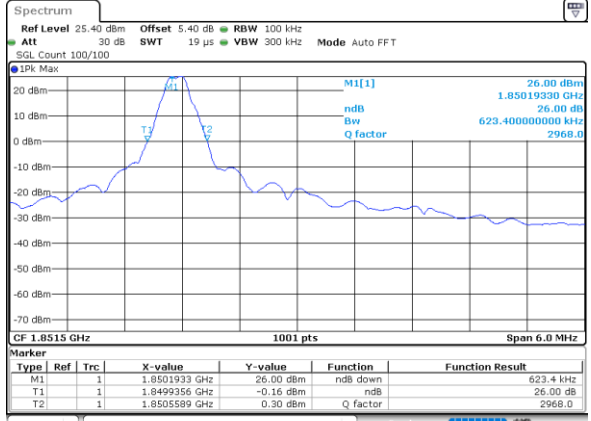

Date: 23_AUG_2023 09:40:06

LTE Band 2

H CH / 3MHz / QPSK

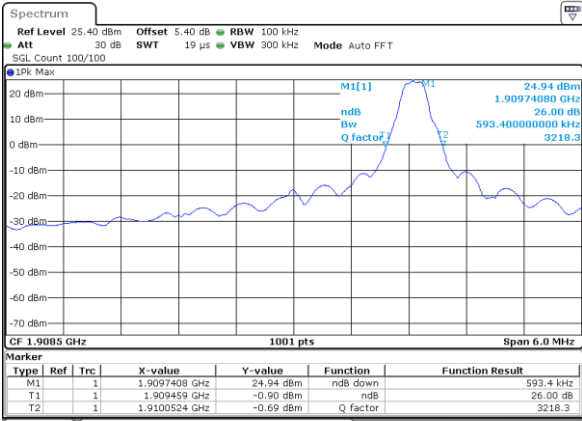

Date: 23_AUG_2023 09:43:18

H CH / 3MHz / 16QAM

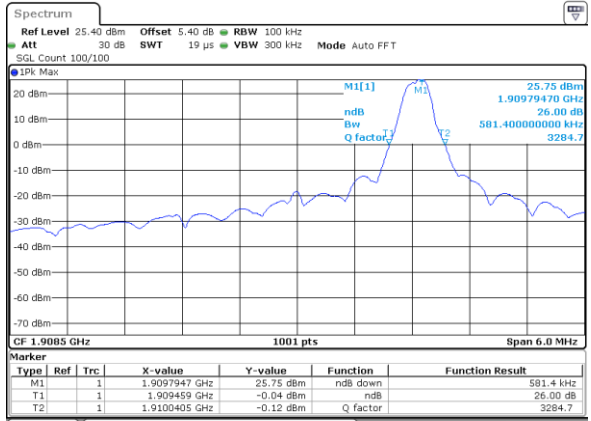

Date: 23_AUG_2023 09:43:58

LTE Band 2

L CH / 5MHz / QPSK

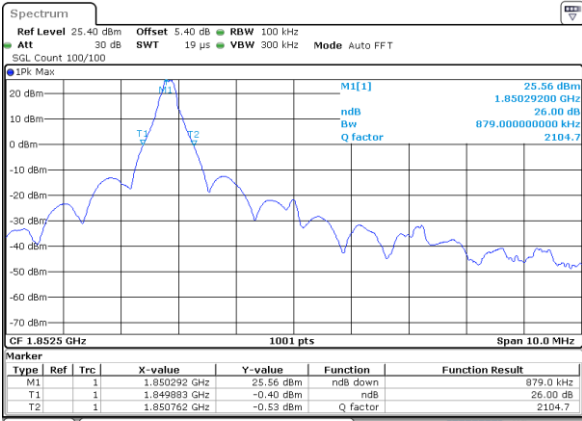

Date: 23_AUG_2023 09:47:59

L CH / 5MHz / 16QAM

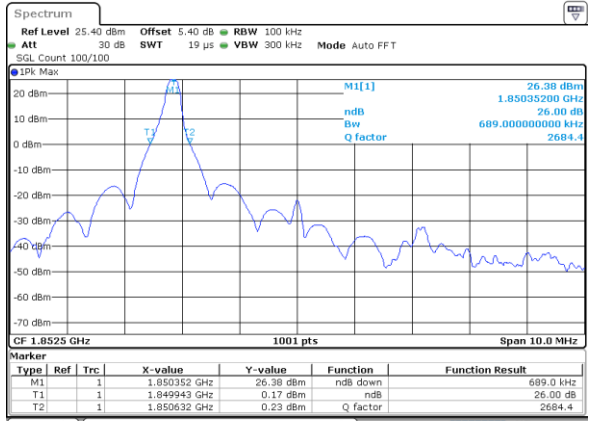

Date: 23_AUG_2023 09:48:20



LTE Band 2

H CH / 5MHz / QPSK

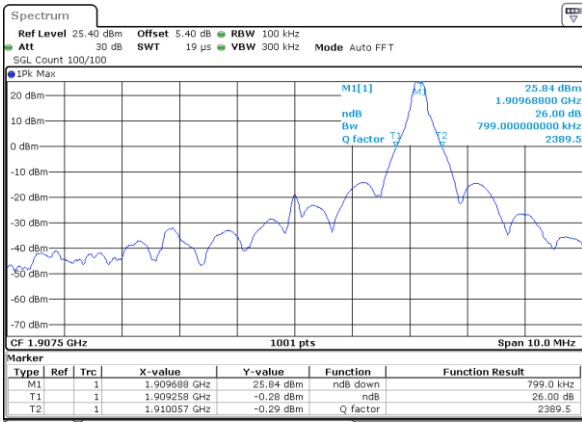

Date: 23_AUG_2023 09:49:04

H CH / 5MHz / 16QAM

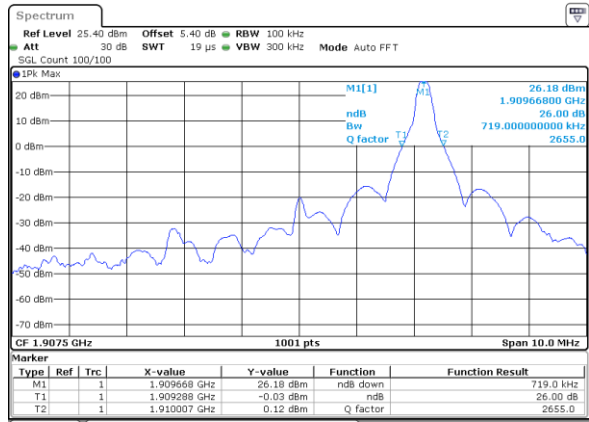

Date: 23_AUG_2023 09:48:42

LTE Band 2

L CH / 10MHz / QPSK

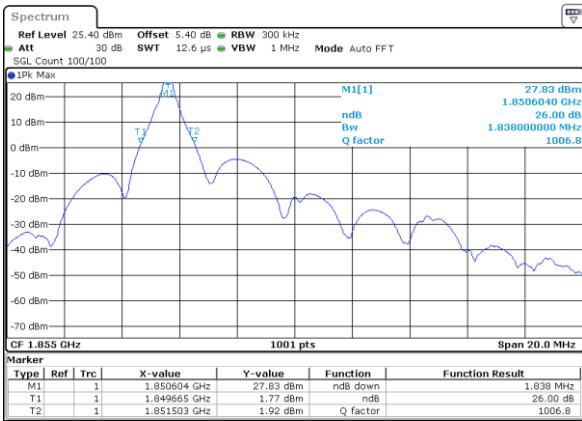

Date: 23_AUG_2023 09:49:26

L CH / 10MHz / 16QAM

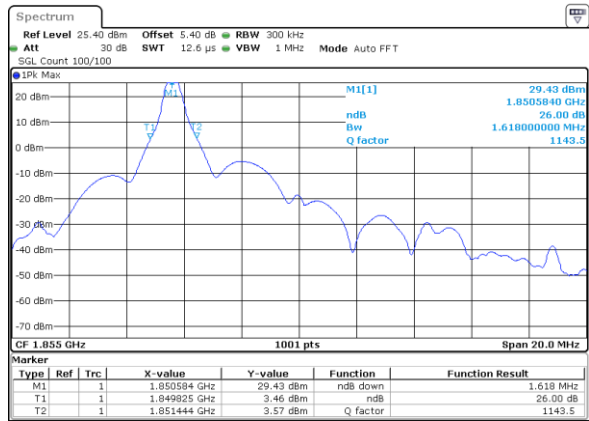

Date: 23_AUG_2023 09:49:48

LTE Band 2

H CH / 10MHz / QPSK

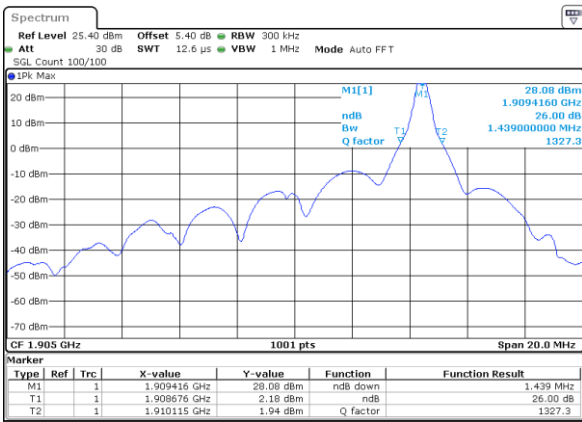

Date: 23_AUG_2023 09:50:33

H CH / 10MHz / 16QAM

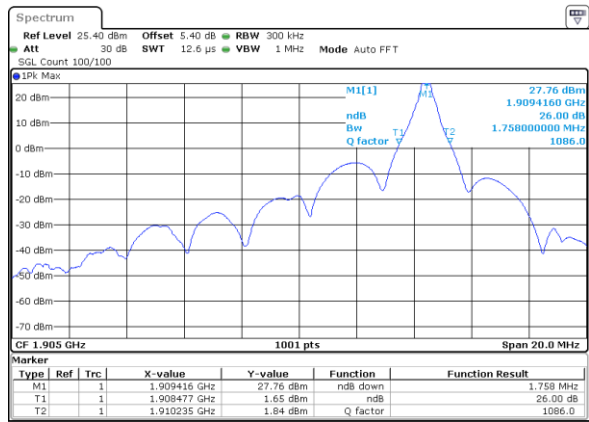

Date: 23_AUG_2023 09:50:09



LTE Band 2

L CH / 15MHz / QPSK

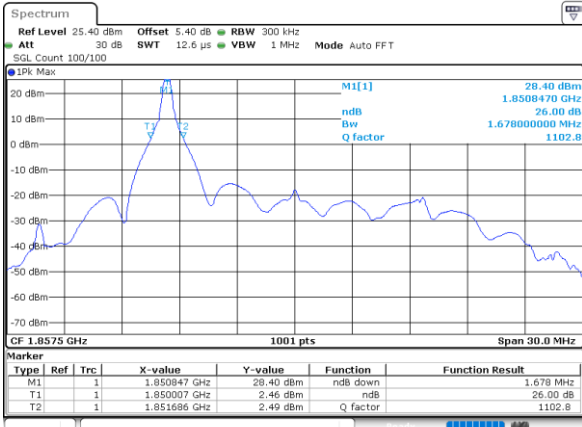

Date: 23_AUG_2023 10:10:34

L CH / 15MHz / 16QAM



Date: 23_AUG_2023 10:10:57

LTE Band 2

H CH / 15MHz / QPSK

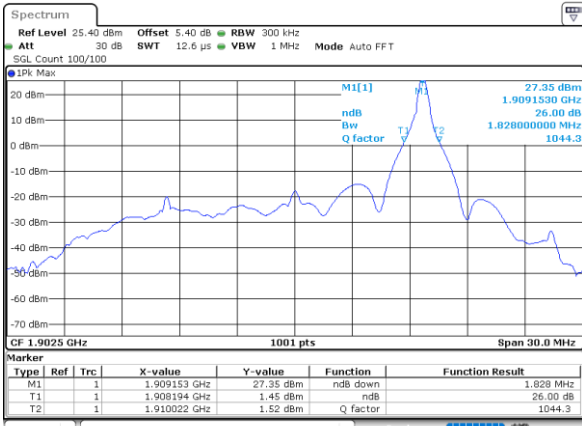

Date: 23_AUG_2023 10:13:00

H CH / 15MHz / 16QAM

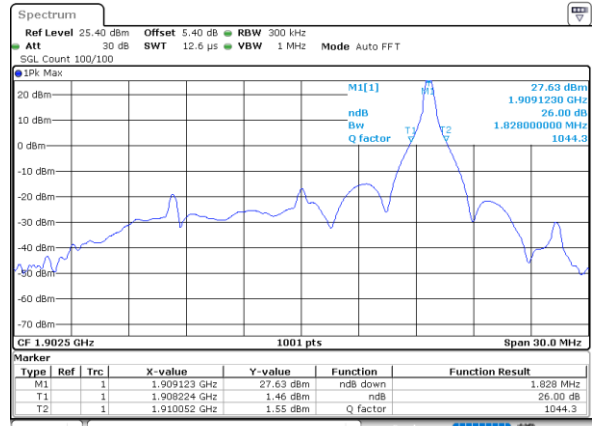

Date: 23_AUG_2023 10:11:22

LTE Band 2

L CH / 20MHz / QPSK

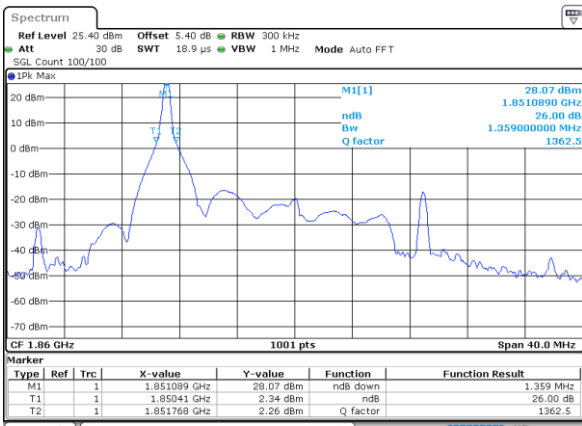

Date: 23_AUG_2023 09:55:39

L CH / 20MHz / 16QAM

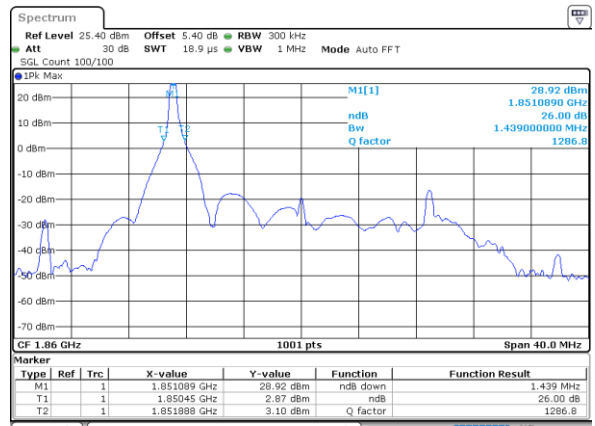

Date: 23_AUG_2023 09:56:01



LTE Band 2

H CH / 20MHz / QPSK

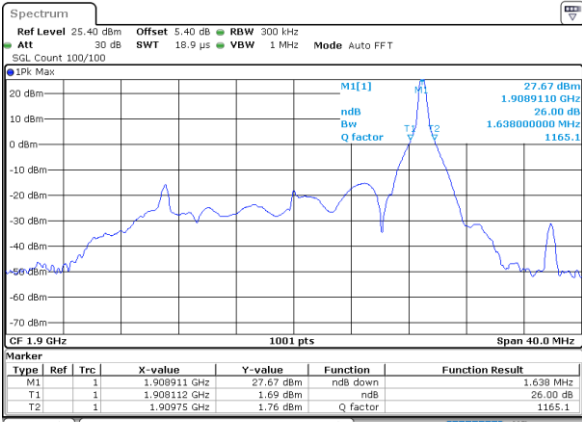

Date: 23_AUG_2023 09:56:44

H CH / 20MHz / 16QAM

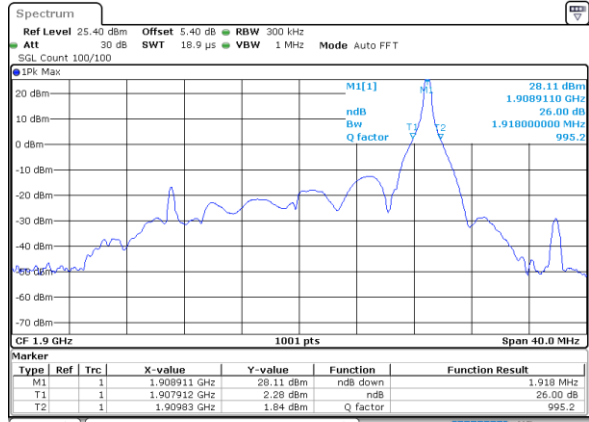

Date: 23_AUG_2023 09:59:45



Occupied Bandwidth

Mode	LTE Band 2 : 99%OBW(MHz)	
BW	1.4MHz	
Mod.	QPSK	16QAM
Middle CH	1.09	1.08
Mode	LTE Band 2 : 99%OBW(MHz)	
BW	3MHz	
Mod.	QPSK	16QAM
Middle CH	2.70	2.71
Mode	LTE Band 2 : 99%OBW(MHz)	
BW	5MHz	
Mod.	QPSK	16QAM
Middle CH	4.51	4.52
Mode	LTE Band 2 : 99%OBW(MHz)	
BW	10MHz	
Mod.	QPSK	16QAM
Middle CH	8.99	5.05
Mode	LTE Band 2 : 99%OBW(MHz)	
BW	15MHz	
Mod.	QPSK	16QAM
Middle CH	13.49	5.09
Mode	LTE Band 2 : 99%OBW(MHz)	
BW	20MHz	
Mod.	QPSK	16QAM
Middle CH	17.90	5.07



LTE Band 2

Middle Channel / 1.4MHz / QPSK

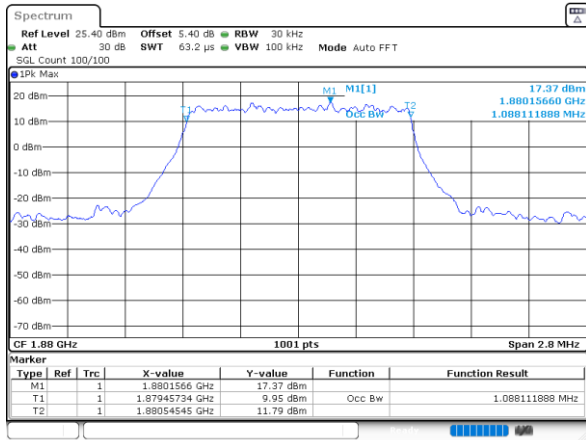

Date: 27_JUL_2023 11:57:35

Middle Channel / 1.4MHz / 16QAM

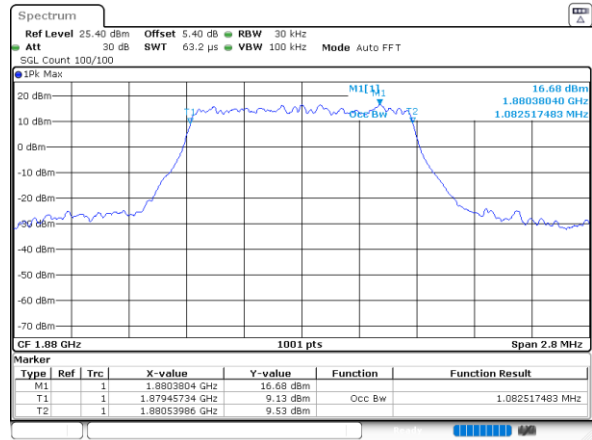

Date: 27_JUL_2023 13:09:59

LTE Band 2

Middle Channel / 3MHz / QPSK

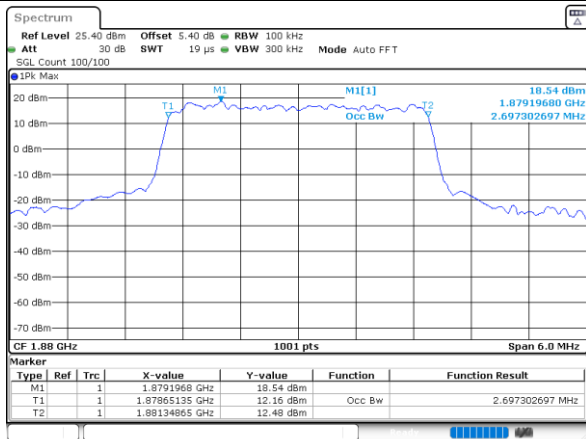

Date: 27_JUL_2023 11:56:53

Middle Channel / 3MHz / 16QAM

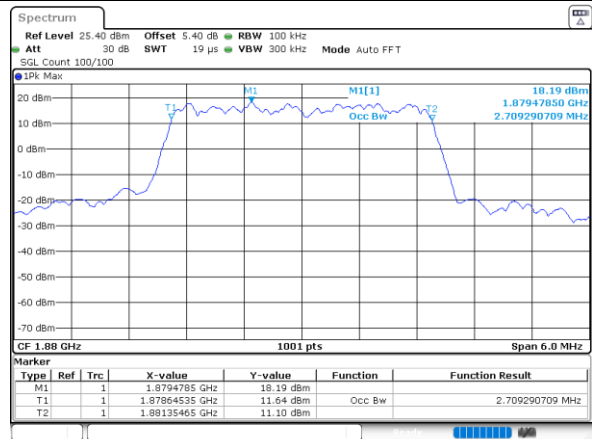

Date: 27_JUL_2023 13:09:16

LTE Band 2

Middle Channel / 5MHz / QPSK

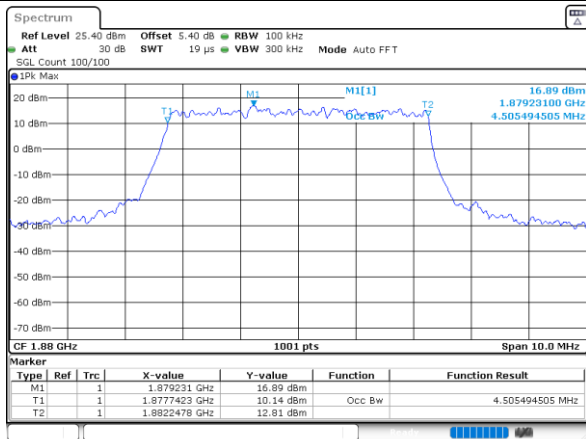

Date: 27_JUL_2023 11:56:10

Middle Channel / 5MHz / 16QAM

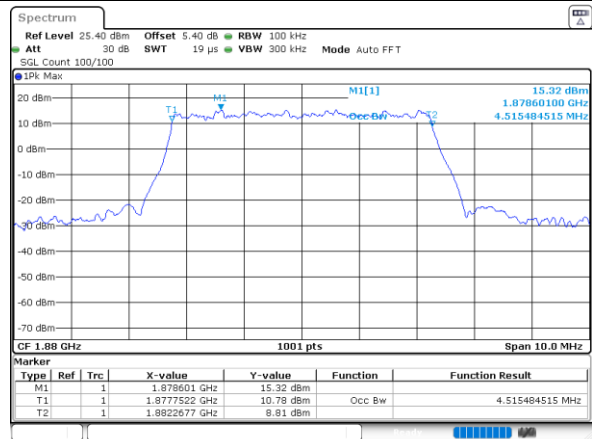

Date: 27_JUL_2023 13:08:34



LTE Band 2

Middle Channel / 10MHz / QPSK

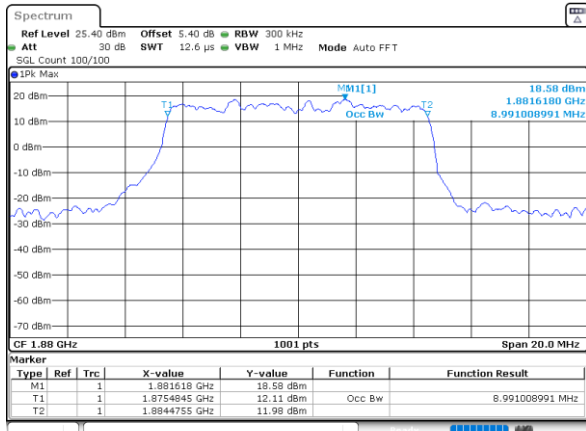

Date: 27_JUL_2023 11:55:28

Middle Channel / 10MHz / 16QAM

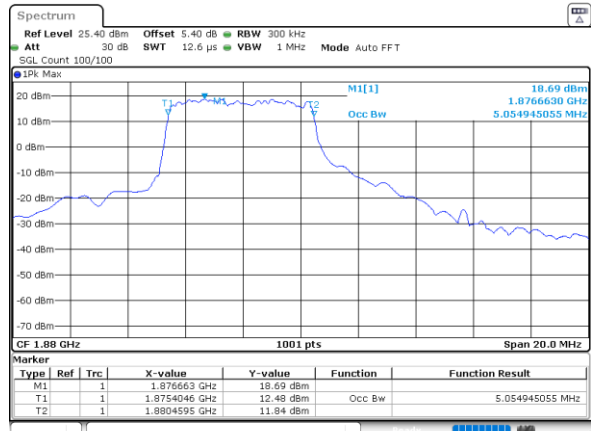

Date: 27_JUL_2023 14:02:14

LTE Band 2

Middle Channel / 15MHz / QPSK

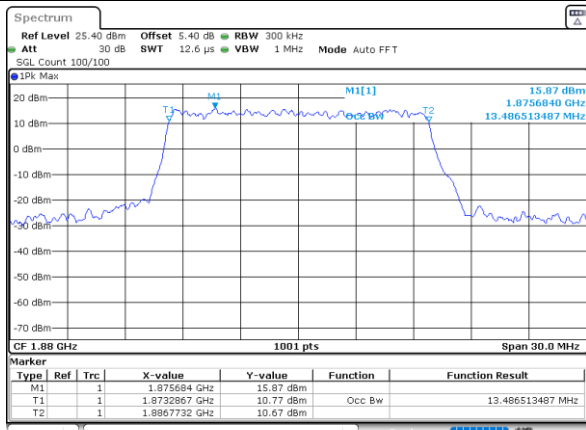

Date: 27_JUL_2023 11:54:46

Middle Channel / 15MHz / 16QAM

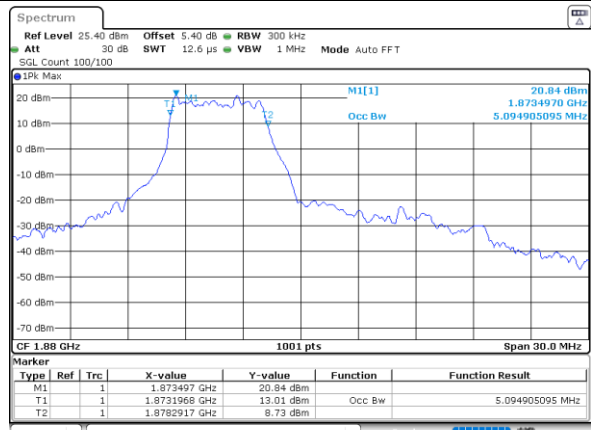

Date: 27_JUL_2023 14:13:17

LTE Band 2

Middle Channel / 20MHz / QPSK

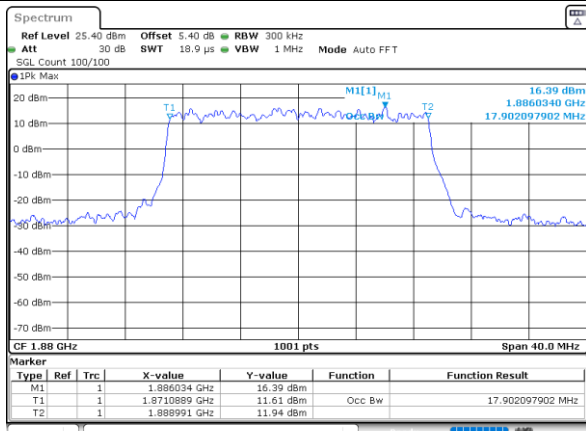

Date: 27_JUL_2023 11:54:03

Middle Channel / 20MHz / 16QAM

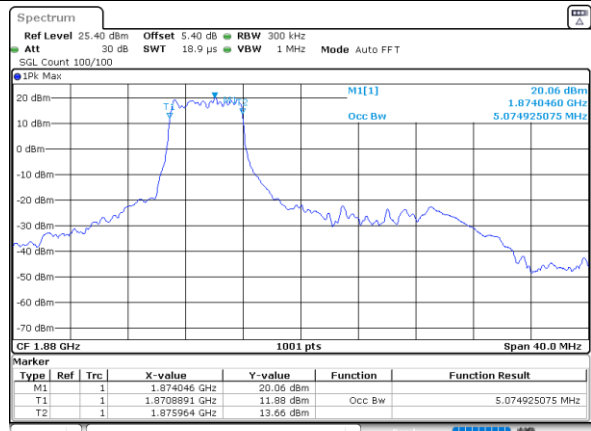

Date: 27_JUL_2023 14:18:04



Conducted Band Edge

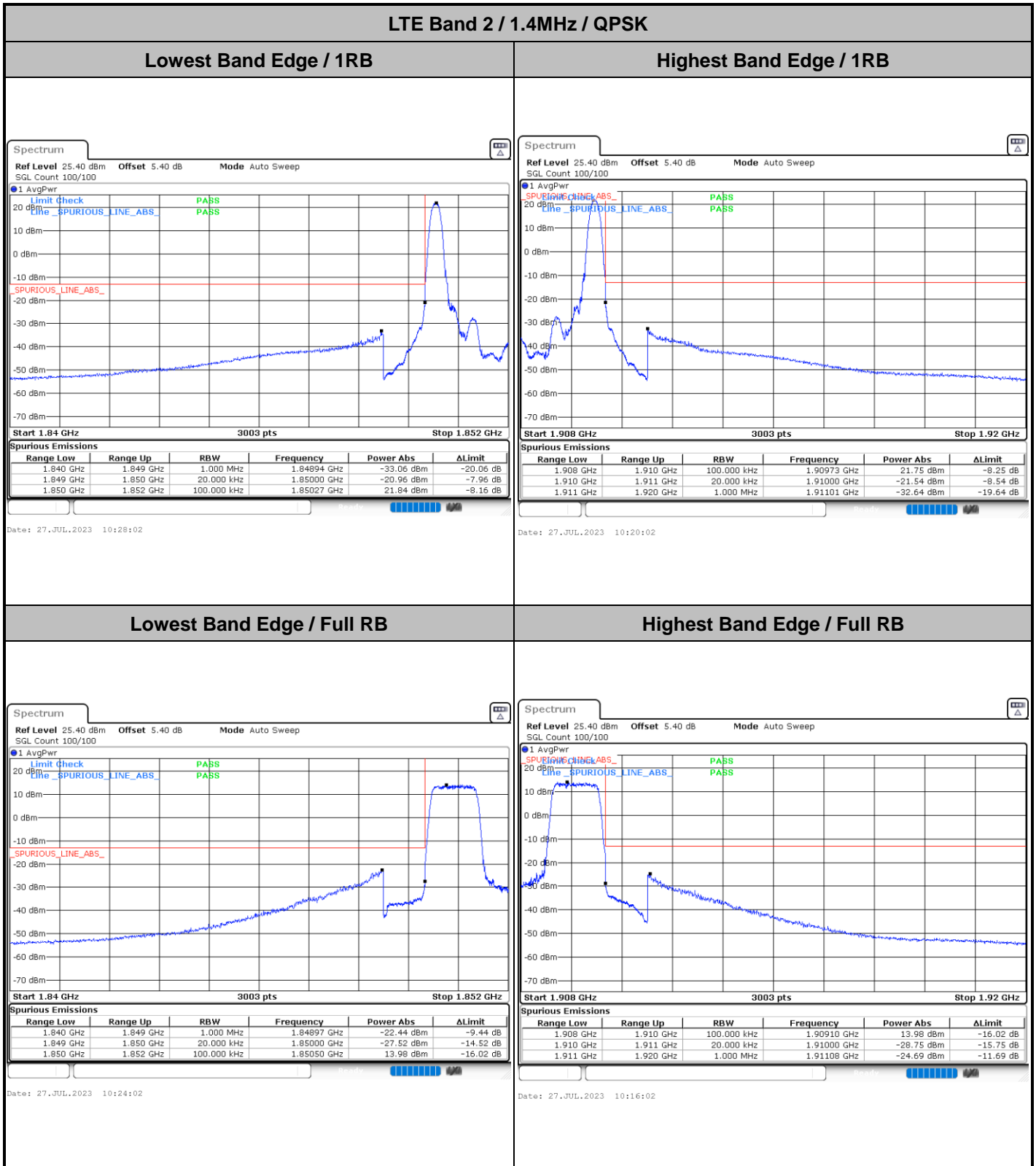



LTE Band 2 / 1.4MHz / 16QAM

Lowest Band Edge / 1 RB

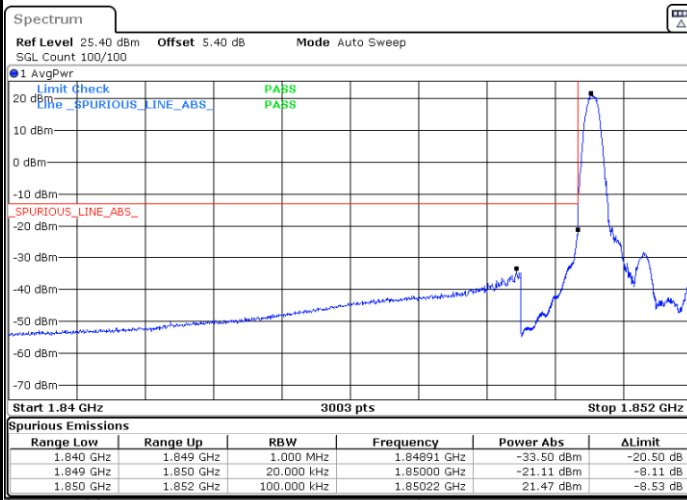

Date: 27.JUL.2023 10:26:42

Highest Band Edge / 1 RB

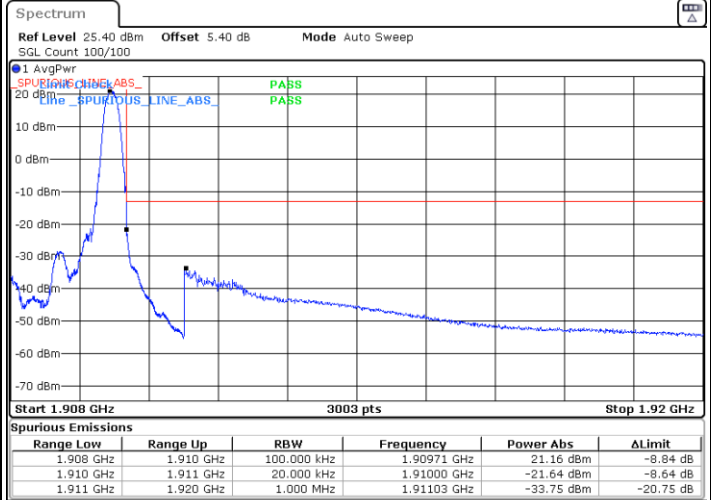

Date: 27.JUL.2023 10:18:42

Lowest Band Edge / Full RB

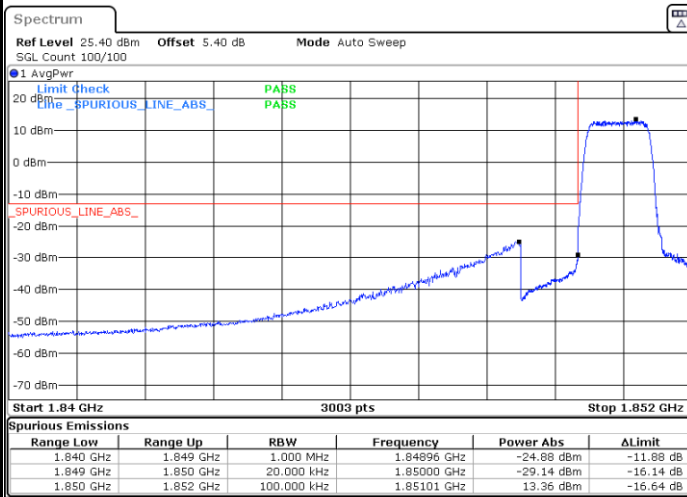

Date: 27.JUL.2023 10:25:22

Highest Band Edge / Full RB

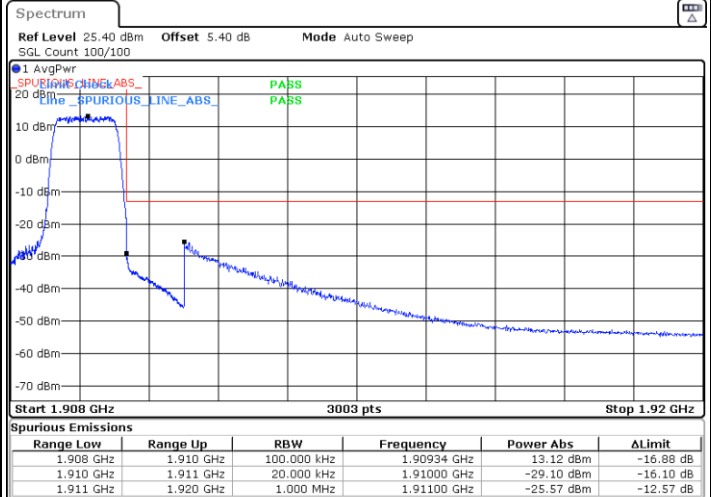

Date: 27.JUL.2023 10:17:22



LTE Band 2 / 3MHz / QPSK

Lowest Band Edge / 1RB

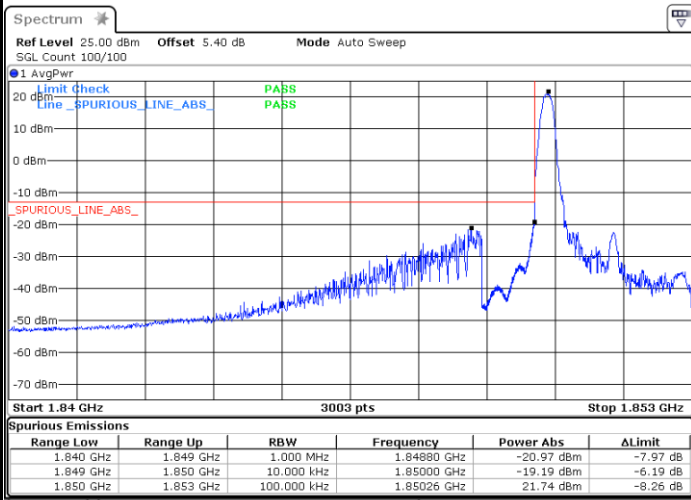

Date: 23.AUG.2023 09:41:25

Highest Band Edge / 1 RB

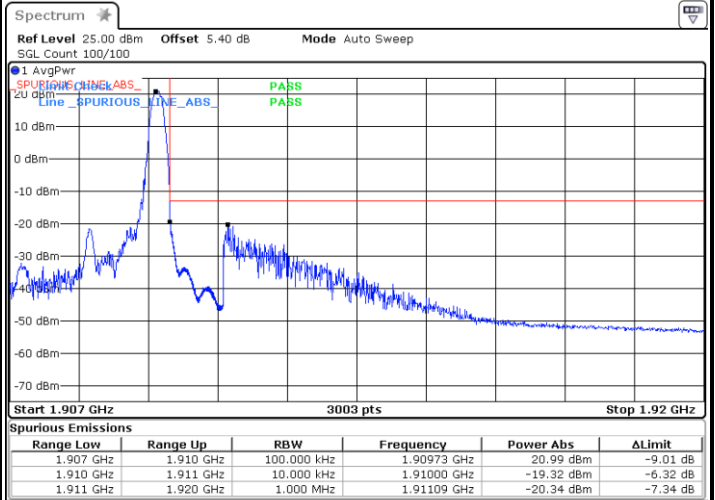

Date: 23.AUG.2023 09:44:52

Lowest Band Edge / Full RB

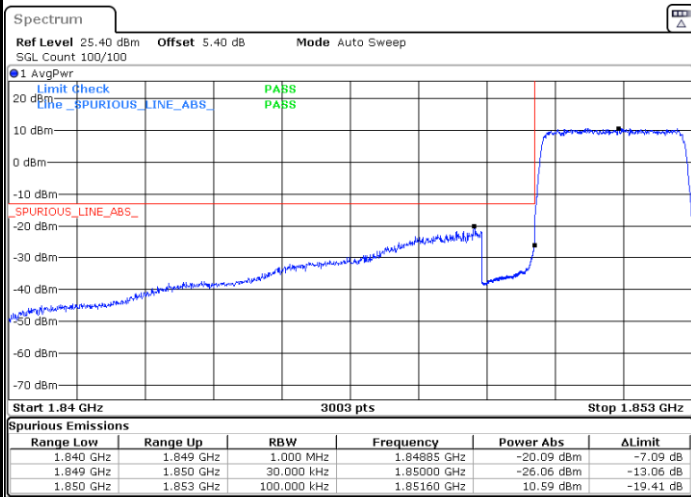

Date: 27.JUL.2023 10:46:04

Highest Band Edge / Full RB

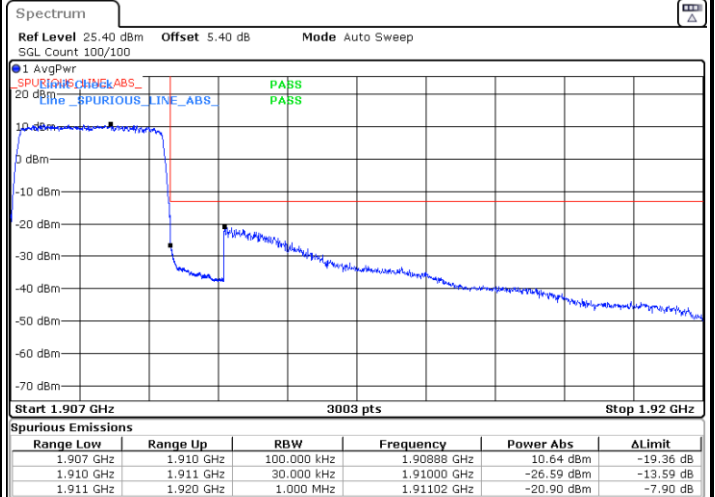

Date: 27.JUL.2023 10:53:03



LTE Band 2 / 3MHz / 16QAM

Lowest Band Edge / 1 RB

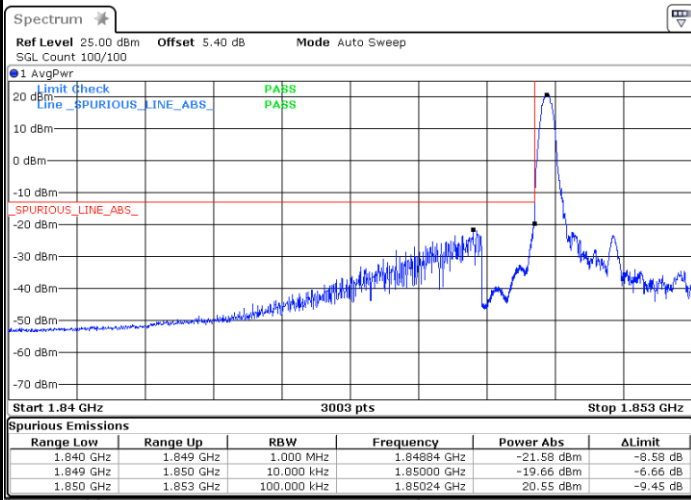

Highest Band Edge / 1 RB

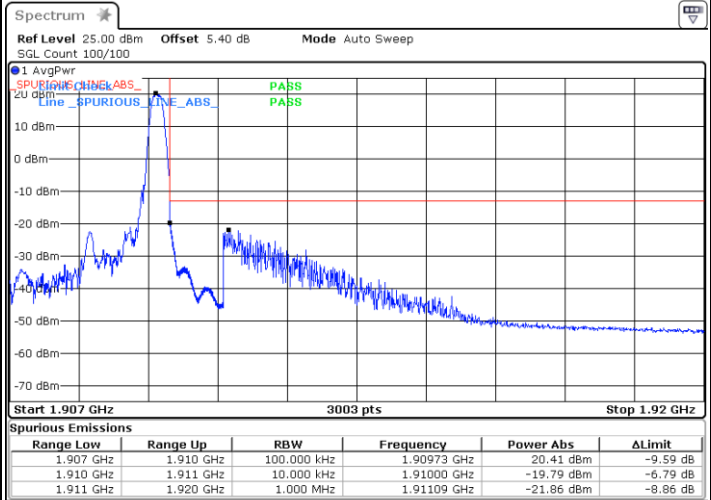

Lowest Band Edge / Full RB

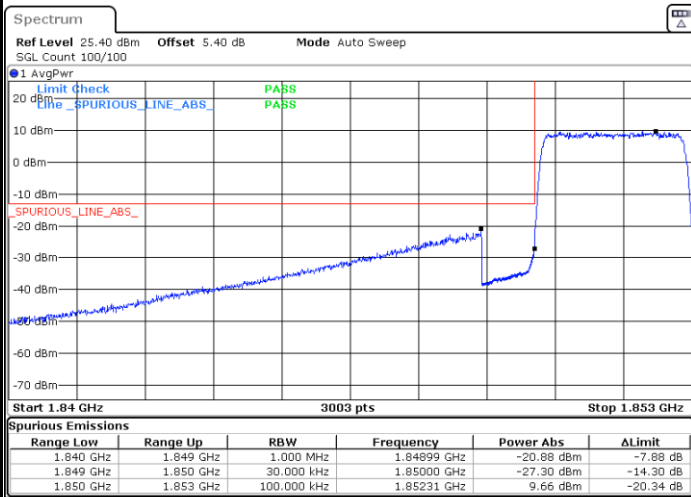

Highest Band Edge / Full RB





LTE Band 2 / 5MHz / QPSK

Lowest Band Edge / 1 RB

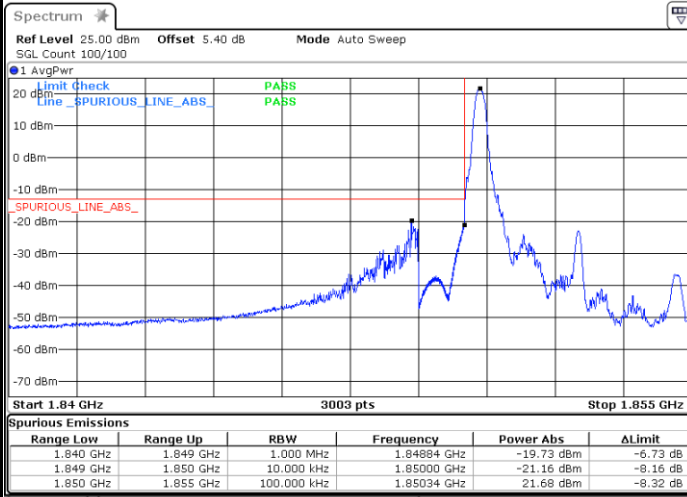

Date: 23.AUG.2023 10:01:10

Highest Band Edge / 1 RB

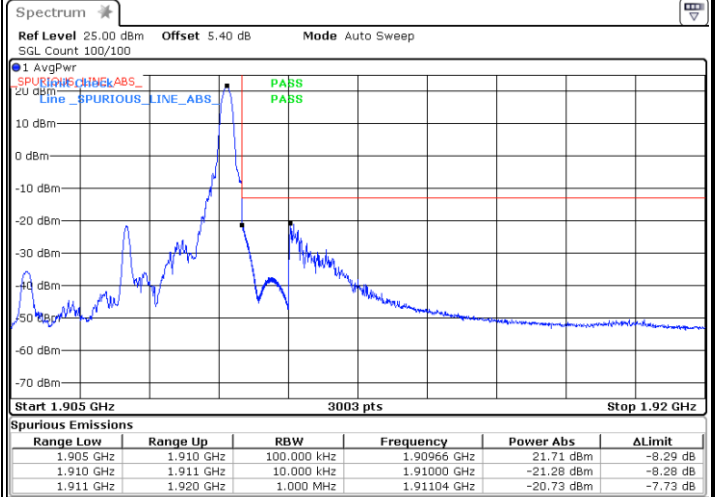

Date: 23.AUG.2023 10:03:02

Lowest Band Edge / Full RB

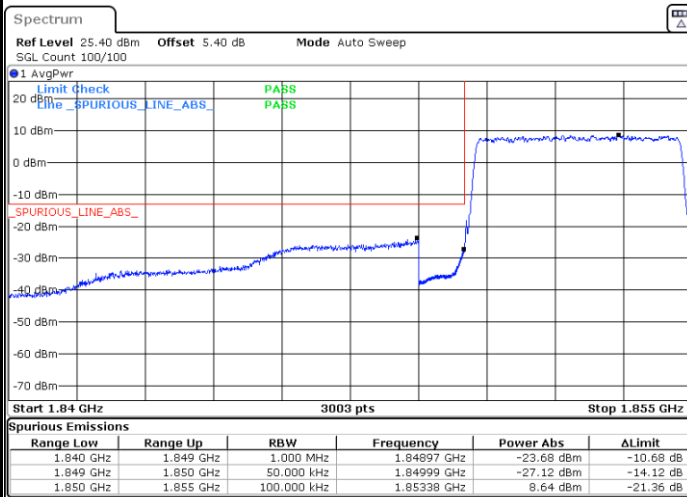

Date: 27.JUL.2023 11:14:23

Highest Band Edge / Full RB



Date: 27.JUL.2023 11:05:44



LTE Band 2 / 5MHz / 16QAM

Lowest Band Edge / 1RB

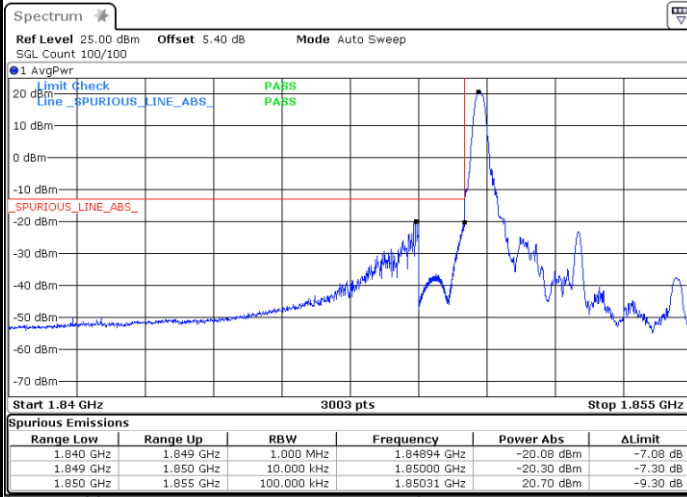

Date: 23.AUG.2023 10:02:02

Highest Band Edge / 1 RB

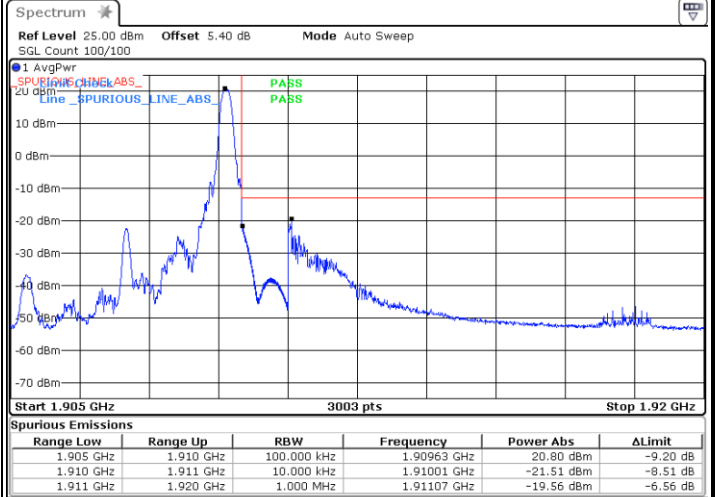

Date: 23.AUG.2023 10:03:56

Lowest Band Edge / Full RB

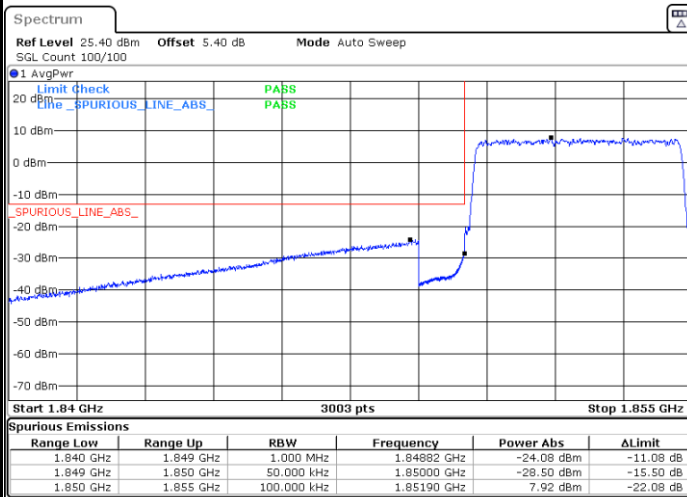

Date: 27.JUL.2023 11:13:13

Highest Band Edge / Full RB

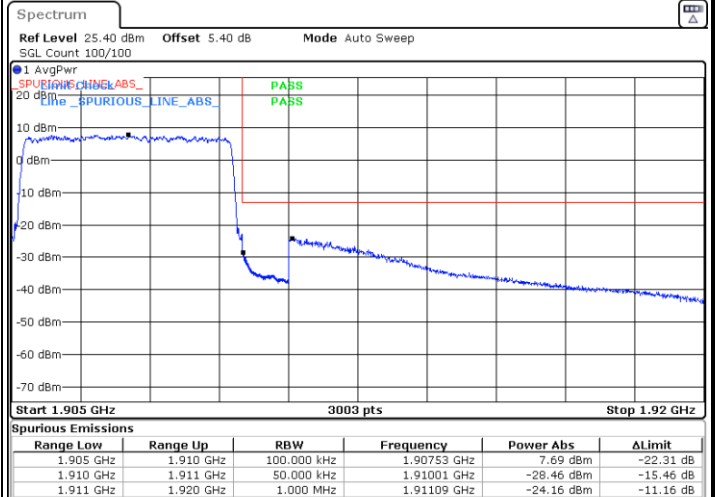

Date: 27.JUL.2023 11:04:38



LTE Band 2 / 10MHz / QPSK

Lowest Band Edge / 1 RB

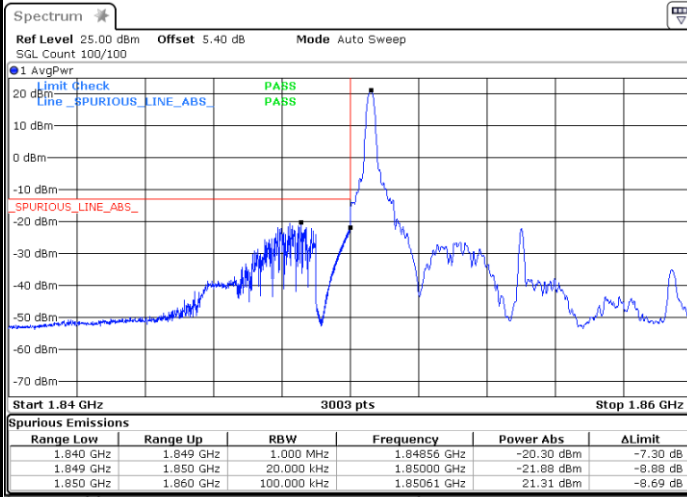

Date: 23.AUG.2023 10:06:39

Highest Band Edge / 1 RB

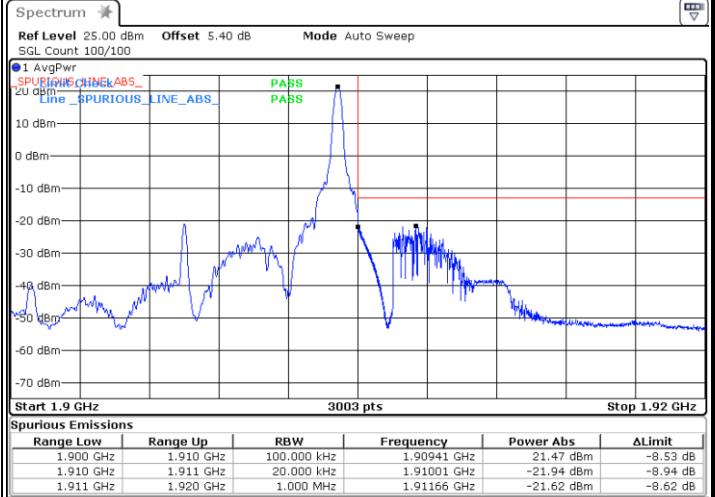

Date: 23.AUG.2023 10:08:47

Lowest Band Edge / Full RB

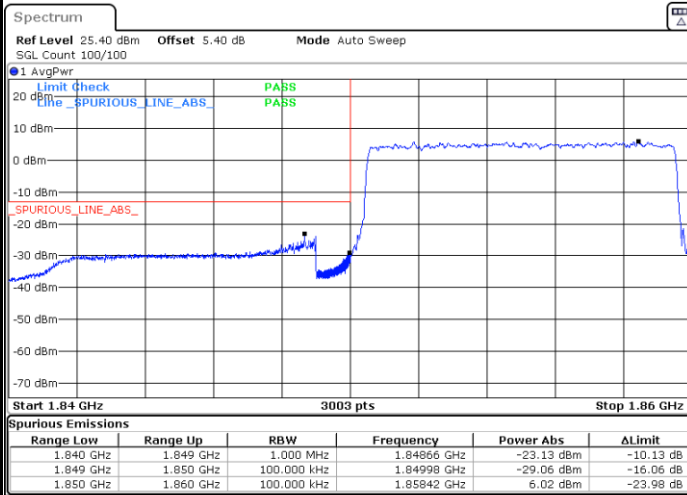

Date: 27.JUL.2023 11:31:49

Highest Band Edge / Full RB

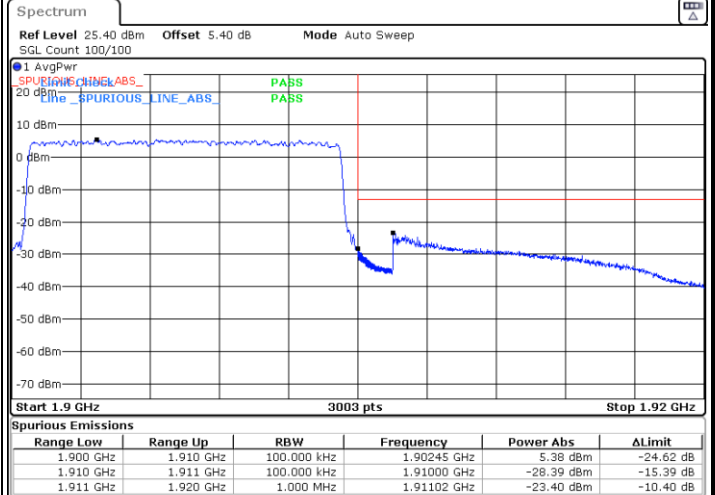

Date: 27.JUL.2023 11:36:43



LTE Band 2 / 10MHz / 16QAM

Lowest Band Edge / 1 RB

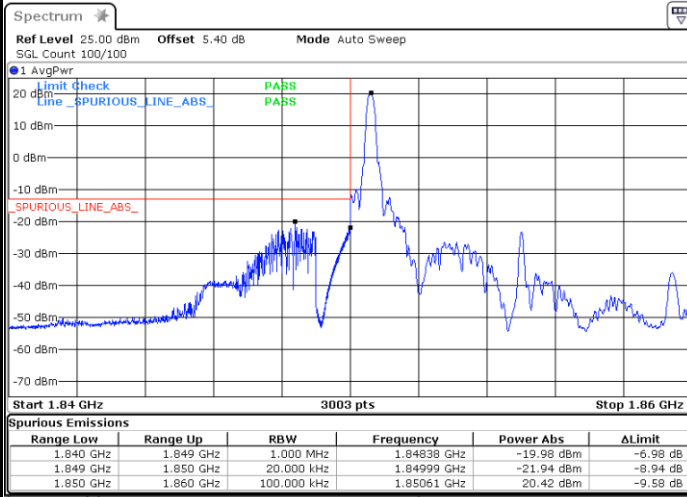

Date: 23.AUG.2023 10:07:56

Highest Band Edge / 1 RB

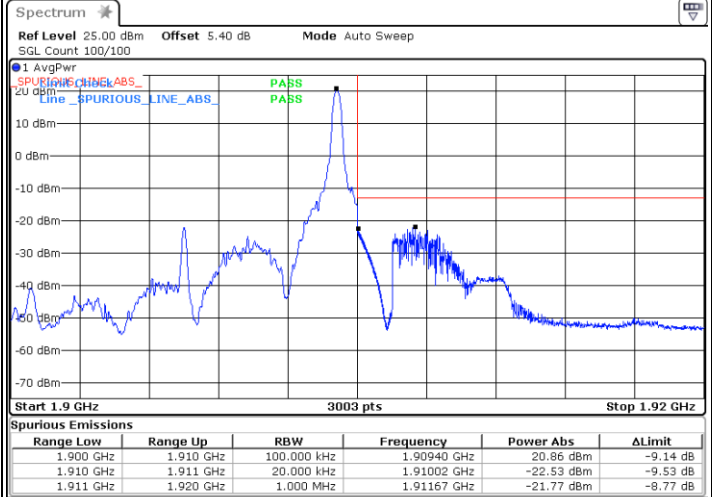

Date: 23.AUG.2023 10:09:33

Lowest Band Edge / Full RB

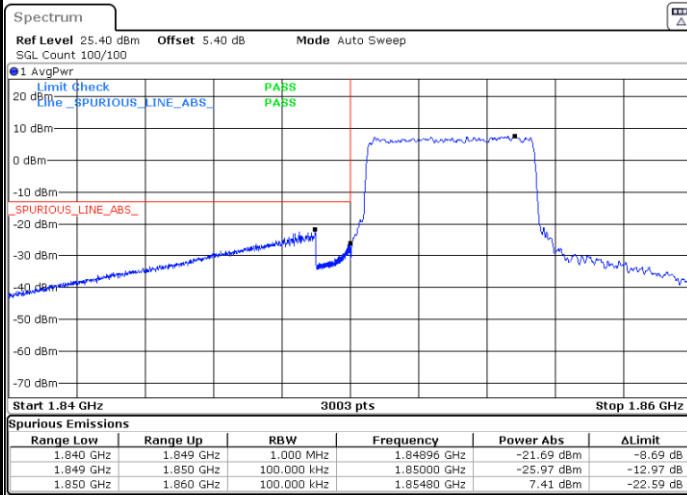

Date: 27.JUL.2023 14:08:26

Highest Band Edge / Full RB

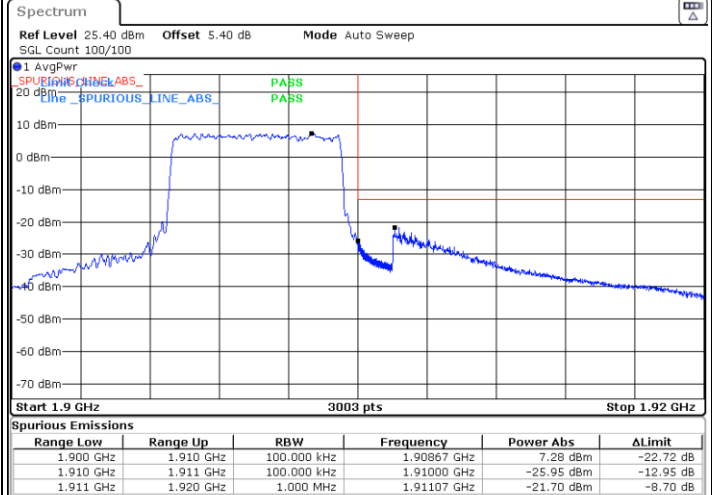

Date: 27.JUL.2023 14:09:13



LTE Band 2 / 15MHz / QPSK

Lowest Band Edge / 1 RB

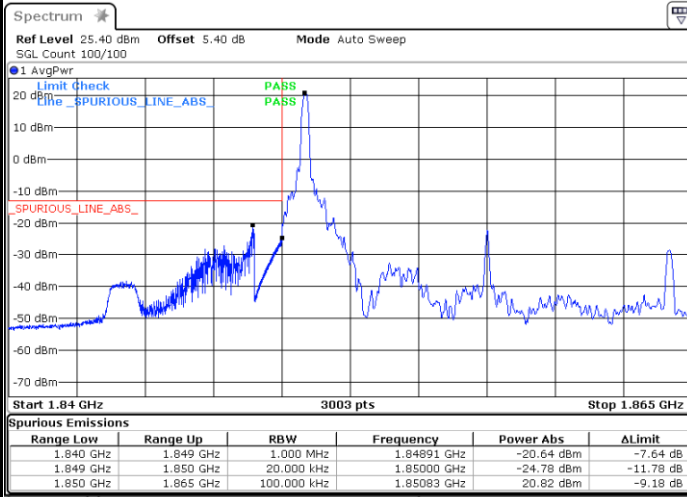

Date: 23.AUG.2023 10:14:05

Highest Band Edge / 1 RB

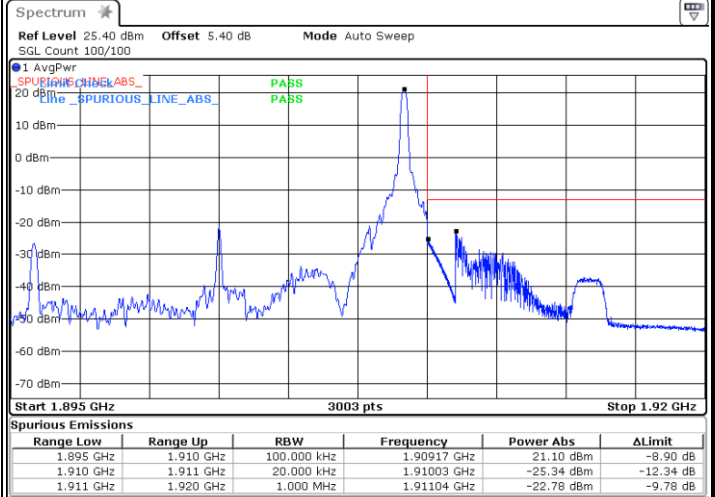

Date: 23.AUG.2023 10:17:28

Lowest Band Edge / Full RB

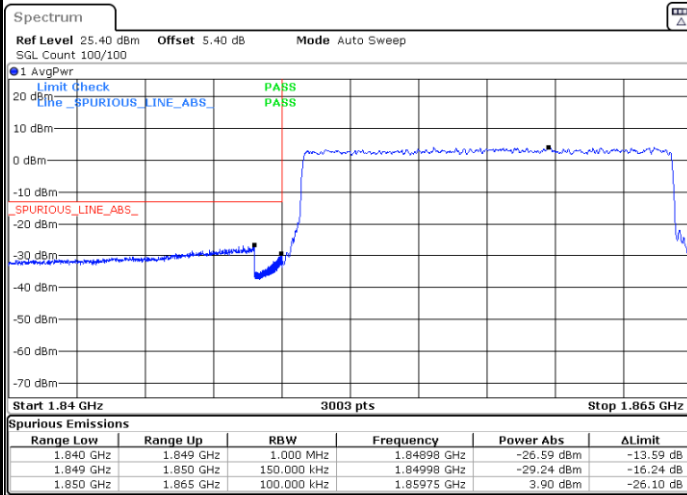

Date: 27.JUL.2023 11:40:19

Highest Band Edge / Full RB

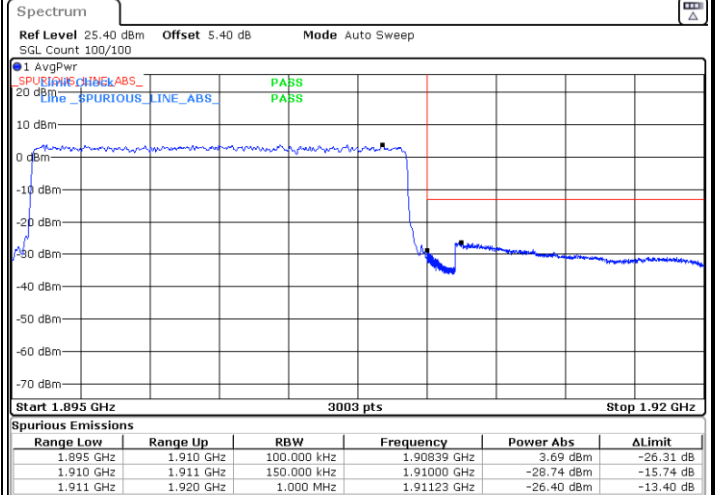

Date: 27.JUL.2023 11:45:13



LTE Band 2 / 15MHz / 16QAM

Lowest Band Edge / 1 RB

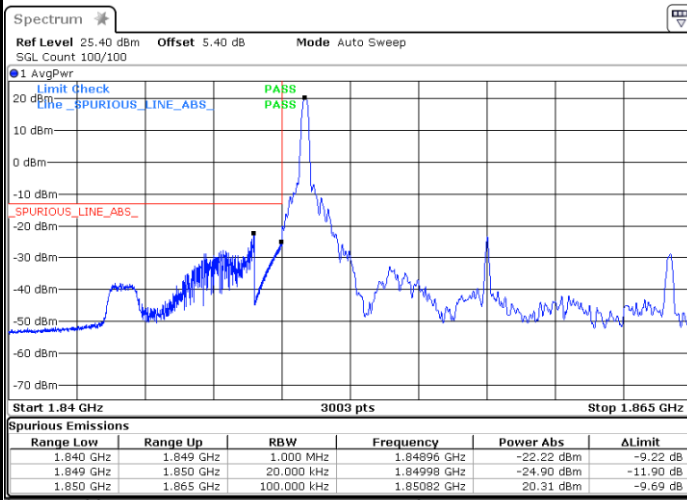

Date: 23.AUG.2023 10:14:51

Highest Band Edge / 1 RB

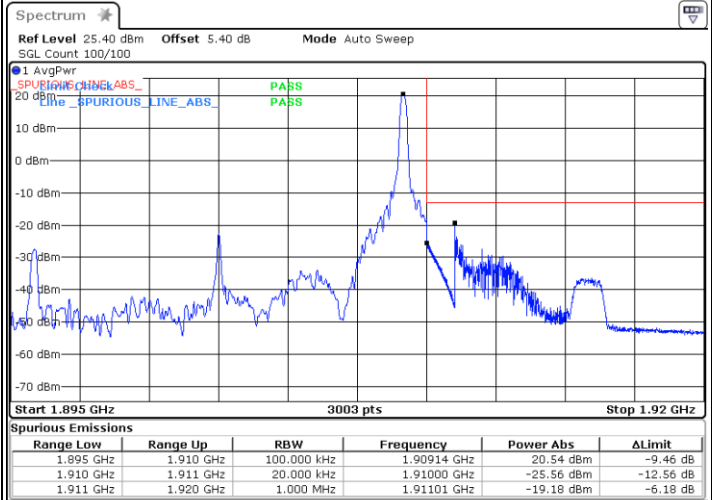

Date: 23.AUG.2023 10:16:40

Lowest Band Edge / Full RB

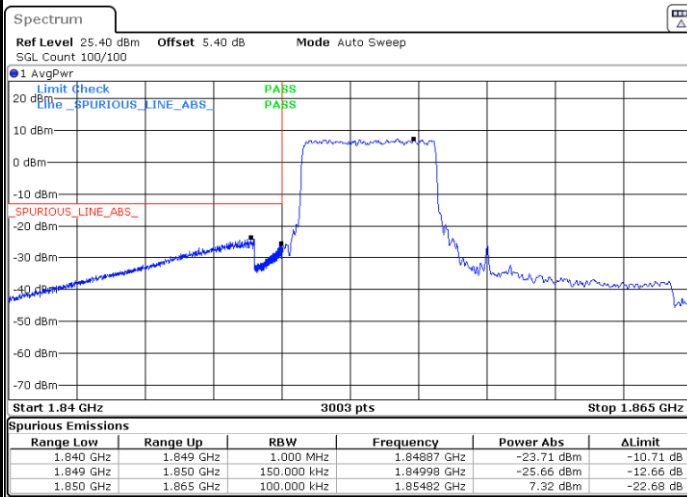

Date: 27.JUL.2023 14:15:49

Highest Band Edge / Full RB

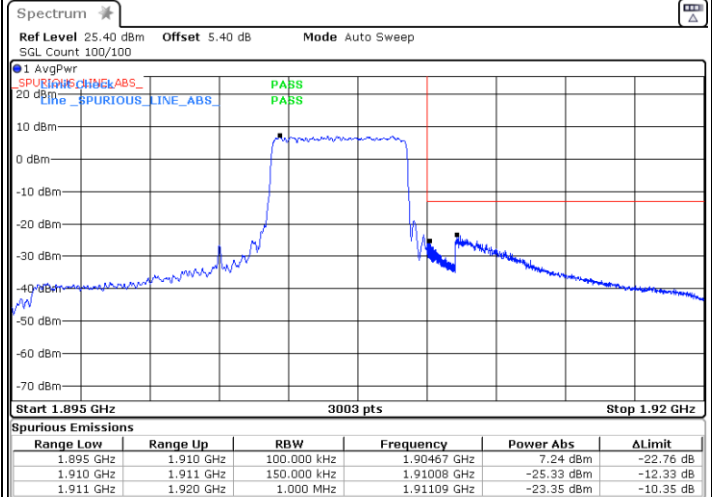

Date: 27.JUL.2023 14:17:02



LTE Band 2 / 20MHz / QPSK

Lowest Band Edge / 1 RB

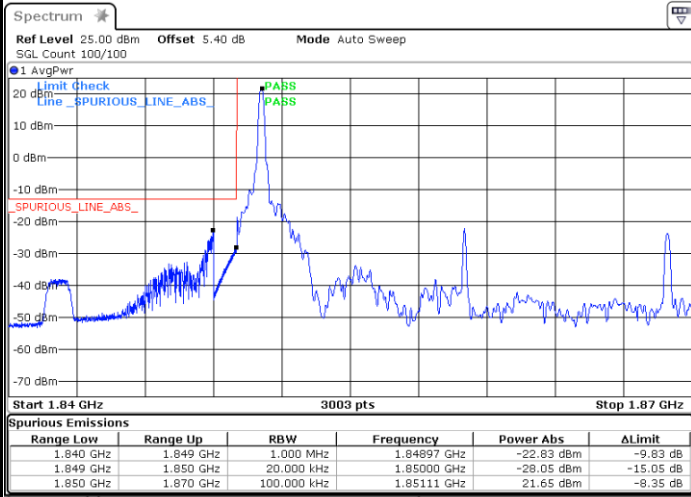

Date: 23.AUG.2023 10:19:05

Highest Band Edge / 1 RB

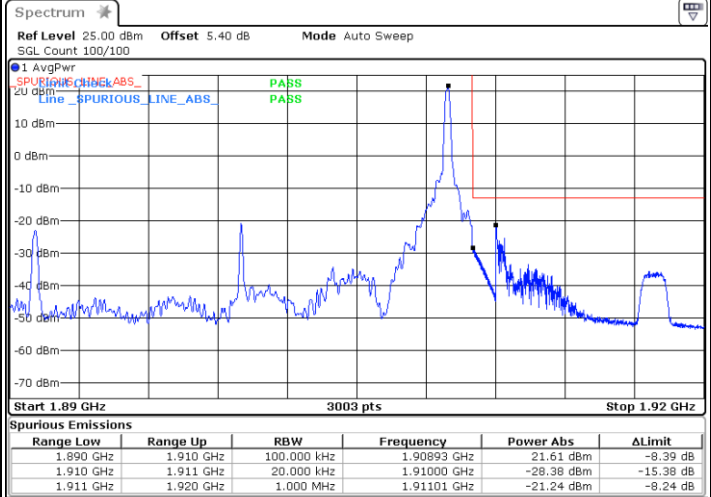

Date: 23.AUG.2023 10:22:17

Lowest Band Edge / Full RB

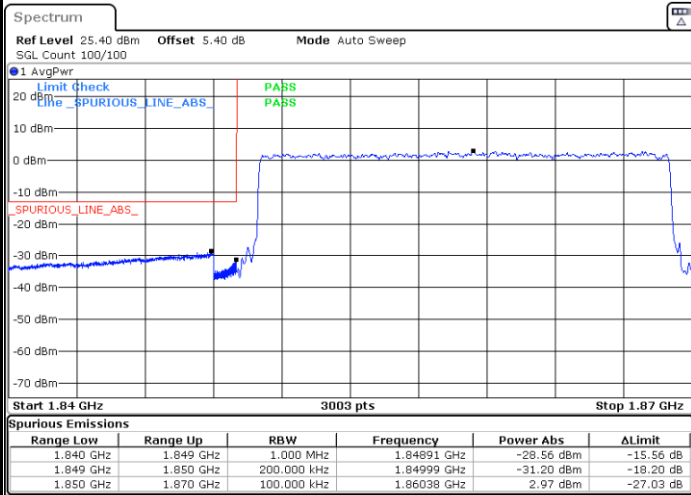

Date: 27.JUL.2023 11:48:48

Highest Band Edge / Full RB

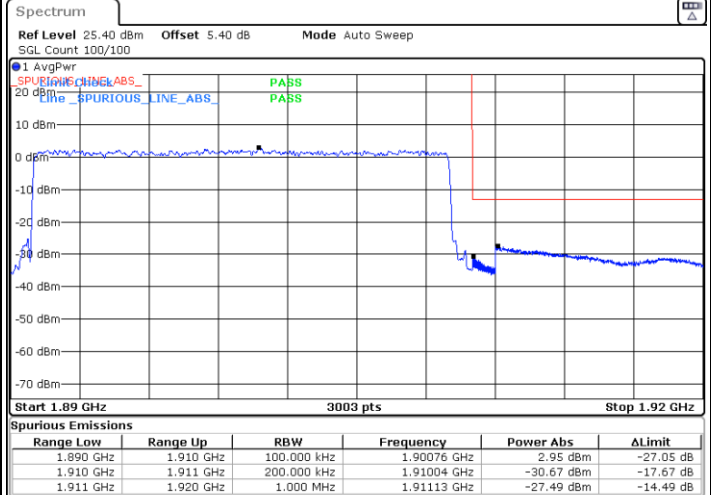

Date: 27.JUL.2023 11:53:42



LTE Band 2 / 20MHz / 16QAM

Lowest Band Edge / 1 RB

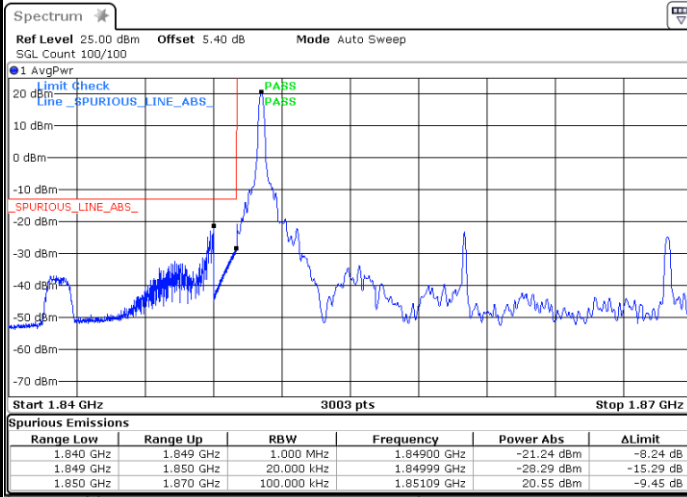

Date: 23.AUG.2023 10:20:00

Highest Band Edge / 1 RB

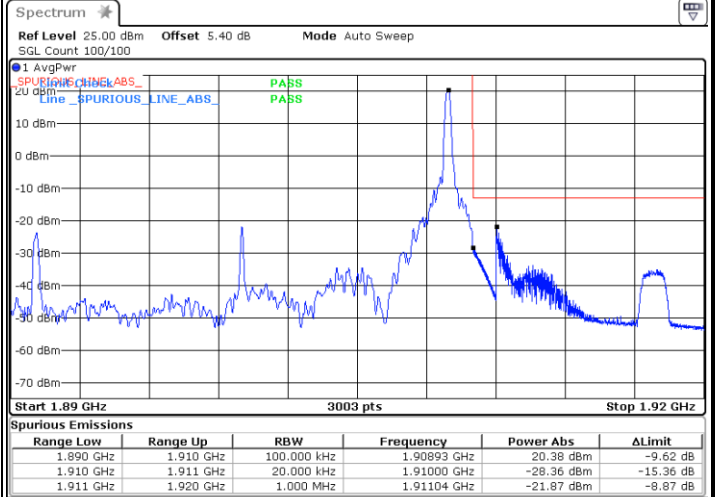

Date: 23.AUG.2023 10:21:25

Lowest Band Edge / Full RB

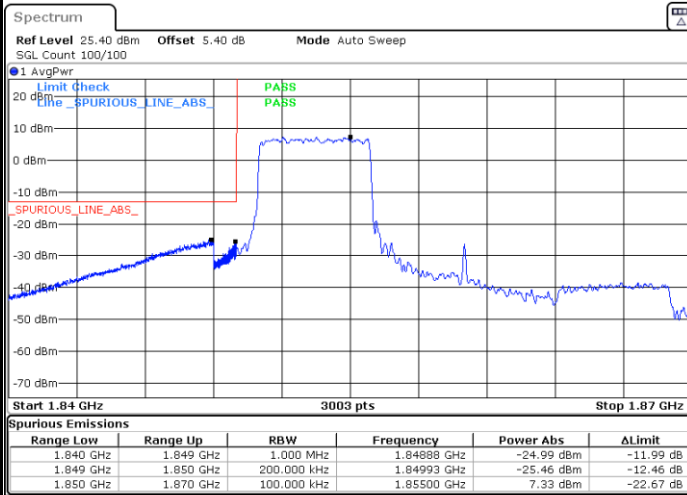

Date: 27.JUL.2023 14:19:20

Highest Band Edge / Full RB

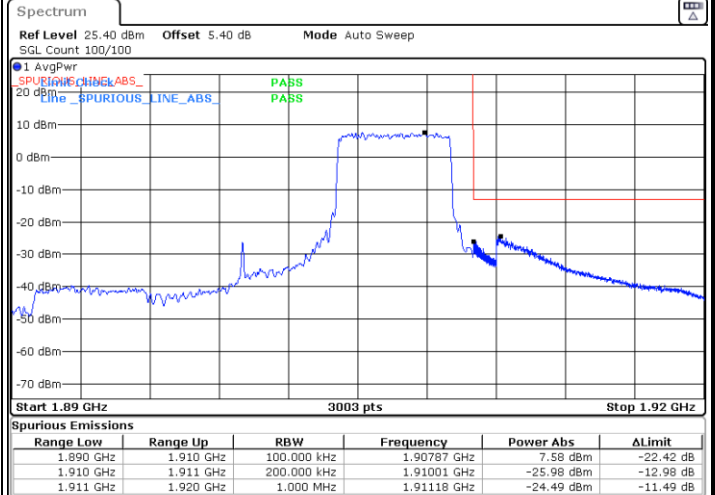

Date: 27.JUL.2023 14:22:25