

# RF TEST REPORT

**Applicant**      Quectel Wireless Solutions Co., Ltd.  
**FCC ID**            XMR2023BG953AGL  
**Product**          LTE Cat M1/NB Module  
**Brand**             Quectel  
**Model**             BG953A-GL  
**Report No.**       R2211A1103-R6  
**Issue Date**      February 1, 2023

TA Technology (Shanghai) Co., Ltd. tested the above equipment in accordance with the requirements in **FCC CFR47 Part 2 (2022)/ FCC CFR47 Part 27C (2022)**. The test results show that the equipment tested is capable of demonstrating compliance with the requirements as documented in this report.

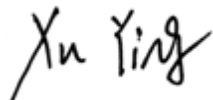

Prepared by: Xu Ying



Approved by: Xu Kai

---

## TA Technology (Shanghai) Co., Ltd.

Building 3, No.145, Jintang Rd, Pudong Shanghai, P.R.China

TEL: +86-021-50791141/2/3

FAX: +86-021-50791141/2/3-8000

## TABLE OF CONTENT

1	Test Laboratory.....	5
1.1	Notes of the Test Report.....	5
1.2	Test facility.....	5
1.3	Testing Location.....	5
2	General Description of Equipment under Test.....	6
2.1	Applicant and Manufacturer Information.....	6
2.2	General information.....	6
3	Applied Standards.....	8
4	Test Configuration.....	9
5	Test Case Results.....	11
5.1	RF Power Output and Effective Isotropic Radiated Power.....	11
5.2	Occupied Bandwidth.....	16
5.3	Band Edge Compliance.....	25
5.4	Peak-to-Average Power Ratio (PAPR).....	51
5.5	Frequency Stability.....	54
5.6	Spurious Emissions at Antenna Terminals.....	64
5.7	Radiates Spurious Emission.....	75
6	Main Test Instruments.....	84
	ANNEX A: The EUT Appearance.....	85
	ANNEX B: Test Setup Photos.....	86
	ANNEX C: Product Change Description.....	87

### Summary of Measurement Results

Number	Test Case	Clause in FCC rules	Verdict
1	RF Power Output and Effective Isotropic Radiated Power	2.1046 /27.50(d)(4) /27.50(b)(10) /27.50(c)(10)	PASS
2	Occupied Bandwidth	2.1049	PASS
3	Band Edge Compliance	27.53(h) /27.53(g) /27.53(f) /27.53(c)	PASS
4	Peak-to-Average Power Ratio	27.50(d)/KDB971168 D01(5.7)	PASS
5	Frequency Stability	2.1055 / 27.54	PASS
6	Spurious Emissions at Antenna Terminals	2.1051 /27.53(h) /27.53(g) /27.53(f) /27.53(c)	PASS
7	Radiates Spurious Emission	2.1053 /27.53(h) /27.53(g) /27.53(f) /27.53(c)	PASS
Date of Testing: July 21, 2021 ~ August 5, 2021			
Date of Sample Received: July 20, 2021			
<p>Note: PASS: The EUT complies with the essential requirements in the standard.</p> <p>FAIL: The EUT does not comply with the essential requirements in the standard.</p> <p>All indications of Pass/Fail in this report are opinions expressed by TA Technology (Shanghai) Co., Ltd. based on interpretations and/or observations of test results. Measurement Uncertainties were not taken into account and are published for informational purposes only.</p>			

BG953A-GL (Report No.: R2211A1103-R6) is a variant model of BG950A-GL (Report No.: R2107A0607-R6V1). This report only changes Product name/ Model/ SW Version/ HW Version/ Category and Extreme Temperature Information.

The differences between the two models are as follows.

Module	BG950A-GL	BG953A-GL
NB Category	Cat NB1	Cat NB2
iSIM	N/A	Supported

There is only verified output power and Radiated Spurious Emissions (LTE eMTC Band 13, 5MHz, Middle Channel) for variant in this report,

Radiated Spurious Emissions did not worsen, so they were not recorded in the report.

Power of new variant is varied due to measurement uncertainty, and sample tolerance of the acceptance range.

The detailed product change description please refers to the *Difference Declaration Letter*.

# 1 Test Laboratory

## 1.1 Notes of the Test Report

This report shall not be reproduced in full or partial, without the written approval of **TA technology (shanghai) co., Ltd.** The results documented in this report apply only to the tested sample, under the conditions and modes of operation as described herein .Measurement Uncertainties were not taken into account and are published for informational purposes only. This report is written to support regulatory compliance of the applicable standards stated above.

## 1.2. Test facility

### **FCC (Designation number: CN1179, Test Firm Registration Number: 446626)**

TA Technology (Shanghai) Co., Ltd. has been listed on the US Federal Communications Commission list of test facilities recognized to perform measurements.

### **A2LA (Certificate Number: 3857.01)**

TA Technology (Shanghai) Co., Ltd. has been listed by American Association for Laboratory Accreditation to perform measurement.

## 1.3 Testing Location

Company:	TA Technology (Shanghai) Co., Ltd.
Address:	Building 3, No.145, Jintang Rd, Pudong Shanghai, P.R.China
City:	Shanghai
Post code:	201201
Country:	P. R. China
Contact:	Xu Kai
Telephone:	+86-021-50791141/2/3
Fax:	+86-021-50791141/2/3-8000
Website:	<a href="http://www.ta-shanghai.com">http://www.ta-shanghai.com</a>
E-mail:	xukai@ta-shanghai.com

## 2 General Description of Equipment under Test

### 2.1 Applicant and Manufacturer Information

Applicant	Quectel Wireless Solutions Co., Ltd.
Applicant address	Building 5, Shanghai Business Park Phase III (Area B), No.1016 Tianlin Road, Minhang District, Shanghai, China, 200233
Manufacturer	Quectel Wireless Solutions Co., Ltd.
Manufacturer address	Building 5, Shanghai Business Park Phase III (Area B), No.1016 Tianlin Road, Minhang District, Shanghai, China, 200233

### 2.2 General information

EUT Description				
Model	BG953A-GL			
IMEI	869410050002659			
Hardware Version	R1.5			
Software Version	BG953AGLAAR02A01			
Power Supply	External power supply			
Antenna Type	External Antenna			
Antenna Gain	Mode	Frequency (MHz)	Gain (dBi)	
	LTE eMTC Band 4	1700	1.67	
		1720	1.94	
		1740	2.00	
		1760	1.57	
	LTE eMTC Band 12	700	1.66	
		710	3.26	
		720	3.95	
	LTE eMTC Band 13	770	3.98	
		780	4.45	
		790	3.63	
	LTE eMTC Band 66	1700	1.67	
		1720	1.94	
		1740	2.00	
		1760	1.57	
		1780	0.97	
	Test Mode(s)	LTE eMTC Band 4/12/13/66;		
	Test Modulation	QPSK 16QAM;		
	LTE Category	M1		
	Maximum E.I.R.P./ E.R.P.	LTE eMTC Band 4:	25.99dBm	

	LTE eMTC Band 12:	25.08dBm	
	LTE eMTC Band 13:	26.08dBm	
	LTE eMTC Band 66:	25.86dBm	
Rated Power Supply Voltage	3.3V		
Operating Voltage	Minimum: 2.2V    Maximum: 4.35V		
Operating Temperature	Lowest: -35°C    Highest: +75°C		
Extreme Temperature	Lowest: -40°C    Highest: +85°C		
Frequency Range(s)	Mode	Tx (MHz)	Rx (MHz)
	LTE eMTC Band 4	1710 ~ 1755	2110 ~ 2155
	LTE eMTC Band 12	699 ~ 716	729 ~ 746
	LTE eMTC Band 13	777 ~ 787	746 ~ 756
	LTE eMTC Band 66	1710 ~ 1780	2110 ~ 2180
<p>Note: 1. The EUT is sent from the applicant to TA and the information of the EUT is declared by the applicant.</p>			

### 3 Applied Standards

According to the specifications of the manufacturer, it must comply with the requirements of the following standards:

**Test standards:**

**FCC CFR 47 Part 22H (2022)**

**FCC CFR47 Part 2 (2022)**

**Reference standard:**

**ANSI C63.26-2015**

**KDB 971168 D01 Power Meas License Digital Systems v03r01**



## 4 Test Configuration

Radiated measurements are performed by rotating the EUT in three different orthogonal test planes. EUT stand-up position (Z axis), lie-down position (X, Y axis). Receiver antenna polarization (horizontal and vertical), the worst emission was found in position (X, Y axis, vertical polarization) and the worst case was recorded.

All mode and data rates and positions and RB size and modulations were investigated.

Subsequently, only the worst case emissions are reported.

The following testing in LTE eMTC is set based on the maximum RF Output Power.

The following testing in different Bandwidth is set to detail in the following table:

Test modes are chosen to be reported as the worst case configuration below:

Test modes are chosen to be reported as the worst case configuration below for LTE eMTC Band 4/12/13/66:

Test items	Modes	Bandwidth (MHz)						Modulation		RB			Test Channel			
		1.4	3	5	10	15	20	QPSK	16QAM	1	50%	100%	L	M	H	
RF Power Output and Effective Isotropic Radiated Power	LTE eMTC 4	○	○	○	○	○	○	○	○	○	○	○	○	○	○	○
	LTE eMTC 12	○	○	○	○	-	-	○	○	○	○	○	○	○	○	○
	LTE eMTC 13	-	-	○	○	-	-	○	○	○	○	○	○	○	○	○
	LTE eMTC 66	○	○	○	○	○	○	○	○	○	○	○	○	○	○	○
Occupied Bandwidth	LTE eMTC 4	○	○	○	○	○	○	○	○	-	-	○	○	○	○	○
	LTE eMTC 12	○	○	○	○	-	-	○	○	-	-	○	○	○	○	○
	LTE eMTC 13	-	-	○	○	-	-	○	○	-	-	○	○	○	○	○
	LTE eMTC 66	○	○	○	○	○	○	○	○	-	-	○	○	○	○	○
Band Edge Compliance	LTE eMTC 4	○	○	○	○	○	○	○	○	○	-	○	○	-	○	○
	LTE eMTC 12	○	○	○	○	-	-	○	○	○	-	○	○	-	○	○
	LTE eMTC 13	-	-	○	○	-	-	○	○	○	-	○	○	-	○	○
	LTE eMTC 66	○	○	○	○	○	○	○	○	○	-	○	○	-	○	○
Peak-to-Aver	LTE	○	○	○	○	○	○	○	○	-	-	○	○	○	○	○

age Power Ratio	eMTC 4														
	LTE eMTC 12	○	○	○	○	-	-	○	○	-	-	○	○	○	○
	LTE eMTC 13	-	-	○	○	-	-	○	○	-	-	○	○	○	○
	LTE eMTC 66	○	○	○	○	○	○	○	○	-	-	○	○	○	○
Frequency Stability	LTE eMTC 4	○	○	○	○	○	○	○	○	○	-	-	-	○	-
	LTE eMTC 12	○	○	○	○	-	-	○	○	○	-	-	-	○	-
	LTE eMTC 13	-	-	○	○	-	-	○	○	○	-	-	-	○	-
	LTE eMTC 66	○	○	○	○	○	○	○	○	○	-	-	-	○	-
Spurious Emissions at Antenna Terminals	LTE eMTC 4	○	○	○	○	○	○	○	-	○	-	-	○	○	○
	LTE eMTC 12	○	○	○	○	-	-	○	-	○	-	-	○	○	○
	LTE eMTC 13	-	-	○	○	-	-	○	-	○	-	-	○	○	○
	LTE eMTC 66	○	○	○	○	○	○	○	-	○	-	-	○	○	○
Radiates Spurious Emission	LTE eMTC 4	○	-	○	-	-	○	○	-	○	-	-	-	○	-
	LTE eMTC 12	○	-	○	○	-	-	○	-	○	-	-	-	○	-
	LTE eMTC 13	-	-	○	○	-	-	○	-	○	-	-	-	○	-
	LTE eMTC 66	○	-	○	-	-	○	○	-	○	-	-	-	○	-
Note	1. The mark "○" means that this configuration is chosen for testing. 2. The mark "-" means that this configuration is not testing.														

## 5 Test Case Results

### 5.1 RF Power Output and Effective Isotropic Radiated Power

#### Ambient condition

Temperature	Relative humidity	Pressure
23°C ~25°C	45%~50%	101.5kPa

#### Methods of Measurement

During the process of the testing, The EUT was connected to the Base Station Simulator with a known loss. The EUT is controlled by the Base Station Simulator test set to ensure max power transmission with proper modulation.

ERP can then be calculated as follows:

$$\text{EIRP (dBm)} = \text{Output Power (dBm)} - \text{Losses (dB)} + \text{Antenna Gain (dBi)}$$

where:dBd refers to gain relative to an ideal dipole.

$$\text{EIRP (dBm)} = \text{ERP (dBm)} + 2.15 \text{ (dB.)}$$

#### Test Setup

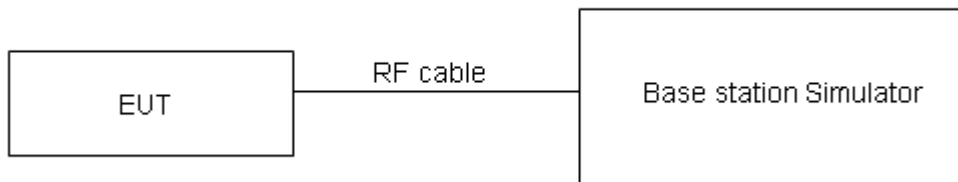

#### Limits

No specific RF power output requirements in part 2.1046.

Rule Part 27.50(b) (10) specifies that “Portable stations (hand-held devices) transmitting in the 746-757 MHz, 776-788 MHz, and 805-806 MHz bands are limited to 3 watts ERP”

Rule Part 27.50(c) (10) specifies that “Portable stations (hand-held devices) in the 600 MHz uplink band and the 698-746 MHz band, and fixed and mobile stations in the 600 MHz uplink band are limited to 3 watts ERP”

Rule Part 27.50(d) (4) specifies that “Fixed, mobile and portable (hand-held) stations operating in the 1710–1755 MHz band are limited to 1 watt EIRP”

Rule Part 27.50(h) (2) specifies that “Mobile and other user stations. Mobile stations are limited to 2.0 watts EIRP. All user stations are limited to 2.0 watts transmitter output power.”

Rule Part 27.50(a) (3) specifies that “(i) For mobile and portable stations transmitting in the

2305-2315 MHz band or the 2350-2360 MHz band, the average EIRP must not exceed 50 milliwatts within any 1 megahertz of authorized bandwidth, except that for mobile and portable stations compliant with 3GPP LTE standards or another advanced mobile broadband protocol that avoids concentrating energy at the edge of the operating band the average EIRP must not exceed 250 milliwatts within any 5 megahertz of authorized bandwidth but may exceed 50 milliwatts within any 1 megahertz of authorized bandwidth. ”

Part 27.50(b)(10)Limit	$\leq 3 \text{ W}$ (34.77 dBm)
Part 27.50(c)(10)Limit	$\leq 3 \text{ W}$ (34.77 dBm)
Part 27.50(d)(4)Limit	$\leq 1 \text{ W}$ (30 dBm)

### Measurement Uncertainty

The assessed measurement uncertainty to ensure 95% confidence level for the normal distribution is with the coverage factor  $k = 2$ ,  $U=0.4 \text{ dB}$  for RF power output,  $k = 2$ ,  $U= 1.19 \text{ dB}$  for ERP/EIRP.

**Test Results**

LTE eMTC Band 4	Channel/ Frequency(MHz)	Index	RB#		Maximum Output Power(dBm)		EIRP (dBm)	
			RBstart		QPSK	16QAM	QPSK	16QAM
			QPSK	16QAM				
1.4MHz	19957/1710.7	0	1#0	1#0	23.70	22.58	25.64	24.52
		0	6#0	5#0	22.31	21.80	24.25	23.74
	20175/1732.5	0	1#0	1#0	23.67	22.47	25.67	24.47
		0	6#0	5#0	23.31	21.81	25.31	23.81
	20393/1754.3	0	1#5	1#5	23.76	22.70	25.33	24.27
		0	6#0	5#0	23.50	21.97	25.07	23.54
3MHz	19965/1711.5	0	1#0	1#0	23.82	22.85	25.76	24.79
		0	6#0	5#0	21.84	21.51	23.78	23.45
	20175/1732.5	0	1#0	1#0	23.82	22.78	25.82	24.78
		0	6#0	5#0	22.14	21.81	24.14	23.81
	20385/1753.5	1	1#5	1#5	23.68	23.02	25.62	24.96
		0	6#0	5#0	22.22	21.96	24.16	23.90
5MHz	19975/1712.5	3	1#0	1#0	23.80	23.81	25.74	25.75
		0	6#0	5#0	23.22	21.71	25.16	23.65
	20175/1732.5	0	1#0	1#0	23.86	23.85	25.86	25.85
		0	6#0	5#0	23.23	21.79	25.23	23.79
	20375/1752.5	0	1#5	1#5	23.52	23.94	25.46	25.88
		0	6#0	5#0	23.36	21.85	25.30	23.79
10MHz	20000/1715	3	1#0	1#0	23.78	23.80	25.72	25.74
		0	4#0	4#0	23.96	22.78	25.90	24.72
	20175/1732.5	0	1#0	1#0	23.83	23.85	25.83	25.85
		0	4#0	4#0	22.95	22.89	24.95	24.89
	20350/1750	4	1#5	1#5	23.59	23.94	25.53	25.88
		7	4#2	4#2	23.81	22.06	25.75	24.00
15MHz	20025/1717.5	3	1#0	1#0	23.78	23.84	25.72	25.78
		0	6#0	5#0	23.61	23.74	25.55	25.68
	20175/1732.5	0	1#0	1#0	23.78	23.75	25.78	25.75
		0	6#0	5#0	23.69	23.70	25.69	25.70
	20325/1747.5	8	1#5	1#5	23.52	23.99	25.52	25.99
		11	6#0	5#0	23.81	23.89	25.81	25.89
20MHz	20050/1720	3	1#0	1#0	23.76	23.78	25.70	25.72
		0	6#0	5#0	23.62	23.64	25.56	25.58
	20175/1732.5	0	1#0	1#0	23.77	23.82	25.77	25.82
		0	6#0	5#0	23.65	23.72	25.65	25.72
	20300/1745	12	1#5	1#5	23.58	23.95	25.58	25.95
		15	6#0	5#0	23.75	23.90	25.75	25.90

LTE eMTC Band12	Channel/ Frequency(MHz)	Index	RB#		Maximum Output Power(dBm)		ERP (dBm)	
			RBstart		QPSK	16QAM	QPSK	16QAM
			QPSK	16QAM				
1.4MHz	23017/699.7	0	1#0	1#0	23.78	22.77	23.29	22.28
		0	6#0	5#0	22.43	22.02	21.94	21.53
	23095/707.5	0	1#0	1#0	23.43	22.40	24.54	23.51
		0	6#0	5#0	22.02	21.57	23.13	22.68
	23173/715.3	0	1#5	1#5	23.19	22.00	24.99	23.80
		0	6#0	5#0	21.64	21.16	23.44	22.96
3MHz	23025/700.5	0	1#0	1#0	23.93	23.12	23.44	22.63
		0	6#0	5#0	22.28	22.01	21.79	21.52
	23095/707.5	0	1#0	1#0	23.57	22.72	24.68	23.83
		0	6#0	5#0	21.86	21.58	22.97	22.69
	23165/714.5	1	1#5	1#5	22.35	22.36	23.46	23.47
		0	6#0	5#0	21.56	21.29	22.67	22.40
5MHz	23035/701.5	3	1#0	1#0	23.77	23.84	23.28	23.35
		0	6#0	5#0	23.25	22.03	22.76	21.54
	23095/707.5	0	1#0	1#0	23.62	23.68	24.73	24.79
		0	6#0	5#0	22.93	21.74	24.04	22.85
	23155/713.5	0	1#5	1#5	23.44	23.40	24.55	24.51
		0	6#0	5#0	22.65	21.44	23.76	22.55
10MHz	23060/704	3	1#0	1#0	23.76	23.82	23.27	23.33
		0	4#0	4#0	23.04	23.05	22.55	22.56
	23095/707.5	0	1#0	1#0	23.67	23.80	24.78	24.91
		0	4#0	4#0	23.97	22.89	25.08	24.00
	23130/711	4	1#5	1#5	23.44	23.42	24.55	24.53
		7	4#2	4#2	22.99	21.36	24.10	22.47
LTE eMTC Band13	Channel/ Frequency(MHz)	Index	RB#		Maximum Output Power(dBm)		ERP (dBm)	
5MHz	23205/779.5	3	1#0	1#0	23.55	23.60	25.85	25.90
		0	6#0	5#0	22.37	21.51	24.67	23.81
	23230/782	0	1#0	1#0	23.54	23.62	25.84	25.92
		0	6#0	5#0	22.82	21.73	25.12	24.03
	23255/784.5	0	1#5	1#5	23.72	23.61	26.02	25.91
		0	6#0	5#0	22.91	21.67	25.21	23.97
10MHz	23230/782	0	1#0	1#0	23.53	23.51	25.83	25.81
		0	4#0	4#0	23.78	22.62	26.08	24.92
LTE eMTC Band66	Channel/ Frequency(MHz)	Index	RB#		Maximum Output Power(dBm)		EIRP (dBm)	
1.4MHz	131979/1710.7	0	1#0	1#0	23.48	22.31	25.42	24.25
		0	6#0	5#0	23.22	21.70	25.16	23.64

	132322/1745	0	1#0	1#0	23.60	22.44	25.60	24.44
		0	6#0	5#0	22.35	21.81	24.35	23.81
	132665/1779.3	0	1#5	1#5	23.21	22.81	24.18	23.78
		0	6#0	5#0	22.62	22.09	23.59	23.06
3MHz	131987/1711.5	0	1#0	1#0	23.69	22.68	25.63	24.62
		0	6#0	5#0	21.99	21.72	23.93	23.66
	132322/1745	0	1#0	1#0	23.78	22.74	25.78	24.74
		0	6#0	5#0	22.08	21.81	24.08	23.81
	132657/1778.5	1	1#5	1#5	23.02	23.04	23.99	24.01
		0	6#0	5#0	23.25	22.13	24.22	23.10
5MHz	131997/1712.5	3	1#0	1#0	23.68	23.65	25.62	25.59
		0	6#0	5#0	23.05	21.70	24.99	23.64
	132322/1745	0	1#0	1#0	23.79	23.72	25.79	25.72
		0	6#0	5#0	23.17	21.76	25.17	23.76
	132647/1777.5	0	1#5	1#5	22.82	23.90	23.79	24.87
		0	6#0	5#0	23.41	22.03	24.38	23.00
10MHz	132022/1715	3	1#0	1#0	23.65	23.64	25.59	25.58
		0	4#0	4#0	23.85	22.65	25.79	24.59
	132322/1745	0	1#0	1#0	23.71	23.72	25.71	25.72
		0	4#0	4#0	23.77	22.73	25.77	24.73
	132622/1775	4	1#5	1#5	22.93	23.24	23.90	24.21
		7	4#2	4#2	23.93	22.10	24.90	23.07
15MHz	132047/1717.5	3	1#0	1#0	23.66	23.65	25.60	25.59
		0	6#0	5#0	23.65	23.60	25.59	25.54
	132322/1745	0	1#0	1#0	23.70	23.69	25.70	25.69
		0	6#0	5#0	23.74	23.67	25.74	25.67
	132597/1772.5	8	1#5	1#5	22.88	23.97	23.85	24.94
		11	6#0	5#0	23.10	23.99	24.07	24.96
20MHz	132072/1720	3	1#0	1#0	23.92	23.64	25.86	25.58
		0	6#0	5#0	23.65	23.59	25.59	25.53
	132322/1745	0	1#0	1#0	23.68	23.69	25.68	25.69
		0	6#0	5#0	23.68	23.61	25.68	25.61
	132572/1770	12	1#5	1#5	23.12	23.94	24.09	24.91
		15	6#0	5#0	23.04	23.99	24.01	24.96

## 5.2 Occupied Bandwidth

### Ambient condition

Temperature	Relative humidity	Pressure
23°C ~25°C	45%~50%	101.5kPa

### Method of Measurement

The EUT was connected to Spectrum Analyzer and Base Station Simulator via power Splitter. The occupied bandwidth is measured using spectrum analyzer.

RBW is set to 51kHz, VBW is set to 160kHz for LTE eMTC Band 4/12/13/66

99% power and -26dBc occupied bandwidths are recorded. Spectrum analyzer plots are included on the following pages.

### Test Setup

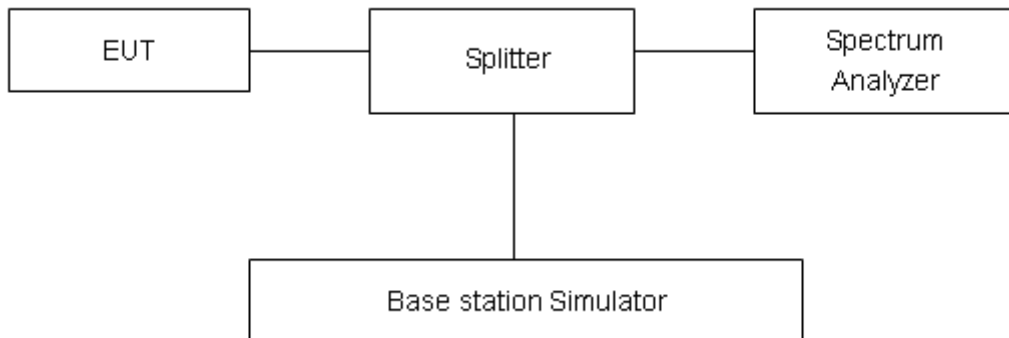

### Limits

No specific occupied bandwidth requirements in part 2.1049.

### Measurement Uncertainty

The assessed measurement uncertainty to ensure 95% confidence level for the normal distribution is with the coverage factor  $k = 2$ ,  $U=624\text{Hz}$ .



**Test Result**

Mode	Bandwidth	Modulation	Channel/ Frequency(MHz)	Bandwidth(MHz)		
				99% Power	-26dBc	
LTE eMTC Band4	1.4MHz	QPSK	20175/1732.5	1.105	1.341	
		16QAM	20175/1732.5	0.976	1.342	
	3MHz	QPSK	20175/1732.5	1.110	1.346	
		16QAM	20175/1732.5	0.961	1.309	
	5MHz	QPSK	20175/1732.5	1.100	1.316	
		16QAM	20175/1732.5	0.975	1.317	
	10MHz	QPSK	20175/1732.5	1.108	1.333	
		16QAM	20175/1732.5	0.999	1.333	
	15MHz	QPSK	20175/1732.5	1.120	1.344	
		16QAM	20175/1732.5	1.001	1.353	
20MHz	QPSK	20175/1732.5	1.113	1.352		
	16QAM	20175/1732.5	1.004	1.354		
Mode	Bandwidth	Modulation	Channel/ Frequency(MHz)	Bandwidth(MHz)		
LTE eMTC Band12	1.4MHz	QPSK	23095/707.5	0.973	1.327	
		16QAM	23095/707.5	0.966	1.302	
	3MHz	QPSK	23095/707.5	1.109	1.343	
		16QAM	23095/707.5	0.965	1.308	
	5MHz	QPSK	23095/707.5	1.099	1.332	
		16QAM	23095/707.5	0.977	1.314	
	10MHz	QPSK	23095/707.5	1.100	1.332	
		16QAM	23095/707.5	0.994	1.322	
	Mode	Bandwidth	Modulation	Channel/ Frequency(MHz)	Bandwidth(MHz)	
	LTE eMTC Band13	5MHz	QPSK	23230/782	1.103	1.331
16QAM			23230/782	0.976	1.312	
10MHz		QPSK	23230/782	1.107	1.334	
		16QAM	23230/782	0.993	1.322	
Mode	Bandwidth	Modulation	Channel/ Frequency(MHz)	Bandwidth(MHz)		
LTE eMTC Band66	1.4MHz	QPSK	132322/1745	1.099	1.321	
		16QAM	132322/1745	0.952	1.294	
	3MHz	QPSK	132322/1745	1.108	1.335	
		16QAM	132322/1745	0.958	1.299	
	5MHz	QPSK	132322/1745	1.101	1.323	
		16QAM	132322/1745	0.995	1.448	
	10MHz	QPSK	132322/1745	1.107	1.340	
		16QAM	132322/1745	0.994	1.317	
	15MHz	QPSK	132322/1745	1.120	1.360	
		16QAM	132322/1745	0.991	1.317	

	20MHz	QPSK	132322/1745	1.117	1.353
		16QAM	132322/1745	0.997	1.346

LTE eMTC Band 4 QPSK 1.4MHz CH-Middle



LTE eMTC Band 4 QPSK 3MHz CH-Middle



LTE eMTC Band 4 QPSK 5MHz CH-Middle



LTE eMTC Band 4 QPSK 10MHz CH-Middle



LTE eMTC Band 4 QPSK 15MHz CH-Middle



LTE eMTC Band 4 QPSK 20MHz CH-Middle



RF Test Report

Report No.: R2211A1103-R6

LTE eMTC Band 4 16QAM 1.4MHz CH-Middle



LTE eMTC Band 4 16QAM 3MHz CH-Middle



LTE eMTC Band 4 16QAM 5MHz CH-Middle



LTE eMTC Band 4 16QAM 10MHz CH-Middle



LTE eMTC Band 4 16QAM 15MHz CH-Middle



LTE eMTC Band 4 16QAM 20MHz CH-Middle



RF Test Report

Report No.: R2211A1103-R6

LTE eMTC Band 12 QPSK 1.4MHz CH-Middle



LTE eMTC Band 12 QPSK 3MHz CH-Middle



LTE eMTC Band 12 QPSK 5MHz CH-Middle



LTE eMTC Band 12 QPSK 10MHz CH-Middle



LTE eMTC Band 12 16QAM 1.4MHz CH-Middle



LTE eMTC Band 12 16QAM 3MHz CH-Middle



LTE eMTC Band 12 16QAM 5MHz CH-Middle



LTE eMTC Band 12 16QAM 10MHz CH-Middle



LTE eMTC Band 13 QPSK 5MHz CH-Middle



LTE eMTC Band 13 QPSK 10MHz CH-Middle



LTE eMTC Band 13 16QAM 5MHz CH-Middle



LTE eMTC Band 13 16QAM 10MHz CH-Middle



LTE eMTC Band 66 QPSK 1.4MHz CH-Middle



LTE eMTC Band 66 QPSK 3MHz CH-Middle



LTE eMTC Band 66 QPSK 5MHz CH-Middle



LTE eMTC Band 66 QPSK 10MHz CH-Middle



LTE eMTC Band 66 QPSK 15MHz CH-Middle



LTE eMTC Band 66 QPSK 20MHz CH-Middle



LTE eMTC Band 66 16QAM 1.4MHz CH-Middle



LTE eMTC Band 66 16QAM 3MHz CH-Middle



LTE eMTC Band 66 16QAM 5MHz CH-Middle



LTE eMTC Band 66 16QAM 10MHz CH-Middle



LTE eMTC Band 66 16QAM 15MHz CH-Middle



LTE eMTC Band 66 16QAM 20MHz CH-Middle

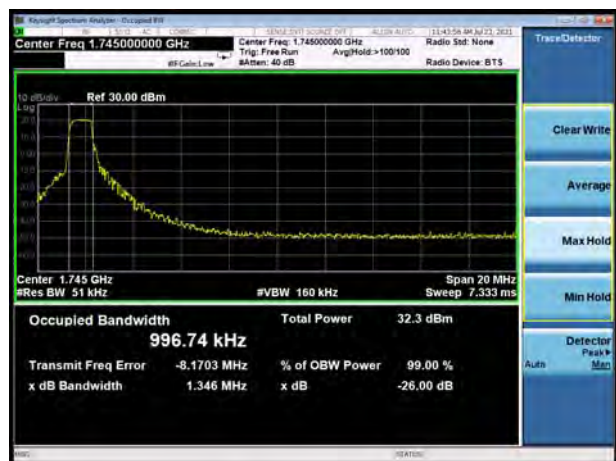



### 5.3 Band Edge Compliance

#### Ambient condition

Temperature	Relative humidity	Pressure
23°C ~25°C	45%~50%	101.5kPa

#### Method of Measurement

The EUT was connected to Spectrum Analyzer and Base Station Simulator via power Splitter. The band edge of the lowest and highest channels were measured.

The testing follows KDB 971168 D01 v03r01 Section 6.0

The EUT was connected to spectrum analyzer and system simulator via a power divider.

The band edges of low and high channels for the highest RF powers were measured.

RBW is set to 51 kHz, VBW is set to 160 kHz for LTE eMTC Band 4/12/13/66 on spectrum analyzer.

Set spectrum analyzer with RMS detector.

The RF fundamental frequency should be excluded against the limit line in the operating frequency band.

Checked that all the results comply with the emission limit line.

#### Test Setup

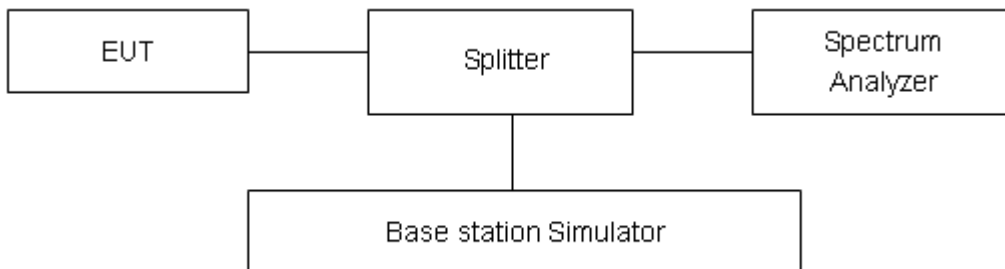

#### Limits

Rule Part 27.53(i) By a factor of not less than  $43 + 10 \log (P)$  dB on all frequencies between 2305 and 2320 MHz.

Rule Part 27.53(h) specifies that “ for operations in the 1695-1710 MHz, 1710-1755 MHz, 1755-1780 MHz, 1915-1920 MHz, 1995-2000 MHz, 2000-2020 MHz, 2110-2155 MHz, 2155-2180 MHz, and 2180-2200 bands, the power of any emission outside a licensee's frequency block shall be attenuated below the transmitter power (P) in watts by at least  $43 + 10 \log_{10} (P)$  dB”

Rule Part 27.53(g) For operations in the 600 MHz band and the 698-746 MHz band, the power of any emission outside a licensee's frequency band(s) of operation shall be attenuated below the transmitter power (P) within the licensed band(s) of operation, measured in watts, by at least  $43 + 10 \log (P)$  dB. Compliance with this provision is based on the use of measurement instrumentation employing a resolution bandwidth of 100 kilohertz or greater. However, in the 100 kilohertz bands immediately outside and adjacent to a licensee's frequency block, a resolution bandwidth of at least 30 kHz may be employed.

Example:

The limit line is derived from  $43 + 10\log(P)$  dB below the transmitter power P(Watts)

$$= P(W) - [43 + 10\log(P)] \text{ (dB)}$$

$$= [30 + 10\log(P)] \text{ (dBm)} - [43 + 10\log(P)] \text{ (dB)} = -13\text{dBm}.$$

Rule Part 27.53(f) For operations in the 746-758 MHz, 775-788 MHz, and 805-806 MHz bands, emissions in the band 1559-1610 MHz shall be limited to  $-70$  dBW/MHz equivalent isotropically radiated power (EIRP) for wideband signals, and  $-80$  dBW EIRP for discrete emissions of less than 700 Hz bandwidth. For the purpose of equipment authorization, a transmitter shall be tested with an antenna that is representative of the type that will be used with the equipment in normal operation.

Rule Part 27.53 (c) For operations in the 746-758 MHz band and the 776-788 MHz band, the power of any emission outside the licensee's frequency band(s) of operation shall be attenuated below the transmitter power (P) within the licensed band(s) of operation, measured in watts, in accordance with the following:

- (1) On any frequency outside the 746-758 MHz band, the power of any emission shall be attenuated outside the band below the transmitter power (P) by at least  $43 + 10 \log(P)$  dB;
- (2) On any frequency outside the 776-788 MHz band, the power of any emission shall be attenuated outside the band below the transmitter power (P) by at least  $43 + 10 \log(P)$  dB;
- (3) On all frequencies between 763-775 MHz and 793-805 MHz, by a factor not less than  $76 + 10 \log(P)$  dB in a 6.25 kHz band segment, for base and fixed stations;
- (4) On all frequencies between 763-775 MHz and 793-805 MHz, by a factor not less than  $65 + 10 \log(P)$  dB in a 6.25 kHz band segment, for mobile and portable stations;
- (5) Compliance with the provisions of paragraphs (c)(1) and (c)(2) of this section is based on the use of measurement instrumentation employing a resolution bandwidth of 100 kHz or greater. However, in the 100 kHz bands immediately outside and adjacent to the frequency block, a resolution bandwidth of at least 30 kHz may be employed;

### Measurement Uncertainty

The assessed measurement uncertainty to ensure 95% confidence level for the normal distribution is with the coverage factor  $k = 1.96$ ,  $U=0.684\text{dB}$ .

**Test Result**

All the test traces in the plots shows the test results clearly.

LTE eMTC Band 4 QPSK 1.4MHz CH-Low, 1 RB



LTE eMTC Band 4 QPSK 1.4MHz CH-High, 1 RB

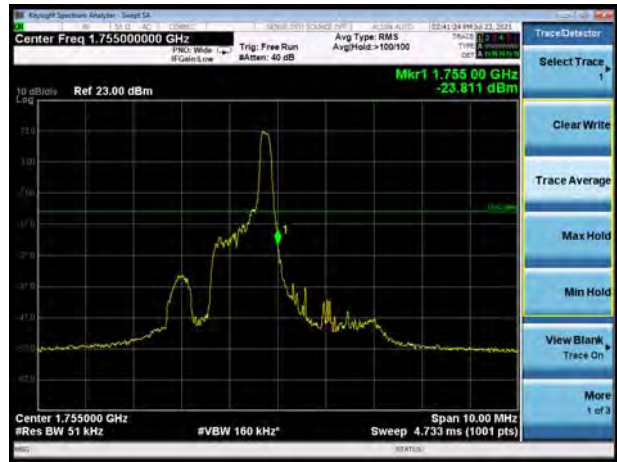

LTE eMTC Band 4 QPSK 1.4MHz CH-Low, 100%RB



LTE eMTC Band 4 QPSK 1.4MHz CH-High, 100%RB

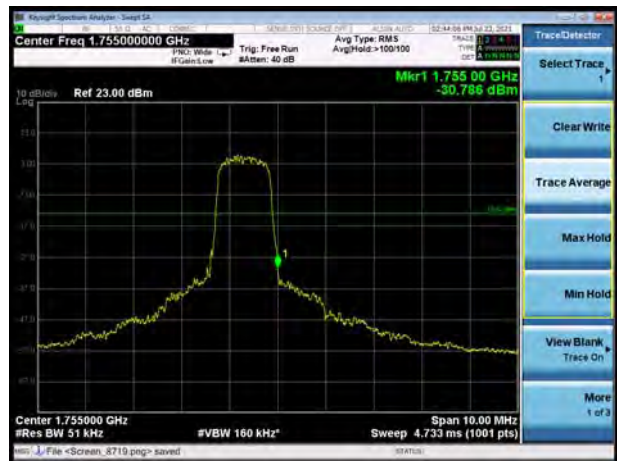

LTE eMTC Band 4 QPSK 3MHz CH-Low, 1 RB



LTE eMTC Band 4 QPSK 3MHz CH-High, 1 RB



RF Test Report

Report No.: R2211A1103-R6

LTE eMTC Band 4 QPSK 3MHz CH-Low, 100%RB

LTE eMTC Band 4 QPSK 3MHz CH-High, 100%RB

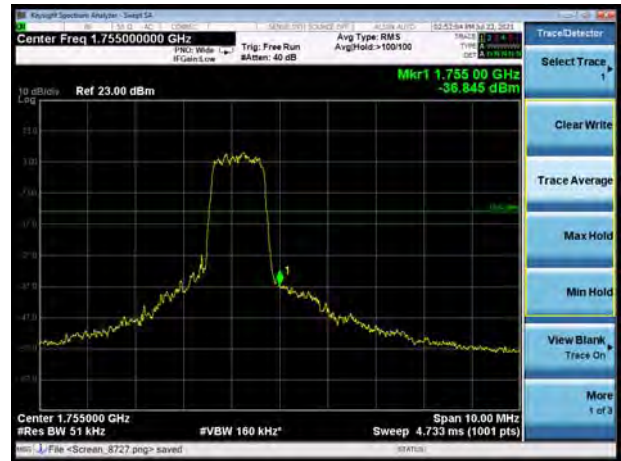
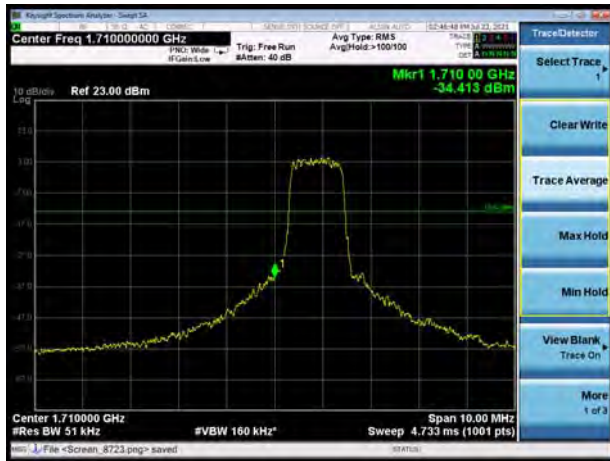

LTE eMTC Band 4 QPSK 5MHz CH-Low, 1 RB

LTE eMTC Band 4 QPSK 5MHz CH-High, 1 RB



LTE eMTC Band 4 QPSK 5MHz CH-Low, 100%RB

LTE eMTC Band 4 QPSK 5MHz CH-High, 100%RB



LTE eMTC Band 4 QPSK 10MHz CH-Low, 1 RB



LTE eMTC Band 4 QPSK 10MHz CH-High, 1 RB

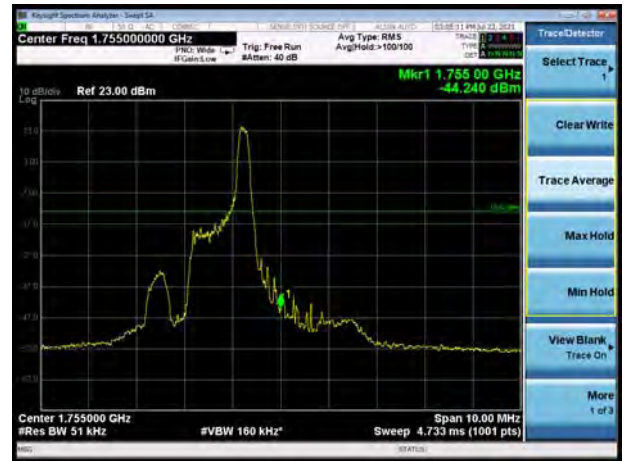

LTE eMTC Band 4 QPSK 10MHz CH-Low, 100%RB

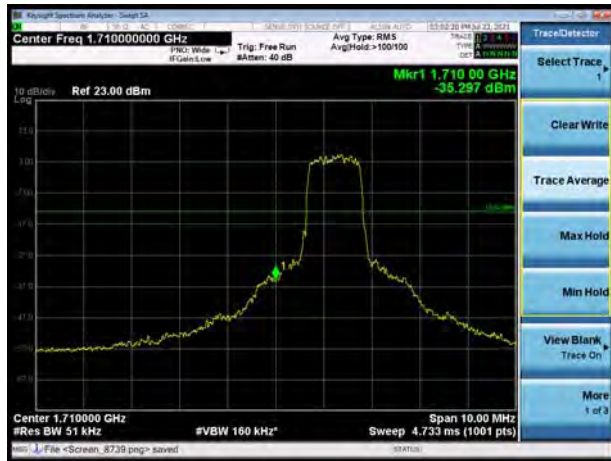

LTE eMTC Band 4 QPSK 10MHz CH-High, 100%RB

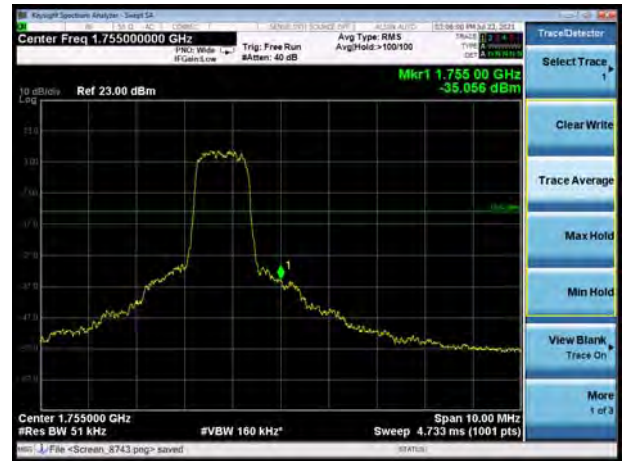

LTE eMTC Band 4 QPSK 15MHz CH-Low, 1 RB



LTE eMTC Band 4 QPSK 15MHz CH-High, 1 RB

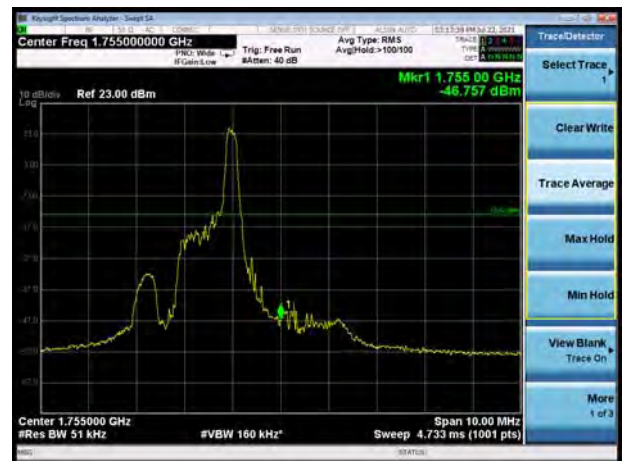

RF Test Report

Report No.: R2211A1103-R6

LTE eMTC Band 4 QPSK 15MHz CH-Low, 100%RB

LTE eMTC Band 4 QPSK 15MHz CH-High, 100%RB



LTE eMTC Band 4 QPSK 20MHz CH-Low, 1 RB

LTE eMTC Band 4 QPSK 20MHz CH-High, 1 RB



LTE eMTC Band 4 QPSK 20MHz CH-Low, 100%RB

LTE eMTC Band 4 QPSK 20MHz CH-High, 100%RB

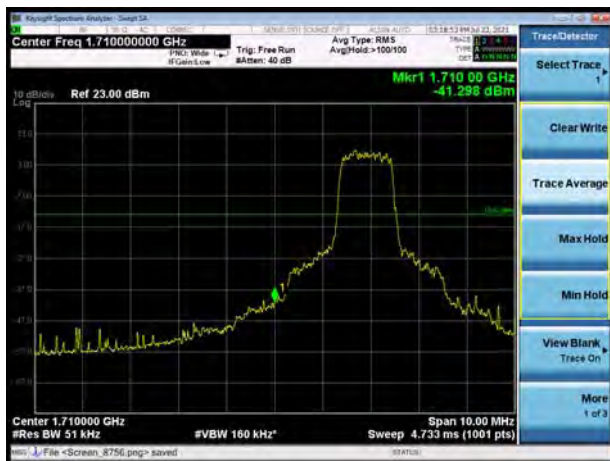

LTE eMTC Band 4 16QAM 1.4MHz CH-Low, 1 RB



LTE eMTC Band 4 16QAM 1.4MHz CH-High, 1 RB



LTE eMTC Band 4 16QAM 1.4MHz CH-Low, 100%RB

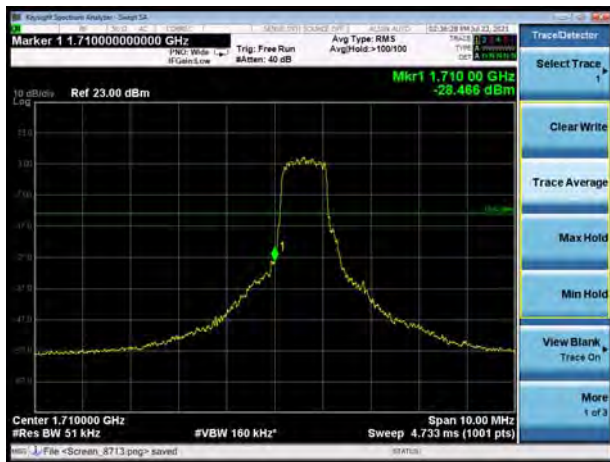

LTE eMTC Band 4 16QAM 1.4MHz CH-High, 100%RB

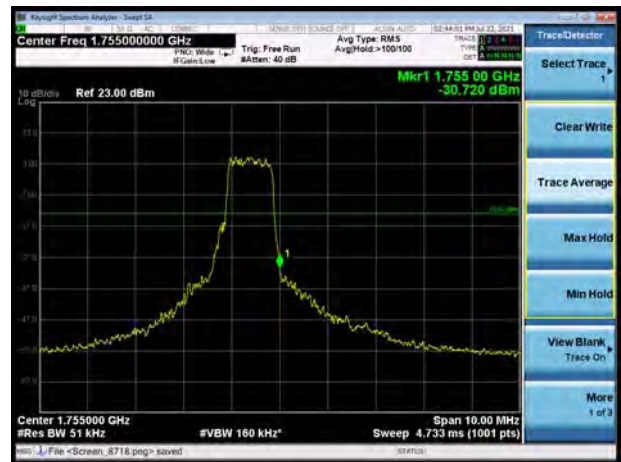

LTE eMTC Band 4 16QAM 3MHz CH-Low, 1 RB



LTE eMTC Band 4 16QAM 3MHz CH-High, 1 RB



RF Test Report

Report No.: R2211A1103-R6

LTE eMTC Band 4 16QAM 3MHz CH-Low, 100%RB

LTE eMTC Band 4 16QAM 3MHz CH-High, 100%RB

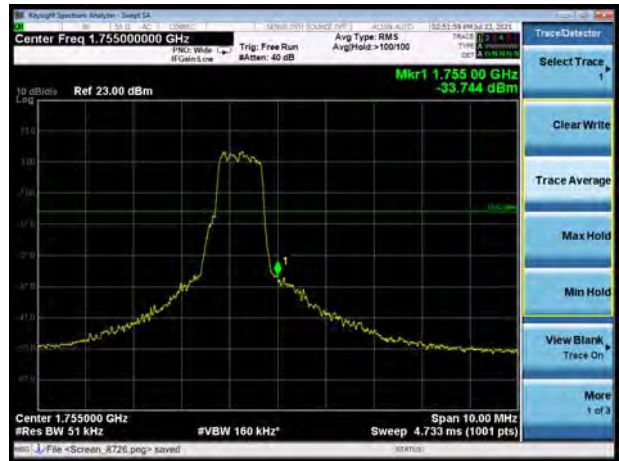

LTE eMTC Band 4 16QAM 5MHz CH-Low, 1 RB

LTE eMTC Band 4 16QAM 5MHz CH-High, 1 RB



LTE eMTC Band 4 16QAM 5MHz CH-Low, 100%RB

LTE eMTC Band 4 16QAM 5MHz CH-High, 100%RB

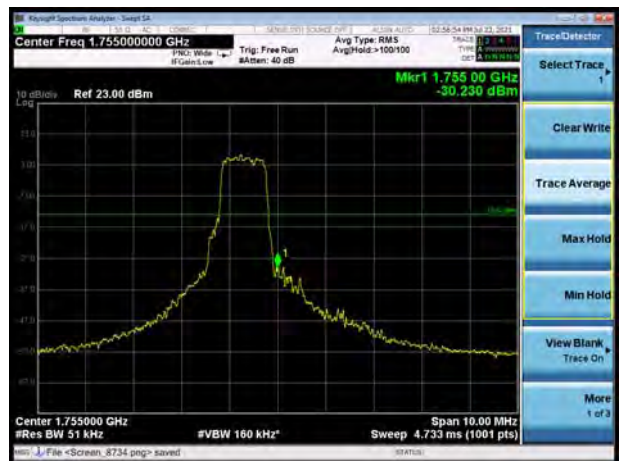
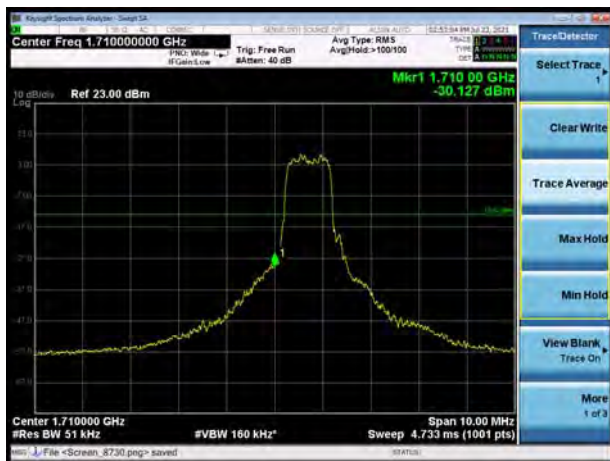



LTE eMTC Band 4 16QAM 10MHz CH-Low, 1 RB



LTE eMTC Band 4 16QAM 10MHz CH-High, 1 RB



LTE eMTC Band 4 16QAM 10MHz CH-Low, 100%RB



LTE eMTC Band 4 16QAM 10MHz CH-High, 100%RB



LTE eMTC Band 4 16QAM 15MHz CH-Low, 1 RB



LTE eMTC Band 4 16QAM 15MHz CH-High, 1 RB



LTE eMTC Band 4 16QAM 15MHz CH-Low, 100%RB

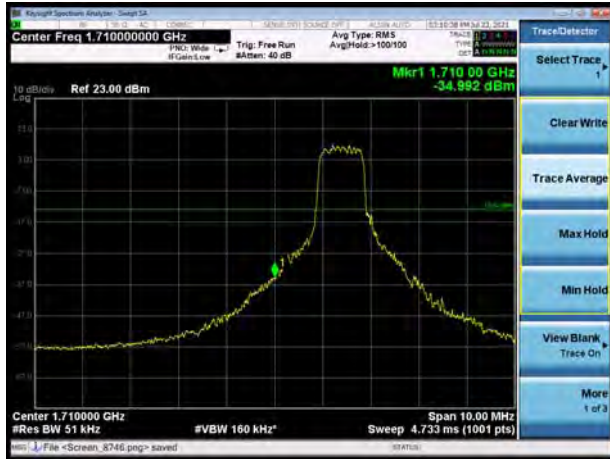

LTE eMTC Band 4 16QAM 15MHz CH-High, 100%RB

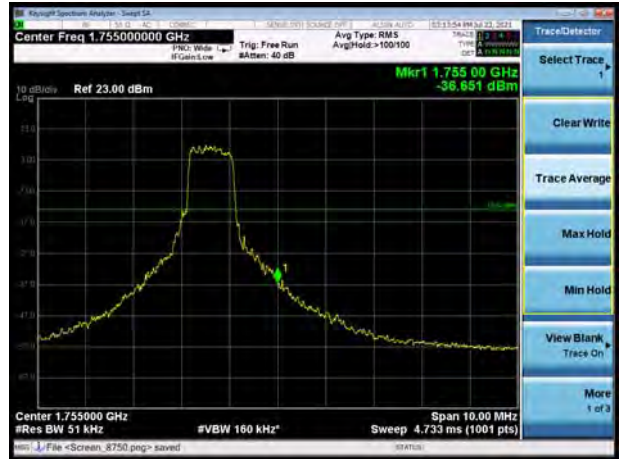

LTE eMTC Band 4 16QAM 20MHz CH-Low, 1 RB



LTE eMTC Band 4 16QAM 20MHz CH-High, 1 RB



LTE eMTC Band 4 16QAM 20MHz CH-Low, 100%RB



LTE eMTC Band 4 16QAM 20MHz CH-High, 100%RB



LTE eMTC Band 12 QPSK 1.4MHz CH-Low, 1 RB

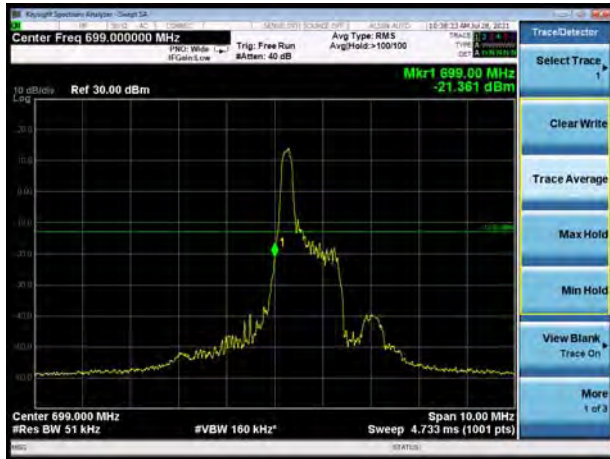

LTE eMTC Band 12 QPSK 1.4MHz CH-High, 1 RB



LTE eMTC Band 12 QPSK 1.4MHz CH-Low, 100%RB

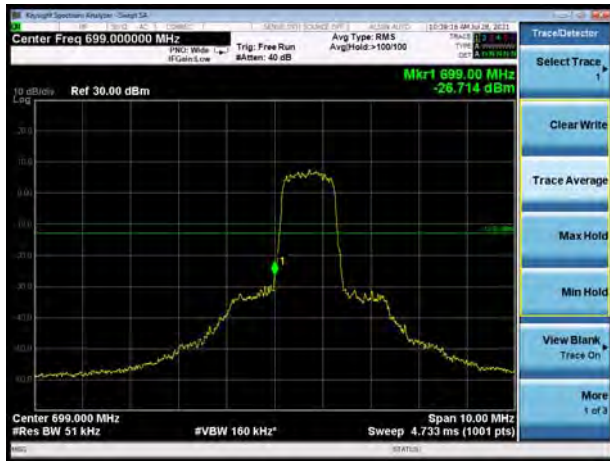

LTE eMTC Band 12 QPSK 1.4MHz CH-High, 100%RB

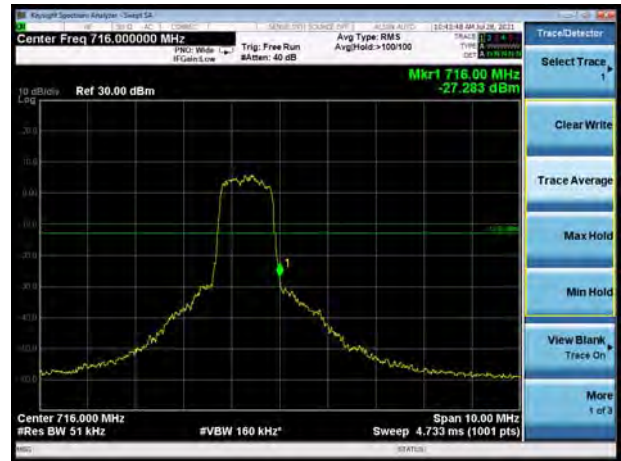

LTE eMTC Band 12 QPSK 3MHz CH-Low, 1 RB



LTE eMTC Band 12 QPSK 3MHz CH-High, 1 RB



RF Test Report

Report No.: R2211A1103-R6

LTE eMTC Band 12 QPSK 3MHz CH-Low, 100%RB

LTE eMTC Band 12 QPSK 3MHz CH-High, 100%RB

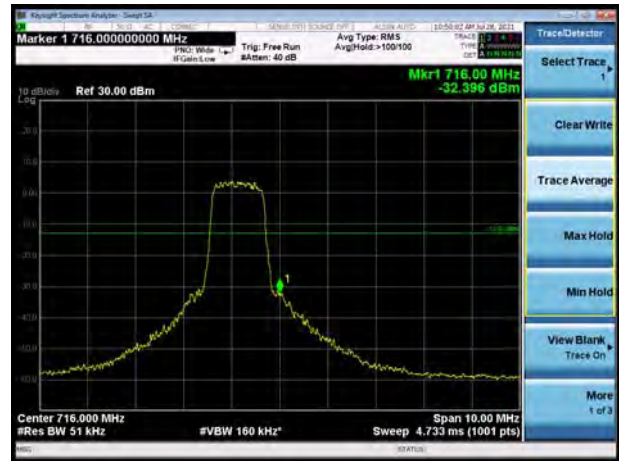
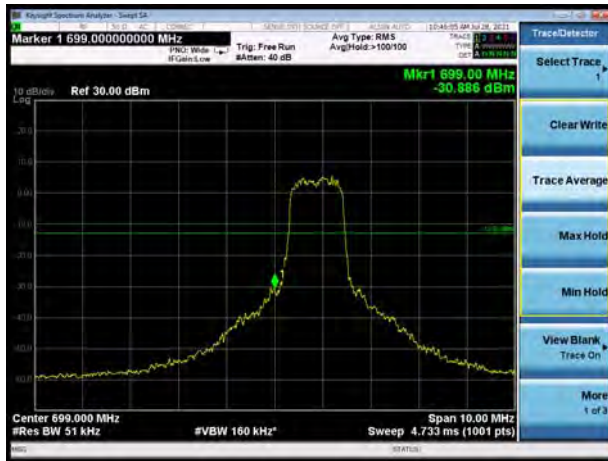

LTE eMTC Band 12 QPSK 5MHz CH-Low, 1 RB

LTE eMTC Band 12 QPSK 5MHz CH-High, 1 RB



LTE eMTC Band 12 QPSK 5MHz CH-Low, 100%RB

LTE eMTC Band 12 QPSK 5MHz CH-High, 100%RB

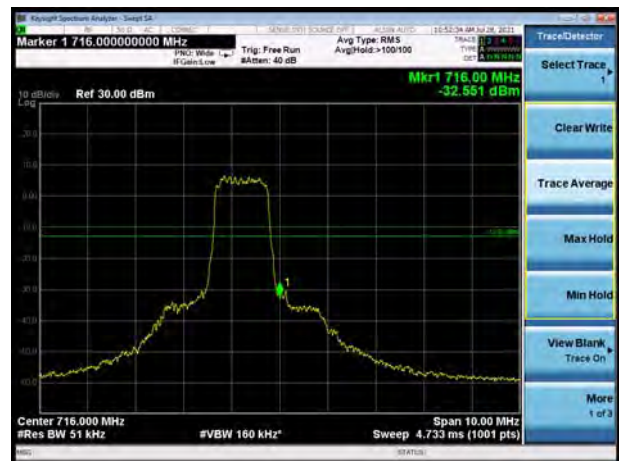
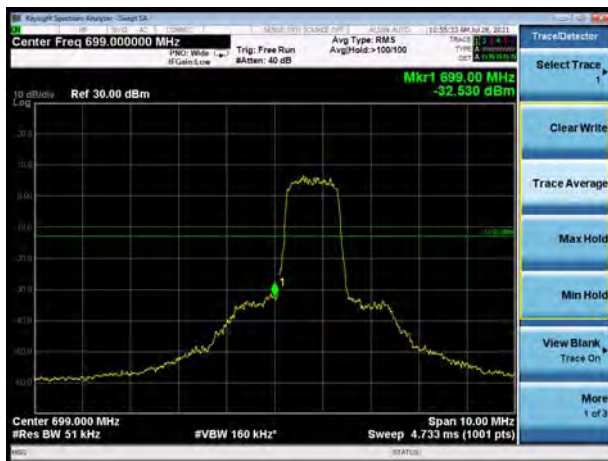

LTE eMTC Band 12 QPSK 10MHz CH-Low, 1 RB



LTE eMTC Band 12 QPSK 10MHz CH-High, 1 RB

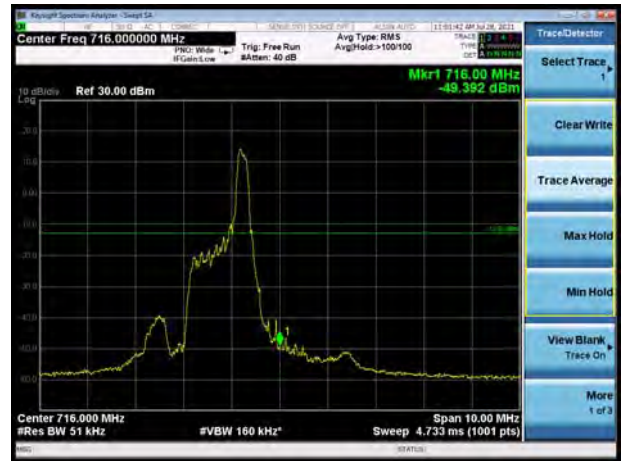

LTE eMTC Band 12 QPSK 10MHz CH-Low, 100%RB

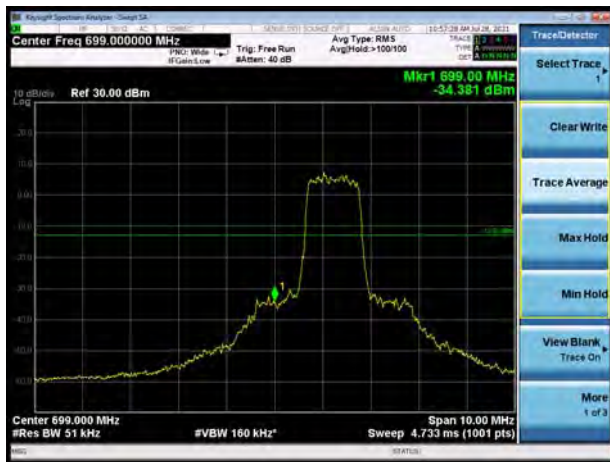

LTE eMTC Band 12 QPSK 10MHz CH-High, 100%RB

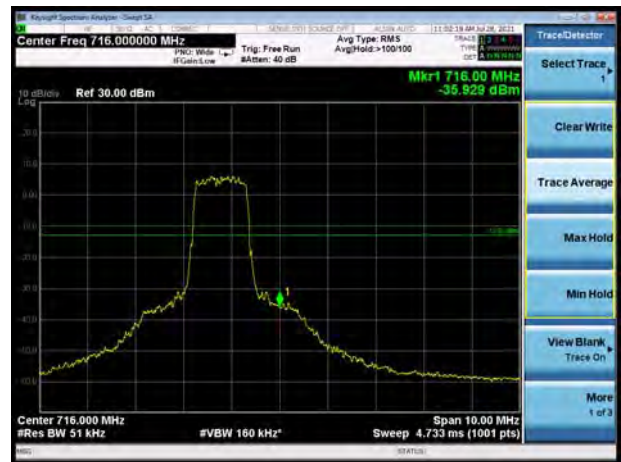

LTE eMTC Band 12 16QAM 1.4MHz CH-Low, 1 RB



LTE eMTC Band 12 16QAM 1.4MHz CH-High, 1 RB



LTE eMTC Band 12 16QAM 1.4MHz CH-Low, 100%RB

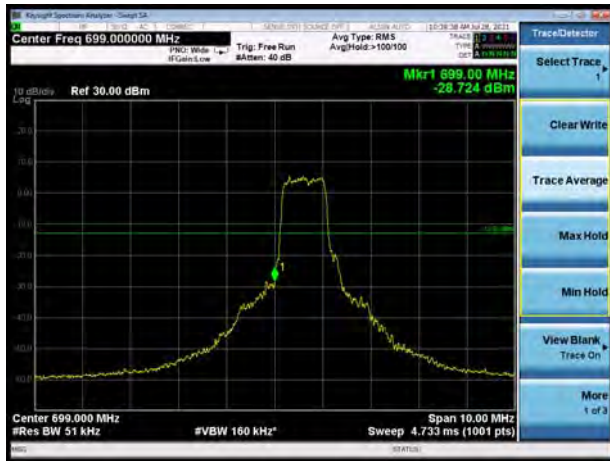

LTE eMTC Band 12 16QAM 1.4MHz CH-High, 100%RB

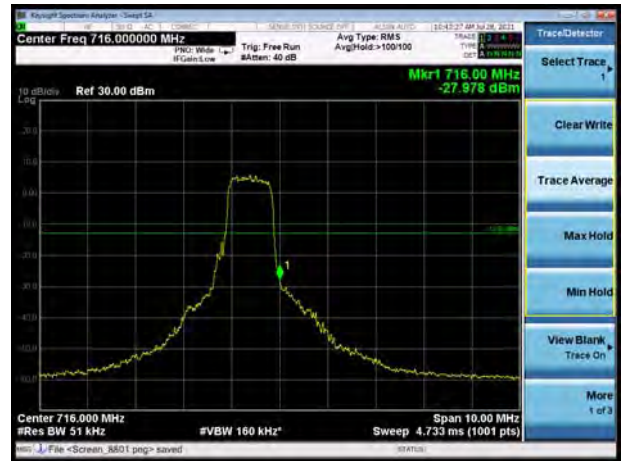

LTE eMTC Band 12 16QAM 3MHz CH-Low, 1 RB



LTE eMTC Band 12 16QAM 3MHz CH-High, 1 RB



LTE eMTC Band 12 16QAM 3MHz CH-Low, 100%RB

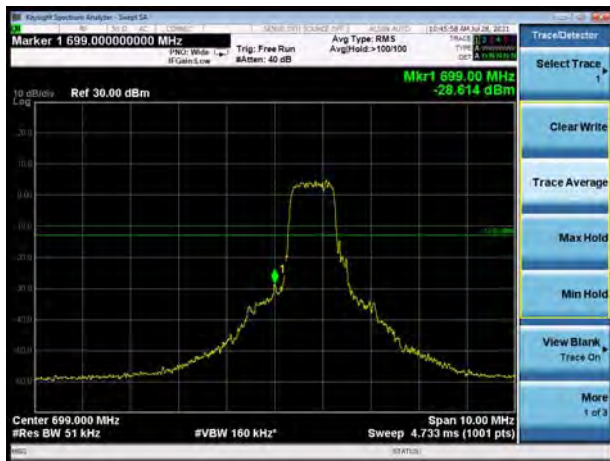

LTE eMTC Band 12 16QAM 3MHz CH-High, 100%RB

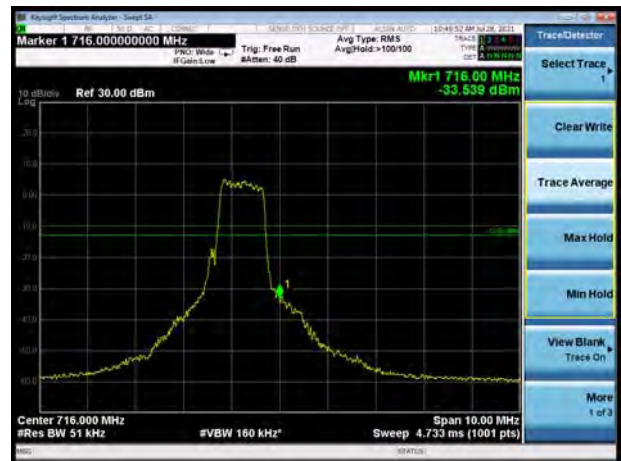

LTE eMTC Band 12 16QAM 5MHz CH-Low, 1 RB



LTE eMTC Band 12 16QAM 5MHz CH-High, 1 RB



LTE eMTC Band 12 16QAM 5MHz CH-Low, 100%RB

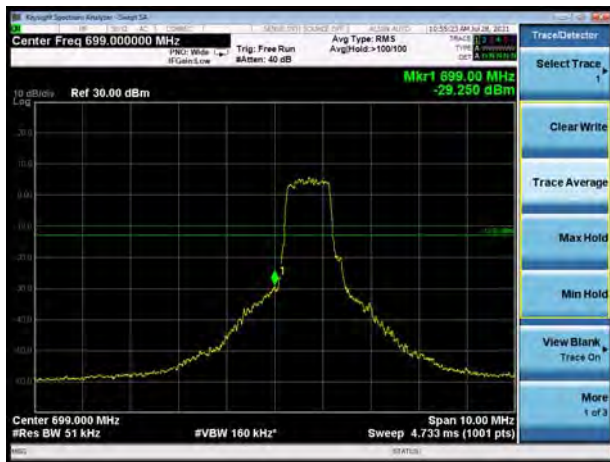

LTE eMTC Band 12 16QAM 5MHz CH-High, 100%RB

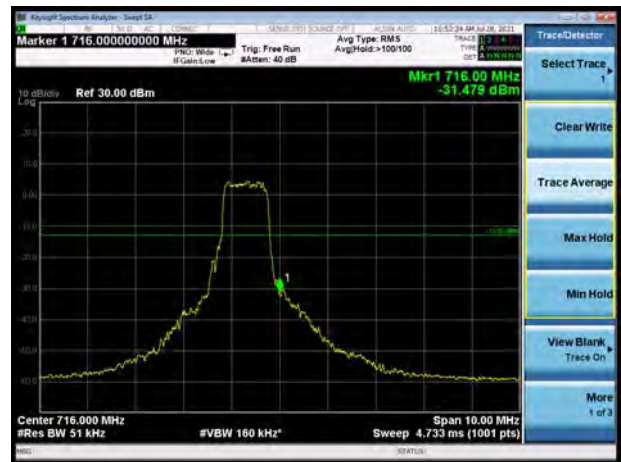

LTE eMTC Band 12 16QAM 10MHz CH-Low, 1 RB

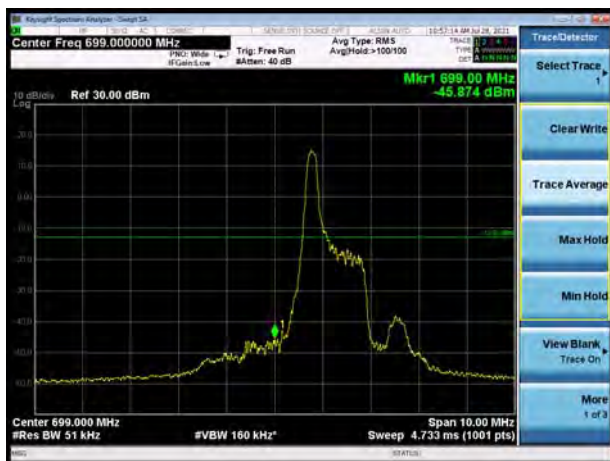

LTE eMTC Band 12 16QAM 10MHz CH-High, 1 RB



RF Test Report

Report No.: R2211A1103-R6

LTE eMTC Band 12 16QAM 10MHz CH-Low, 100%RB

LTE eMTC Band 12 16QAM 10MHz CH-High, 100%RB

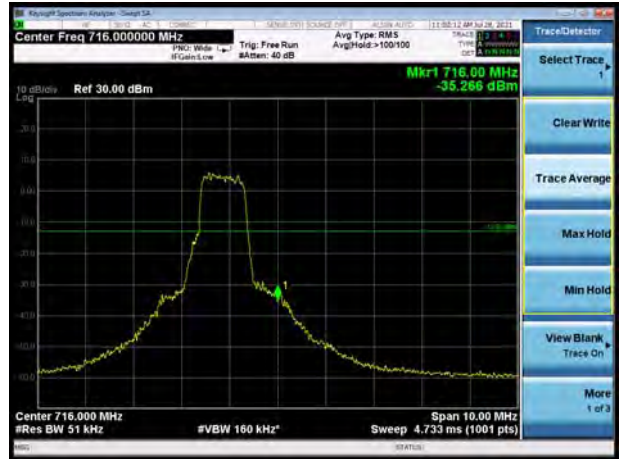
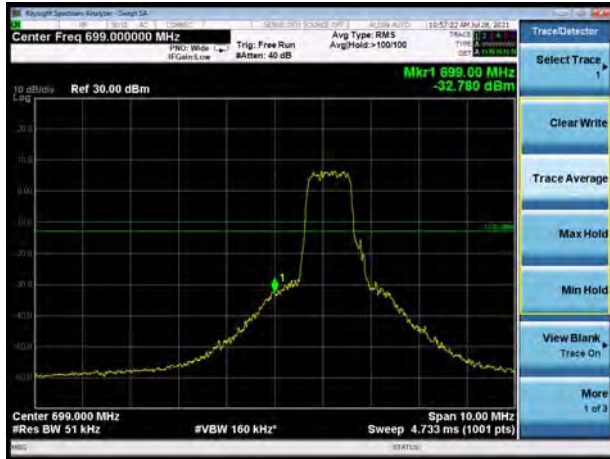

LTE eMTC Band 13 QPSK 5MHz CH-Low, 1 RB (763MHz ~775MHz)

LTE eMTC Band 13 QPSK 10MHz CH-Low, 1 RB (775MHz ~777MHz)

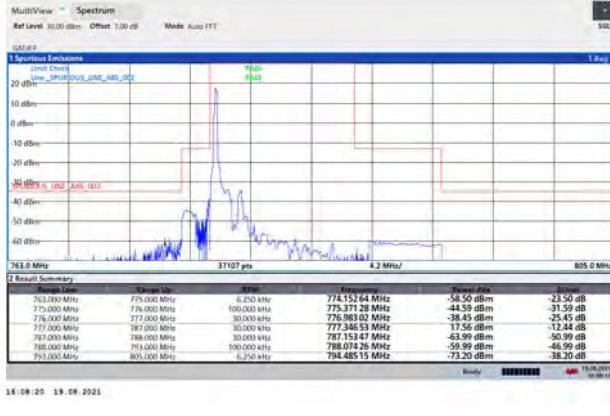

LTE eMTC Band 13 QPSK 5MHz CH-High, 1 RB (787MHz ~793MHz)

LTE eMTC Band 13 QPSK 10MHz CH-High, 1 RB (793MHz ~805MHz)

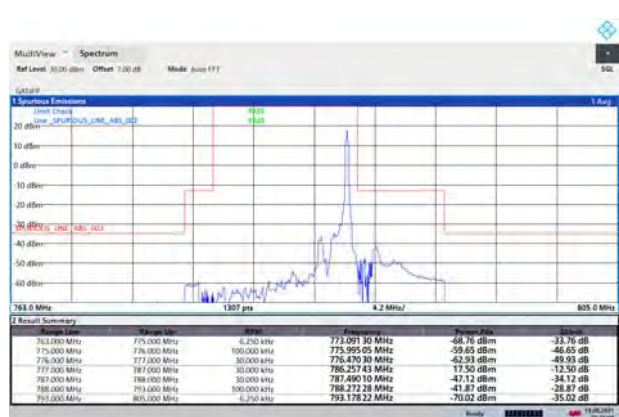



LTE eMTC Band 13 QPSK 5MHz CH-Low, 100%RB (763MHz ~775MHz)



14:10:40 19.08.2021

LTE eMTC Band 13 QPSK 10MHz CH-Low, 100%RB (775MHz ~777MHz)

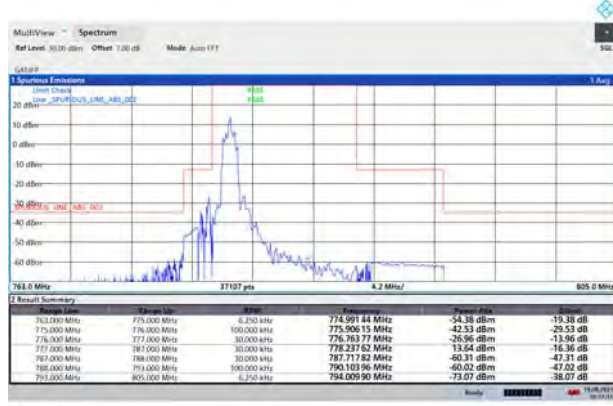

14:17:15 19.08.2021

LTE eMTC Band 13 QPSK 5MHz CH-High, 100%RB (787MHz ~793MHz)

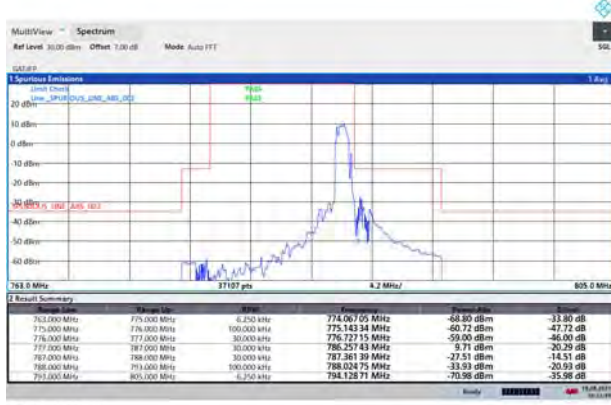

14:12:56 19.08.2021

LTE eMTC Band 13 QPSK 10MHz CH-High, 100%RB (793MHz ~805MHz)

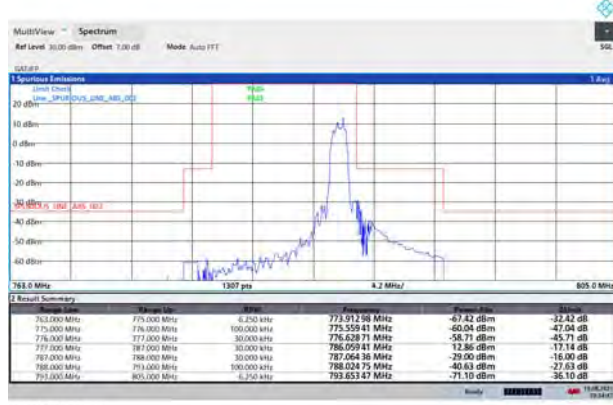

13:34:47 19.08.2021

LTE eMTC Band 13 16QAM 5MHz CH-Low, 1 RB (763MHz ~775MHz)

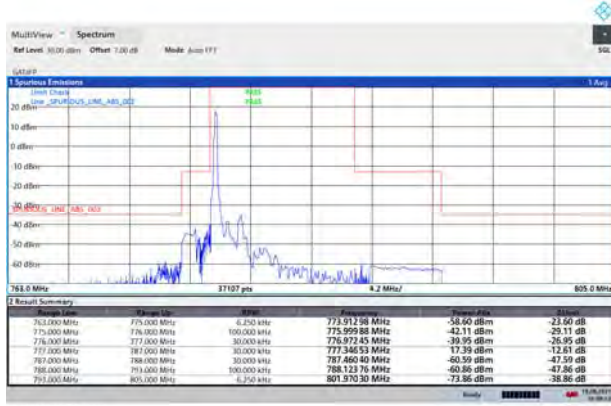

14:09:54 19.08.2021

LTE eMTC Band 13 16QAM 10MHz CH-Low, 1 RB (775MHz ~777MHz)



14:15:47 19.08.2021

RF Test Report

Report No.: R2211A1103-R6

LTE eMTC Band 13 16QAM 5MHz CH-High, 1 RB  
(787MHz ~793MHz)

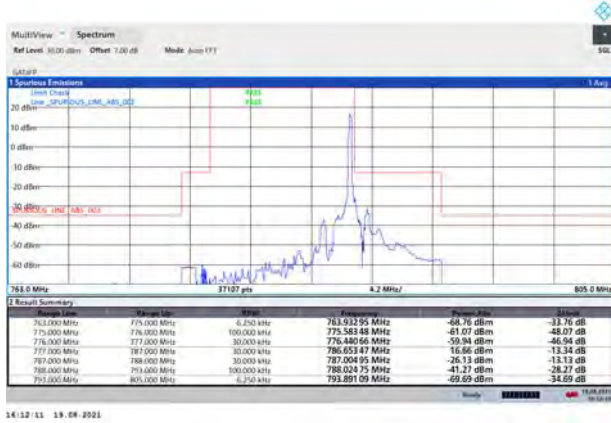

LTE eMTC Band 13 16QAM 10MHz CH-High, 1 RB  
(793MHz ~805MHz)

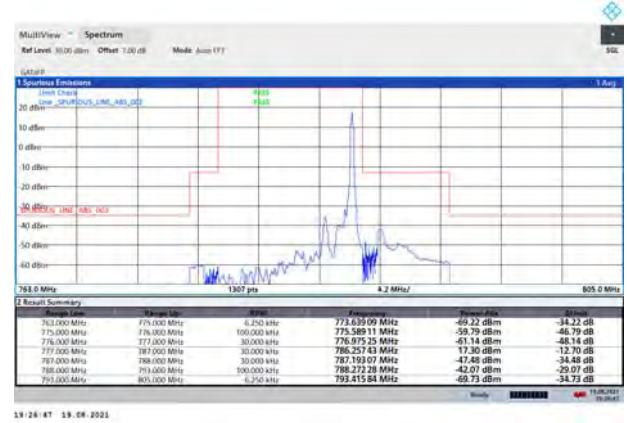

LTE eMTC Band 13 16QAM 5MHz CH-Low, 100%RB  
(763MHz ~775MHz)



LTE eMTC Band 13 16QAM 10MHz CH-Low, 100%RB  
(775MHz ~777MHz)



LTE eMTC Band 13 16QAM 5MHz CH-High, 100%RB  
(787MHz ~793MHz)



LTE eMTC Band 13 16QAM 10MHz CH-High, 100%RB  
(793MHz ~805MHz)



LTE eMTC Band 66 QPSK 1.4MHz CH-Low, 1 RB



LTE eMTC Band 66 QPSK 1.4MHz CH-High, 1 RB



LTE eMTC Band 66 QPSK 1.4MHz CH-Low, 100%RB



LTE eMTC Band 66 QPSK 1.4MHz CH-High, 100%RB



LTE eMTC Band 66 QPSK 3MHz CH-Low, 1 RB



LTE eMTC Band 66 QPSK 3MHz CH-High, 1 RB



LTE eMTC Band 66 QPSK 3MHz CH-Low, 100%RB



LTE eMTC Band 66 QPSK 3MHz CH-High, 100%RB



LTE eMTC Band 66 QPSK 5MHz CH-Low, 1 RB



LTE eMTC Band 66 QPSK 5MHz CH-High, 1 RB



LTE eMTC Band 66 QPSK 5MHz CH-Low, 100%RB



LTE eMTC Band 66 QPSK 5MHz CH-High, 100%RB



LTE eMTC Band 66 QPSK 10MHz CH-Low, 1 RB



LTE eMTC Band 66 QPSK 10MHz CH-High, 1 RB



LTE eMTC Band 66 QPSK 10MHz CH-Low, 100%RB



LTE eMTC Band 66 QPSK 10MHz CH-High, 100%RB



LTE eMTC Band 66 QPSK 15MHz CH-Low, 1 RB



LTE eMTC Band 66 QPSK 15MHz CH-High, 1 RB



RF Test Report

Report No.: R2211A1103-R6

LTE eMTC Band 66 QPSK 15MHz CH-Low, 100%RB



LTE eMTC Band 66 QPSK 15MHz CH-High, 100%RB



LTE eMTC Band 66 QPSK 20MHz CH-Low, 1 RB



LTE eMTC Band 66 QPSK 20MHz CH-High, 1 RB



LTE eMTC Band 66 QPSK 20MHz CH-Low, 100%RB



LTE eMTC Band 66 QPSK 20MHz CH-High, 100%RB



LTE eMTC Band 66 16QAM 1.4MHz CH-Low, 1 RB

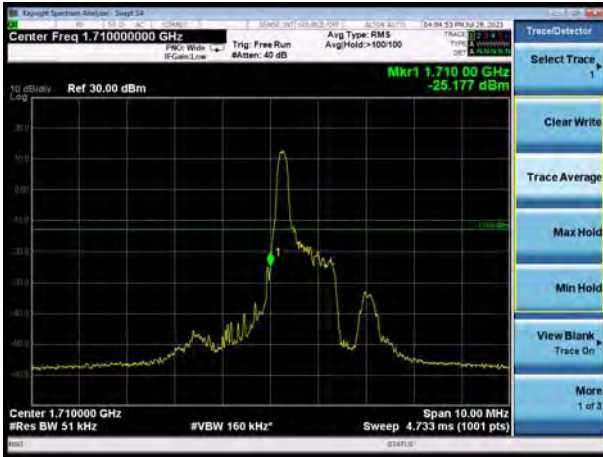

LTE eMTC Band 66 16QAM 1.4MHz CH-High, 1 RB



LTE eMTC Band 66 16QAM 1.4MHz CH-Low, 100%RB



LTE eMTC Band 66 16QAM 1.4MHz CH-High, 100%RB

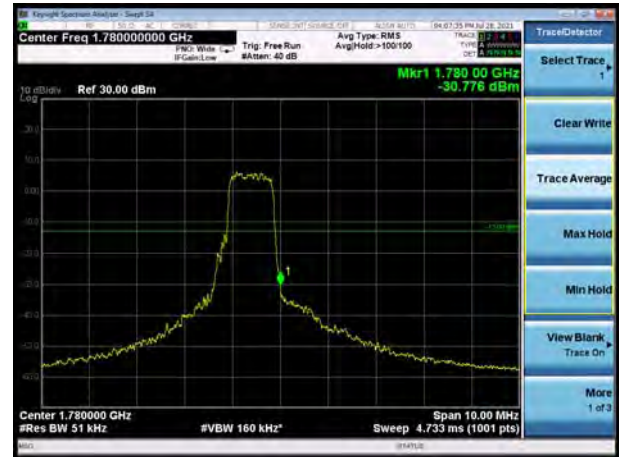

LTE eMTC Band 66 16QAM 3MHz CH-Low, 1 RB



LTE eMTC Band 66 16QAM 3MHz CH-High, 1 RB



RF Test Report

Report No.: R2211A1103-R6

LTE eMTC Band 66 16QAM 3MHz CH-Low, 100%RB



LTE eMTC Band 66 16QAM 3MHz CH-High, 100%RB

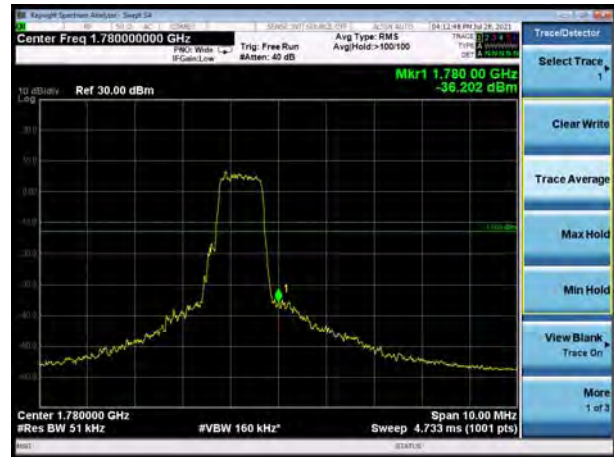

LTE eMTC Band 66 16QAM 5MHz CH-Low, 1 RB



LTE eMTC Band 66 16QAM 5MHz CH-High, 1 RB



LTE eMTC Band 66 16QAM 5MHz CH-Low, 100%RB

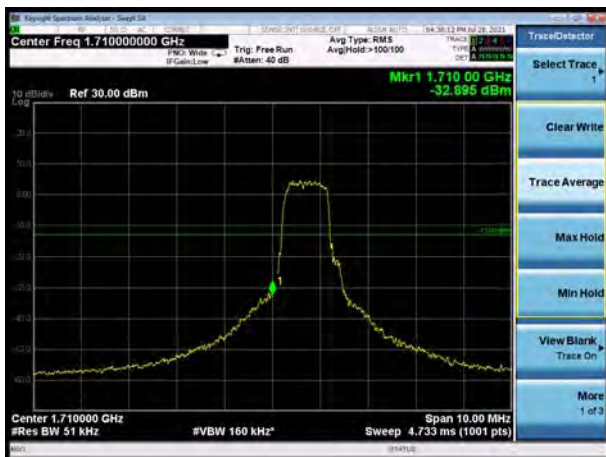

LTE eMTC Band 66 16QAM 5MHz CH-High, 100%RB





LTE eMTC Band 66 16QAM 10MHz CH-Low, 1 RB



LTE eMTC Band 66 16QAM 10MHz CH-High, 1 RB



LTE eMTC Band 66 16QAM 10MHz CH-Low, 100%RB

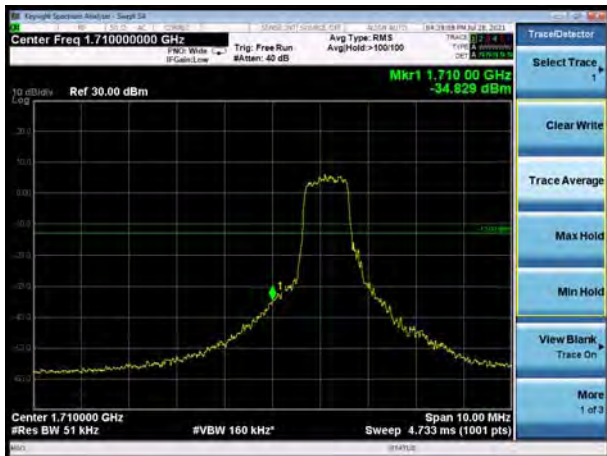

LTE eMTC Band 66 16QAM 10MHz CH-High, 100%RB

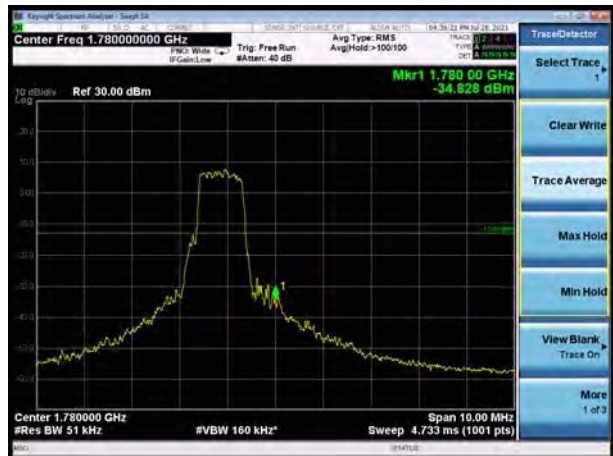

LTE eMTC Band 66 16QAM 15MHz CH-Low, 1 RB



LTE eMTC Band 66 16QAM 15MHz CH-High, 1 RB



RF Test Report

Report No.: R2211A1103-R6

LTE eMTC Band 66 16QAM 15MHz CH-Low, 100%RB

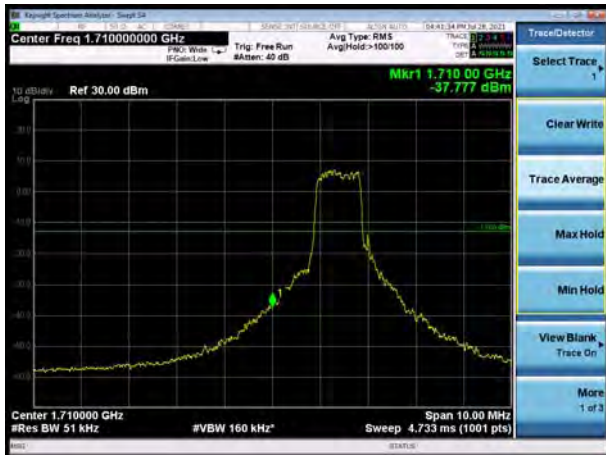

LTE eMTC Band 66 16QAM 15MHz CH-High, 100%RB

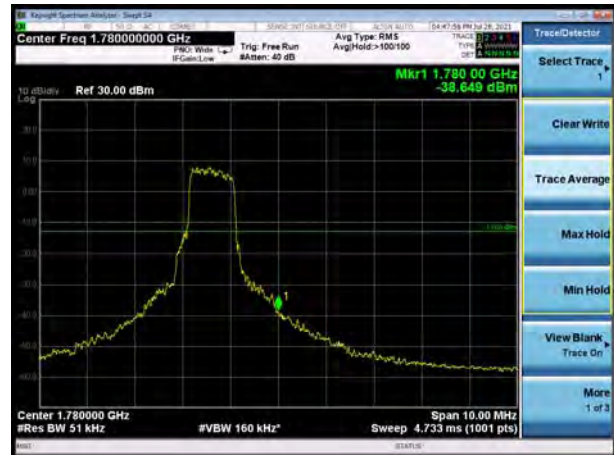

LTE eMTC Band 66 16QAM 20MHz CH-Low, 1 RB



LTE eMTC Band 66 16QAM 20MHz CH-High, 1 RB



LTE eMTC Band 66 16QAM 20MHz CH-Low, 100%RB



LTE eMTC Band 66 16QAM 20MHz CH-High, 100%RB

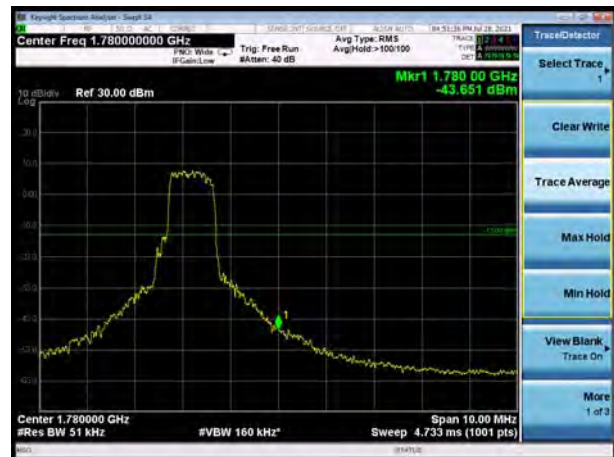

## 5.4 Peak-to-Average Power Ratio (PAPR)

### Ambient condition

Temperature	Relative humidity	Pressure
23°C ~25°C	45%~50%	101.5kPa

### Methods of Measurement

Measure the total peak power and record as PPk. And measure the total average power and record as PAvg. Both the peak and average power levels must be expressed in the same logarithmic units (e.g., dBm). Determine the PAPR from:

$$\text{PAPR (dB)} = \text{PPk (dBm)} - \text{PAvg (dBm)}$$

### Test Setup

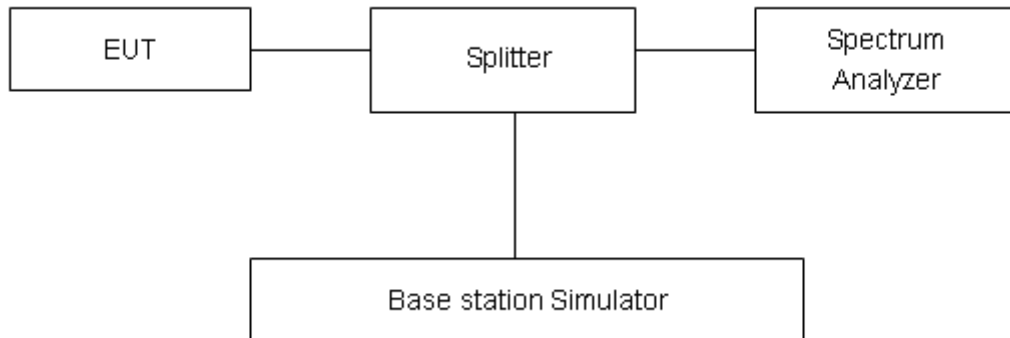

### Limits

Rule Part 27.50(d)(5) Equipment employed must be authorized in accordance with the provisions of 24.51. Power measurements for transmissions by stations authorized under this section may be made either in accordance with a Commission-approved average power technique or in compliance with paragraph (d)(6) of this section. In measuring transmissions in this band using an average power technique, the peak-to-average ratio (PAR) of the transmission may not exceed 13 dB.

### Measurement Uncertainty

The assessed measurement uncertainty to ensure 95% confidence level for the normal distribution is with the coverage factor  $k = 2$ ,  $U = 0.4$  dB.

**Test Results**

Mode	Bandwidth	Modulation	Channel/ Frequency(MHz)	Peak-to-Average Power Ratio (PAPR)			Limit (dB)	Conclusion
				Peak(dBm)	Avg(dBm)	PAPR(dB)		
LTE eMTC Band4	1.4MHz	QPSK	20175/1732.5	25.80	14.65	11.15	≤13	PASS
		16QAM	20175/1732.5	26.42	14.34	12.08	≤13	PASS
	3MHz	QPSK	20175/1732.5	25.96	16.00	9.96	≤13	PASS
		16QAM	20175/1732.5	26.67	16.70	9.97	≤13	PASS
	5MHz	QPSK	20175/1732.5	26.94	17.21	9.73	≤13	PASS
		16QAM	20175/1732.5	26.60	15.47	11.13	≤13	PASS
	10MHz	QPSK	20175/1732.5	27.05	18.01	9.04	≤13	PASS
		16QAM	20175/1732.5	27.23	15.98	11.25	≤13	PASS
	15MHz	QPSK	20175/1732.5	27.72	19.22	8.50	≤13	PASS
		16QAM	20175/1732.5	28.01	18.32	9.69	≤13	PASS
20MHz	QPSK	20175/1732.5	27.67	18.59	9.08	≤13	PASS	
	16QAM	20175/1732.5	28.02	18.26	9.76	≤13	PASS	
Mode	Bandwidth	Modulation	Channel/ Frequency(MHz)	Peak-to-Average Power Ratio (PAPR)			Limit (dB)	Conclusion
Peak(dBm)	Avg(dBm)	PAPR(dB)						
LTE eMTC Band12	1.4MHz	QPSK	23095/707.5	27.39	17.59	9.80	≤13	PASS
		16QAM	23095/707.5	27.23	16.29	10.94	≤13	PASS
	3MHz	QPSK	23095/707.5	26.79	17.19	9.60	≤13	PASS
		16QAM	23095/707.5	27.16	15.36	11.80	≤13	PASS
	5MHz	QPSK	23095/707.5	27.38	17.59	9.79	≤13	PASS
		16QAM	23095/707.5	27.44	17.28	10.16	≤13	PASS
	10MHz	QPSK	23095/707.5	27.52	17.82	9.70	≤13	PASS
		16QAM	23095/707.5	27.90	17.42	10.48	≤13	PASS
Mode	Bandwidth	Modulation	Channel/ Frequency(MHz)	Peak-to-Average Power Ratio (PAPR)			Limit (dB)	Conclusion
Peak(dBm)	Avg(dBm)	PAPR(dB)						
LTE eMTC Band13	5MHz	QPSK	23230/782	27.59	18.03	9.56	≤13	PASS
		16QAM	23230/782	27.69	17.35	10.34	≤13	PASS
	10MHz	QPSK	23230/782	27.68	18.17	9.51	≤13	PASS
		16QAM	23230/782	28.15	18.03	10.12	≤13	PASS
Mode	Bandwidth	Modulation	Channel/ Frequency(MHz)	Peak-to-Average Power Ratio (PAPR)			Limit (dB)	Conclusion
Peak(dBm)	Avg(dBm)	PAPR(dB)						
LTE eMTC Band66	1.4MHz	QPSK	132322/1745	26.48	17.09	9.39	≤13	PASS
		16QAM	132322/1745	26.93	16.37	10.56	≤13	PASS
	3MHz	QPSK	132322/1745	26.03	15.19	10.84	≤13	PASS
		16QAM	132322/1745	26.93	16.83	10.10	≤13	PASS
	5MHz	QPSK	132322/1745	27.13	17.65	9.48	≤13	PASS
		16QAM	132322/1745	26.80	15.62	11.18	≤13	PASS

10MHz	QPSK	132322/1745	27.14	17.78	9.36	≤13	PASS
	16QAM	132322/1745	27.64	17.89	9.75	≤13	PASS
15MHz	QPSK	132322/1745	27.84	19.22	8.62	≤13	PASS
	16QAM	132322/1745	28.12	16.86	11.26	≤13	PASS
20MHz	QPSK	132322/1745	27.82	18.97	8.85	≤13	PASS
	16QAM	132322/1745	28.25	18.47	9.78	≤13	PASS

## 5.5 Frequency Stability

### Ambient condition

Temperature	Relative humidity	Pressure
23°C ~25°C	45%~50%	101.5kPa

### Method of Measurement

#### Frequency Stability (Temperature Variation)

The temperature inside the climate chamber is varied from -35°C to +75°C in 10°C step size.

(1) With all power removed, the temperature was decreased to -10°C and permitted to stabilize for three hours.

(2) Measure the carrier frequency with the test equipment in a “call mode”. These measurements should be made within 1 minute of powering up the mobile station, to prevent significant self warming.

(3) Repeat the above measurements at 10°C increments from -35°C to +75°C. Allow at least 1.5 hours at each temperature, un-powered, before making measurements.

#### Frequency Stability (Voltage Variation)

The frequency stability shall be measured with variation of primary supply voltage as follows:

**Primary Supply Voltage:** The primary supply voltage is varied from 85% to 115% of the nominal value for non hand-carried battery and AC powered equipment. For hand-carried, battery-powered equipment, primary supply voltage is reduced to the battery operating end point which shall be specified by the manufacturer.

This transceiver is specified to operate with an input voltage of between 2.2V and 4.35 V, with a nominal voltage of 3.3V.

### Test setup

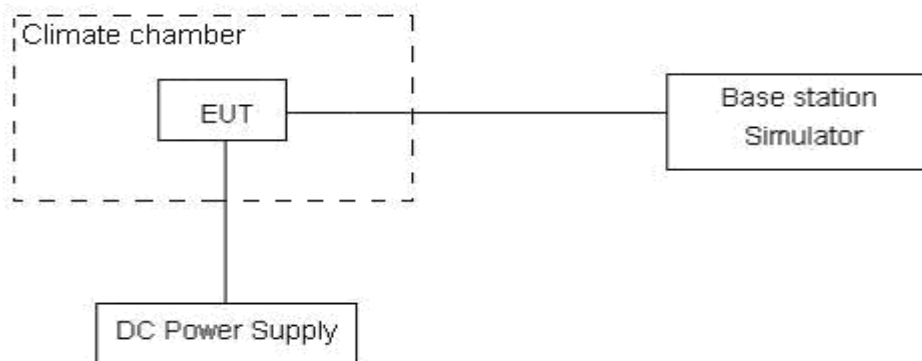

### Limits

The frequency stability shall be sufficient to ensure that the fundamental emissions stay within the authorized bands of operation.

### Measurement Uncertainty

The assessed measurement uncertainty to ensure 99.75% confidence level for the normal distribution is with the coverage factor  $k = 3, U=0.01\text{ppm}$ .

**Test Result**

LTE eMTC Band 4						
Condition		Freq.Error (Hz)	Freq.Error (Hz)	Frequency Stability (ppm)	Frequency Stability (ppm)	Verdict
BANDWIDTH	1.4MHz					
Temperature	Voltage	16QAM	QPSK	16QAM	QPSK	
Normal (25°C)	Normal	5.85	12.77	0.00337	0.00737	PASS
Extreme (75°C)		11.94	16.39	0.00689	0.00946	PASS
Extreme (70°C)		12.23	10.20	0.00706	0.00589	PASS
Extreme (60°C)		7.71	16.19	0.00445	0.00935	PASS
Extreme (50°C)		16.17	14.58	0.00933	0.00841	PASS
Extreme (40°C)		14.54	11.41	0.00839	0.00658	PASS
Extreme (30°C)		9.77	13.26	0.00564	0.00765	PASS
Extreme (20°C)		4.83	11.07	0.00279	0.00639	PASS
Extreme (10°C)		5.88	16.75	0.00340	0.00967	PASS
Extreme (0°C)		3.03	7.94	0.00175	0.00458	PASS
Extreme (-10°C)		7.87	8.31	0.00454	0.00480	PASS
Extreme (-20°C)		5.02	7.26	0.00290	0.00419	PASS
Extreme (-30°C)		6.83	5.50	0.00394	0.00317	PASS
Extreme (-35°C)			10.13	8.37	0.00584	0.00483
25°C	LV	10.52	6.25	0.00607	0.00361	PASS
	HV	10.45	5.57	0.00603	0.00322	PASS
Condition		Freq.Error (Hz)	Freq.Error (Hz)	Frequency Stability (ppm)	Frequency Stability (ppm)	Verdict
BANDWIDTH	3MHz					
Temperature	Voltage	16QAM	QPSK	16QAM	QPSK	
Normal (25°C)	Normal	16.44	11.35	0.00949	0.00655	PASS
Extreme (75°C)		12.97	1.37	0.00748	0.00079	PASS
Extreme (70°C)		5.12	2.29	0.00295	0.00132	PASS
Extreme (60°C)		1.16	2.54	0.00067	0.00146	PASS
Extreme (50°C)		17.20	1.82	0.00993	0.00105	PASS
Extreme (40°C)		2.46	15.90	0.00142	0.00918	PASS
Extreme (30°C)		8.35	15.64	0.00482	0.00903	PASS
Extreme (20°C)		17.53	2.63	0.01012	0.00152	PASS
Extreme (10°C)		15.46	4.93	0.00892	0.00285	PASS
Extreme (0°C)		8.59	1.65	0.00496	0.00095	PASS
Extreme (-10°C)		11.32	3.87	0.00653	0.00223	PASS
Extreme (-20°C)		9.28	3.30	0.00536	0.00190	PASS
Extreme (-30°C)		13.71	3.65	0.00791	0.00210	PASS
Extreme (-35°C)		1.91	15.21	0.00110	0.00878	PASS
25°C	LV	17.20	9.24	0.00993	0.00533	PASS
	HV	2.71	16.40	0.00156	0.00947	PASS
Condition		Freq.Error	Freq.Error	Frequency	Frequency	Verdict

		(Hz)	(Hz)	Stability (ppm)	Stability (ppm)	
BANDWIDTH	5MHz					
Temperature	Voltage	16QAM	QPSK	16QAM	QPSK	
Normal (25°C)	Normal	8.76	3.93	0.00506	0.00227	PASS
Extreme (75°C)		7.90	11.78	0.00456	0.00680	PASS
Extreme (70°C)		5.19	8.13	0.00300	0.00469	PASS
Extreme (60°C)		16.67	1.98	0.00962	0.00114	PASS
Extreme (50°C)		14.64	5.52	0.00845	0.00319	PASS
Extreme (40°C)		1.57	7.73	0.00091	0.00446	PASS
Extreme (30°C)		2.44	10.75	0.00141	0.00620	PASS
Extreme (20°C)		9.64	1.05	0.00556	0.00061	PASS
Extreme (10°C)		9.06	17.27	0.00523	0.00997	PASS
Extreme (0°C)		7.49	17.14	0.00432	0.00989	PASS
Extreme (-10°C)		2.50	13.00	0.00144	0.00750	PASS
Extreme (-20°C)		8.63	6.08	0.00498	0.00351	PASS
Extreme (-30°C)		12.11	9.04	0.00699	0.00522	PASS
Extreme (-35°C)		1.17	3.99	0.00068	0.00230	PASS
25°C		LV	15.73	15.59	0.00908	0.00900
	HV	9.70	5.38	0.00560	0.00310	PASS
Condition		Freq.Error (Hz)	Freq.Error (Hz)	Frequency Stability (ppm)	Frequency Stability (ppm)	Verdict
BANDWIDTH	10MHz					
Temperature	Voltage	16QAM	QPSK	16QAM	QPSK	
Normal (25°C)	Normal	2.23	2.99	0.00129	0.00173	PASS
Extreme (75°C)		3.32	16.49	0.00192	0.00952	PASS
Extreme (70°C)		10.81	16.01	0.00624	0.00924	PASS
Extreme (60°C)		8.79	9.82	0.00508	0.00567	PASS
Extreme (50°C)		10.37	3.47	0.00598	0.00200	PASS
Extreme (40°C)		15.18	7.87	0.00876	0.00454	PASS
Extreme (30°C)		11.51	1.19	0.00664	0.00069	PASS
Extreme (20°C)		9.00	2.44	0.00519	0.00141	PASS
Extreme (10°C)		10.03	6.60	0.00579	0.00381	PASS
Extreme (0°C)		9.88	7.87	0.00570	0.00454	PASS
Extreme (-10°C)		16.36	16.40	0.00944	0.00947	PASS
Extreme (-20°C)		2.61	15.12	0.00151	0.00873	PASS
Extreme (-30°C)		5.70	8.36	0.00329	0.00483	PASS
Extreme (-35°C)		5.78	12.08	0.00334	0.00697	PASS
25°C		LV	11.63	6.36	0.00671	0.00367
	HV	12.08	8.00	0.00697	0.00462	PASS
Condition		Freq.Error (Hz)	Freq.Error (Hz)	Frequency Stability (ppm)	Frequency Stability (ppm)	Verdict
BANDWIDTH	15MHz					



Temperature	Voltage	16QAM	QPSK	16QAM	QPSK	
Normal (25°C)	Normal	11.12	3.01	0.00642	0.00174	PASS
Extreme (75°C)		11.71	5.74	0.00676	0.00331	PASS
Extreme (70°C)		11.49	7.90	0.00663	0.00456	PASS
Extreme (60°C)		17.84	10.75	0.01029	0.00620	PASS
Extreme (50°C)		12.12	3.91	0.00699	0.00226	PASS
Extreme (40°C)		9.54	12.12	0.00551	0.00699	PASS
Extreme (30°C)		15.61	10.21	0.00901	0.00589	PASS
Extreme (20°C)		3.72	17.46	0.00215	0.01008	PASS
Extreme (10°C)		4.27	5.81	0.00247	0.00335	PASS
Extreme (0°C)		16.46	15.29	0.00950	0.00882	PASS
Extreme (-10°C)		11.54	4.79	0.00666	0.00277	PASS
Extreme (-20°C)		14.65	7.35	0.00846	0.00424	PASS
Extreme (-30°C)		4.12	14.00	0.00238	0.00808	PASS
Extreme (-35°C)		14.97	10.30	0.00864	0.00595	PASS
25°C	LV	5.66	1.36	0.00327	0.00079	PASS
	HV	12.65	3.75	0.00730	0.00216	PASS
Condition		Freq.Error (Hz)	Freq.Error (Hz)	Frequency Stability (ppm)	Frequency Stability (ppm)	Verdict
BANDWIDTH	20MHz					
Temperature	Voltage	16QAM	QPSK	16QAM	QPSK	
Normal (25°C)		12.47	4.10	0.00720	0.00237	PASS
Extreme (75°C)		3.02	6.67	0.00175	0.00385	PASS
Extreme (70°C)		2.31	8.53	0.00133	0.00492	PASS
Extreme (60°C)	Normal	1.67	16.73	0.00097	0.00966	PASS
Extreme (50°C)		6.16	3.54	0.00356	0.00204	PASS
Extreme (40°C)		14.12	11.48	0.00815	0.00663	PASS
Extreme (30°C)		2.65	10.23	0.00153	0.00590	PASS
Extreme (20°C)		14.79	13.49	0.00854	0.00779	PASS
Extreme (10°C)		7.34	14.56	0.00423	0.00841	PASS
Extreme (0°C)		4.85	1.16	0.00280	0.00067	PASS
Extreme (-10°C)		6.11	13.13	0.00353	0.00758	PASS
Extreme (-20°C)		10.30	9.27	0.00594	0.00535	PASS
Extreme (-30°C)		6.77	14.45	0.00391	0.00834	PASS
Extreme (-35°C)		2.10	10.93	0.00121	0.00631	PASS
25°C	LV	3.19	15.74	0.00184	0.00909	PASS
	HV	3.29	12.31	0.00190	0.00711	PASS

LTE eMTC Band 12						
Condition		Freq.Error (Hz)	Freq.Error (Hz)	Frequency Stability (ppm)	Frequency Stability (ppm)	Verdict
BANDWIDTH	1.4MHz					
Temperature	Voltage	16QAM	QPSK	16QAM	QPSK	
Normal (25°C)	Normal	16.28	7.14	0.02300	0.01009	PASS
Extreme (75°C)		11.12	14.47	0.01571	0.02045	PASS
Extreme (70°C)		5.25	1.70	0.00741	0.00240	PASS
Extreme (60°C)		12.24	4.01	0.01730	0.00566	PASS
Extreme (50°C)		15.70	13.04	0.02219	0.01843	PASS
Extreme (40°C)		10.90	9.34	0.01541	0.01320	PASS
Extreme (30°C)		9.74	2.13	0.01376	0.00302	PASS
Extreme (20°C)		13.91	6.76	0.01967	0.00956	PASS
Extreme (10°C)		17.91	7.01	0.02531	0.00990	PASS
Extreme (0°C)		1.89	7.87	0.00267	0.01112	PASS
Extreme (-10°C)		7.49	15.42	0.01059	0.02179	PASS
Extreme (-20°C)		15.37	9.25	0.02173	0.01308	PASS
Extreme (-30°C)		7.91	4.10	0.01118	0.00580	PASS
Extreme (-35°C)		1.71	16.71	0.00242	0.02361	PASS
25°C		LV	14.24	16.94	0.02012	0.02395
	HV	14.02	11.83	0.01981	0.01672	PASS
Condition		Freq.Error (Hz)	Freq.Error (Hz)	Frequency Stability (ppm)	Frequency Stability (ppm)	Verdict
BANDWIDTH	3MHz					
Temperature	Voltage	16QAM	QPSK	16QAM	QPSK	
Normal (25°C)	Normal	16.15	9.41	0.02283	0.01330	PASS
Extreme (75°C)		12.53	14.47	0.01771	0.02045	PASS
Extreme (70°C)		14.74	4.20	0.02083	0.00594	PASS
Extreme (60°C)		7.35	13.63	0.01039	0.01926	PASS
Extreme (50°C)		11.61	12.01	0.01640	0.01697	PASS
Extreme (40°C)		7.27	1.79	0.01027	0.00253	PASS
Extreme (30°C)		13.43	13.96	0.01899	0.01973	PASS
Extreme (20°C)		10.15	13.58	0.01435	0.01920	PASS
Extreme (10°C)		14.81	9.66	0.02093	0.01365	PASS
Extreme (0°C)		3.24	14.59	0.00458	0.02062	PASS
Extreme (-10°C)		9.44	16.18	0.01334	0.02287	PASS
Extreme (-20°C)		14.40	6.77	0.02036	0.00957	PASS
Extreme (-30°C)		11.57	10.94	0.01636	0.01547	PASS
Extreme (-35°C)		6.45	2.58	0.00912	0.00364	PASS
25°C		LV	11.02	16.66	0.01557	0.02355
	HV	14.49	8.43	0.02049	0.01191	PASS
Condition		Freq.Error	Freq.Error	Frequency	Frequency	Verdict

		(Hz)	(Hz)	Stability (ppm)	Stability (ppm)	
BANDWIDTH	5MHz					
Temperature	Voltage	16QAM	QPSK	16QAM	QPSK	
Normal (25°C)	Normal	10.32	2.74	0.01458	0.00387	PASS
Extreme (75°C)		2.93	7.51	0.00414	0.01062	PASS
Extreme (70°C)		14.16	16.34	0.02001	0.02310	PASS
Extreme (60°C)		14.75	17.18	0.02085	0.02428	PASS
Extreme (50°C)		10.45	13.70	0.01477	0.01936	PASS
Extreme (40°C)		5.37	9.48	0.00759	0.01339	PASS
Extreme (30°C)		1.51	14.42	0.00213	0.02038	PASS
Extreme (20°C)		1.76	15.10	0.00249	0.02134	PASS
Extreme (10°C)		9.12	15.63	0.01288	0.02209	PASS
Extreme (0°C)		9.64	11.95	0.01362	0.01689	PASS
Extreme (-10°C)		7.56	3.83	0.01068	0.00542	PASS
Extreme (-20°C)		11.38	16.48	0.01608	0.02329	PASS
Extreme (-30°C)		17.32	9.17	0.02448	0.01296	PASS
Extreme (-35°C)		1.37	12.47	0.00193	0.01763	PASS
25°C		LV	5.34	15.50	0.00755	0.02191
	HV	5.72	17.06	0.00809	0.02411	PASS
Condition		Freq.Error (Hz)	Freq.Error (Hz)	Frequency Stability (ppm)	Frequency Stability (ppm)	Verdict
BANDWIDTH	10MHz					
Temperature	Voltage	16QAM	QPSK	16QAM	QPSK	
Normal (25°C)	Normal	5.92	15.90	0.00836	0.02248	PASS
Extreme (75°C)		1.52	13.10	0.00215	0.01851	PASS
Extreme (70°C)		14.62	3.00	0.02066	0.00425	PASS
Extreme (60°C)		12.04	2.21	0.01701	0.00312	PASS
Extreme (50°C)		14.53	3.05	0.02054	0.00431	PASS
Extreme (40°C)		17.02	6.96	0.02406	0.00984	PASS
Extreme (30°C)		7.21	11.00	0.01018	0.01555	PASS
Extreme (20°C)		10.95	3.57	0.01548	0.00504	PASS
Extreme (10°C)		10.10	6.51	0.01428	0.00920	PASS
Extreme (0°C)		14.90	4.08	0.02107	0.00577	PASS
Extreme (-10°C)		10.45	7.36	0.01477	0.01040	PASS
Extreme (-20°C)		6.72	14.96	0.00950	0.02115	PASS
Extreme (-30°C)		3.36	13.58	0.00475	0.01919	PASS
Extreme (-35°C)		8.00	8.10	0.01130	0.01145	PASS
25°C		LV	12.40	4.15	0.01753	0.00587
	HV	11.60	3.05	0.01639	0.00430	PASS

LTE eMTC Band 13						
Condition		Freq.Error (Hz)	Freq.Error (Hz)	Frequency Stability (ppm)	Frequency Stability (ppm)	Verdict
BANDWIDTH	5MHz					
Temperature	Voltage	16QAM	QPSK	16QAM	QPSK	
Normal (25°C)	Normal	4.98	2.16	0.00636	0.00115	PASS
Extreme (75°C)		6.61	10.04	0.00846	0.00534	PASS
Extreme (70°C)		2.14	15.80	0.00273	0.00840	PASS
Extreme (60°C)		2.61	4.19	0.00334	0.00223	PASS
Extreme (50°C)		1.62	15.21	0.00207	0.00809	PASS
Extreme (40°C)		3.13	2.35	0.00400	0.00125	PASS
Extreme (30°C)		3.51	4.67	0.00449	0.00248	PASS
Extreme (20°C)		5.66	4.57	0.00724	0.00243	PASS
Extreme (10°C)		2.80	6.38	0.00359	0.00339	PASS
Extreme (0°C)		13.62	11.30	0.01742	0.00601	PASS
Extreme (-10°C)		9.15	14.89	0.01170	0.00792	PASS
Extreme (-20°C)		5.71	6.58	0.00731	0.00350	PASS
Extreme (-30°C)		10.94	13.39	0.01400	0.00712	PASS
Extreme (-35°C)		13.75	6.41	0.01758	0.00341	PASS
25°C		LV	7.34	12.59	0.00939	0.00670
	HV	16.56	1.20	0.02118	0.00064	PASS
Condition		Freq.Error (Hz)	Freq.Error (Hz)	Frequency Stability (ppm)	Frequency Stability (ppm)	Verdict
BANDWIDTH	10MHz					
Temperature	Voltage	16QAM	QPSK	16QAM	QPSK	
Normal (25°C)	Normal	7.76	3.67	0.00992	0.00195	PASS
Extreme (75°C)		3.18	10.13	0.00407	0.00539	PASS
Extreme (70°C)		8.78	11.03	0.01122	0.00587	PASS
Extreme (60°C)		8.79	6.77	0.01124	0.00360	PASS
Extreme (50°C)		3.88	15.09	0.00497	0.00802	PASS
Extreme (40°C)		14.44	8.45	0.01846	0.00449	PASS
Extreme (30°C)		2.87	6.80	0.00367	0.00361	PASS
Extreme (20°C)		4.04	4.84	0.00516	0.00258	PASS
Extreme (10°C)		10.31	11.39	0.01318	0.00606	PASS
Extreme (0°C)		14.51	8.75	0.01855	0.00466	PASS
Extreme (-10°C)		11.03	13.33	0.01410	0.00709	PASS
Extreme (-20°C)		6.74	5.73	0.00861	0.00305	PASS
Extreme (-30°C)		15.25	12.26	0.01950	0.00652	PASS
Extreme (-35°C)		9.62	17.71	0.01230	0.00942	PASS
25°C		LV	6.91	7.40	0.00884	0.00393
	HV	10.76	13.61	0.01377	0.00724	PASS

LTE eMTC Band 66						
Condition		Freq.Error (Hz)	Freq.Error (Hz)	Frequency Stability (ppm)	Frequency Stability (ppm)	Verdict
BANDWIDTH	1.4MHz					
Temperature	Voltage	16QAM	QPSK	16QAM	QPSK	
Normal (25°C)	Normal	2.27	11.39	0.00130	0.00653	PASS
Extreme (75°C)		16.29	12.71	0.00934	0.00729	PASS
Extreme (70°C)		1.79	2.72	0.00103	0.00156	PASS
Extreme (60°C)		10.16	13.90	0.00583	0.00796	PASS
Extreme (50°C)		1.46	5.74	0.00084	0.00329	PASS
Extreme (40°C)		10.20	10.21	0.00584	0.00585	PASS
Extreme (30°C)		17.58	1.07	0.01007	0.00061	PASS
Extreme (20°C)		12.10	10.35	0.00693	0.00593	PASS
Extreme (10°C)		6.51	14.97	0.00373	0.00858	PASS
Extreme (0°C)		4.82	3.48	0.00276	0.00200	PASS
Extreme (-10°C)		16.30	2.30	0.00934	0.00132	PASS
Extreme (-20°C)		15.32	12.90	0.00878	0.00739	PASS
Extreme (-30°C)		11.97	9.04	0.00686	0.00518	PASS
Extreme (-35°C)		4.23	10.31	0.00243	0.00591	PASS
25°C	LV	13.05	2.34	0.00748	0.00134	PASS
	HV	17.15	10.25	0.00983	0.00587	PASS
Condition		Freq.Error (Hz)	Freq.Error (Hz)	Frequency Stability (ppm)	Frequency Stability (ppm)	Verdict
BANDWIDTH	3MHz					
Temperature	Voltage	16QAM	QPSK	16QAM	QPSK	
Normal (25°C)	Normal	2.96	4.12	0.00170	0.00236	PASS
Extreme (75°C)		16.44	15.30	0.00942	0.00877	PASS
Extreme (70°C)		2.29	11.70	0.00131	0.00671	PASS
Extreme (60°C)		2.35	7.10	0.00134	0.00407	PASS
Extreme (50°C)		7.93	3.14	0.00455	0.00180	PASS
Extreme (40°C)		14.13	4.96	0.00810	0.00284	PASS
Extreme (30°C)		14.23	17.77	0.00816	0.01018	PASS
Extreme (20°C)		8.07	8.08	0.00463	0.00463	PASS
Extreme (10°C)		12.66	8.62	0.00725	0.00494	PASS
Extreme (0°C)		4.69	3.43	0.00269	0.00196	PASS
Extreme (-10°C)		7.88	14.73	0.00451	0.00844	PASS
Extreme (-20°C)		2.84	13.30	0.00163	0.00762	PASS
Extreme (-30°C)		11.37	12.82	0.00652	0.00735	PASS
Extreme (-35°C)		8.91	3.92	0.00511	0.00225	PASS
25°C	LV	17.38	2.82	0.00996	0.00161	PASS
	HV	8.85	16.74	0.00507	0.00959	PASS
Condition		Freq.Error (Hz)	Freq.Error (Hz)	Frequency Stability	Frequency Stability	Verdict

BANDWIDTH	5MHz			(ppm)	(ppm)	
Temperature	Voltage	16QAM	QPSK	16QAM	QPSK	
Normal (25°C)	Normal	10.79	5.45	0.00618	0.00312	PASS
Extreme (75°C)		10.85	16.40	0.00622	0.00940	PASS
Extreme (70°C)		6.20	3.75	0.00355	0.00215	PASS
Extreme (60°C)		13.95	15.96	0.00800	0.00915	PASS
Extreme (50°C)		5.26	10.90	0.00301	0.00624	PASS
Extreme (40°C)		17.73	3.23	0.01016	0.00185	PASS
Extreme (30°C)		13.29	9.84	0.00761	0.00564	PASS
Extreme (20°C)		9.01	4.96	0.00516	0.00284	PASS
Extreme (10°C)		3.05	12.47	0.00175	0.00715	PASS
Extreme (0°C)		10.91	15.47	0.00625	0.00886	PASS
Extreme (-10°C)		12.93	11.46	0.00741	0.00657	PASS
Extreme (-20°C)		7.38	2.85	0.00423	0.00163	PASS
Extreme (-30°C)		8.73	12.01	0.00500	0.00688	PASS
Extreme (-35°C)		1.93	14.99	0.00111	0.00859	PASS
25°C		LV	13.46	8.02	0.00771	0.00460
	HV	3.83	1.31	0.00220	0.00075	PASS
Condition		Freq.Error (Hz)	Freq.Error (Hz)	Frequency Stability (ppm)	Frequency Stability (ppm)	Verdict
BANDWIDTH	10MHz					
Temperature	Voltage	16QAM	QPSK	16QAM	QPSK	
Normal (25°C)	Normal	15.47	14.78	0.00887	0.00847	PASS
Extreme (75°C)		8.54	10.02	0.00490	0.00574	PASS
Extreme (70°C)		14.35	17.81	0.00822	0.01021	PASS
Extreme (60°C)		4.37	3.41	0.00251	0.00195	PASS
Extreme (50°C)		3.13	4.06	0.00179	0.00233	PASS
Extreme (40°C)		11.61	13.47	0.00666	0.00772	PASS
Extreme (30°C)		6.21	7.03	0.00356	0.00403	PASS
Extreme (20°C)		10.52	2.12	0.00603	0.00122	PASS
Extreme (10°C)		2.46	6.03	0.00141	0.00346	PASS
Extreme (0°C)		8.58	2.30	0.00492	0.00132	PASS
Extreme (-10°C)		6.48	3.19	0.00371	0.00183	PASS
Extreme (-20°C)		13.91	9.40	0.00797	0.00539	PASS
Extreme (-30°C)		16.95	10.58	0.00972	0.00606	PASS
Extreme (-35°C)		6.44	16.31	0.00369	0.00935	PASS
25°C		LV	6.66	5.56	0.00382	0.00319
	HV	14.78	5.23	0.00847	0.00300	PASS
Condition		Freq.Error (Hz)	Freq.Error (Hz)	Frequency Stability (ppm)	Frequency Stability (ppm)	Verdict
BANDWIDTH	15MHz					
Temperature	Voltage	16QAM	QPSK	16QAM	QPSK	

Normal (25°C)	Normal	8.64	15.39	0.00495	0.00882	PASS	
Extreme (75°C)		4.64	2.85	0.00266	0.00163	PASS	
Extreme (70°C)		14.23	3.27	0.00815	0.00187	PASS	
Extreme (60°C)		7.99	13.11	0.00458	0.00751	PASS	
Extreme (50°C)		17.42	13.86	0.00998	0.00795	PASS	
Extreme (40°C)		9.54	13.93	0.00547	0.00798	PASS	
Extreme (30°C)		10.04	13.03	0.00575	0.00747	PASS	
Extreme (20°C)		9.14	10.71	0.00524	0.00614	PASS	
Extreme (10°C)		12.84	6.79	0.00736	0.00389	PASS	
Extreme (0°C)		14.32	16.94	0.00820	0.00971	PASS	
Extreme (-10°C)		8.00	16.06	0.00458	0.00921	PASS	
Extreme (-20°C)		13.66	8.29	0.00783	0.00475	PASS	
Extreme (-30°C)		9.72	14.31	0.00557	0.00820	PASS	
Extreme (-35°C)		7.00	16.87	0.00401	0.00967	PASS	
25°C	LV	9.29	8.93	0.00533	0.00512	PASS	
	HV	2.96	12.13	0.00169	0.00695	PASS	
Condition		Freq.Error (Hz)	Freq.Error (Hz)	Frequency Stability (ppm)	Frequency Stability (ppm)	Verdict	
BANDWIDTH	20MHz						
Temperature	Voltage	16QAM	QPSK	16QAM	QPSK		
Normal (25°C)		16.09	7.78	0.00922	0.00446		PASS
Extreme (75°C)		1.30	15.24	0.00074	0.00874	PASS	
Extreme (70°C)	Normal	4.76	4.54	0.00273	0.00260	PASS	
Extreme (60°C)		16.15	11.85	0.00925	0.00679	PASS	
Extreme (50°C)		15.85	14.28	0.00908	0.00818	PASS	
Extreme (40°C)		5.96	12.55	0.00341	0.00719	PASS	
Extreme (30°C)		8.76	4.11	0.00502	0.00235	PASS	
Extreme (20°C)		10.91	14.17	0.00625	0.00812	PASS	
Extreme (10°C)		14.87	3.50	0.00852	0.00200	PASS	
Extreme (0°C)		15.45	9.56	0.00885	0.00548	PASS	
Extreme (-10°C)		16.96	1.38	0.00972	0.00079	PASS	
Extreme (-20°C)		9.22	6.39	0.00528	0.00366	PASS	
Extreme (-30°C)		9.57	16.14	0.00548	0.00925	PASS	
Extreme (-35°C)		3.89	11.04	0.00223	0.00633	PASS	
25°C		LV	15.42	10.67	0.00884	0.00612	PASS
		HV	16.06	4.56	0.00921	0.00261	PASS

## 5.6 Spurious Emissions at Antenna Terminals

### Ambient condition

Temperature	Relative humidity	Pressure
23°C ~25°C	45%~50%	101.5kPa

### Method of Measurement

The EUT was connected to Spectrum Analyzer and Base Station Simulator via power Splitter. The measurement is carried out using a spectrum analyzer. The spectrum analyzer scans from 9kHz to the 10th harmonic of the carrier. The peak detector is used.

RBW is set to 100kHz, VBW is set to 300kHz for 30MHz~1GHz

RBW is set to 1MHz, VBW is set to 3MHz for above 1GHz, Sweep is set to ATUO.

RBW is set to 1 kHz (0.009MHz~ 0.15 MHz),

RBW is set to 10 kHz (0.15 MHz~ 30 MHz)

RBW is set to 100 kHz (30MHz~1000 MHz)

RBW is set to 1000 kHz (above 1000MHz)

Of those disturbances below (limit – 20 dB), the mark is not required for the EUT.

The modulation mode and RB allocation refer to section 5.1, using the maximum output power configuration.

### Test setup

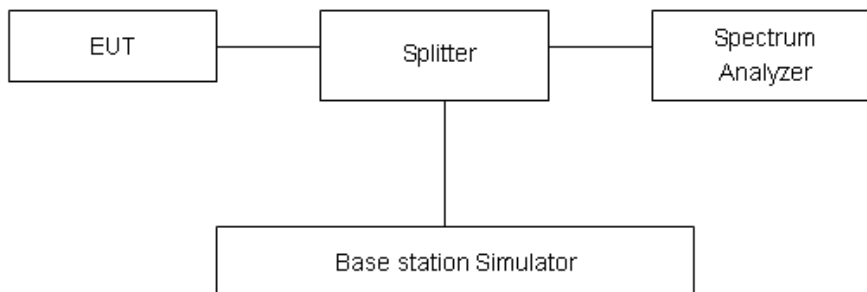

### Limits

Rule Part 27.53(h) specifies that “for operations in the 1695-1710 MHz, 1710-1755 MHz, 1755-1780 MHz, 1915-1920 MHz, 1995-2000 MHz, 2000-2020 MHz, 2110-2155 MHz, 2155-2180 MHz, and 2180-2200 bands, the power of any emission outside a licensee's frequency block shall be attenuated below the transmitter power (P) in watts by at least 43 + 10 log<sub>10</sub> (P) dB..”

Rule Part 27.53 (g) For operations in the 600 MHz band and the 698-746 MHz band, the power of any emission outside a licensee's frequency band(s) of operation shall be attenuated below the transmitter power (P) within the licensed band(s) of operation, measured in watts, by at least 43 + 10 log (P) dB. Compliance with this provision is based on the use of measurement instrumentation employing a resolution bandwidth of 100 kilohertz or greater. However, in the 100 kilohertz bands immediately outside and adjacent to a licensee's frequency block, a resolution bandwidth of at least



30 kHz may be employed.

Rule Part 27.53(f) For operations in the 746-758 MHz, 775-788 MHz, and 805-806 MHz bands, emissions in the band 1559-1610 MHz shall be limited to -70 dBW/MHz equivalent isotropically radiated power (EIRP) for wideband signals, and -80 dBW EIRP for discrete emissions of less than 700 Hz bandwidth. For the purpose of equipment authorization, a transmitter shall be tested with an antenna that is representative of the type that will be used with the equipment in normal operation.

Part 27.53 (c) For operations in the 746-758 MHz band and the 776-788 MHz band, the power of any emission outside the licensee's frequency band(s) of operation shall be attenuated below the transmitter power (P) within the licensed band(s) of operation, measured in watts, in accordance with the following:

- (1) On any frequency outside the 746-758 MHz band, the power of any emission shall be attenuated outside the band below the transmitter power (P) by at least  $43 + 10 \log (P)$  dB;
- (2) On any frequency outside the 776-788 MHz band, the power of any emission shall be attenuated outside the band below the transmitter power (P) by at least  $43 + 10 \log (P)$  dB;
- (3) On all frequencies between 763-775 MHz and 793-805 MHz, by a factor not less than  $76 + 10 \log (P)$  dB in a 6.25 kHz band segment, for base and fixed stations;
- (4) On all frequencies between 763-775 MHz and 793-805 MHz, by a factor not less than  $65 + 10 \log (P)$  dB in a 6.25 kHz band segment, for mobile and portable stations;
- (5) Compliance with the provisions of paragraphs (c)(1) and (c)(2) of this section is based on the use of measurement instrumentation employing a resolution bandwidth of 100 kHz or greater. However, in the 100 kHz bands immediately outside and adjacent to the frequency block, a resolution bandwidth of at least 30 kHz may be employed;

Part 27.53(a)/(h)/(g) Limit		-13 dBm
Part 27.53(f) Limit	Limit out of the band 1559-1610 MHz	-13 dBm
	Limit in the band 1559-1610 MHz	-40 dBm

**Measurement Uncertainty**

The assessed measurement uncertainty to ensure 99.75% confidence level for the normal distribution is with the coverage factor  $k = 1.96$ .

Frequency	Uncertainty
9kHz-1GHz	0.684 dB
1GHz-27GHz	1.407 dB

Test Result

Sweep the whole frequency band through the range from 9kHz to the 10th harmonic of the carrier, the emissions more than 20 dB below the limit are not reported.

The signal beyond the limit is carrier.

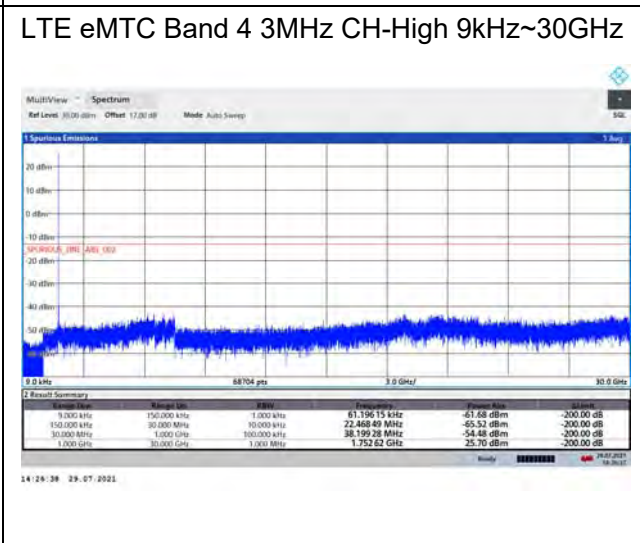
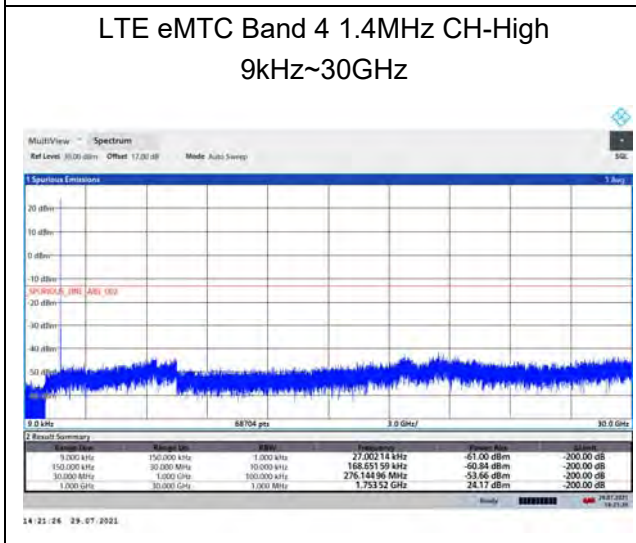
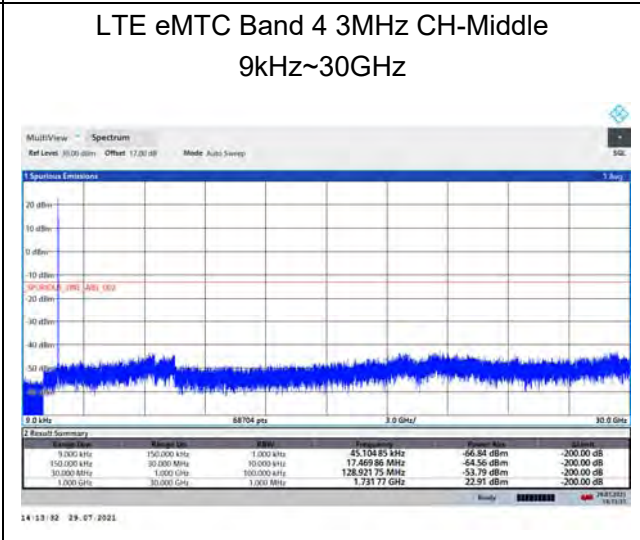
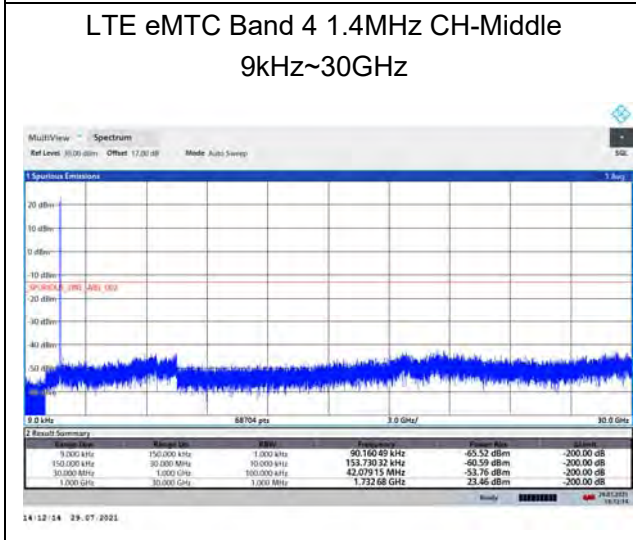
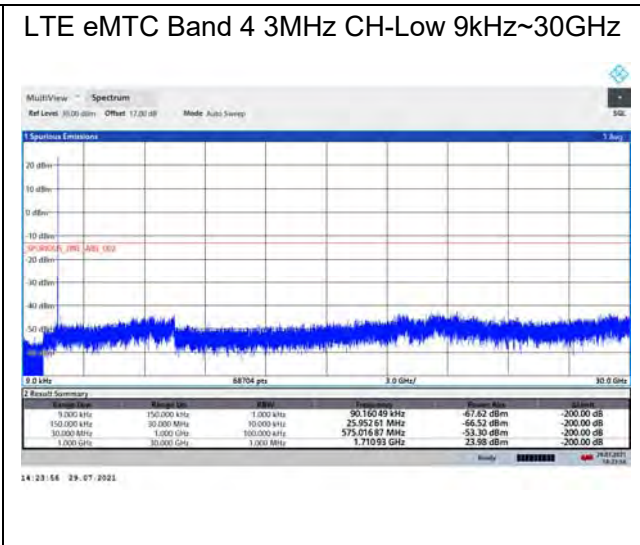
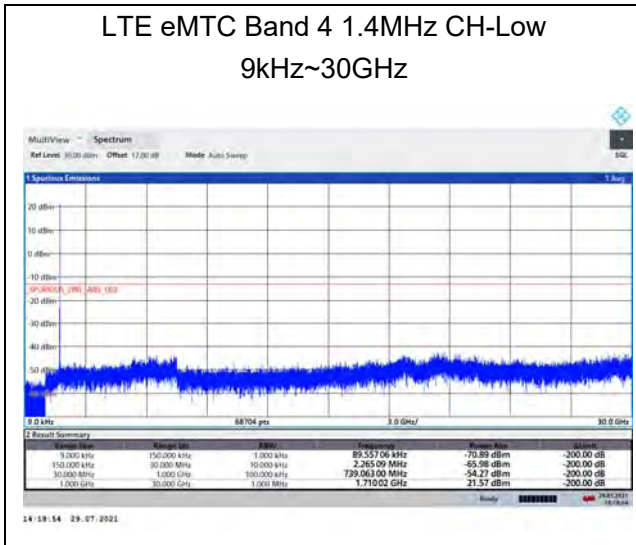

LTE eMTC Band 4 5MHz CH-Low 9kHz~30GHz

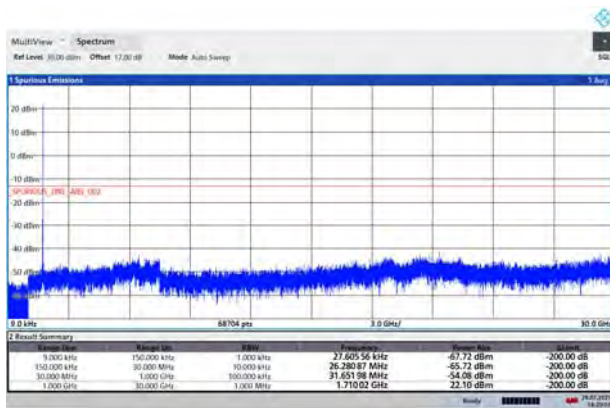

14:29:59 29.07.2021

LTE eMTC Band 4 10MHz CH-Low 9kHz~30GHz

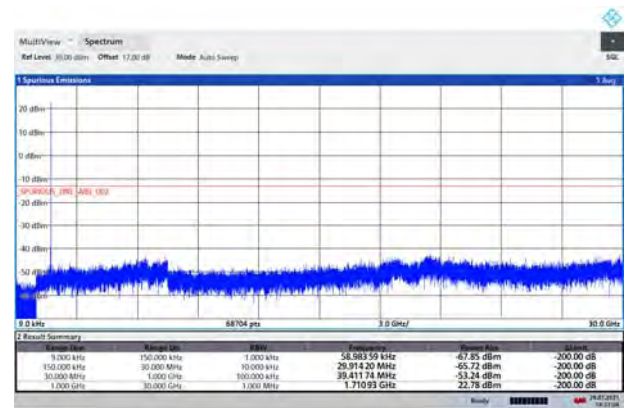

14:31:05 29.07.2021

LTE eMTC Band 4 5MHz CH-Middle 9kHz~30GHz

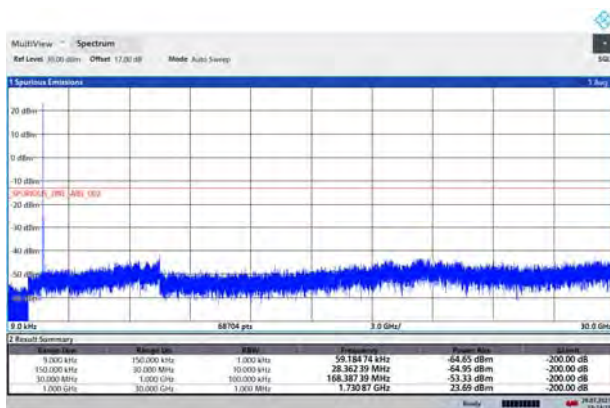

14:34:25 29.07.2021

LTE eMTC Band 4 10MHz CH-Middle 9kHz~30GHz

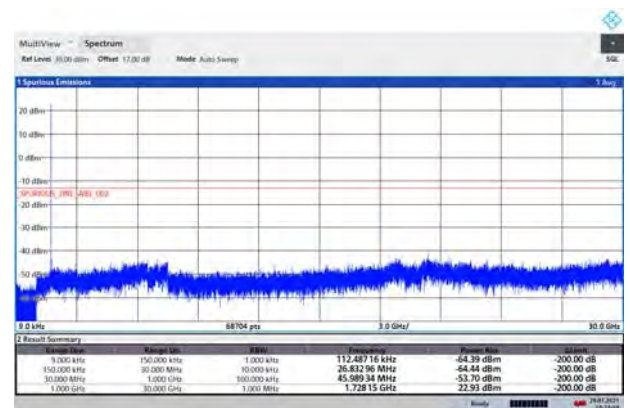

14:34:59 29.07.2021

LTE eMTC Band 4 5MHz CH-High 9kHz~30GHz

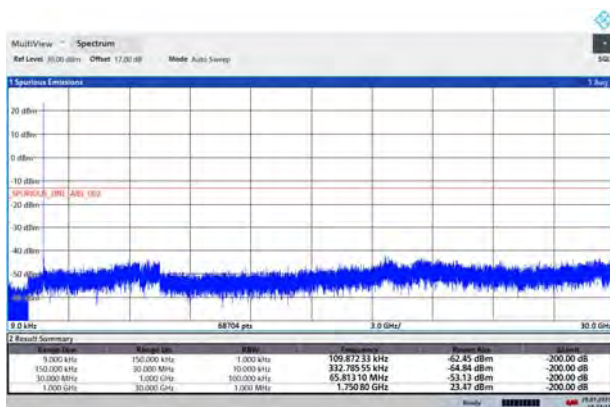

14:34:14 29.07.2021

LTE eMTC Band 4 10MHz CH-High 9kHz~30GHz

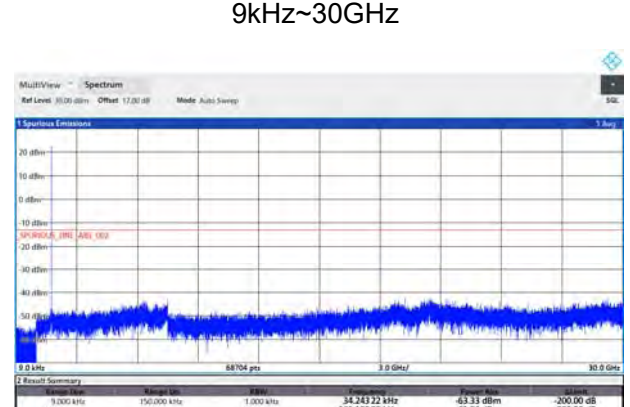

14:39:37 29.07.2021

LTE eMTC Band 4 15MHz CH-Low 9kHz~30GHz

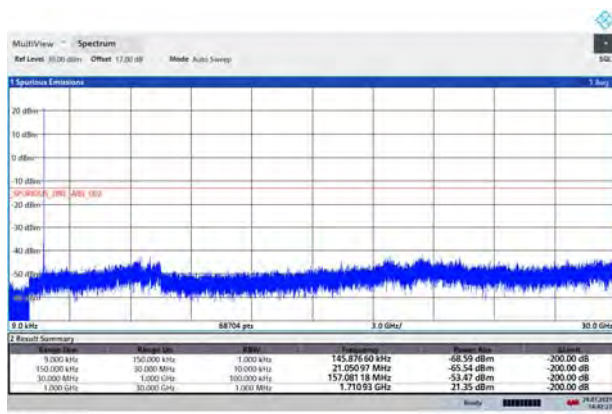

14 42:27 29.07.2021

LTE eMTC Band 4 20MHz CH-Low 9kHz~30GHz

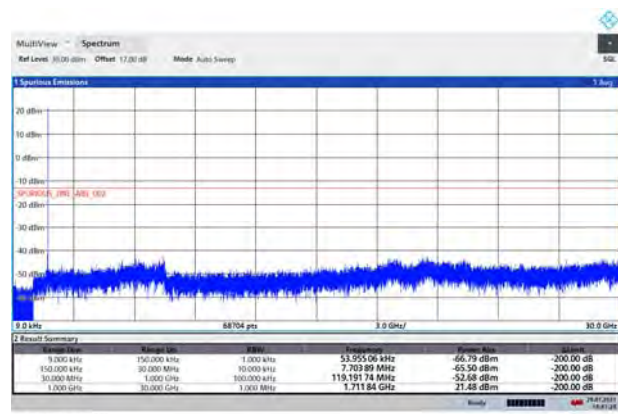

14 41:29 29.07.2021

LTE eMTC Band 4 15MHz CH-Middle 9kHz~30GHz

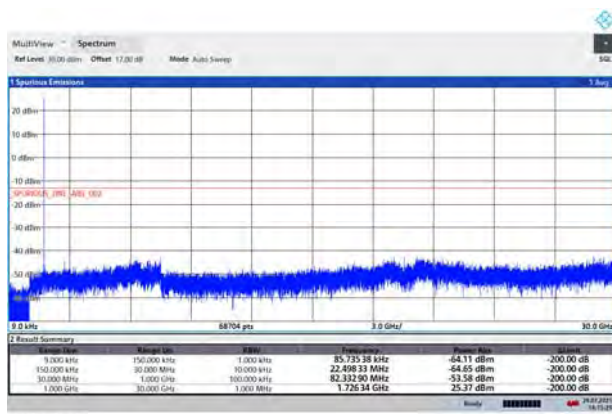

14 15:29 29.07.2021

LTE eMTC Band 4 20MHz CH-Middle 9kHz~30GHz

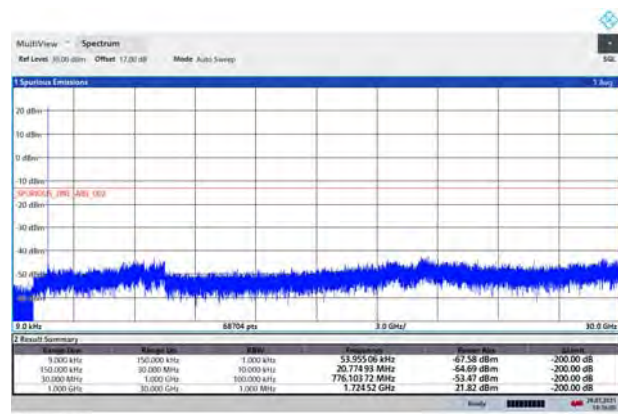

14 14:05 29.07.2021

LTE eMTC Band 4 15MHz CH-High 9kHz~30GHz

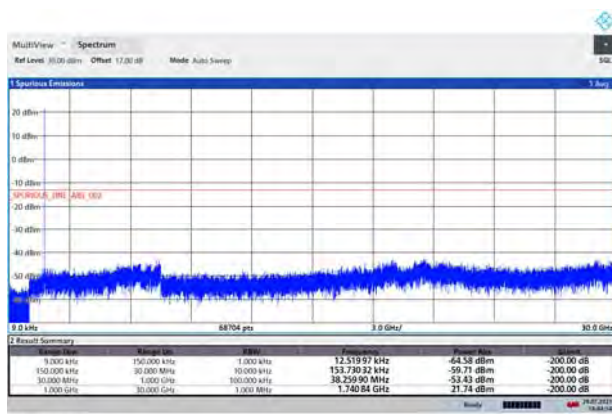

14 44:54 29.07.2021

LTE eMTC Band 4 20MHz CH-High 9kHz~30GHz

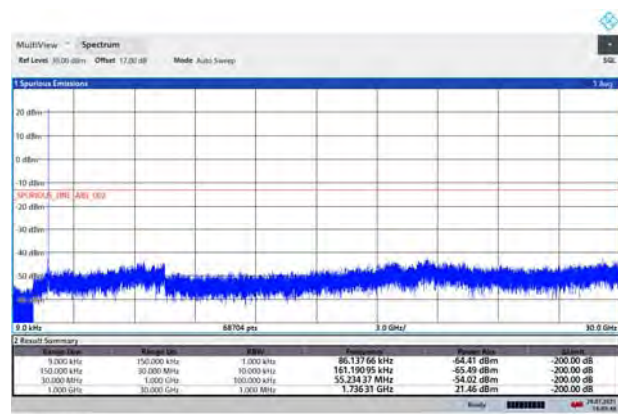

14 49:48 29.07.2021

LTE eMTC Band 12 1.4MHz CH-Low  
9kHz~30GHz

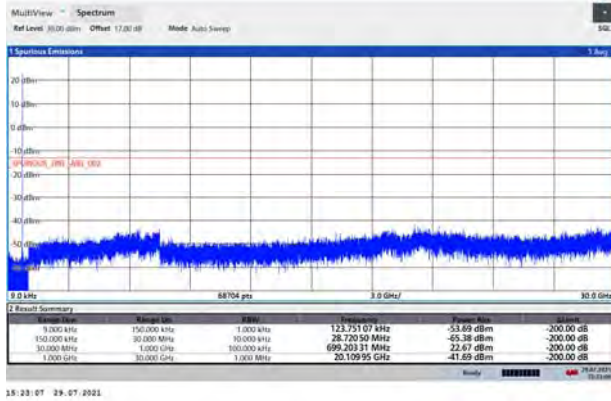

15:23:07 29-07-2021

LTE eMTC Band 12 3MHz CH-Low 9kHz~30GHz

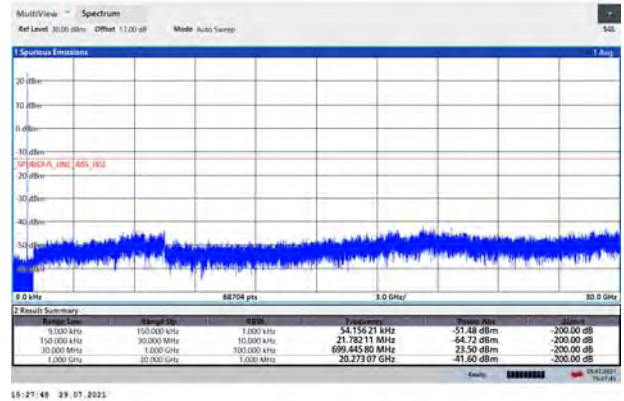

15:27:48 29-07-2021

LTE eMTC Band 12 1.4MHz CH-Middle  
9kHz~30GHz

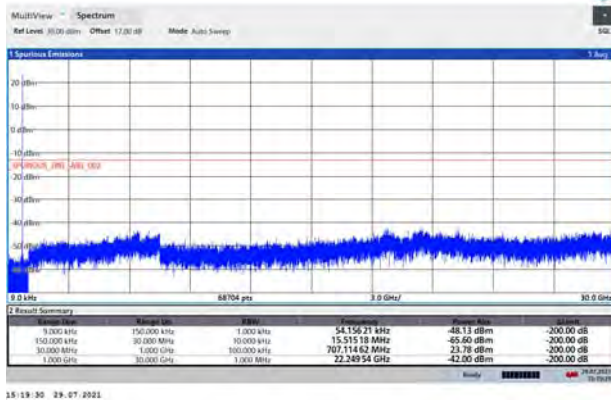

15:19:30 29-07-2021

LTE eMTC Band 12 3MHz CH-Middle  
9kHz~30GHz

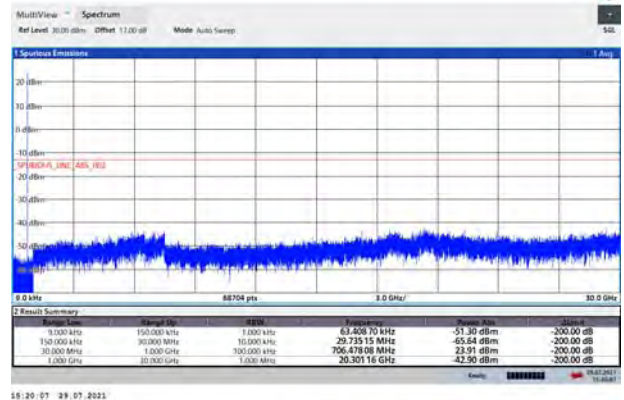

15:20:07 29-07-2021

LTE eMTC Band 12 1.4MHz CH-High  
9kHz~30GHz

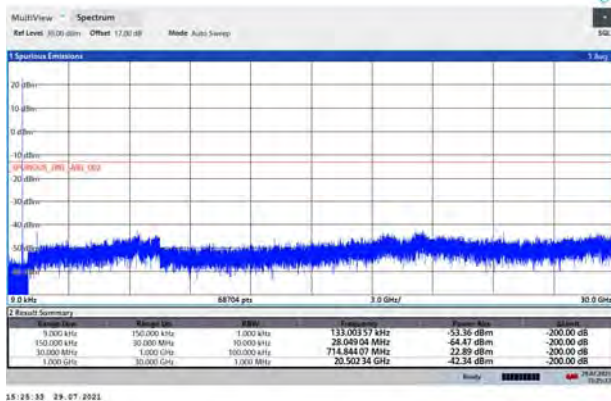

15:26:30 29-07-2021

LTE eMTC Band 12 3MHz CH-High  
9kHz~30GHz

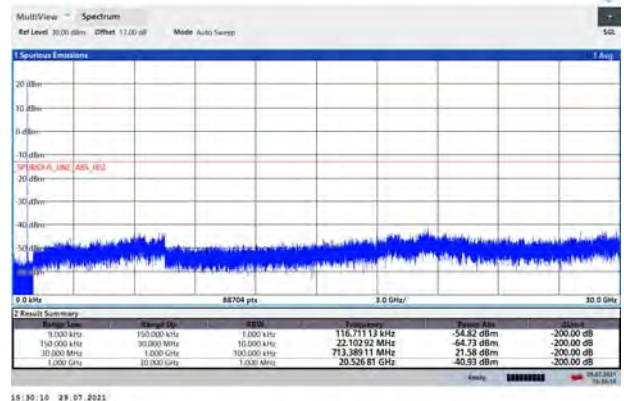

15:30:10 29-07-2021

LTE eMTC Band 12 5MHz CH-Low 9kHz~30GHz

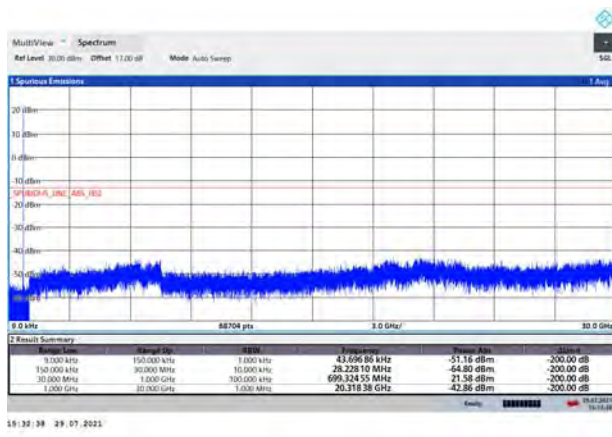

LTE eMTC Band 12 10MHz CH-Low 9kHz~30GHz

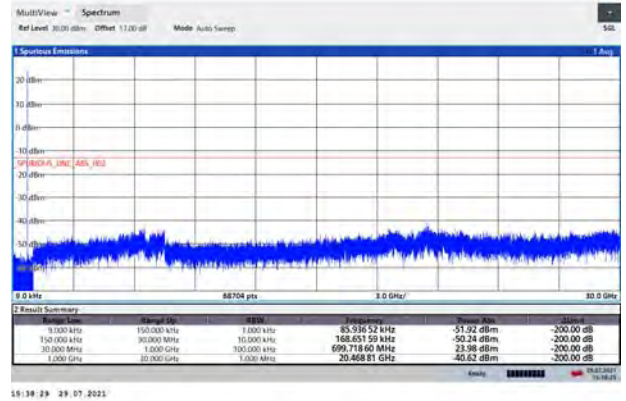

LTE eMTC Band 12 5MHz CH-Middle 9kHz~30GHz

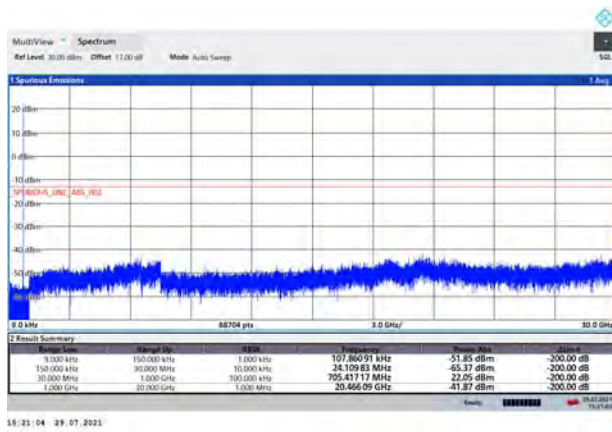

LTE eMTC Band 12 10MHz CH-Middle 9kHz~30GHz

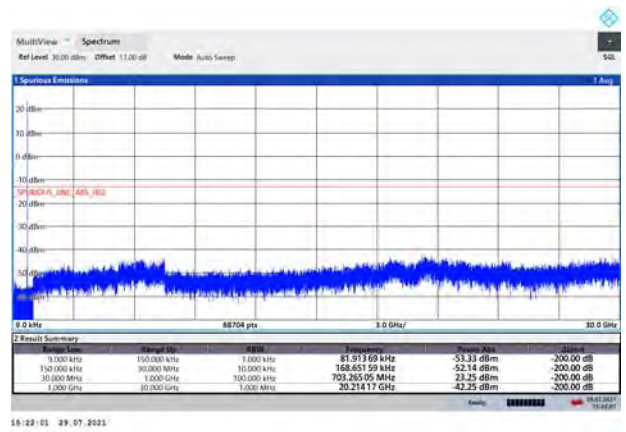

LTE eMTC Band 12 5MHz CH-High 9kHz~30GHz

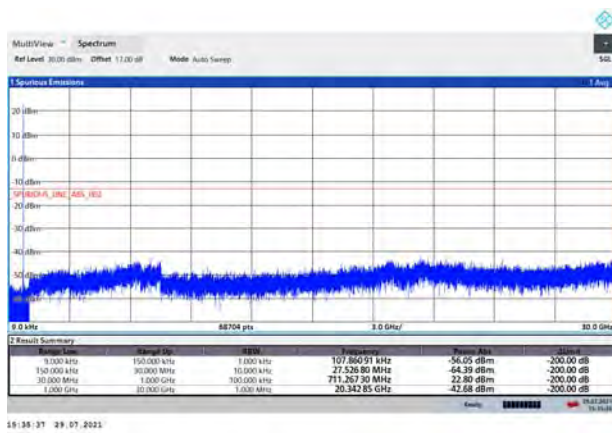

LTE eMTC Band 12 10MHz CH-High 9kHz~30GHz

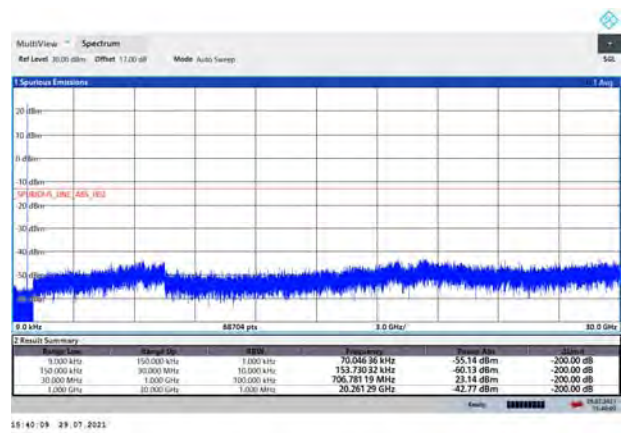

LTE eMTC Band 13 5MHz CH-Low  
9kHz~12.75GHz

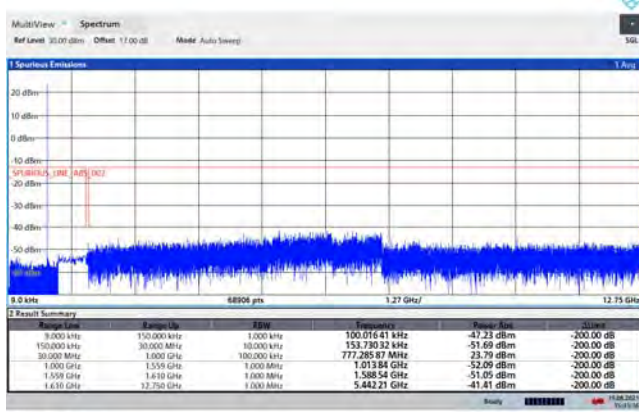

15:33:17 19. 08. 2021

LTE eMTC Band 13 5MHz CH-Middle  
9kHz~12.75GHz

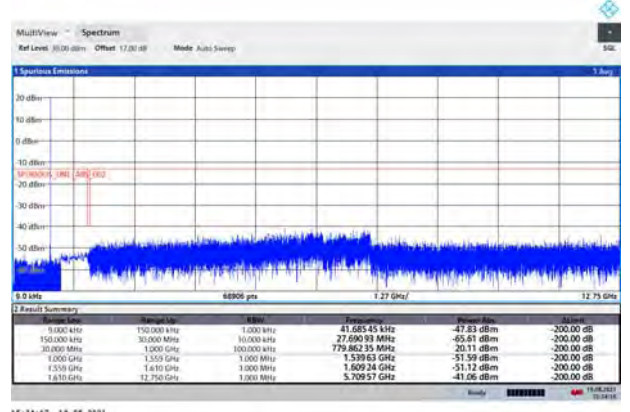

15:34:17 19. 08. 2021

LTE eMTC Band 13 5MHz CH-High  
9kHz~12.75GHz

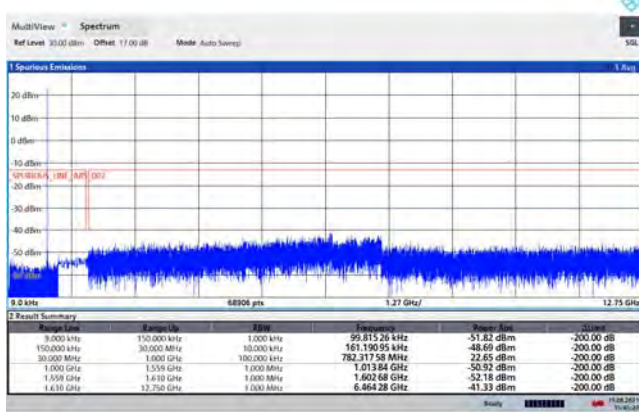

15:43:23 19. 08. 2021

LTE eMTC Band 13 10MHz  
CH-Middle 9kHz~12.75GHz

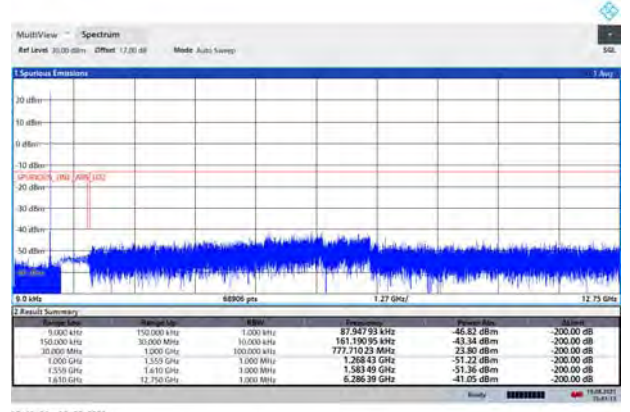

15:41:14 19. 08. 2021

LTE eMTC Band 66 1.4MHz CH-Low  
9kHz~30GHz

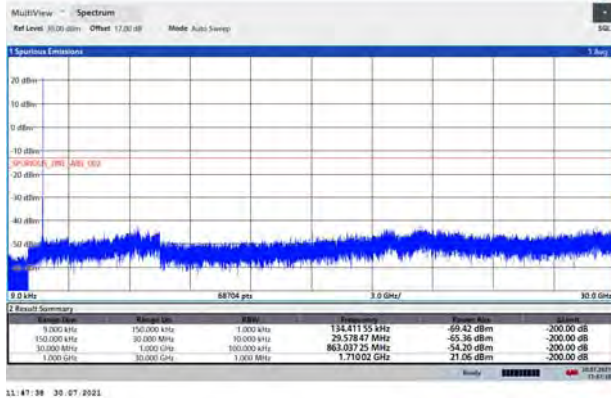

11:47:38 30-07-2021

LTE eMTC Band 66 3MHz CH-Low 9kHz~30GHz

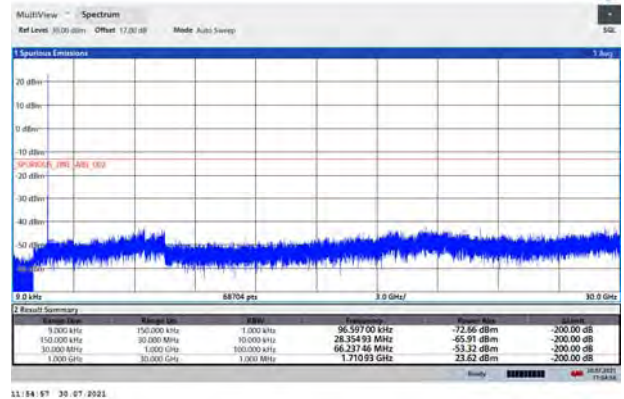

11:54:57 30-07-2021

LTE eMTC Band 66 1.4MHz CH-Middle  
9kHz~30GHz

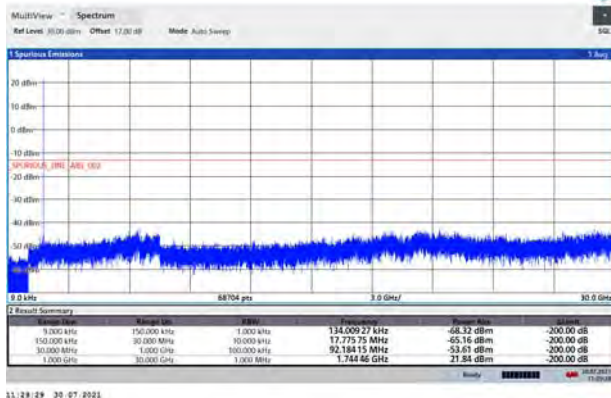

11:28:29 30-07-2021

LTE eMTC Band 66 3MHz CH-Middle  
9kHz~30GHz

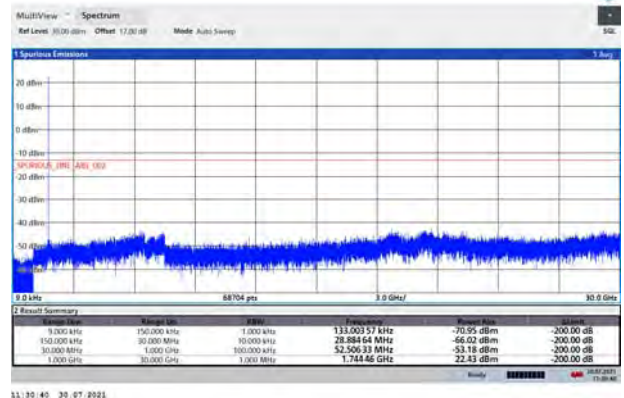

11:30:40 30-07-2021

LTE eMTC Band 66 1.4MHz CH-High  
9kHz~30GHz

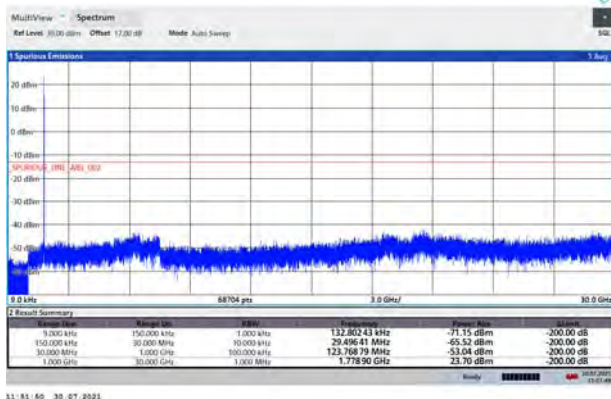

11:51:50 30-07-2021

LTE eMTC Band 66 3MHz CH-High  
9kHz~30GHz

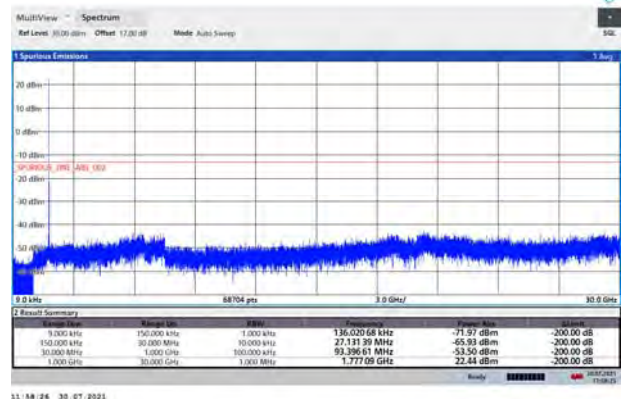

11:54:24 30-07-2021



LTE eMTC Band 66 5MHz CH-Low 9kHz~30GHz

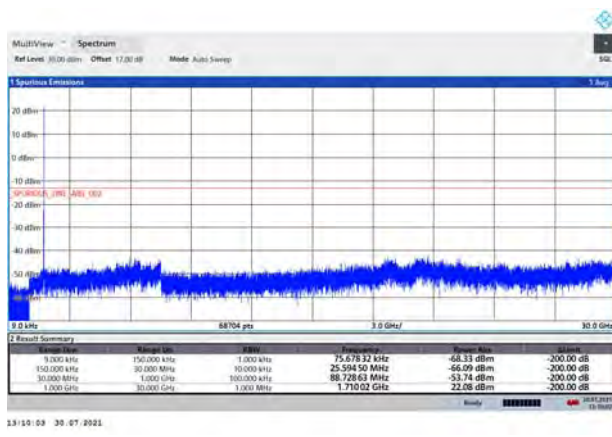

13:14:03 30 07 2021

LTE eMTC Band 66 10MHz CH-Low 9kHz~30GHz

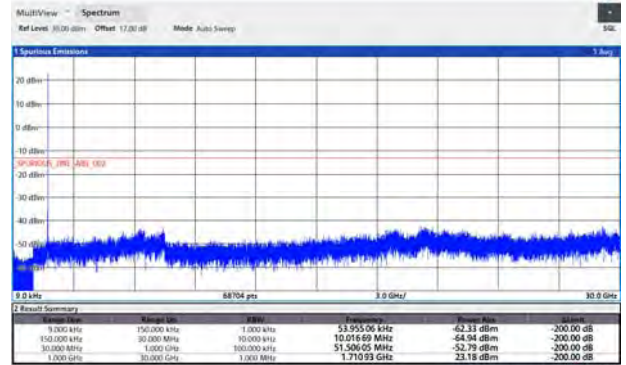

13:17:02 30 07 2021

LTE eMTC Band 66 5MHz CH-Middle 9kHz~30GHz

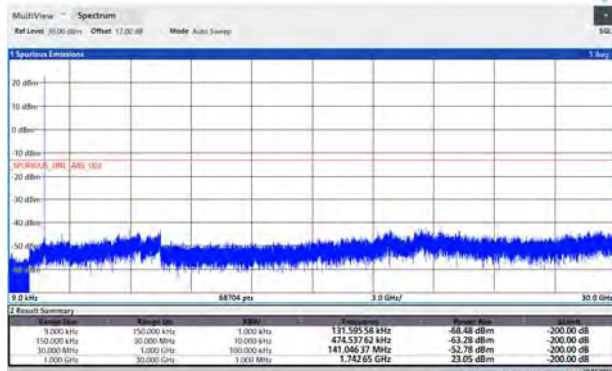

11:31:22 30 07 2021

LTE eMTC Band 66 10MHz CH-Middle 9kHz~30GHz

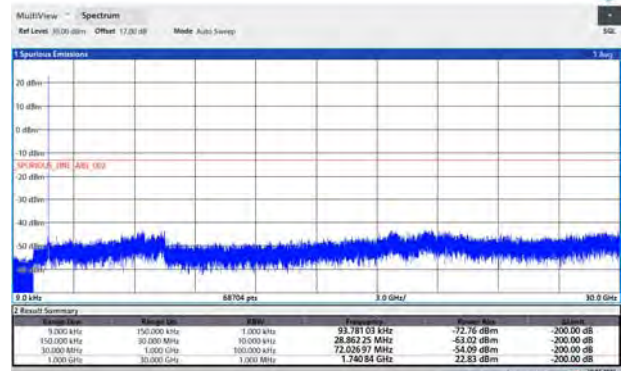

11:32:16 30 07 2021

LTE eMTC Band 66 5MHz CH-High 9kHz~30GHz

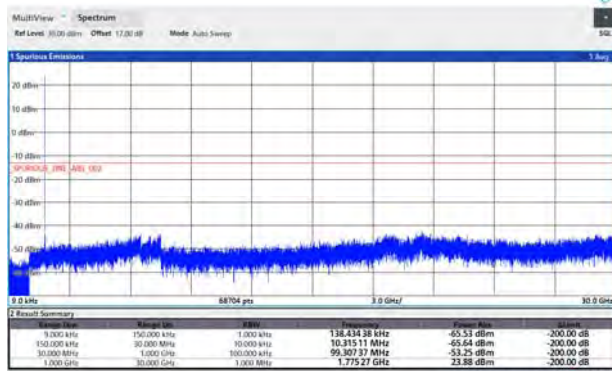

13:13:29 30 07 2021

LTE eMTC Band 66 10MHz CH-High 9kHz~30GHz

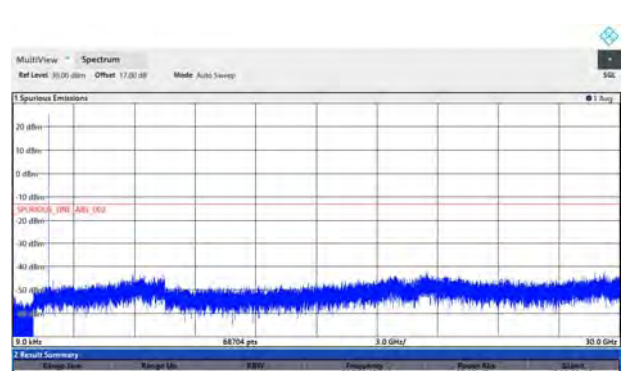

13:21:30 30 07 2021

LTE eMTC Band 66 15MHz CH-Low  
9kHz~30GHz

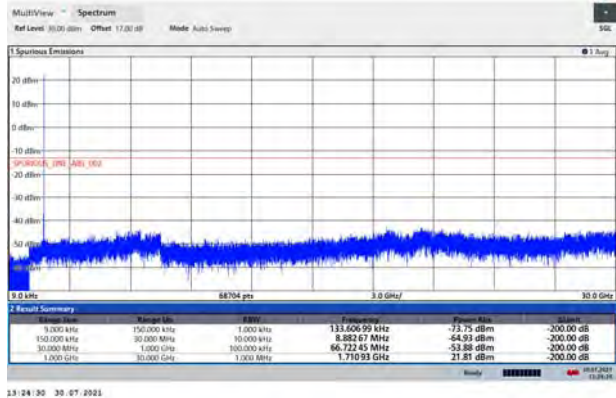

LTE eMTC Band 66 20MHz CH-Low  
9kHz~30GHz

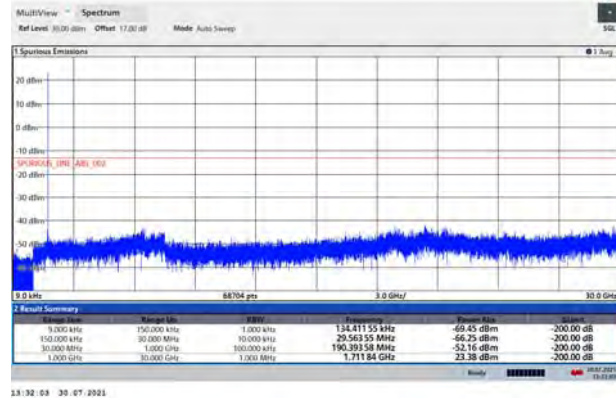

LTE eMTC Band 66 15MHz CH-Middle  
9kHz~30GHz

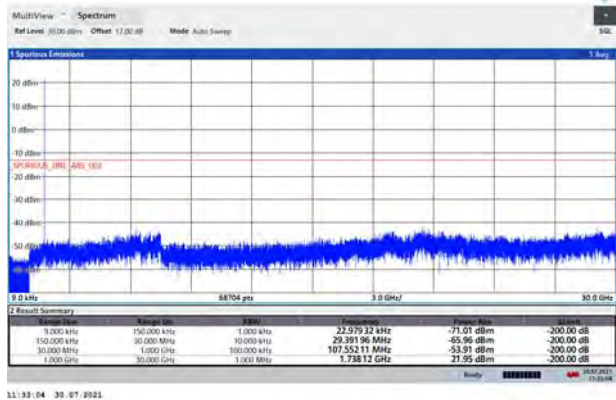

LTE eMTC Band 66 20MHz CH-Middle  
9kHz~30GHz

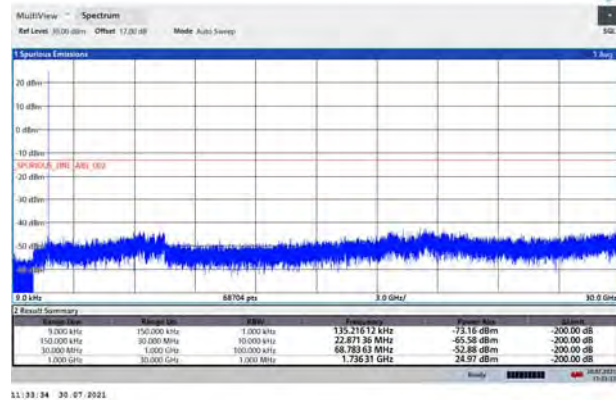

LTE eMTC Band 66 15MHz CH-High  
9kHz~30GHz

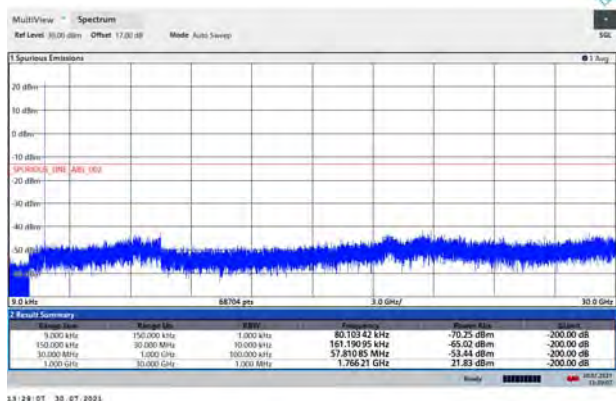

LTE eMTC Band 66 20MHz CH-High  
9kHz~30GHz

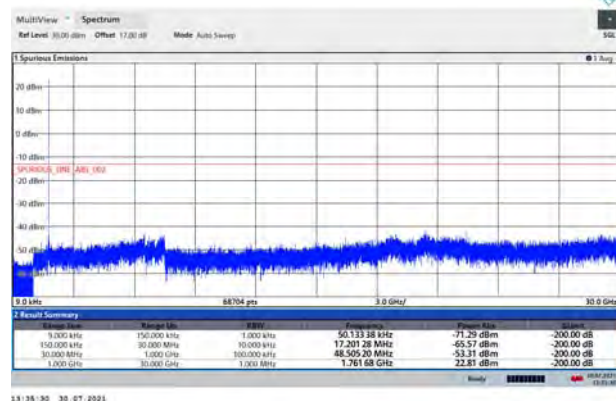

## 5.7 Radiates Spurious Emission

### Ambient condition

Temperature	Relative humidity	Pressure
23°C ~25°C	45%~50%	101.5kPa

### Method of Measurement

- The testing follows FCC KDB 971168 D01 v03r01 Section 5.8 and ANSI C63.26 (2015).
- Below 1GHz: The EUT is placed on a turntable 0.8 meters above the ground in the chamber, 3 meter away from the antenna. The maximal emission value is acquired by adjusting the antenna height, polarisation and turntable azimuth. Normally, the height range of antenna is 1 m to 4 m, the azimuth range of turntable is 0° to 360°, and the receive antenna has two polarizations Vertical (V) and Horizontal (H). Above 1GHz: (Note: the FCC's permission to use 1.5m as an alternative per TCBC Conf call of Dec. 2, 2014.) The EUT is placed on a turntable 1.5 meters above the ground in the chamber, 3 meter away from the antenna. The maximal emission value is acquired by adjusting the antenna height, polarisation and turntable azimuth. Normally, the height range of antenna is 1 m to 4 m, the azimuth range of turntable is 0° to 360°, and the receive antenna has two polarizations Vertical (V) and Horizontal (H).
- A loop antenna, A log-periodic antenna or horn antenna shall be substituted in place of the EUT. The log-periodic antenna will be driven by a signal generator and the level will be adjusted till the same power value on the spectrum analyzer or receiver. The level of the spurious emissions can be calculated through the level of the signal generator, cable loss, the gain of the substitution antenna and the reading of the spectrum analyzer or receiver.
- The EUT is then put into continuously transmitting mode at its maximum power level during the test. Set Test Receiver or Spectrum RBW=100kHz, VBW=300kHz for 30MHz to 1GHz and RBW=1MHz, VBW=3MHz for above 1GHz, and the maximum value of the receiver should be recorded as (Pr).
- The EUT shall be replaced by a substitution antenna. In the chamber, an substitution antenna for the frequency band of interest is placed at the reference point of the chamber. An RF Signal source for the frequency band of interest is connected to the substitution antenna with a cable that has been constructed to not interfere with the radiation pattern of the antenna. A power (PMea) is applied to the input of the substitution antenna, and adjust the level of the signal generator output until the value of the receiver reach the previously recorded (Pr). The power of signal source (PMea) is recorded. The test should be performed by rotating the test item and adjusting the receiving antenna polarization.
- A amplifier should be connected to the Signal Source output port. And the cable should be connect between the Amplifier and the Substitution Antenna. The cable loss (Pcl), the Substitution Antenna Gain (Ga) and the Amplifier Gain (PAg) should be recorded after test.
- The measurement results are obtained as described below:  
 $Power(EIRP) = PMea - PAg - Pcl + Ga$   
 The measurement results are amend as described below:  
 $Power(EIRP) = PMea - Pcl + Ga$
- This value is EIRP since the measurement is calibrated using an antenna of known gain (2.15 dBi) and known input power. ERP can be calculated from EIRP by subtracting the gain of the dipole,  $ERP = EIRP - 2.15dBi$ .

The modulation mode and RB allocation refer to section 5.1, using the maximum output power configuration.

**Test setup**

**9KHz ~ 30MHz**

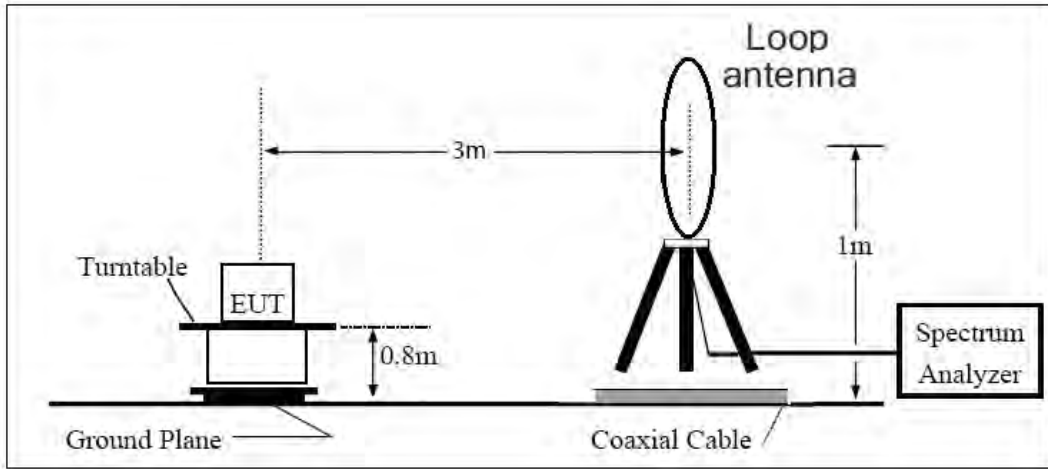

**30MHz ~ 1GHz**

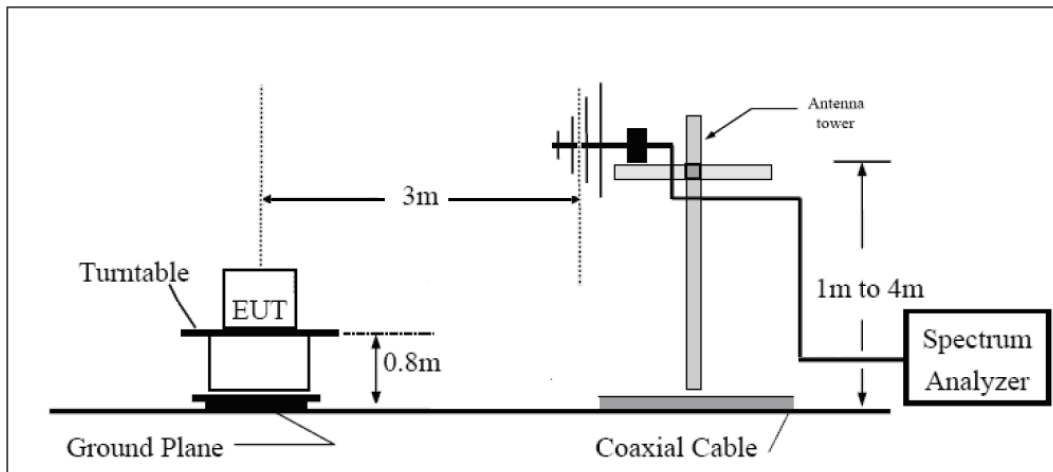

**Above 1GHz**

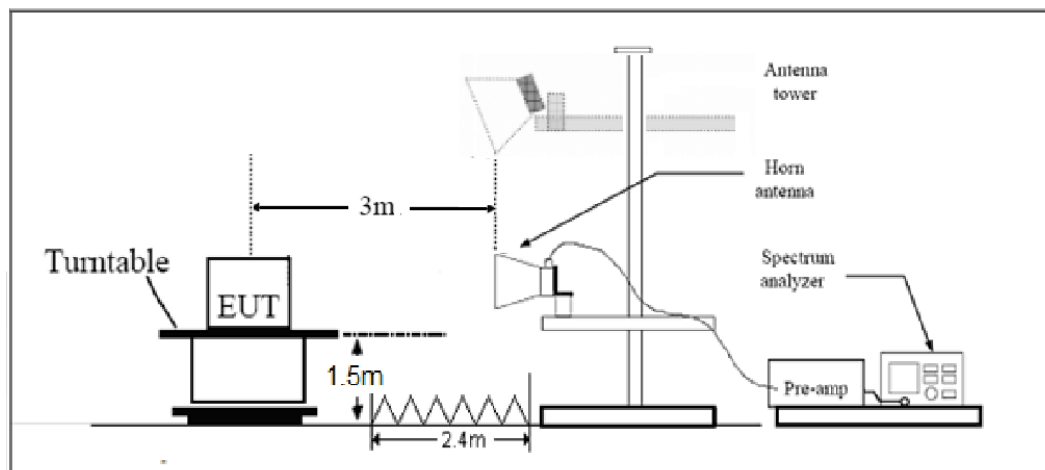

Note: Area side:2.4mX3.6m

**Limits**

Rule Part 27.53(h) specifies that “for operations in the 1695-1710 MHz, 1710-1755 MHz, 1755-1780 MHz, 1915-1920 MHz, 1995-2000 MHz, 2000-2020 MHz, 2110-2155 MHz, 2155-2180 MHz, and 2180-2200 bands, the power of any emission outside a licensee's frequency block shall be attenuated below the transmitter power (P) in watts by at least  $43 + 10 \log_{10}(P)$  dB.”

Rule Part 27.53 (g) For operations in the 600 MHz band and the 698-746 MHz band, the power of any emission outside a licensee's frequency band(s) of operation shall be attenuated below the transmitter power (P) within the licensed band(s) of operation, measured in watts, by at least  $43 + 10 \log(P)$  dB. Compliance with this provision is based on the use of measurement instrumentation employing a resolution bandwidth of 100 kilohertz or greater. However, in the 100 kilohertz bands immediately outside and adjacent to a licensee's frequency block, a resolution bandwidth of at least 30 kHz may be employed.

Rule Part 27.53(f) For operations in the 746-758 MHz, 775-788 MHz, and 805-806 MHz bands, emissions in the band 1559-1610 MHz shall be limited to  $-70$  dBW/MHz equivalent isotropically radiated power (EIRP) for wideband signals, and  $-80$  dBW EIRP for discrete emissions of less than 700 Hz bandwidth. For the purpose of equipment authorization, a transmitter shall be tested with an antenna that is representative of the type that will be used with the equipment in normal operation.

Part 27.53 (c) For operations in the 746-758 MHz band and the 776-788 MHz band, the power of any emission outside the licensee's frequency band(s) of operation shall be attenuated below the transmitter power (P) within the licensed band(s) of operation, measured in watts, in accordance with the following:

- (1) On any frequency outside the 746-758 MHz band, the power of any emission shall be attenuated outside the band below the transmitter power (P) by at least  $43 + 10 \log(P)$  dB;
- (2) On any frequency outside the 776-788 MHz band, the power of any emission shall be attenuated outside the band below the transmitter power (P) by at least  $43 + 10 \log(P)$  dB;
- (3) On all frequencies between 763-775 MHz and 793-805 MHz, by a factor not less than  $76 + 10 \log(P)$  dB in a 6.25 kHz band segment, for base and fixed stations;
- (4) On all frequencies between 763-775 MHz and 793-805 MHz, by a factor not less than  $65 + 10 \log(P)$  dB in a 6.25 kHz band segment, for mobile and portable stations;
- (5) Compliance with the provisions of paragraphs (c)(1) and (c)(2) of this section is based on the use of measurement instrumentation employing a resolution bandwidth of 100 kHz or greater. However, in the 100 kHz bands immediately outside and adjacent to the frequency block, a resolution bandwidth of at least 30 kHz may be employed;

Part 27.53(a)/(h)/(g) Limit		-13 dBm
Part 27.53(f) Limit	Limit out of the band 1559-1610 MHz	-13 dBm
	Limit in the band 1559-1610 MHz	-40 dBm

**Measurement Uncertainty**

The assessed measurement uncertainty to ensure 95% confidence level for the normal distribution is with the coverage factor  $k = \pm 1.96$ ,  $U = \pm 3.55$  dB.

**Test Result**

Sweep the whole frequency band through the range from 9kHz to the 10th harmonic of the carrier, the emissions below the noise floor will not be recorded in the report.

LTE eMTC Band 4 QPSK 1.4MHz CH-Middle, RB 1

Harmonic	Frequency (MHz)	SG (dBm)	Cable Loss (dB)	Gain (dBi)	Antenna Polarization	EIRP Level (dBm)	Limit (dBm)	Margin (dB)	Azimuth (deg)
2	3464.25	-55.36	2.70	12.70	Horizontal	-45.36	-13.00	32.36	45
3	5197.50	-42.06	3.20	12.50	Horizontal	-32.76	-13.00	19.76	270
4	6930.00	-51.69	4.20	11.80	Horizontal	-44.09	-13.00	31.09	90
5	8662.50	-56.06	4.40	12.50	Horizontal	-47.96	-13.00	34.96	135
6	10395.00	-49.83	4.70	11.30	Horizontal	-43.23	-13.00	30.23	90
7	12127.50	-50.85	5.20	13.80	Horizontal	-42.25	-13.00	29.25	0
8	13860.00	-50.23	5.70	11.30	Horizontal	-44.63	-13.00	31.63	90
9	15592.50	-51.38	6.10	16.80	Horizontal	-40.68	-13.00	27.68	180
10	17325.00	-48.44	6.10	14.20	Horizontal	-40.34	-13.00	27.34	180

Note: 1.The other Spurious RF Radiated emissions level is no more than noise floor.  
2. The worst emission was found in the antenna is Horizontal position.

LTE eMTC Band 4 QPSK 5MHz CH-Middle, RB 1

Harmonic	Frequency (MHz)	SG (dBm)	Cable Loss (dB)	Gain (dBi)	Antenna Polarization	EIRP Level (dBm)	Limit (dBm)	Margin (dB)	Azimuth (deg)
2	3460.50	-55.69	2.70	12.70	Horizontal	-45.69	-13.00	32.69	45
3	5191.50	-40.83	3.20	12.50	Horizontal	-31.53	-13.00	18.53	270
4	6930.00	-51.27	4.20	11.80	Horizontal	-43.67	-13.00	30.67	90
5	8662.50	-55.82	4.40	12.50	Horizontal	-47.72	-13.00	34.72	135
6	10395.00	-49.66	4.70	11.30	Horizontal	-43.06	-13.00	30.06	90
7	12127.50	-50.97	5.20	13.80	Horizontal	-42.37	-13.00	29.37	0
8	13860.00	-48.38	5.70	11.30	Horizontal	-42.78	-13.00	29.78	90
9	15592.50	-51.83	6.10	16.80	Horizontal	-41.13	-13.00	28.13	180
10	17325.00	-46.93	6.10	14.20	Horizontal	-38.83	-13.00	25.83	180

Note: 1.The other Spurious RF Radiated emissions level is no more than noise floor.  
2. The worst emission was found in the antenna is Horizontal position.

LTE eMTC Band 4 QPSK 20MHz CH-Middle, RB 1

Harmonic	Frequency (MHz)	SG (dBm)	Cable Loss (dB)	Gain (dBi)	Antenna Polarization	EIRP Level (dBm)	Limit (dBm)	Margin (dB)	Azimuth (deg)
2	3447.75	-56.70	2.70	12.70	Horizontal	-46.70	-13.00	33.70	45
3	5170.88	-41.31	3.20	12.50	Horizontal	-32.01	-13.00	19.01	0
4	6930.00	-52.54	4.20	11.80	Horizontal	-44.94	-13.00	31.94	45
5	8662.50	-55.46	4.40	12.50	Horizontal	-47.36	-13.00	34.36	180
6	10395.00	-50.69	4.70	11.30	Horizontal	-44.09	-13.00	31.09	0
7	12127.50	-50.61	5.20	13.80	Horizontal	-42.01	-13.00	29.01	45
8	13860.00	-49.79	5.70	11.30	Horizontal	-44.19	-13.00	31.19	270
9	15592.50	-52.09	6.10	16.80	Horizontal	-41.39	-13.00	28.39	315
10	17325.00	-41.90	6.10	14.20	Horizontal	-33.80	-13.00	20.80	135

Note: 1.The other Spurious RF Radiated emissions level is no more than noise floor.  
2. The worst emission was found in the antenna is Horizontal position.

LTE eMTC Band 12 QPSK 1.4MHz CH-Middle, RB 1

Harmonic	Frequency (MHz)	SG (dBm)	Cable Loss (dB)	Gain (dBi)	Antenna Polarization	ERP Level (dBm)	Limit (dBm)	Margin (dB)	Azimuth (deg)
2	1415.00	-54.64	1.70	8.70	Horizontal	-49.79	-13.00	36.79	0
3	2122.50	-63.42	2.10	11.10	Horizontal	-56.57	-13.00	43.57	45
4	2830.00	-57.12	2.30	13.10	Horizontal	-48.47	-13.00	35.47	0
5	3537.50	-64.63	2.60	12.70	Horizontal	-56.68	-13.00	43.68	45
6	4245.00	-48.12	3.30	12.50	Horizontal	-41.07	-13.00	28.07	315
7	4952.50	-47.00	3.40	12.50	Horizontal	-40.05	-13.00	27.05	45
8	5660.00	-48.41	3.30	12.50	Horizontal	-41.36	-13.00	28.36	135
9	6367.50	-51.63	3.80	11.50	Horizontal	-46.08	-13.00	33.08	0
10	7075.00	-55.96	4.20	11.80	Horizontal	-50.51	-13.00	37.51	45

Note: 1.The other Spurious RF Radiated emissions level is no more than noise floor.  
2. The worst emission was found in the antenna is Horizontal position.

LTE eMTC Band 12 QPSK 5MHz CH-Middle, RB 1

Harmonic	Frequency (MHz)	SG (dBm)	Cable Loss (dB)	Gain (dBi)	Antenna Polarization	ERP Level (dBm)	Limit (dBm)	Margin (dB)	Azimuth (deg)
2	1410.60	-53.86	1.70	8.70	Horizontal	-49.01	-13.00	36.01	135
3	2115.90	-63.01	2.10	11.10	Horizontal	-56.16	-13.00	43.16	270
4	2821.20	-56.67	2.30	13.10	Horizontal	-48.02	-13.00	35.02	45
5	3512.50	-66.11	2.60	12.70	Horizontal	-58.16	-13.00	45.16	0
6	4215.00	-45.68	3.30	12.50	Horizontal	-38.63	-13.00	25.63	0
7	4917.50	-43.89	3.40	12.50	Horizontal	-36.94	-13.00	23.94	90
8	5620.00	-49.36	3.30	12.50	Horizontal	-42.31	-13.00	29.31	45
9	6322.50	-52.63	3.80	11.50	Horizontal	-47.08	-13.00	34.08	225
10	7025.00	-56.47	4.20	11.80	Horizontal	-51.02	-13.00	38.02	135

Note: 1.The other Spurious RF Radiated emissions level is no more than noise floor.  
 2. The worst emission was found in the antenna is Horizontal position.

LTE eMTC Band 12 QPSK 10MHz CH-Middle, RB 1

Harmonic	Frequency (MHz)	SG (dBm)	Cable Loss (dB)	Gain (dBi)	Antenna Polarization	ERP Level (dBm)	Limit (dBm)	Margin (dB)	Azimuth (deg)
2	1406.40	-52.46	1.70	8.70	Horizontal	-47.61	-13.00	34.61	0
3	2109.60	-62.98	2.10	11.10	Horizontal	-56.13	-13.00	43.13	45
4	2812.80	-57.93	2.30	13.10	Horizontal	-49.28	-13.00	36.28	0
5	3537.50	-64.76	2.60	12.70	Horizontal	-56.81	-13.00	43.81	0
6	4245.00	-47.75	3.30	12.50	Horizontal	-40.70	-13.00	27.70	90
7	4952.50	-44.07	3.40	12.50	Horizontal	-37.12	-13.00	24.12	0
8	5660.00	-49.33	3.30	12.50	Horizontal	-42.28	-13.00	29.28	90
9	6367.50	-54.41	3.80	11.50	Horizontal	-48.86	-13.00	35.86	135
10	7075.00	-56.71	4.20	11.80	Horizontal	-51.26	-13.00	38.26	0

Note: 1.The other Spurious RF Radiated emissions level is no more than noise floor.  
 2. The worst emission was found in the antenna is Horizontal position.



**LTE eMTC Band 13 QPSK 5MHz CH-Middle, RB 1**

Harmonic	Frequency (MHz)	SG (dBm)	Cable Loss (dB)	Gain (dBi)	Antenna Polarization	EIRP Level (dBm)	Limit (dBm)	Margin (dB)	Azimuth (deg)
2	1564.00	-61.18	1.70	8.70	Horizontal	-56.33	-40.00	16.33	45
3	2346.00	-52.33	2.10	12.00	Horizontal	-44.58	-13.00	31.58	0
4	3120.00	-65.12	2.30	13.10	Horizontal	-56.47	-13.00	43.47	0
5	3901.00	-61.32	2.90	12.50	Horizontal	-53.87	-13.00	40.87	135
6	4692.00	-46.93	3.10	12.50	Horizontal	-39.68	-13.00	26.68	45
7	5474.00	-47.48	3.30	12.50	Horizontal	-40.43	-13.00	27.43	90
8	6256.00	-58.33	3.50	12.80	Horizontal	-51.18	-13.00	38.18	90
9	7038.00	-55.46	4.20	11.80	Horizontal	-50.01	-13.00	37.01	315
10	7820.00	-56.79	4.40	12.30	Horizontal	-51.04	-13.00	38.04	90

Note: 1.The other Spurious RF Radiated emissions level is no more than noise floor.  
2. The worst emission was found in the antenna is Horizontal position.

**LTE eMTC Band 13 QPSK 10MHz CH-Middle, RB 1**

Harmonic	Frequency (MHz)	SG (dBm)	Cable Loss (dB)	Gain (dBi)	Antenna Polarization	ERP Level (dBm)	Limit (dBm)	Margin (dB)	Azimuth (deg)
2	1555.25	-61.31	1.70	8.70	Horizontal	-56.46	-13.00	43.46	90
3	2346.00	-60.83	2.10	12.00	Horizontal	-53.08	-13.00	40.08	0
4	3128.00	-63.62	2.30	13.10	Horizontal	-54.97	-13.00	41.97	45
5	3910.00	-60.58	2.90	12.50	Horizontal	-53.13	-13.00	40.13	135
6	4692.00	-49.00	3.10	12.50	Horizontal	-41.75	-13.00	28.75	90
7	5474.00	-47.47	3.30	12.50	Horizontal	-40.42	-13.00	27.42	45
8	6256.00	-58.68	3.50	12.80	Horizontal	-51.53	-13.00	38.53	180
9	7038.00	-56.31	4.20	11.80	Horizontal	-50.86	-13.00	37.86	270
10	7820.00	-57.54	4.40	12.30	Horizontal	-51.79	-13.00	38.79	45

Note: 1.The other Spurious RF Radiated emissions level is no more than noise floor.  
2. The worst emission was found in the antenna is Horizontal position.

LTE eMTC Band 66 QPSK 1.4MHz CH-Middle, RB 1

Harmonic	Frequency (MHz)	SG (dBm)	Cable Loss (dB)	Gain (dBi)	Antenna Polarization	EIRP Level (dBm)	Limit (dBm)	Margin (dB)	Azimuth (deg)
2	3509.25	-57.76	2.70	12.70	Horizontal	-47.76	-13.00	34.76	270
3	5262.50	-43.11	3.20	12.50	Horizontal	-33.81	-13.00	20.81	225
4	7018.00	-51.34	4.20	11.80	Horizontal	-43.74	-13.00	30.74	225
5	8772.50	-54.90	4.40	12.50	Horizontal	-46.80	-13.00	33.80	180
6	10527.00	-50.97	4.70	11.80	Horizontal	-43.87	-13.00	30.87	270
7	12281.50	-50.28	5.20	13.80	Horizontal	-41.68	-13.00	28.68	180
8	14036.00	-50.10	5.70	13.20	Horizontal	-42.60	-13.00	29.60	45
9	15790.50	-53.27	6.10	16.80	Horizontal	-42.57	-13.00	29.57	315
10	17545.00	-48.33	6.10	14.20	Horizontal	-40.23	-13.00	27.23	90

Note: 1.The other Spurious RF Radiated emissions level is no more than noise floor.  
2. The worst emission was found in the antenna is Horizontal position.

LTE eMTC Band 66 QPSK 5MHz CH-Middle, RB 1

Harmonic	Frequency (MHz)	SG (dBm)	Cable Loss (dB)	Gain (dBi)	Antenna Polarization	EIRP Level (dBm)	Limit (dBm)	Margin (dB)	Azimuth (deg)
2	3486.00	-59.42	2.70	12.70	Horizontal	-49.42	-13.00	36.42	315
3	5229.00	-43.49	3.20	12.50	Horizontal	-34.19	-13.00	21.19	315
4	6972.00	-51.34	4.20	11.80	Horizontal	-43.74	-13.00	30.74	90
5	8715.00	-55.62	4.40	12.50	Horizontal	-47.52	-13.00	34.52	0
6	10458.00	-49.91	4.70	11.80	Horizontal	-42.81	-13.00	29.81	225
7	12201.00	-49.91	5.20	13.80	Horizontal	-41.31	-13.00	28.31	225
8	13944.00	-51.37	5.70	13.20	Horizontal	-43.87	-13.00	30.87	270
9	15687.00	-52.10	6.10	16.80	Horizontal	-41.40	-13.00	28.40	135
10	17430.00	-49.41	6.10	14.20	Horizontal	-41.31	-13.00	28.31	225

Note: 1.The other Spurious RF Radiated emissions level is no more than noise floor.  
2. The worst emission was found in the antenna is Horizontal position.

LTE eMTC Band 66 QPSK 20MHz CH-Middle, RB 1

Harmonic	Frequency (MHz)	SG (dBm)	Cable Loss (dB)	Gain (dBi)	Antenna Polarization	EIRP Level (dBm)	Limit (dBm)	Margin (dB)	Azimuth (deg)
2	3472.88	-58.73	2.70	12.70	Horizontal	-48.73	-13.00	35.73	270
3	5209.00	-43.18	3.20	12.50	Horizontal	-33.88	-13.00	20.88	315
4	6945.75	-52.86	4.20	11.80	Horizontal	-45.26	-13.00	32.26	90
5	8682.00	-55.12	4.40	12.50	Horizontal	-47.02	-13.00	34.02	180
6	10418.63	-49.60	4.70	11.80	Horizontal	-42.50	-13.00	29.50	0
7	12455.00	-52.80	5.20	13.80	Horizontal	-44.20	-13.00	31.20	90
8	13891.50	-51.67	5.70	13.20	Horizontal	-44.17	-13.00	31.17	90
9	15627.00	-50.66	6.10	16.80	Horizontal	-39.96	-13.00	26.96	45
10	17364.38	-48.24	6.10	14.20	Horizontal	-40.14	-13.00	27.14	180

Note: 1.The other Spurious RF Radiated emissions level is no more than noise floor.  
2. The worst emission was found in the antenna is Horizontal position.

## 6 Main Test Instruments

Name	Manufacturer	Type	Serial Number	Calibration Date	Expiration Date
Base Station Simulator	R&S	CMW500	113824	2021-05-15	2022-05-14
Power Splitter	Hua Xiang	SHX-GF2-2-13	10120101	/	/
Climate Chamber	Weiss	VT4002	582261194500 10	2021-05-15	2022-05-14
Spectrum Analyzer	Key sight	N9010A	MY50210259	2021-05-15	2022-05-14
Signal Analyzer	R&S	FSV3030	101411	2020-12-13	2021-12-12
Loop Antenna	SCHWARZBECK	FMZB1519	1519-047	2020-04-02	2023-04-01
TRILOG Broadband Antenna	SCHWARZBECK	VULB 9163	391	2019-12-16	2022-12-15
Horn Antenna	R&S	HF907	102723	2018-08-11	2021-08-10
Horn Antenna	ETS-Lindgren	3160-09	00102644	2018-06-20	2023-06-19
Horn Antenna	STEATITE	QSH-SL-26-40-K-15	16779	2019-12-24	2022-12-23
Signal generator	R&S	SMB 100A	102594	2021-05-15	2022-05-14
Climatic Chamber	ESPEC	SU-242	93000506	2020-12-13	2021-12-12
Preamplifier	R&S	SCU18	102327	2021-05-15	2022-05-14
MOB COMMS DC SUPPLY	Keysight	66319D	MY43004105	2021-06-09	2021-12-08
RF Cable	Agilent	SMA 15cm	0001	2021-06-09	2021-12-08
Software	R&S	EMC32	9.26.0	/	/

\*\*\*\*\*END OF REPORT \*\*\*\*\*

## ANNEX A: The EUT Appearance

The EUT Appearance are submitted separately.

## ANNEX B: Test Setup Photos

The Test Setup Photos are submitted separately.

## ANNEX C: Product Change Description

The Product Change Description are submitted separately.