

RF TEST REPORT

Applicant Quectel Wireless Solutions Co., Ltd.
FCC ID XMR2023BG773AGL
Product LTE Module
Brand Quectel
Model BG773A-GL
Report No. R2211A1099-R8
Issue Date March 21, 2023

TA Technology (Shanghai) Co., Ltd. tested the above equipment in accordance with the requirements in **FCC CFR47 Part 2 (2022)/ FCC CFR47 Part 27C (2022)**. The test results show that the equipment tested is capable of demonstrating compliance with the requirements as documented in this report.

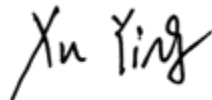

Prepared by: Xu Ying



Approved by: Xu Kai

TA Technology (Shanghai) Co., Ltd.

Building 3, No.145, Jintang Rd, Pudong Shanghai, P.R.China

TEL: +86-021-50791141/2/3

FAX: +86-021-50791141/2/3-8000

TABLE OF CONTENT

1	Test Laboratory.....	5
1.1	Notes of the Test Report.....	5
1.2	Test facility.....	5
1.3	Testing Location.....	5
2	General Description of Equipment under Test.....	6
2.1	Applicant and Manufacturer Information.....	6
2.2	General information.....	6
3	Applied Standards.....	8
4	Test Configuration.....	9
5	Test Case Results.....	11
5.1	RF Power Output and Effective Isotropic Radiated Power.....	11
5.2	Occupied Bandwidth.....	16
5.3	Band Edge Compliance.....	25
5.4	Peak-to-Average Power Ratio (PAPR).....	51
5.5	Frequency Stability.....	54
5.6	Spurious Emissions at Antenna Terminals.....	63
5.7	Radiates Spurious Emission.....	74
6	Main Test Instruments.....	83
	ANNEX A: The EUT Appearance.....	84
	ANNEX B: Test Setup Photos.....	85
	ANNEX C: Product Change Description (Variant 1).....	86
	ANNEX D: Product Change Description (Variant 2).....	87

Summary of Measurement Results

Number	Test Case	Clause in FCC rules	Verdict
1	RF Power Output and Effective Isotropic Radiated Power	2.1046 /27.50(d)(4) /27.50(b)(10) /27.50(c)(10)	PASS
2	Occupied Bandwidth	2.1049	PASS
3	Band Edge Compliance	27.53(h) /27.53(g) /27.53(f) /27.53(c)	PASS
4	Peak-to-Average Power Ratio	27.50(d)/KDB971168 D01(5.7)	PASS
5	Frequency Stability	2.1055 / 27.54	PASS
6	Spurious Emissions at Antenna Terminals	2.1051 /27.53(h) /27.53(g) /27.53(f) /27.53(c)	PASS
7	Radiates Spurious Emission	2.1053 /27.53(h) /27.53(g) /27.53(f) /27.53(c)	PASS
Date of Testing: April 21, 2021 ~ May 14, 2021			
Date of Sample Received: April 16, 2021			
<p>Note: PASS: The EUT complies with the essential requirements in the standard.</p> <p>FAIL: The EUT does not comply with the essential requirements in the standard.</p> <p>All indications of Pass/Fail in this report are opinions expressed by TA Technology (Shanghai) Co., Ltd. based on interpretations and/or observations of test results. Measurement Uncertainties were not taken into account and are published for informational purposes only.</p>			

BG773A-GL (Report No.: R2211A1099-R8) is a variant model (Variant 2) of BG770A-GL (Report No.: R2207A0656-R8V1). This report verifies only the power, the power of new variant are varied due to measurement uncertainty, and sample tolerance of the acceptance range. Test values all duplicated from Original for variant.

The detailed product change description please refers to following table:

Module	BG770A-GL	BG773A-GL
BB Chip	ALT1250	ALT1250
Category	Cat M1 /NB2/GNSS	Cat M1 /NB2/GNSS
Frequency Bands	Cat M1 LTE-HD-FDD: B2/B4/B5 /B12/B13/B25/B26/B66 Cat NB2 LTE-HD-FDD: B2/B4/B5/B12/B13/B17/ B25/B66	Cat M1 LTE-HD-FDD: B2/B4/B5 /B12/B13/B25/B26/B66 Cat NB2 LTE-HD-FDD: B2/B4/B5/B12/B13/B17/ B25/B66
GNSS	GPS, GLONASS	GPS, GLONASS
iSIM	N/A	Supported

The detailed product change description please refers to the *Difference Declaration Letter (Variant 2)*.

BG770A-GL (Report No.: R2207A0656-R8V1) is a variant model (Variant 1) of BG770A-GL (Report No.: R2104A0331-R8). Test values all duplicated from Original for variant. There is no test for variant in this report. BG770A-GL supports from Cat NB1 (3GPP R13) to Cat NB2 (3GPP R14) only by FW updating, the hardware remains the same.

The detailed product change description please refers to following table:

Module	BG770A-GL (Cat NB1)	BG770A-GL (Cat NB2)
Category	Cat M1 & NB1	Cat M1 & NB2
Frequency Bands	Cat M1 LTE-HD-FDD: B2/B4/B5 /B12/B13/B25/B26/B66 Cat NB1 LTE-HD-FDD: B2/B4/B5/B12/B13/B17/ B25/B66	Cat M1 LTE-HD-FDD: B2/B4/B5 /B12/B13/B25/B26/B66 Cat NB2 LTE-HD-FDD: B2/B4/B5/B12/B13/B17/ B25/B66
Others	The same	

The detailed product change description please refers to the *Difference Declaration Letter (Variant 1)*.

1 Test Laboratory

1.1 Notes of the Test Report

This report shall not be reproduced in full or partial, without the written approval of **TA technology (shanghai) co., Ltd.** The results documented in this report apply only to the tested sample, under the conditions and modes of operation as described herein .Measurement Uncertainties were not taken into account and are published for informational purposes only. This report is written to support regulatory compliance of the applicable standards stated above.

1.2. Test facility

FCC (Designation number: CN1179, Test Firm Registration Number: 446626)

TA Technology (Shanghai) Co., Ltd. has been listed on the US Federal Communications Commission list of test facilities recognized to perform measurements.

A2LA (Certificate Number: 3857.01)

TA Technology (Shanghai) Co., Ltd. has been listed by American Association for Laboratory Accreditation to perform measurement.

1.3 Testing Location

Company: TA Technology (Shanghai) Co., Ltd.
Address: Building 3, No.145, Jintang Rd, Pudong Shanghai, P.R.China
City: Shanghai
Post code: 201201
Country: P. R. China
Contact: Xu Kai
Telephone: +86-021-50791141/2/3
Fax: +86-021-50791141/2/3-8000
Website: <http://www.ta-shanghai.com>
E-mail: xukai@ta-shanghai.com

2 General Description of Equipment under Test

2.1 Applicant and Manufacturer Information

Applicant	Quectel Wireless Solutions Co., Ltd
Applicant address	Building 5, Shanghai Business Park Phase III (Area B), No.1016 Tianlin Road, Minhang District, Shanghai, 200233 China
Manufacturer	Quectel Wireless Solutions Co., Ltd
Manufacturer address	Building 5, Shanghai Business Park Phase III (Area B), No.1016 Tianlin Road, Minhang District, Shanghai, 200233 China

2.2 General information

EUT Description			
Model	BG773A-GL		
IMEI	Original: 863593050006733		
Hardware Version	R1.1		
Software Version	BG773AGLAAR02A01		
Power Supply	External power supply		
Antenna Type	External Antenna		
Antenna Gain	Band	Frequency (MHz)	Gain (dBi)
	LTE eMTC Band 4	1700	1.67
		1720	1.94
		1740	2.00
		1760	1.57
	LTE eMTC Band 12	700	1.66
		710	3.26
		720	3.95
	LTE eMTC Band 13	770	3.98
		780	4.45
		790	3.63
	LTE eMTC Band 66	1700	1.67
		1720	1.94
		1740	2.00
		1760	1.57
		1780	0.97
Test Mode(s)	LTE eMTC Band 4/12/13/66		
Test Modulation	QPSK 16QAM		
LTE Category	M1		
Maximum E.I.R.P./ E.R.P.	LTE eMTC Band 4:	25.77dBm	

	LTE eMTC Band 12:	24.99dBm	
	LTE eMTC Band 13:	25.99dBm	
	LTE eMTC Band 66:	25.79dBm	
Rated Power Supply Voltage	3.3V		
Operating Voltage	Lowest: -35°C Highest: +75°C		
Operating Temperature	Lowest: -30°C Highest: +50°C		
Extreme Temperature	Minimum: 3.1V Maximum: 4.2V		
Frequency Range(s)	Band	Tx (MHz)	Rx (MHz)
	LTE eMTC Band 4	1710 ~ 1755	2110 ~ 2155
	LTE eMTC Band 12	699 ~ 716	729 ~ 746
	LTE eMTC Band 13	777 ~ 787	746 ~ 756
	LTE eMTC Band 66	1710 ~ 1780	2110 ~ 2180
Note: 1. The EUT is sent from the applicant to TA and the information of the EUT is declared by the applicant.			

3 Applied Standards

According to the specifications of the manufacturer, it must comply with the requirements of the following standards:

Test standards:

FCC CFR 47 Part 22H (2022)

FCC CFR47 Part 2 (2022)

Reference standard:

ANSI C63.26-2015

KDB 971168 D01 Power Meas License Digital Systems v03r01

4 Test Configuration

Radiated measurements are performed by rotating the EUT in three different orthogonal test planes. EUT stand-up position (Z axis), lie-down position (X,Y axis). Receiver antenna polarization (horizontal and vertical), the worst emission was found in position (Z axis, horizontal polarization) and the worst case was recorded.

All mode and data rates and positions and RB size and modulations were investigated.

Subsequently, only the worst case emissions are reported.

The following testing in LTE eMTC is set based on the maximum RF Output Power.

The following testing in different Bandwidth is set to detail in the following table:

Test modes are chosen to be reported as the worst case configuration below:

Test modes are chosen to be reported as the worst case configuration below for LTE eMTC Band 4/12/13/66:

Test items	Modes	Bandwidth (MHz)						Modulation		RB			Test Channel		
		1.4	3	5	10	15	20	QPSK	16QAM/ 64QAM	1	50%	100%	L	M	H
RF Power Output and Effective Isotropic Radiated Power	LTE eMTC Band 4	○	○	○	○	○	○	○	○	○	○	○	○	○	○
	LTE eMTC Band 12	○	○	○	○	-	-	○	○	○	○	○	○	○	○
	LTE eMTC Band 13	-	-	○	○	-	-	○	○	○	○	○	○	○	○
	LTE eMTC Band 66	○	○	○	○	○	○	○	○	○	○	○	○	○	○
Occupied Bandwidth	LTE eMTC Band 4	○	○	○	○	○	○	○	○	-	-	○	○	○	○
	LTE eMTC Band 12	○	○	○	○	-	-	○	○	-	-	○	○	○	○
	LTE eMTC Band 13	-	-	○	○	-	-	○	○	-	-	○	○	○	○
	LTE eMTC Band 66	○	○	○	○	○	○	○	○	-	-	○	○	○	○
Band Edge Compliance	LTE eMTC Band 4	○	○	○	○	○	○	○	○	○	-	○	○	-	○
	LTE eMTC Band 12	○	○	○	○	-	-	○	○	○	-	○	○	-	○
	LTE eMTC	-	-	○	○	-	-	○	○	○	-	○	○	-	○

	Band 13														
	LTE eMTC Band 66	O	O	O	O	O	O	O	O	O	-	O	O	-	O
Peak-to-Average Power Ratio	LTE eMTC Band 4	O	O	O	O	O	O	O	O	-	-	O	O	O	O
	LTE eMTC Band 12	O	O	O	O	-	-	O	O	-	-	O	O	O	O
	LTE eMTC Band 13	-	-	O	O	-	-	O	O	-	-	O	O	O	O
	LTE eMTC Band 66	O	O	O	O	O	O	O	O	-	-	O	O	O	O
Frequency Stability	LTE eMTC Band 4	O	O	O	O	O	O	O	O	O	-	-	-	O	-
	LTE eMTC Band 12	O	O	O	O	-	-	O	O	O	-	-	-	O	-
	LTE eMTC Band 13	-	-	O	O	-	-	O	O	O	-	-	-	O	-
	LTE eMTC Band 66	O	O	O	O	O	O	O	O	O	-	-	-	O	-
Spurious Emissions at Antenna Terminals	LTE eMTC Band 4	O	O	O	O	O	O	O	-	O	-	-	O	O	O
	LTE eMTC Band 12	O	O	O	O	-	-	O	-	O	-	-	O	O	O
	LTE eMTC Band 13	-	-	O	O	-	-	O	-	O	-	-	O	O	O
	LTE eMTC Band 66	O	O	O	O	O	O	O	-	O	-	-	O	O	O
Radiates Spurious Emission	LTE eMTC Band 4	O	-	O	-	-	O	O	-	O	-	-	-	O	-
	LTE eMTC Band 12	O	-	O	O	-	-	O	-	O	-	-	-	O	-
	LTE eMTC Band 13	-	-	O	O	-	-	O	-	O	-	-	-	O	-
	LTE eMTC Band 66	-	-	O	-	-	O	O	-	O	-	-	-	O	-
Note	1. The mark "O" means that this configuration is chosen for testing. 2. The mark "-" means that this configuration is not testing.														

5 Test Case Results

5.1 RF Power Output and Effective Isotropic Radiated Power

Ambient condition

Temperature	Relative humidity
20°C ~ 25°C	45% ~ 50%

Methods of Measurement

During the process of the testing, The EUT was connected to the Base Station Simulator with a known loss. The EUT is controlled by the Base Station Simulator test set to ensure max power transmission with proper modulation.

ERP can then be calculated as follows:

$$\text{EIRP (dBm)} = \text{Output Power (dBm)} - \text{Losses (dB)} + \text{Antenna Gain (dBi)}$$

where:dBd refers to gain relative to an ideal dipole.

$$\text{EIRP (dBm)} = \text{ERP (dBm)} + 2.15 \text{ (dB.)}$$

Test Setup

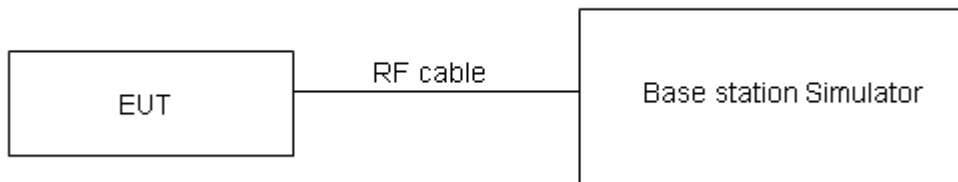

Limits

No specific RF power output requirements in part 2.1046.

Rule Part 27.50(b) (10) specifies that “Portable stations (hand-held devices) transmitting in the 746-757 MHz, 776-788 MHz, and 805-806 MHz bands are limited to 3 watts ERP”

Rule Part 27.50(c) (10) specifies that “Portable stations (hand-held devices) in the 600 MHz uplink band and the 698-746 MHz band, and fixed and mobile stations in the 600 MHz uplink band are limited to 3 watts ERP”

Rule Part 27.50(d) (4) specifies that “Fixed, mobile and portable (hand-held) stations operating in the 1710–1755 MHz band are limited to 1 watt EIRP”

Rule Part 27.50(h) (2) specifies that “Mobile and other user stations. Mobile stations are limited to 2.0 watts EIRP. All user stations are limited to 2.0 watts transmitter output power.”

Rule Part 27.50(a) (3) specifies that “(i) For mobile and portable stations transmitting in the

2305-2315 MHz band or the 2350-2360 MHz band, the average EIRP must not exceed 50 milliwatts within any 1 megahertz of authorized bandwidth, except that for mobile and portable stations compliant with 3GPP LTE standards or another advanced mobile broadband protocol that avoids concentrating energy at the edge of the operating band the average EIRP must not exceed 250 milliwatts within any 5 megahertz of authorized bandwidth but may exceed 50 milliwatts within any 1 megahertz of authorized bandwidth. ”

Part 27.50(b)(10)Limit	$\leq 3 \text{ W}$ (34.77 dBm)
Part 27.50(c)(10)Limit	$\leq 3 \text{ W}$ (34.77 dBm)
Part 27.50(d)(4)Limit	$\leq 1 \text{ W}$ (30 dBm)

Measurement Uncertainty

The assessed measurement uncertainty to ensure 95% confidence level for the normal distribution is with the coverage factor $k = 2$, $U=0.4 \text{ dB}$ for RF power output, $k = 2$, $U= 1.19 \text{ dB}$ for ERP/EIRP.

Test Results

LTE eMTC Band 4	Channel/ Frequency(MHz)	Index	RB#	RB#	Maximum Output Power(dBm)		EIRP (dBm)	
			Rbstart	Rbstart	QPSK	16QAM	QPSK	16QAM
			QPSK	16QAM				
1.4MHz	19957/1710.7	0	1#0	1#0	23.53	22.50	25.47	24.44
		0	6#0	5#0	22.13	21.58	24.07	23.52
	20175/1732.5	0	1#0	1#0	23.41	22.32	25.41	24.32
		0	6#0	5#0	22.12	21.48	24.12	23.48
	20393/1754.3	0	1#5	1#5	23.62	22.42	25.19	23.99
		0	6#0	5#0	22.17	21.59	23.74	23.16
3MHz	19965/1711.5	0	1#0	1#0	23.63	22.61	25.57	24.55
		0	6#0	5#0	21.88	21.57	23.82	23.51
	20175/1732.5	0	1#0	1#0	23.62	22.68	25.62	24.68
		0	6#0	5#0	21.79	21.54	23.79	23.54
	20385/1753.5	1	1#5	1#5	23.80	22.73	25.37	24.30
		1	6#0	5#0	21.89	21.63	23.46	23.20
5MHz	19975/1712.5	3	1#0	1#0	23.75	23.74	25.69	25.68
		0	6#0	5#0	23.03	21.62	24.97	23.56
	20175/1732.5	0	1#0	1#0	23.67	23.70	25.67	25.70
		0	6#0	5#0	22.95	21.73	24.95	23.73
	20375/1752.5	0	1#5	1#5	23.55	23.73	25.12	25.30
		3	6#0	5#0	23.06	21.71	24.63	23.28
10MHz	20000/1715	3	1#0	1#0	23.77	23.80	25.71	25.74
		0	4#0	4#0	23.41	22.70	25.35	24.64
	20175/1732.5	0	1#0	1#0	23.70	23.72	25.70	25.72
		0	4#0	4#0	23.46	22.64	25.46	24.64
	20350/1750	4	1#5	1#5	23.80	23.74	25.37	25.31
		7	4#2	4#2	23.39	21.75	24.96	23.32
15MHz	20025/1717.5	3	1#0	1#0	23.79	23.15	25.73	25.09
		0	6#0	5#0	23.63	23.66	25.57	25.60
	20175/1732.5	0	1#0	1#0	23.67	23.64	25.67	25.64
		0	6#0	5#0	23.59	23.53	25.59	25.53
	20325/1747.5	8	1#5	1#5	23.77	23.69	25.77	25.69
		11	6#0	5#0	23.64	23.47	25.64	25.47
20MHz	20050/1720	3	1#0	1#0	23.77	23.80	25.71	25.74
		0	6#0	5#0	23.62	23.62	25.56	25.56
	20175/1732.5	0	1#0	1#0	23.70	23.71	25.70	25.71
		0	6#0	5#0	23.61	23.58	25.61	25.58
	20300/1745	12	1#5	1#5	23.72	23.66	25.72	25.66
		15	6#0	5#0	23.60	23.49	25.60	25.49
LTE eMTC	Channel/	Index	RB#	RB#	Maximum Output		ERP (dBm)	

Band12	Frequency(MHz)		Rbstart QPSK	Rbstart 16QAM	Power(dBm)		QPSK	16QAM
					QPSK	16QAM		
1.4MHz	23017/699.7	0	1#0	1#0	23.53	22.88	23.04	22.39
		0	6#0	5#0	22.49	21.92	22.00	21.43
	23095/707.5	0	1#0	1#0	23.37	22.80	24.48	23.91
		0	6#0	5#0	22.33	21.87	23.44	22.98
	23173/715.3	0	1#5	1#5	23.19	22.78	24.99	24.58
		0	6#0	5#0	22.89	21.74	24.69	23.54
3MHz	23025/700.5	0	1#0	1#0	23.64	23.18	23.15	22.69
		0	6#0	5#0	22.25	22.00	21.76	21.51
	23095/707.5	0	1#0	1#0	23.53	23.06	24.64	24.17
		0	6#0	5#0	22.15	21.93	23.26	23.04
	23165/714.5	1	1#5	1#5	23.24	23.00	24.35	24.11
		1	6#0	5#0	22.06	21.74	23.17	22.85
5MHz	23035/701.5	3	1#0	1#0	23.52	23.33	23.03	22.84
		0	6#0	5#0	23.24	22.11	22.75	21.62
	23095/707.5	0	1#0	1#0	23.47	23.33	24.58	24.44
		0	6#0	5#0	23.30	22.13	24.41	23.24
	23155/713.5	0	1#5	1#5	23.55	23.33	24.66	24.44
		3	6#0	5#0	23.08	21.93	24.19	23.04
10MHz	23060/704	3	1#0	1#0	23.48	23.30	22.99	22.81
		0	4#0	4#0	23.67	23.07	23.18	22.58
	23095/707.5	0	1#0	1#0	23.51	23.37	24.62	24.48
		0	4#0	4#0	23.67	23.14	24.78	24.25
	23130/711	4	1#5	1#5	23.51	23.34	24.62	24.45
		7	4#2	4#2	23.72	22.04	24.83	23.15
LTE eMTC Band13	Channel/ Frequency(MHz)	Index	RB# Rbstart QPSK	RB# Rbstart 16QAM	Maximum Output Power(dBm)		ERP (dBm)	
5MHz	23205/779.5	3	1#0	1#0	23.43	23.19	25.73	25.49
		0	6#0	5#0	23.14	21.86	25.44	24.16
	23230/782	0	1#0	1#0	23.69	23.28	25.99	25.58
		0	6#0	5#0	23.11	21.87	25.41	24.17
	23255/784.5	0	1#5	1#5	23.60	23.42	25.90	25.72
		3	6#0	5#0	23.04	21.75	25.34	24.05
10MHz	23230/782	0	1#0	1#0	23.40	23.24	25.70	25.54
		0	4#0	4#0	23.55	22.89	25.85	25.19
LTE eMTC Band66	Channel/ Frequency(MHz)	Index	RB# Rbstart QPSK	RB# Rbstart 16QAM	Maximum Output Power(dBm)		EIRP (dBm)	
1.4MHz	131979/1710.7	0	1#0	1#0	23.52	22.52	25.46	24.46
		0	6#0	5#0	22.15	21.59	24.09	23.53

	132322/1745	0	1#0	1#0	23.43	21.82	25.43	23.82
		0	6#0	5#0	22.03	21.52	24.03	23.52
	132665/1779.3	0	1#5	1#5	23.72	22.53	24.69	23.50
		0	6#0	5#0	22.10	21.60	23.07	22.57
3MHz	131987/1711.5	0	1#0	1#0	23.62	22.60	25.56	24.54
		0	6#0	5#0	21.84	21.58	23.78	23.52
	132322/1745	0	1#0	1#0	23.60	22.62	25.60	24.62
		0	6#0	5#0	21.78	21.54	23.78	23.54
	132657/1778.5	1	1#5	1#5	23.79	22.78	24.76	23.75
		1	6#0	5#0	21.92	21.66	22.89	22.63
5MHz	131997/1712.5	3	1#0	1#0	23.71	23.67	25.65	25.61
		0	6#0	5#0	22.86	21.59	24.80	23.53
	132322/1745	0	1#0	1#0	23.60	23.68	25.60	25.68
		0	6#0	5#0	22.88	21.74	24.88	23.74
	132647/1777.5	0	1#5	1#5	23.77	23.64	24.74	24.61
		3	6#0	5#0	22.87	21.57	23.84	22.54
10MHz	132022/1715	3	1#0	1#0	23.68	23.66	25.62	25.60
		0	4#0	4#0	23.64	22.61	25.58	24.55
	132322/1745	0	1#0	1#0	23.63	23.60	25.63	25.60
		0	4#0	4#0	23.57	22.68	25.57	24.68
	132622/1775	4	1#5	1#5	23.72	23.69	24.69	24.66
		7	4#2	4#2	22.98	21.69	23.95	22.66
15MHz	132047/1717.5	3	1#0	1#0	23.71	23.72	25.65	25.66
		0	6#0	5#0	23.64	23.55	25.58	25.49
	132322/1745	0	1#0	1#0	23.62	23.61	25.62	25.61
		0	6#0	5#0	23.78	23.54	25.78	25.54
	132597/1772.5	8	1#5	1#5	23.75	23.68	24.72	24.65
		11	6#0	5#0	23.67	23.51	24.64	24.48
20MHz	132072/1720	3	1#0	1#0	23.73	23.74	25.67	25.68
		0	6#0	5#0	23.62	23.58	25.56	25.52
	132322/1745	0	1#0	1#0	23.63	23.62	25.63	25.62
		0	6#0	5#0	23.79	23.52	25.79	25.52
	132572/1770	12	1#5	1#5	23.73	23.67	24.70	24.64
		15	6#0	5#0	23.63	23.49	24.60	24.46

5.2 Occupied Bandwidth

Ambient condition

Temperature	Relative humidity
20°C ~ 25°C	45% ~ 50%

Method of Measurement

The EUT was connected to Spectrum Analyzer and Base Station Simulator via power Splitter. The occupied bandwidth is measured using spectrum analyzer.

RBW is set to 51kHz, VBW is set to 160kHz for LTE eMTC Band 4/12/13/66

99% power and -26dBc occupied bandwidths are recorded. Spectrum analyzer plots are included on the following pages.

Test Setup

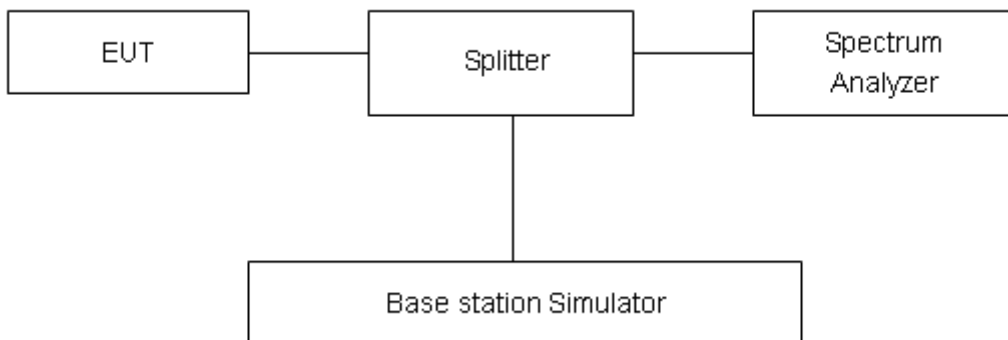

Limits

No specific occupied bandwidth requirements in part 2.1049.

Measurement Uncertainty

The assessed measurement uncertainty to ensure 95% confidence level for the normal distribution is with the coverage factor $k = 2$, $U=624\text{Hz}$.

Test Result

Mode	Bandwidth	Modulation	Channel/ Frequency(MHz)	Bandwidth(MHz)	
				99% Power	-26dBc
LTE eMTC Band4	1.4MHz	QPSK	20175/1732.5	1.1133	1.342
		16QAM	20175/1732.5	0.9675	1.295
	3MHz	QPSK	20175/1732.5	1.1158	1.343
		16QAM	20175/1732.5	0.9638	1.312
	5MHz	QPSK	20175/1732.5	1.0979	1.332
		16QAM	20175/1732.5	0.9994	1.317
	10MHz	QPSK	20175/1732.5	1.1122	1.342
		16QAM	20175/1732.5	0.9853	1.298
	15MHz	QPSK	20175/1732.5	1.1182	1.351
		16QAM	20175/1732.5	1.0030	1.323
20MHz	QPSK	20175/1732.5	1.1162	1.347	
	16QAM	20175/1732.5	1.0073	1.334	
Mode	Bandwidth	Modulation	Channel/ Frequency(MHz)	Bandwidth(MHz)	
				99% Power	-26dBc
LTE eMTC Band12	1.4MHz	QPSK	23095/707.5	1.1057	1.330
		16QAM	23095/707.5	0.9698	1.300
	3MHz	QPSK	23095/707.5	1.1029	1.342
		16QAM	23095/707.5	0.9862	1.310
	5MHz	QPSK	23095/707.5	1.1045	1.334
		16QAM	23095/707.5	0.9662	1.303
10MHz	QPSK	23095/707.5	1.1045	1.325	
	16QAM	23095/707.5	0.9882	1.311	
Mode	Bandwidth	Modulation	Channel/ Frequency(MHz)	Bandwidth(MHz)	
				99% Power	-26dBc
LTE eMTC Band13	5MHz	QPSK	23230/782	1.1135	1.338
		16QAM	23230/782	0.9627	1.319
	10MHz	QPSK	23230/782	1.1097	1.351
		16QAM	23230/782	0.9861	1.305
Mode	Bandwidth	Modulation	Channel/ Frequency(MHz)	Bandwidth(MHz)	
				99% Power	-26dBc
LTE eMTC Band66	1.4MHz	QPSK	132322/1745	1.1132	1.324
		16QAM	132322/1745	0.9618	1.286
	3MHz	QPSK	132322/1745	1.1014	1.308
		16QAM	132322/1745	0.9491	1.308
	5MHz	QPSK	132322/1745	1.1055	1.330
		16QAM	132322/1745	0.9989	1.269
10MHz	QPSK	132322/1745	1.1072	1.341	
	16QAM	132322/1745	0.9876	1.290	

	15MHz	QPSK	132322/1745	1.1036	1.333
		16QAM	132322/1745	0.9854	1.308
	20MHz	QPSK	132322/1745	1.1124	1.344
		16QAM	132322/1745	0.9896	1.324

LTE eMTC Band 4 QPSK 1.4MHz CH-Middle

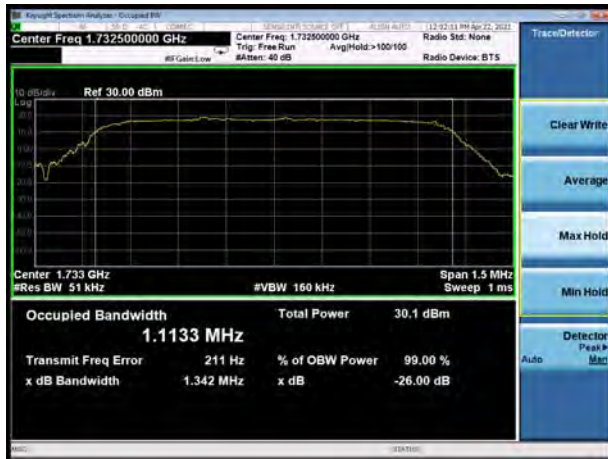

LTE eMTC Band 4 QPSK 3MHz CH-Middle



LTE eMTC Band 4 QPSK 5MHz CH-Middle



LTE eMTC Band 4 QPSK 10MHz CH-Middle



LTE eMTC Band 4 QPSK 15MHz CH-Middle



LTE eMTC Band 4 QPSK 20MHz CH-Middle



LTE eMTC Band 4 16QAM 1.4MHz CH-Middle



LTE eMTC Band 4 16QAM 3MHz CH-Middle



LTE eMTC Band 4 16QAM 5MHz CH-Middle



LTE eMTC Band 4 16QAM 10MHz CH-Middle



LTE eMTC Band 4 16QAM 15MHz CH-Middle

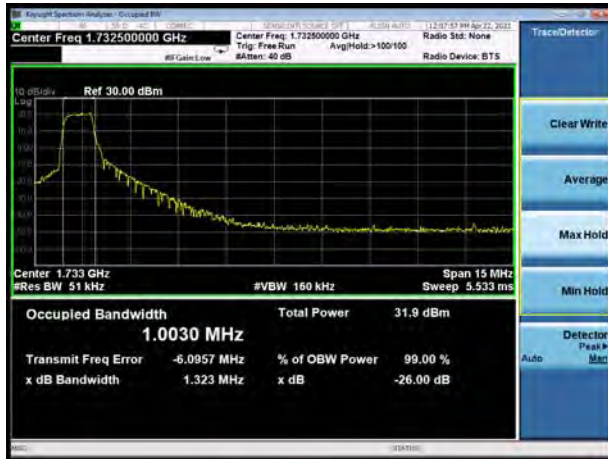

LTE eMTC Band 4 16QAM 20MHz CH-Middle



LTE eMTC Band 12 QPSK 1.4MHz CH-Middle



LTE eMTC Band 12 QPSK 3MHz CH-Middle



LTE eMTC Band 12 QPSK 5MHz CH-Middle



LTE eMTC Band 12 QPSK 10MHz CH-Middle



LTE eMTC Band 12 16QAM 1.4MHz CH-Middle



LTE eMTC Band 12 16QAM 3MHz CH-Middle



LTE eMTC Band 12 16QAM 5MHz CH-Middle



LTE eMTC Band 12 16QAM 10MHz CH-Middle



LTE eMTC Band 13 QPSK 5MHz CH-Middle



LTE eMTC Band 13 QPSK 10MHz CH-Middle



LTE eMTC Band 13 16QAM 5MHz CH-Middle



LTE eMTC Band 13 16QAM 10MHz CH-Middle



LTE eMTC Band 66 QPSK 1.4MHz CH-Middle



LTE eMTC Band 66 QPSK 3MHz CH-Middle



LTE eMTC Band 66 QPSK 5MHz CH-Middle



LTE eMTC Band 66 QPSK 10MHz CH-Middle



LTE eMTC Band 66 QPSK 15MHz CH-Middle



LTE eMTC Band 66 QPSK 20MHz CH-Middle



LTE eMTC Band 66 16QAM 1.4MHz CH-Middle



LTE eMTC Band 66 16QAM 3MHz CH-Middle



LTE eMTC Band 66 16QAM 5MHz CH-Middle



LTE eMTC Band 66 16QAM 10MHz CH-Middle

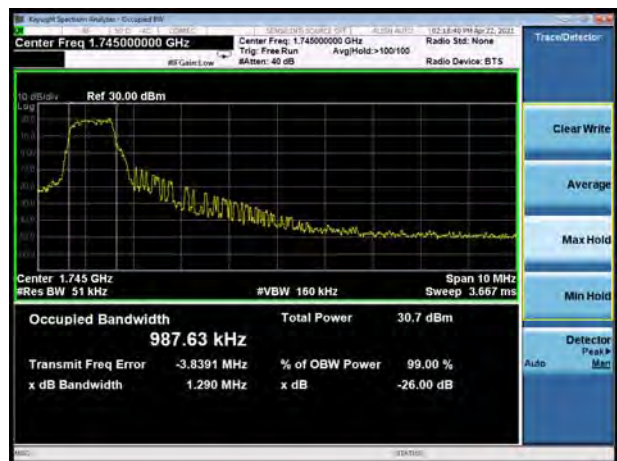

LTE eMTC Band 66 16QAM 15MHz CH-Middle

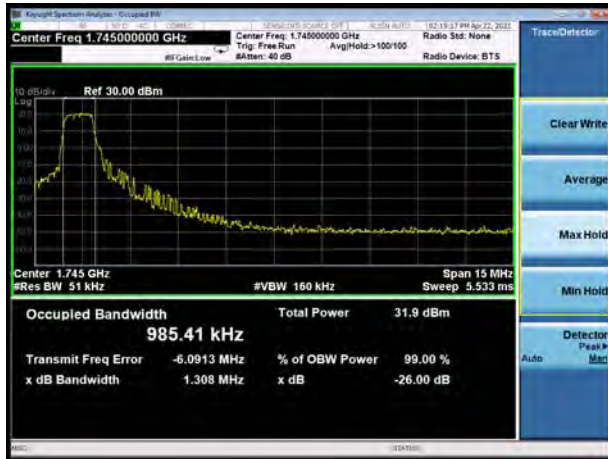

LTE eMTC Band 66 16QAM 20MHz CH-Middle



5.3 Band Edge Compliance

Ambient condition

Temperature	Relative humidity
20°C ~ 25°C	45% ~ 50%

Method of Measurement

The EUT was connected to Spectrum Analyzer and Base Station Simulator via power Splitter. The band edge of the lowest and highest channels were measured.

The testing follows KDB 971168 D01 v03r01 Section 6.0

The EUT was connected to spectrum analyzer and system simulator via a power divider.

The band edges of low and high channels for the highest RF powers were measured.

RBW is set to 51 kHz, VBW is set to 160 kHz for LTE eMTC Band 4/12/13/66 on spectrum analyzer.

Set spectrum analyzer with RMS detector.

The RF fundamental frequency should be excluded against the limit line in the operating frequency band.

Checked that all the results comply with the emission limit line.

Test Setup

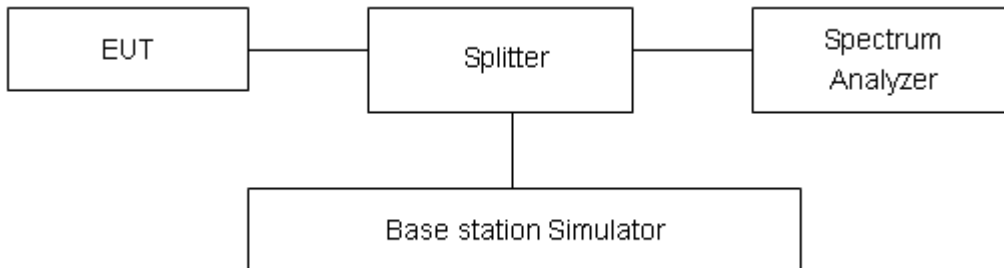

Limits

Rule Part 27.53(i) By a factor of not less than $43 + 10 \log(P)$ dB on all frequencies between 2305 and 2320 MHz.

Rule Part 27.53(h) specifies that “ for operations in the 1695-1710 MHz, 1710-1755 MHz, 1755-1780 MHz, 1915-1920 MHz, 1995-2000 MHz, 2000-2020 MHz, 2110-2155 MHz, 2155-2180 MHz, and 2180-2200 bands, the power of any emission outside a licensee's frequency block shall be attenuated below the transmitter power (P) in watts by at least $43 + 10 \log_{10}(P)$ dB”

Rule Part 27.53(g) For operations in the 600 MHz band and the 698-746 MHz band, the power of any emission outside a licensee's frequency band(s) of operation shall be attenuated below the transmitter power (P) within the licensed band(s) of operation, measured in watts, by at least $43 + 10 \log(P)$ dB. Compliance with this provision is based on the use of measurement instrumentation

employing a resolution bandwidth of 100 kilohertz or greater. However, in the 100 kilohertz bands immediately outside and adjacent to a licensee's frequency block, a resolution bandwidth of at least 30 kHz may be employed.

Example:

The limit line is derived from $43 + 10 \log(P)$ dB below the transmitter power P (Watts)
 $= P(W) - [43 + 10 \log(P)]$ (dB)
 $= [30 + 10 \log(P)]$ (dBm) - $[43 + 10 \log(P)]$ (dB) = -13dBm.

Rule Part 27.53(f) For operations in the 746-758 MHz, 775-788 MHz, and 805-806 MHz bands, emissions in the band 1559-1610 MHz shall be limited to -70 dBW/MHz equivalent isotropically radiated power (EIRP) for wideband signals, and -80 dBW EIRP for discrete emissions of less than 700 Hz bandwidth. For the purpose of equipment authorization, a transmitter shall be tested with an antenna that is representative of the type that will be used with the equipment in normal operation.

Rule Part 27.53 (c) For operations in the 746-758 MHz band and the 776-788 MHz band, the power of any emission outside the licensee's frequency band(s) of operation shall be attenuated below the transmitter power (P) within the licensed band(s) of operation, measured in watts, in accordance with the following:

- (1) On any frequency outside the 746-758 MHz band, the power of any emission shall be attenuated outside the band below the transmitter power (P) by at least $43 + 10 \log(P)$ dB;
- (2) On any frequency outside the 776-788 MHz band, the power of any emission shall be attenuated outside the band below the transmitter power (P) by at least $43 + 10 \log(P)$ dB;
- (3) On all frequencies between 763-775 MHz and 793-805 MHz, by a factor not less than $76 + 10 \log(P)$ dB in a 6.25 kHz band segment, for base and fixed stations;
- (4) On all frequencies between 763-775 MHz and 793-805 MHz, by a factor not less than $65 + 10 \log(P)$ dB in a 6.25 kHz band segment, for mobile and portable stations;
- (5) Compliance with the provisions of paragraphs (c)(1) and (c)(2) of this section is based on the use of measurement instrumentation employing a resolution bandwidth of 100 kHz or greater. However, in the 100 kHz bands immediately outside and adjacent to the frequency block, a resolution bandwidth of at least 30 kHz may be employed;

Measurement Uncertainty

The assessed measurement uncertainty to ensure 95% confidence level for the normal distribution is with the coverage factor $k = 1.96$, $U = 0.684$ dB.

Test Result

All the test traces in the plots shows the test results clearly.

LTE eMTC Band 4 QPSK 1.4MHz CH-Low, 1 RB

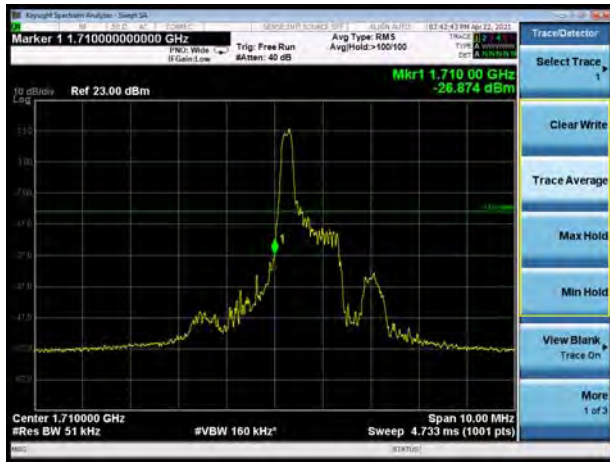

LTE eMTC Band 4 QPSK 1.4MHz CH-High, 1 RB

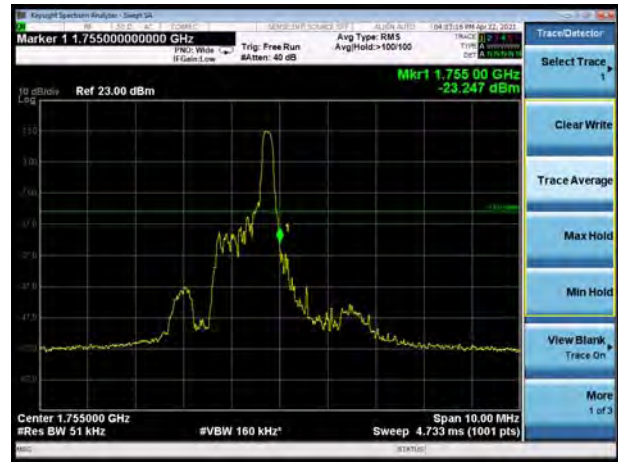

LTE eMTC Band 4 QPSK 1.4MHz CH-Low, 100%RB

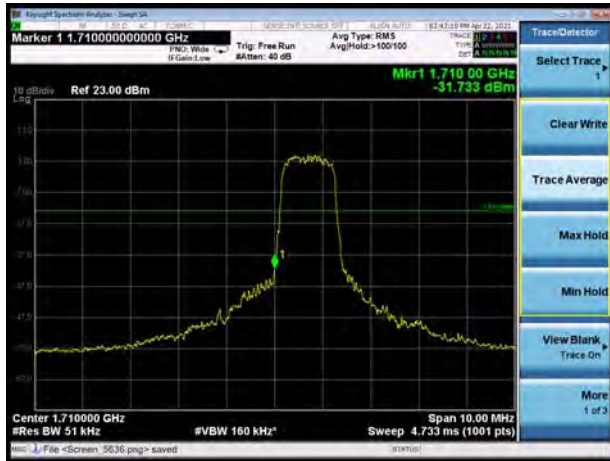

LTE eMTC Band 4 QPSK 1.4MHz CH-High, 100%RB

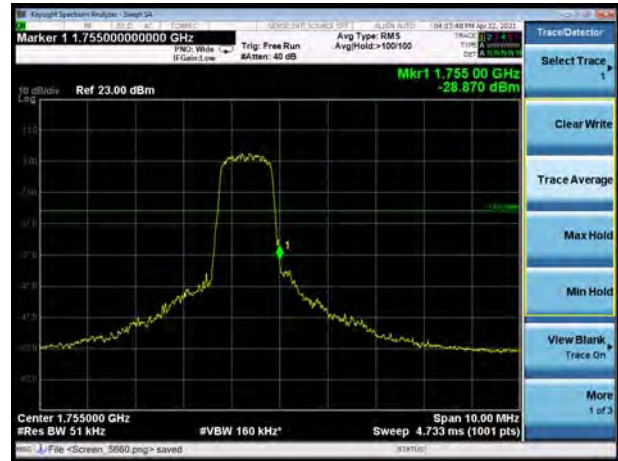

LTE eMTC Band 4 QPSK 3MHz CH-Low, 1 RB



LTE eMTC Band 4 QPSK 3MHz CH-High, 1 RB

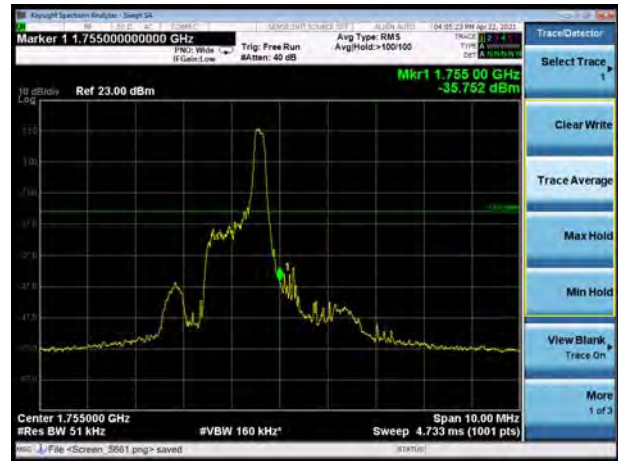

LTE eMTC Band 4 QPSK 3MHz CH-Low, 100%RB

LTE eMTC Band 4 QPSK 3MHz CH-High, 100%RB

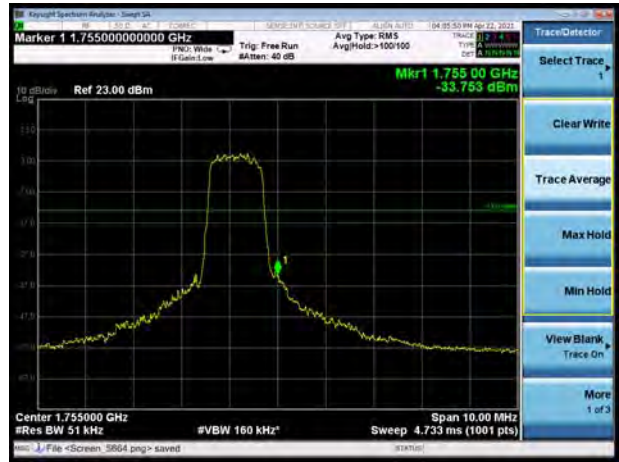

LTE eMTC Band 4 QPSK 5MHz CH-Low, 1 RB

LTE eMTC Band 4 QPSK 5MHz CH-High, 1 RB



LTE eMTC Band 4 QPSK 5MHz CH-Low, 100%RB

LTE eMTC Band 4 QPSK 5MHz CH-High, 100%RB

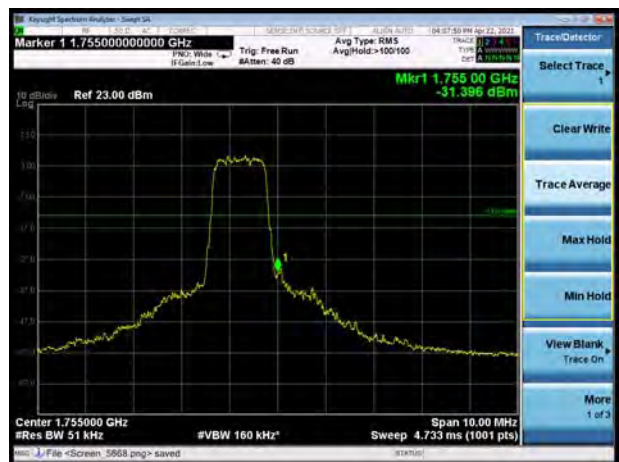
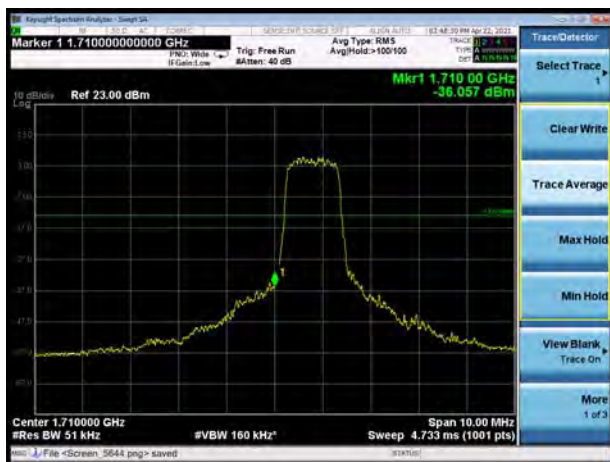

LTE eMTC Band 4 QPSK 10MHz CH-Low, 1 RB



LTE eMTC Band 4 QPSK 10MHz CH-High, 1 RB



LTE eMTC Band 4 QPSK 10MHz CH-Low, 100%RB

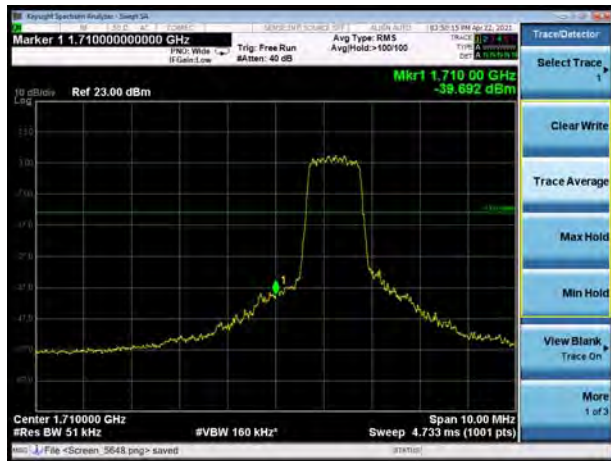

LTE eMTC Band 4 QPSK 10MHz CH-High, 100%RB



LTE eMTC Band 4 QPSK 15MHz CH-Low, 1 RB

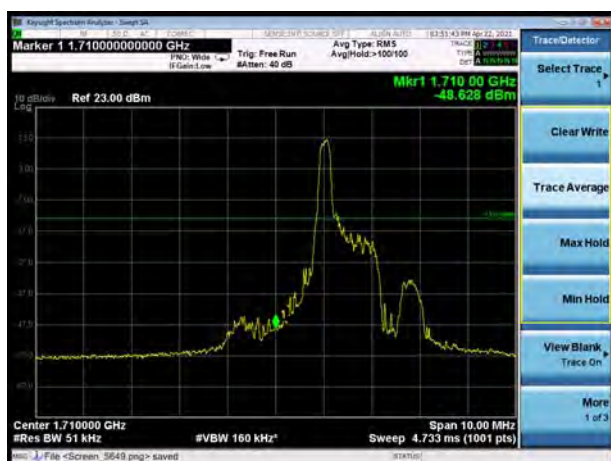

LTE eMTC Band 4 QPSK 15MHz CH-High, 1 RB

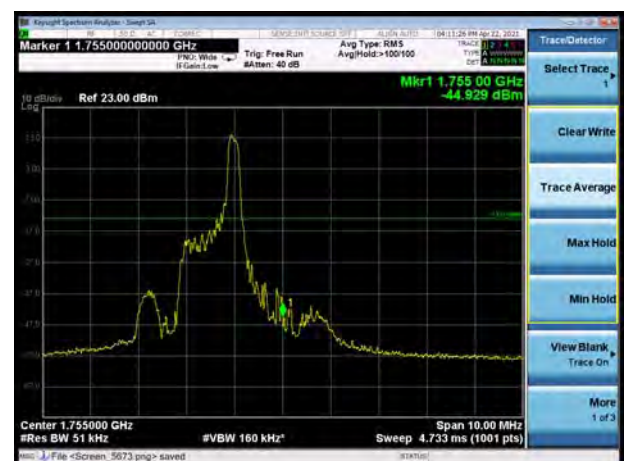

LTE eMTC Band 4 QPSK 15MHz CH-Low, 100%RB

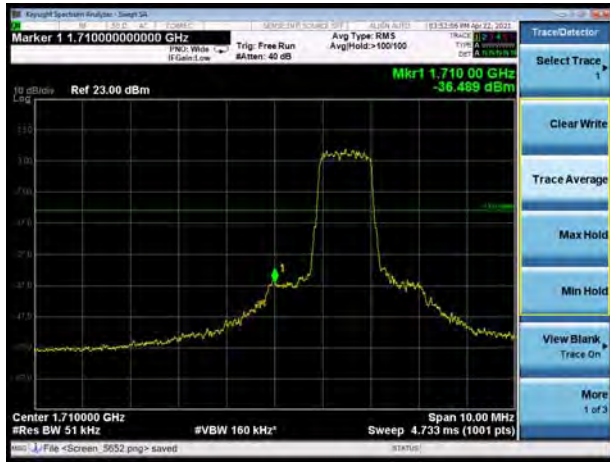

LTE eMTC Band 4 QPSK 15MHz CH-High, 100%RB

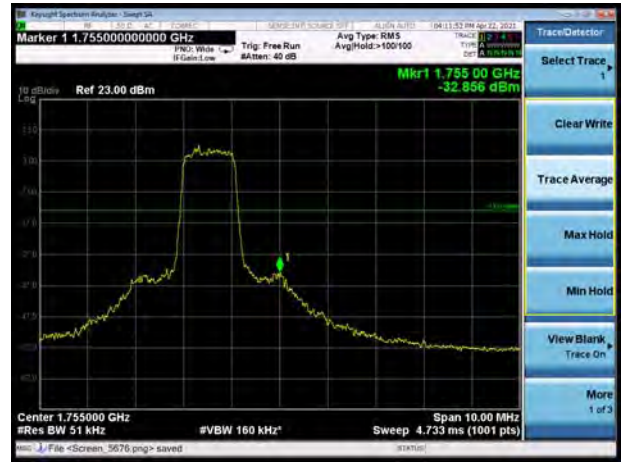

LTE eMTC Band 4 QPSK 20MHz CH-Low, 1 RB



LTE eMTC Band 4 QPSK 20MHz CH-High, 1 RB

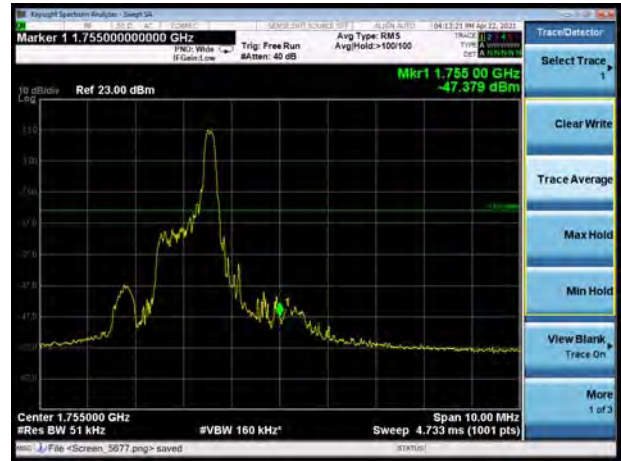

LTE eMTC Band 4 QPSK 20MHz CH-Low, 100%RB



LTE eMTC Band 4 QPSK 20MHz CH-High, 100%RB



LTE eMTC Band 4 16QAM 1.4MHz CH-Low, 1 RB



LTE eMTC Band 4 16QAM 1.4MHz CH-High, 1 RB



LTE eMTC Band 4 16QAM 1.4MHz CH-Low, 100%RB

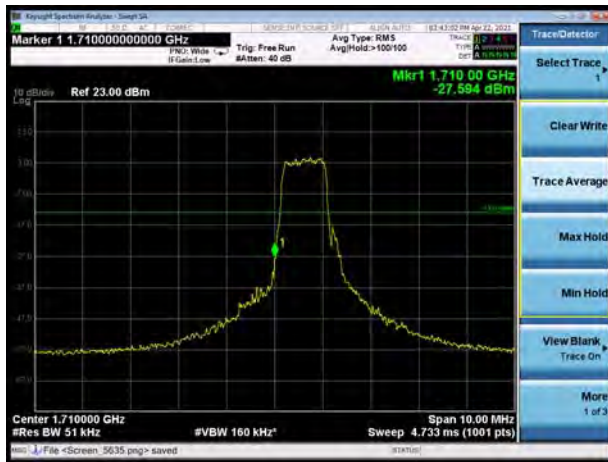

LTE eMTC Band 4 16QAM 1.4MHz CH-High, 100%RB

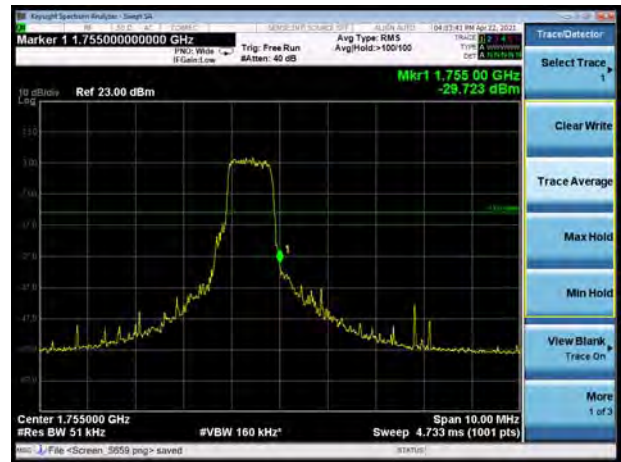

LTE eMTC Band 4 16QAM 3MHz CH-Low, 1 RB



LTE eMTC Band 4 16QAM 3MHz CH-High, 1 RB



LTE eMTC Band 4 16QAM 3MHz CH-Low, 100%RB

LTE eMTC Band 4 16QAM 3MHz CH-High, 100%RB

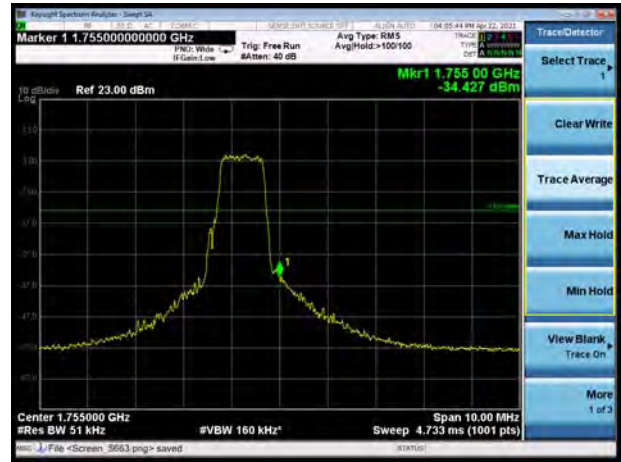
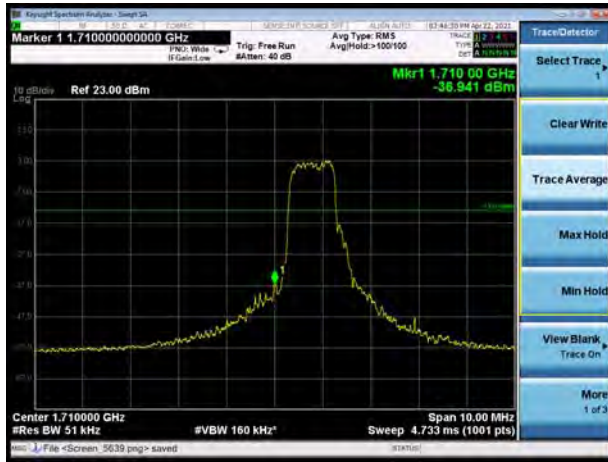

LTE eMTC Band 4 16QAM 5MHz CH-Low, 1 RB

LTE eMTC Band 4 16QAM 5MHz CH-High, 1 RB

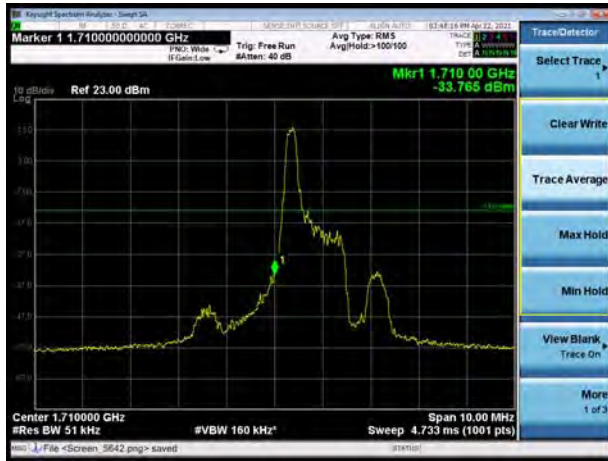

LTE eMTC Band 4 16QAM 5MHz CH-Low, 100%RB

LTE eMTC Band 4 16QAM 5MHz CH-High, 100%RB

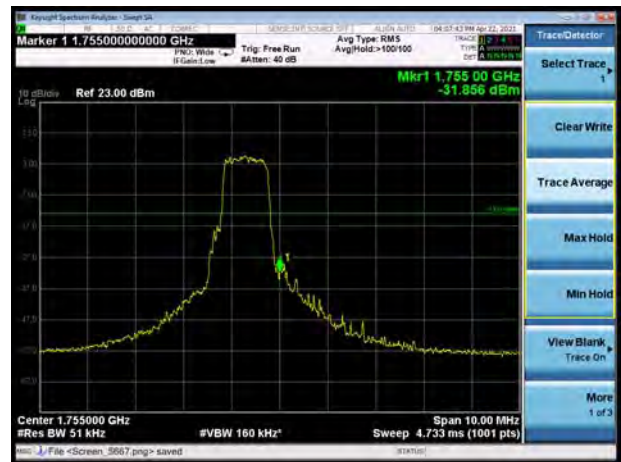
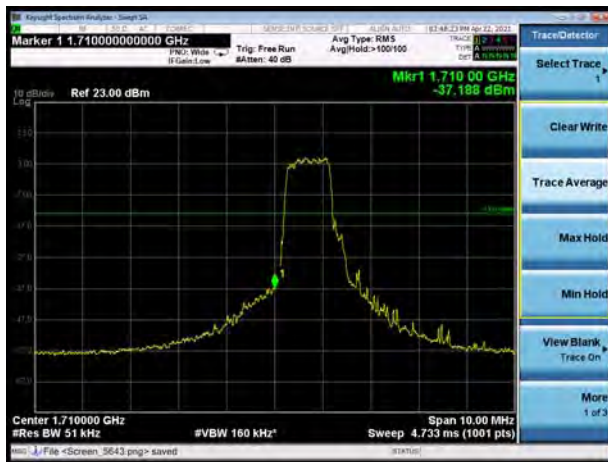

LTE eMTC Band 4 16QAM 10MHz CH-Low, 1 RB



LTE eMTC Band 4 16QAM 10MHz CH-High, 1 RB

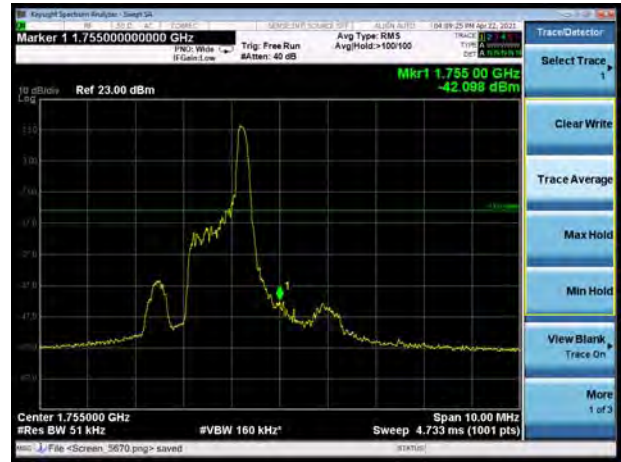

LTE eMTC Band 4 16QAM 10MHz CH-Low, 100%RB

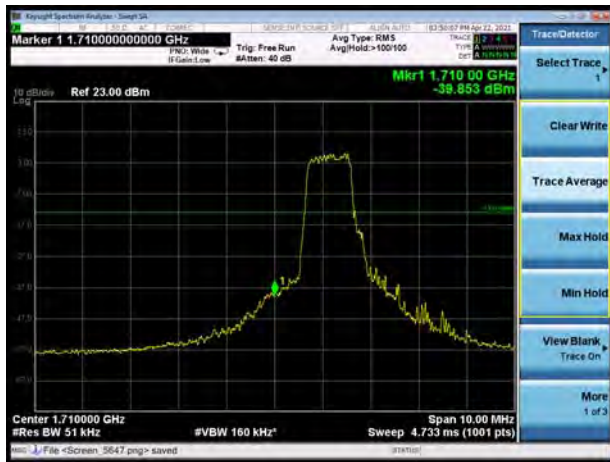

LTE eMTC Band 4 16QAM 10MHz CH-High, 100%RB



LTE eMTC Band 4 16QAM 15MHz CH-Low, 1 RB



LTE eMTC Band 4 16QAM 15MHz CH-High, 1 RB

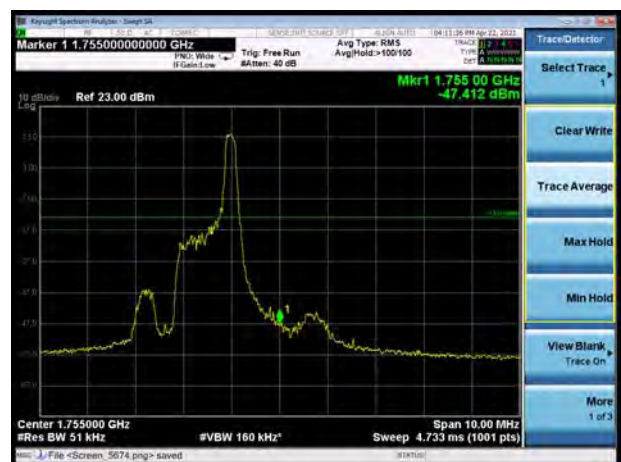

LTE eMTC Band 4 16QAM 15MHz CH-Low, 100%RB

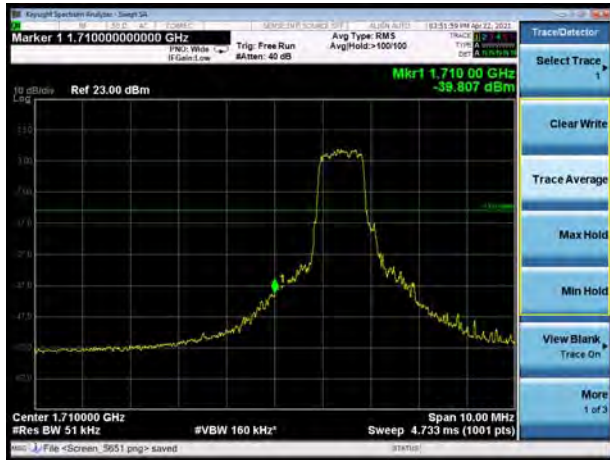

LTE eMTC Band 4 16QAM 15MHz CH-High, 100%RB



LTE eMTC Band 4 16QAM 20MHz CH-Low, 1 RB



LTE eMTC Band 4 16QAM 20MHz CH-High, 1 RB



LTE eMTC Band 4 16QAM 20MHz CH-Low, 100%RB

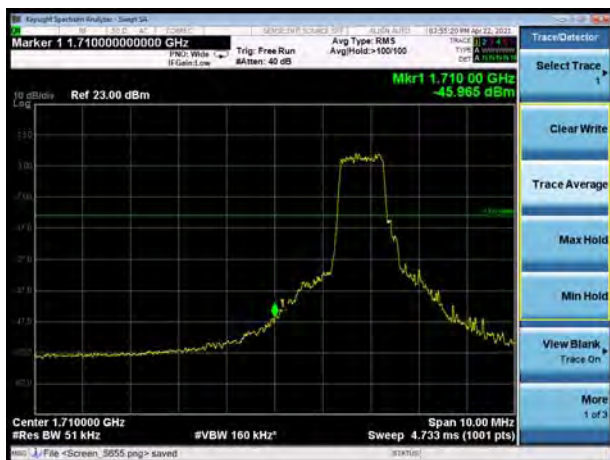

LTE eMTC Band 4 16QAM 20MHz CH-High, 100%RB



LTE eMTC Band 12 QPSK 1.4MHz CH-Low, 1 RB

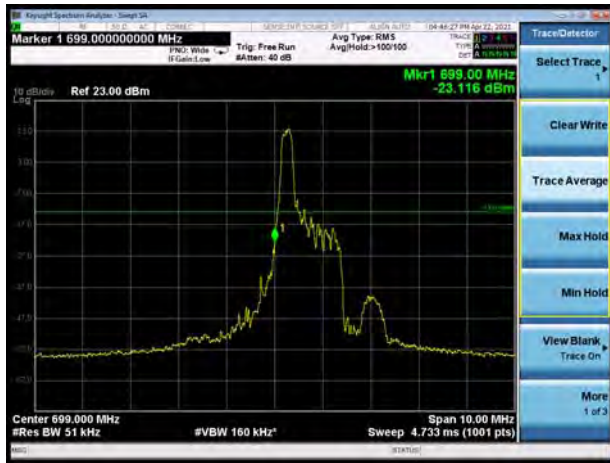

LTE eMTC Band 12 QPSK 1.4MHz CH-High, 1 RB

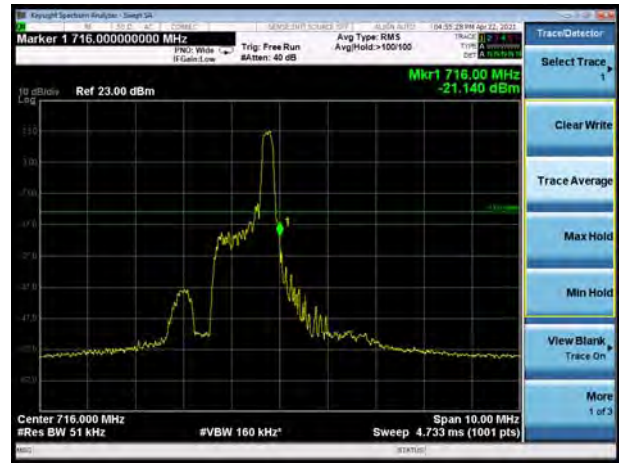

LTE eMTC Band 12 QPSK 1.4MHz CH-Low, 100%RB



LTE eMTC Band 12 QPSK 1.4MHz CH-High, 100%RB

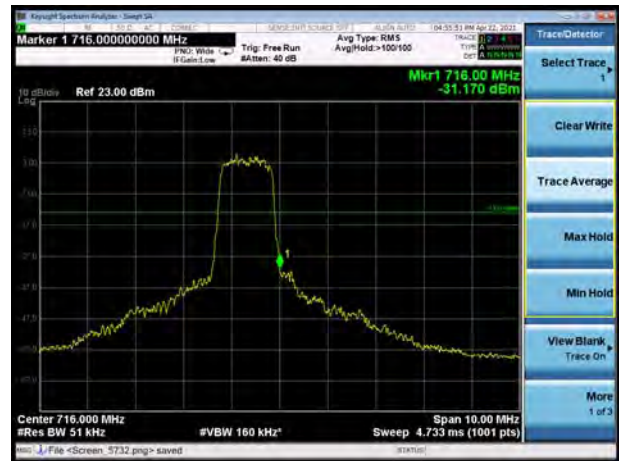

LTE eMTC Band 12 QPSK 3MHz CH-Low, 1 RB

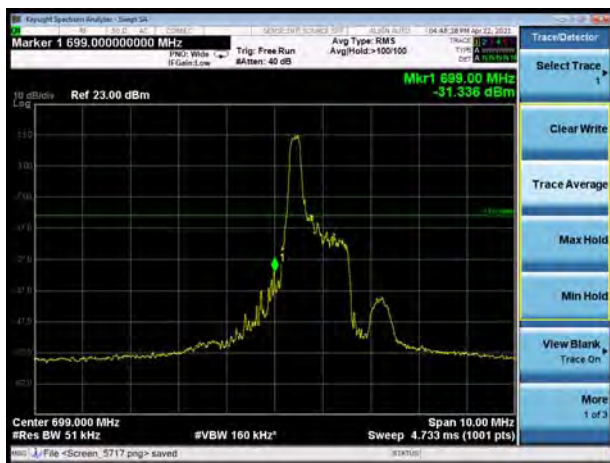

LTE eMTC Band 12 QPSK 3MHz CH-High, 1 RB

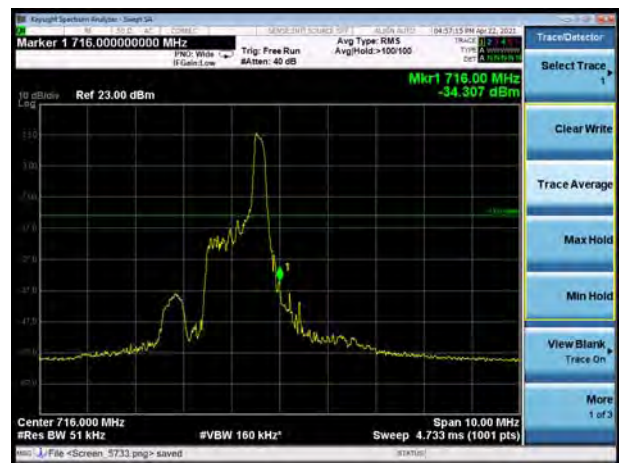

LTE eMTC Band 12 QPSK 3MHz CH-Low, 100%RB

LTE eMTC Band 12 QPSK 3MHz CH-High, 100%RB

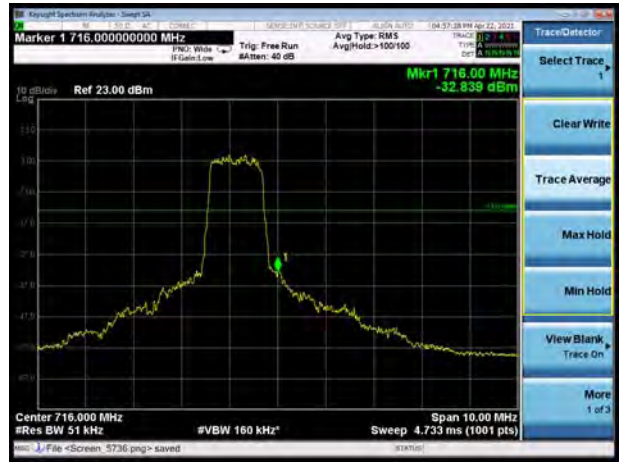

LTE eMTC Band 12 QPSK 5MHz CH-Low, 1 RB

LTE eMTC Band 12 QPSK 5MHz CH-High, 1 RB



LTE eMTC Band 12 QPSK 5MHz CH-Low, 100%RB

LTE eMTC Band 12 QPSK 5MHz CH-High, 100%RB

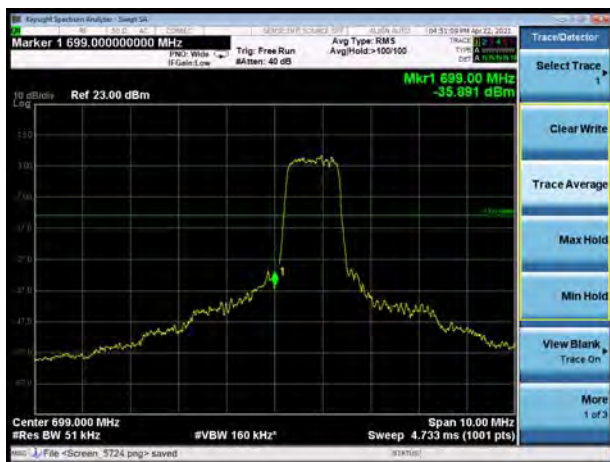

LTE eMTC Band 12 QPSK 10MHz CH-Low, 1 RB

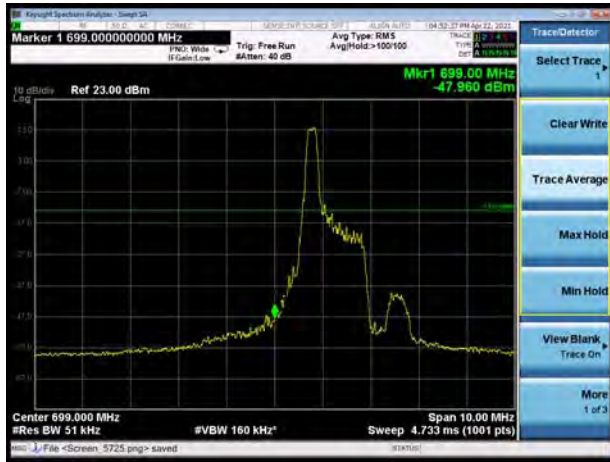

LTE eMTC Band 12 QPSK 10MHz CH-High, 1 RB

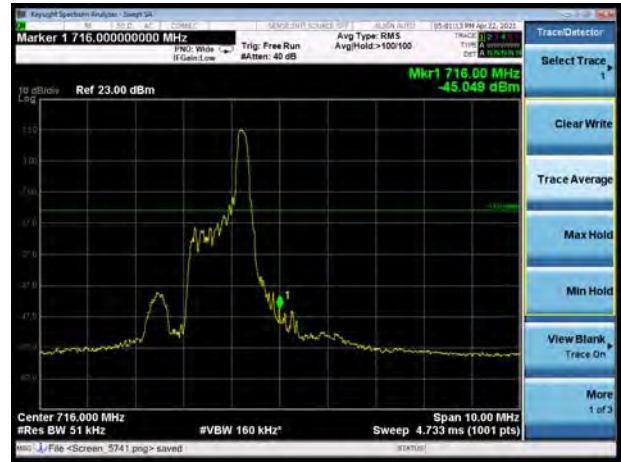

LTE eMTC Band 12 QPSK 10MHz CH-Low, 100%RB

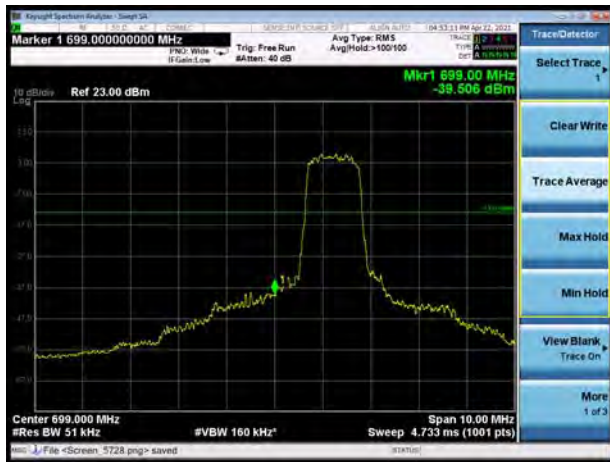

LTE eMTC Band 12 QPSK 10MHz CH-High, 100%RB



LTE eMTC Band 12 16QAM 1.4MHz CH-Low, 1 RB

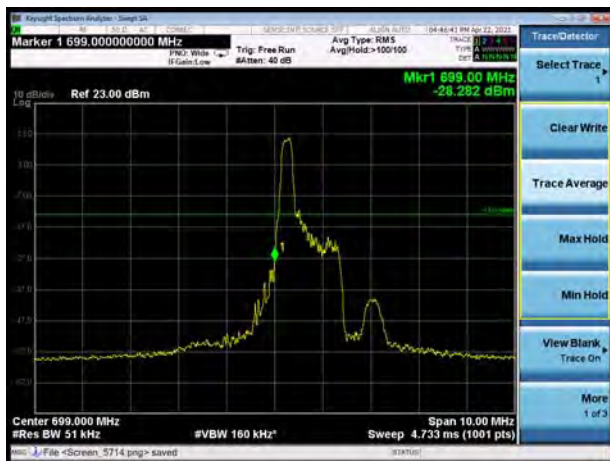

LTE eMTC Band 12 16QAM 1.4MHz CH-High, 1 RB

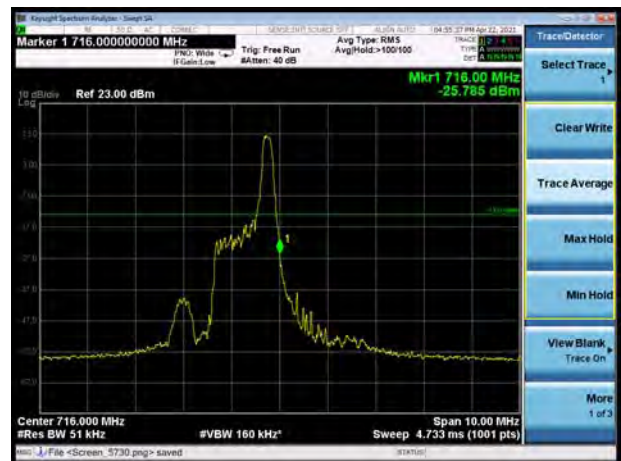

LTE eMTC Band 12 16QAM 1.4MHz CH-Low, 100%RB



LTE eMTC Band 12 16QAM 1.4MHz CH-High, 100%RB



LTE eMTC Band 12 16QAM 3MHz CH-Low, 1 RB

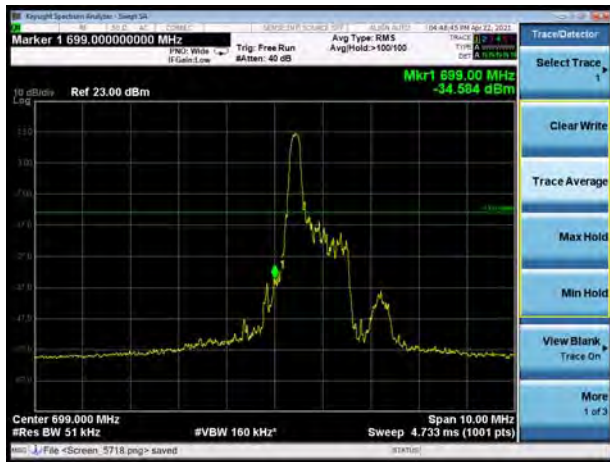

LTE eMTC Band 12 16QAM 3MHz CH-High, 1 RB

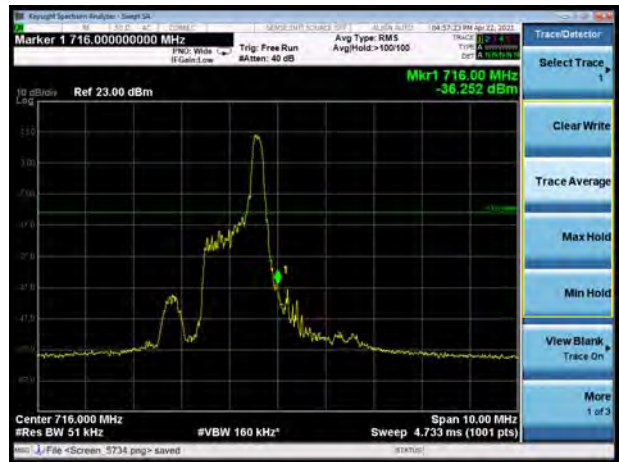

LTE eMTC Band 12 16QAM 3MHz CH-Low, 100%RB

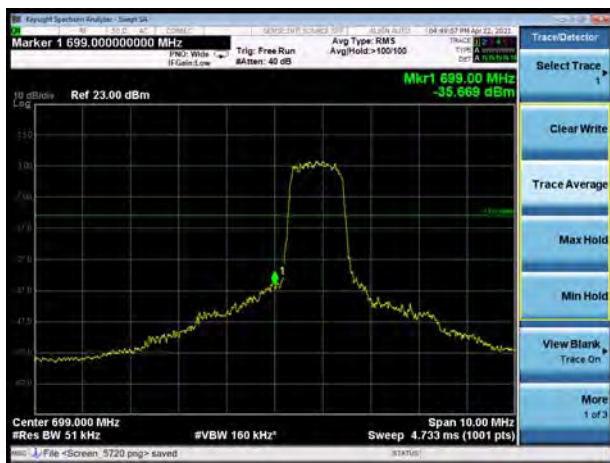

LTE eMTC Band 12 16QAM 3MHz CH-High, 100%RB

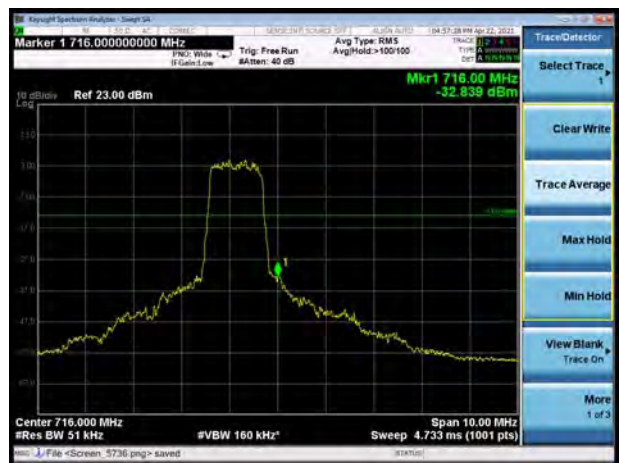

LTE eMTC Band 12 16QAM 5MHz CH-Low, 1 RB

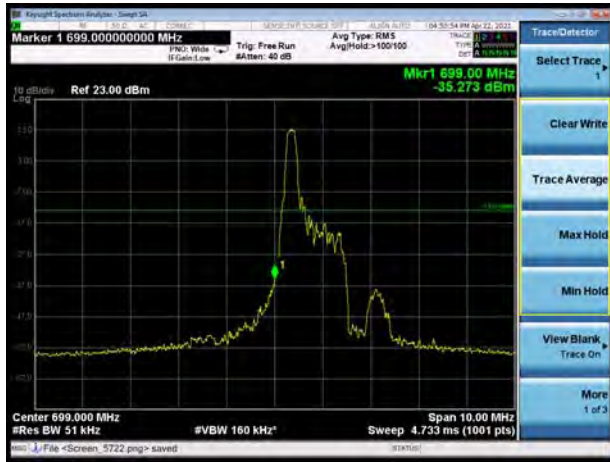

LTE eMTC Band 12 16QAM 5MHz CH-High, 1 RB

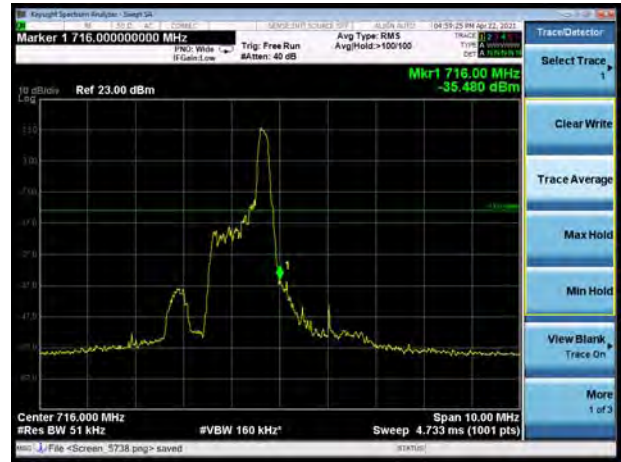

LTE eMTC Band 12 16QAM 5MHz CH-Low, 100%RB

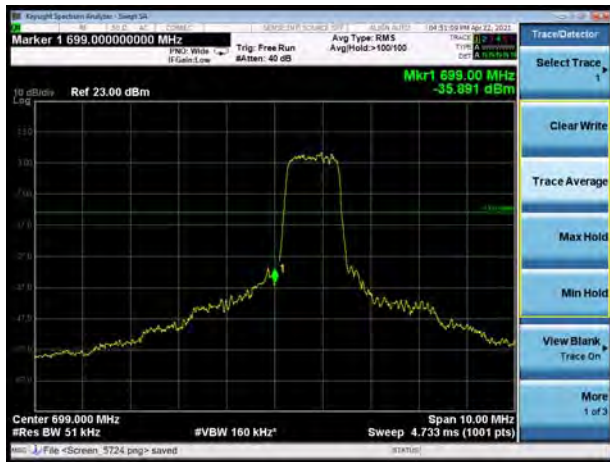

LTE eMTC Band 12 16QAM 5MHz CH-High, 100%RB



LTE eMTC Band 12 16QAM 10MHz CH-Low, 1 RB

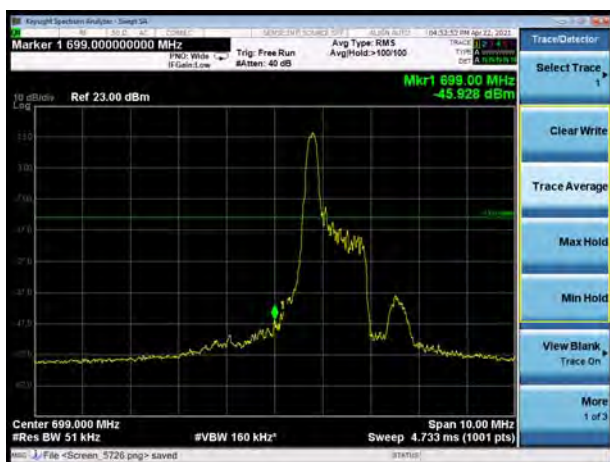

LTE eMTC Band 12 16QAM 10MHz CH-High, 1 RB



LTE eMTC Band 12 16QAM 10MHz CH-Low, 100%RB

LTE eMTC Band 12 16QAM 10MHz CH-High, 100%RB

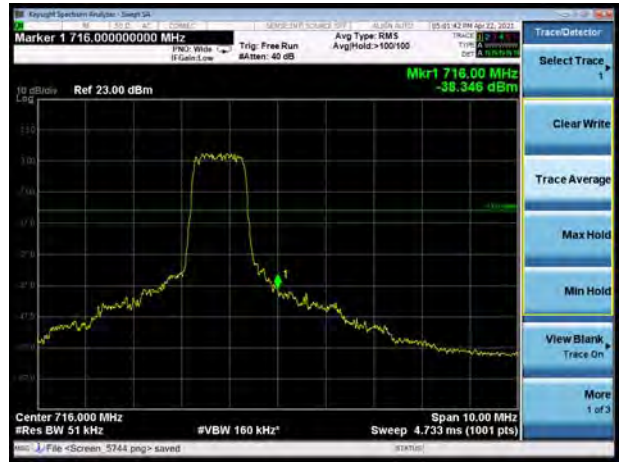
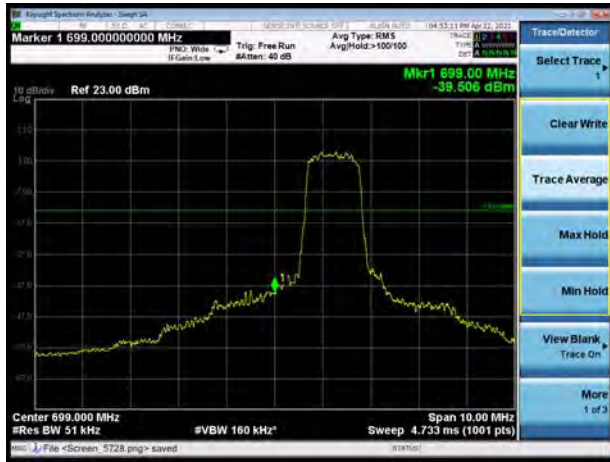

LTE eMTC Band 13 QPSK 5MHz CH-Low, 1 RB (763MHz ~775MHz)

LTE eMTC Band 13 QPSK 10MHz CH-Low, 1 RB (775MHz ~777MHz)

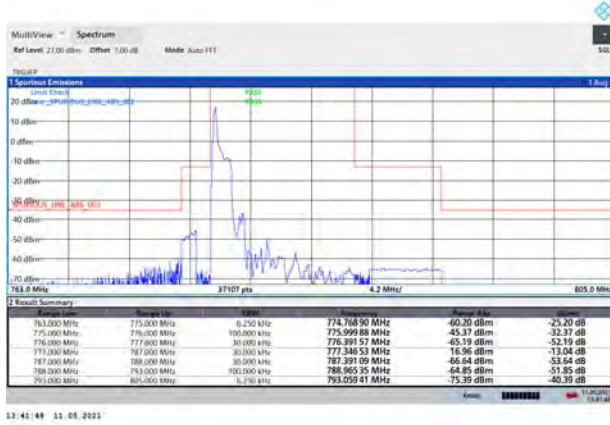

LTE eMTC Band 13 QPSK 5MHz CH-High, 1 RB (787MHz ~793MHz)

LTE eMTC Band 13 QPSK 10MHz CH-High, 1 RB (793MHz ~805MHz)

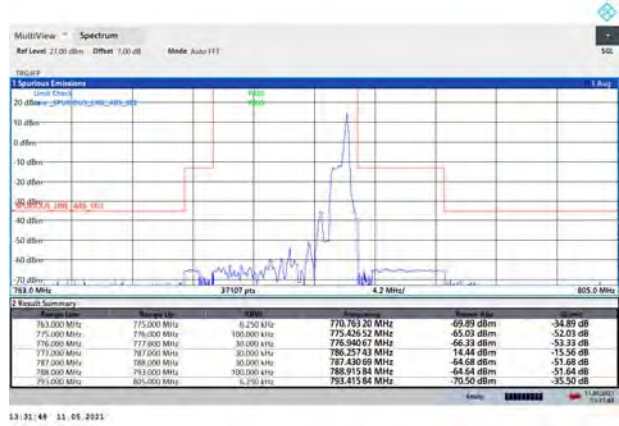

LTE eMTC Band 13 QPSK 5MHz CH-Low, 100%RB (763MHz ~775MHz)



13:47:25 11.05.2021

LTE eMTC Band 13 QPSK 10MHz CH-Low, 100%RB (775MHz ~777MHz)



13:34:13 11.05.2021

LTE eMTC Band 13 QPSK 5MHz CH-High, 100%RB (787MHz ~793MHz)



13:52:24 11.05.2021

LTE eMTC Band 13 QPSK 10MHz CH-High, 100%RB (793MHz ~805MHz)



13:34:49 11.05.2021

LTE eMTC Band 13 16QAM 5MHz CH-Low, 1 RB (763MHz ~775MHz)



13:45:09 11.05.2021

LTE eMTC Band 13 16QAM 10MHz CH-Low, 1 RB (775MHz ~777MHz)



13:35:49 11.05.2021

LTE eMTC Band 13 16QAM 5MHz CH-High, 1 RB (787MHz ~793MHz)

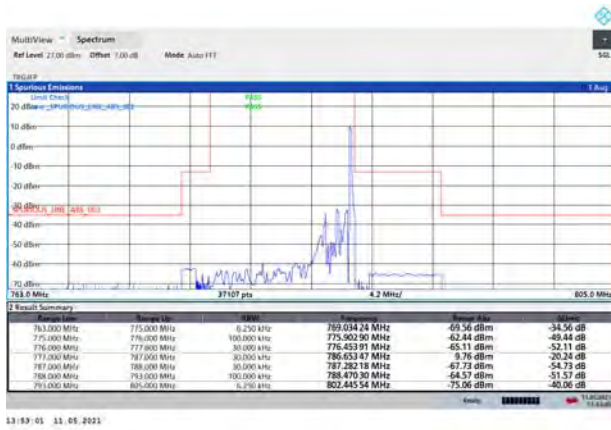

13:53:03 11.05.2021

LTE eMTC Band 13 16QAM 10MHz CH-High, 1 RB (793MHz ~805MHz)



13:37:09 11.05.2021

LTE eMTC Band 13 16QAM 5MHz CH-Low, 100%RB (763MHz ~775MHz)



13:47:25 11.05.2021

LTE eMTC Band 13 16QAM 10MHz CH-Low, 100%RB (775MHz ~777MHz)

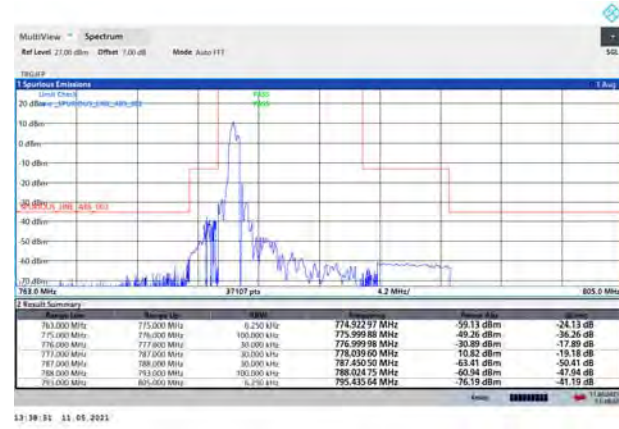

13:18:31 11.05.2021

LTE eMTC Band 13 16QAM 5MHz CH-High, 100%RB (787MHz ~793MHz)



13:14:09 11.05.2021

LTE eMTC Band 13 16QAM 10MHz CH-High, 100%RB (793MHz ~805MHz)



13:39:30 11.05.2021

LTE eMTC Band 66 QPSK 1.4MHz CH-Low, 1 RB



LTE eMTC Band 66 QPSK 1.4MHz CH-High, 1 RB



LTE eMTC Band 66 QPSK 1.4MHz CH-Low, 100%RB

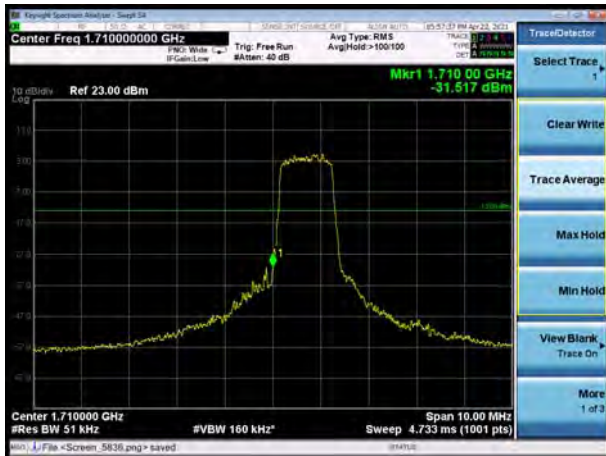

LTE eMTC Band 66 QPSK 1.4MHz CH-High, 100%RB

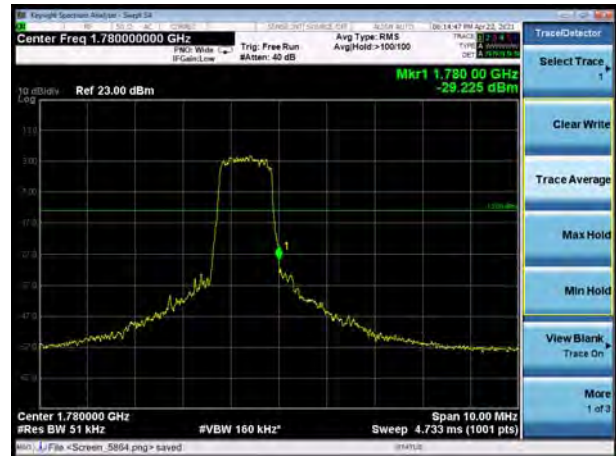

LTE eMTC Band 66 QPSK 3MHz CH-Low, 1 RB



LTE eMTC Band 66 QPSK 3MHz CH-High, 1 RB



LTE eMTC Band 66 QPSK 3MHz CH-Low, 100%RB

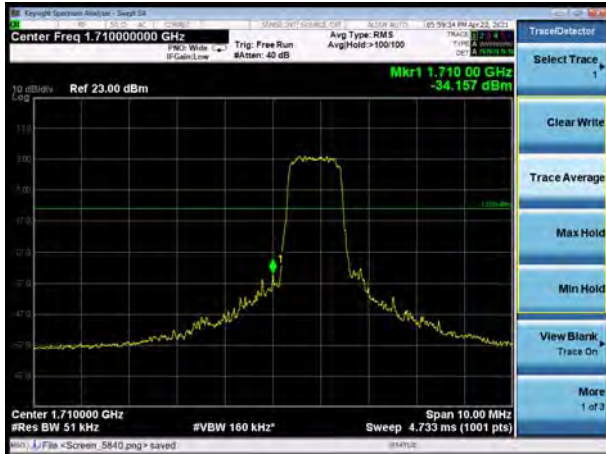

LTE eMTC Band 66 QPSK 3MHz CH-High, 100%RB

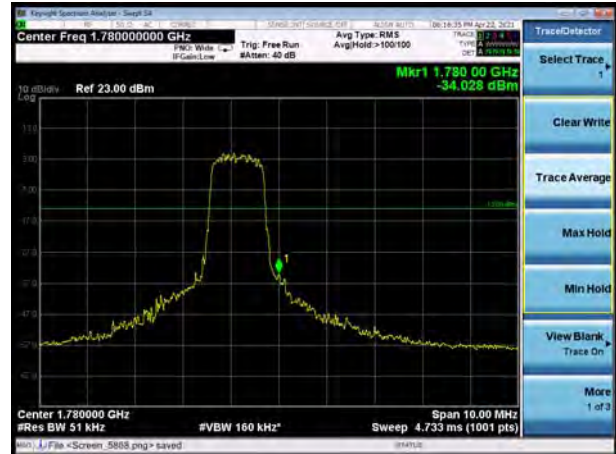

LTE eMTC Band 66 QPSK 5MHz CH-Low, 1 RB



LTE eMTC Band 66 QPSK 5MHz CH-High, 1 RB



LTE eMTC Band 66 QPSK 5MHz CH-Low, 100%RB



LTE eMTC Band 66 QPSK 5MHz CH-High, 100%RB

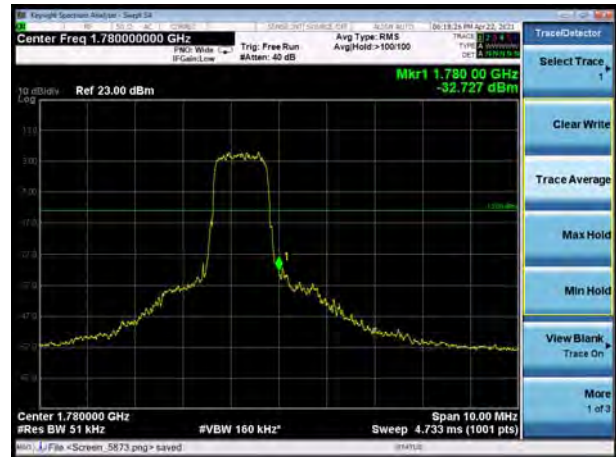

LTE eMTC Band 66 QPSK 10MHz CH-Low, 1 RB



LTE eMTC Band 66 QPSK 10MHz CH-High, 1 RB



LTE eMTC Band 66 QPSK 10MHz CH-Low, 100%RB



LTE eMTC Band 66 QPSK 10MHz CH-High, 100%RB



LTE eMTC Band 66 QPSK 15MHz CH-Low, 1 RB



LTE eMTC Band 66 QPSK 15MHz CH-High, 1 RB



LTE eMTC Band 66 QPSK 15MHz CH-Low, 100%RB



LTE eMTC Band 66 QPSK 15MHz CH-High, 100%RB

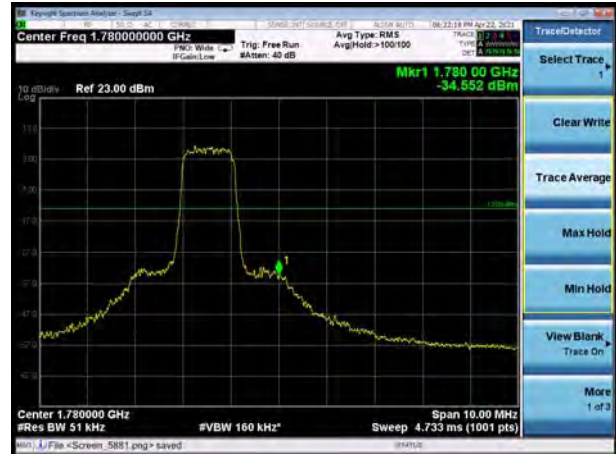

LTE eMTC Band 66 QPSK 20MHz CH-Low, 1 RB



LTE eMTC Band 66 QPSK 20MHz CH-High, 1 RB



LTE eMTC Band 66 QPSK 20MHz CH-Low, 100%RB

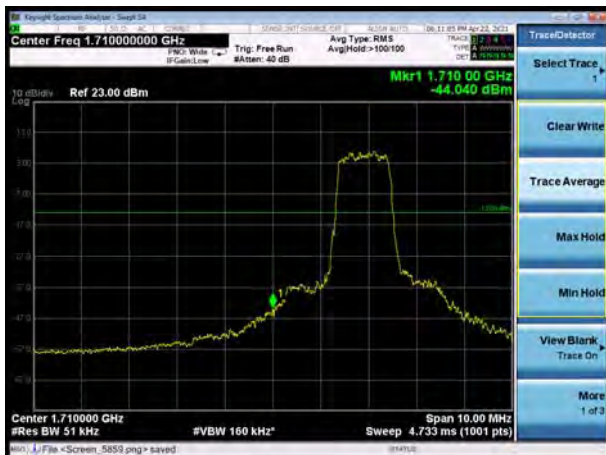

LTE eMTC Band 66 QPSK 20MHz CH-High, 100%RB

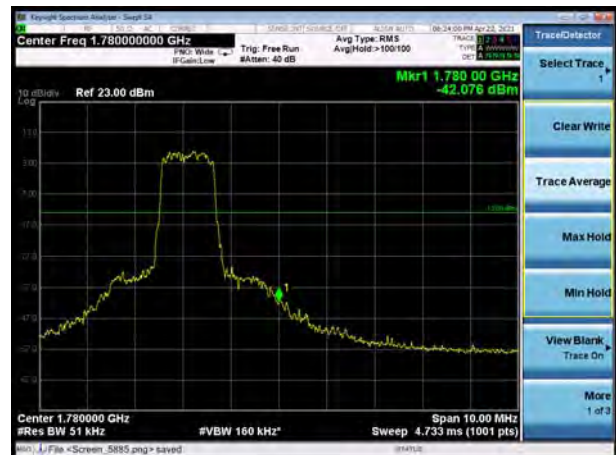

LTE eMTC Band 66 16QAM 1.4MHz CH-Low, 1 RB



LTE eMTC Band 66 16QAM 1.4MHz CH-High, 1 RB



LTE eMTC Band 66 16QAM 1.4MHz CH-Low, 100%RB

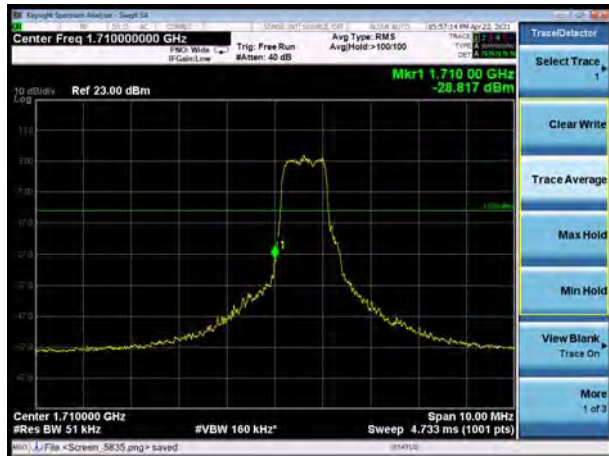

LTE eMTC Band 66 16QAM 1.4MHz CH-High, 100%RB



LTE eMTC Band 66 16QAM 3MHz CH-Low, 1 RB

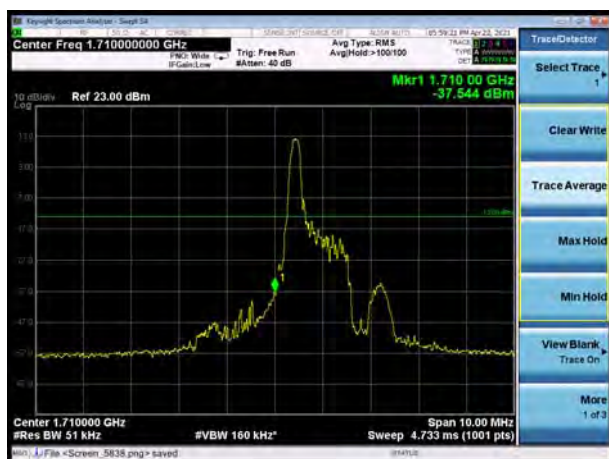

LTE eMTC Band 66 16QAM 3MHz CH-High, 1 RB

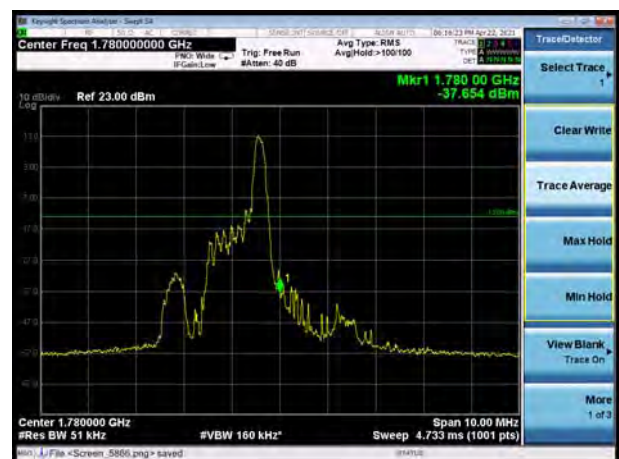

LTE eMTC Band 66 16QAM 3MHz CH-Low, 100%RB



LTE eMTC Band 66 16QAM 3MHz CH-High, 100%RB



LTE eMTC Band 66 16QAM 5MHz CH-Low, 1 RB

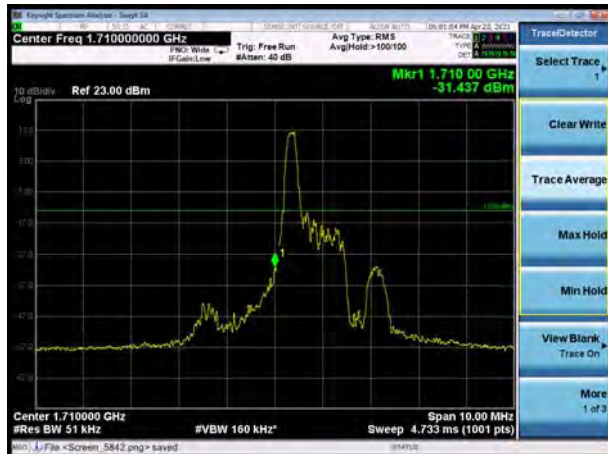

LTE eMTC Band 66 16QAM 5MHz CH-High, 1 RB

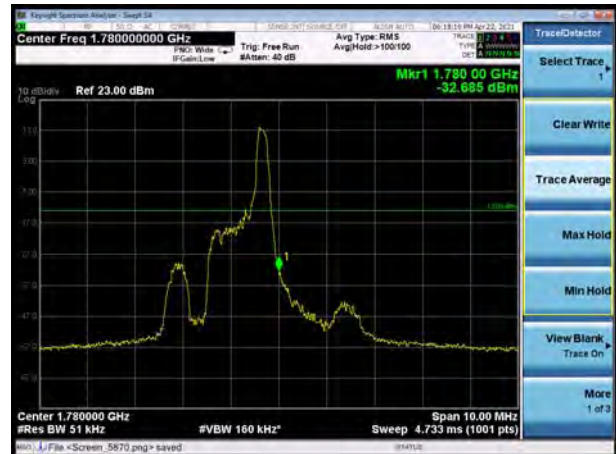

LTE eMTC Band 66 16QAM 5MHz CH-Low, 100%RB

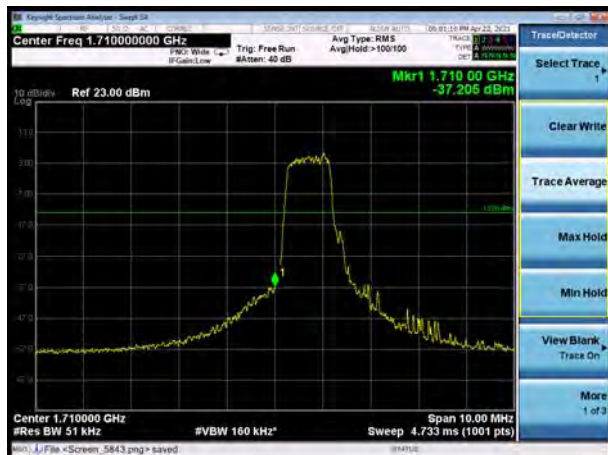

LTE eMTC Band 66 16QAM 5MHz CH-High, 100%RB

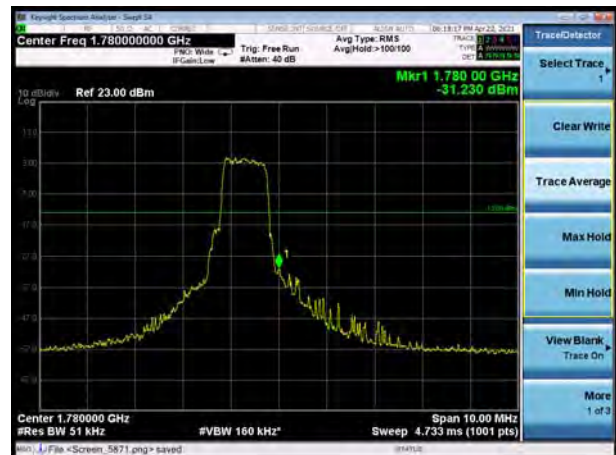

LTE eMTC Band 66 16QAM 10MHz CH-Low, 1 RB



LTE eMTC Band 66 16QAM 10MHz CH-High, 1 RB



LTE eMTC Band 66 16QAM 10MHz CH-Low, 100%RB



LTE eMTC Band 66 16QAM 10MHz CH-High, 100%RB



LTE eMTC Band 66 16QAM 15MHz CH-Low, 1 RB

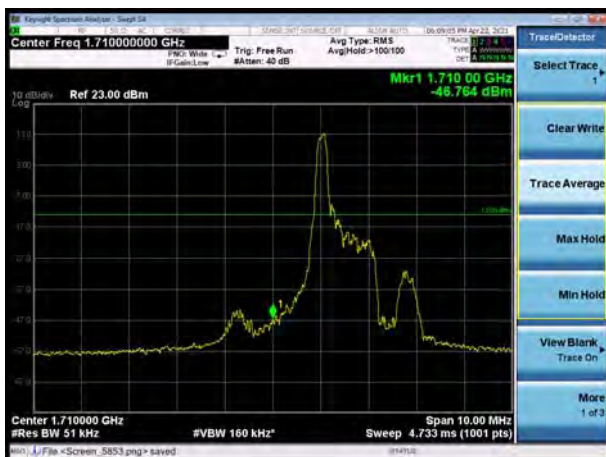

LTE eMTC Band 66 16QAM 15MHz CH-High, 1 RB

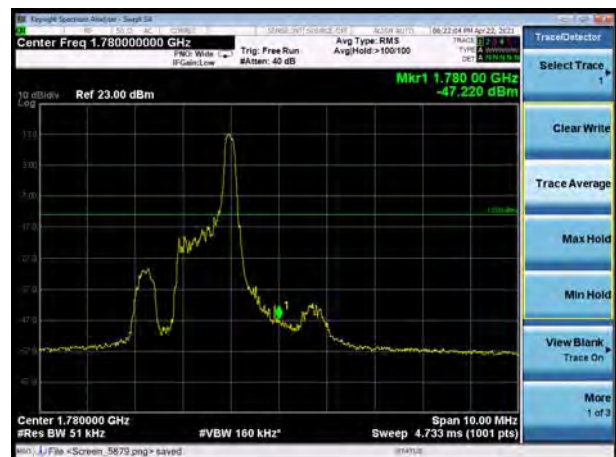

LTE eMTC Band 66 16QAM 15MHz CH-Low, 100%RB



LTE eMTC Band 66 16QAM 15MHz CH-High, 100%RB

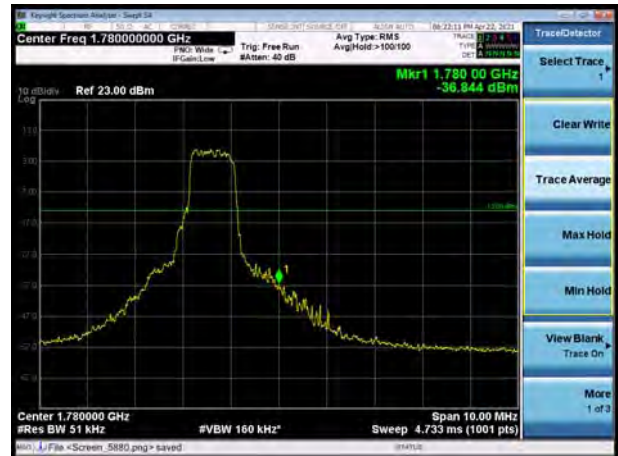

LTE eMTC Band 66 16QAM 20MHz CH-Low, 1 RB

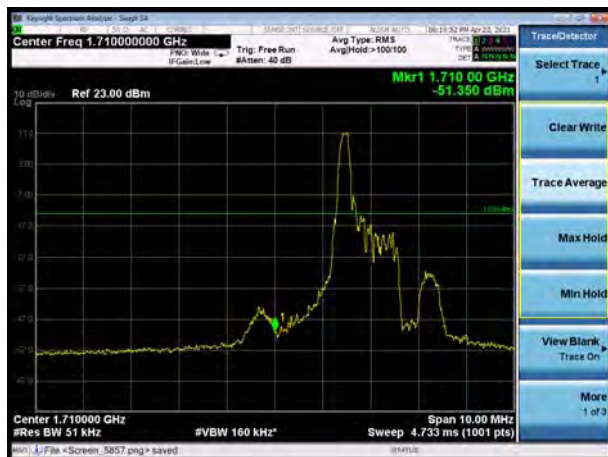

LTE eMTC Band 66 16QAM 20MHz CH-High, 1 RB



LTE eMTC Band 66 16QAM 20MHz CH-Low, 100%RB

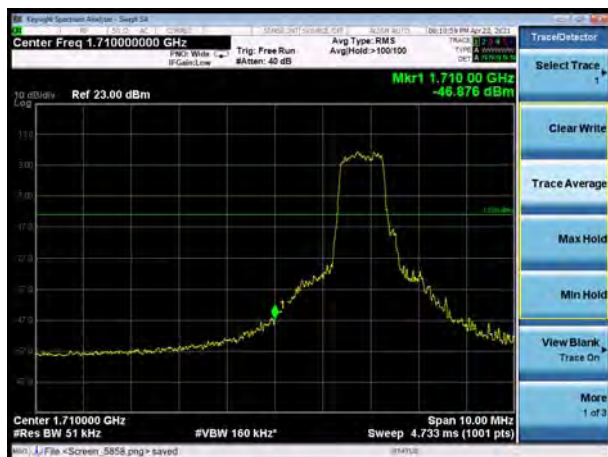

LTE eMTC Band 66 16QAM 20MHz CH-High, 100%RB

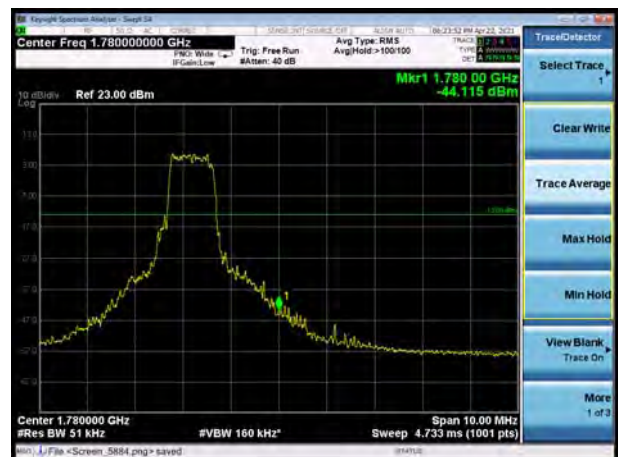

5.4 Peak-to-Average Power Ratio (PAPR)

Ambient condition

Temperature	Relative humidity
20°C ~ 25°C	45% ~ 50%

Methods of Measurement

Measure the total peak power and record as PPk. And measure the total average power and record as PAvg. Both the peak and average power levels must be expressed in the same logarithmic units (e.g., dBm). Determine the PAPR from:

$$\text{PAPR (dB)} = \text{PPk (dBm)} - \text{PAvg (dBm)}.$$

Test Setup

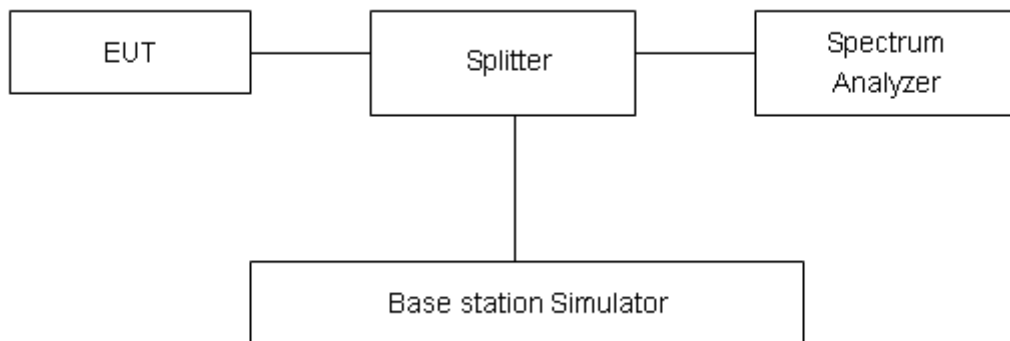

Limits

Rule Part 27.50(d)(5) Equipment employed must be authorized in accordance with the provisions of 24.51. Power measurements for transmissions by stations authorized under this section may be made either in accordance with a Commission-approved average power technique or in compliance with paragraph (d)(6) of this section. In measuring transmissions in this band using an average power technique, the peak-to-average ratio (PAR) of the transmission may not exceed 13 dB.

Measurement Uncertainty

The assessed measurement uncertainty to ensure 95% confidence level for the normal distribution is with the coverage factor $k = 2$, $U = 0.4$ dB.

Test Results

Mode	Bandwidth	Modulation	Channel/ Frequency(MHz)	Peak-to-Average Power Ratio (PAPR)			Limit (dB)	Conclusion	
				Peak(dBm)	Avg(dBm)	PAPR(dB)			
LTE eMTC Band4	1.4MHz	QPSK	20175/1732.5	26.36	16.23	10.13	≤13	PASS	
		16QAM	20175/1732.5	26.82	15.81	11.01	≤13	PASS	
	3MHz	QPSK	20175/1732.5	26.07	15.94	10.13	≤13	PASS	
		16QAM	20175/1732.5	26.95	15.76	11.19	≤13	PASS	
	5MHz	QPSK	20175/1732.5	27.21	17.03	10.18	≤13	PASS	
		16QAM	20175/1732.5	27.08	15.99	11.09	≤13	PASS	
	10MHz	QPSK	20175/1732.5	27.11	17.10	10.01	≤13	PASS	
		16QAM	20175/1732.5	27.46	15.43	12.03	≤13	PASS	
	15MHz	QPSK	20175/1732.5	27.87	18.11	9.76	≤13	PASS	
		16QAM	20175/1732.5	28.12	16.77	11.35	≤13	PASS	
20MHz	QPSK	20175/1732.5	27.96	18.29	9.67	≤13	PASS		
	16QAM	20175/1732.5	28.41	18.40	10.01	≤13	PASS		
Mode	Bandwidth	Modulation	Channel/ Frequency(MHz)	Peak-to-Average Power Ratio (PAPR)			Limit (dB)	Conclusion	
LTE eMTC Band12	1.4MHz	QPSK	23095/707.5	26.41	16.38	10.03	≤13	PASS	
		16QAM	23095/707.5	27.12	16.03	11.09	≤13	PASS	
	3MHz	QPSK	23095/707.5	26.30	15.90	10.40	≤13	PASS	
		16QAM	23095/707.5	27.09	15.27	11.82	≤13	PASS	
	5MHz	QPSK	23095/707.5	27.39	17.23	10.16	≤13	PASS	
		16QAM	23095/707.5	27.31	16.00	11.31	≤13	PASS	
	10MHz	QPSK	23095/707.5	27.36	17.26	10.10	≤13	PASS	
		16QAM	23095/707.5	28.08	16.82	11.26	≤13	PASS	
	Mode	Bandwidth	Modulation	Channel/ Frequency(MHz)	Peak-to-Average Power Ratio (PAPR)			Limit (dB)	Conclusion
	LTE eMTC Band13	5MHz	QPSK	23230/782	27.61	17.39	10.22	≤13	PASS
16QAM			23230/782	27.61	15.95	11.66	≤13	PASS	
10MHz		QPSK	23230/782	27.73	17.38	10.35	≤13	PASS	
		16QAM	23230/782	28.57	17.55	11.02	≤13	PASS	
Mode	Bandwidth	Modulation	Channel/ Frequency(MHz)	Peak-to-Average Power Ratio (PAPR)			Limit (dB)	Conclusion	
LTE eMTC Band66	1.4MHz	QPSK	132322/1745	26.62	16.56	10.06	≤13	PASS	
		16QAM	132322/1745	27.08	16.03	11.05	≤13	PASS	
	3MHz	QPSK	132322/1745	26.35	16.28	10.07	≤13	PASS	
		16QAM	132322/1745	27.12	15.88	11.24	≤13	PASS	
	5MHz	QPSK	132322/1745	27.37	17.14	10.23	≤13	PASS	

		16QAM	132322/1745	27.22	16.12	11.10	≤13	PASS
10MHz		QPSK	132322/1745	27.37	17.29	10.08	≤13	PASS
		16QAM	132322/1745	27.87	17.04	10.83	≤13	PASS
15MHz		QPSK	132322/1745	28.15	18.68	9.47	≤13	PASS
		16QAM	132322/1745	28.53	18.45	10.08	≤13	PASS
20MHz		QPSK	132322/1745	28.12	18.50	9.62	≤13	PASS
		16QAM	132322/1745	28.49	18.15	10.34	≤13	PASS

5.5 Frequency Stability

Ambient condition

Temperature	Relative humidity
20°C ~ 25°C	45% ~ 50%

Method of Measurement

Frequency Stability (Temperature Variation)

The temperature inside the climate chamber is varied from -30°C to +50°C in 10°C step size.

(1) With all power removed, the temperature was decreased to -10°C and permitted to stabilize for three hours.

(2) Measure the carrier frequency with the test equipment in a “call mode”. These measurements should be made within 1 minute of powering up the mobile station, to prevent significant self warming.

(3) Repeat the above measurements at 10°C increments from -30°C to +50°C. Allow at least 1.5 hours at each temperature, un-powered, before making measurements.

Frequency Stability (Voltage Variation)

The frequency stability shall be measured with variation of primary supply voltage as follows:

Primary Supply Voltage: The primary supply voltage is varied from 85% to 115% of the nominal value for non hand-carried battery and AC powered equipment. For hand-carried, battery-powered equipment, primary supply voltage is reduced to the battery operating end point which shall be specified by the manufacturer.

This transceiver is specified to operate with an input voltage of between 3.1 V and 4.2V, with a nominal voltage of 3.3V.

Test setup

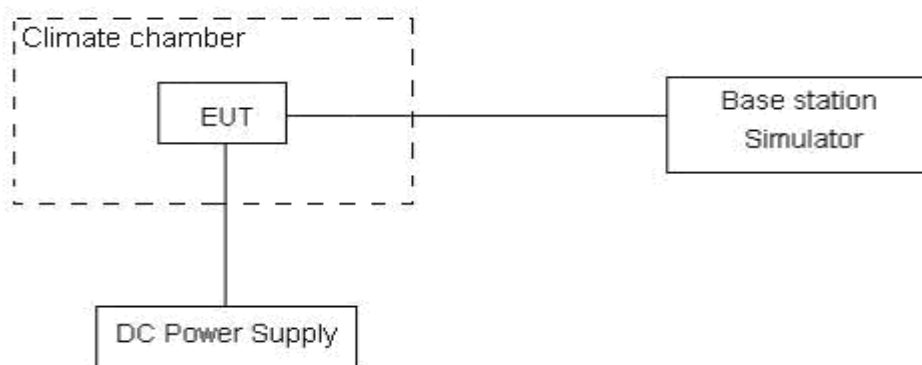

Limits

The frequency stability shall be sufficient to ensure that the fundamental emissions stay within the authorized bands of operation.

Measurement Uncertainty

The assessed measurement uncertainty to ensure 99.75% confidence level for the normal distribution is with the coverage factor $k = 3$, $U=0.01\text{ppm}$.

Test Result

LTE eMTC Band 4						
Condition		Freq.Error (Hz)	Freq.Error (Hz)	Frequency Stability (ppm)	Frequency Stability (ppm)	Verdict
BANDWIDTH	1.4MHz					
Temperature	Voltage	16QAM	QPSK	16QAM	QPSK	
Normal (25°C)	Normal	14.49	10.69	0.00771	0.00568	PASS
Extreme (50°C)		7.79	4.48	0.00415	0.00238	PASS
Extreme (40°C)		6.16	14.25	0.00328	0.00758	PASS
Extreme (30°C)		5.89	1.10	0.00313	0.00059	PASS
Extreme (20°C)		13.41	16.22	0.00713	0.00863	PASS
Extreme (10°C)		3.65	1.79	0.00194	0.00095	PASS
Extreme (0°C)		10.14	10.40	0.00539	0.00553	PASS
Extreme (-10°C)		15.88	7.05	0.00845	0.00375	PASS
Extreme (-20°C)		5.67	8.73	0.00302	0.00464	PASS
Extreme (-30°C)		14.27	2.09	0.00759	0.00111	PASS
25°C	LV	8.95	3.24	0.00476	0.00172	PASS
	HV	11.66	15.53	0.00620	0.00826	PASS
Condition		Freq.Error (Hz)	Freq.Error (Hz)	Frequency Stability (ppm)	Frequency Stability (ppm)	Verdict
BANDWIDTH	3MHz					
Temperature	Voltage	16QAM	QPSK	16QAM	QPSK	
Normal (25°C)	Normal	5.90	9.48	0.00314	0.00504	PASS
Extreme (50°C)		11.36	10.96	0.00604	0.00583	PASS
Extreme (40°C)		17.68	17.34	0.00940	0.00923	PASS
Extreme (30°C)		9.00	16.58	0.00479	0.00882	PASS
Extreme (20°C)		1.44	11.05	0.00077	0.00588	PASS
Extreme (10°C)		13.87	17.80	0.00738	0.00947	PASS
Extreme (0°C)		15.80	4.17	0.00841	0.00222	PASS
Extreme (-10°C)		2.25	5.52	0.00120	0.00294	PASS
Extreme (-20°C)		16.96	13.09	0.00902	0.00696	PASS
Extreme (-30°C)		7.63	16.80	0.00406	0.00894	PASS
25°C	LV	16.55	9.43	0.00880	0.00502	PASS
	HV	9.72	1.17	0.00517	0.00062	PASS
Condition		Freq.Error (Hz)	Freq.Error (Hz)	Frequency Stability (ppm)	Frequency Stability (ppm)	Verdict
BANDWIDTH	5MHz					
Temperature	Voltage	16QAM	QPSK	16QAM	QPSK	
Normal (25°C)	Normal	13.86	14.56	0.00737	0.00774	PASS
Extreme (50°C)		9.00	2.24	0.00479	0.00119	PASS
Extreme (40°C)		7.22	12.74	0.00384	0.00678	PASS

Extreme (30°C)		10.18	1.03	0.00542	0.00055	PASS
Extreme (20°C)		6.83	2.59	0.00363	0.00138	PASS
Extreme (10°C)		7.28	17.58	0.00387	0.00935	PASS
Extreme (0°C)		10.36	9.04	0.00551	0.00481	PASS
Extreme (-10°C)		4.23	6.51	0.00225	0.00346	PASS
Extreme (-20°C)		8.11	1.10	0.00431	0.00058	PASS
Extreme (-30°C)		1.94	10.60	0.00103	0.00564	PASS
25°C	LV	8.21	3.26	0.00437	0.00174	PASS
	HV	11.61	5.18	0.00618	0.00276	PASS
Condition		Freq.Error (Hz)	Freq.Error (Hz)	Frequency Stability (ppm)	Frequency Stability (ppm)	Verdict
BANDWIDTH	10MHz					
Temperature	Voltage	16QAM	QPSK	16QAM	QPSK	
Normal (25°C)	Normal	4.32	9.26	0.00230	0.00493	PASS
Extreme (50°C)		11.77	15.33	0.00626	0.00816	PASS
Extreme (40°C)		6.85	10.87	0.00364	0.00578	PASS
Extreme (30°C)		17.10	13.74	0.00910	0.00731	PASS
Extreme (20°C)		9.56	15.14	0.00508	0.00805	PASS
Extreme (10°C)		9.05	16.42	0.00482	0.00873	PASS
Extreme (0°C)		9.12	13.60	0.00485	0.00724	PASS
Extreme (-10°C)		5.47	2.98	0.00291	0.00158	PASS
Extreme (-20°C)		14.84	16.91	0.00789	0.00899	PASS
Extreme (-30°C)		11.63	9.24	0.00619	0.00492	PASS
25°C	LV	7.18	9.03	0.00382	0.00481	PASS
	HV	16.84	3.10	0.00896	0.00165	PASS
Condition		Freq.Error (Hz)	Freq.Error (Hz)	Frequency Stability (ppm)	Frequency Stability (ppm)	Verdict
BANDWIDTH	15MHz					
Temperature	Voltage	16QAM	QPSK	16QAM	QPSK	
Normal (25°C)	Normal	7.58	16.98	0.00403	0.00903	PASS
Extreme (50°C)		15.92	5.43	0.00847	0.00289	PASS
Extreme (40°C)		15.39	3.70	0.00819	0.00197	PASS
Extreme (30°C)		9.90	3.47	0.00527	0.00185	PASS
Extreme (20°C)		14.87	7.73	0.00791	0.00411	PASS
Extreme (10°C)		10.38	14.42	0.00552	0.00767	PASS
Extreme (0°C)		12.27	1.23	0.00653	0.00066	PASS
Extreme (-10°C)		15.98	17.29	0.00850	0.00920	PASS
Extreme (-20°C)		7.91	2.40	0.00421	0.00127	PASS
Extreme (-30°C)		7.00	7.90	0.00373	0.00420	PASS
25°C	LV	6.63	14.46	0.00353	0.00769	PASS

Condition		Freq.Error (Hz)	Freq.Error (Hz)	Frequency Stability (ppm)	Frequency Stability (ppm)	Verdict
BANDWIDTH	20MHz					
Temperature	Voltage	16QAM	QPSK	16QAM	QPSK	
Normal (25°C)	Normal	5.69	2.98	0.00303	0.00158	PASS
Extreme (50°C)		1.63	15.73	0.00087	0.00837	PASS
Extreme (40°C)		14.93	8.03	0.00794	0.00427	PASS
Extreme (30°C)		5.95	5.43	0.00317	0.00289	PASS
Extreme (20°C)		7.92	13.39	0.00421	0.00712	PASS
Extreme (10°C)		8.89	16.33	0.00473	0.00869	PASS
Extreme (0°C)		8.92	2.08	0.00475	0.00111	PASS
Extreme (-10°C)		1.54	10.23	0.00082	0.00544	PASS
Extreme (-20°C)		17.06	2.77	0.00908	0.00148	PASS
Extreme (-30°C)		17.69	1.49	0.00941	0.00079	PASS
25°C		LV	11.16	7.76	0.00594	0.00413
	HV	6.85	3.13	0.00365	0.00167	PASS

LTE eMTC Band 12						
Condition		Freq.Error (Hz)	Freq.Error (Hz)	Frequency Stability (ppm)	Frequency Stability (ppm)	Verdict
BANDWIDTH	1.4MHz					
Temperature	Voltage	16QAM	QPSK	16QAM	QPSK	
Normal (25°C)	Normal	4.93	5.29	0.00262	0.00281	PASS
Extreme (50°C)		11.76	8.80	0.00626	0.00468	PASS
Extreme (40°C)		3.87	7.30	0.00206	0.00388	PASS
Extreme (30°C)		17.53	7.79	0.00932	0.00415	PASS
Extreme (20°C)		1.70	2.47	0.00091	0.00131	PASS
Extreme (10°C)		3.40	4.89	0.00181	0.00260	PASS
Extreme (0°C)		9.15	15.12	0.00487	0.00805	PASS
Extreme (-10°C)		1.96	7.14	0.00104	0.00380	PASS
Extreme (-20°C)		4.75	4.86	0.00253	0.00258	PASS
Extreme (-30°C)		5.97	8.65	0.00318	0.00460	PASS
25°C		LV	15.51	17.73	0.00825	0.00943
	HV	1.64	1.90	0.00087	0.00101	PASS
Condition		Freq.Error (Hz)	Freq.Error (Hz)	Frequency Stability (ppm)	Frequency Stability (ppm)	Verdict
BANDWIDTH	3MHz					
Temperature	Voltage	16QAM	QPSK	16QAM	QPSK	
Normal (25°C)	Normal	4.19	1.10	0.00223	0.00059	PASS

Extreme (50°C)		4.59	2.35	0.00244	0.00125	PASS
Extreme (40°C)		17.88	10.99	0.00951	0.00585	PASS
Extreme (30°C)		4.16	13.39	0.00221	0.00712	PASS
Extreme (20°C)		15.65	2.06	0.00833	0.00109	PASS
Extreme (10°C)		11.80	10.17	0.00628	0.00541	PASS
Extreme (0°C)		6.18	3.85	0.00329	0.00205	PASS
Extreme (-10°C)		17.96	9.77	0.00955	0.00520	PASS
Extreme (-20°C)		2.90	14.87	0.00155	0.00791	PASS
Extreme (-30°C)		2.68	8.39	0.00143	0.00446	PASS
25°C	LV	11.26	1.44	0.00599	0.00077	PASS
	HV	14.61	7.56	0.00777	0.00402	PASS
Condition		Freq.Error (Hz)	Freq.Error (Hz)	Frequency Stability (ppm)	Frequency Stability (ppm)	Verdict
BANDWIDTH	5MHz					
Temperature	Voltage	16QAM	QPSK	16QAM	QPSK	
Normal (25°C)	Normal	8.15	11.08	0.00434	0.00590	PASS
Extreme (50°C)		6.24	17.08	0.00332	0.00908	PASS
Extreme (40°C)		8.21	10.40	0.00437	0.00553	PASS
Extreme (30°C)		7.22	6.54	0.00384	0.00348	PASS
Extreme (20°C)		2.76	12.03	0.00147	0.00640	PASS
Extreme (10°C)		7.21	6.35	0.00383	0.00338	PASS
Extreme (0°C)		3.91	5.87	0.00208	0.00312	PASS
Extreme (-10°C)		4.60	13.57	0.00244	0.00722	PASS
Extreme (-20°C)		4.78	5.43	0.00254	0.00289	PASS
Extreme (-30°C)		5.75	7.60	0.00306	0.00404	PASS
25°C	LV	7.76	8.30	0.00413	0.00441	PASS
	HV	1.83	9.87	0.00097	0.00525	PASS
Condition		Freq.Error (Hz)	Freq.Error (Hz)	Frequency Stability (ppm)	Frequency Stability (ppm)	Verdict
BANDWIDTH	10MHz					
Temperature	Voltage	16QAM	QPSK	16QAM	QPSK	
Normal (25°C)	Normal	16.67	17.92	0.00887	0.00953	PASS
Extreme (50°C)		11.37	11.30	0.00605	0.00601	PASS
Extreme (40°C)		10.83	10.58	0.00576	0.00563	PASS
Extreme (30°C)		16.48	8.93	0.00877	0.00475	PASS
Extreme (20°C)		13.53	5.55	0.00719	0.00295	PASS
Extreme (10°C)		13.91	15.85	0.00740	0.00843	PASS
Extreme (0°C)		11.66	17.47	0.00620	0.00929	PASS
Extreme (-10°C)		14.15	2.24	0.00753	0.00119	PASS
Extreme (-20°C)		13.22	11.65	0.00703	0.00620	PASS

Extreme (-30°C)		2.01	16.00	0.00107	0.00851	PASS
25°C	LV	1.16	14.22	0.00062	0.00756	PASS
	HV	7.47	15.98	0.00397	0.00850	PASS
LTE eMTC Band 13						
Condition		Freq.Error (Hz)	Freq.Error (Hz)	Frequency Stability (ppm)	Frequency Stability (ppm)	Verdict
BANDWIDTH	5MHz					
Temperature	Voltage	16QAM	QPSK	16QAM	QPSK	
Normal (25°C)	Normal	16.90	2.94	0.00899	0.00157	PASS
Extreme (50°C)		6.77	14.15	0.00360	0.00753	PASS
Extreme (40°C)		10.64	10.20	0.00566	0.00542	PASS
Extreme (30°C)		6.52	8.57	0.00347	0.00456	PASS
Extreme (20°C)		8.97	5.04	0.00477	0.00268	PASS
Extreme (10°C)		1.46	12.82	0.00078	0.00682	PASS
Extreme (0°C)		13.99	5.22	0.00744	0.00278	PASS
Extreme (-10°C)		1.38	8.09	0.00073	0.00430	PASS
Extreme (-20°C)		9.05	17.76	0.00482	0.00945	PASS
Extreme (-30°C)		8.29	1.04	0.00441	0.00055	PASS
25°C		LV	3.89	7.17	0.00207	0.00381
	HV	14.11	6.14	0.00750	0.00327	PASS
Condition		Freq.Error (Hz)	Freq.Error (Hz)	Frequency Stability (ppm)	Frequency Stability (ppm)	Verdict
BANDWIDTH	10MHz					
Temperature	Voltage	16QAM	QPSK	16QAM	QPSK	
Normal (25°C)	Normal	11.04	15.31	0.00587	0.00814	PASS
Extreme (50°C)		6.82	2.74	0.00363	0.00146	PASS
Extreme (40°C)		1.88	7.22	0.00100	0.00384	PASS
Extreme (30°C)		6.26	8.15	0.00333	0.00434	PASS
Extreme (20°C)		15.75	14.55	0.00838	0.00774	PASS
Extreme (10°C)		7.32	9.36	0.00389	0.00498	PASS
Extreme (0°C)		11.66	5.57	0.00620	0.00296	PASS
Extreme (-10°C)		9.66	10.66	0.00514	0.00567	PASS
Extreme (-20°C)		6.18	10.93	0.00329	0.00581	PASS
Extreme (-30°C)		14.02	4.73	0.00746	0.00252	PASS
25°C		LV	2.69	17.07	0.00143	0.00908
	HV	13.63	2.30	0.00725	0.00122	PASS

LTE eMTC Band 66						
Condition		Freq.Error (Hz)	Freq.Error (Hz)	Frequency Stability (ppm)	Frequency Stability (ppm)	Verdict
BANDWIDTH	1.4MHz					
Temperature	Voltage	16QAM	QPSK	16QAM	QPSK	
Normal (25°C)	Normal	14.74	8.30	0.00784	0.00442	PASS
Extreme (50°C)		6.64	7.17	0.00353	0.00382	PASS
Extreme (40°C)		2.96	12.98	0.00157	0.00691	PASS
Extreme (30°C)		6.74	9.29	0.00358	0.00494	PASS
Extreme (20°C)		11.74	10.59	0.00625	0.00563	PASS
Extreme (10°C)		5.12	15.78	0.00272	0.00839	PASS
Extreme (0°C)		1.27	4.27	0.00067	0.00227	PASS
Extreme (-10°C)		4.24	8.62	0.00225	0.00458	PASS
Extreme (-20°C)		9.03	1.97	0.00480	0.00105	PASS
Extreme (-30°C)		11.15	2.28	0.00593	0.00121	PASS
25°C	LV	1.05	2.34	0.00056	0.00125	PASS
	HV	7.18	17.55	0.00382	0.00933	PASS
Condition		Freq.Error (Hz)	Freq.Error (Hz)	Frequency Stability (ppm)	Frequency Stability (ppm)	Verdict
BANDWIDTH	3MHz					
Temperature	Voltage	16QAM	QPSK	16QAM	QPSK	
Normal (25°C)	Normal	17.36	11.17	0.00924	0.00594	PASS
Extreme (50°C)		12.17	6.42	0.00647	0.00342	PASS
Extreme (40°C)		17.79	4.87	0.00946	0.00259	PASS
Extreme (30°C)		13.38	12.35	0.00712	0.00657	PASS
Extreme (20°C)		8.51	15.47	0.00453	0.00823	PASS
Extreme (10°C)		14.77	4.38	0.00786	0.00233	PASS
Extreme (0°C)		6.80	16.56	0.00362	0.00881	PASS
Extreme (-10°C)		13.40	14.93	0.00713	0.00794	PASS
Extreme (-20°C)		11.44	13.02	0.00608	0.00693	PASS
Extreme (-30°C)		12.14	4.72	0.00646	0.00251	PASS
25°C	LV	4.53	16.16	0.00241	0.00859	PASS
	HV	17.96	4.98	0.00956	0.00265	PASS
Condition		Freq.Error (Hz)	Freq.Error (Hz)	Frequency Stability (ppm)	Frequency Stability (ppm)	Verdict
BANDWIDTH	5MHz					
Temperature	Voltage	16QAM	QPSK	16QAM	QPSK	
Normal (25°C)	Normal	3.94	17.06	0.00210	0.00907	PASS
Extreme (50°C)		3.35	3.27	0.00178	0.00174	PASS
Extreme (40°C)		9.54	6.47	0.00507	0.00344	PASS

Extreme (30°C)		1.26	11.77	0.00067	0.00626	PASS
Extreme (20°C)		12.86	6.03	0.00684	0.00321	PASS
Extreme (10°C)		12.85	17.31	0.00683	0.00921	PASS
Extreme (0°C)		15.82	10.42	0.00842	0.00554	PASS
Extreme (-10°C)		12.09	1.69	0.00643	0.00090	PASS
Extreme (-20°C)		13.30	2.63	0.00708	0.00140	PASS
Extreme (-30°C)		12.37	15.03	0.00658	0.00800	PASS
25°C	LV	6.91	10.28	0.00367	0.00547	PASS
	HV	9.51	6.18	0.00506	0.00329	PASS
Condition		Freq.Error (Hz)	Freq.Error (Hz)	Frequency Stability (ppm)	Frequency Stability (ppm)	Verdict
BANDWIDTH	10MHz					
Temperature	Voltage	16QAM	QPSK	16QAM	QPSK	
Normal (25°C)	Normal	4.59	8.40	0.00244	0.00447	PASS
Extreme (50°C)		12.90	4.24	0.00686	0.00226	PASS
Extreme (40°C)		12.46	4.96	0.00663	0.00264	PASS
Extreme (30°C)		4.17	4.87	0.00222	0.00259	PASS
Extreme (20°C)		1.36	17.21	0.00072	0.00916	PASS
Extreme (10°C)		7.40	1.31	0.00394	0.00069	PASS
Extreme (0°C)		9.67	6.69	0.00514	0.00356	PASS
Extreme (-10°C)		4.02	12.86	0.00214	0.00684	PASS
Extreme (-20°C)		14.42	14.00	0.00767	0.00745	PASS
Extreme (-30°C)		9.92	9.31	0.00528	0.00495	PASS
25°C	LV	14.69	6.54	0.00781	0.00348	PASS
	HV	13.79	2.50	0.00734	0.00133	PASS
Condition		Freq.Error (Hz)	Freq.Error (Hz)	Frequency Stability (ppm)	Frequency Stability (ppm)	Verdict
BANDWIDTH	15MHz					
Temperature	Voltage	16QAM	QPSK	16QAM	QPSK	
Normal (25°C)	Normal	9.25	10.97	0.00492	0.00584	PASS
Extreme (50°C)		1.79	2.74	0.00095	0.00146	PASS
Extreme (40°C)		16.29	14.16	0.00866	0.00753	PASS
Extreme (30°C)		8.13	15.01	0.00432	0.00798	PASS
Extreme (20°C)		5.30	4.39	0.00282	0.00233	PASS
Extreme (10°C)		15.19	4.46	0.00808	0.00237	PASS
Extreme (0°C)		11.12	14.04	0.00592	0.00747	PASS
Extreme (-10°C)		8.70	5.28	0.00463	0.00281	PASS
Extreme (-20°C)		1.96	10.34	0.00105	0.00550	PASS
Extreme (-30°C)		3.14	2.43	0.00167	0.00129	PASS
25°C	LV	7.24	1.62	0.00385	0.00086	PASS

Condition		Freq.Error (Hz)	Freq.Error (Hz)	Frequency Stability (ppm)	Frequency Stability (ppm)	Verdict
BANDWIDTH	20MHz	16QAM	QPSK	16QAM	QPSK	
Temperature	Voltage	16QAM	QPSK	16QAM	QPSK	
Normal (25°C)	Normal	1.63	17.40	0.00087	0.00925	PASS
Extreme (50°C)		1.34	7.34	0.00071	0.00391	PASS
Extreme (40°C)		9.34	9.05	0.00497	0.00482	PASS
Extreme (30°C)		1.06	5.51	0.00057	0.00293	PASS
Extreme (20°C)		5.67	9.75	0.00302	0.00518	PASS
Extreme (10°C)		16.83	7.49	0.00895	0.00398	PASS
Extreme (0°C)		11.57	7.96	0.00616	0.00423	PASS
Extreme (-10°C)		14.87	16.33	0.00791	0.00869	PASS
Extreme (-20°C)		16.01	14.72	0.00852	0.00783	PASS
Extreme (-30°C)		9.49	11.70	0.00505	0.00622	PASS
25°C	LV	11.41	17.45	0.00607	0.00928	PASS
	HV	14.27	8.54	0.00759	0.00454	PASS

5.6 Spurious Emissions at Antenna Terminals

Ambient condition

Temperature	Relative humidity
20°C ~ 25°C	45% ~ 50%

Method of Measurement

The EUT was connected to Spectrum Analyzer and Base Station Simulator via power Splitter. The measurement is carried out using a spectrum analyzer. The spectrum analyzer scans from 9kHz to the 10th harmonic of the carrier. The peak detector is used.

RBW is set to 100kHz, VBW is set to 300kHz for 30MHz~1GHz

RBW is set to 1MHz, VBW is set to 3MHz for above 1GHz, Sweep is set to ATUO.

RBW is set to 1 kHz (0.009MHz~ 0.15 MHz),

RBW is set to 10 kHz (0.15 MHz~ 30 MHz)

RBW is set to 100 kHz (30MHz~1000 MHz)

RBW is set to 1000 kHz (above 1000MHz)

Of those disturbances below (limit – 20 dB), the mark is not required for the EUT.

The modulation mode and RB allocation refer to section 5.1, using the maximum output power configuration.

Test setup

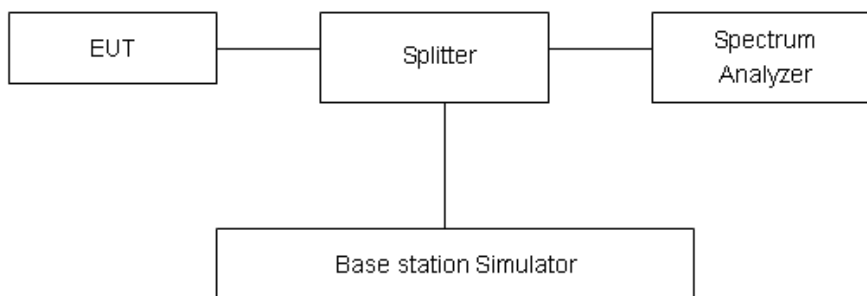

Limits

Rule Part 27.53(h) specifies that “for operations in the 1695-1710 MHz, 1710-1755 MHz, 1755-1780 MHz, 1915-1920 MHz, 1995-2000 MHz, 2000-2020 MHz, 2110-2155 MHz, 2155-2180 MHz, and 2180-2200 bands, the power of any emission outside a licensee's frequency block shall be attenuated below the transmitter power (P) in watts by at least $43 + 10 \log_{10}(P)$ dB..”

Rule Part 27.53 (g) For operations in the 600 MHz band and the 698-746 MHz band, the power of any emission outside a licensee's frequency band(s) of operation shall be attenuated below the transmitter power (P) within the licensed band(s) of operation, measured in watts, by at least $43 + 10 \log(P)$ dB. Compliance with this provision is based on the use of measurement instrumentation employing a resolution bandwidth of 100 kilohertz or greater. However, in the 100 kilohertz bands

immediately outside and adjacent to a licensee's frequency block, a resolution bandwidth of at least 30 kHz may be employed.

Rule Part 27.53(f) For operations in the 746-758 MHz, 775-788 MHz, and 805-806 MHz bands, emissions in the band 1559-1610 MHz shall be limited to -70 dBW/MHz equivalent isotropically radiated power (EIRP) for wideband signals, and -80 dBW EIRP for discrete emissions of less than 700 Hz bandwidth. For the purpose of equipment authorization, a transmitter shall be tested with an antenna that is representative of the type that will be used with the equipment in normal operation.

Part 27.53 (c) For operations in the 746-758 MHz band and the 776-788 MHz band, the power of any emission outside the licensee's frequency band(s) of operation shall be attenuated below the transmitter power (P) within the licensed band(s) of operation, measured in watts, in accordance with the following:

- (1) On any frequency outside the 746-758 MHz band, the power of any emission shall be attenuated outside the band below the transmitter power (P) by at least $43 + 10 \log (P)$ dB;
- (2) On any frequency outside the 776-788 MHz band, the power of any emission shall be attenuated outside the band below the transmitter power (P) by at least $43 + 10 \log (P)$ dB;
- (3) On all frequencies between 763-775 MHz and 793-805 MHz, by a factor not less than $76 + 10 \log (P)$ dB in a 6.25 kHz band segment, for base and fixed stations;
- (4) On all frequencies between 763-775 MHz and 793-805 MHz, by a factor not less than $65 + 10 \log (P)$ dB in a 6.25 kHz band segment, for mobile and portable stations;
- (5) Compliance with the provisions of paragraphs (c)(1) and (c)(2) of this section is based on the use of measurement instrumentation employing a resolution bandwidth of 100 kHz or greater. However, in the 100 kHz bands immediately outside and adjacent to the frequency block, a resolution bandwidth of at least 30 kHz may be employed;

Part 27.53(a)/(h)/(g) Limit		-13 dBm
Part 27.53(f) Limit	Limit out of the band 1559-1610 MHz	-13 dBm
	Limit in the band 1559-1610 MHz	-40 dBm

Measurement Uncertainty

The assessed measurement uncertainty to ensure 99.75% confidence level for the normal distribution is with the coverage factor $k = 1.96$.

Frequency	Uncertainty
9kHz-1GHz	0.684 dB
1GHz-27GHz	1.407 dB

Test Result

Sweep the whole frequency band through the range from 9kHz to the 10th harmonic of the carrier, the emissions more than 20 dB below the limit are not reported.
The signal beyond the limit is carrier.

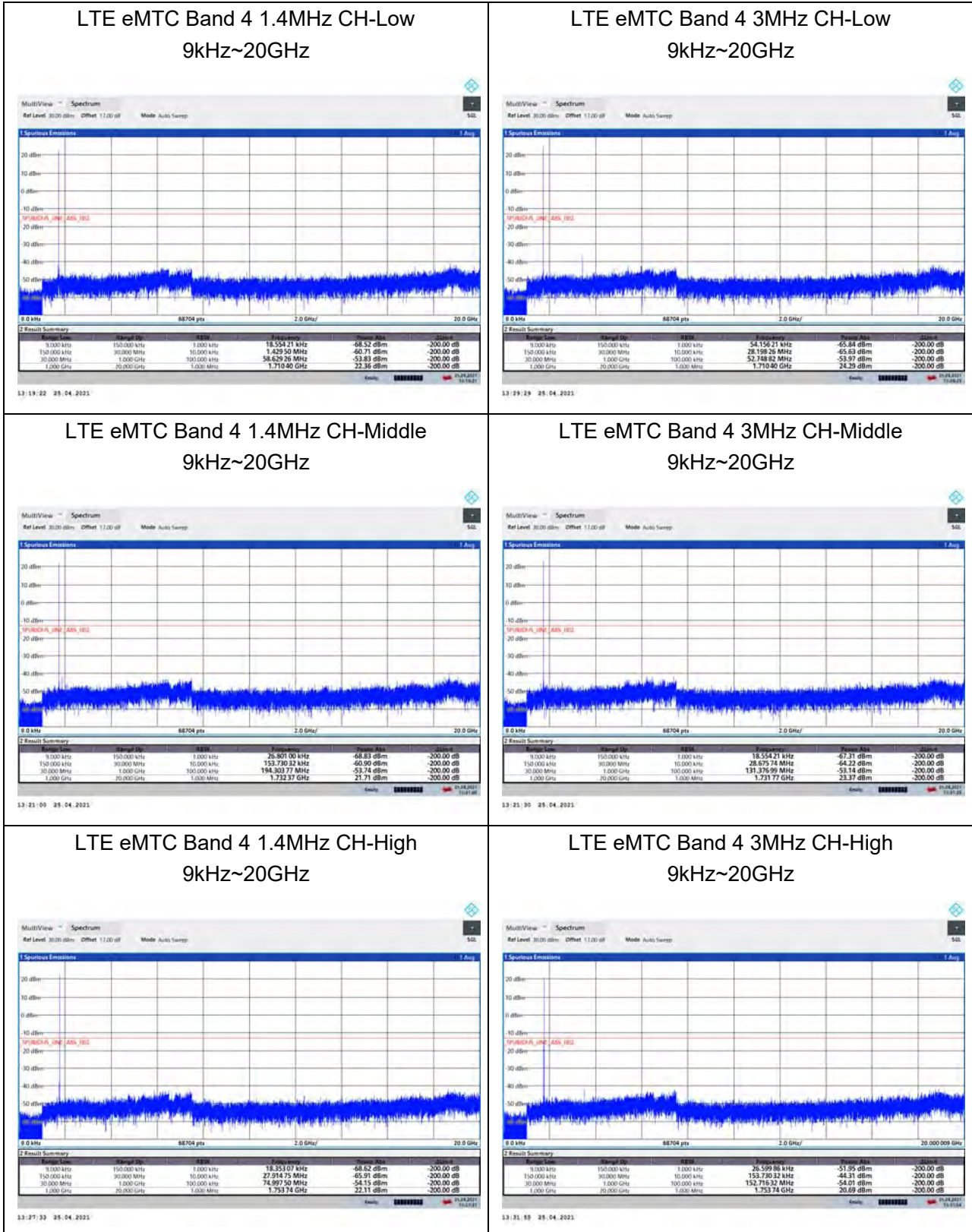

LTE eMTC Band 4 5MHz CH-Low 9kHz~20GHz

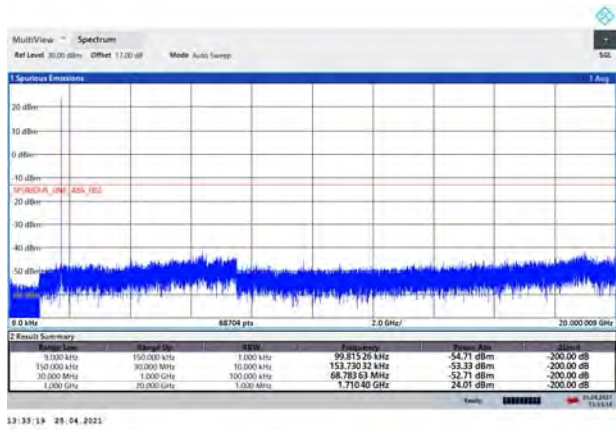

LTE eMTC Band 4 10MHz CH-Low 9kHz~20GHz

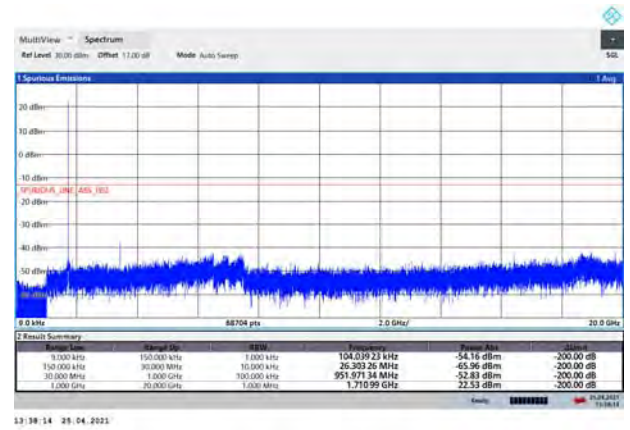

LTE eMTC Band 4 5MHz CH-Middle 9kHz~20GHz

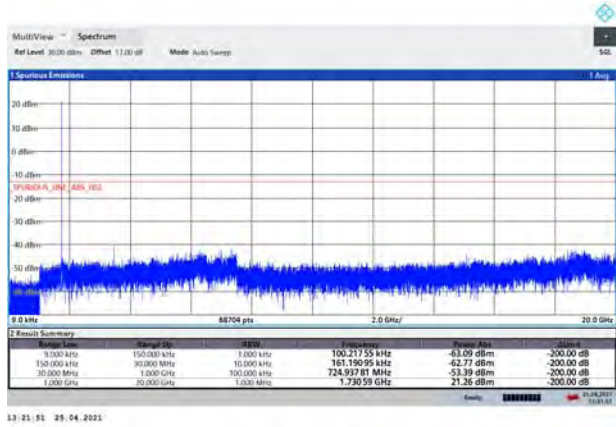

LTE eMTC Band 4 10MHz CH-Middle 9kHz~20GHz

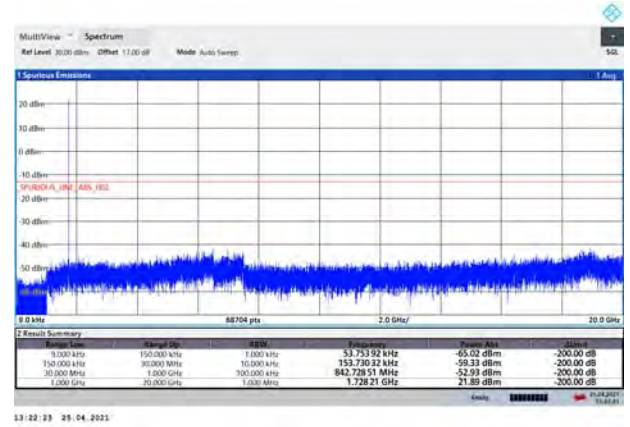

LTE eMTC Band 4 5MHz CH-High 9kHz~20GHz

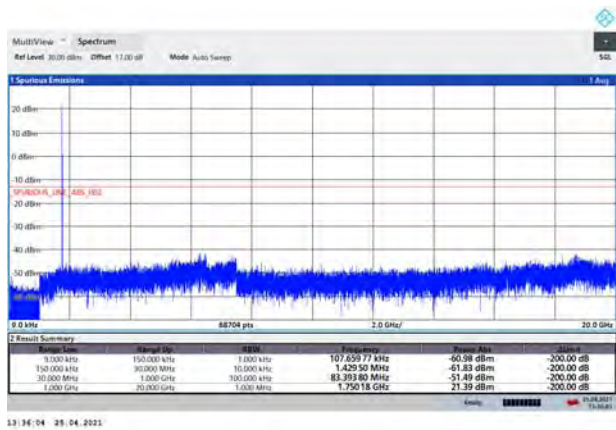

LTE eMTC Band 4 10MHz CH-High 9kHz~20GHz

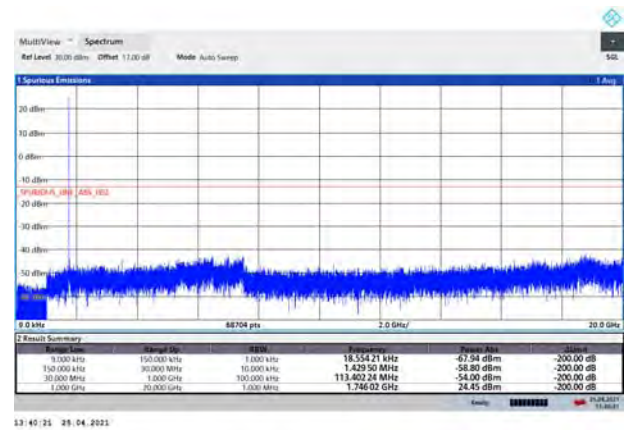

LTE eMTC Band 4 15MHz CH-Low 9kHz~20GHz

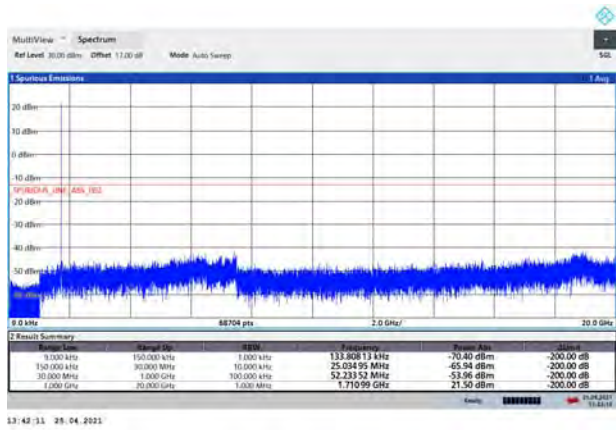

LTE eMTC Band 4 20MHz CH-Low 9kHz~20GHz

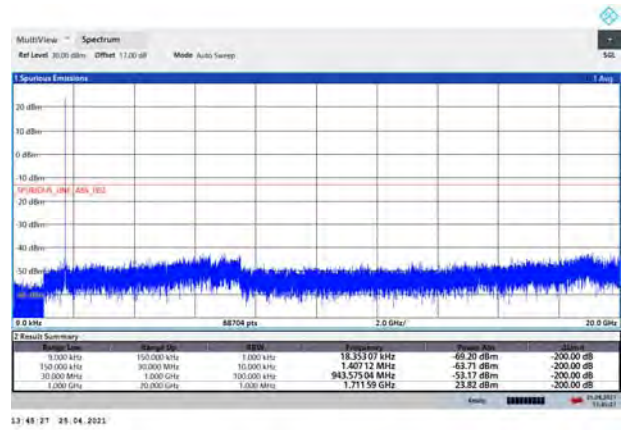

LTE eMTC Band 4 15MHz CH-Middle 9kHz~20GHz

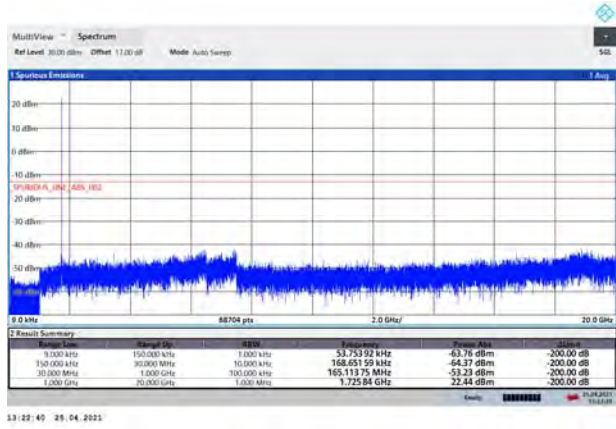

LTE eMTC Band 4 20MHz CH-Middle 9kHz~20GHz

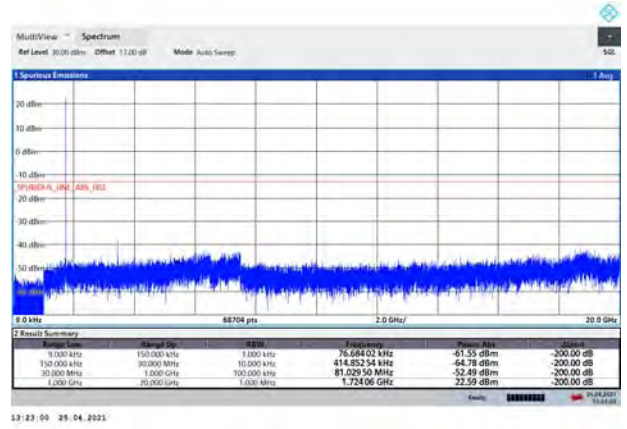

LTE eMTC Band 4 15MHz CH-High 9kHz~20GHz

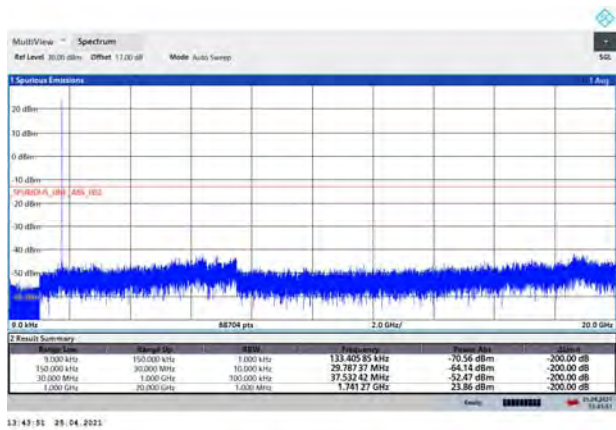

LTE eMTC Band 4 20MHz CH-High 9kHz~20GHz



LTE eMTC Band 12 1.4MHz CH-Low
9kHz~20GHz

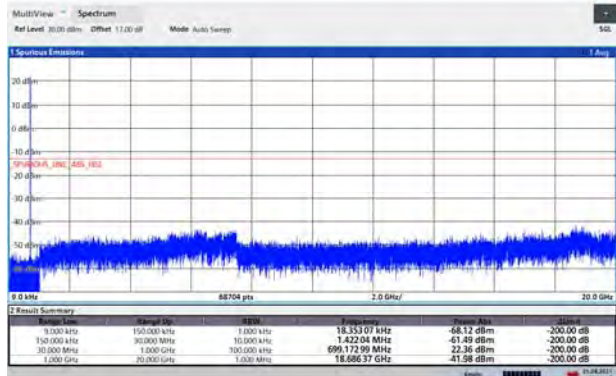

14:05:19 25.04.2021

LTE eMTC Band 12 3MHz CH-Low
9kHz~20GHz

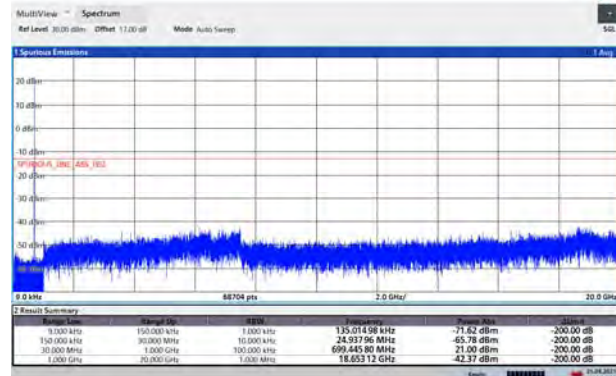

14:10:39 25.04.2021

LTE eMTC Band 12 1.4MHz CH-Middle
9kHz~20GHz

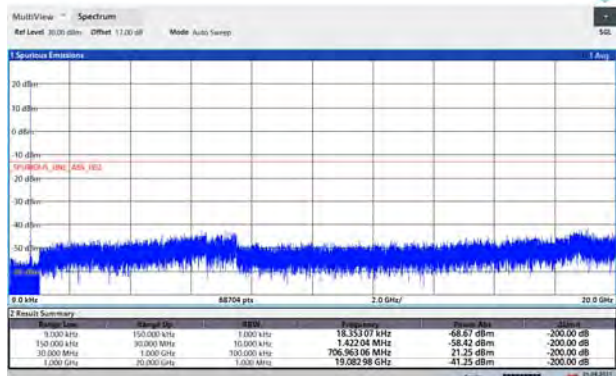

14:04:04 25.04.2021

LTE eMTC Band 12 3MHz CH-Middle
9kHz~20GHz

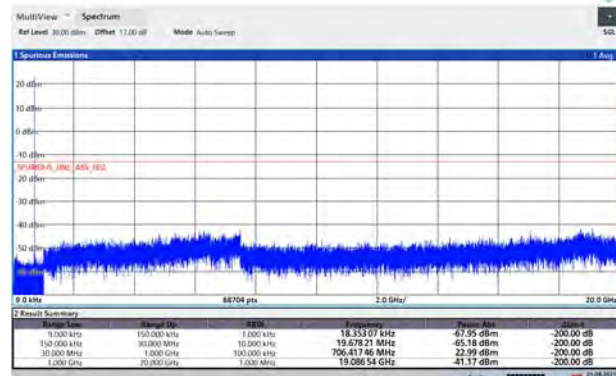

14:07:18 25.04.2021

LTE eMTC Band 12 1.4MHz CH-High
9kHz~20GHz

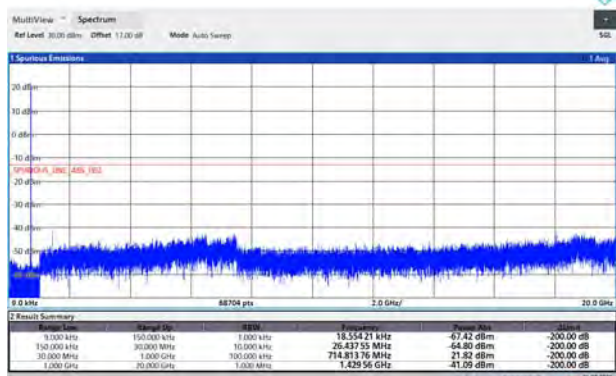

14:09:25 25.04.2021

LTE eMTC Band 12 3MHz CH-High
9kHz~20GHz

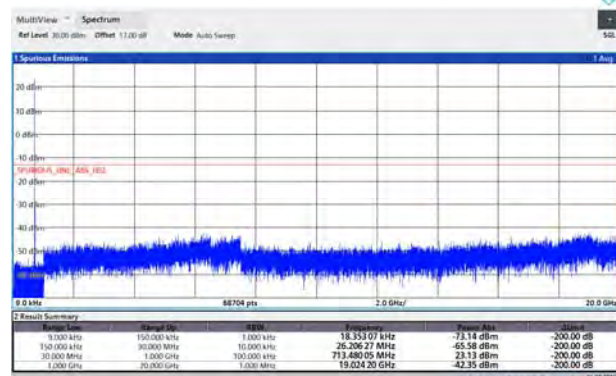

14:11:02 25.04.2021

LTE eMTC Band 12 5MHz CH-Low
9kHz~20GHz

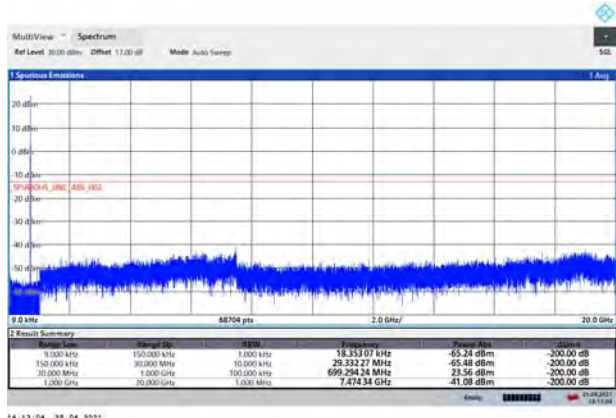

14:13:04 25.04.2021

LTE eMTC Band 12 10MHz CH-Low
9kHz~20GHz

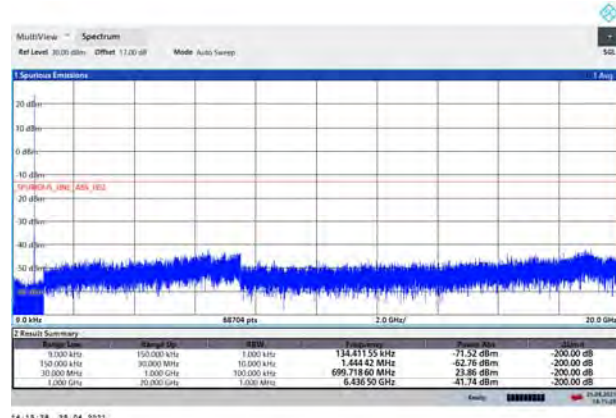

14:18:28 25.04.2021

LTE eMTC Band 12 5MHz CH-Middle
9kHz~20GHz

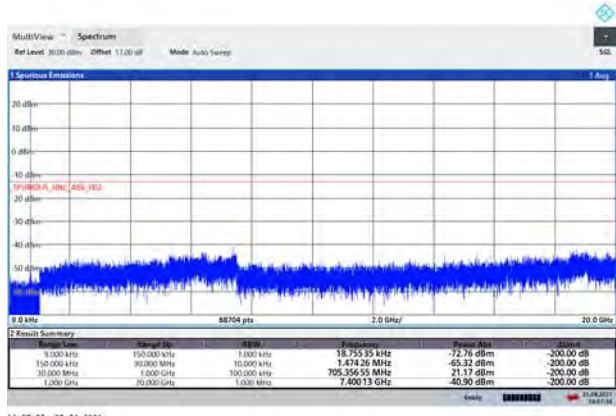

14:17:38 25.04.2021

LTE eMTC Band 12 10MHz CH-Middle
9kHz~20GHz

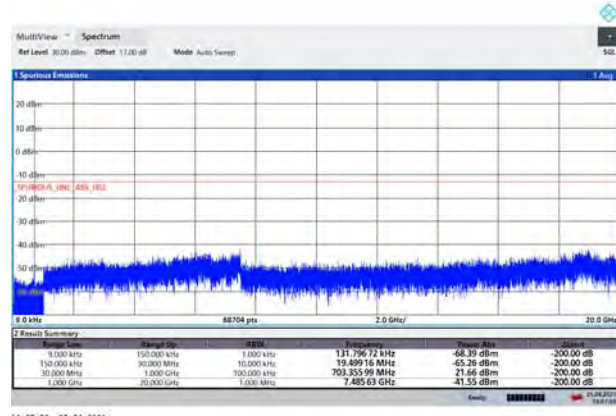

14:17:59 25.04.2021

LTE eMTC Band 12 5MHz CH-High
9kHz~20GHz

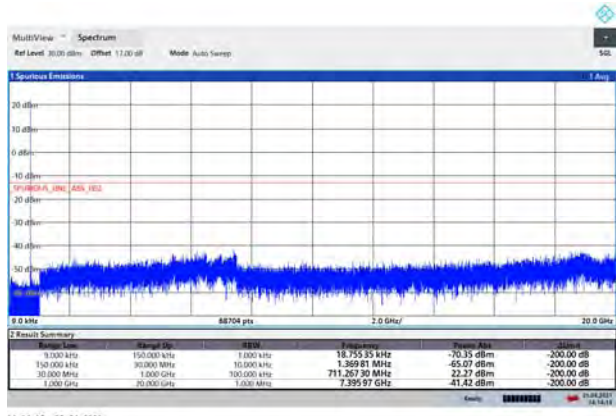

14:14:15 25.04.2021

LTE eMTC Band 12 10MHz CH-High
9kHz~20GHz

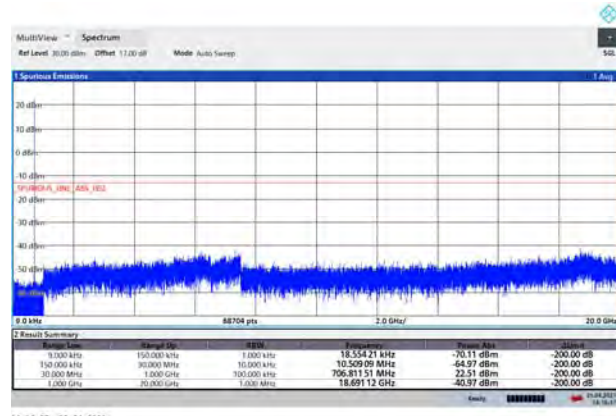

14:14:37 25.04.2021

LTE eMTC Band 13 5MHz CH-Low
9kHz~12.75GHz

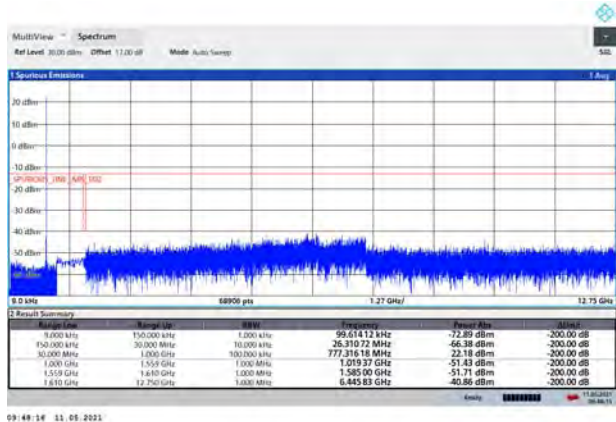

09:49:14 11.05.2021

LTE eMTC Band 13 5MHz CH-Middle
9kHz~12.75GHz

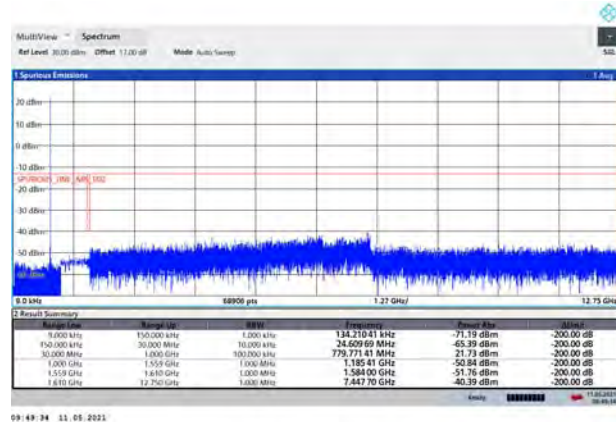

09:49:24 11.05.2021

LTE eMTC Band 13 5MHz CH-High
9kHz~12.75GHz

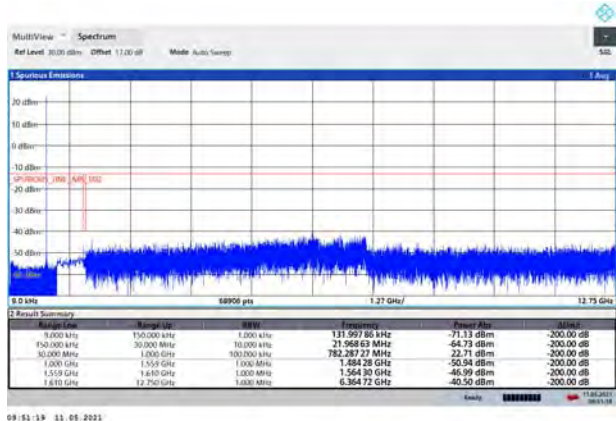

09:51:14 11.05.2021

LTE eMTC Band 13 10MHz CH- Low
9kHz~12.75GHz

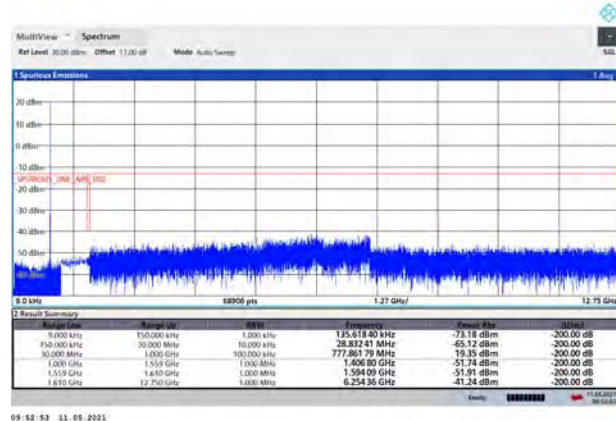

09:52:53 11.05.2021

LTE eMTC Band 13 10MHz CH-Middle
9kHz~12.75GHz

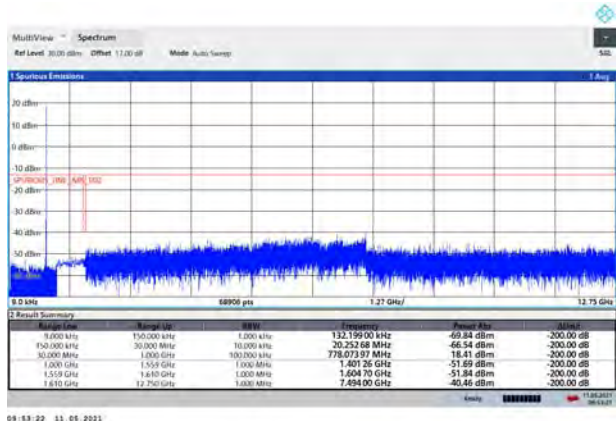

09:53:22 11.05.2021

LTE eMTC Band 13 10MHz CH- High
9kHz~12.75GHz

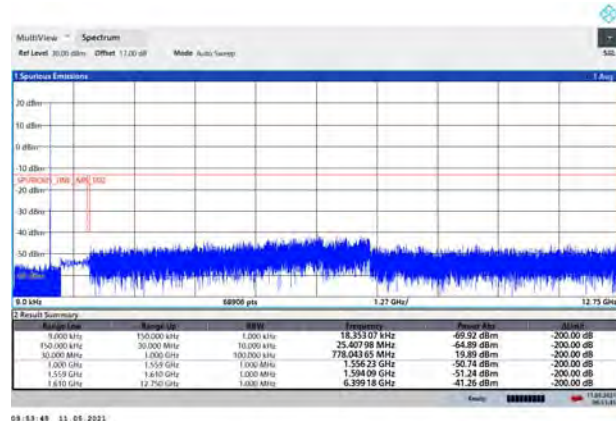

09:53:49 11.05.2021

LTE eMTC Band 66 1.4MHz CH-Low
9kHz~20GHz

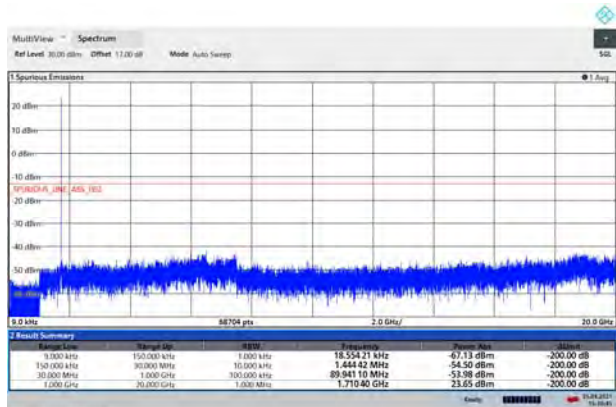

15:30:49 25.04.2021

LTE eMTC Band 66 3MHz CH-Low
9kHz~20GHz

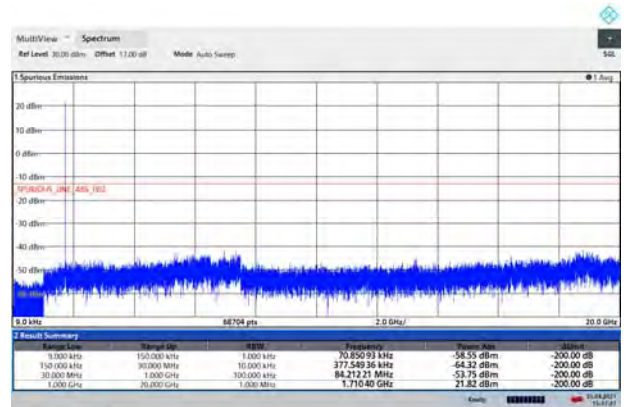

15:37:28 25.04.2021

LTE eMTC Band 66 1.4MHz CH-Middle
9kHz~20GHz

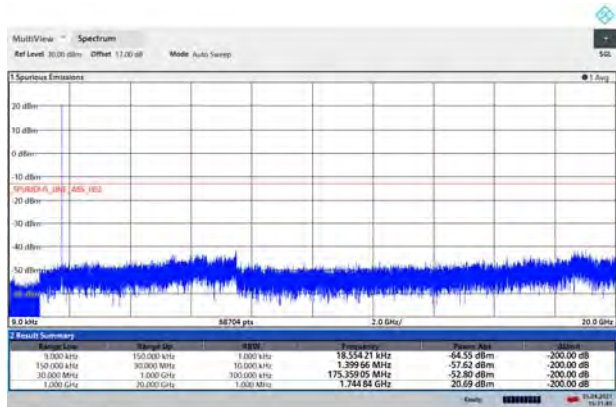

15:31:00 25.04.2021

LTE eMTC Band 66 3MHz CH-Middle
9kHz~20GHz

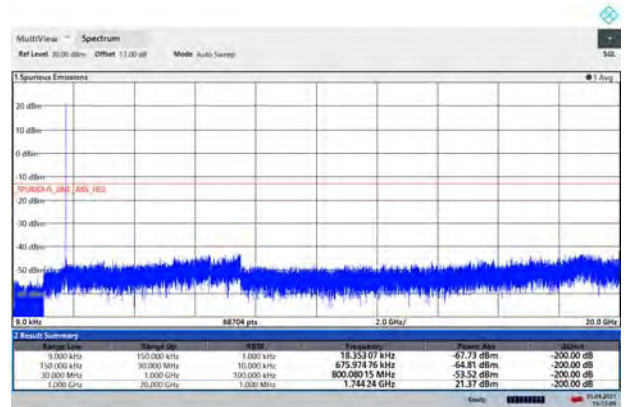

15:32:09 25.04.2021

LTE eMTC Band 66 1.4MHz CH-High
9kHz~20GHz

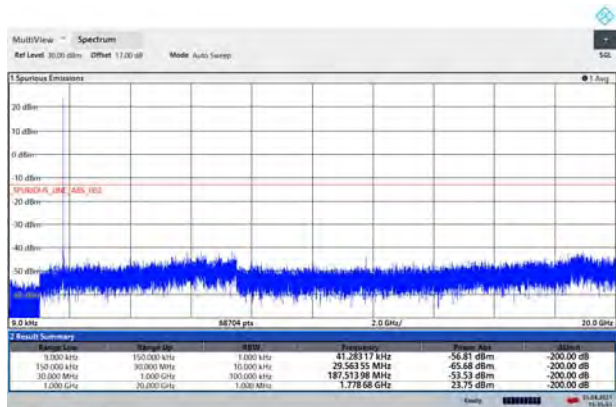

15:35:53 25.04.2021

LTE eMTC Band 66 3MHz CH-High
9kHz~20GHz

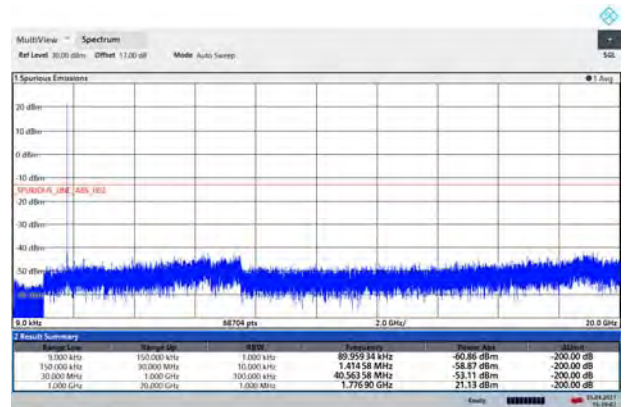

15:39:03 25.04.2021

LTE eMTC Band 66 5MHz CH-Low
9kHz~20GHz

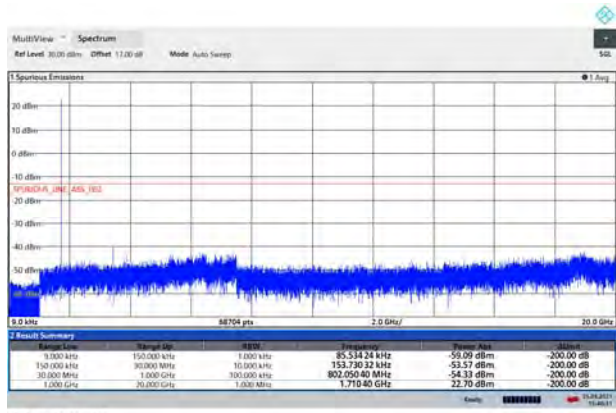

15:40:35 25.04.2021

LTE eMTC Band 66 10MHz CH-Low
9kHz~20GHz

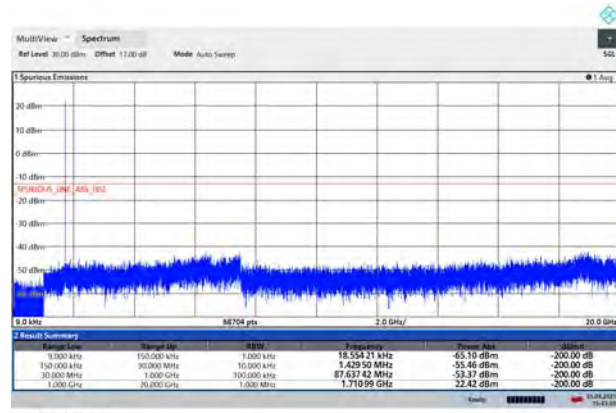

15:43:59 25.04.2021

LTE eMTC Band 66 5MHz CH-Middle
9kHz~20GHz

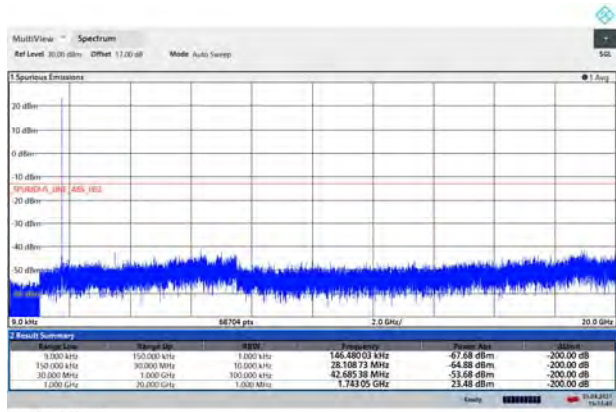

15:32:40 25.04.2021

LTE eMTC Band 66 10MHz CH-Middle
9kHz~20GHz

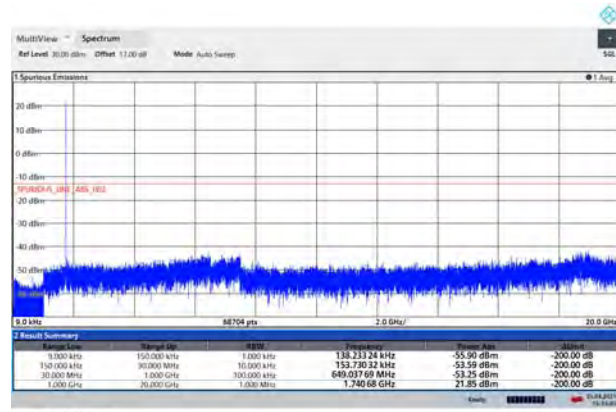

15:33:03 25.04.2021

LTE eMTC Band 66 5MHz CH-High
9kHz~20GHz

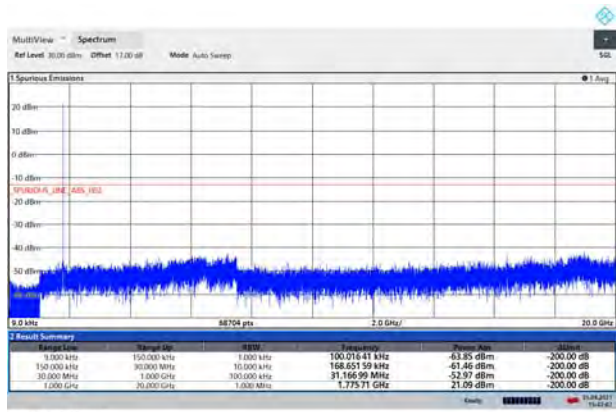

15:42:00 25.04.2021

LTE eMTC Band 66 10MHz CH-High
9kHz~20GHz

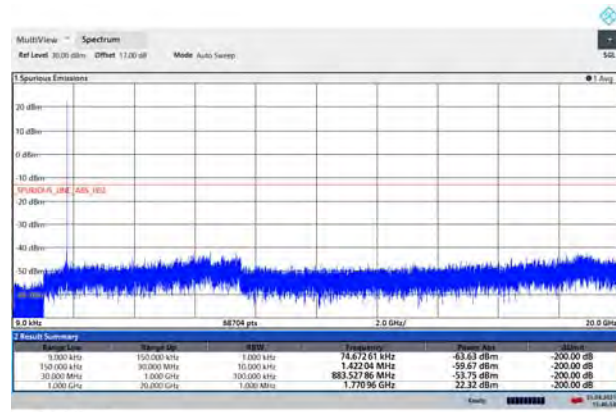

15:44:53 25.04.2021

LTE eMTC Band 66 15MHz CH-Low
9kHz~20GHz

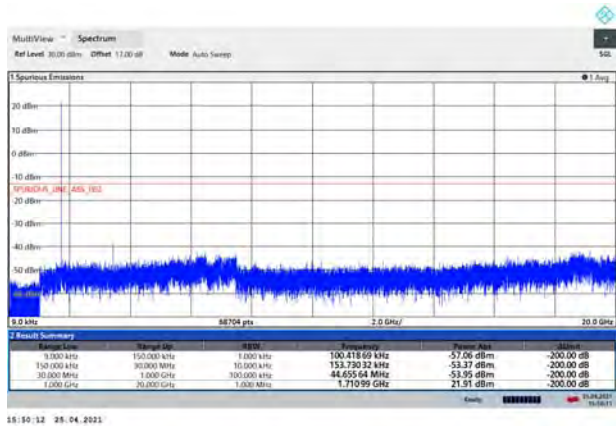

15:50:12 25.04.2021

LTE eMTC Band 66 20MHz CH-Low
9kHz~20GHz

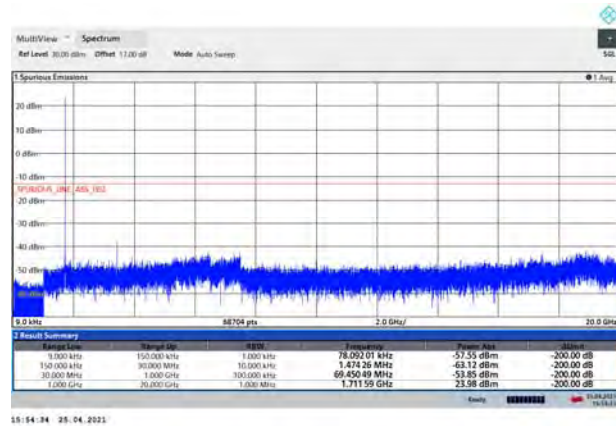

15:54:34 25.04.2021

LTE eMTC Band 66 15MHz CH-Middle
9kHz~20GHz

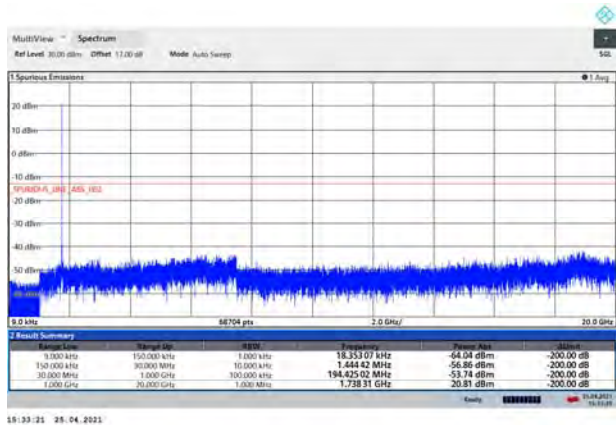

15:55:25 25.04.2021

LTE eMTC Band 66 20MHz CH-Middle
9kHz~20GHz

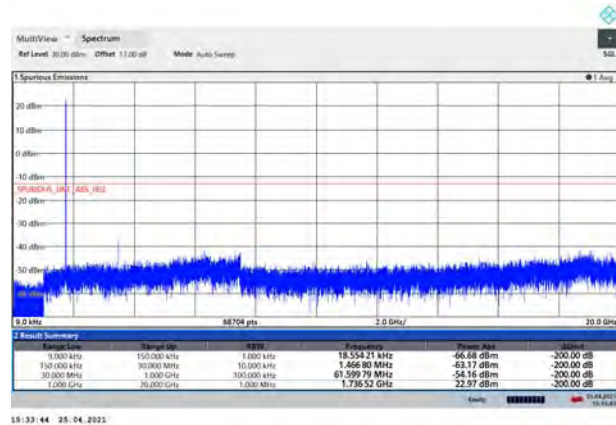

15:53:44 25.04.2021

LTE eMTC Band 66 15MHz CH-High
9kHz~20GHz

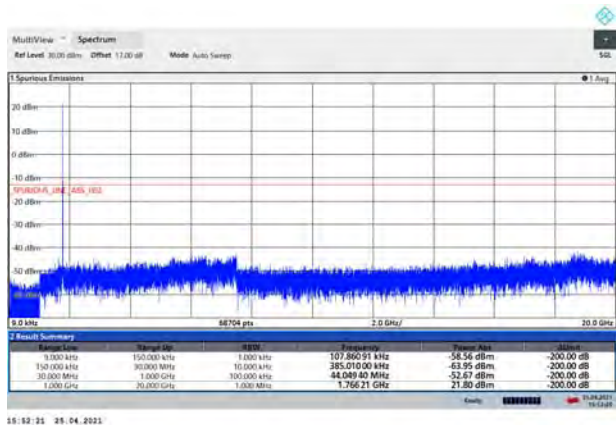

15:52:25 25.04.2021

LTE eMTC Band 66 20MHz CH-High
9kHz~20GHz

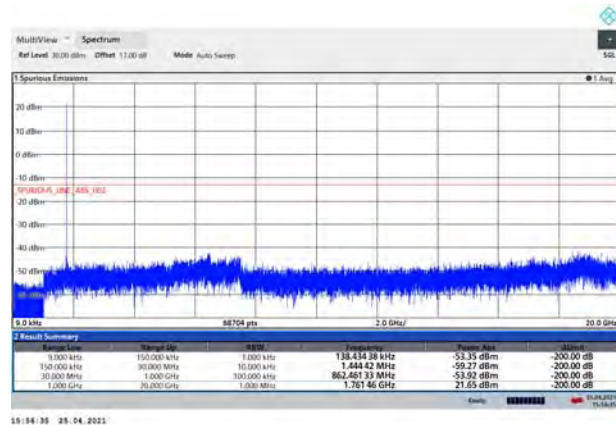

15:54:35 25.04.2021

5.7 Radiates Spurious Emission

Ambient condition

Temperature	Relative humidity
20°C ~ 25°C	45% ~ 50%

Method of Measurement

1. The testing follows FCC KDB 971168 D01 v03r01 Section 5.8 and ANSI C63.26 (2015).
2. Below 1GHz: The EUT is placed on a turntable 0.8 meters above the ground in the chamber, 3 meter away from the antenna. The maximal emission value is acquired by adjusting the antenna height, polarisation and turntable azimuth. Normally, the height range of antenna is 1 m to 4 m, the azimuth range of turntable is 0° to 360°, and the receive antenna has two polarizations Vertical (V) and Horizontal (H). Above 1GHz: (Note: the FCC's permission to use 1.5m as an alternative per TCBC Conf call of Dec. 2, 2014.) The EUT is placed on a turntable 1.5 meters above the ground in the chamber, 3 meter away from the antenna. The maximal emission value is acquired by adjusting the antenna height, polarisation and turntable azimuth. Normally, the height range of antenna is 1 m to 4 m, the azimuth range of turntable is 0° to 360°, and the receive antenna has two polarizations Vertical (V) and Horizontal (H).
3. A loop antenna, A log-periodic antenna or horn antenna shall be substituted in place of the EUT. The log-periodic antenna will be driven by a signal generator and the level will be adjusted till the same power value on the spectrum analyzer or receiver. The level of the spurious emissions can be calculated through the level of the signal generator, cable loss, the gain of the substitution antenna and the reading of the spectrum analyzer or receiver.
4. The EUT is then put into continuously transmitting mode at its maximum power level during the test. Set Test Receiver or Spectrum RBW=100kHz, VBW=300kHz for 30MHz to 1GHz and RBW=1MHz, VBW=3MHz for above 1GHz, and the maximum value of the receiver should be recorded as (Pr).
5. The EUT shall be replaced by a substitution antenna. In the chamber, an substitution antenna for the frequency band of interest is placed at the reference point of the chamber. An RF Signal source for the frequency band of interest is connected to the substitution antenna with a cable that has been constructed to not interfere with the radiation pattern of the antenna. A power (PMea) is applied to the input of the substitution antenna, and adjust the level of the signal generator output until the value of the receiver reach the previously recorded (Pr). The power of signal source (PMea) is recorded. The test should be performed by rotating the test item and adjusting the receiving antenna polarization.
6. A amplifier should be connected to the Signal Source output port. And the cable should be connect between the Amplifier and the Substitution Antenna. The cable loss (Pcl) ,the Substitution Antenna Gain (Ga) and the Amplifier Gain (PAG) should be recorded after test.
7. The measurement results are obtained as described below:

$$\text{Power(EIRP)} = \text{PMea} - \text{PAG} - \text{Pcl} + \text{Ga}$$
 The measurement results are amend as described below:

$$\text{Power(EIRP)} = \text{PMea} - \text{Pcl} + \text{Ga}$$
8. This value is EIRP since the measurement is calibrated using an antenna of known gain (2.15 dBi) and known input power. ERP can be calculated from EIRP by subtracting the gain of the dipole, ERP

= EIRP-2.15dBi.

The modulation mode and RB allocation refer to section 5.1, using the maximum output power configuration.

Test setup

9KHz ~ 30MHz

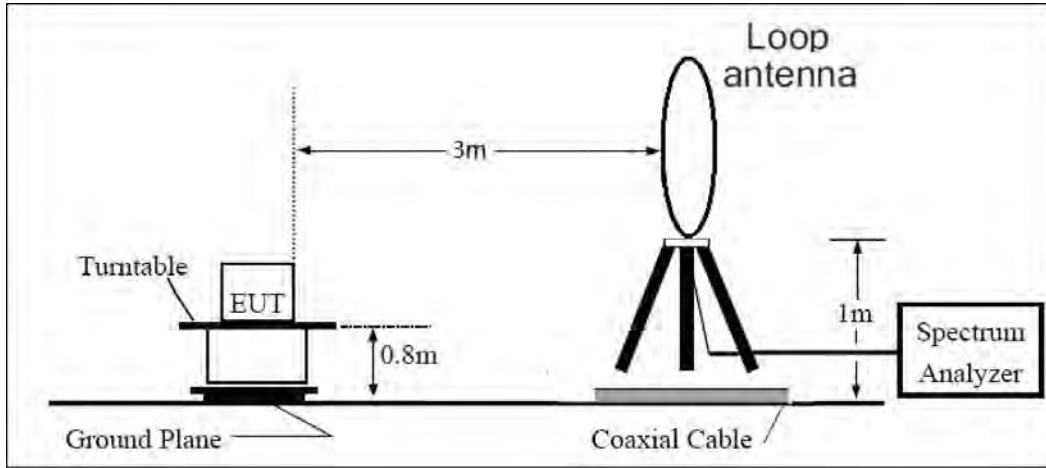

30MHz ~ 1GHz

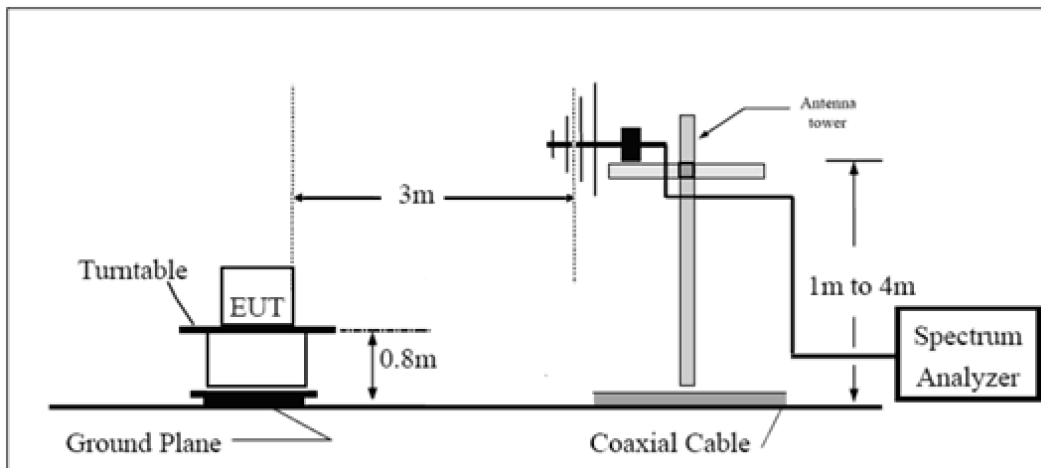

Above 1GHz

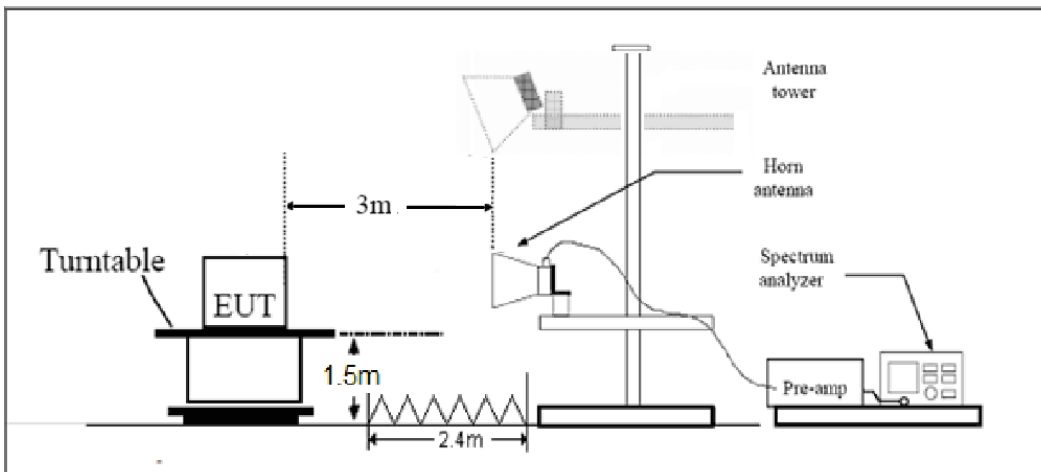

Note: Area side:2.4mX3.6m

Limits

Rule Part 27.53(h) specifies that “for operations in the 1695-1710 MHz, 1710-1755 MHz, 1755-1780 MHz, 1915-1920 MHz, 1995-2000 MHz, 2000-2020 MHz, 2110-2155 MHz, 2155-2180 MHz, and 2180-2200 bands, the power of any emission outside a licensee's frequency block shall be attenuated below the transmitter power (P) in watts by at least $43 + 10 \log_{10}(P)$ dB.”

Rule Part 27.53 (g) For operations in the 600 MHz band and the 698-746 MHz band, the power of any emission outside a licensee's frequency band(s) of operation shall be attenuated below the transmitter power (P) within the licensed band(s) of operation, measured in watts, by at least $43 + 10 \log(P)$ dB. Compliance with this provision is based on the use of measurement instrumentation employing a resolution bandwidth of 100 kilohertz or greater. However, in the 100 kilohertz bands immediately outside and adjacent to a licensee's frequency block, a resolution bandwidth of at least 30 kHz may be employed.

Rule Part 27.53(f) For operations in the 746-758 MHz, 775-788 MHz, and 805-806 MHz bands, emissions in the band 1559-1610 MHz shall be limited to -70 dBW/MHz equivalent isotropically radiated power (EIRP) for wideband signals, and -80 dBW EIRP for discrete emissions of less than 700 Hz bandwidth. For the purpose of equipment authorization, a transmitter shall be tested with an antenna that is representative of the type that will be used with the equipment in normal operation.

Part 27.53 (c) For operations in the 746-758 MHz band and the 776-788 MHz band, the power of any emission outside the licensee's frequency band(s) of operation shall be attenuated below the transmitter power (P) within the licensed band(s) of operation, measured in watts, in accordance with the following:

- (1) On any frequency outside the 746-758 MHz band, the power of any emission shall be attenuated outside the band below the transmitter power (P) by at least $43 + 10 \log(P)$ dB;
- (2) On any frequency outside the 776-788 MHz band, the power of any emission shall be attenuated outside the band below the transmitter power (P) by at least $43 + 10 \log(P)$ dB;
- (3) On all frequencies between 763-775 MHz and 793-805 MHz, by a factor not less than $76 + 10 \log(P)$ dB in a 6.25 kHz band segment, for base and fixed stations;
- (4) On all frequencies between 763-775 MHz and 793-805 MHz, by a factor not less than $65 + 10 \log(P)$ dB in a 6.25 kHz band segment, for mobile and portable stations;
- (5) Compliance with the provisions of paragraphs (c)(1) and (c)(2) of this section is based on the use of measurement instrumentation employing a resolution bandwidth of 100 kHz or greater. However, in the 100 kHz bands immediately outside and adjacent to the frequency block, a resolution bandwidth of at least 30 kHz may be employed;

Part 27.53(a)/(h)/(g) Limit		-13 dBm
Part 27.53(f) Limit	Limit out of the band 1559-1610 MHz	-13 dBm
	Limit in the band 1559-1610 MHz	-40 dBm

Measurement Uncertainty

The assessed measurement uncertainty to ensure 95% confidence level for the normal distribution is with the coverage factor $k = \pm 1.96$, $U = \pm 3.55$ dB.

Test Result

Sweep the whole frequency band through the range from 9kHz to the 10th harmonic of the carrier, the emissions below the noise floor will not be recorded in the report.

LTE eMTC Band 4 QPSK 1.4MHz CH-Middle, RB 1

Harmonic	Frequency (MHz)	SG (dBm)	Cable Loss (dB)	Gain (dBi)	Antenna Polarization	EIRP Level (dBm)	Limit (dBm)	Margin (dB)	Azimuth (deg)
2	3464.25	-45.29	2.70	12.70	Horizontal	-35.29	-13.00	22.29	270
3	5197.50	-49.63	3.20	12.50	Horizontal	-40.33	-13.00	27.33	45
4	6930.00	-61.74	4.20	11.80	Horizontal	-54.14	-13.00	41.14	90
5	8662.50	-57.76	4.40	12.50	Horizontal	-49.66	-13.00	36.66	180
6	10395.00	-53.79	4.70	11.30	Horizontal	-47.19	-13.00	34.19	45
7	12127.50	-55.19	5.20	13.80	Horizontal	-46.59	-13.00	33.59	315
8	13860.00	-50.60	5.70	11.30	Horizontal	-45.00	-13.00	32.00	90
9	15592.50	-59.20	6.10	16.80	Horizontal	-48.50	-13.00	35.50	45
10	17325.00	-54.15	6.10	14.20	Horizontal	-46.05	-13.00	33.05	180

Note: 1.The other Spurious RF Radiated emissions level is no more than noise floor.
2. The worst emission was found in the antenna is Horizontal position.

LTE eMTC Band 4 QPSK 5MHz CH-Middle, RB 1

Harmonic	Frequency (MHz)	SG (dBm)	Cable Loss (dB)	Gain (dBi)	Antenna Polarization	EIRP Level (dBm)	Limit (dBm)	Margin (dB)	Azimuth (deg)
2	3460.50	-44.69	2.70	12.70	Horizontal	-34.69	-13.00	21.69	45
3	5191.50	-48.57	3.20	12.50	Horizontal	-39.27	-13.00	26.27	180
4	6930.00	-59.25	4.20	11.80	Horizontal	-51.65	-13.00	38.65	90
5	8662.50	-59.77	4.40	12.50	Horizontal	-51.67	-13.00	38.67	225
6	10395.00	-54.79	4.70	11.30	Horizontal	-48.19	-13.00	35.19	315
7	12127.50	-54.83	5.20	13.80	Horizontal	-46.23	-13.00	33.23	270
8	13860.00	-50.81	5.70	11.30	Horizontal	-45.21	-13.00	32.21	135
9	15592.50	-60.48	6.10	16.80	Horizontal	-49.78	-13.00	36.78	90
10	17325.00	-53.32	6.10	14.20	Horizontal	-45.22	-13.00	32.22	135

Note: 1.The other Spurious RF Radiated emissions level is no more than noise floor.
2. The worst emission was found in the antenna is Horizontal position.

LTE eMTC Band 4 QPSK 20MHz CH-Middle, RB 1

Harmonic	Frequency (MHz)	SG (dBm)	Cable Loss (dB)	Gain (dBi)	Antenna Polarization	EIRP Level (dBm)	Limit (dBm)	Margin (dB)	Azimuth (deg)
2	3447.00	-44.82	2.70	12.70	Horizontal	-34.82	-13.00	21.82	180
3	5170.88	-45.62	3.20	12.50	Horizontal	-36.32	-13.00	23.32	45
4	6930.00	-58.97	4.20	11.80	Horizontal	-51.37	-13.00	38.37	315
5	8662.50	-55.98	4.40	12.50	Horizontal	-47.88	-13.00	34.88	90
6	10395.00	-54.14	4.70	11.30	Horizontal	-47.54	-13.00	34.54	45
7	12127.50	-54.91	5.20	13.80	Horizontal	-46.31	-13.00	33.31	180
8	13860.00	-49.94	5.70	11.30	Horizontal	-44.34	-13.00	31.34	315
9	15592.50	-59.40	6.10	16.80	Horizontal	-48.70	-13.00	35.70	45
10	17325.00	-55.32	6.10	14.20	Horizontal	-47.22	-13.00	34.22	90

Note: 1.The other Spurious RF Radiated emissions level is no more than noise floor.
2. The worst emission was found in the antenna is Horizontal position.

LTE eMTC Band 12 QPSK 1.4MHz CH-Middle, RB 1

Harmonic	Frequency (MHz)	SG (dBm)	Cable Loss (dB)	Gain (dBi)	Antenna Polarization	ERP Level (dBm)	Limit (dBm)	Margin (dB)	Azimuth (deg)
2	1415.00	-51.27	1.70	8.70	Horizontal	-46.42	-13.00	33.42	45
3	2122.50	-48.91	2.10	11.10	Horizontal	-42.06	-13.00	29.06	135
4	2830.00	-65.50	2.30	13.10	Horizontal	-56.85	-13.00	43.85	315
5	3537.50	-61.10	2.60	12.70	Horizontal	-53.15	-13.00	40.15	90
6	4245.00	-57.99	3.30	12.50	Horizontal	-50.94	-13.00	37.94	45
7	4952.50	-64.26	3.40	12.50	Horizontal	-57.31	-13.00	44.31	270
8	5660.00	-63.06	3.30	12.50	Horizontal	-56.01	-13.00	43.01	0
9	6367.50	-59.31	3.80	11.50	Horizontal	-53.76	-13.00	40.76	45
10	7075.00	-55.68	4.20	11.80	Horizontal	-50.23	-13.00	37.23	90

Note: 1.The other Spurious RF Radiated emissions level is no more than noise floor.
2. The worst emission was found in the antenna is Horizontal position.

LTE eMTC Band 12 QPSK 5MHz CH-Middle, RB 1

Harmonic	Frequency (MHz)	SG (dBm)	Cable Loss (dB)	Gain (dBi)	Antenna Polarization	ERP Level (dBm)	Limit (dBm)	Margin (dB)	Azimuth (deg)
2	1410.60	-48.90	1.70	8.70	Horizontal	-44.05	-13.00	31.05	45
3	2115.90	-47.62	2.10	11.10	Horizontal	-40.77	-13.00	27.77	180
4	2821.20	-62.82	2.30	13.10	Horizontal	-54.17	-13.00	41.17	0
5	3537.50	-59.71	2.60	12.70	Horizontal	-51.76	-13.00	38.76	225
6	4245.00	-61.06	3.30	12.50	Horizontal	-54.01	-13.00	41.01	90
7	4952.50	-64.14	3.40	12.50	Horizontal	-57.19	-13.00	44.19	45
8	5660.00	-63.22	3.30	12.50	Horizontal	-56.17	-13.00	43.17	135
9	6367.50	-58.24	3.80	11.50	Horizontal	-52.69	-13.00	39.69	45
10	7075.00	-55.89	4.20	11.80	Horizontal	-50.44	-13.00	37.44	315

Note: 1. The other Spurious RF Radiated emissions level is no more than noise floor.
 2. The worst emission was found in the antenna is Horizontal position.

LTE eMTC Band 12 QPSK 10MHz CH-Middle, RB 1

Harmonic	Frequency (MHz)	SG (dBm)	Cable Loss (dB)	Gain (dBi)	Antenna Polarization	ERP Level (dBm)	Limit (dBm)	Margin (dB)	Azimuth (deg)
2	1406.40	-46.59	1.70	8.70	Horizontal	-41.74	-13.00	28.74	315
3	2109.60	-46.19	2.10	11.10	Horizontal	-39.34	-13.00	26.34	45
4	2812.80	-65.62	2.30	13.10	Horizontal	-56.97	-13.00	43.97	0
5	3537.50	-58.57	2.60	12.70	Horizontal	-50.62	-13.00	37.62	180
6	4245.00	-58.52	3.30	12.50	Horizontal	-51.47	-13.00	38.47	225
7	4952.50	-60.93	3.40	12.50	Horizontal	-53.98	-13.00	40.98	90
8	5660.00	-60.37	3.30	12.50	Horizontal	-53.32	-13.00	40.32	270
9	6367.50	-59.61	3.80	11.50	Horizontal	-54.06	-13.00	41.06	45
10	7075.00	-58.47	4.20	11.80	Horizontal	-53.02	-13.00	40.02	180

Note: 1. The other Spurious RF Radiated emissions level is no more than noise floor.
 2. The worst emission was found in the antenna is Horizontal position.

LTE eMTC Band 13 QPSK 5MHz CH-Middle, RB 1

Harmonic	Frequency (MHz)	SG (dBm)	Cable Loss (dB)	Gain (dBi)	Antenna Polarization	EIRP Level (dBm)	Limit (dBm)	Margin (dB)	Azimuth (deg)
2	1559.73	-57.12	1.70	8.70	Horizontal	-52.27	-40.00	12.27	45
3	2346.00	-54.68	2.10	12.00	Horizontal	-46.93	-13.00	33.93	90
4	3128.00	-65.34	2.30	13.10	Horizontal	-56.69	-13.00	43.69	180
5	3910.00	-58.76	2.90	12.50	Horizontal	-51.31	-13.00	38.31	45
6	4692.00	-59.32	3.10	12.50	Horizontal	-52.07	-13.00	39.07	0
7	5474.00	-64.00	3.30	12.50	Horizontal	-56.95	-13.00	43.95	90
8	6256.00	-57.87	3.50	12.80	Horizontal	-50.72	-13.00	37.72	135
9	7038.00	-58.11	4.20	11.80	Horizontal	-52.66	-13.00	39.66	45
10	7820.00	-56.87	4.40	12.30	Horizontal	-51.12	-13.00	38.12	315

Note: 1.The other Spurious RF Radiated emissions level is no more than noise floor.
2. The worst emission was found in the antenna is Horizontal position.

LTE eMTC Band 13 QPSK 10MHz CH-Middle, RB 1

Harmonic	Frequency (MHz)	SG (dBm)	Cable Loss (dB)	Gain (dBi)	Antenna Polarization	ERP Level (dBm)	Limit (dBm)	Margin (dB)	Azimuth (deg)
2	1555.25	-59.39	1.70	8.70	Horizontal	-54.54	-13.00	41.54	45
3	2346.00	-56.87	2.10	12.00	Horizontal	-49.12	-13.00	36.12	90
4	3128.00	-65.12	2.30	13.10	Horizontal	-56.47	-13.00	43.47	315
5	3910.00	-60.18	2.90	12.50	Horizontal	-52.73	-13.00	39.73	0
6	4692.00	-66.07	3.10	12.50	Horizontal	-58.82	-13.00	45.82	315
7	5474.00	-62.88	3.30	12.50	Horizontal	-55.83	-13.00	42.83	315
8	6256.00	-61.39	3.50	12.80	Horizontal	-54.24	-13.00	41.24	180
9	7038.00	-55.82	4.20	11.80	Horizontal	-50.37	-13.00	37.37	0
10	7820.00	-57.62	4.40	12.30	Horizontal	-51.87	-13.00	38.87	90

Note: 1.The other Spurious RF Radiated emissions level is no more than noise floor.
2. The worst emission was found in the antenna is Horizontal position.

LTE eMTC Band 66 QPSK 1.4MHz CH-Middle, RB 1

Harmonic	Frequency (MHz)	SG (dBm)	Cable Loss (dB)	Gain (dBi)	Antenna Polarization	EIRP Level (dBm)	Limit (dBm)	Margin (dB)	Azimuth (deg)
2	3509.0	-49.35	2.70	12.70	Horizontal	-39.35	-13.00	26.35	315
3	5263.5	-51.57	3.20	12.50	Horizontal	-42.27	-13.00	29.27	45
4	7018.0	-59.11	4.20	11.80	Horizontal	-51.51	-13.00	38.51	0
5	8772.5	-55.49	4.40	12.50	Horizontal	-47.39	-13.00	34.39	0
6	10527.0	-53.47	4.70	11.80	Horizontal	-46.37	-13.00	33.37	90
7	12281.5	-53.40	5.20	13.80	Horizontal	-44.80	-13.00	31.80	225
8	14036.0	-52.44	5.70	13.20	Horizontal	-44.94	-13.00	31.94	315
9	15790.5	-54.65	6.10	16.80	Horizontal	-43.95	-13.00	30.95	90
10	17545.0	-50.08	6.10	14.20	Horizontal	-41.98	-13.00	28.98	0

Note: 1.The other Spurious RF Radiated emissions level is no more than noise floor.
2. The worst emission was found in the antenna is Horizontal position.

LTE eMTC Band 66 QPSK 5MHz CH-Middle, RB 1

Harmonic	Frequency (MHz)	SG (dBm)	Cable Loss (dB)	Gain (dBi)	Antenna Polarization	EIRP Level (dBm)	Limit (dBm)	Margin (dB)	Azimuth (deg)
2	3505.6	-48.89	2.70	12.70	Horizontal	-38.89	-13.00	25.89	315
3	5258.4	-52.92	3.20	12.50	Horizontal	-43.62	-13.00	30.62	45
4	7011.2	-59.33	4.20	11.80	Horizontal	-51.73	-13.00	38.73	270
5	8764.0	-55.26	4.40	12.50	Horizontal	-47.16	-13.00	34.16	180
6	10516.8	-51.72	4.70	11.80	Horizontal	-44.62	-13.00	31.62	0
7	12269.6	-51.26	5.20	13.80	Horizontal	-42.66	-13.00	29.66	90
8	14022.4	-50.46	5.70	13.20	Horizontal	-42.96	-13.00	29.96	225
9	15775.2	-54.83	6.10	16.80	Horizontal	-44.13	-13.00	31.13	315
10	17528.0	-52.17	6.10	14.20	Horizontal	-44.07	-13.00	31.07	45

Note: 1.The other Spurious RF Radiated emissions level is no more than noise floor.
2. The worst emission was found in the antenna is Horizontal position.

LTE eMTC Band 66 QPSK 20MHz CH-Middle, RB 1

Harmonic	Frequency (MHz)	SG (dBm)	Cable Loss (dB)	Gain (dBi)	Antenna Polarization	EIRP Level (dBm)	Limit (dBm)	Margin (dB)	Azimuth (deg)
2	3472.2	-50.47	2.70	12.70	Horizontal	-40.47	-13.00	27.47	315
3	5209.5	-51.36	3.20	12.50	Horizontal	-42.06	-13.00	29.06	225
4	6984.4	-61.71	4.20	11.80	Horizontal	-54.11	-13.00	41.11	315
5	8730.5	-52.45	4.40	12.50	Horizontal	-44.35	-13.00	31.35	45
6	10476.6	-51.54	4.70	11.80	Horizontal	-44.44	-13.00	31.44	270
7	12222.7	-52.75	5.20	13.80	Horizontal	-44.15	-13.00	31.15	0
8	13968.8	-51.71	5.70	13.20	Horizontal	-44.21	-13.00	31.21	315
9	15714.9	-53.86	6.10	16.80	Horizontal	-43.16	-13.00	30.16	90
10	17461.0	-50.50	6.10	14.20	Horizontal	-42.40	-13.00	29.40	225

Note: 1. The other Spurious RF Radiated emissions level is no more than noise floor.
 2. The worst emission was found in the antenna is Horizontal position.

6 Main Test Instruments

Name	Manufacturer	Type	Serial Number	Calibration Date	Expiration Date
Base Station Simulator	R&S	CMW500	113824	2020-05-18	2021-05-17
Power Splitter	Hua Xiang	SHX-GF2-2-13	10120101	/	/
Spectrum Analyzer	Key sight	N9010A	MY50210259	2020-05-18	2021-05-17
Signal Analyzer	R&S	FSV30	100815	2020-12-13	2021-12-12
Loop Antenna	SCHWARZBECK	FMZB1519	1519-047	2020-04-02	2023-04-01
TRILOG Broadband Antenna	SCHWARZBECK	VULB 9163	391	2019-12-16	2021-12-15
Horn Antenna	R&S	HF907	102723	2018-08-11	2021-08-10
Horn Antenna	ETS-Lindgren	3160-09	00102643	2018-06-20	2021-06-19
Signal generator	R&S	SMB 100A	102594	2020-05-18	2021-05-17
Climatic Chamber	ESPEC	SU-242	93000506	2020-12-13	2021-12-12
Preamplifier	R&S	SCU18	102327	2020-05-18	2021-05-17
MOB COMMS DC SUPPLY	Keysight	66319D	MY43004105	2020-05-18	2021-05-17
RF Cable	Agilent	SMA 15cm	0001	2021-5-15	2022-5-14
Software	R&S	EMC32	9.26.0	/	/

*****END OF REPORT *****

ANNEX A: The EUT Appearance

The EUT Appearance are submitted separately.

ANNEX B: Test Setup Photos

The Test Setup Photos are submitted separately.

ANNEX C: Product Change Description (Variant 1)

The Product Change Description are submitted separately.

ANNEX D: Product Change Description (Variant 2)

The Product Change Description are submitted separately.