

RF TEST REPORT

Applicant Quectel Wireless Solutions Co., Ltd.
FCC ID XMR2023AH20C
Product Bluetooth Module
Brand Quectel
Model AH20C
Report No. R2301A0036-R2
Issue Date February 28, 2023

TA Technology (Shanghai) Co., Ltd. tested the above equipment in accordance with the requirements in **FCC CFR47 Part 15C (2022)**. The test results show that the equipment tested is capable of demonstrating compliance with the requirements as documented in this report.

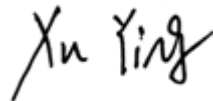

Prepared by: Xu Ying



Approved by: Xu Kai

TA Technology (Shanghai) Co., Ltd.

Building 3, No.145, Jintang Rd, Pudong Shanghai, P.R.China

TEL: +86-021-50791141/2/3

FAX: +86-021-50791141/2/3-8000

TABLE OF CONTENT

1. Test Laboratory	4
1.1. Notes of the Test Report	4
1.2. Test Facility	4
1.3. Testing Location	4
2. General Description of Equipment Under Test	5
2.1. Applicant and Manufacturer Information	5
2.2. General Information	5
3. Applied Standards	6
4. Test Configuration	7
5. Test Case Results	8
5.1. Maximum output power	8
5.2. 99% Bandwidth and 6dB Bandwidth	10
5.3. Band Edge	16
5.4. Power Spectral Density	19
5.5. Spurious RF Conducted Emissions	23
5.6. Unwanted Emission	27
5.7. Conducted Emission	41
6. Main Test Instruments	44
ANNEX A: The EUT Appearance	45
ANNEX B: Test Setup Photos	46

Summary of Measurement Results

Number	Test Case	Clause in FCC rules	Verdict
1	Maximum output power	15.247(b)(3)	PASS
2	99% Bandwidth and 6dB Bandwidth	15.247(a)(2) C63.10 6.7	PASS
3	Power spectral density	15.247(e)	PASS
4	Band Edge	15.247(d)	PASS
5	Spurious RF Conducted Emissions	15.247(d)	PASS
6	Unwanted Emissions	15.247(d),15.205,15.209	PASS
7	Conducted Emissions	15.207	PASS
Date of Testing: January 18, 2023 ~ February 2, 2023			
Date of Sample Received: January 18, 2023			
Note: All indications of Pass/Fail in this report are opinions expressed by TA Technology (Shanghai) Co., Ltd. based on interpretations and/or observations of test results. Measurement Uncertainties were not taken into account and are published for informational purposes only.			

1. Test Laboratory

1.1. Notes of the Test Report

This report shall not be reproduced in full or partial, without the written approval of **TA Technology (Shanghai) Co., Ltd.** The results documented in this report apply only to the tested sample, under the conditions and modes of operation as described herein. Measurement Uncertainties were not taken into account and are published for informational purposes only. This report is written to support regulatory compliance of the applicable standards stated above.

1.2. Test Facility

FCC (Designation number: CN1179, Test Firm Registration Number: 446626)

TA Technology (Shanghai) Co., Ltd. has been listed on the US Federal Communications Commission list of test facilities recognized to perform measurements.

A2LA (Certificate Number: 3857.01)

TA Technology (Shanghai) Co., Ltd. has been listed by American Association for Laboratory Accreditation to perform measurement.

1.3. Testing Location

Company: TA Technology (Shanghai) Co., Ltd.
Address: Building 3, No.145, Jintang Rd, Pudong Shanghai, P.R.China
City: Shanghai
Post code: 201201
Country: P. R. China
Contact: Xu Kai
Telephone: +86-021-50791141/2/3
Fax: +86-021-50791141/2/3-8000
Website: <http://www.ta-shanghai.com>
E-mail: xukai@ta-shanghai.com

2. General Description of Equipment Under Test

2.1. Applicant and Manufacturer Information

Applicant	Quectel Wireless Solutions Co., Ltd.
Applicant address	Building 5, Shanghai Business Park Phase III (Area B), No.1016 Tianlin Road, Minhang District, Shanghai, China, 200233
Manufacturer	Quectel Wireless Solutions Co., Ltd.
Manufacturer address	Building 5, Shanghai Business Park Phase III (Area B), No.1016 Tianlin Road, Minhang District, Shanghai, China, 200233

2.2. General Information

EUT Description	
Model	AH20C
SN	E1C22KM24000019
Hardware Version	R1.0
Software Version	BCM20703A1
Power Supply	External power supply
Antenna Type	External Antenna
Antenna Connector	A permanently attached antenna (meet with the standard FCC Part 15.203 requirement)
Operating Frequency Range(s)	Bluetooth LE V5.2: 2402 ~2480 MHz
Modulation Type	Bluetooth LE: GFSK
Max. Output Power	Bluetooth LE: 7.70 dBm
Auxiliary test equipment	
Antenna	Manufacturer: Quectel Wireless Solutions Co., Ltd. Brand: Quectel Model: YE0038AA Antenna Gain: 0.73 dBi
<p>Note: 1. The EUT is sent from the applicant to TA and the information of the EUT is declared by the applicant.</p> <p>2. 1) The antenna gain is provided by the manufacturer. 2) The antenna is for testing only and will not be sold with the equipment.</p>	

3. Applied Standards

According to the specifications of the manufacturer, it must comply with the requirements of the following standards:

Test standards:

FCC CFR47 Part 15C (2022) Radio Frequency Devices

ANSI C63.10-2013

Reference standard:

KDB 558074 D01 15.247 Meas Guidance v05r02

4. Test Configuration

Test Mode

The EUT has been associated with peripherals and configuration operated in a manner tended to maximize its emission characteristics in a typical application.

The radiated emission was measured in the following position: EUT stand-up position (Z axis), lie-down position (X, Y axis). The worst emission was found in lie-down position (X axis) and the loop antenna is vertical, the others are vertical and horizontal. and the worst case was recorded.

In order to find the worst case condition, Pre-tests are needed at the presence of different data rate. Preliminary tests have been done on all the configuration for confirming worst case. Data rate below means worst-case rate of each test item.

Worst-case data rates are shown as following table.

Test Mode	Data Rate
Bluetooth(Low Energy)	1Mbps

5. Test Case Results

5.1. Maximum output power

Ambient Condition

Temperature	Relative humidity
20°C ~25°C	45%~50%

Methods of Measurement

During the process of the testing, The EUT was connected to Power meter with a known loss. The EUT is max power transmission with proper modulation.

Test Setup

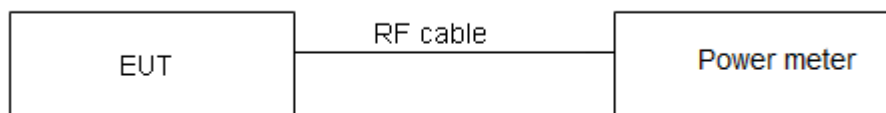

Limits

Rule Part 15.247 (b) (3) specifies that " For systems using digital modulation in the 902–928 MHz, 2400–2483.5 MHz: 1 Watt."

Average Output Power	$\leq 1W$ (30dBm)
----------------------	-------------------

Measurement Uncertainty

The assessed measurement uncertainty to ensure 95% confidence level for the normal distribution is with the coverage factor $k = 2$, $U = 0.44$ dB.

Test Results

Power setting: default

Test Mode	Duty cycle	Duty cycle correction Factor(dB)
Bluetooth LE	0.854	0.685
Note: when Duty cycle ≥ 0.98 , Duty cycle correction Factor not required.		

Test Mode	Carrier frequency (MHz) / Channel	Average Power Measured (dBm)	Average Power with duty factor (dBm)	Limit (dBm)	Conclusion
Bluetooth (Low Energy)	2402/CH0	6.98	7.67	30	PASS
	2440/CH19	6.71	7.40	30	PASS
	2480/CH39	7.01	7.70	30	PASS
Note: Average Power with duty factor = Average Power Measured +Duty cycle correction factor					

5.2. 99% Bandwidth and 6dB Bandwidth

Ambient Condition

Temperature	Relative humidity
20°C ~25°C	45%~50%

Method of Measurement

The EUT was connected to the spectrum analyzer through an external attenuator (20dB) and a known loss cable. RBW is set to 100 kHz; VBW is set to 300 kHz on spectrum analyzer.

Dector=Peak, Trace mode=max hold.

The EUT was connected to the spectrum analyzer through a known loss cable. The resolution bandwidth (RBW) shall be in the range of 1% to 5% of the actual occupied / x dB bandwidth and the video bandwidth (VBW) shall not be smaller than three times the RBW value.

Test Setup

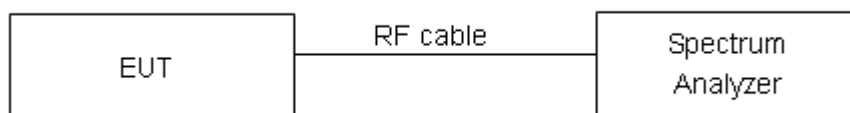

Limits

Rule Part 15.247 (a) (2) specifies that “Systems using digital modulation techniques may operate in the 902–928 MHz, 2400–2483.5 MHz bands. The minimum 6 dB bandwidth shall be at least 500 kHz.”

minimum 6 dB bandwidth	≥ 500 kHz
------------------------	-----------

Measurement Uncertainty

The assessed measurement uncertainty to ensure 95% confidence level for the normal distribution is with the coverage factor $k = 2$, $U = 936$ Hz.

Test Results:

Test Mode	Carrier frequency (MHz)	99% bandwidth (MHz)	Minimum 6 dB bandwidth (MHz)	Limit (kHz)	Conclusion
Bluetooth (Low Energy)	2402	1.069	0.681	500	PASS
	2440	1.066	0.693	500	PASS
	2480	1.067	0.704	500	PASS

99%bandwidth

OBW BLE 2402MHz

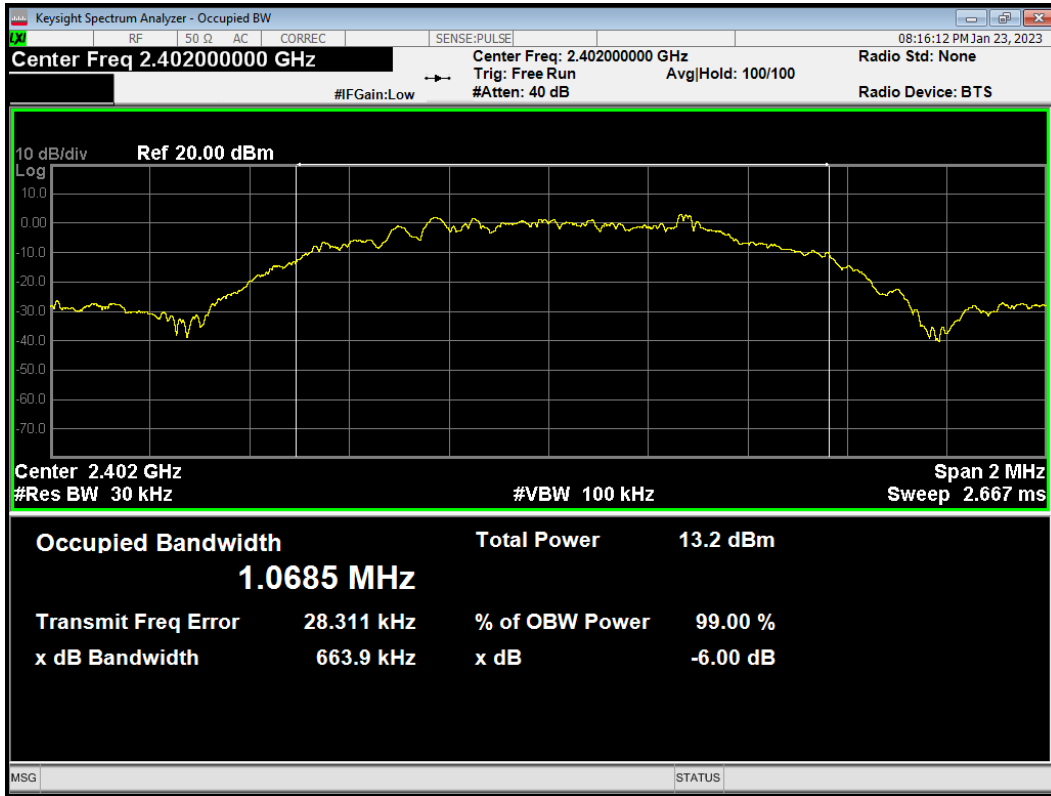

OBW BLE 2440MHz

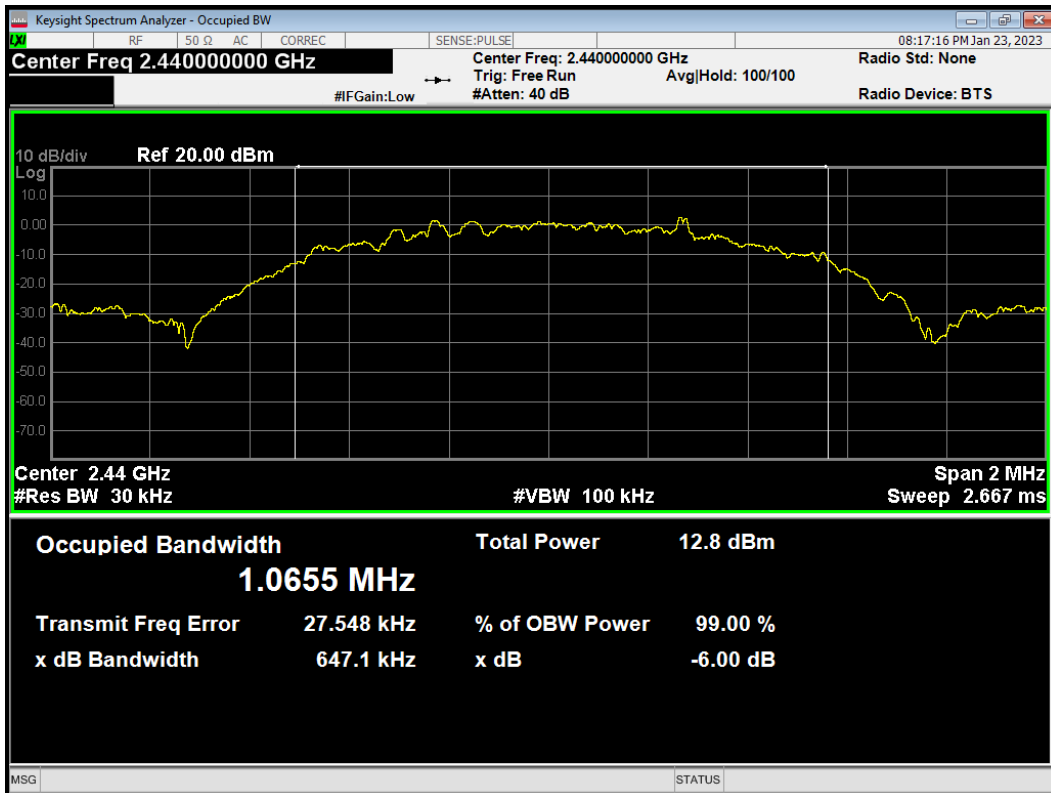

OBW BLE 2480MHz

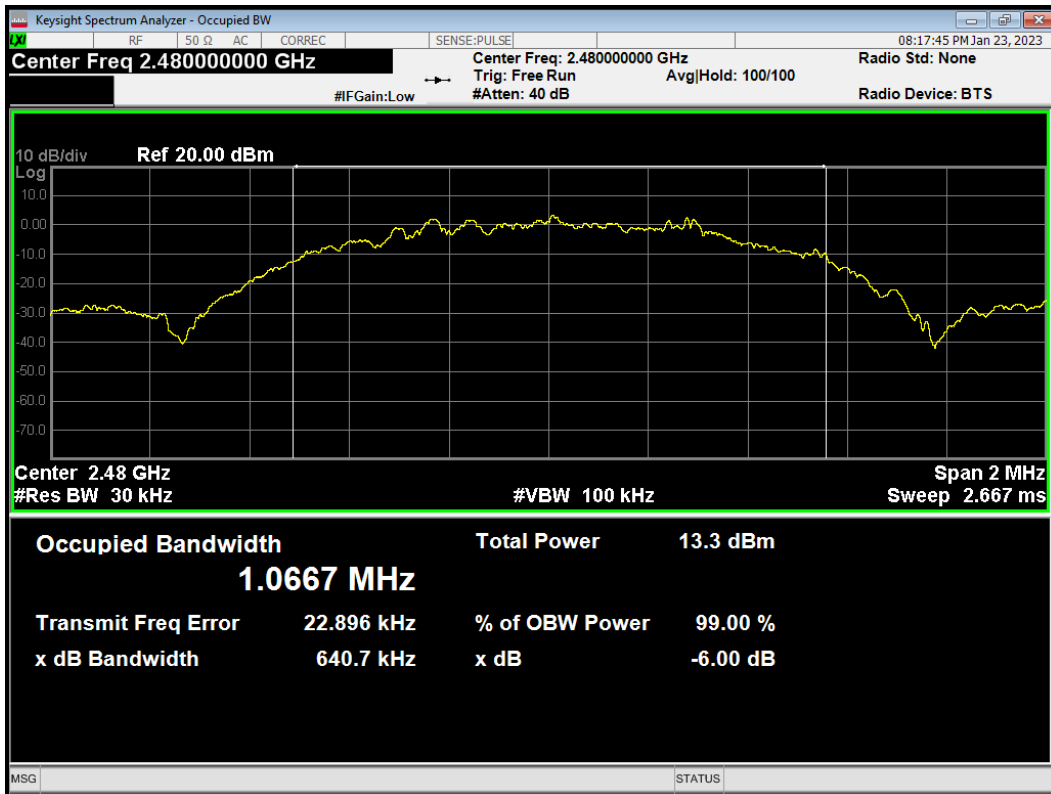

6 dB bandwidth

-6dB Bandwidth BLE 2402MHz

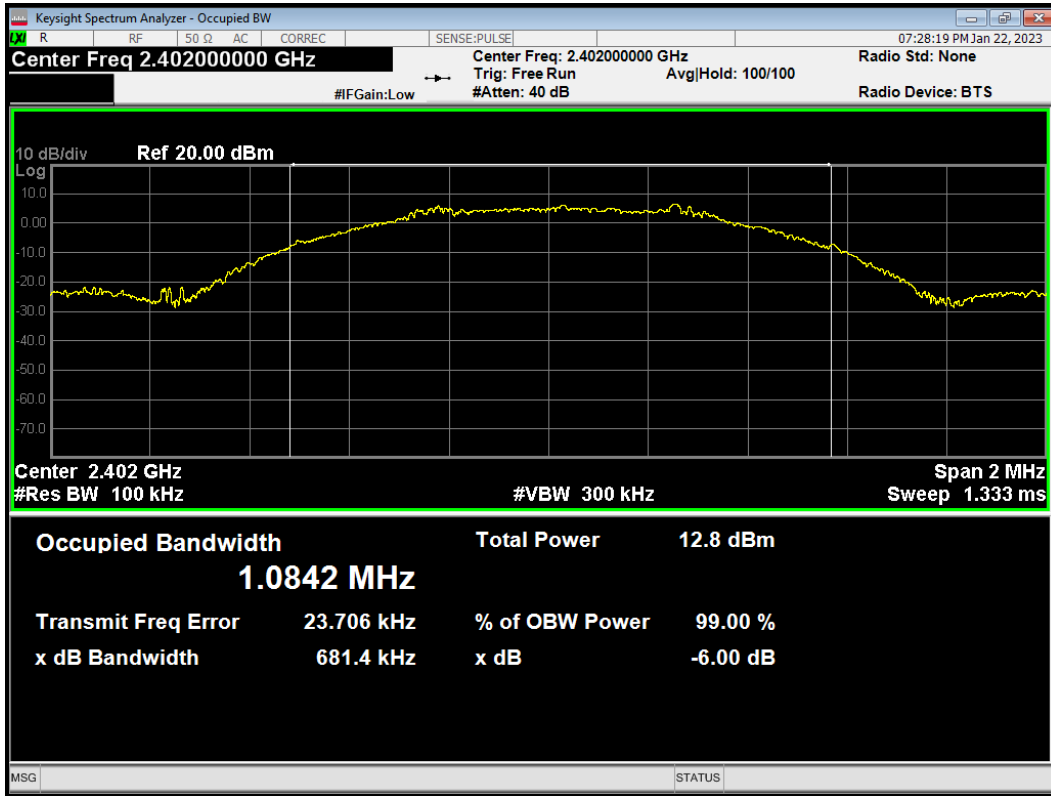

-6dB Bandwidth BLE 2440MHz

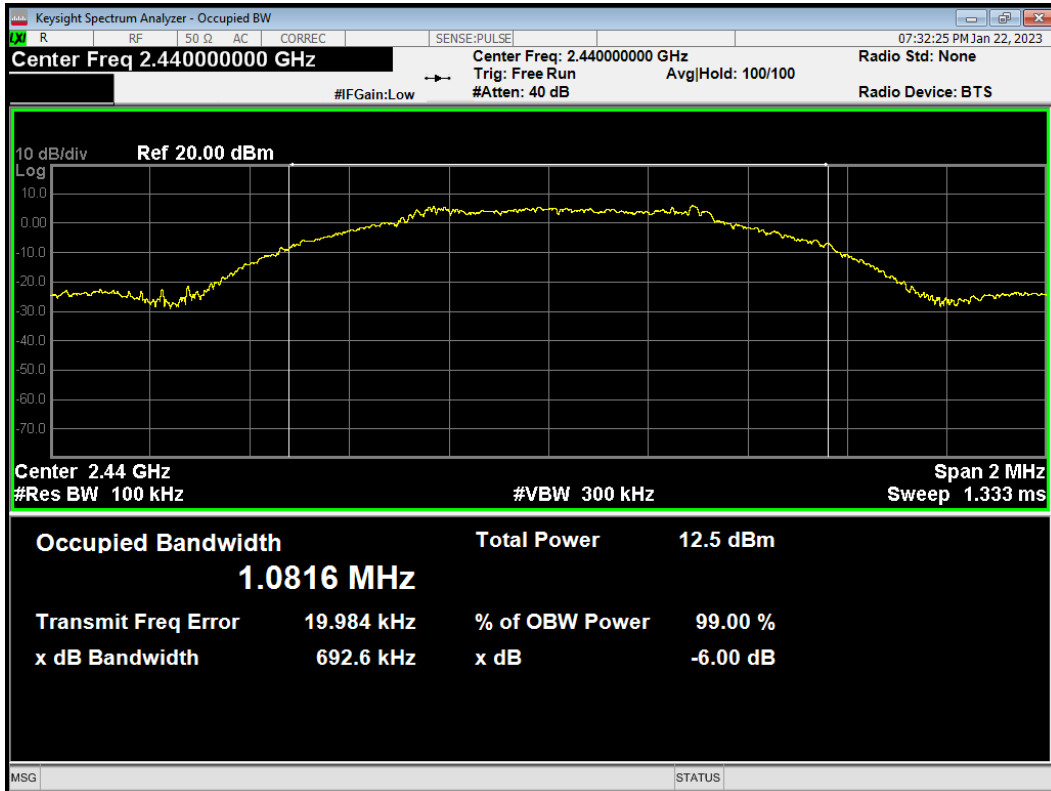

-6dB Bandwidth BLE 2480MHz

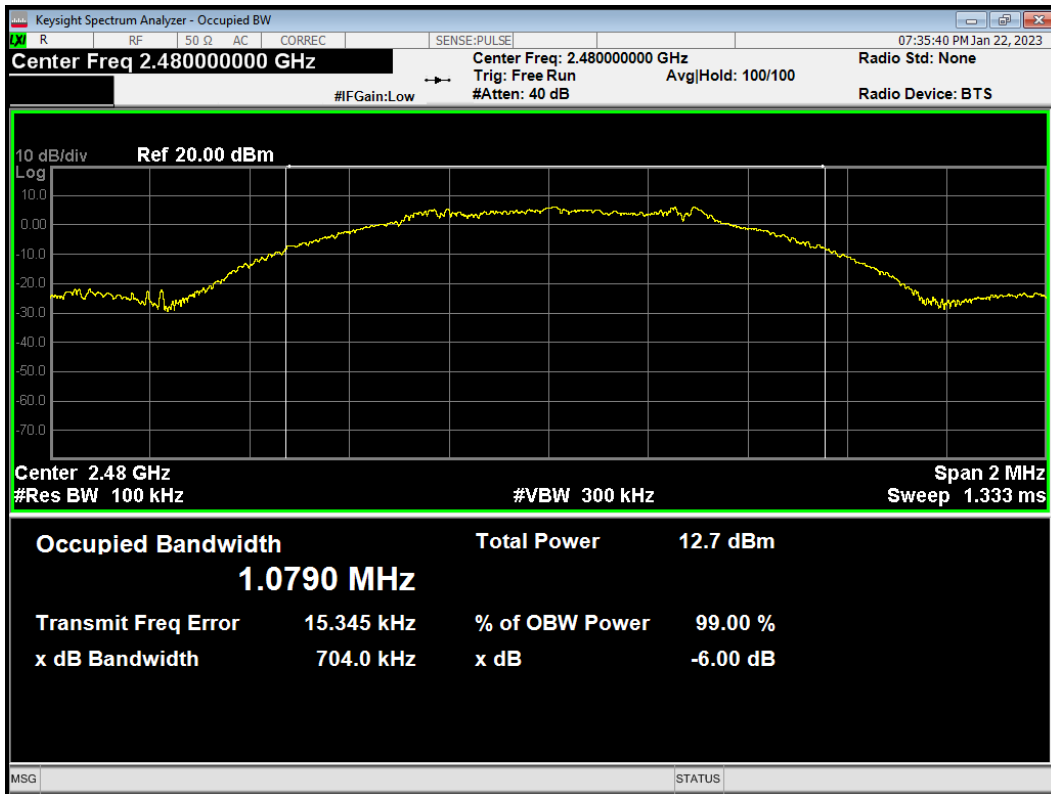

5.3. Band Edge

Ambient Condition

Temperature	Relative humidity
20°C ~25°C	45%~50%

Method of Measurement

The EUT was connected to the spectrum analyzer through an external attenuator (20dB) and a known loss cable the band edge of the lowest and highest channels were measured. The peak detector is used and RBW is set to 100 kHz and VBW is set to 300 kHz on spectrum analyzer. Spectrum analyzer plots are included on the following pages.

Test Setup

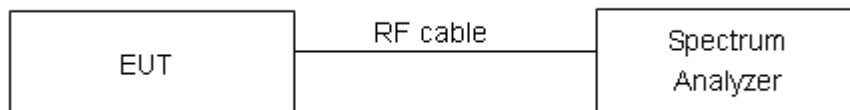

Limits

Rule Part 15.247(d) specifies that “In any 100 kHz bandwidth outside the frequency band in which the spread spectrum or digitally modulated intentional radiator is operating, the radio frequency power that is produced by the intentional radiator shall be at least 20 dB below that in the 100 kHz bandwidth within the band that contains the highest level of the desired power, based on either an RF conducted or a radiated measurement, provided the transmitter demonstrates compliance with the peak conducted power limits.” If the transmitter complies with the conducted power limits based on the use of RMS averaging over a time interval, as permitted under paragraph (b)(3) of this section, the attenuation required under this paragraph shall be 30 dB instead of 20 dB.”

Measurement Uncertainty

The assessed measurement uncertainty to ensure 95% confidence level for the normal distribution is with the coverage factor $k = 1.96$.

Frequency	Uncertainty
2GHz-3GHz	1.407 dB

Test Results: PASS

Band Edge BLE 2402MHz Ref

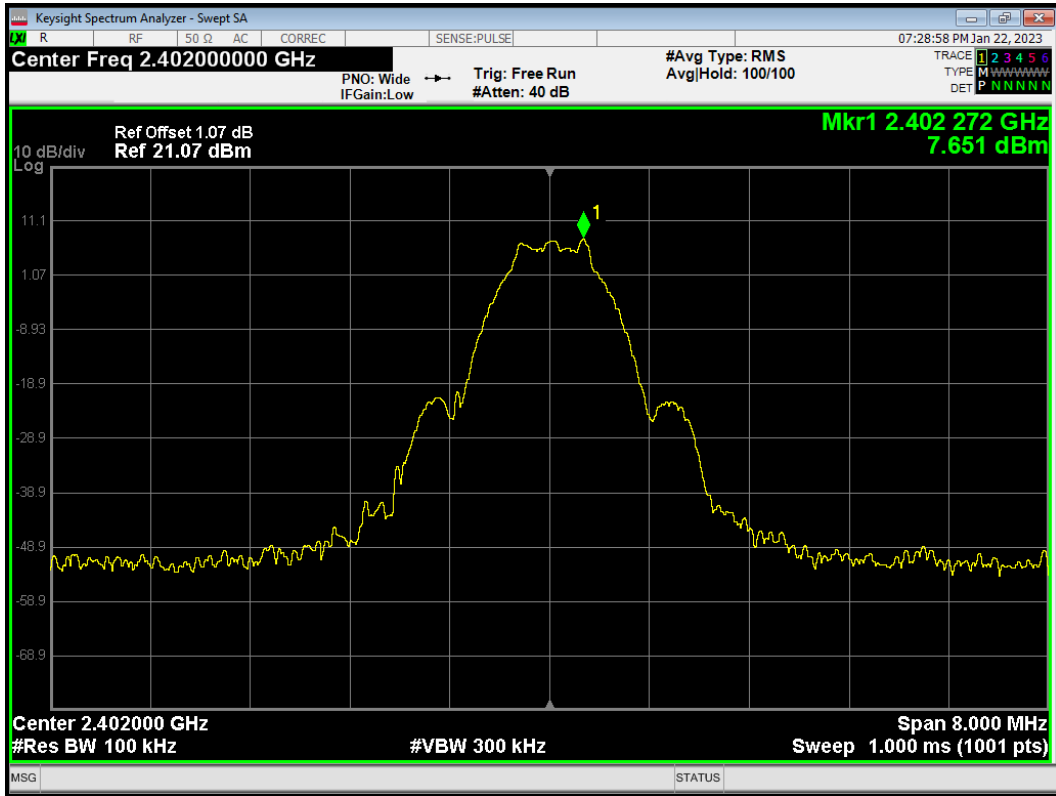

Band Edge BLE 2402MHz Emission

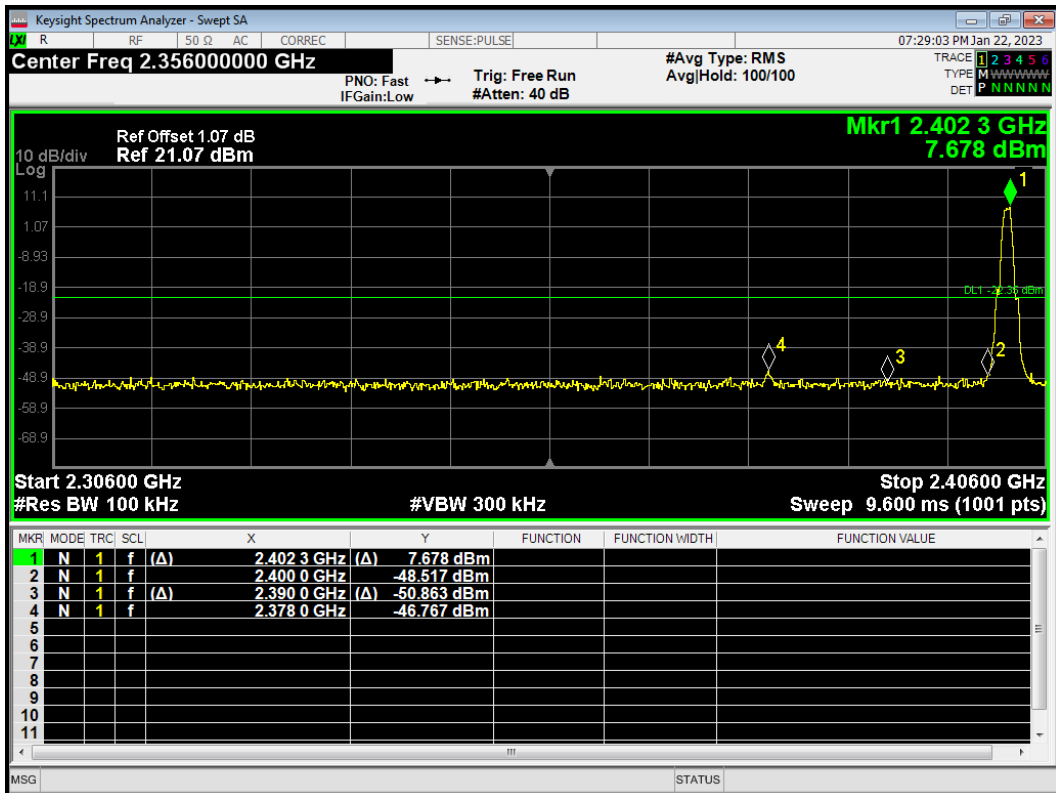

Band Edge BLE 2480MHz Ref

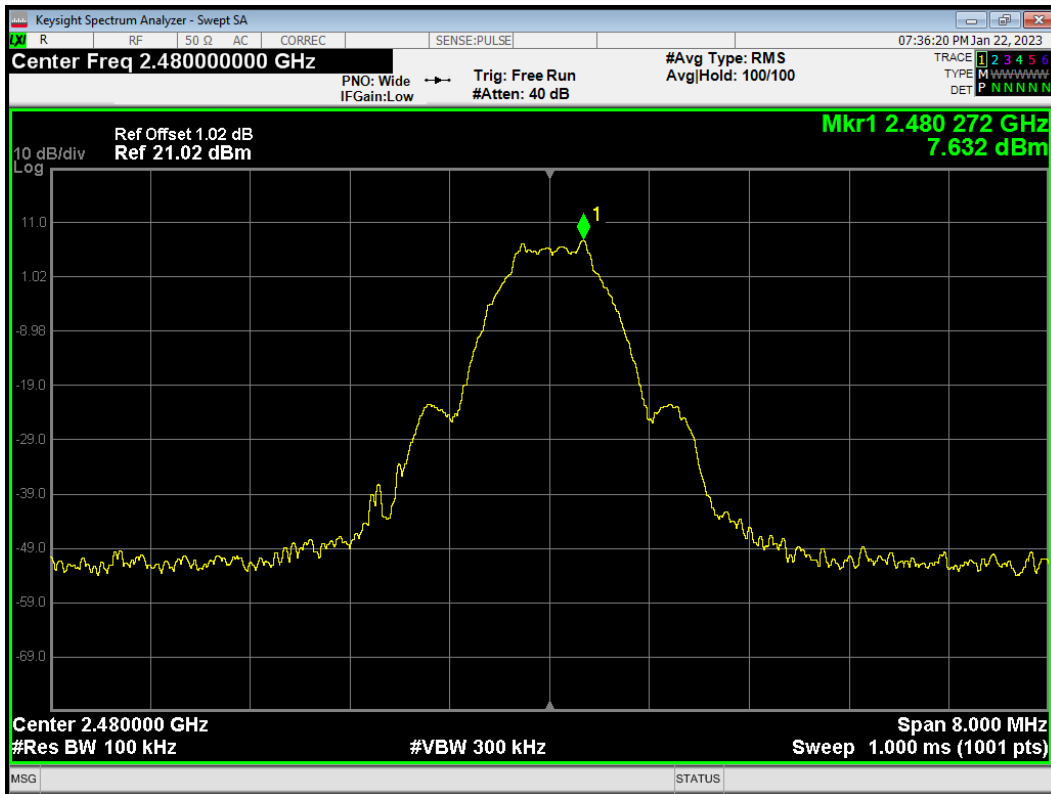

Band Edge BLE 2480MHz Emission

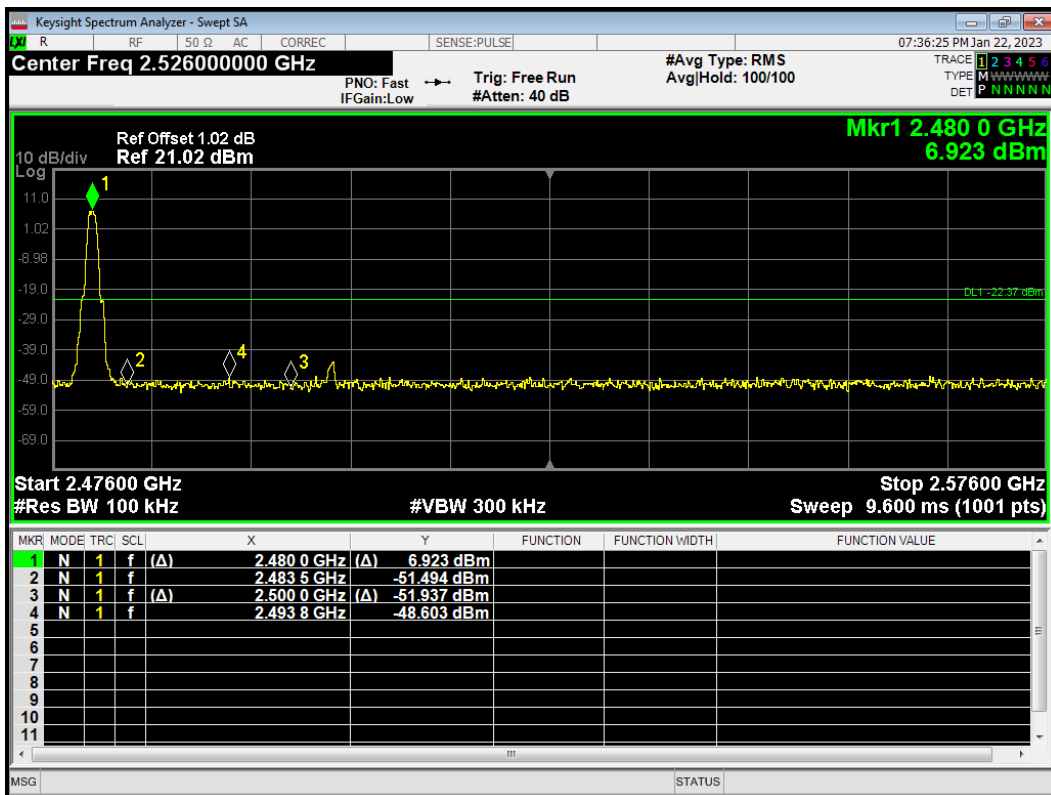

5.4. Power Spectral Density

Ambient Condition

Temperature	Relative humidity
20°C ~25°C	45%~50%

Method of Measurement

During the process of the testing, The EUT was connected to Spectrum Analyzer with a known loss. The EUT is max power transmission with proper modulation.

Method AVGPSD-2 was used for this test.

- a) Measure the duty cycle (D)of the transmitter output signal as described in 11.6
- b) Set instrument center frequency to DTS channel center frequency
- c) Set span to at least 1.5 times the OBW
- d) Set RBW to: $3\text{kHz} \leq \text{RBW} \leq 100\text{Kh}$
- e) Set $\text{VBW} \geq [3x \text{RBW}]$
- f) Detector= power averaging (rms) or sample detector (when rms not available)
- g) Ensure that the number of measurement points in the sweep $\geq [2 \times \text{span}/\text{RBW}]$
- h) Sweep time =auto couple
- i) Do not use sweep triggering; allow sweep to "free run"
- j) Employ trace averaging (rms) mode over a minimum of 100 traces
- k) Use the peak marker function to determine the maximum amplitude level
- l) Add $[10 \log(1/ D)]$, where D is the duty cycle measured in step a), to the measured PSD to compute the average PSD during the actual transmission time
- m) If measured value exceeds requirement specified by regulatory agency then reduce RBW (but no less than 3 kHz) and repeat (note that this may require zooming in on the emission of interest and reducing the span to meet the minimum measurement point requirement as the RBW is reduced)

Test setup

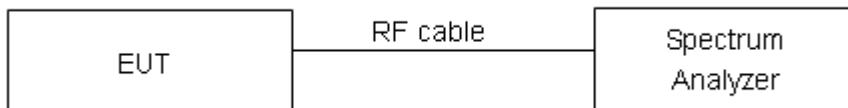

Limits

Rule Part 15.247(e) specifies that” For digitally modulated systems, the power spectral density conducted from the intentional radiator to the antenna shall not be greater than 8 dBm in any 3 kHz band during any time interval of continuous transmission. ”

Limits	$\leq 8 \text{ dBm} / 3\text{kHz}$
--------	------------------------------------

Measurement Uncertainty

The assessed measurement uncertainty to ensure 95% confidence level for the normal distribution is with the coverage factor $k = 2$, $U = 0.75\text{dB}$.

Test Results:

Test Mode	Channel Number	Read Value (dBm / 3kHz)	Power Spectral Density (dBm / 3kHz)	Limit (dBm / 3kHz)	Conclusion
Bluetooth (Low Energy)	0	-13.63	-12.94	8	PASS
	19	-14.39	-13.70	8	PASS
	39	-13.81	-13.12	8	PASS

Note: Power Spectral Density = Read Value + Duty cycle correction factor

PSD BLE 2402MHz

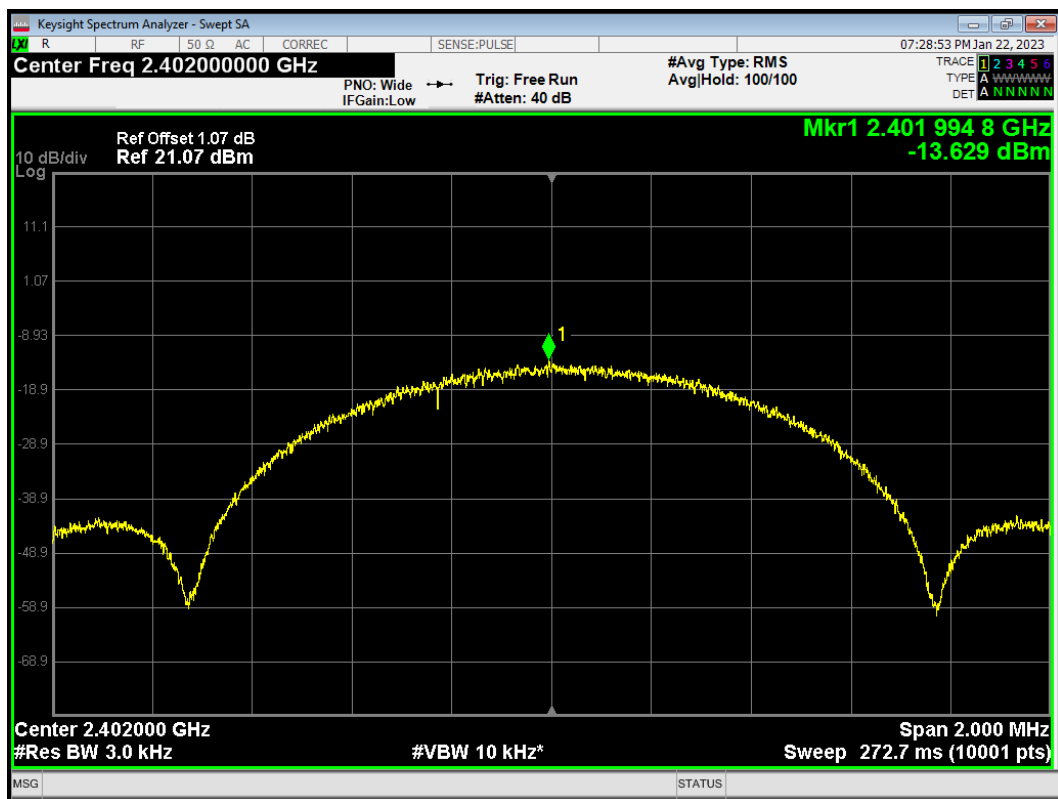

PSD BLE 2440MHz

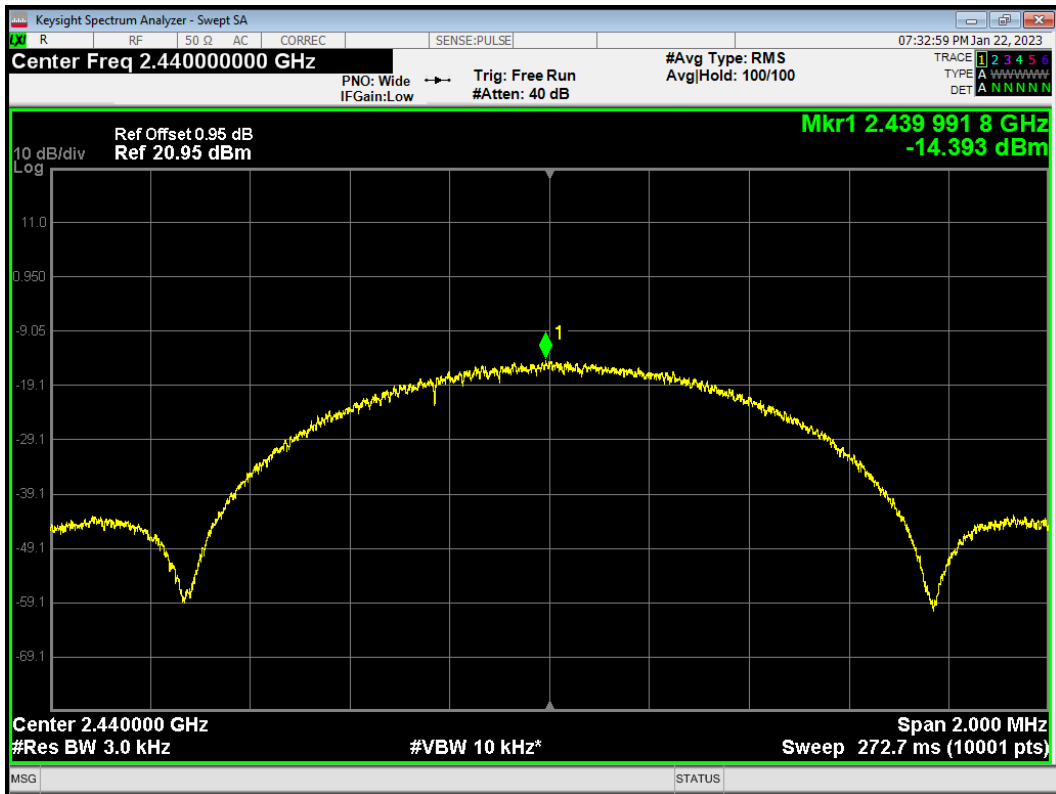

PSD BLE 2480MHz

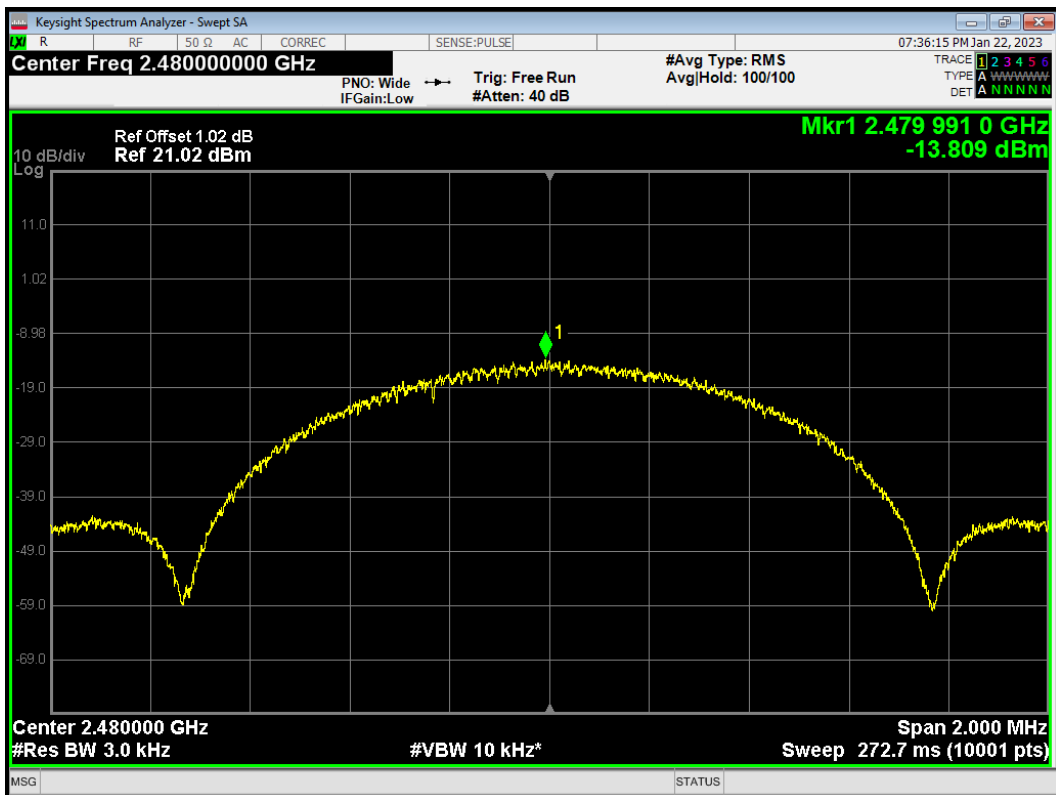

5.5. Spurious RF Conducted Emissions

Ambient Condition

Temperature	Relative humidity
20°C ~25°C	45%~50%

Method of Measurement

The EUT was connected to the spectrum analyzer with a known loss. The spectrum analyzer scans from 30MHz to the 10th harmonic of the carrier. The peak detector is used. Set RBW to 100 kHz and VBW to 300 kHz, Sweep is set to ATUO.

The test is in transmitting mode.

Test Setup



Limits

Rule Part 15.247(d) pacifies that “In any 100 kHz bandwidth outside the frequency band in which the spread spectrum or digitally modulated intentional radiator is operating, the radio frequency power that is produced by the intentional radiator shall be at least 20 dB below that in the 100 kHz bandwidth within the band that contains the highest level of the desired power, based on either an RF conducted or a radiated measurement, provided the transmitter demonstrates compliance with the peak conducted power limits. If the transmitter complies with the conducted power limits based on the use of RMS averaging over a time interval, as permitted under paragraph (b)(3) of this section, the attenuation required under this paragraph shall be 30 dB instead of 20 dB. ”

Test Mode	Carrier frequency (MHz)	Reference value (dBm)	Limit
Bluetooth (Low Energy)	2402	7.52	-22.48
	2440	7.16	-22.84
	2480	7.67	-22.33

Measurement Uncertainty

The assessed measurement uncertainty to ensure 95% confidence level for the normal distribution is with the coverage factor $k = 1.96$.

Frequency	Uncertainty
100kHz-2GHz	0.684 dB
2GHz-26GHz	1.407 dB

Test Results:

Tx. Spurious BLE 2402MHz Ref

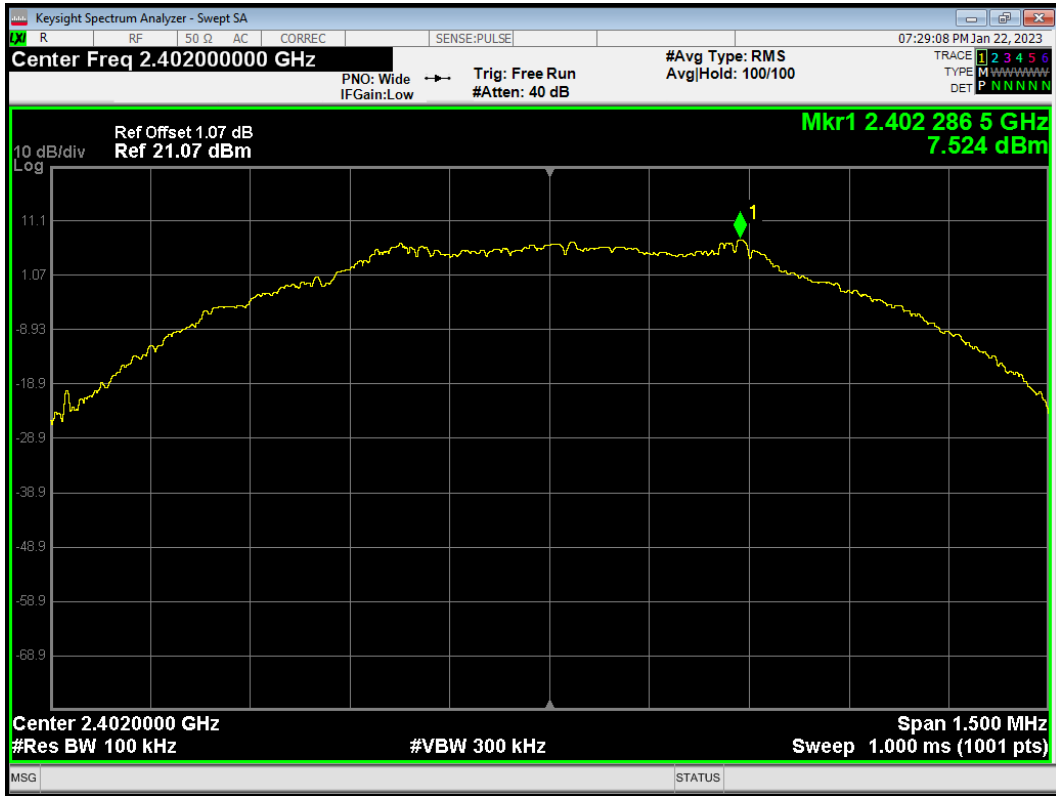

Tx. Spurious BLE 2402MHz Emission

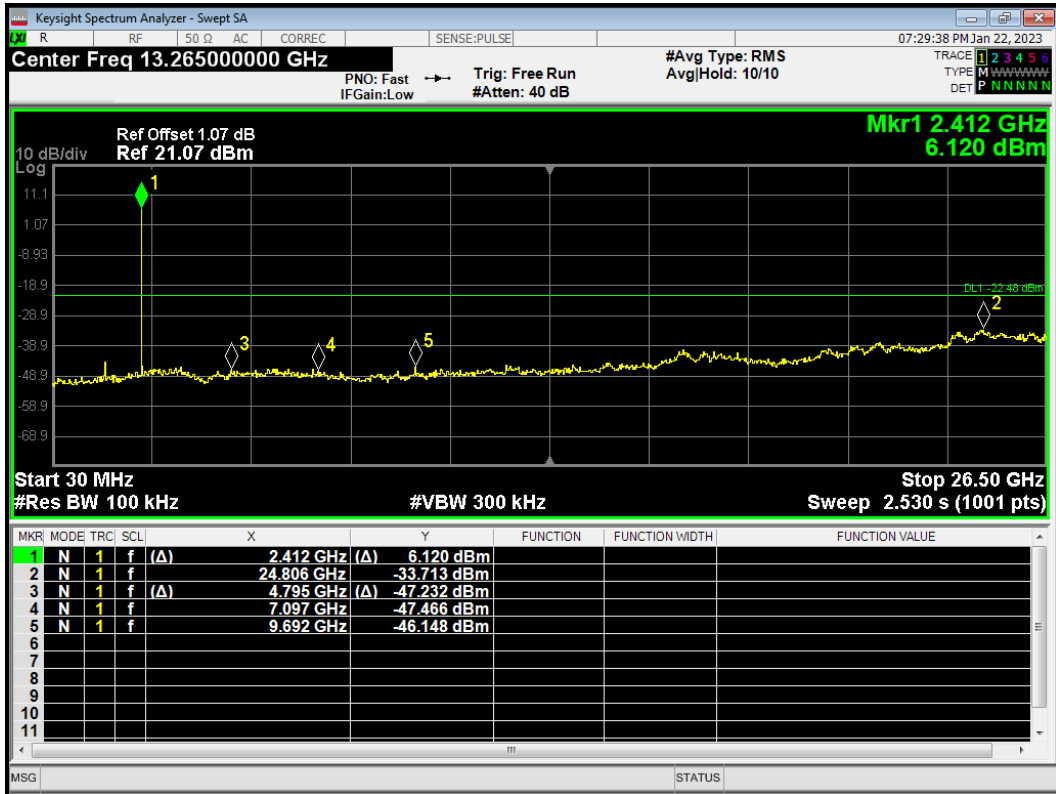

Tx. Spurious BLE 2440MHz Ref

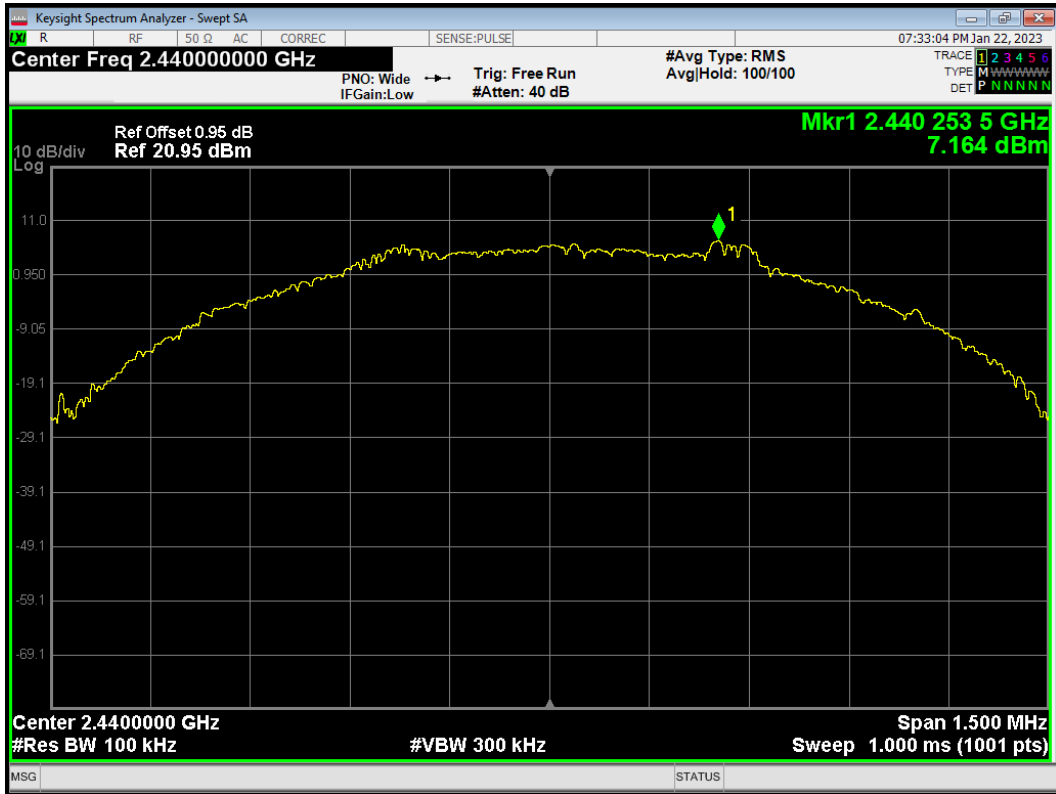

Tx. Spurious BLE 2440MHz Emission

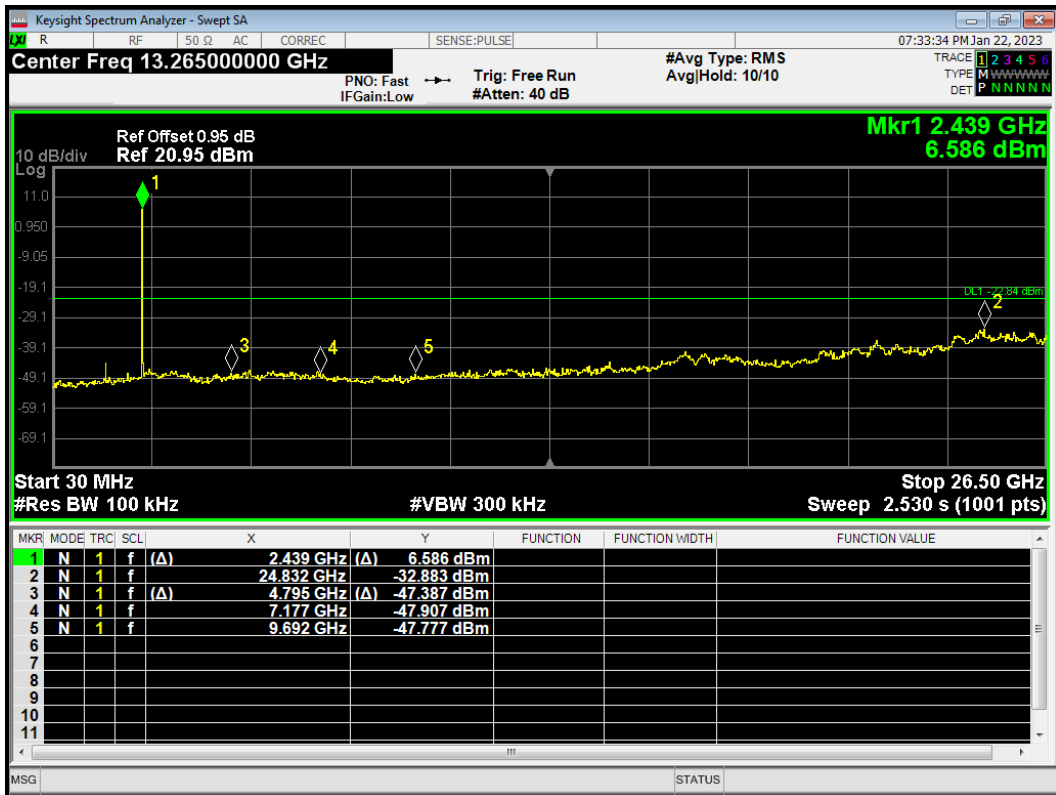

Tx. Spurious BLE 2480MHz Ref

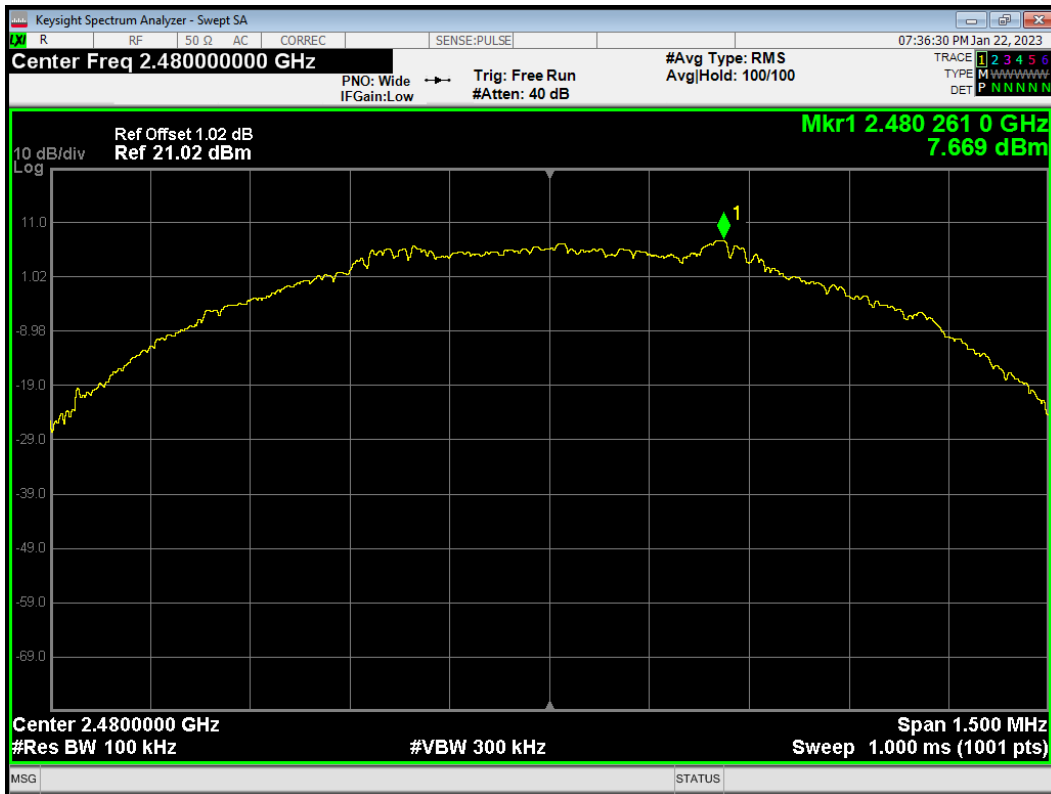

Tx. Spurious BLE 2480MHz Emission

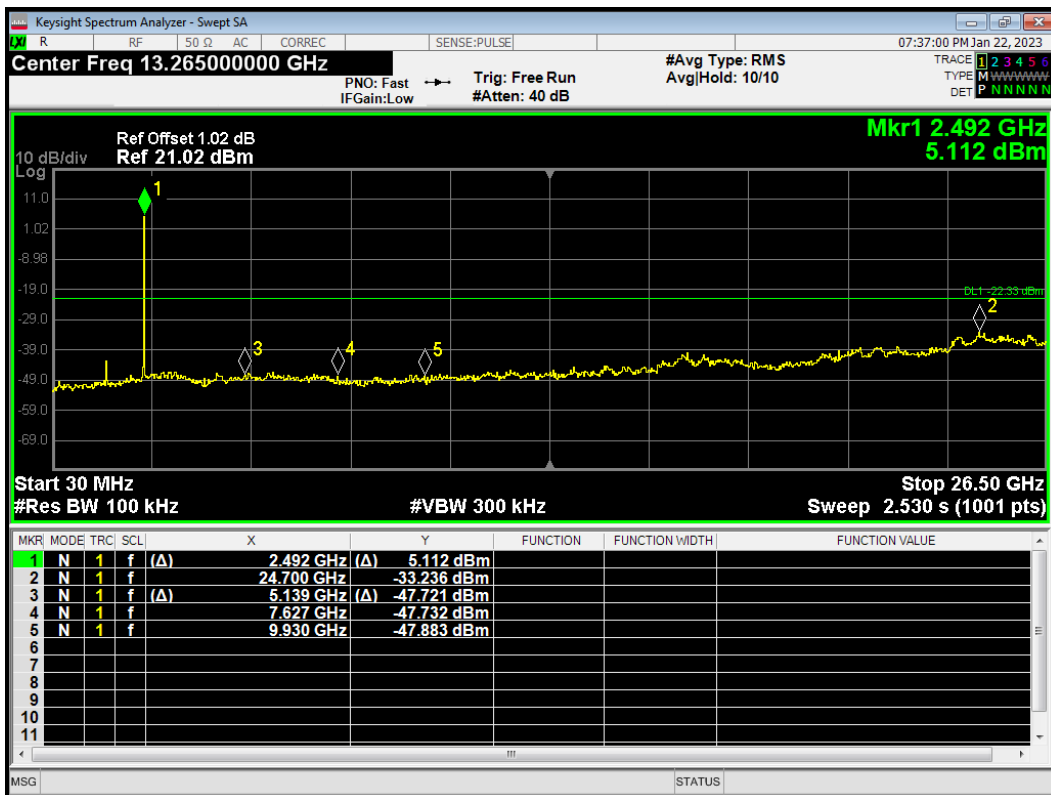

5.6. Unwanted Emission

Ambient Condition

Temperature	Relative humidity
20°C ~25°C	45%~50%

Method of Measurement

The test set-up was made in accordance to the general provisions of ANSI C63.10.

The Equipment Under Test (EUT) was set up on a non-conductive table in the semi-anechoic chamber. The test was performed at the distance of 3 m between the EUT and the receiving antenna.

The turntable shall be rotated from 0 to 360 degrees for detecting the maximum of radiated spurious signal level. The measurements shall be repeated with orthogonal polarization of the test antenna. The data of cable loss and antenna factor has been calibrated in full testing frequency range before the testing. Sweep the Restricted Band and the emissions less than 20 dB below the permissible value are reported.

The radiated emissions measurements were made in a typical installation configuration.

Sweep the whole frequency band through the range from 9 kHz to the 10th harmonic of the carrier, and the emissions less than 20 dB below the permissible value are reported.

This method refer to ANSI C63.10.

The procedure for peak unwanted emissions measurements above 1000 MHz is as follows:

Set the spectrum analyzer in the following:

9kHz~150 kHz

RBW=200Hz, VBW=1kHz/ Sweep=AUTO

150 kHz~30MHz

RBW=9KHz, VBW=30KHz,/ Sweep=AUTO

Below 1GHz

RBW=100kHz / VBW=300kHz / Sweep=AUTO

a) Peak emission levels are measured by setting the instrument as follows:

Above 1GHz

PEAK: RBW=1MHz VBW=3MHz/ Sweep=AUTO

b) Average emission levels are measured by setting the instrument as follows:

Above 1GHz

AVERAGE: RBW=1MHz / VBW=3MHz / Sweep=AUTO

c) Detector: The measurements employing a CISPR quasi-peak detector except for the frequency bands 9-90 kHz, 110-490 kHz and above 1000 MHz. Radiated emission limits in these three bands are based on measurements employing an average detector.

d) Averaging type = power (i.e., rms) (As an alternative, the detector and averaging type may be set for linear voltage averaging. Some instruments require linear display mode to use linear voltage averaging. Log or dB averaging shall not be used.)

- e) Sweep time = auto.
- f) Perform a trace average of at least 100 traces if the transmission is continuous. If the transmission is not continuous, then the number of traces shall be increased by a factor of $1 / D$, where D is the duty cycle. For example, with 50% duty cycle, at least 200 traces shall be averaged. (If a specific emission is demonstrated to be continuous—i.e., 100% duty cycle—then rather than turning ON and OFF with the transmit cycle, at least 100 traces shall be averaged.)
- g) If tests are performed with the EUT transmitting at a duty cycle less than 98%, then a correction factor shall be added to the measurement results prior to comparing with the emission limit, to compute the emission level that would have been measured had the test been performed at 100% duty cycle. The correction factor is computed as follows:
- 1) If power averaging (rms) mode was used in the preceding step e), then the correction factor is $[10 \log (1 / D)]$, where D is the duty cycle. For example, if the transmit duty cycle was 50%, then 3 dB shall be added to the measured emission levels.
 - 2) If linear voltage averaging mode was used in the preceding step e), then the correction factor is $[20 \log (1 / D)]$, where D is the duty cycle. For example, if the transmit duty cycle was 50%, then 6 dB shall be added to the measured emission levels.
 - 3) If a specific emission is demonstrated to be continuous (100% duty cycle) rather than turning ON and OFF with the transmit cycle, then no duty cycle correction is required for that emission.

The test is in transmitting mode.

Test Setup

9KHz~ 30MHz

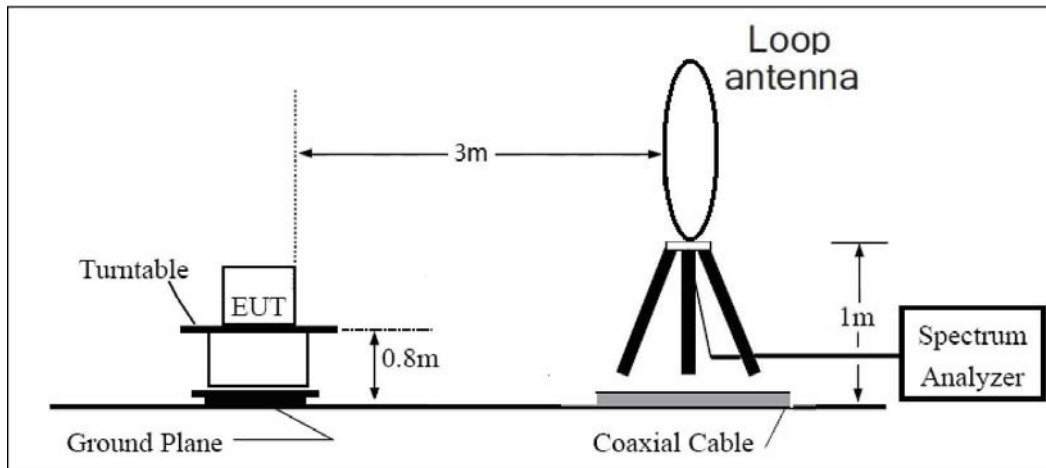

30MHz~ 1GHz

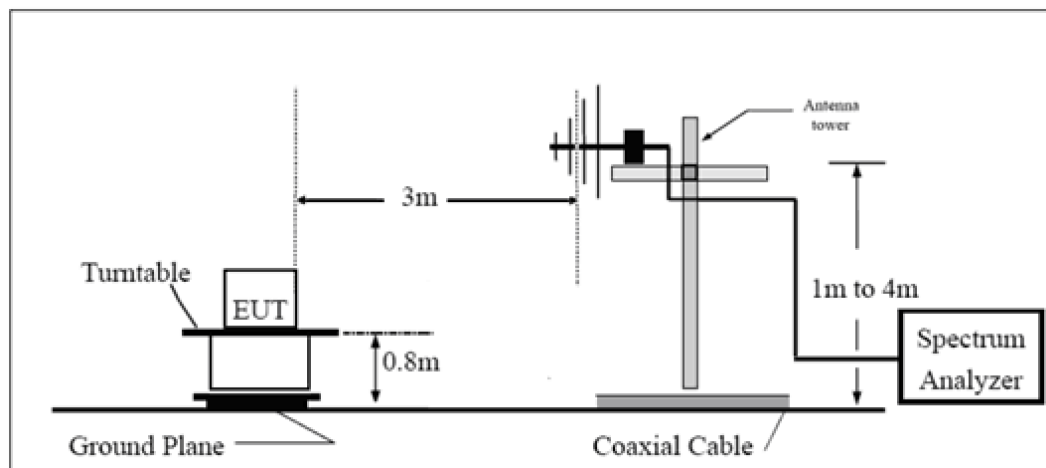

Above 1GHz

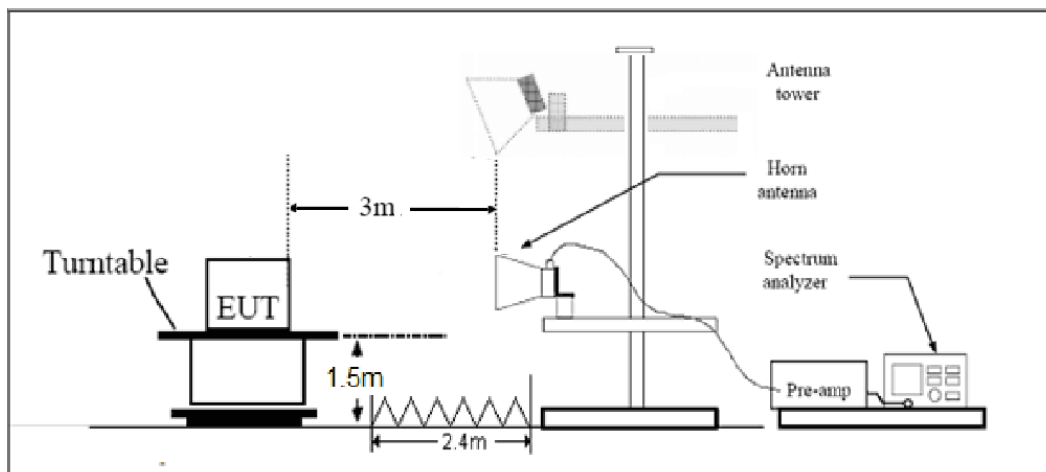

Note: Area side:2.4mX3.6m

Limits

Rule Part 15.247(d) specifies that “In addition, radiated emissions which fall in the restricted bands, as defined in § 15.205(a), must also comply with the radiated emission limits specified in § 15.209(a) (see § 15.205(c)).”

Limit in restricted band

Frequency of emission (MHz)	Field strength($\mu\text{V}/\text{m}$)	Field strength($\text{dB}\mu\text{V}/\text{m}$)
0.009–0.490	2400/F(kHz)	/
0.490–1.705	24000/F(kHz)	/
1.705–30.0	30	/
30-88	100	40
88-216	150	43.5
216-960	200	46
Above960	500	54

§15.35(b)

There is also a limit on the radio frequency emissions, as measured using instrumentation with a peak detector function, corresponding to 20 dB above the maximum permitted average limit.

Peak Limit=74 $\text{dB}\mu\text{V}/\text{m}$

Average Limit=54 $\text{dB}\mu\text{V}/\text{m}$

Spurious Radiated Emissions are permitted in any of the frequency bands listed below:

MHz	MHz	MHz	GHz
0.090-0.110	16.42-16.423	399.9-410	4.5-5.15
¹ 0.495-0.505	16.69475-16.69525	608-614	5.35-5.46
2.1735-2.1905	16.80425-16.80475	960-1240	7.25-7.75
4.125-4.128	25.5-25.67	1300-1427	8.025-8.5
4.17725-4.17775	37.5-38.25	1435-1626.5	9.0-9.2
4.20725-4.20775	73-74.6	1645.5-1646.5	9.3-9.5
6.215-6.218	74.8-75.2	1660-1710	10.6-12.7
6.26775-6.26825	108-121.94	1718.8-1722.2	13.25-13.4
6.31175-6.31225	123-138	2200-2300	14.47-14.5
8.291-8.294	149.9-150.05	2310-2390	15.35-16.2
8.362-8.366	156.52475-156.52525	2483.5-2500	17.7-21.4
8.37625-8.38675	156.7-156.9	2690-2900	22.01-23.12
8.41425-8.41475	162.0125-167.17	3260-3267	23.6-24.0
12.29-12.293	167.72-173.2	3332-3339	31.2-31.8
12.51975-12.52025	240-285	3345.8-3358	36.43-36.5
12.57675-12.57725	322-335.4	3600-4400	(²)
13.36-13.41			

Measurement Uncertainty

The assessed measurement uncertainty to ensure 95% confidence level for the normal distribution is with the coverage factor $k = 1.96$.

Frequency	Uncertainty
9KHz-30MHz	3.55 dB
30MHz-200MHz	4.17 dB
200MHz-1GHz	4.84 dB
1-18GHz	4.35 dB
18-26.5GHz	5.90 dB
26.5GHz~40GHz	5.92 dB

Test Results:

A symbol ($\text{dB } \mu\text{V/m}$) in the test plot below means ($\text{dB}\mu\text{V/m}$)

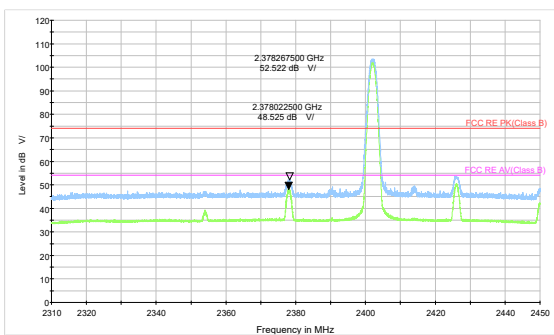

Bluetooth LE Channel 0 Peak+ Average

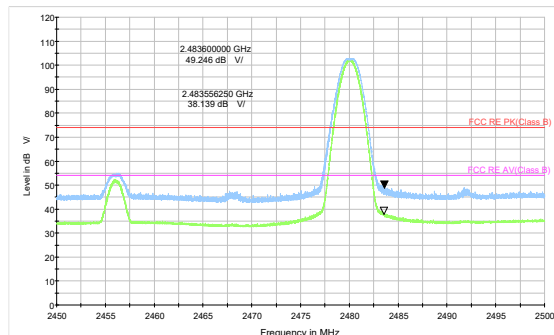

Bluetooth LE Channel 39 Peak+ Average

Result of RE

Test result

Sweep the whole frequency band through the range from 9kHz to the 10th harmonic of the carrier, the Emissions in the frequency band 9kHz-30MHz and 18GHz-26.5GHz are more than 20dB below the limit are not reported.

The following graphs display the maximum values of horizontal and vertical by software. For above 1GHz, Blue trace uses the peak detection, Green trace uses the average detection.

Continuous TX mode:

Bluetooth LE

During the test, the Radiates Emission from 30MHz to 1GHz was performed in all modes with all channels, Bluetooth LE-Channel 39 are selected as the worst condition. The test data of the worst-case condition was recorded in this report.

A symbol (dB V/) in the test plot below means (dBμV/m)

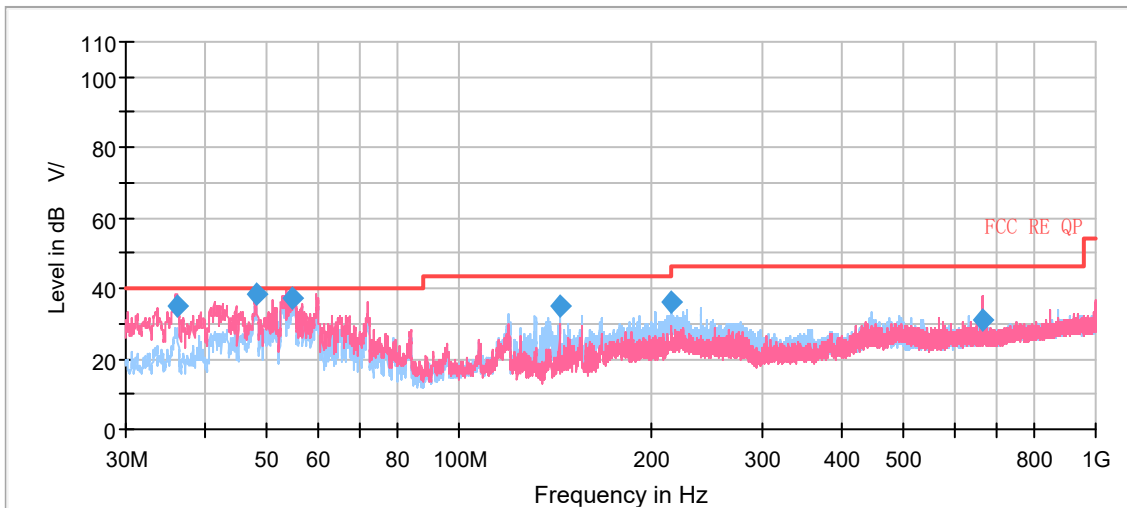

Radiates Emission from 30MHz to 1GHz

Frequency (MHz)	Quasi-Peak (dBμV/m)	Limit (dBμV/m)	Margin (dB)	Height (cm)	Polarization	Azimuth (deg)	Correct Factor (dB)
36.054000	34.85	40.00	5.15	100.0	V	165.0	18.1
47.986667	38.14	40.00	1.86	100.0	V	80.0	20.5
54.670333	37.26	40.00	2.74	100.0	V	16.0	20.2
143.982667	34.82	43.50	8.68	184.0	H	239.0	14.7
215.907333	35.93	43.50	7.57	100.0	H	214.0	17.9
665.459000	30.86	46.00	15.14	100.0	V	214.0	27.2

- Remark: 1. Correction Factor = Antenna factor + Insertion loss (cable loss + amplifier gain)**
- 2. Margin = Limit – Quasi-Peak**

Bluetooth LE-Channel 0

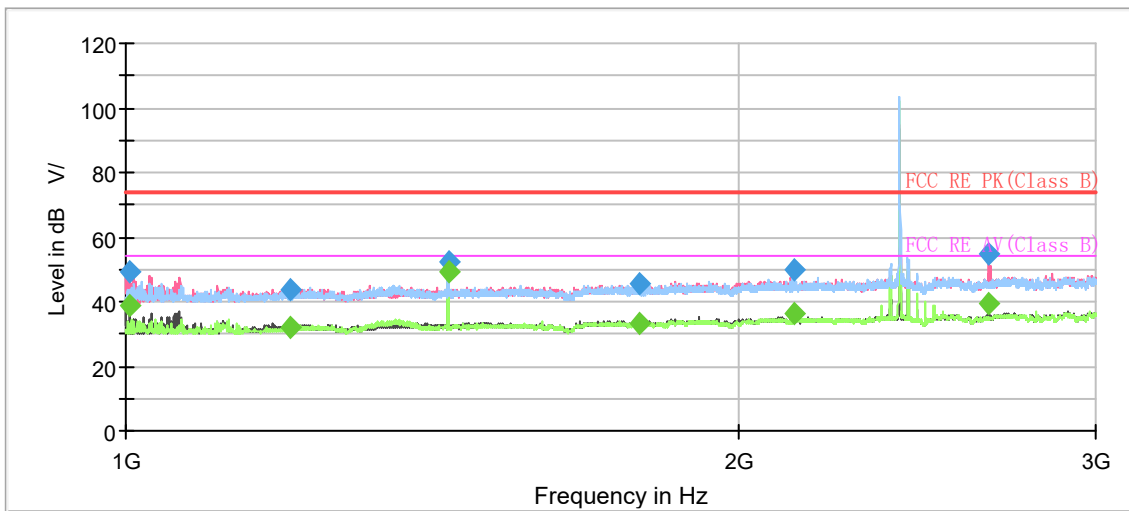

Note: The signal beyond the limit is carrier.
Radiates Emission from 1GHz to 3GHz

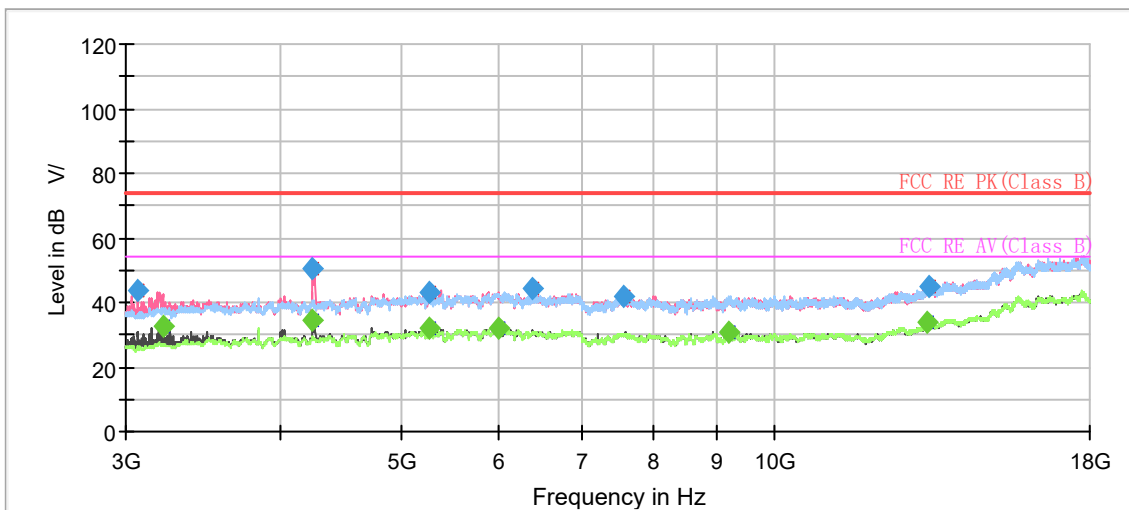

Radiates Emission from 3GHz to 18GHz

Frequency (MHz)	MaxPeak (dB μ V/m)	Average (dB μ V/m)	Limit (dB μ V/m)	Margin (dB)	Meas. Time (ms)	Height (cm)	Pol	Azimuth (deg)	Corr. (dB/m)
1004.250000	---	39.00	54.00	15.00	500.0	200.0	V	221.0	-8.8
1004.250000	49.20	---	74.00	24.80	500.0	200.0	V	221.0	-8.8
1205.000000	43.74	---	74.00	30.26	500.0	100.0	V	200.0	-7.4
1205.250000	---	32.31	54.00	21.69	500.0	100.0	V	11.0	-7.4
1441.000000	52.45	---	74.00	21.55	500.0	200.0	H	295.0	-5.9
1441.250000	---	49.09	54.00	4.91	500.0	100.0	H	289.0	-5.9
1788.500000	45.49	---	74.00	28.52	500.0	200.0	V	162.0	-4.1
1790.750000	---	33.29	54.00	20.71	500.0	100.0	V	324.0	-4.1
2132.750000	49.75	---	74.00	24.25	500.0	100.0	V	301.0	-2.3
2133.250000	---	36.07	54.00	17.93	500.0	100.0	V	17.0	-2.3
2658.500000	---	39.43	54.00	14.57	500.0	200.0	V	244.0	-0.1
2658.500000	54.51	---	74.00	19.49	500.0	200.0	V	244.0	-0.1

Remark: 1. Correction Factor = Antenna factor + Insertion loss (cable loss + amplifier gain)

2. Margin = Limit - MAX Peak/ Average

Bluetooth LE-Channel 19

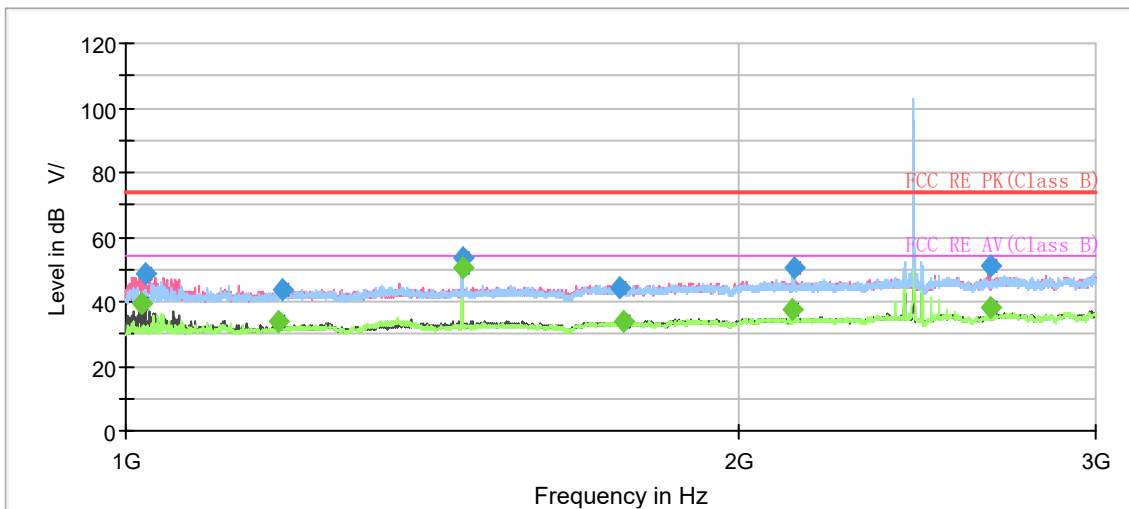

Note: The signal beyond the limit is carrier.
Radiates Emission from 1GHz to 3GHz

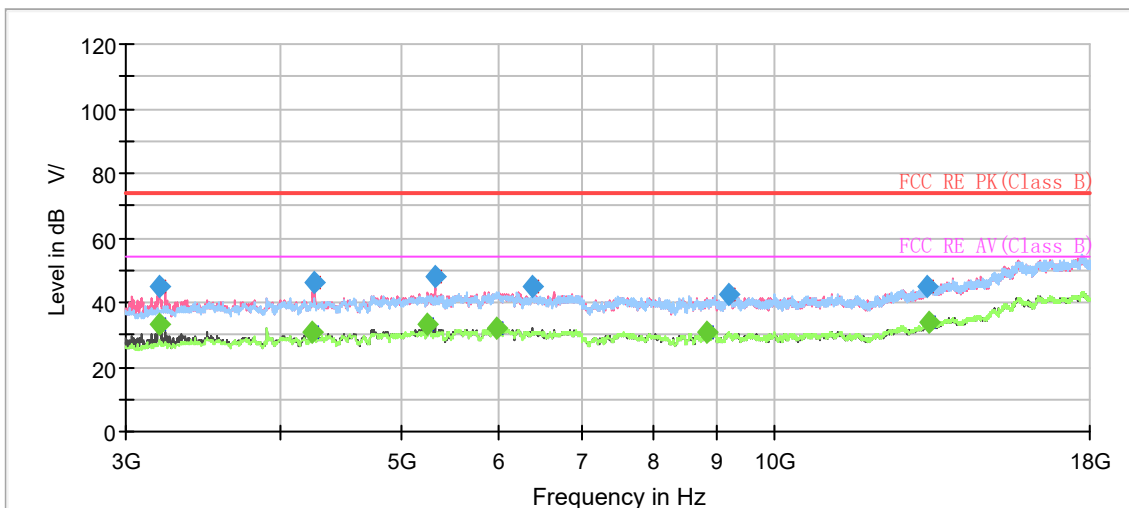

Radiates Emission from 3GHz to 18GHz

Frequency (MHz)	MaxPeak (dB μ V/m)	Average (dB μ V/m)	Limit (dB μ V/m)	Margin (dB)	Meas. Time (ms)	Height (cm)	Pol	Azimuth (deg)	Corr. (dB/m)
1018.000000	---	39.26	54.00	14.74	500.0	200.0	V	222.0	-8.7
1022.250000	48.63	---	74.00	25.37	500.0	200.0	V	227.0	-8.6
1188.000000	---	33.86	54.00	20.14	500.0	100.0	V	194.0	-7.5
1194.250000	43.66	---	74.00	30.34	500.0	200.0	V	191.0	-7.5
1464.000000	---	50.35	54.00	3.65	500.0	100.0	H	291.0	-5.8
1464.250000	53.56	---	74.00	20.44	500.0	200.0	H	294.0	-5.8
1747.750000	44.39	---	74.00	29.61	500.0	200.0	V	92.0	-4.3
1756.000000	---	33.79	54.00	20.21	500.0	100.0	V	307.0	-4.2
2127.500000	---	37.49	54.00	16.51	500.0	200.0	V	36.0	-2.3
2131.750000	50.30	---	74.00	23.70	500.0	200.0	V	69.0	-2.3
2660.250000	---	37.90	54.00	16.10	500.0	200.0	V	271.0	-0.1
2660.250000	51.06	---	74.00	22.94	500.0	200.0	V	271.0	-0.1

Remark: 1. Correction Factor = Antenna factor + Insertion loss (cable loss + amplifier gain)

2. Margin = Limit –MAX Peak/ Average

Bluetooth LE-Channel 39

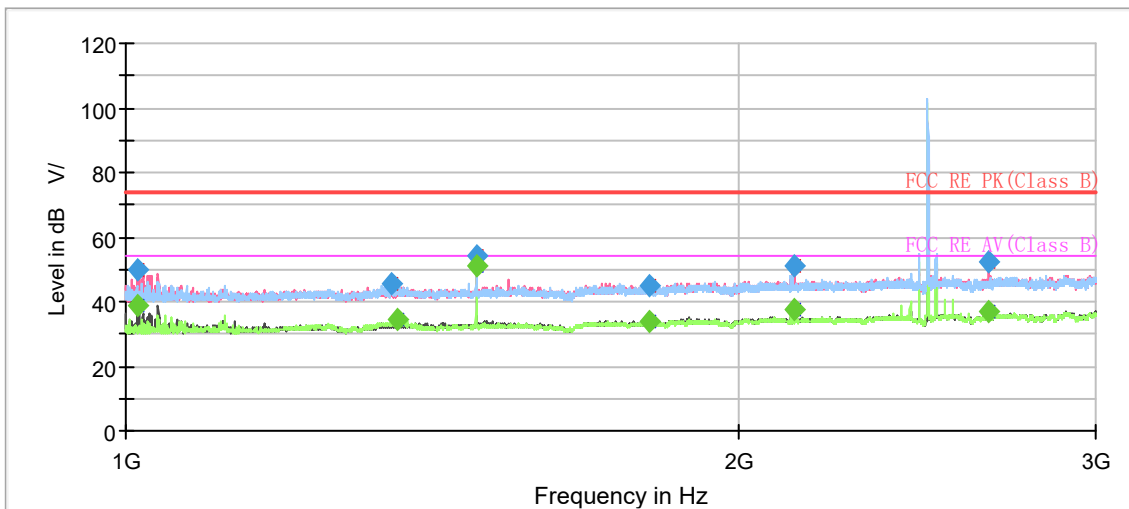

Note: The signal beyond the limit is carrier.
Radiates Emission from 1GHz to 3GHz

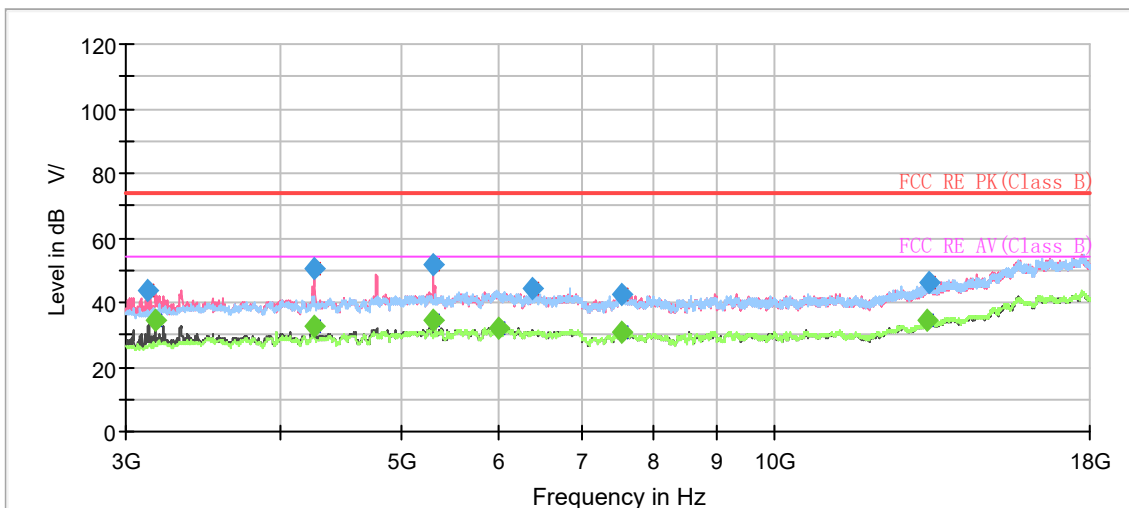

Radiates Emission from 3GHz to 18GHz

Frequency (MHz)	MaxPeak (dB μ V/m)	Average (dB μ V/m)	Limit (dB μ V/m)	Margin (dB)	Meas. Time (ms)	Height (cm)	Pol	Azimuth (deg)	Corr. (dB/m)
1013.000000	49.68	---	74.00	24.32	500.0	200.0	V	209.0	-8.7
1013.500000	---	38.79	54.00	15.21	500.0	200.0	V	209.0	-8.7
1350.000000	45.24	---	74.00	28.76	500.0	200.0	H	277.0	-6.5
1359.250000	---	34.38	54.00	19.62	500.0	200.0	H	277.0	-6.5
1487.750000	53.91	---	74.00	20.09	500.0	200.0	H	287.0	-5.6
1488.000000	---	51.37	54.00	2.63	500.0	200.0	H	282.0	-5.6
1808.250000	45.19	---	74.00	28.81	500.0	100.0	V	89.0	-4.0
1810.250000	---	33.68	54.00	20.32	500.0	100.0	H	264.0	-4.0
2130.000000	51.28	---	74.00	22.72	500.0	200.0	V	26.0	-2.3
2132.000000	---	37.57	54.00	16.43	500.0	200.0	V	21.0	-2.3
2656.500000	---	36.90	54.00	17.10	500.0	200.0	V	223.0	-0.1
2656.500000	52.32	---	74.00	21.68	500.0	200.0	V	223.0	-0.1

Remark: 1. Correction Factor = Antenna factor + Insertion loss (cable loss + amplifier gain)

2. Margin = Limit –MAX Peak/ Average

During the test, the Radiates Emission from 18GHz to 26.5GHz was performed in all modes with all channels, Bluetooth LE-Channel 39 are selected as the worst condition. The test data of the worst-case condition was recorded in this report.

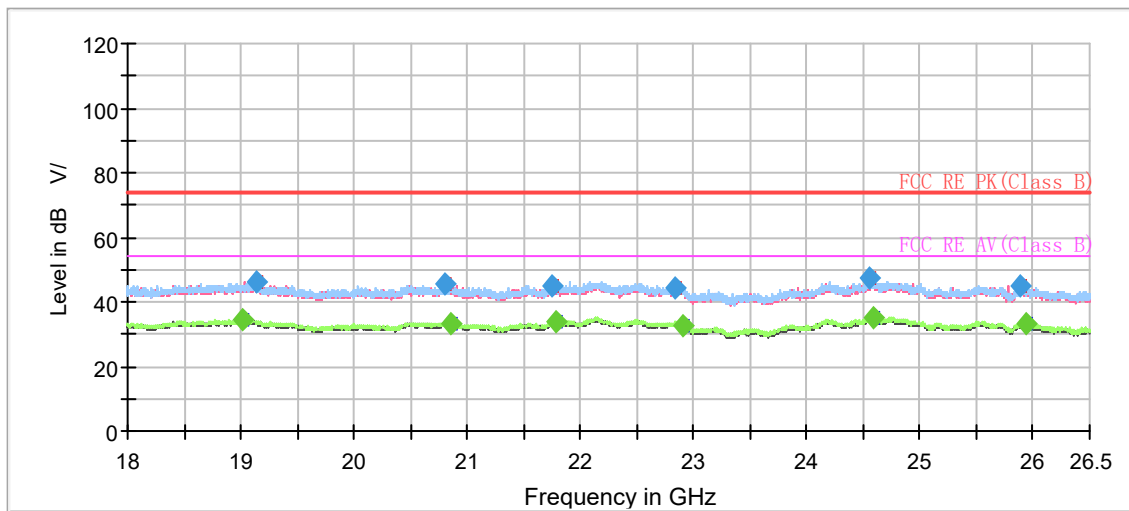

Radiates Emission from 18GHz to 26.5GHz

Frequency (MHz)	MaxPeak (dB μ V/m)	Average (dB μ V/m)	Limit (dB μ V/m)	Margin (dB)	Meas. Time (ms)	Height (cm)	Pol	Azimuth (deg)	Corr. (dB/m)
19023.187500	---	34.35	54.00	19.65	500.0	100.0	H	199.0	-6.5
19141.125000	46.26	---	74.00	27.74	500.0	100.0	H	291.0	-6.5
20811.375000	45.43	---	74.00	28.57	500.0	100.0	H	33.0	-6.3
20852.812500	---	33.42	54.00	20.58	500.0	100.0	H	38.0	-6.3
21749.562500	45.18	---	74.00	28.82	500.0	200.0	V	97.0	-5.3
21777.187500	---	33.95	54.00	20.05	500.0	100.0	H	67.0	-5.2
22842.875000	44.53	---	74.00	29.47	500.0	200.0	H	144.0	-4.8
22905.562500	---	32.78	54.00	21.22	500.0	100.0	H	348.0	-5.1
24555.625000	47.24	---	74.00	26.76	500.0	100.0	H	96.0	-1.8
24597.062500	---	35.05	54.00	18.95	500.0	100.0	H	140.0	-1.6
25892.250000	44.62	---	74.00	29.38	500.0	200.0	V	12.0	-2.9
25935.812500	---	32.95	54.00	21.05	500.0	100.0	H	8.0	-3.0

Remark: 1. Correction Factor = Antenna factor + Insertion loss (cable loss + amplifier gain)

2. Margin = Limit -MAX Peak/ Average

5.7. Conducted Emission

Ambient Condition

Temperature	Relative humidity
20°C ~25°C	45%~50%

Methods of Measurement

The EUT is placed on a non-metallic table of 80cm height above the horizontal metal reference ground plane. During the test, the EUT was operating in its typical mode. The test method is according to ANSI C63.10. Connect the AC power line of the EUT to the L.I.S.N. Use EMI receiver to detect the average and Quasi-peak value. RBW is set to 9 kHz, VBW is set to 30kHz.

The measurement result should include both L line and N line.

The test is in transmitting mode.

Test Setup

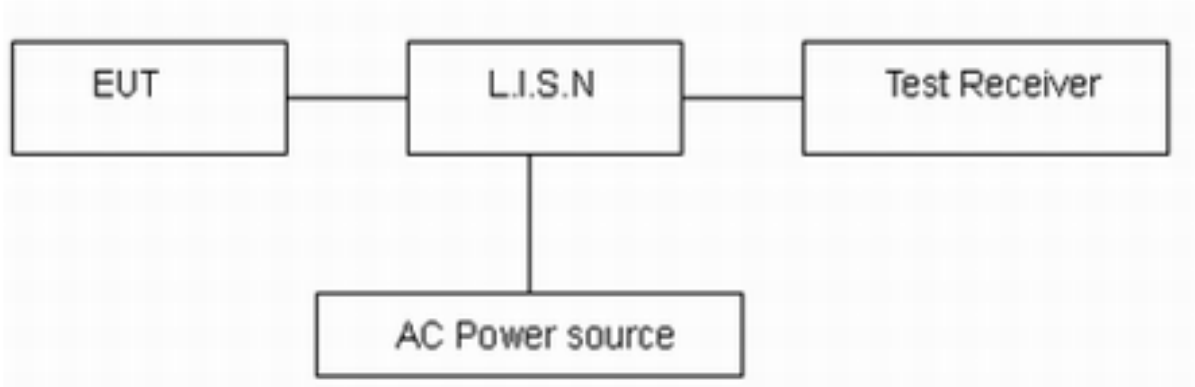

Note: AC Power source is used to change the voltage 110V/60Hz.

Limits

Frequency (MHz)	Conducted Limits(dBμV)	
	Quasi-peak	Average
0.15 - 0.5	66 to 56 *	56 to 46 *
0.5 - 5	56	46
5 - 30	60	50

*: Decreases with the logarithm of the frequency.

Measurement Uncertainty

The assessed measurement uncertainty to ensure 95% confidence level for the normal distribution is with the coverage factor $k = 1.96$, $U = 2.69$ dB.

Test Results:

Following plots, Blue trace uses the peak detection and Green trace uses the average detection.

Bluetooth LE

During the test, the Conducted Emission was performed in all modes with all channels, Bluetooth LE-Channel 39 are selected as the worst condition. The test data of the worst-case condition was recorded in this report.

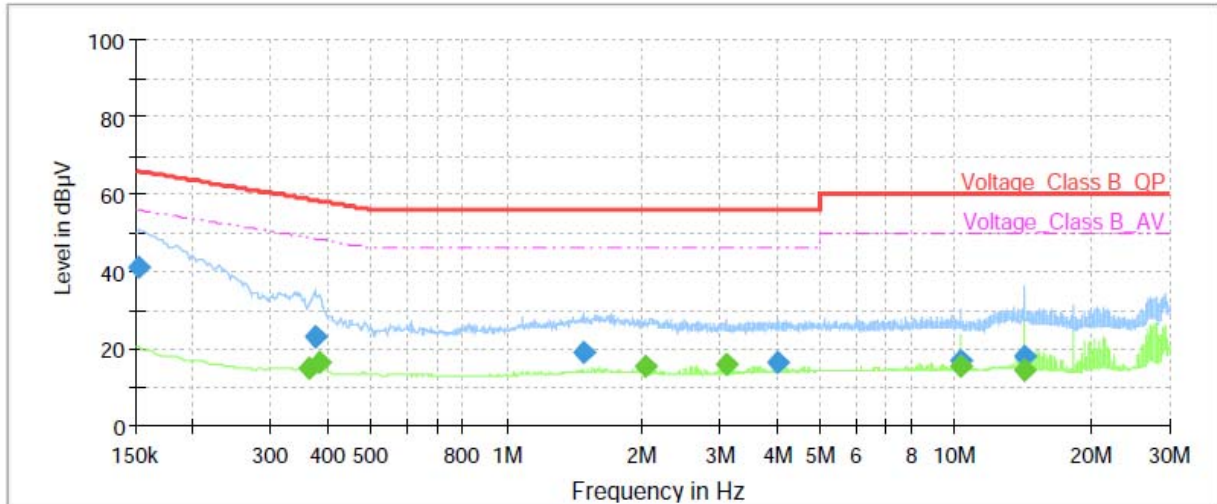

Frequency (MHz)	QuasiPeak (dBµV)	Average (dBµV)	Limit (dBµV)	Margin (dB)	Meas. Time (ms)	Bandwidth (kHz)	Line	Filter	Corr. (dB)
0.15	41.18	---	65.88	24.70	1000.0	9.000	L1	ON	20.9
0.36	---	14.98	48.69	33.71	1000.0	9.000	L1	ON	20.8
0.38	23.18	---	58.39	35.21	1000.0	9.000	L1	ON	20.8
0.38	---	16.34	48.19	31.85	1000.0	9.000	L1	ON	20.8
1.48	19.06	---	56.00	36.94	1000.0	9.000	L1	ON	19.6
2.04	---	15.21	46.00	30.79	1000.0	9.000	L1	ON	19.4
3.08	---	15.94	46.00	30.06	1000.0	9.000	L1	ON	19.2
4.04	16.35	---	56.00	39.65	1000.0	9.000	L1	ON	19.2
10.24	17.13	---	60.00	42.87	1000.0	9.000	L1	ON	19.3
10.24	---	15.20	50.00	34.80	1000.0	9.000	L1	ON	19.3
14.34	---	14.49	50.00	35.51	1000.0	9.000	L1	ON	19.4
14.34	17.83	---	60.00	42.17	1000.0	9.000	L1	ON	19.4

Remark: Correct factor=cable loss + LISN factor

L line Conducted Emission from 150 KHz to 30 MHz

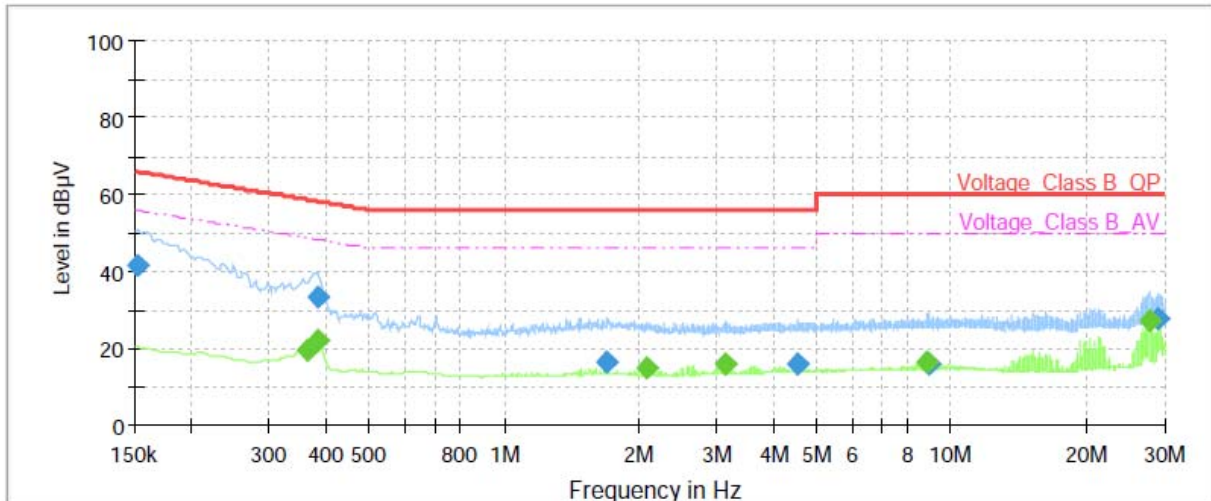

Frequency (MHz)	QuasiPeak (dBµV)	Average (dBµV)	Limit (dBµV)	Margin (dB)	Meas. Time (ms)	Bandwidth (kHz)	Line	Filter	Corr. (dB)
0.15	41.57	---	65.88	24.31	1000.0	9.000	N	ON	20.9
0.36	---	19.71	48.69	28.98	1000.0	9.000	N	ON	20.9
0.38	33.26	---	58.24	24.98	1000.0	9.000	N	ON	20.8
0.38	---	21.91	48.19	26.28	1000.0	9.000	N	ON	20.8
1.70	16.36	---	56.00	39.64	1000.0	9.000	N	ON	19.6
2.08	---	14.91	46.00	31.09	1000.0	9.000	N	ON	19.4
3.12	---	15.86	46.00	30.14	1000.0	9.000	N	ON	19.3
4.52	15.80	---	56.00	40.20	1000.0	9.000	N	ON	19.2
8.84	---	16.30	50.00	33.70	1000.0	9.000	N	ON	19.3
8.95	16.14	---	60.00	43.86	1000.0	9.000	N	ON	19.3
27.68	---	27.11	50.00	22.89	1000.0	9.000	N	ON	20.1
29.00	27.74	---	60.00	32.26	1000.0	9.000	N	ON	20.2

Remark: Correct factor=cable loss + LISN factor

N line Conducted Emission from 150 KHz to 30 MHz

6. Main Test Instruments

Name	Manufacturer	Type	Serial Number	Calibration Date	Expiration Date
Power sensor	R&S	NRP18S	101954	2022-05-14	2023-05-13
Spectrum Analyzer	KEYSIGHT	N9020A	MY51330870	2022-05-14	2023-05-13
Radiated Emission					
EMI Test Receiver	R&S	ESR	102389	2022-05-25	2023-05-24
Signal Analyzer	R&S	FSV40	101186	2022-05-14	2023-05-13
Loop Antenna	SCHWARZBECK	FMZB1519	1519-047	2020-04-02	2023-04-01
TRILOG Broadband Antenna	SCHWARZBECK	VULB 9163	1023	2020-05-05	2023-05-04
Horn Antenna	R&S	HF907	102723	2020-08-11	2023-08-10
Horn Antenna	ETS-Lindgren	3160-09	00102643	2021-10-10	2024-10-09
Software	R&S	EMC32	9.26.0	/	/
Conducted Emission					
LISN	R&S	ENV216	102191	2022-12-13	2024-12-09
EMI Test Receiver	R&S	ESR	101667	2022-05-25	2023-05-24
Software	R&S	EMC32	10.35.10	/	/

*****END OF REPORT *****

ANNEX A: The EUT Appearance

The EUT Appearance are submitted separately.

ANNEX B: Test Setup Photos

The Test Setup Photos are submitted separately.