

Antenna

YE0038AA Datasheet

Antenna Services

Version: 3.0

Date: 2022-07-06

Status: Preliminary



At Quectel, our aim is to provide timely and comprehensive services to our customers. If you require any assistance, please contact our headquarters:

Quectel Wireless Solutions Co., Ltd.

Building 5, Shanghai Business Park Phase III (Area B), No.1016 Tianlin Road, Minhang District, Shanghai 200233, China

Tel: +86 21 5108 6236

Email: info@quectel.com

Or our local offices. For more information, please visit:

<http://www.quectel.com/support/sales.htm>.

For technical support, or to report documentation errors, please visit:

<http://www.quectel.com/support/technical.htm>.

Or email us at: support@quectel.com.

Legal Notices

We offer information as a service to you. The provided information is based on your requirements and we make every effort to ensure its quality. You agree that you are responsible for using independent analysis and evaluation in designing intended products, and we provide reference designs for illustrative purposes only. Before using any hardware, software or service guided by this document, please read this notice carefully. Even though we employ commercially reasonable efforts to provide the best possible experience, you hereby acknowledge and agree that this document and related services hereunder are provided to you on an “as available” basis. We may revise or restate this document from time to time at our sole discretion without any prior notice to you.

Use and Disclosure Restrictions

License Agreements

Documents and information provided by us shall be kept confidential, unless specific permission is granted. They shall not be accessed or used for any purpose except as expressly provided herein.

Copyright

Our and third-party products hereunder may contain copyrighted material. Such copyrighted material shall not be copied, reproduced, distributed, merged, published, translated, or modified without prior written consent. We and the third party have exclusive rights over copyrighted material. No license shall be granted or conveyed under any patents, copyrights, trademarks, or service mark rights. To avoid ambiguities, purchasing in any form cannot be deemed as granting a license other than the normal non-exclusive, royalty-free license to use the material. We reserve the right to take legal action for noncompliance with abovementioned requirements, unauthorized use, or other illegal or malicious use of the material.

Trademarks

Except as otherwise set forth herein, nothing in this document shall be construed as conferring any rights to use any trademark, trade name or name, abbreviation, or counterfeit product thereof owned by Quectel or any third party in advertising, publicity, or other aspects.

Third-Party Rights

This document may refer to hardware, software and/or documentation owned by one or more third parties (“third-party materials”). Use of such third-party materials shall be governed by all restrictions and obligations applicable thereto.

We make no warranty or representation, either express or implied, regarding the third-party materials, including but not limited to any implied or statutory, warranties of merchantability or fitness for a particular purpose, quiet enjoyment, system integration, information accuracy, and non-infringement of any third-party intellectual property rights with regard to the licensed technology or use thereof. Nothing herein constitutes a representation or warranty by us to either develop, enhance, modify, distribute, market, sell, offer for sale, or otherwise maintain production of any our products or any other hardware, software, device, tool, information, or product. We moreover disclaim any and all warranties arising from the course of dealing or usage of trade.

Privacy Policy

To implement module functionality, certain device data are uploaded to Quectel’s or third-party’s servers, including carriers, chipset suppliers or customer-designated servers. Quectel, strictly abiding by the relevant laws and regulations, shall retain, use, disclose or otherwise process relevant data for the purpose of performing the service only or as permitted by applicable laws. Before data interaction with third parties, please be informed of their privacy and data security policy.

Disclaimer

- a) We acknowledge no liability for any injury or damage arising from the reliance upon the information.
- b) We shall bear no liability resulting from any inaccuracies or omissions, or from the use of the information contained herein.
- c) While we have made every effort to ensure that the functions and features under development are free from errors, it is possible that they could contain errors, inaccuracies, and omissions. Unless otherwise provided by valid agreement, we make no warranties of any kind, either implied or express, and exclude all liability for any loss or damage suffered in connection with the use of features and functions under development, to the maximum extent permitted by law, regardless of whether such loss or damage may have been foreseeable.
- d) We are not responsible for the accessibility, safety, accuracy, availability, legality, or completeness of information, advertising, commercial offers, products, services, and materials on third-party websites and third-party resources.

Copyright © Quectel Wireless Solutions Co., Ltd. 2022. All rights reserved.

About the Document

Revision History

Version	Date	Author	Note
-	2020-11-24	Kenny YIN	Creation of the document
1.0	2020-11-24	Kenny YIN	First official release
1.1	2021-01-27	Kenny YIN	Added IP rating description.
2.0	2021-04-28	Aria CHU	Updated all test data in the datasheets.
2.1	2021-07-25	Aria CHU	Updated working temperature (Chapter 3).
2.2	2021-11-16	Aria CHU	Updated the information of product features (Chapter 3).
2.3	2021-11-30	Aria CHU	Updated the product description in Chapter 1.
2.4	2022-01-18	Kenny YIN	Updated the drawing (Chapter 5).
3.0	2022-07-05	Aria CHU	Updated all data in this datasheet

Contents

About the Document.....	3
Contents.....	4
1 Product Description.....	5
2 Product Features.....	5
3 Product Specifications.....	6
4 Overall Performance.....	7
4.1. Test Environment.....	7
4.2. Data-WIFI.....	8
4.3. Data-Band48.....	11
4.4. Radiation Pattern-WIFI.....	15
4.5. Radiation Pattern-Band48.....	20
5 Product Size.....	23

1 Product Description

The antenna is designed for superior performance, and can be widely used for wireless applications.

We provide comprehensive antenna design support such as simulation, testing and manufacturing for custom antenna solutions to meet your specific application needs.

2 Product Features

- Wi-Fi+Band48 (The Bluetooth band and WiFi band range are the same, so products that support Bluetooth can use this antenna.)
- High efficiency
- Excellent performance



3 Product Specifications

- **WIFI**

Passive Electrical Specifications

Frequency Range	2.4–2.5 GHz, 5.15–5.85 GHz
Input Impedence	50 Ω
VSWR	2.4GHz: ≤ 2.0, 5GHz: ≤ 2.8
Peak Gain	2.4GHz: ≤ 0.73dBi, 5GHz: ≤1.14dBi
Polarization Type	Linear

- **Band48**

Passive Electrical Specifications

Frequency Range	3400-3800MHz
Input Impedence	50 Ω
VSWR	≤ 6.0
Peak Gain	≤ -0.56 dBi
Polarization Type	Linear

Mechanical Specifications

Antenna Size	195 mm x Φ 13 mm
Casing	ABS
Connector Type	SMA Male (Center Pin)
Working Temperature	-40 °C to +85 °C
Radome Color	Black
IP Rating	IP55

4 Overall Performance

4.1. Test Environment

- KEYSIGHT ENA Network Analyzer E5063A 100 kHz – 8.5 GHz
- RayZone® 2800 Chamber 5G (FR1) SISO/MIMO, 600 MHz – 8.5 GHz



4.2. Data-WIFI

- VSWR

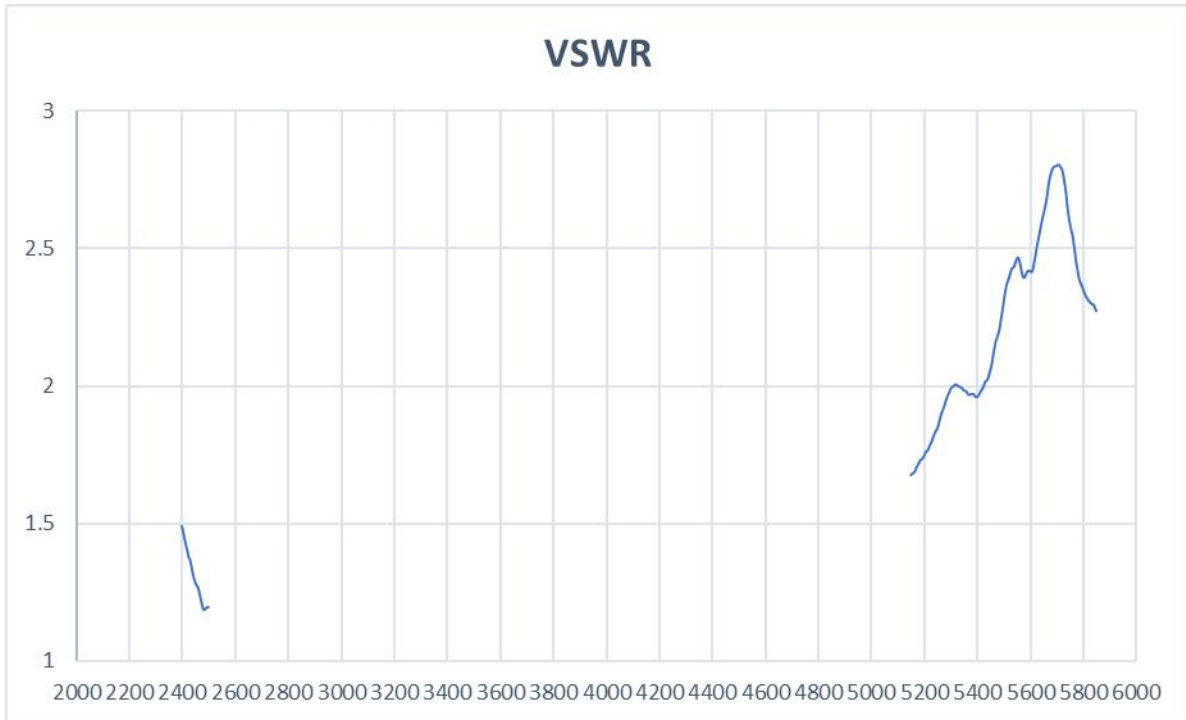

Frequency (MHz)	2400	2500	5150	5850
VSWR	1.49	1.19	1.67	2.27

● Efficiency

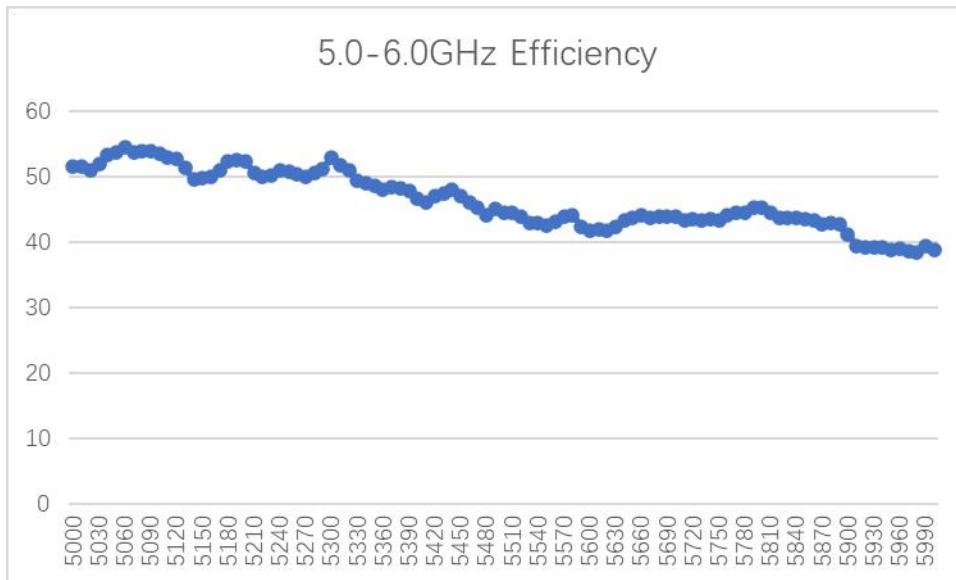
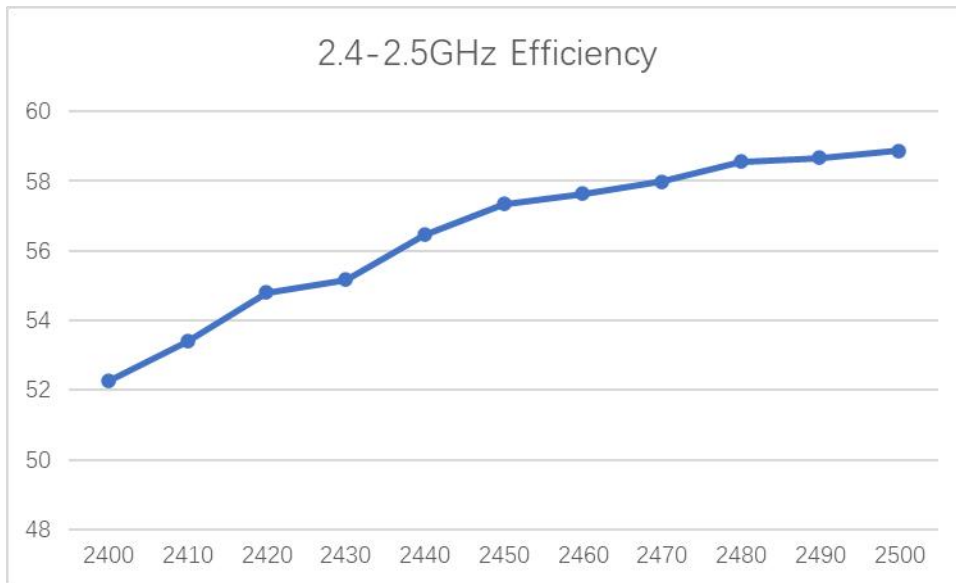

Frequency (MHz)	2400	2500	5150	5850
Efficiency (%)	52.26	59.64	49.76	43.45

● Gain

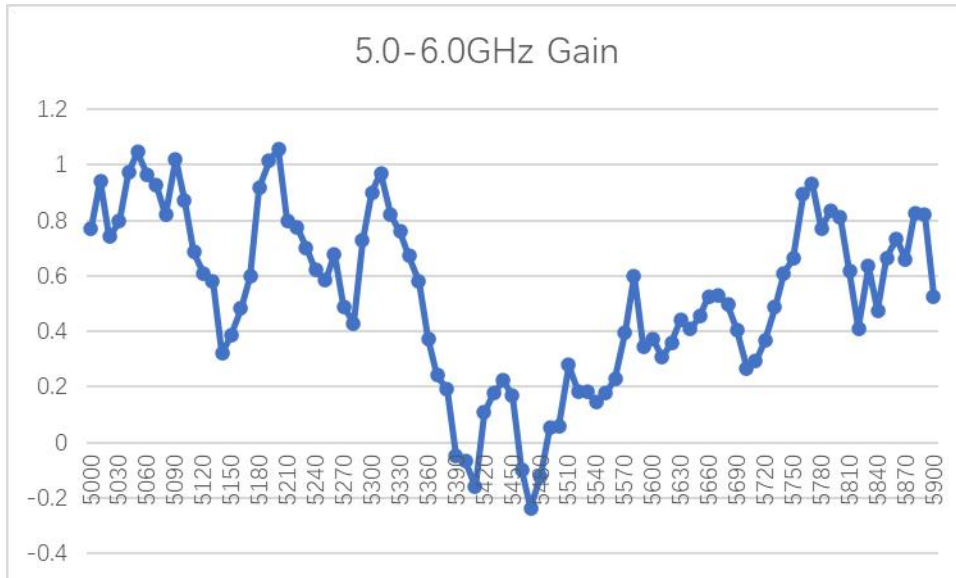
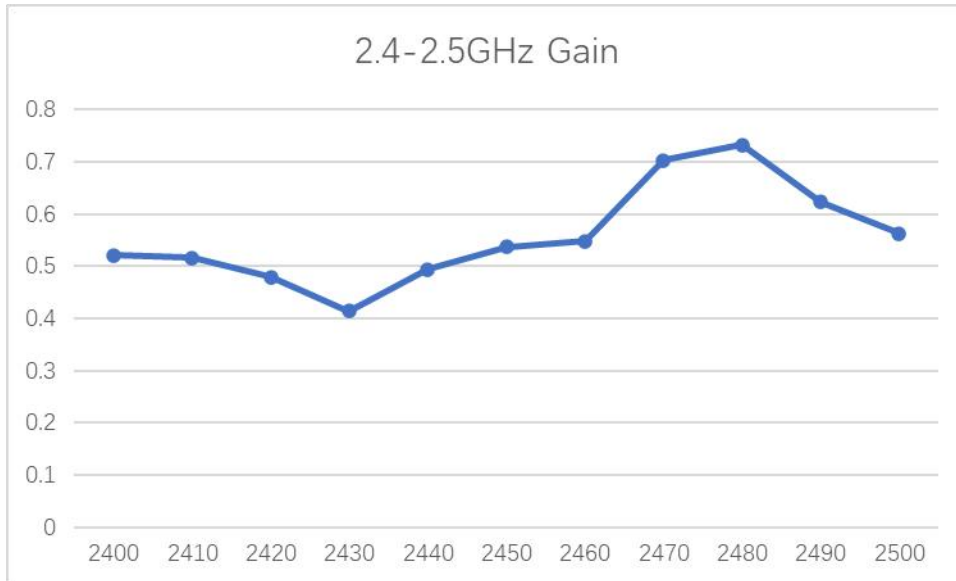

Frequency (MHz)	2400	2480	2500	5180	5300	5725	5750
Gain (dBi)	0.52	0.73	0.50	1.14	1.0	0.42	0.95.

4.3. Data-Band48

- Detailed Band48 data

Frequency(MHz)	Efficiency(%)	Gain(dBi)	VSWR
3400	31.31	-0.62	1.7595953
3410	30.54	-0.6	1.7594879
3420	30.27	-0.56	1.7583804
3430	29.99	-0.6	1.7557133
3440	29.58	-0.67	1.7407261
3450	29.52	-0.72	1.7120283
3460	29.22	-0.7	1.6657989
3470	28.71	-0.85	1.6026738
3480	28.37	-0.89	1.5193631
3490	28.14	-1.02	1.4232132
3500	27.8	-1.1	1.3214646
3510	27.73	-1.21	1.2190003
3520	26.99	-1.24	1.1431093
3530	26.8	-1.16	1.1454306
3540	26.01	-1.3	1.2251233
3550	25.45	-1.36	1.3391756
3560	24.91	-1.42	1.4751243
3570	24.52	-1.48	1.6197301
3580	24.18	-1.5	1.7623735
3590	23.06	-1.73	1.9009234
3600	22.27	-2.09	2.046213
3610	21.58	-2.25	2.1994422
3610	21.58	-2.25	2.1994422
3620	20.81	-2.44	2.3669588
3630	20.19	-2.46	2.5564068
3640	20.17	-2.44	2.7623186
3650	19.58	-2.61	3.0100725
3660	19.5	-2.46	3.283869
3670	19.34	-2.51	3.5730605
3680	18.15	-2.77	3.8926434
3690	18.59	-2.63	4.2036292
3700	18.34	-2.72	4.5103584
3710	17.64	-3	4.8055132
3720	17.31	-3	5.0332462
3730	16.93	-3.14	5.2320687
3740	16.36	-3.21	5.3770512
3750	16.24	-3.23	5.5003468
3760	16.63	-3.26	5.5554026
3770	15.87	-3.42	5.608513
3780	15.96	-3.26	5.6901719
3790	16.14	-3.16	5.6804135
3800	16.84	-3.08	5.6561165

● **VSWR**

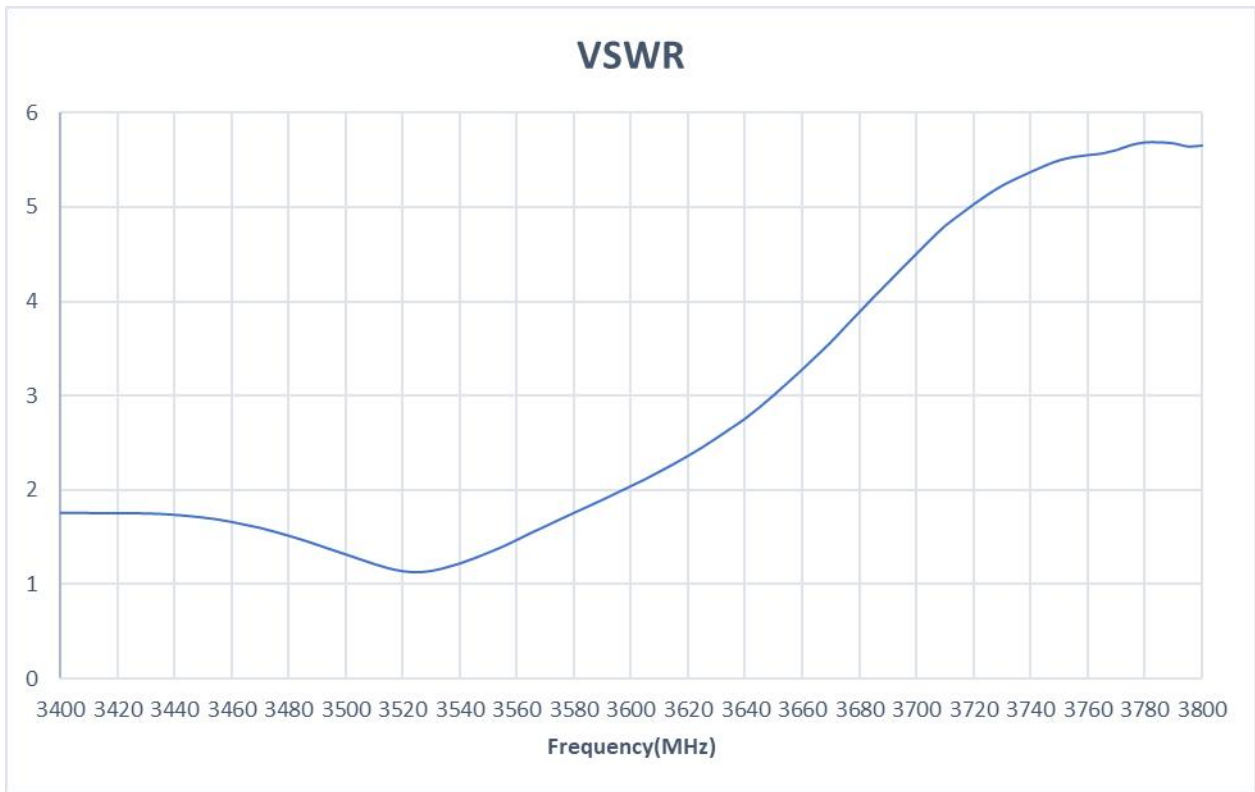

Frequency (MHz)	3400	3600	3800
VSWR	1.75	2.04	5.65

● Efficiency

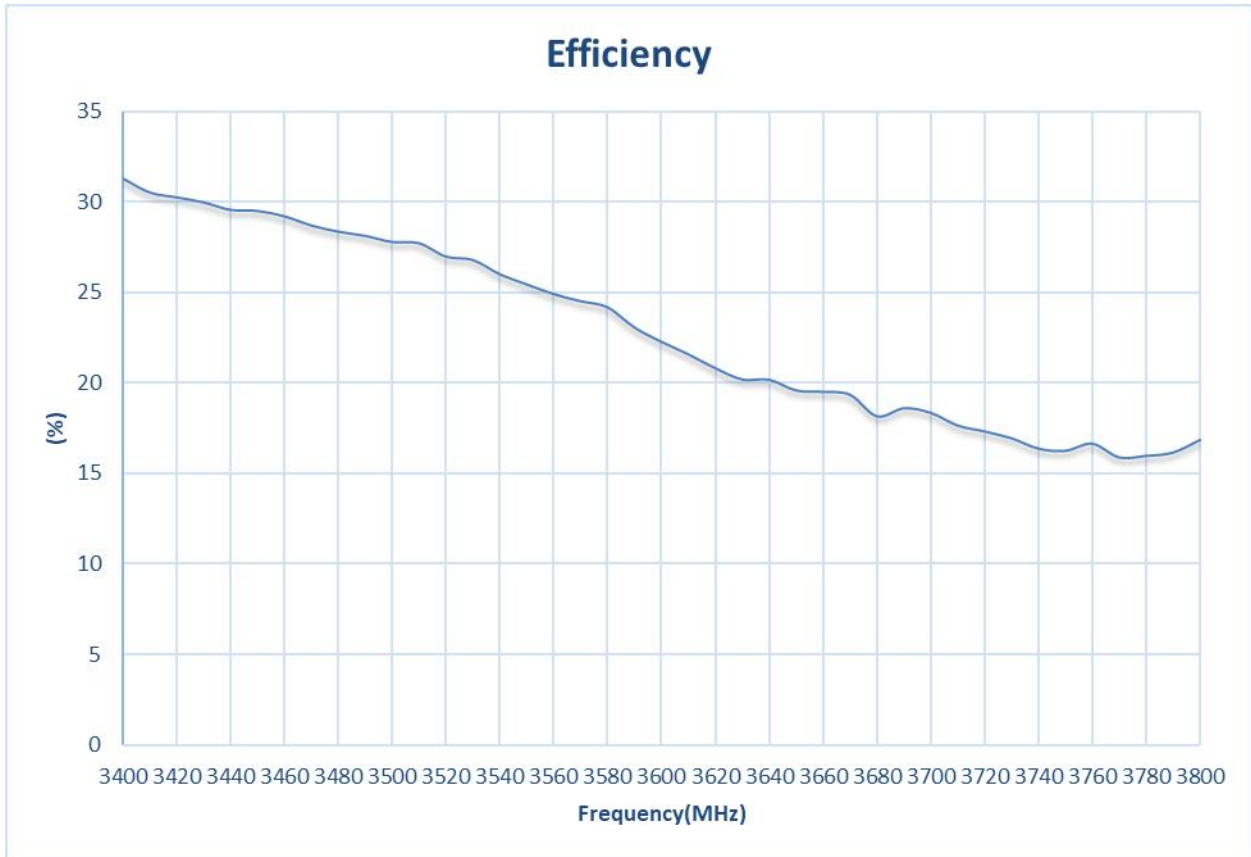

Frequency (MHz)	3400	3600	3800
Efficiency (%)	31.31	22.27	16.84

● Gain

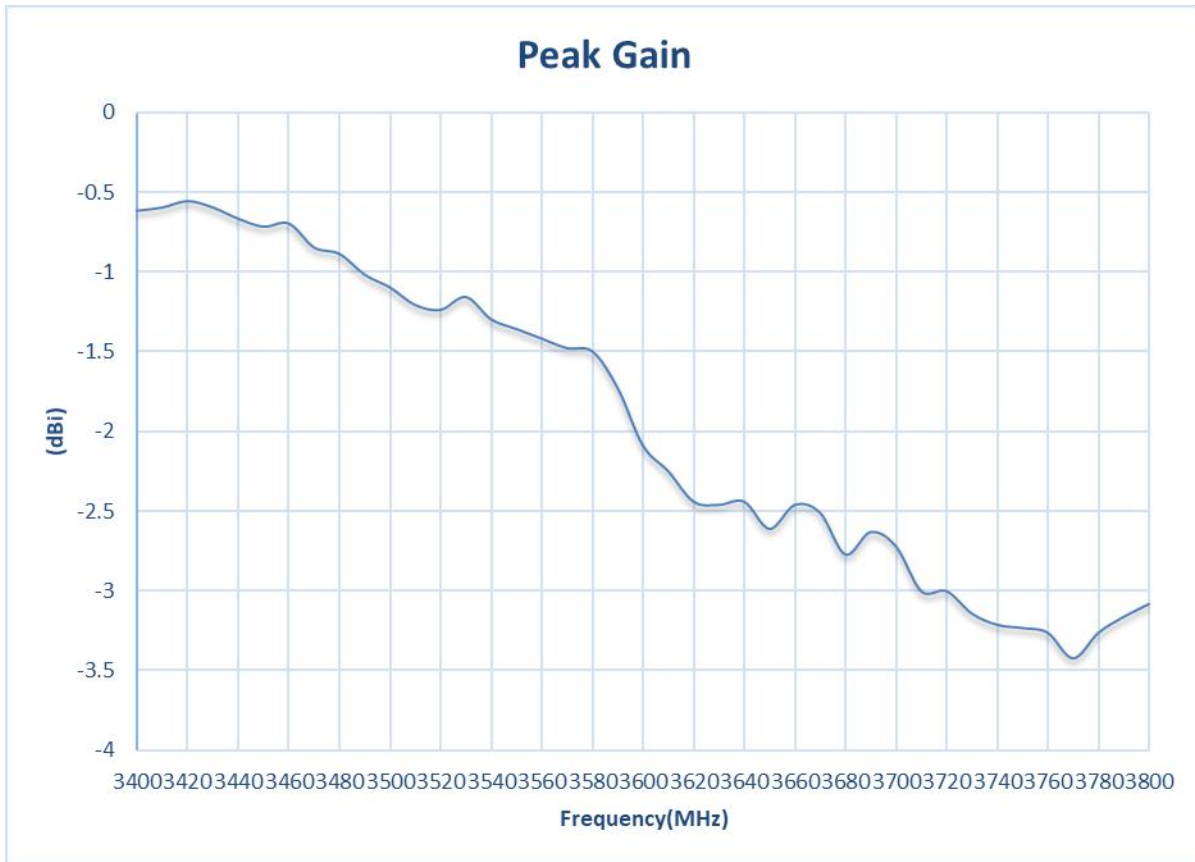

Frequency (MHz)	3400	3600	3800
Gain (dBi)	-0.62	-2.09	-3.08

4.4. Radiation Pattern-WIFI

2400 MHz

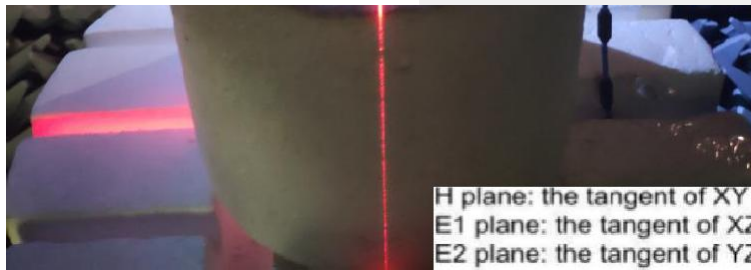
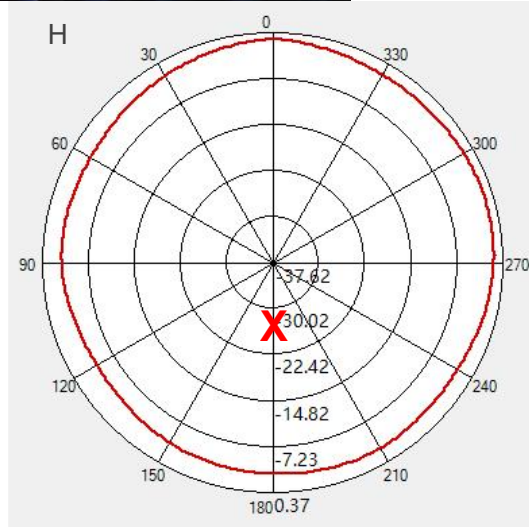
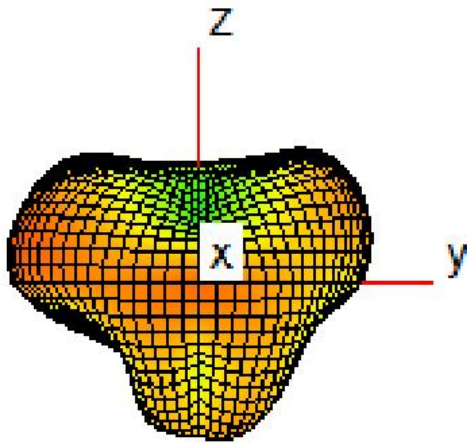
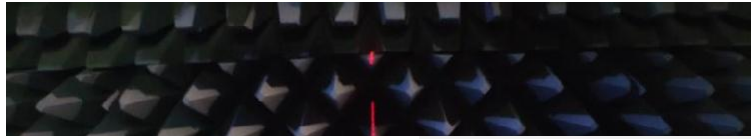

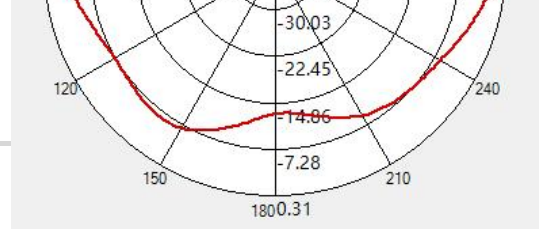
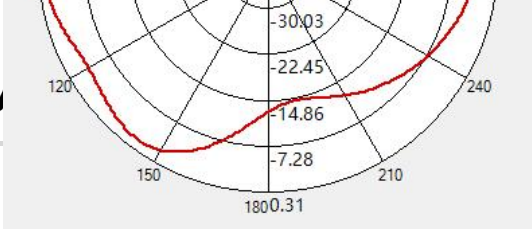

2500 MHz

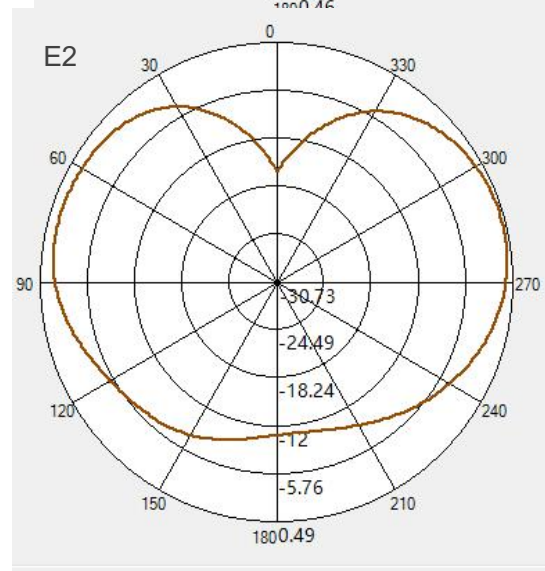
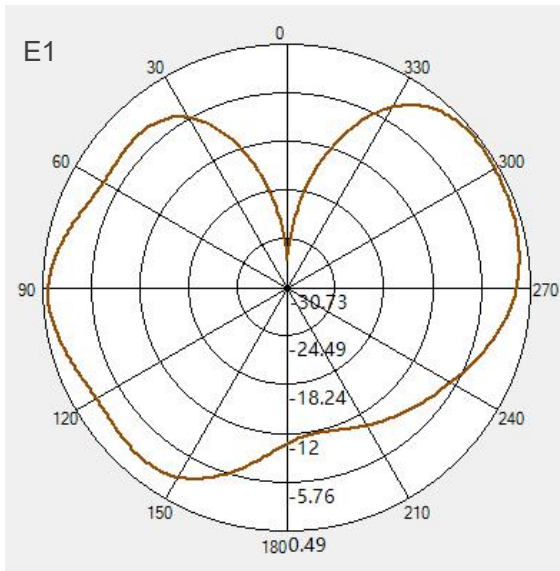
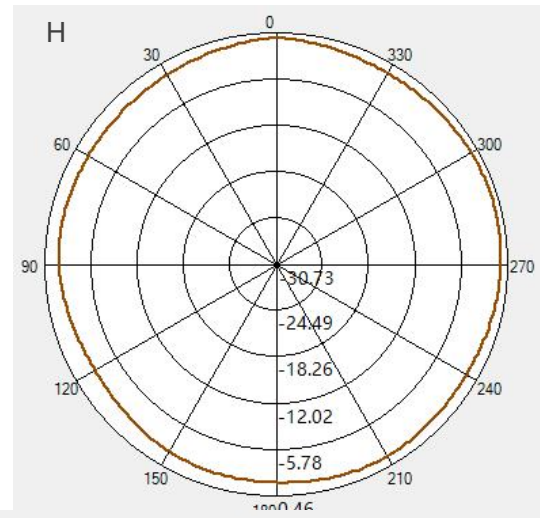
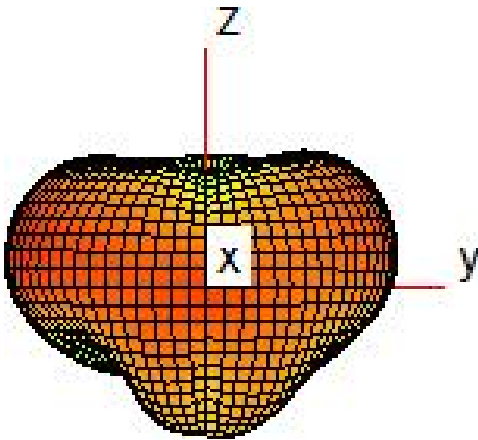

5180 MHz

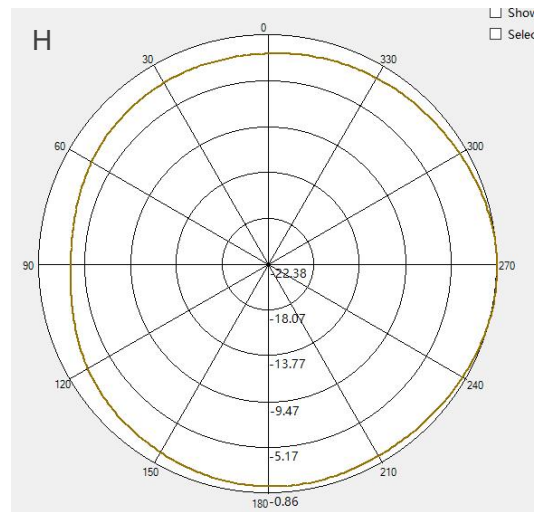
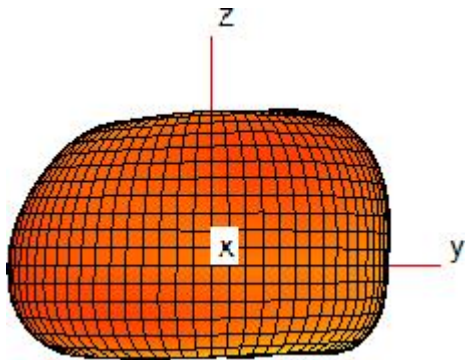

5300 MHz

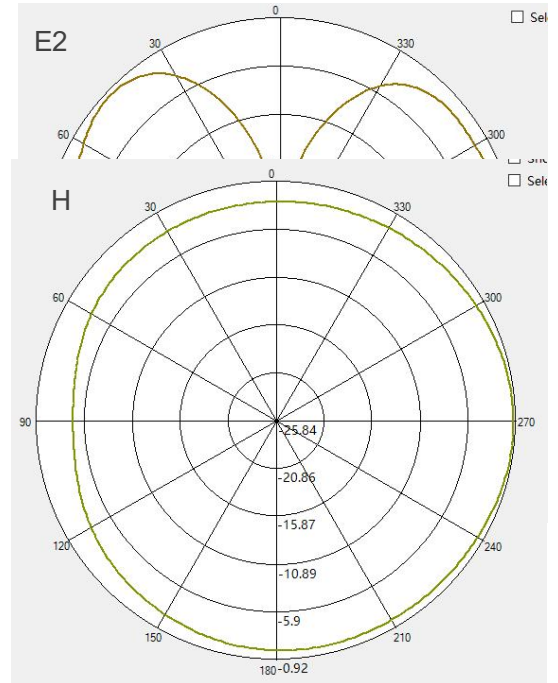
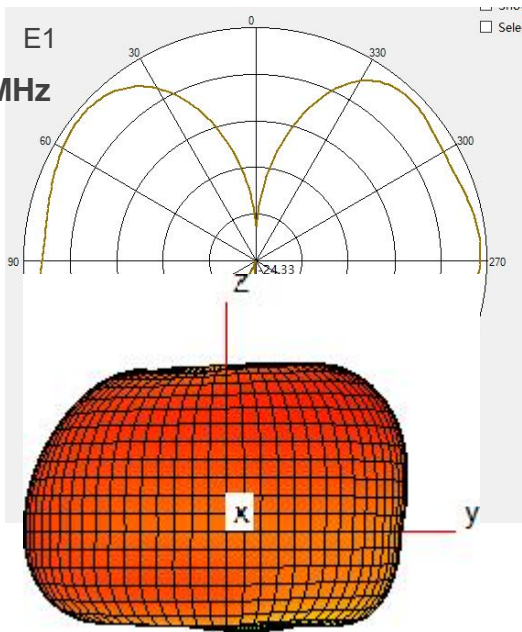

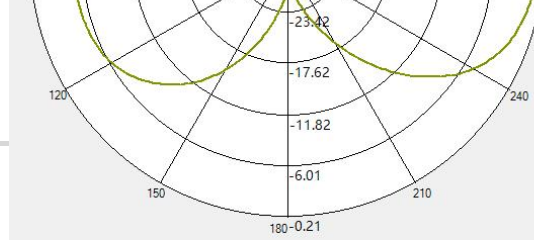
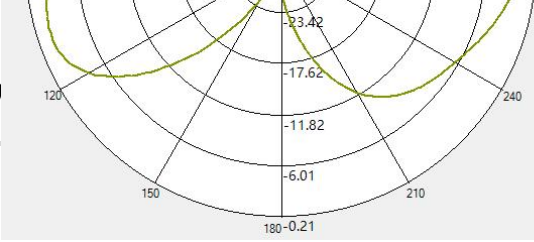

5725 MHz

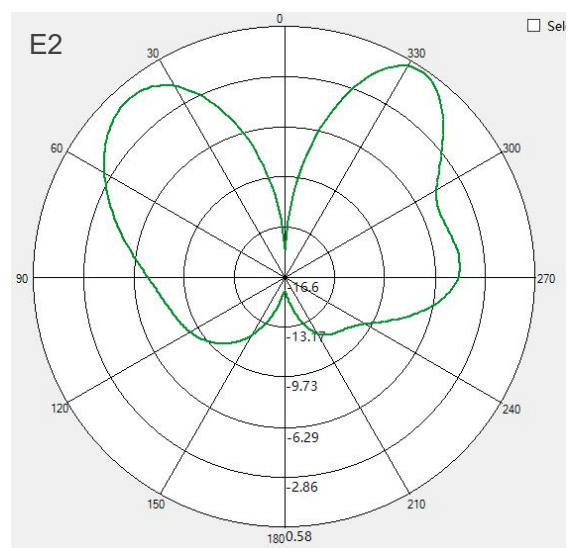
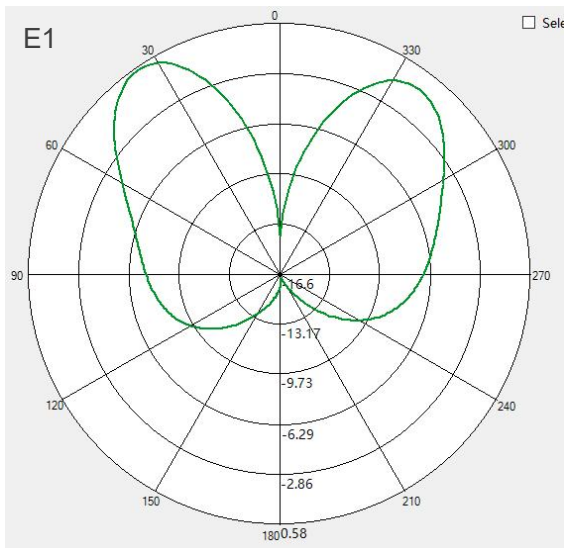
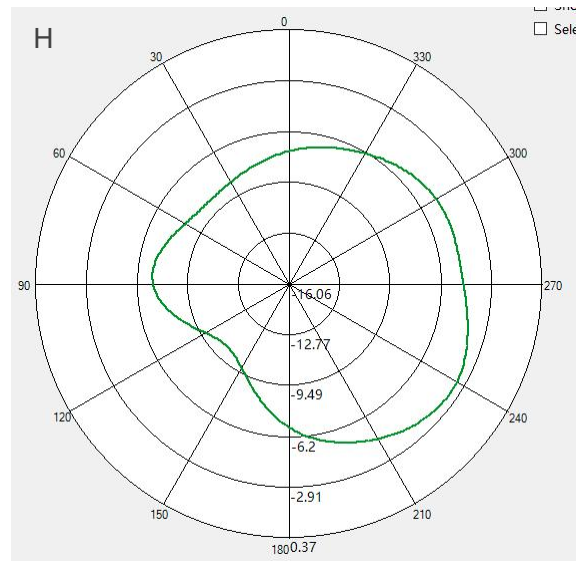
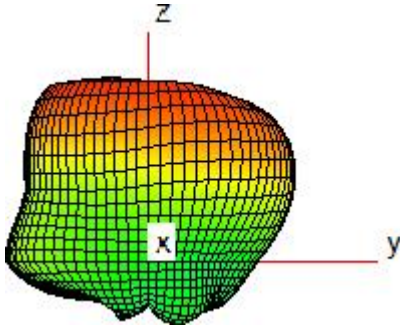

5750 MHz

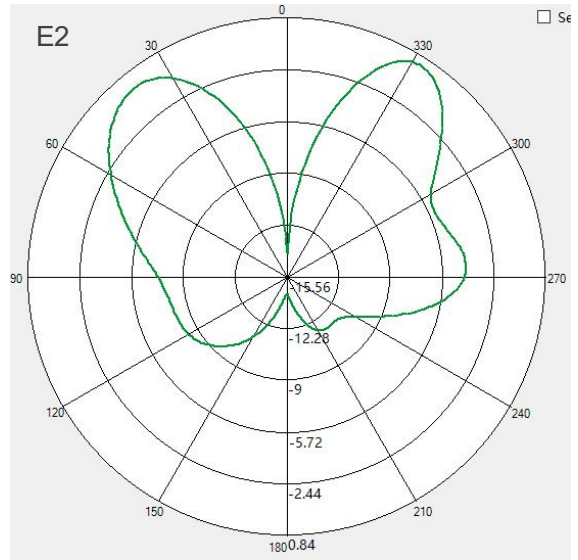
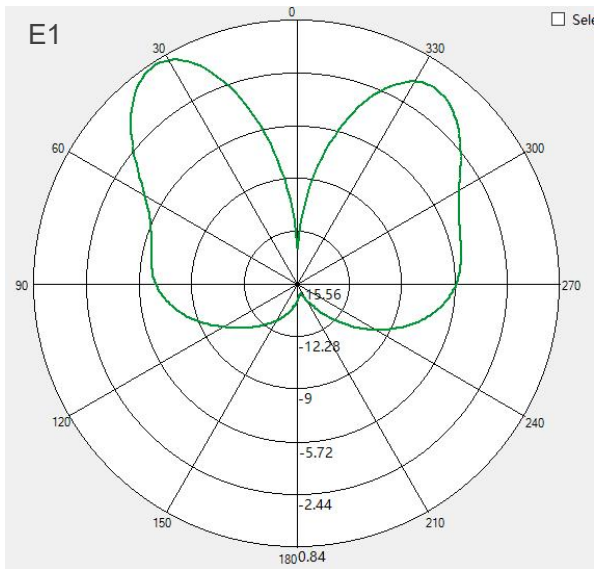
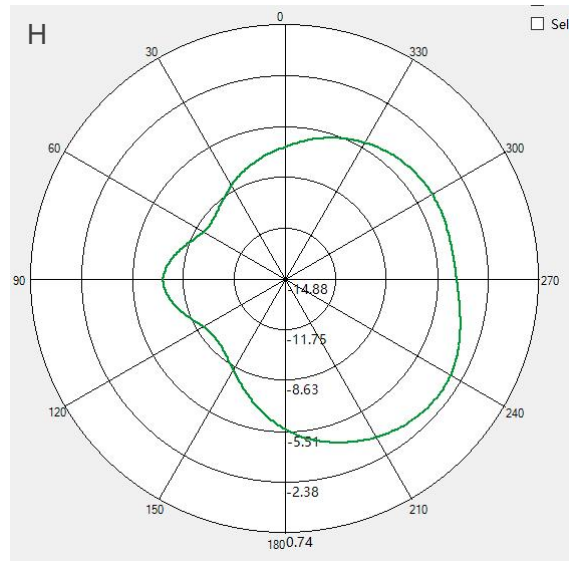
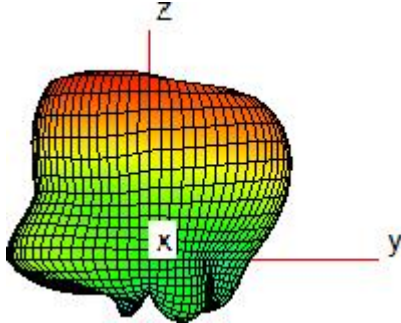

4.5. Radiation Pattern-Band48

3400MHz

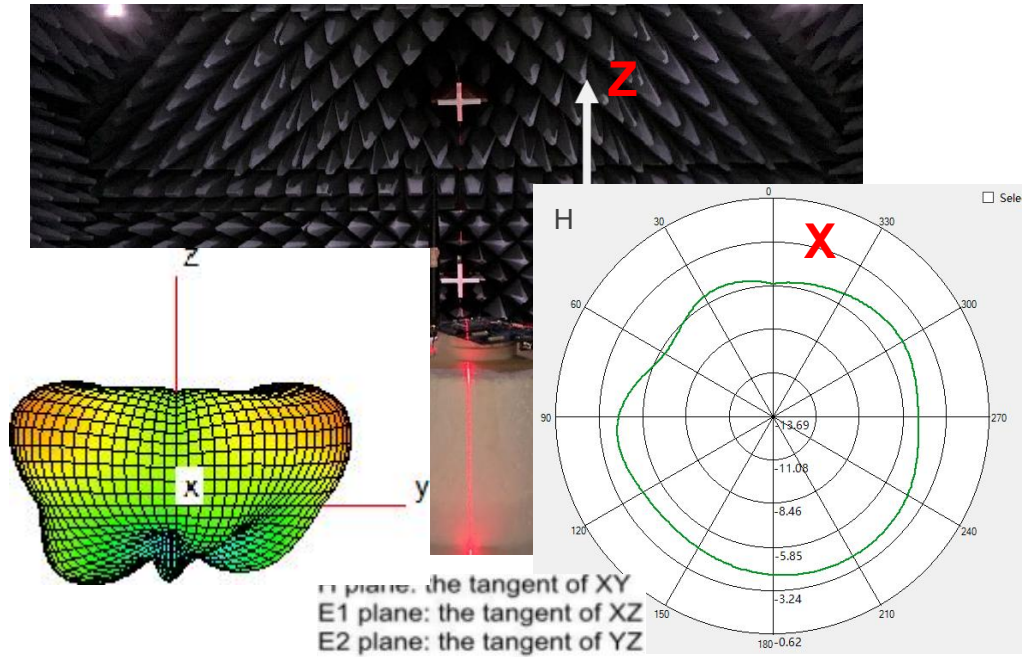

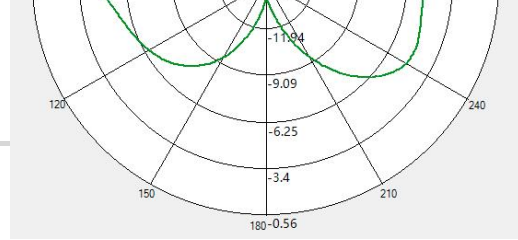
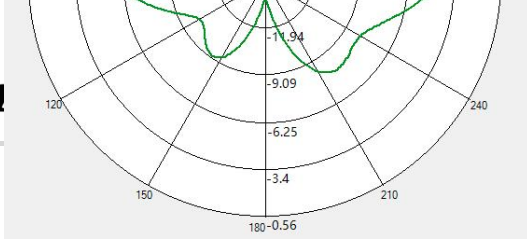

3600MHz

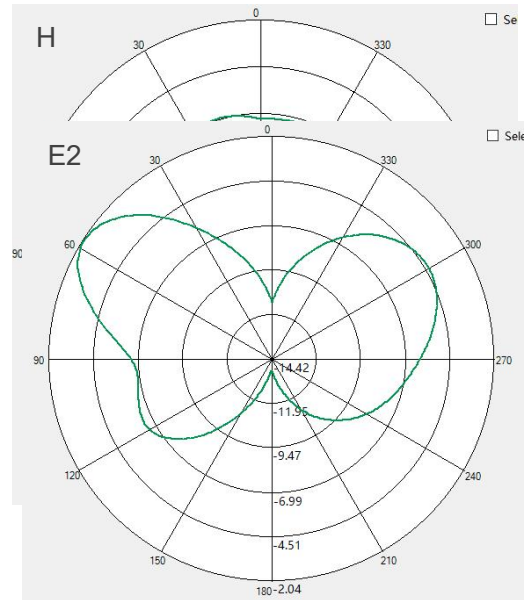
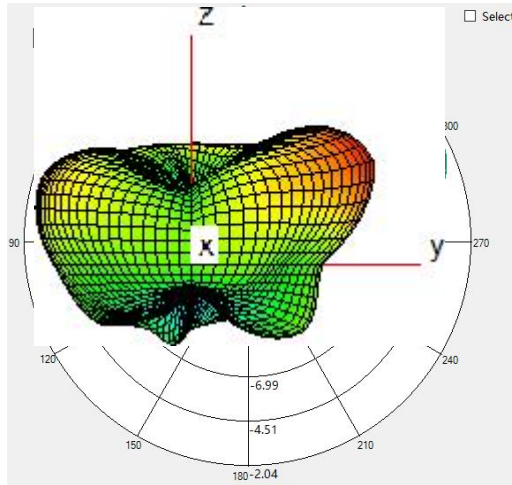

3800MHz

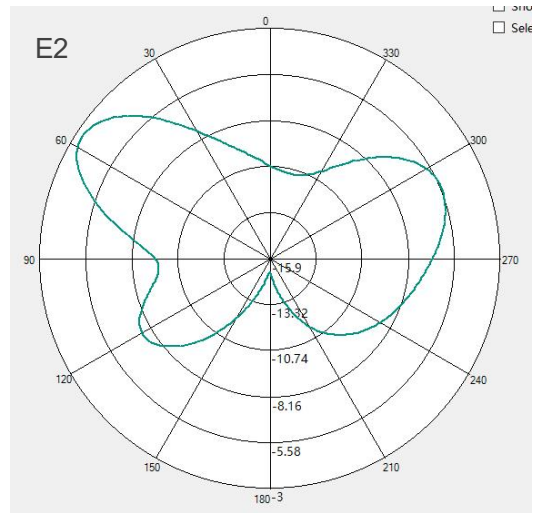
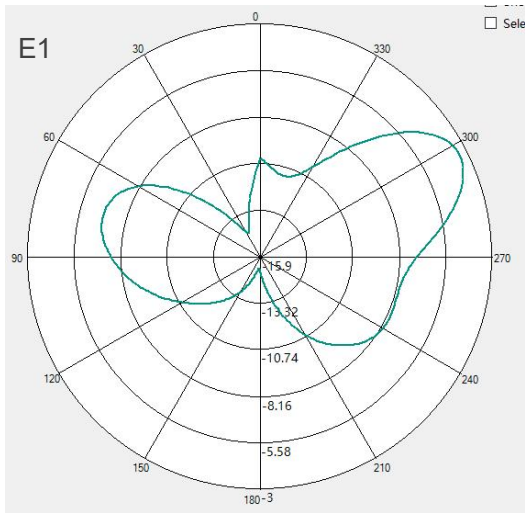
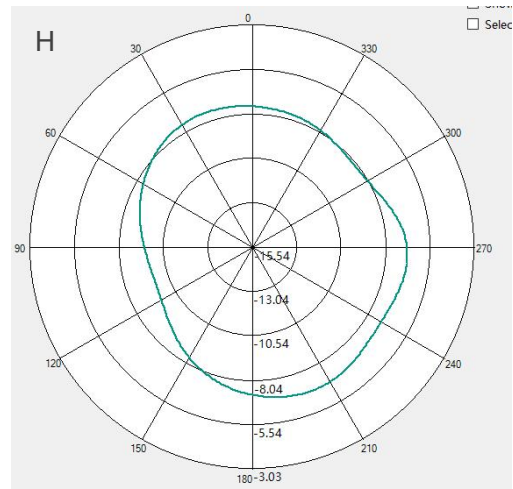
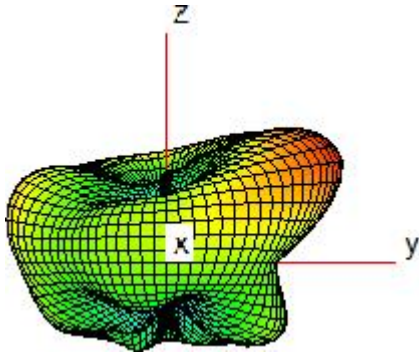

5 Product Size

