

Report No.: XEWA2310000070RG05  
 Rev.: 01  
 Page: 1 of 267

# TEST REPORT

**Application No.:** XEWA2310000070RG  
**Applicant:** Quectel Wireless Solutions Co., Ltd.  
**Address of Applicant:** Building 5, Shanghai Business Park Phase III (Area B), No.1016 Tianlin Road, Minhang District, Shanghai, China 200233  
**Manufacturer:** Quectel Wireless Solutions Co., Ltd.  
**Address of Manufacturer:** Building 5, Shanghai Business Park Phase III (Area B), No.1016 Tianlin Road, Minhang District, Shanghai, China 200233  
**EUT Description:** Wi-Fi & Bluetooth Module  
**Model No.:** AF66T  
**Trade Mark:** Quectel  
**FCC ID:** XMR202309AF66T  
**Standards:** FCC 47 CFR Part 2, Subpart J  
 FCC 47 CFR Part 15, Subpart E  
**Date of Receipt:** 2023/09/26  
**Date of Test:** 2023/10/11 to 2023/10/23  
**Date of Issue:** 2023/11/13

<b>Test Result :</b>	<b>PASS *</b>
----------------------	---------------

\* In the configuration tested, the EUT detailed in this report complied with the standards specified above.

Authorized Signature:



Peter Tan  
 Regulatory Technical Manager



Unless otherwise agreed in writing, this document is issued by the Company subject to its General Conditions of Service printed overleaf, available on request or accessible at <http://www.sgs.com/en/Terms-and-Conditions.aspx> and, for electronic format documents, subject to Terms and Conditions for Electronic Documents at <http://www.sgs.com/en/Terms-and-Conditions/Terms-e-Document.aspx>. Attention is drawn to the limitation of liability, indemnification and jurisdiction issues defined therein. Any holder of this document is advised that information contained herein reflects the Company's findings at the time of its intervention only and within the limits of Client's instructions, if any. The Company's sole responsibility is to its Client and this document does not exonerate parties to a transaction from exercising all their rights and obligations under the transaction documents. This document cannot be reproduced except in full, without prior written approval of the Company. Any unauthorized alteration, forgery or falsification of the content or appearance of this document is unlawful and offenders may be prosecuted to the fullest extent of the law. Unless otherwise stated the results shown in this test report refer only to the sample(s) tested and such sample(s) are retained for 30 days only.  
 Attention: To check the authenticity of testing/inspection report & certificate, please contact us at telephone: (86-755) 8307 1443, or email: [CN.Doccheck@sgs.com](mailto:CN.Doccheck@sgs.com)

SGS-CSTC Standards Technical Services (Xi'an) Co., Ltd.  
 (Weiss Technik)

1/E Unit D, Building 1, Kanghong Orange Science Park, No.137, Kejun3rd Road, Fengfeng New Town, Xi'an, Shaanxi, China 710086  
 中国·西安·沣东新城科园三路137号康鸿橙方科技园1号楼D单元1层 邮编: 710086

t (86-29) 6282 7885 www.sgs.com.cn  
 t (86-29) 6282 7885 sgs.china@sgs.com

# 1 Version

Revision Record				
Version	Chapter	Date	Modifier	Remark
01		2023/11/13		Original

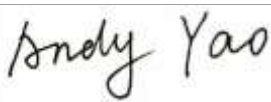
<b>Prepared By</b>	 <hr/> (Leah Chen) / Test Engineer
<b>Checked By</b>	 <hr/> (Andy Yao) / Reviewer



Unless otherwise agreed in writing, this document is issued by the Company subject to its General Conditions of Service printed overleaf, available on request or accessible at <http://www.sgs.com/en/Terms-and-Conditions.aspx> and, for electronic format documents, subject to Terms and Conditions for Electronic Documents at <http://www.sgs.com/en/Terms-and-Conditions/Terms-e-Documents.aspx>. Attention is drawn to the limitation of liability, indemnification and jurisdiction issues defined therein. Any holder of this document is advised that information contained herein reflects the Company's findings at the time of its intervention only and within the limits of Client's instructions, if any. The Company's sole responsibility is to its Client and this document does not exonerate parties to a transaction from exercising all their rights and obligations under the transaction documents. This document cannot be reproduced except in full, without prior written approval of the Company. Any unauthorized alteration, forgery or falsification of the content or appearance of this document is unlawful and offenders may be prosecuted to the fullest extent of the law. Unless otherwise stated the results shown in this test report refer only to the sample(s) tested and such sample(s) are retained for 30 days only.

Attention: To check the authenticity of testing/inspection report & certificate, please contact us at telephone: (86-755) 8307 1443, or email: [CN.Doccheck@sgs.com](mailto:CN.Doccheck@sgs.com)

## 2 Test Summary

Test Item	Band <sup>[1]</sup>	FCC rules No.	Test Requirements	Test Result	Result																						
Dynamic Frequency Selection	Band II-A Band II-C	15.407	<p><b>DFS Detection Thresholds:</b></p> <table border="1"> <thead> <tr> <th>Maximum Transmit Power</th> <th>Value</th> </tr> </thead> <tbody> <tr> <td>ERP &gt; 200 mW/eVPM</td> <td>-64 dBm</td> </tr> <tr> <td>ERP &lt; 200 mW/eVPM and power spectral density &lt; 10 dBm/MHz</td> <td>-67 dBm</td> </tr> <tr> <td>ERP &lt; 200 mW/eVPM that do not meet the power spectral density requirement</td> <td>-64 dBm</td> </tr> </tbody> </table> <p>Note 1: This is the level at the input of the receiver assuming a 0 dB receive antenna.                      Note 2: Throughout these test procedures an additional 1 dB has been added to the magnitude of the test transmission waveforms to account for variations in measurement equipment. This will ensure that the test signal is at or above the detection threshold level to trigger a DFS response.                      Note 3: ERP is based on the highest antenna gain. For MDSO devices refer to KDB Publication 682911 D01.</p> <p><b>DFS Response Requirement:</b></p> <table border="1"> <thead> <tr> <th>Parameter</th> <th>Value</th> </tr> </thead> <tbody> <tr> <td>Non-occupancy period</td> <td>Minimum 10 minutes</td> </tr> <tr> <td>Channel availability (Squelch Time)</td> <td>60 seconds</td> </tr> <tr> <td>Channel Move Time</td> <td>10 seconds</td> </tr> <tr> <td>Channel Closing Transmission Time</td> <td>See Note 1.</td> </tr> <tr> <td>UNSI Detection Bandwidth</td> <td>200 microseconds + an aggregate of 60 microseconds over remaining 10 second period. See Notes 1 and 2.</td> </tr> <tr> <td></td> <td>Minimum 100% of the U.S. MIL-99% transmission power bandwidth. See Note 1.</td> </tr> </tbody> </table> <p>Note 1: Channel Move Time and the Channel Closing Transmission Time should be performed with Radar Type 0. The measurement timing begins at the end of the Radar Type 0 burst.                      Note 2: The Channel Closing Transmission Time is composed of 200 microseconds starting at the beginning of the Channel Move Time plus any additional measurement control signals required to facilitate a Channel move (an aggregate of 60 microseconds) during the remainder of the 10 second period. The aggregate duration of control signals will not count against periods in between transmissions.                      Note 3: During the UNSI Detection Bandwidth's detection test, radar type D should be used. For each frequency step the minimum percentage of detection is 90 percent. Measurements are performed with no data traffic.</p>	Maximum Transmit Power	Value	ERP > 200 mW/eVPM	-64 dBm	ERP < 200 mW/eVPM and power spectral density < 10 dBm/MHz	-67 dBm	ERP < 200 mW/eVPM that do not meet the power spectral density requirement	-64 dBm	Parameter	Value	Non-occupancy period	Minimum 10 minutes	Channel availability (Squelch Time)	60 seconds	Channel Move Time	10 seconds	Channel Closing Transmission Time	See Note 1.	UNSI Detection Bandwidth	200 microseconds + an aggregate of 60 microseconds over remaining 10 second period. See Notes 1 and 2.		Minimum 100% of the U.S. MIL-99% transmission power bandwidth. See Note 1.	Clause 4.1	PASS
Maximum Transmit Power	Value																										
ERP > 200 mW/eVPM	-64 dBm																										
ERP < 200 mW/eVPM and power spectral density < 10 dBm/MHz	-67 dBm																										
ERP < 200 mW/eVPM that do not meet the power spectral density requirement	-64 dBm																										
Parameter	Value																										
Non-occupancy period	Minimum 10 minutes																										
Channel availability (Squelch Time)	60 seconds																										
Channel Move Time	10 seconds																										
Channel Closing Transmission Time	See Note 1.																										
UNSI Detection Bandwidth	200 microseconds + an aggregate of 60 microseconds over remaining 10 second period. See Notes 1 and 2.																										
	Minimum 100% of the U.S. MIL-99% transmission power bandwidth. See Note 1.																										
<p>Note 1:                      Band II-A: 5250-5350MHz                      Band II-C: 5470-5725MHz                      Remark: Only worst-case data is recorded in the test report</p>																											



## Contents

1	Version .....	2
2	Test Summary .....	3
3	General Information .....	5
3.1	Details of Client.....	5
3.2	Test Location .....	5
3.3	Test Facility .....	5
3.4	General Description of EUT .....	6
3.5	Test Environment and Mode .....	9
3.6	Description of Support Units .....	9
3.7	Worst-case configuration and mode.....	9
4	Test results and Measurement Data.....	10
4.1	Dynamic Frequency Selection .....	10
4.1.1	DFS Measurement Configuration .....	10
4.1.2	DFS Threshold level .....	10
4.1.3	Power-on cycle .....	10
4.1.4	User Access Restrctions.....	10
4.1.5	Channel Loading/Data Streaming.....	10
4.1.6	Conducted Setup of Calibration of DFS Detection Threshold Level .....	11
4.1.7	Test Setup .....	11
4.1.8	Test Procedures .....	12
4.1.9	Applicability of DFS Requirements Prior to Use of a Channel .....	20
4.1.10	Applicability of DFS Requirements During Normal Operation.....	20
4.1.11	DFS Detection Thresholds.....	21
4.1.12	Response Requirements .....	21
4.1.13	Short Pulse Radar Test Waveforms .....	22
4.1.14	Long Pulse Radar Test Waveform.....	24
4.1.15	Frequency Hopping Radar Test Waveform .....	24
5	Measurement Uncertainty (95% confidence levels, k=2).....	25
6	Equipment List.....	26
7	Photographs - Setup Photos.....	27



Unless otherwise agreed in writing, this document is issued by the Company subject to its General Conditions of Service printed overleaf, available on request or accessible at <http://www.sgs.com/en/Terms-and-Conditions.aspx> and, for electronic format documents, subject to Terms and Conditions for Electronic Documents at <http://www.sgs.com/en/Terms-and-Conditions/Terms-e-Documents.aspx>. Attention is drawn to the limitation of liability, indemnification and jurisdiction issues defined therein. Any holder of this document is advised that information contained herein reflects the Company's findings at the time of its intervention only and within the limits of Client's instructions, if any. The Company's sole responsibility is to its Client and this document does not exonerate parties to a transaction from exercising all their rights and obligations under the transaction documents. This document cannot be reproduced except in full, without prior written approval of the Company. Any unauthorized alteration, forgery or falsification of the content or appearance of this document is unlawful and offenders may be prosecuted to the fullest extent of the law. Unless otherwise stated the results shown in this test report refer only to the sample(s) tested and such sample(s) are retained for 30 days only.

Attention: To check the authenticity of testing/inspection report & certificate, please contact us at telephone: (86-755) 4307 1443, or email: [CN.Doccheck@sgs.com](mailto:CN.Doccheck@sgs.com)

SGS-CSTC Standards Technical Services (Xi'an) Co., Ltd. | 1/E Unit D Building 1, Kanghong Orange Science Park, No.137, Keyuan 3rd Road, Fengcheng New Town, Xi'an, Shaanxi, China | 710086 | t (86-29) 6282 7885 | www.sgs.com.cn  
 中国·西安·沣东新城科里三路137号康鸿橙方科技园1号楼D单元1层 | 邮编: 710086 | t (86-29) 6282 7885 | sgs.china@sgs.com

Report No.: XEWA2310000070RG05  
 Rev.: 01  
 Page: 5 of 267

### 3 General Information

#### 3.1 Details of Client

Applicant:	Quectel Wireless Solutions Co., Ltd.
Address of Applicant:	Building 5, Shanghai Business Park Phase III (Area B), No.1016 Tianlin Road, Minhang District, Shanghai, China 200233
Manufacturer:	Quectel Wireless Solutions Co., Ltd.
Address of Manufacturer:	Building 5, Shanghai Business Park Phase III (Area B), No.1016 Tianlin Road, Minhang District, Shanghai, China 200233

#### 3.2 Test Location

Company:	SGS-CSTC Standards Technical Services (Xi'an) Co., Ltd.
Address:	1/F, Unit D, Building 1, Kanghong Orange Science Park, No.137, Keyuan 3rd Road, Fengdong New Town, Xi'an, Shaanxi China
Post code:	710086
Test engineer:	Qiang Zhang

#### 3.3 Test Facility

The test facility is recognized, certified, or accredited by the following organizations:

<ul style="list-style-type: none"> <li>• <b>A2LA (Certificate No. 4854.01)</b>            SGS-CSTC Standards Technical Services (Xi'an) Co., Ltd. is accredited by the American Association for Laboratory Accreditation(A2LA). Certificate No. 4854.01.</li> <li>• <b>Innovation, Science and Economic Development Canada</b>            SGS-CSTC Standards Technical Services (Xi'an) Co., Ltd. has been recognized by ISED as an accredited testing laboratory.            CAB identifier: CN0095.            IC#: 25613.</li> <li>• <b>FCC –Designation Number: CN1337</b>            SGS-CSTC Standards Technical Services (Xi'an) Co., Ltd. has been recognized as an accredited testing laboratory.            Designation Number: CN1337.            Test Firm Registration Number: 917410</li> </ul>
---



Unless otherwise agreed in writing, this document is issued by the Company subject to its General Conditions of Service printed overleaf, available on request or accessible at <http://www.sgs.com/en/Terms-and-Conditions.aspx> and, for electronic format documents, subject to Terms and Conditions for Electronic Documents at <http://www.sgs.com/en/Terms-and-Conditions/Terms-e-Documents.aspx>. Attention is drawn to the limitation of liability, indemnification and jurisdiction issues defined therein. Any holder of this document is advised that information contained herein reflects the Company's findings at the time of its intervention only and within the limits of Client's instructions, if any. The Company's sole responsibility is to its Client and this document does not exonerate parties to a transaction from exercising all their rights and obligations under the transaction documents. This document cannot be reproduced except in full, without prior written approval of the Company. Any unauthorized alteration, forgery or falsification of the content or appearance of this document is unlawful and offenders may be prosecuted to the fullest extent of the law. Unless otherwise stated the results shown in this test report refer only to the sample(s) tested and such sample(s) are retained for 30 days only.  
 Attention: To check the authenticity of testing/inspection report & certificate, please contact us at telephone: (86-755) 8307 1443, or email: [CN.Doccheck@sgs.com](mailto:CN.Doccheck@sgs.com)

1/F, Unit D, Building 1, Kanghong Orange Science Park, No.137, Keyuan 3rd Road, Fengdong New Town, Xi'an, Shaanxi, China 710086 t (86-29) 6282 7885 www.sgs.com.cn  
 中国·西安·沣东新城科里三路137号康鸿橙方科技园1号楼D单元1层 邮编: 710086 t (86-29) 6282 7885 sgs.china@sgs.com

### 3.4 General Description of EUT

EUT Description:	Wi-Fi & Bluetooth Module	
Model No.:	AF66T	
Trade Mark:	Quectel	
Hardware Version:	R1.0	
Software Version:	NA	
Power Supply:	DC 12V	
SN:	D1C23G416000834	
WLAN Mode Supported:	802.11a:	20 MHz channel bandwidth
	802.11n:	20 MHz / 40 MHz channel bandwidth
	802.11ac:	20 MHz / 40 MHz / 80 MHz MHz channel bandwidth
	802.11ax:	20 MHz / 40 MHz / 80 MHz MHz channel bandwidth
Operation Frequency:	5250MHz to 5350MHz	
	5470MHz to 5725MHz	
Modulation Type:	802.11a:	OFDM (BPSK, QPSK, 16QAM, 64QAM)
	802.11n:	OFDM (BPSK, QPSK, 16QAM, 64QAM)
	802.11ac:	OFDM (BPSK, QPSK, 16QAM, 64QAM, 256QAM)
	802.11ax:	OFDM/OFDMA (BPSK, QPSK, 16QAM, 64QAM, 256QAM, 1024QAM)
Channel Spacing:	20MHz:	802.11a/n(HT20)/ac(VHT20)/ax(HE20)
	40MHz:	802.11n(HT40)/ac(VHT40)/ax(HE40)
	80MHz:	802.11ac(VHT80)/ax(HE80)
Antenna Type:	Dipole Antenna	
Antenna Gain:	5250MHz to 5350MHz: 1.00dBi(Ant0); 1.00dBi(Ant1);	
	5470MHz to 5725MHz: 0.60dBi(Ant0); 0.60dBi(Ant1);	
Smart System:	Note: The antenna gain are derived from the gain information report provided by the manufacturer.	
	<input checked="" type="checkbox"/> SISO	802.11a/n/ac/ax
	<input checked="" type="checkbox"/> MIMO	802.11n/ac/ax: 2Tx & 2Rx
DFS Function:	<input checked="" type="checkbox"/> Diversity	CDD:802.11a: 2Tx & 2Rx
	<input checked="" type="checkbox"/> Master	
TPC Function:	<input type="checkbox"/> Slave with radar detection	<input type="checkbox"/> Slave without radar detection
	<input checked="" type="checkbox"/> Support, <input type="checkbox"/> Not Support	



Unless otherwise agreed in writing, this document is issued by the Company subject to its General Conditions of Service printed overleaf, available on request or accessible at <http://www.sgs.com/en/Terms-and-Conditions.aspx> and, for electronic format documents, subject to Terms and Conditions for Electronic Documents at <http://www.sgs.com/en/Terms-and-Conditions/Terms-e-Document.aspx>. Attention is drawn to the limitation of liability, indemnification and jurisdiction issues defined therein. Any holder of this document is advised that information contained herein reflects the Company's findings at the time of its intervention only and within the limits of Client's instructions, if any. The Company's sole responsibility is to its Client and this document does not exonerate parties to a transaction from exercising all their rights and obligations under the transaction documents. This document cannot be reproduced except in full, without prior written approval of the Company. Any unauthorized alteration, forgery or falsification of the content or appearance of this document is unlawful and offenders may be prosecuted to the fullest extent of the law. Unless otherwise stated the results shown in this test report refer only to the sample(s) tested and such sample(s) are retained for 30 days only.

Attention: To check the authenticity of testing/inspection report & certificate, please contact us at telephone: (86-755) 8307 1443, or email: [CN.Doccheck@sgs.com](mailto:CN.Doccheck@sgs.com)  
 S/E Unit D, Building 1, Kanglong Orange Science Park, No.157, Keyuan 3rd Road, Fenglong New Town, Xi'an, Shaanxi, China 710086 t (86-29) 6282 7885 www.sgs.com.cn  
 中国·西安·沣东新城科里三路157号康隆橙方科技园1号楼D单元1层 邮编: 710086 t (86-29) 6282 7885 sgs.china@sgs.com

Report No.: XEWA2310000070RG05  
 Rev.: 01  
 Page: 7 of 267

Use Conditions:	Indoor
RF Cable:	1.5dB
Remark: As above information is provided and confirmed by the applicant. SGS is not liable to the accuracy, suitability, reliability or/and integrity of the information.	

Remark:  
 In FCC 15.31, for each band in which the device can be operated with the device operating at the number of frequencies in each band specified in the following table, and the selected channel to perform the test as below:

Frequency range over which device operates	Number of Measurement Frequencies Required	Location of Measurement Frequency in Band of Operation
1 MHz or less	1	centre
1 MHz to 10 MHz	2	1 near high end, 1 near low end
Greater than 10 MHz	3	1 near high end, 1 near centre

For UNII Band II-A:		
Mode	Channel	Frequency(MHz)
IEEE 802.11a/n/ac/ax 20MHz	The Lowest channel	5260
	The Middle channel	5280
	The Highest channel	5320
IEEE 802.11n/ac/ax 40MHz	The Lowest channel	5270
	The Highest channel	5310
IEEE 802.11ac/ax 80MHz	The Middle channel	5290

For UNII Band II-C:		
Mode	Channel	Frequency(MHz)
IEEE 802.11a/n/ac/ax 20MHz	The Lowest channel	5500
	The Middle channel	5580
	The Highest channel	5700
IEEE 802.11n/ac/ax 40MHz	The Lowest channel	5510
	The Middle channel	5550
	The Highest channel	5670
IEEE 802.11ac/ax 80MHz	The Lowest channel	5530
	The Highest channel	5610



Unless otherwise agreed in writing, this document is issued by the Company subject to its General Conditions of Service printed overleaf, available on request or accessible at <http://www.sgs.com/en/Terms-and-Conditions.aspx> and, for electronic format documents, subject to Terms and Conditions for Electronic Documents at <http://www.sgs.com/en/Terms-and-Conditions/Terms-e-Documents.aspx>. Attention is drawn to the limitation of liability, indemnification and jurisdiction issues defined therein. Any holder of this document is advised that information contained herein reflects the Company's findings at the time of its intervention only and within the limits of Client's instructions, if any. The Company's sole responsibility is to its Client and this document does not exonerate parties to a transaction from exercising all their rights and obligations under the transaction documents. This document cannot be reproduced except in full, without prior written approval of the Company. Any unauthorized alteration, forgery or falsification of the content or appearance of this document is unlawful and offenders may be prosecuted to the fullest extent of the law. Unless otherwise stated the results shown in this test report refer only to the sample(s) tested and such sample(s) are retained for 30 days only.

Attention: To check the authenticity of testing/inspection report & certificate, please contact us at telephone: (86-755) 8307 1443, or email: CN\_Doccheck@sgs.com  
 S/E Unit D, Building 1, Kanghong Orange Science Park, No.137, Keyuan 3rd Road, Fengfeng New Town, Xi'an, Shaanxi, China 710086 t (86-29) 6282 7885 www.sgs.com.cn  
 中国·西安·沣东新城科园三路137号康鸿橙方科技园1号楼D单元1层 邮编: 710086 t (86-29) 6282 7885 sgs.china@sgs.com

Report No.: XEWA2310000070RG05  
 Rev.: 01  
 Page: 8 of 267

Frequency Band	Channel	Freq.(MHz)	Channel	Freq.(MHz)
Straddle Channel	144 <sup>[1]</sup>	5720	142 <sup>[2]</sup>	5710
	138 <sup>[3]</sup>	5690		
TDWR Channel	120 <sup>[1]</sup>	5600	124 <sup>[1]</sup>	5620
	128 <sup>[1]</sup>	5640	118 <sup>[2]</sup>	5590
	126 <sup>[2]</sup>	5630	122 <sup>[3]</sup>	5610

**Note:**

1. The above Frequency and Channel were 802.11a, 802.11n HT20, 802.11ac VHT20 and 802.11ax HE20.
2. The above Frequency and Channel were 802.11n HT40, 802.11ac VHT40 and 802.11ax HE40.
3. The above Frequency and Channel were 802.11ac VHT80 and 802.11ax HE80.



Unless otherwise agreed in writing, this document is issued by the Company subject to its General Conditions of Service printed overleaf, available on request or accessible at <http://www.sgs.com/en/Terms-and-Conditions.aspx> and, for electronic format documents, subject to Terms and Conditions for Electronic Documents at <http://www.sgs.com/en/Terms-and-Conditions/Terms-e-Document.aspx>. Attention is drawn to the limitation of liability, indemnification and jurisdiction issues defined therein. Any holder of this document is advised that information contained herein reflects the Company's findings at the time of its intervention only and within the limits of Client's instructions, if any. The Company's sole responsibility is to its Client and this document does not exonerate parties to a transaction from exercising all their rights and obligations under the transaction documents. This document cannot be reproduced except in full, without prior written approval of the Company. Any unauthorized alteration, forgery or falsification of the content or appearance of this document is unlawful and offenders may be prosecuted to the fullest extent of the law. Unless otherwise stated the results shown in this test report refer only to the sample(s) tested and such sample(s) are retained for 30 days only.

Attention: To check the authenticity of testing/inspection report & certificate, please contact us at telephone: (86-755) 8307 1443, or email: [CN.Doccheck@sgs.com](mailto:CN.Doccheck@sgs.com)



### 3.5 Test Environment and Mode

Environment Parameter	101.0 kPa Selected Values During Tests	
Relative Humidity	44-46 % RH Ambient	
Value	Temperature(°C)	Voltage(V)
NTNV	22~23	3.85

Remark:  
 NV: Normal Voltage  
 NT: Normal Temperature

### 3.6 Description of Support Units

Description	Manufacturer	Model No.
Mother board*	Quectel	N/A
Adapter*	Quectel	N/A
Test Antenna*	Quectel	YE0038AA
Phone	Hamilton	EC1002 (FCC ID:RYQEC1002)

Remark: The information with "\*" are provided by client.

### 3.7 Worst-case configuration and mode

Low data rate was used to test on antenna port conducted tests and radiated spurious emissions since it has the highest maximum power. Following are the worst-case data rates set for test:

Modulation Type	SISO - Data Rate	CDD/MIMO - Data Rate
802.11a	6 Mbps	12 Mbps
802.11n (HT 20)	MCS0 (6.5 Mbps)	MCS0 (13 Mbps)
802.11n (HT 40)	MCS0 (13.5 Mbps)	MCS0 (27 Mbps)
802.11ac (VHT 20)	MCS0 (6.5 Mbps)	MCS0 (13 Mbps)
802.11ac (VHT 40)	MCS0 (13.5 Mbps)	MCS0 (27 Mbps)
802.11ac (VHT 80)	MCS0 (29.3 Mbps)	MCS0 (58.5 Mbps)
802.11ax (HE 20)	MCS0 (8 Mbps)	MCS0 (16 Mbps)
802.11ax (HE 40)	MCS0 (16 Mbps)	MCS0 (32 Mbps)
802.11ax (HE 80)	MCS0 (34 Mbps)	MCS0 (68 Mbps)



## 4 Test results and Measurement Data

### 4.1 Dynamic Frequency Selection

#### 4.1.1 DFS Measurement Configuration

Test Condition	Conducted Measurement Use 50Ohms to connect cable/connector calibration and testing, Use Ant0 port for testing. Refer to Section 4.1.7 for test connection.
----------------	--

#### 4.1.2 DFS Threshold level

DFS Threshold level:( -64 )dBm	<input checked="" type="checkbox"/> At the antenna connector <input type="checkbox"/> In front of the antenna
The Interference <b>Radar Detection Threshold Level is:</b> <b>(Band II-A: -64dBm + 1.00dBi + 0dB = -63dBm);</b> <b>(Band II-C: -64dBm + 0.60dBi + 0dB = -63.4dBm)</b> That had been taken into account the output power range and antenna gain.	

#### 4.1.3 Power-on cycle

The time required for the Master Device and/or Client Device to complete its power-on cycle(58S).
---

#### 4.1.4 User Access Restrctions

DFS Controls(Hardware or software) related to radar detection are NOT accessible to the user. Manufacturer statement confirming that information regarding the parameters of the detected Radar Waveforms is not available to the end user.
---

#### 4.1.5 Channel Loading/Data Streaming

<input type="checkbox"/>	The dara file(MPEG-4) has been transmitting in a streaming mode.
<input checked="" type="checkbox"/>	Softwae to ping the client is permitted to simuate data transfer with random ping intervals.
<input checked="" type="checkbox"/>	Minimum channel loading of approximately 17%.
<input type="checkbox"/>	Unicast protocol has been used.



Unless otherwise agreed in writing, this document is issued by the Company subject to its General Conditions of Service printed overleaf, available on request or accessible at <http://www.sgs.com/en/Terms-and-Conditions.aspx> and, for electronic format documents, subject to Terms and Conditions for Electronic Documents at <http://www.sgs.com/en/Terms-and-Conditions/Terms-e-Document.aspx>. Attention is drawn to the limitation of liability, indemnification and jurisdiction issues defined therein. Any holder of this document is advised that information contained herein reflects the Company's findings at the time of its intervention only and within the limits of Client's instructions, if any. The Company's sole responsibility is to its Client and this document does not exonerate parties to a transaction from exercising all their rights and obligations under the transaction documents. This document cannot be reproduced except in full, without prior written approval of the Company. Any unauthorized alteration, forgery or falsification of the content or appearance of this document is unlawful and offenders may be prosecuted to the fullest extent of the law. Unless otherwise stated the results shown in this test report refer only to the sample(s) tested and such sample(s) are retained for 30 days only.

#### 4.1.6 Conducted Setup of Calibration of DFS Detection Threshold Level



#### 4.1.7 Test Setup

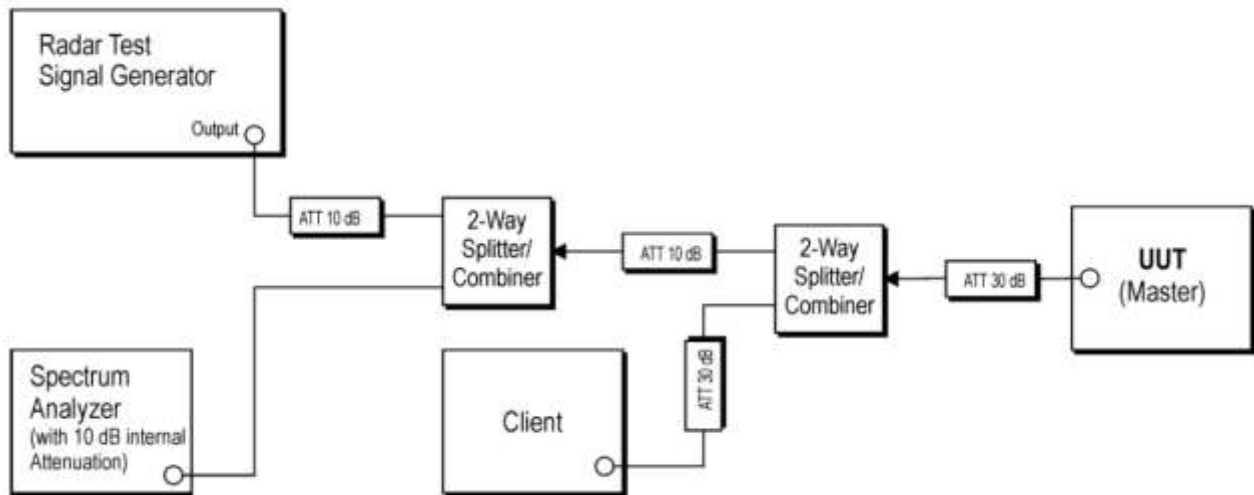

Unless otherwise agreed in writing, this document is issued by the Company subject to its General Conditions of Service printed overleaf, available on request or accessible at <http://www.sgs.com/en/Terms-and-Conditions.aspx> and, for electronic format documents, subject to Terms and Conditions for Electronic Documents at <http://www.sgs.com/en/Terms-and-Conditions/Terms-e-Document.aspx>. Attention is drawn to the limitation of liability, indemnification and jurisdiction issues defined therein. Any holder of this document is advised that information contained herein reflects the Company's findings at the time of its intervention only and within the limits of Client's instructions, if any. The Company's sole responsibility is to its Client and this document does not exonerate parties to a transaction from exercising all their rights and obligations under the transaction documents. This document cannot be reproduced except in full, without prior written approval of the Company. Any unauthorized alteration, forgery or falsification of the content or appearance of this document is unlawful and offenders may be prosecuted to the fullest extent of the law. Unless otherwise stated the results shown in this test report refer only to the sample(s) tested and such sample(s) are retained for 30 days only.

Report No.: XEWA2310000070RG05

Rev.: 01

Page: 12 of 267

## 4.1.8 Test Procedures

### 4.1.8.1 U-NII Detection Bandwidth

Adjust the equipment to produce a single *Burst* of any one of the Short Pulse Radar Types 0 – 4 in **Table 5** at the center frequency of the UUT *Operating Channel* at the specified *DFS Detection Threshold* level found in **Table 3**.

Set the UUT up as a standalone device (no associated Client or Master, as appropriate) and no traffic. Frame based systems will be set to a talk/listen ratio reflecting the worst case (maximum) that is user configurable during this test.

Generate a single radar *Burst*, and note the response of the UUT. Repeat for a minimum of 10 trials. The UUT must detect the *Radar Waveform* within the DFS band using the specified *U-NII Detection Bandwidth* criterion shown in **Table 4**. In cases where the channel bandwidth may exceed past the DFS band edge on specific channels (i.e., 802.11ac or wideband frame based systems) select a channel that has the entire emission bandwidth within the DFS band. If this is not possible, test the detection BW to the DFS band edge. Starting at the center frequency of the UUT operating *Channel*, increase the radar frequency in 5 MHz steps, repeating the above test sequence, until the detection rate falls below the *U-NII Detection Bandwidth* criterion specified in **Table 4**. Repeat this measurement in 1MHz steps at frequencies 5 MHz below where the detection rate begins to fall. Record the highest frequency (denote as FH) at which detection is greater than or equal to the *U-NII Detection Bandwidth* criterion. Recording the detection rate at frequencies above FH is not required to demonstrate compliance.

Starting at the center frequency of the UUT operating *Channel*, decrease the radar frequency in 5 MHz steps, repeating the above test sequence, until the detection rate falls below the *U-NII Detection Bandwidth* criterion specified in **Table 4**. Repeat this measurement in 1MHz steps at frequencies 5 MHz above where the detection rate begins to fall. Record the lowest frequency (denote as FL) at which detection is greater than or equal to the *U-NII Detection Bandwidth* criterion. Recording the detection rate at frequencies below FL is not required to demonstrate compliance.

The *U-NII Detection Bandwidth* is calculated as follows:

$$U-NII\ Detection\ Bandwidth = FH - FL$$

The *U-NII Detection Bandwidth* must meet the *U-NII Detection Bandwidth* criterion specified in **Table 4**. Otherwise, the UUT does not comply with DFS requirements. This is essential to ensure that the UUT is capable of detecting *Radar Waveforms* across the same frequency spectrum that contains the significant energy from the system. In the case that the *U-NII Detection Bandwidth* is greater than or equal to the 99 percent power bandwidth for the measured FH and FL, the test can be truncated and the *U-NII Detection Bandwidth* can be reported as the measured FH and FL.

### 4.1.8.2 Performance Requirements Check

The following tests must be performed for U-NII device certification: Initial *Channel Startup Check* with a radar *Burst* at start of *Channel Availability Check* and with a radar *Burst* at end of *Channel Availability Check*; *In-Service Monitoring*; and the 30 minute *Non-Occupancy Period*.

### 4.1.8.3 Initial Channel Availability Check Time

The Initial *Channel Availability Check Time* tests that the UUT does not emit beacon, control, or data signals on the test *Channel* until the power-up sequence has been completed and the U-NII device checks for *Radar Waveforms* for one minute on the test *Channel*. This test does not use any *Radar Waveforms* and only needs to be performed one time.

a) The U-NII devices will be powered on and be instructed to operate on the appropriate U-NII *Channel* that must incorporate DFS functions. At the same time the UUT is powered on, the spectrum analyzer will be set to zero span mode with a 3 MHz RBW and 3 MHz VBW on the *Channel* occupied by the radar (Chr) with a 2.5 minute sweep time. The spectrum analyzer's sweep will be started at the same time power is applied to



Unless otherwise agreed in writing, this document is issued by the Company subject to its General Conditions of Service printed overleaf, available on request or accessible at <http://www.sgs.com/en/Terms-and-Conditions.aspx> and, for electronic format documents, subject to Terms and Conditions for Electronic Documents at <http://www.sgs.com/en/Terms-and-Conditions/Terms-e-Documents.aspx>. Attention is drawn to the limitation of liability, indemnification and jurisdiction issues defined therein. Any holder of this document is advised that information contained herein reflects the Company's findings at the time of its intervention only and within the limits of Client's instructions, if any. The Company's sole responsibility is to its Client and this document does not exonerate parties to a transaction from exercising all their rights and obligations under the transaction documents. This document cannot be reproduced except in full, without prior written approval of the Company. Any unauthorized alteration, forgery or falsification of the content or appearance of this document is unlawful and offenders may be prosecuted to the fullest extent of the law. Unless otherwise stated the results shown in this test report refer only to the sample(s) tested and such sample(s) are retained for 30 days only.

Attention: To check the authenticity of testing/inspection report & certificate, please contact us at telephone: (86-755) 8307 1443, or email: CN\_Doccheck@sgs.com

SGS-CSTC Standards Technical Services (Xi'an) Co., Ltd. | 1/F Unit D, Building 1, Kanglong Orange Science Park, No.157, Keyuan 3rd Road, Fengfeng New Town, Xi'an, Shaanxi, China | 710086

中国·西安·沣东新城科里三路157号康鸿橙方科技园1号楼D单元1层 | 邮编: 710086

t (86-29) 6282 7885 | www.sgsgroup.com.cn

t (86-29) 6282 7885 | sgs.china@sgs.com

Report No.: XEWA2310000070RG05

Rev.: 01

Page: 13 of 267

the U-NII device.

b) The UUT should not transmit any beacon or data transmissions until at least 1 minute after the completion of the power-on cycle.

c) Confirm that the UUT initiates transmission on the channel

This measurement can be used to determine the length of the power-on cycle if it is not supplied by the manufacturer. If the spectrum analyzer sweep is started at the same time the UUT is powered on and the UUT does not begin transmissions until it has completed the cycle, the power-on time can be determined by comparing the two times.

#### 4.1.8.4 Radar Burst at the Beginning of the Channel Availability Check Time

The steps below define the procedure to verify successful radar detection on the test *Channel* during a period equal to the *Channel Availability Check Time* and avoidance of operation on that *Channel* when a radar *Burst* with a level equal to the *DFS Detection Threshold* + 1 dB occurs at the beginning of the *Channel Availability Check Time*. This is illustrated in **Figure 15**.

a) The *Radar Waveform* generator and UUT are connected using the applicable test setup described in the sections on configuration for Conducted Tests (7.2) or Radiated Tests (7.3) and the power of the UUT is switched off.

b) The UUT is powered on at T0. T1 denotes the instant when the UUT has completed its power-up sequence (T<sub>power\_up</sub>). The *Channel Availability Check Time* commences on Chr at instant T1 and will end no sooner than T1 + T<sub>ch\_avail\_check</sub>.

c) A single *Burst* of one of the Short Pulse Radar Types 0-4 will commence within a 6 second window starting at T1. An additional 1 dB is added to the radar test signal to ensure it is at or above the *DFS Detection Threshold*, accounting for equipment variations/errors.

d) Visual indication or measured results on the UUT of successful detection of the radar *Burst* will be recorded and reported. Observation of Chr for UUT emissions will continue for 2.5 minutes after the radar *Burst* has been generated.

e) Verify that during the 2.5 minute measurement window no UUT transmissions occurred on Chr. The *Channel Availability Check* results will be recorded.



Unless otherwise agreed in writing, this document is issued by the Company subject to its General Conditions of Service printed overleaf, available on request or accessible at <http://www.sgs.com/en/Terms-and-Conditions.aspx> and, for electronic format documents, subject to Terms and Conditions for Electronic Documents at <http://www.sgs.com/en/Terms-and-Conditions/Terms-e-Documents.aspx>. Attention is drawn to the limitation of liability, indemnification and jurisdiction issues defined therein. Any holder of this document is advised that information contained herein reflects the Company's findings at the time of its intervention only and within the limits of Client's instructions, if any. The Company's sole responsibility is to its Client and this document does not exonerate parties to a transaction from exercising all their rights and obligations under the transaction documents. This document cannot be reproduced except in full, without prior written approval of the Company. Any unauthorized alteration, forgery or falsification of the content or appearance of this document is unlawful and offenders may be prosecuted to the fullest extent of the law. Unless otherwise stated the results shown in this test report refer only to the sample(s) tested and such sample(s) are retained for 30 days only.

Attention: To check the authenticity of testing/inspection report & certificate, please contact us at telephone: (86-755) 8307 1443, or email: CN.Doccheck@sgs.com

1/E Unit D, Building 1, Kanghong Orange Science Park, No.137, Keyuan 3rd Road, Fengcheng New Town, Xi'an, Shaanxi, China 710086

t (86-29) 6282 7885 www.sgs.com

中国·西安·沣东新城科园三路137号康鸿橙方科技园1号楼D单元1层 邮编: 710086

t (86-29) 6282 7885 sgs.china@sgs.com

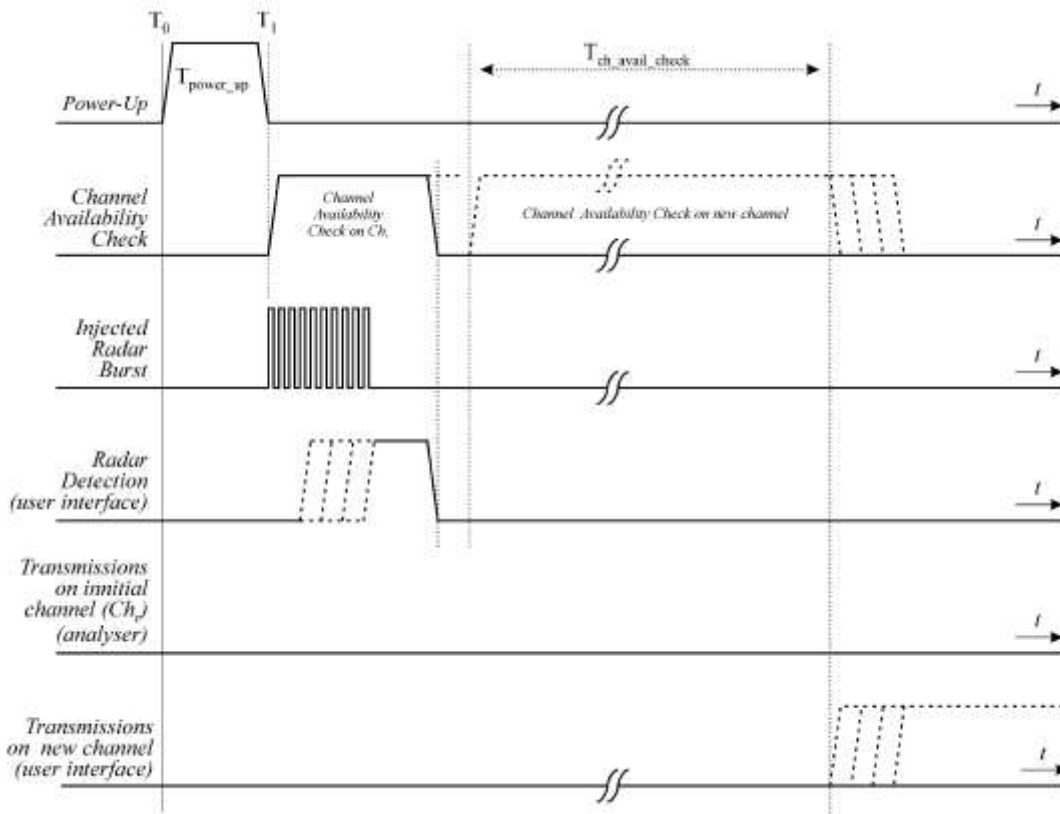

Figure 15: Example of timing for radar testing at the beginning of the Channel Availability Check Time

#### 4.1.8.5 Radar Burst at the End of the Channel Availability Check Time

The steps below define the procedure to verify successful radar detection on the test Channel during a period equal to the Channel Availability Check Time and avoidance of operation on that Channel when a radar Burst with a level equal to the DFS Detection Threshold + 1dB occurs at the end of the Channel Availability Check Time. This is illustrated in Figure 16.

- The Radar Waveform generator and UUT are connected using the applicable test setup described in the sections for Conducted Tests (7.2) or Radiated Tests (7.3) and the power of the UUT is switched off.
- The UUT is powered on at T0. T1 denotes the instant when the UUT has completed its power-up sequence (Tpower\_up). The Channel Availability Check Time commences on Chr at instant T1 and will end no sooner than T1 + Tch\_avail\_check.
- A single Burst of one of the Short Pulse Radar Types 0-4 will commence within a 6 second window starting at T1 + 54 seconds. An additional 1 dB is added to the radar test signal to ensure it is at or above the DFS Detection Threshold, accounting for equipment variations/errors.
- Visual indication or measured results on the UUT of successful detection of the radar Burst will be recorded and reported. Observation of Chr for UUT emissions will continue for 2.5 minutes after the radar Burst has been generated.
- Verify that during the 2.5 minute measurement window no UUT transmissions occurred on Chr. The Channel Availability Check results will be recorded.



Unless otherwise agreed in writing, this document is issued by the Company subject to its General Conditions of Service printed overleaf, available on request or accessible at <http://www.sgs.com/en/Terms-and-Conditions.aspx> and, for electronic format documents, subject to Terms and Conditions for Electronic Documents at <http://www.sgs.com/en/Terms-and-Conditions/Terms-e-Document.aspx>. Attention is drawn to the limitation of liability, indemnification and jurisdiction issues defined therein. Any holder of this document is advised that information contained herein reflects the Company's findings at the time of its intervention only and within the limits of Client's instructions, if any. The Company's sole responsibility is to its Client and this document does not exonerate parties to a transaction from exercising all their rights and obligations under the transaction documents. This document cannot be reproduced except in full, without prior written approval of the Company. Any unauthorized alteration, forgery or falsification of the content or appearance of this document is unlawful and offenders may be prosecuted to the fullest extent of the law. Unless otherwise stated the results shown in this test report refer only to the sample(s) tested and such sample(s) are retained for 30 days only.

Attention: To check the authenticity of testing/inspection report & certificate, please contact us at telephone: (86-755) 8307 1443, or email: CN.Doccheck@sgs.com  
 U/E Unit D, Building 1, Kanghong Orange Science Park, No.157, Keyuan3rd Road, Fengling New Town, Xi'an, Shaanxi, China 710086 t (86-29) 6282 7885 www.sgs.com.cn  
 中国·西安·沣东新城科里三路157号康鸿橙方科技园1号楼D单元1层 邮编: 710086 t (86-29) 6282 7885 sgs.china@sgs.com

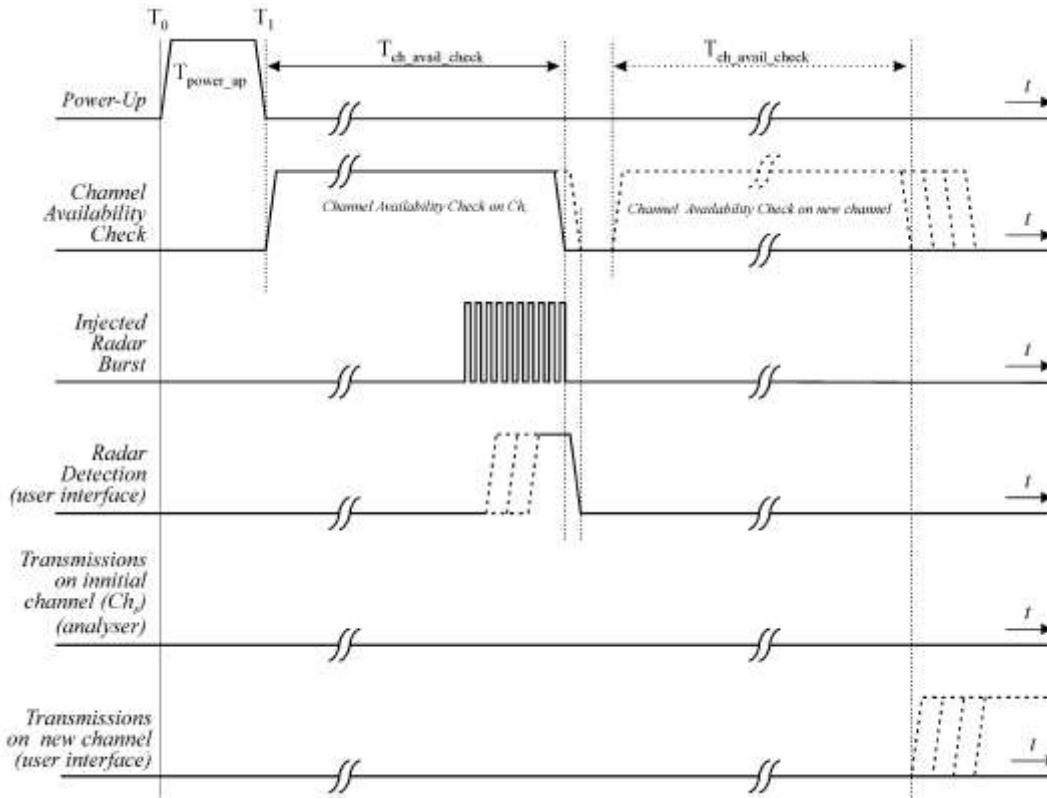

Figure 16: Example of timing for radar testing towards the end of the Channel Availability Check Time

#### 4.1.8.6 In-Service Monitoring for Channel Move Time, Channel Closing Transmission Time and Non-Occupancy Period

These tests define how the following DFS parameters are verified during *In-Service Monitoring*;

- Channel Closing Transmission Time
- Channel Move Time
- Non-Occupancy Period

The steps below define the procedure to determine the above mentioned parameters when a radar *Burst* with a level equal to the *DFS Detection Threshold* + 1dB is generated on the *Operating Channel* of the U-NII device (*In-Service Monitoring*).

- a) One frequency will be chosen from the *Operating Channels* of the UUT within the 5250-5350 MHz or 5470-5725 MHz bands. For 802.11 devices, the test frequency must contain control signals. This can be verified by disabling channel loading and monitoring the spectrum analyzer. If no control signals are detected, another frequency must be selected within the emission bandwidth where control signals are detected.
- b) In case the UUT is a U-NII device operating as a *Client Device* (with or without DFS), a U-NII device operating as a *Master Device* will be used to allow the UUT (Client device) to *Associate* with the *Master Device*. In case the UUT is a *Master Device*, a U-NII device operating as a *Client Device* will be used and it is assumed that the Client will *Associate* with the UUT (Master). In both cases for conducted tests, the *Radar Waveform* generator will be connected to the *Master Device*. For radiated tests, the emissions of the *Radar Waveform* generator will be directed towards the *Master Device*. If the *Master Device* has antenna gain, the main beam of the antenna will be directed toward the radar emitter. Vertical polarization is used for testing.
- c) Stream the channel loading test file from the *Master Device* to the *Client Device* on the test *Channel* for



Unless otherwise agreed in writing, this document is issued by the Company subject to its General Conditions of Service printed overleaf, available on request or accessible at <http://www.sgs.com/en/Terms-and-Conditions.aspx> and, for electronic format documents, subject to Terms and Conditions for Electronic Documents at <http://www.sgs.com/en/Terms-and-Conditions/Terms-e-Documents.aspx>. Attention is drawn to the limitation of liability, indemnification and jurisdiction issues defined therein. Any holder of this document is advised that information contained herein reflects the Company's findings at the time of its intervention only and within the limits of Client's instructions, if any. The Company's sole responsibility is to its Client and this document does not exonerate parties to a transaction from exercising all their rights and obligations under the transaction documents. This document cannot be reproduced except in full, without prior written approval of the Company. Any unauthorized alteration, forgery or falsification of the content or appearance of this document is unlawful and offenders may be prosecuted to the fullest extent of the law. Unless otherwise stated the results shown in this test report refer only to the sample(s) tested and such sample(s) are retained for 30 days only.

Attention: To check the authenticity of testing/inspection report & certificate, please contact us at telephone: (86-755) 8307 1443, or email: [CN.Doccheck@sgs.com](mailto:CN.Doccheck@sgs.com)  
 (U) Unit D, Building 1, Kanghong Orange Science Park, No.157, Keyuan 3rd Road, Fengling New Town, Xi'an, Shaanxi, China 710086 t (86-29) 6282 7885 www.sgs.com.cn  
 中国·西安·沣东新城科里三路157号康鸿橙方科技园1号楼D单元1层 邮编: 710086 t (86-29) 6282 7885 sgs.china@sgs.com

the entire period of the test.

d) At time  $T_0$  the *Radar Waveform* generator sends a *Burst* of pulses for one of the Radar Type 0 in **Table 5** at levels defined in **Table 3**, on the *Operating Channel*. An additional 1 dB is added to the radar test signal to ensure it is at or above the *DFS Detection Threshold*, accounting for equipment variations/errors.

e) Observe the transmissions of the UUT at the end of the radar *Burst* on the *Operating Channel* for duration greater than 10 seconds. Measure and record the transmissions from the UUT during the observation time (*Channel Move Time*). Measure and record the *Channel Move Time* and *Channel Closing Transmission Time* if radar detection occurs. **Figure 17** illustrates *Channel Closing Transmission Time*.

f) When operating as a *Master Device*, monitor the UUT for more than 30 minutes following instant  $T_2$  to verify that the UUT does not resume any transmissions on this *Channel*. Perform this test once and record the measurement result.

g) In case the UUT is a U-NII device operating as a *Client Device* with *In-Service Monitoring*, perform steps a) to f).

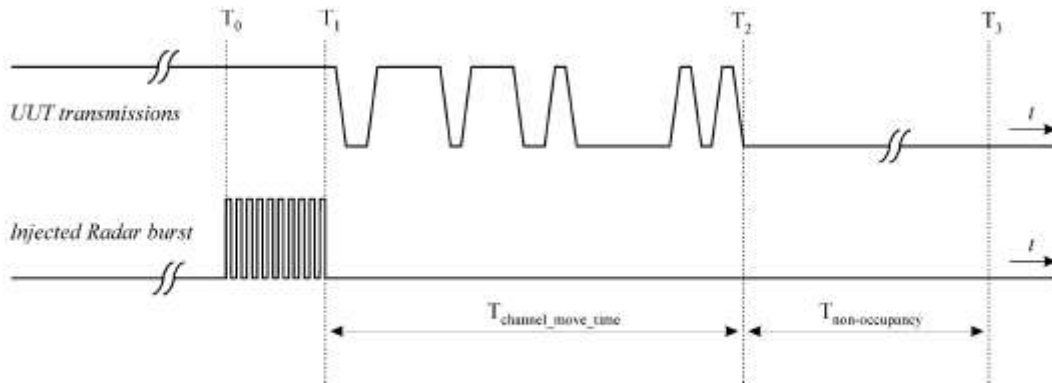

Figure 17: Example of Channel Closing Transmission Time & Channel Closing Time

#### 4.1.8.7 Statistical Performance Check

The steps below define the procedure to determine the minimum percentage of successful detection requirements found in **Tables 5-7** when a radar burst with a level equal to the *DFS Detection Threshold* + 1dB is generated on the *Operating Channel* of the U-NII device (*In-Service Monitoring*).

a) One frequency will be chosen from the *Operating Channels* of the UUT within the 5250-5350 MHz or 5470-5725 MHz bands.

b) In case the UUT is a U-NII device operating as a *Client Device* (with or without Radar Detection), a U-NII device operating as a *Master Device* will be used to allow the UUT (*Client device*) to *Associate* with the *Master Device*. In case the UUT is a *Master Device*, a U-NII device operating as a *Client Device* will be used and it is assumed that the *Client* will *Associate* with the UUT (*Master*). In both cases for conducted tests, the *Radar Waveform* generator will be connected to the *Master Device*. For radiated tests, the emissions of the *Radar Waveform* generator will be directed towards the *Master Device*. If the *Master Device* has antenna gain, the main beam of the antenna will be directed toward the radar emitter. Vertical polarization is used for testing.

c) Stream the channel loading test file from the *Master Device* to the *Client Device* on the test *Channel* for the entire period of the test.

d) At time  $T_0$  the *Radar Waveform* generator sends the individual waveform for each of the Radar Types 1- 6 in **Tables 5-7**, at levels defined in **Table 3**, on the *Operating Channel*. An additional 1 dB is added to the radar test signal to ensure it is at or above the *DFS Detection Threshold*, accounting for equipment variations/errors.

e) Observe the transmissions of the UUT at the end of the *Burst* on the *Operating Channel* for duration greater than 10 seconds for Radar Type 0 to ensure detection occurs.



Unless otherwise agreed in writing, this document is issued by the Company subject to its General Conditions of Service printed overleaf, available on request or accessible at <http://www.sgs.com/en/Terms-and-Conditions.aspx> and, for electronic format documents, subject to Terms and Conditions for Electronic Documents at <http://www.sgs.com/en/Terms-and-Conditions/Terms-e-Document.aspx>. Attention is drawn to the limitation of liability, indemnification and jurisdiction issues defined therein. Any holder of this document is advised that information contained herein reflects the Company's findings at the time of its intervention only and within the limits of Client's instructions, if any. The Company's sole responsibility is to its Client and this document does not exonerate parties to a transaction from exercising all their rights and obligations under the transaction documents. This document cannot be reproduced except in full, without prior written approval of the Company. Any unauthorized alteration, forgery or falsification of the content or appearance of this document is unlawful and offenders may be prosecuted to the fullest extent of the law. Unless otherwise stated the results shown in this test report refer only to the sample(s) tested and such sample(s) are retained for 30 days only.

Attention: To check the authenticity of testing/inspection report & certificate, please contact us at telephone: (86-755) 8307 1443, or email: CN.Doccheck@sgs.com

SGS-CSTC Standards Technical Services (Xi'an) Co., Ltd.  
 Inspection & Testing Services  
 (Xi'an, China)

11E Unit D, Building 1, Kangfeng Orange Science Park, No.157, Keyuan 3rd Road, Fengfeng New Town, Xi'an, Shaanxi, China 710086  
 中国·西安·沣东新城科里三路157号康鸿橙方科技园1号楼D单元1层 邮编: 710086

t (86-29) 6282 7885 www.sgs.com.cn  
 t (86-29) 6282 7885 sgs.china@sgs.com



- f) Observe the transmissions of the UUT at the end of the Burst on the *Operating Channel* for duration greater than 22 seconds for Long Pulse Radar Type 5 to ensure detection occurs.
- g) In case the UUT is a U-NII device operating as a *Client Device with In-Service Monitoring*, perform steps a) to f).

**4.1.8.8 Short Pulse Radar Test**

Once the performance requirements check is complete, statistical data will be gathered, to determine the ability of the device to detect the radar test waveforms (Short Pulse Radar Types 1-4) found in **Table 5**. The device can utilize a test mode to demonstrate when detection occurs to prevent the need to reset the device between trials. The percentage of successful detection is calculated by:

$$\frac{\text{TotalWaveformDetections}}{\text{TotalWaveformTrials}} \times 100 = \text{Percentage of Successful Detection Radar Waveform N} = \text{PdN}$$

In addition an aggregate minimum percentage of successful detection across all Short Pulse Radar Types 1-4 is required and is calculated as follows:

$$\frac{P_d1 + P_d2 + P_d3 + P_d4}{4}$$

The minimum number of trails, minimum percentage of successful detection and the aggregate minimum percentage of successful detection are found in **Table 5**.

**4.1.8.9 Long Pulse Radar Test**

Statistical data will be gathered to determine the ability of the device to detect the Long Pulse Radar Type 5 found in **Table 6**. The device can utilize a test mode to demonstrate when detection occurs to prevent the need to reset the device between trials.

Three subsets of trials will be performed with a minimum of ten trials per subset. The subset of trials differ in where the Long Pulse Type 5 Signal is tuned in frequency:

- a) the *Channel* center frequency (Figure 18);
- b) tuned frequencies such that 90% of the Long Pulse Type 5 frequency modulation is within the low edge of the UUT *Occupied Bandwidth* (Figure 19); and
- c) tuned frequencies such that 90% of the Long Pulse Type 5 frequency modulation is within the high edge of the UUT *Occupied Bandwidth* (Figure 20).

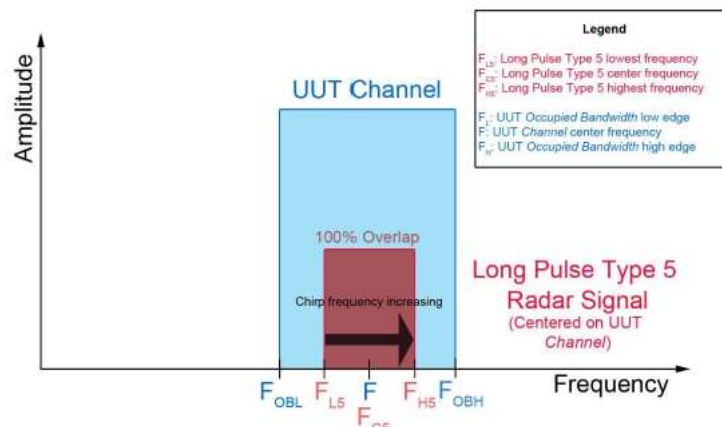

Figure 18: Example of the Relationship Between Long Pulse Type 5 Signal and the U-NII channel when the Signal is Tuned to the UUT Channel Center Frequency



Unless otherwise agreed in writing, this document is issued by the Company subject to its General Conditions of Service printed overleaf, available on request or accessible at <http://www.sgs.com/en/Terms-and-Conditions.aspx> and, for electronic format documents, subject to Terms and Conditions for Electronic Documents at <http://www.sgs.com/en/Terms-and-Conditions/Terms-e-Documents.aspx>. Attention is drawn to the limitation of liability, indemnification and jurisdiction issues defined therein. Any holder of this document is advised that information contained herein reflects the Company's findings at the time of its intervention only and within the limits of Client's instructions, if any. The Company's sole responsibility is to its Client and this document does not exonerate parties to a transaction from exercising all their rights and obligations under the transaction documents. This document cannot be reproduced except in full, without prior written approval of the Company. Any unauthorized alteration, forgery or falsification of the content or appearance of this document is unlawful and offenders may be prosecuted to the fullest extent of the law. Unless otherwise stated the results shown in this test report refer only to the sample(s) tested and such sample(s) are retained for 30 days only.

Attention: To check the authenticity of testing/inspection report & certificate, please contact us at telephone: (86-755) 8307 1443, or email: CN\_Doccheck@sgs.com

SGS-CSTC Standards Technical Services (Xi'an) Co., Ltd. | 1/F Unit D, Building 1, Kanglong Orange Science Park, No.157, Keyuan3rd Road, Fengling New Town, Xi'an, Shaanxi, China | 710086  
 中国·西安·沣东新城科里三路157号康鸿橙方科技园1号楼D单元1层 | 邮编: 710086

t (86-29) 6282 7885 | www.sgs.com.cn  
 t (86-29) 6282 7885 | sgs.china@sgs.com

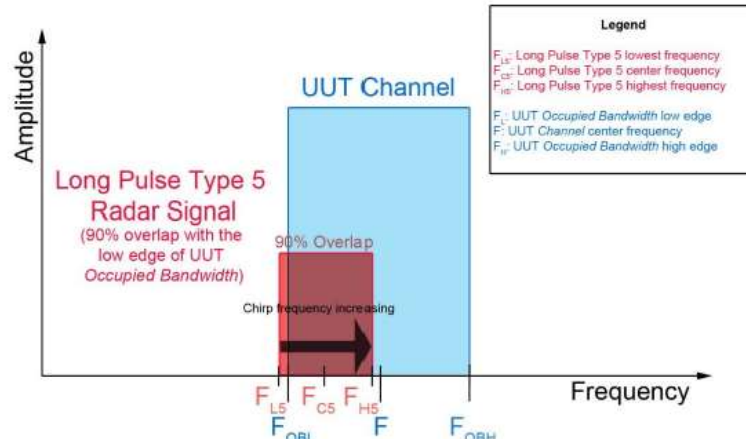

Figure 19: Example of the Relationship Between Long Pulse Type 5 Signal and the U-NII channel when the Signal is Tuned so that 90% of the Radar Signal Overlaps with the Low Edge of the UUT Occupied Bandwidth

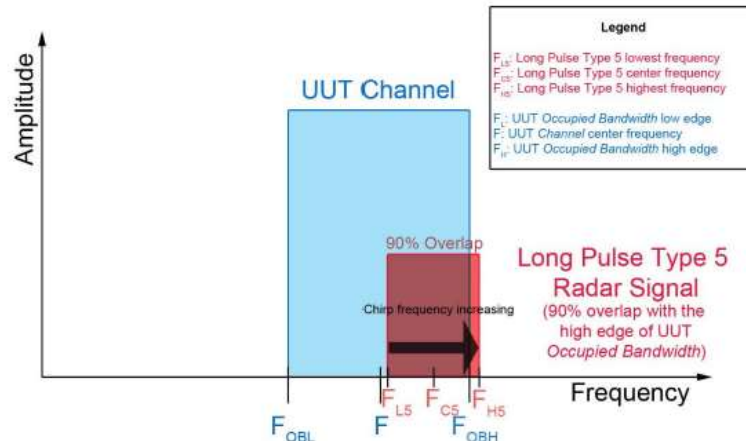

Figure 20: Example of the Relationship Between Long Pulse Type 5 Signal and the U-NII channel when the Signal is Tuned so that 90% of the Radar Signal Overlaps with the High Edge of the UUT Occupied Bandwidth

For subset case 1: the center frequency of the signal generator will remain fixed at the center of the UUT Channel.

For subset case 2: to retain 90% frequency overlap between the radar signal and the UUT Occupied Bandwidth, the center frequency of the signal generator will vary for each of the ten trials in subset case 2. The center frequency of the signal generator for each trial is calculated by:

$$FL + (0.4 * \text{Chirp Width [in MHz]})$$

For subset case 3: to retain 90% frequency overlap between the radar signal and the UUT Occupied Bandwidth, the center frequency of the signal generator will vary for each of the ten trials in subset case 3. The center frequency of the signal generator for each trial is calculated by:

$$FH - (0.4 * \text{Chirp Width [in MHz]})$$

The percentage of successful detection is calculated by dividing the sum of the detections for the three subsets by the sum of trials for the three subsets:

$$\frac{\text{Total Waveform Detections}}{\text{Total Waveform Trials}} \times 100$$



Unless otherwise agreed in writing, this document is issued by the Company subject to its General Conditions of Service printed overleaf, available on request or accessible at <http://www.sgs.com/en/Terms-and-Conditions.aspx> and, for electronic format documents, subject to Terms and Conditions for Electronic Documents at <http://www.sgs.com/en/Terms-and-Conditions/Terms-e-Documents.aspx>. Attention is drawn to the limitation of liability, indemnification and jurisdiction issues defined therein. Any holder of this document is advised that information contained herein reflects the Company's findings at the time of its intervention only and within the limits of Client's instructions, if any. The Company's sole responsibility is to its Client and this document does not exonerate parties to a transaction from exercising all their rights and obligations under the transaction documents. This document cannot be reproduced except in full, without prior written approval of the Company. Any unauthorized alteration, forgery or falsification of the content or appearance of this document is unlawful and offenders may be prosecuted to the fullest extent of the law. Unless otherwise stated the results shown in this test report refer only to the sample(s) tested and such sample(s) are retained for 30 days only.  
 Attention: To check the authenticity of testing/inspection report & certificate, please contact us at telephone: (86-755) 8307 1443, or email: CN\_Doccheck@sgs.com

Report No.: XEWA2310000070RG05  
 Rev.: 01  
 Page: 19 of 267

**4.1.8.10 Frequency Hopping Radar Test**

Statistical data will be gathered to determine the ability of the device to detect the Frequency Hopping radar test signal (radar type 6) found in **Table 7**. The device can utilize a test mode to demonstrate when detection occurs to prevent the need to reset the device between trial runs. The probability of successful detection is calculated by:

$$\frac{\text{TotalWaveformDetections}}{\text{TotalWaveformTrials}} \times 100$$



Unless otherwise agreed in writing, this document is issued by the Company subject to its General Conditions of Service printed overleaf, available on request or accessible at <http://www.sgs.com/en/Terms-and-Conditions.aspx> and, for electronic format documents, subject to Terms and Conditions for Electronic Documents at <http://www.sgs.com/en/Terms-and-Conditions/Terms-e-Documents.aspx>. Attention is drawn to the limitation of liability, indemnification and jurisdiction issues defined therein. Any holder of this document is advised that information contained herein reflects the Company's findings at the time of its intervention only and within the limits of Client's instructions, if any. The Company's sole responsibility is to its Client and this document does not exonerate parties to a transaction from exercising all their rights and obligations under the transaction documents. This document cannot be reproduced except in full, without prior written approval of the Company. Any unauthorized alteration, forgery or falsification of the content or appearance of this document is unlawful and offenders may be prosecuted to the fullest extent of the law. Unless otherwise stated the results shown in this test report refer only to the sample(s) tested and such sample(s) are retained for 30 days only.  
 Attention: To check the authenticity of testing/inspection report & certificate, please contact us at telephone: (86-755) 8307 1443, or email: CN.Doccheck@sgs.com

**4.1.9 Applicability of DFS Requirements Prior to Use of a Channel**

Requirement	DFS Operational mode		
	Master	Client Without Radar Detection	Client With Radar Detection
Non-Occupancy Period	Yes	Not required	Yes
DFS Detection Threshold	Yes	Not required	Yes
Channel Availability Check Time	Yes	Not required	Not required
U-NII Detection Bandwidth	Yes	Not required	Yes

**4.1.10 Applicability of DFS Requirements During Normal Operation**

Requirement	DFS Operational mode	
	Master Device or Client with Radar Detection	Client Without Radar Detection
DFS Detection Threshold	Yes	Not required
Channel Availability Check Time	Yes	Yes
Channel Move Time	Yes	Yes
U-NII Detection Bandwidth	Yes	Not required

Additional requirements for devices with multiple bandwidth modes	Master Device or Client with Radar Detection	Client Without Radar Detection
U-NII Detection Bandwidth and Statistical Performance Check	All BW modes must be tested	Not required
Channel Move Time and Channel Closing Transmission Time	Test using widest BW mode available	Test using the widest BW mode available for the link
All other tests	Any single BW mode	Not required

Note: Frequencies selected for statistical performance check (Section 7.8.4) should include several frequencies within the radar detection bandwidth and frequencies near the edge of the radar detection bandwidth. For 802.11 devices it is suggested to select frequencies in each of the bonded 20 MHz channels and the channel center frequency.



Unless otherwise agreed in writing, this document is issued by the Company subject to its General Conditions of Service printed overleaf, available on request or accessible at <http://www.sgs.com/en/Terms-and-Conditions.aspx> and, for electronic format documents, subject to Terms and Conditions for Electronic Documents at <http://www.sgs.com/en/Terms-and-Conditions/Terms-e-Documents.aspx>. Attention is drawn to the limitation of liability, indemnification and jurisdiction issues defined therein. Any holder of this document is advised that information contained herein reflects the Company's findings at the time of its intervention only and within the limits of Client's instructions, if any. The Company's sole responsibility is to its Client and this document does not exonerate parties to a transaction from exercising all their rights and obligations under the transaction documents. This document cannot be reproduced except in full, without prior written approval of the Company. Any unauthorized alteration, forgery or falsification of the content or appearance of this document is unlawful and offenders may be prosecuted to the fullest extent of the law. Unless otherwise stated the results shown in this test report refer only to the sample(s) tested and such sample(s) are retained for 30 days only.  
 Attention: To check the authenticity of testing/inspection report & certificate, please contact us at telephone: (86-755) 8307 1443, or email: [CN\\_Doccheck@sgs.com](mailto:CN_Doccheck@sgs.com)

**4.1.11 DFS Detection Thresholds**

Maximum Transmit Power	Value (See Notes 1, 2, and 3)
EIRP ≥ 200 milliwatt	-64 dBm
EIRP < 200 milliwatt and power spectral density < 10 dBm/MHz	-62 dBm
EIRP < 200 milliwatt that do not meet the power spectral density requirement	-64 dBm

Note 1: This is the level at the input of the receiver assuming a 0 dBi receive antenna.  
 Note 2: Throughout these test procedures an additional 1 dB has been added to the amplitude of the test transmission waveforms to account for variations in measurement equipment. This will ensure that the test signal is at or above the detection threshold level to trigger a DFS response.  
 Note3: EIRP is based on the highest antenna gain. For MIMO devices refer to KDB Publication 662911 D01.

**4.1.12 Response Requirements**

Parameter	Value
Non-occupancy period	Minimum 30 minutes
Channel Availability Check Time	60 seconds
Channel Move Time	10 seconds See Note 1.
Channel Closing Transmission Time	200 milliseconds + an aggregate of 60 milliseconds over remaining 10 second period. See Notes 1 and 2.
U-NII Detection Bandwidth	Minimum 100% of the U-NII 99% transmission power bandwidth. See Note 3.

Note 1: Channel Move Time and the Channel Closing Transmission Time should be performed with Radar Type 0. The measurement timing begins at the end of the Radar Type 0 burst.  
 Note 2: The Channel Closing Transmission Time is comprised of 200 milliseconds starting at the beginning of the Channel Move Time plus any additional intermittent control signals required to facilitate a Channel move (an aggregate of 60 milliseconds) during the remainder of the 10 second period. The aggregate duration of control signals will not count quiet periods in between transmissions.  
 Note 3: During the U-NII Detection Bandwidth detection test, radar type 0 should be used. For each frequency step the minimum percentage of detection is 90 percent. Measurements are performed with no data traffic.



Unless otherwise agreed in writing, this document is issued by the Company subject to its General Conditions of Service printed overleaf, available on request or accessible at <http://www.sgs.com/en/Terms-and-Conditions.aspx> and, for electronic format documents, subject to Terms and Conditions for Electronic Documents at <http://www.sgs.com/en/Terms-and-Conditions/Terms-e-Documents.aspx>. Attention is drawn to the limitation of liability, indemnification and jurisdiction issues defined therein. Any holder of this document is advised that information contained herein reflects the Company's findings at the time of its intervention only and within the limits of Client's instructions, if any. The Company's sole responsibility is to its Client and this document does not exonerate parties to a transaction from exercising all their rights and obligations under the transaction documents. This document cannot be reproduced except in full, without prior written approval of the Company. Any unauthorized alteration, forgery or falsification of the content or appearance of this document is unlawful and offenders may be prosecuted to the fullest extent of the law. Unless otherwise stated the results shown in this test report refer only to the sample(s) tested and such sample(s) are retained for 30 days only.  
 Attention: To check the authenticity of testing/inspection report & certificate, please contact us at telephone: (86-755) 4307 1443, or email: [CN\\_Doccheck@sgs.com](mailto:CN_Doccheck@sgs.com)

**4.1.13 Short Pulse Radar Test Waveforms**

Radar Type	Pulse Width (μsec)	PRI(μsec)	Number of Pulses	Minimum Percentage of Successful Detection	Minimum Number of Trials
0	1	1428	18	See Note 1	See Note 1
1	1	Test A: 15 unique PRI values randomly selected from the list of 23 PRI values in Table 5a	$\text{Roundup} \left\{ \left( \frac{1}{360} \right) \cdot \left( \frac{19 \cdot 10^6}{\text{PRI}_{\mu\text{sec}}} \right) \right\}$	60%	30
		Test B: 15 unique PRI values randomly selected within the range of 518-3066 μsec, with a minimum increment of 1 μsec, excluding PRI values selected in Test A			
2	1-5	150-230	23-29	60%	30
3	6-10	200-500	16-18	60%	30
4	11-20	200-500	12-16	60%	30
Aggregate (Radar Types 1-4)				80%	120
Note 1: Short Pulse Radar Type 0 should be used for the detection bandwidth test, channel move time, and channel closing time tests.					

A minimum of 30 unique waveforms are required for each of the Short Pulse Radar Types 2 through 4. If more than 30 waveforms are used for Short Pulse Radar Types 2 through 4, then each additional waveform must also be unique and not repeated from the previous waveforms. If more than 30 waveforms are used for Short Pulse Radar Type 1, then each additional waveform is generated with Test B and must also be unique and not repeated from the previous waveforms in Tests A or B.

For example if in Short Pulse Radar Type 1 Test B a PRI of 3066 μsec is selected, the number of pulses

would be  $6 \cdot 1 \cdot 19 \cdot 10 \cdot \text{Roundup} \left\{ \left( \frac{1}{360} \right) \cdot \left( \frac{19 \cdot 10^6}{3066} \right) \right\} \text{Round up } \{17.2\} = 18.$



Report No.: XEWA2310000070RG05  
 Rev.: 01  
 Page: 23 of 267

**Table 5a - Pulse Repetition Intervals Values for Test A**

Pulse Repetition Frequency Number	Pulse Repetition Frequency (Pulses Per Second)	Pulse Repetition Interval (Microseconds)
1	1930.5	518
2	1858.7	538
3	1792.1	558
4	1730.1	578
5	1672.2	598
6	1618.1	618
7	1567.4	638
8	1519.8	658
9	1474.9	678
10	1432.7	698
11	1392.8	718
12	1355	738
13	1319.3	758
14	1285.3	778
15	1253.1	798
16	1222.5	818
17	1193.3	838
18	1165.6	858
19	1139	878
20	1113.6	898
21	1089.3	918
22	1066.1	938
23	326.2	3066

The aggregate is the average of the percentage of successful detections of Short Pulse Radar Types 1-4. For example, the following table indicates how to compute the aggregate of percentage of successful detections.

Radar Type	Number of Trials	Number of Successful Detections	Minimum Percentage of Successful Detection
1	35	29	82.9%
2	30	18	60%
3	30	27	90%
4	50	44	88%
Aggregate (82.9% + 60% + 90% + 88%)/4 = 80.2%			



Unless otherwise agreed in writing, this document is issued by the Company subject to its General Conditions of Service printed overleaf, available on request or accessible at <http://www.sgs.com/en/Terms-and-Conditions.aspx> and, for electronic format documents, subject to Terms and Conditions for Electronic Documents at <http://www.sgs.com/en/Terms-and-Conditions/Terms-e-Documents.aspx>. Attention is drawn to the limitation of liability, indemnification and jurisdiction issues defined therein. Any holder of this document is advised that information contained herein reflects the Company's findings at the time of its intervention only and within the limits of Client's instructions, if any. The Company's sole responsibility is to its Client and this document does not exonerate parties to a transaction from exercising all their rights and obligations under the transaction documents. This document cannot be reproduced except in full, without prior written approval of the Company. Any unauthorized alteration, forgery or falsification of the content or appearance of this document is unlawful and offenders may be prosecuted to the fullest extent of the law. Unless otherwise stated the results shown in this test report refer only to the sample(s) tested and such sample(s) are retained for 30 days only.  
 Attention: To check the authenticity of testing/inspection report & certificate, please contact us at telephone: (86-755) 4307 1443, or email: [CN.Doccheck@sgs.com](mailto:CN.Doccheck@sgs.com)  
 (SGS-CSTC) Standards Technical Services (Xi'an) Co., Ltd. | (86-29) 6282 7885 | www.sgs.com.cn  
 中国·西安·沣东新城科园三路137号康鸿楼方科技园1号楼D单元1层 | 邮编: 710086 | (86-29) 6282 7885 | sgs.china@sgs.com

**4.1.14 Long Pulse Radar Test Waveform**

Radar Type	Pulse Width (µsec)	Chirp Width (MHz)	PRI (µsec)	Number of Pulses per Burst	Number of Bursts	Minimum Percentage of Successful Detection	Minimum Number of Trials
5	50-100	5-20	1000-2000	1-3	8-20	80%	30

Each waveform is defined as follows:

- 1) The transmission period for the Long Pulse Radar test signal is 12 seconds.
- 2) There are a total of 8 to 20 Bursts in the 12 second period, with the number of Bursts being randomly chosen. This number is Burst Count.
- 3) Each Burst consists of 1 to 3 pulses, with the number of pulses being randomly chosen. Each Burst within the 12 second sequence may have a different number of pulses.
- 4) The pulse width is between 50 and 100 microseconds, with the pulse width being randomly chosen. Each pulse within a Burst will have the same pulse width. Pulses in different Bursts may have different pulse widths.
- 5) Each pulse has a linear frequency modulated chirp between 5 and 20 MHz, with the chirp width being randomly chosen. Each pulse within a transmission period will have the same chirp width. The chirp is centered on the pulse. For example, with a radar frequency of 5300 MHz and a 20 MHz chirped signal, the chirp starts at 5290 MHz and ends at 5310 MHz.
- 6) If more than one pulse is present in a Burst, the time between the pulses will be between 1000 and 2000 microseconds, with the time being randomly chosen. If three pulses are present in a Burst, the random time interval between the first and second pulses is chosen independently of the random time interval between the second and third pulses.
- 7) The 12 second transmission period is divided into even intervals. The number of intervals is equal to Burst Count. Each interval is of length  $(12,000,000 / \text{Burst Count})$  microseconds. Each interval contains one Burst. The start time for the Burst, relative to the beginning of the interval, is between 1 and  $[(12,000,000 / \text{Burst Count}) - (\text{Total Burst Length}) + (\text{One Random PRI Interval})]$  microseconds, with the start time being randomly chosen. The step interval for the start time is 1 microsecond. The start time for each Burst is chosen randomly.

**4.1.15 Frequency Hopping Radar Test Waveform**

Radar Type	Pulse Width (µsec)	Chirp Width (MHz)	PRI (µsec)	Number of Pulses per Burst	Number of Bursts	Minimum Percentage of Successful Detection	Minimum Number of Trials
6	1	333	9	0.333	300	70%	30

For the Frequency Hopping Radar Type, the same Burst parameters are used for each waveform. The hopping sequence is different for each waveform and a 100-length segment is selected from the hopping sequence defined by the following algorithm: If a segment does not contain at least 1 frequency within the U-NII Detection Bandwidth of the UUT, then that segment is not used.

The detailed test data see: **Appendix**





Report No.: XEWA2310000070RG05  
 Rev.: 01  
 Page: 25 of 267

## 5 Measurement Uncertainty (95% confidence levels, k=2)

No.	Item	Measurement Uncertainty
1	Radio Frequency	$\pm 7.25 \times 10^{-8}$ GHz
Remark: The $U_{lab}$ (lab Uncertainty) is less than $U_{CISPR/ETSI}$ (CISPR/ETSI Uncertainty), so the test results – compliance is deemed to occur if no measured disturbance level exceeds the disturbance limit; – non-compliance is deemed to occur if any measured disturbance level exceeds the disturbance limit.		



Unless otherwise agreed in writing, this document is issued by the Company subject to its General Conditions of Service printed overleaf, available on request or accessible at <http://www.sgs.com/en/Terms-and-Conditions.aspx> and, for electronic format documents, subject to Terms and Conditions for Electronic Documents at <http://www.sgs.com/en/Terms-and-Conditions/Terms-e-Documents.aspx>. Attention is drawn to the limitation of liability, indemnification and jurisdiction issues defined therein. Any holder of this document is advised that information contained herein reflects the Company's findings at the time of its intervention only and within the limits of Client's instructions, if any. The Company's sole responsibility is to its Client and this document does not exonerate parties to a transaction from exercising all their rights and obligations under the transaction documents. This document cannot be reproduced except in full, without prior written approval of the Company. Any unauthorized alteration, forgery or falsification of the content or appearance of this document is unlawful and offenders may be prosecuted to the fullest extent of the law. Unless otherwise stated the results shown in this test report refer only to the sample(s) tested and such sample(s) are retained for 30 days only.  
 Attention: To check the authenticity of testing/inspection report & certificate, please contact us at telephone: (86-755) 8307 1443, or email: CN.Doccheck@sgs.com

## 6 Equipment List

RF Test System					
Test Equipment	Manufacturer	Model No.	Inventory No.	Cal. date (yyyy/mm/dd)	Cal. Due date (yyyy/mm/dd)
MXA signal analyzer	Agilent	N9020A	XAW01-06-07	2023/02/16	2024/02/15
MXG vector signal Generator	Agilent	N5182B	XAW01-07-16	2023/02/16	2024/02/15
Measurement Software	Tonscend	JS1120-3 (3.2.18)	XAW02-14-01	NCR	NCR
RF control unit	Tonscend	JS0806-2	XAW03-37-01	NCR	NCR
Power Meter	Anritsu	ML2495A	XAW01-25-03	2023/08/30	2024/08/29
Power Supply	Agilent	66311B	XAW01-17-01	2023/02/16	2024/02/15
Temperature and humidity meter	MingGao	T809	XAW01-01-16	2023/09/04	2024/09/03



Unless otherwise agreed in writing, this document is issued by the Company subject to its General Conditions of Service printed overleaf, available on request or accessible at <http://www.sgs.com/en/Terms-and-Conditions.aspx> and, for electronic format documents, subject to Terms and Conditions for Electronic Documents at <http://www.sgs.com/en/Terms-and-Conditions/Terms-e-Document.aspx>. Attention is drawn to the limitation of liability, indemnification and jurisdiction issues defined therein. Any holder of this document is advised that information contained herein reflects the Company's findings at the time of its intervention only and within the limits of Client's instructions, if any. The Company's sole responsibility is to its Client and this document does not exonerate parties to a transaction from exercising all their rights and obligations under the transaction documents. This document cannot be reproduced except in full, without prior written approval of the Company. Any unauthorized alteration, forgery or falsification of the content or appearance of this document is unlawful and offenders may be prosecuted to the fullest extent of the law. Unless otherwise stated the results shown in this test report refer only to the sample(s) tested and such sample(s) are retained for 30 days only.

Report No.: XEWA2310000070RG05  
Rev.: 01  
Page: 27 of 267

## 7 Photographs - Setup Photos

Refer to Appendix A.2 WLAN Setup Photos.



Unless otherwise agreed in writing, this document is issued by the Company subject to its General Conditions of Service printed overleaf, available on request or accessible at <http://www.sgs.com/en/Terms-and-Conditions.aspx> and, for electronic format documents, subject to Terms and Conditions for Electronic Documents at <http://www.sgs.com/en/Terms-and-Conditions/Terms-e-Documents.aspx>. Attention is drawn to the limitation of liability, indemnification and jurisdiction issues defined therein. Any holder of this document is advised that information contained herein reflects the Company's findings at the time of its intervention only and within the limits of Client's instructions, if any. The Company's sole responsibility is to its Client and this document does not exonerate parties to a transaction from exercising all their rights and obligations under the transaction documents. This document cannot be reproduced except in full, without prior written approval of the Company. Any unauthorized alteration, forgery or falsification of the content or appearance of this document is unlawful and offenders may be prosecuted to the fullest extent of the law. Unless otherwise stated the results shown in this test report refer only to the sample(s) tested and such sample(s) are retained for 30 days only.

Attention: To check the authenticity of testing/inspection report & certificate, please contact us at telephone: (86-755) 8307 1443, or email: [CN.Doccheck@sgs.com](mailto:CN.Doccheck@sgs.com)

Report No.: XEWA2310000070RG05  
Rev.: 01  
Page: 28 of 267

# Appendix



Unless otherwise agreed in writing, this document is issued by the Company subject to its General Conditions of Service printed overleaf, available on request or accessible at <http://www.sgs.com/en/Terms-and-Conditions.aspx> and, for electronic format documents, subject to Terms and Conditions for Electronic Documents at <http://www.sgs.com/en/Terms-and-Conditions/Terms-e-Documents.aspx>. Attention is drawn to the limitation of liability, indemnification and jurisdiction issues defined therein. Any holder of this document is advised that information contained herein reflects the Company's findings at the time of its intervention only and within the limits of Client's instructions, if any. The Company's sole responsibility is to its Client and this document does not exonerate parties to a transaction from exercising all their rights and obligations under the transaction documents. This document cannot be reproduced except in full, without prior written approval of the Company. Any unauthorized alteration, forgery or falsification of the content or appearance of this document is unlawful and offenders may be prosecuted to the fullest extent of the law. Unless otherwise stated the results shown in this test report refer only to the sample(s) tested and such sample(s) are retained for 30 days only.  
Attention: To check the authenticity of testing/inspection report & certificate, please contact us at telephone: (86-755) 8307 1443, or email: [CN.Doccheck@sgs.com](mailto:CN.Doccheck@sgs.com)

Report No.: XEWA2310000070RG05  
 Rev.: 01  
 Page: 29 of 267

## DFS Detection Thresholds Test Result

TestMode	Frequency[dbm]	Radar Type	Result	Limit[dbm]	Verdict
11ac80MIMO	5530	Type0	-63.61	-63.40	PASS
		Type1	-63.42	-63.40	PASS
		Type2	-63.42	-63.40	PASS
		Type3	-63.80	-63.40	PASS
		Type4	-63.76	-63.40	PASS
		Type5	-63.82	-63.40	PASS
		Type6	-63.63	-63.40	PASS



Unless otherwise agreed in writing, this document is issued by the Company subject to its General Conditions of Service printed overleaf, available on request or accessible at <http://www.sgs.com/en/Terms-and-Conditions.aspx> and, for electronic format documents, subject to Terms and Conditions for Electronic Documents at <http://www.sgs.com/en/Terms-and-Conditions/Terms-e-Document.aspx>. Attention is drawn to the limitation of liability, indemnification and jurisdiction issues defined therein. Any holder of this document is advised that information contained herein reflects the Company's findings at the time of its intervention only and within the limits of Client's instructions, if any. The Company's sole responsibility is to its Client and this document does not exonerate parties to a transaction from exercising all their rights and obligations under the transaction documents. This document cannot be reproduced except in full, without prior written approval of the Company. Any unauthorized alteration, forgery or falsification of the content or appearance of this document is unlawful and offenders may be prosecuted to the fullest extent of the law. Unless otherwise stated the results shown in this test report refer only to the sample(s) tested and such sample(s) are retained for 30 days only.

Attention: To check the authenticity of testing/inspection report & certificate, please contact us at telephone: (86-755) 8307 1443, or email: [CN.Doccheck@sgs.com](mailto:CN.Doccheck@sgs.com)  
 (Xi'an Office) SGS-CSTC Standards Technical Services (Xi'an) Co., Ltd. | 1/E Unit D Building 1, Kanghong Orange Science Park, No.137, Keyuan 3rd Road, Fengdong New Town, Xi'an, Shaanxi, China | 710086 | t: (86-29) 6282 7885 | www.sgs.com.cn  
 中国·西安·沣东新城科园三路137号康鸿橙方科技园1号楼D单元1层 | 邮编: 710086 | t: (86-29) 6282 7885 | sgs.china@sgs.com

Test Graphs

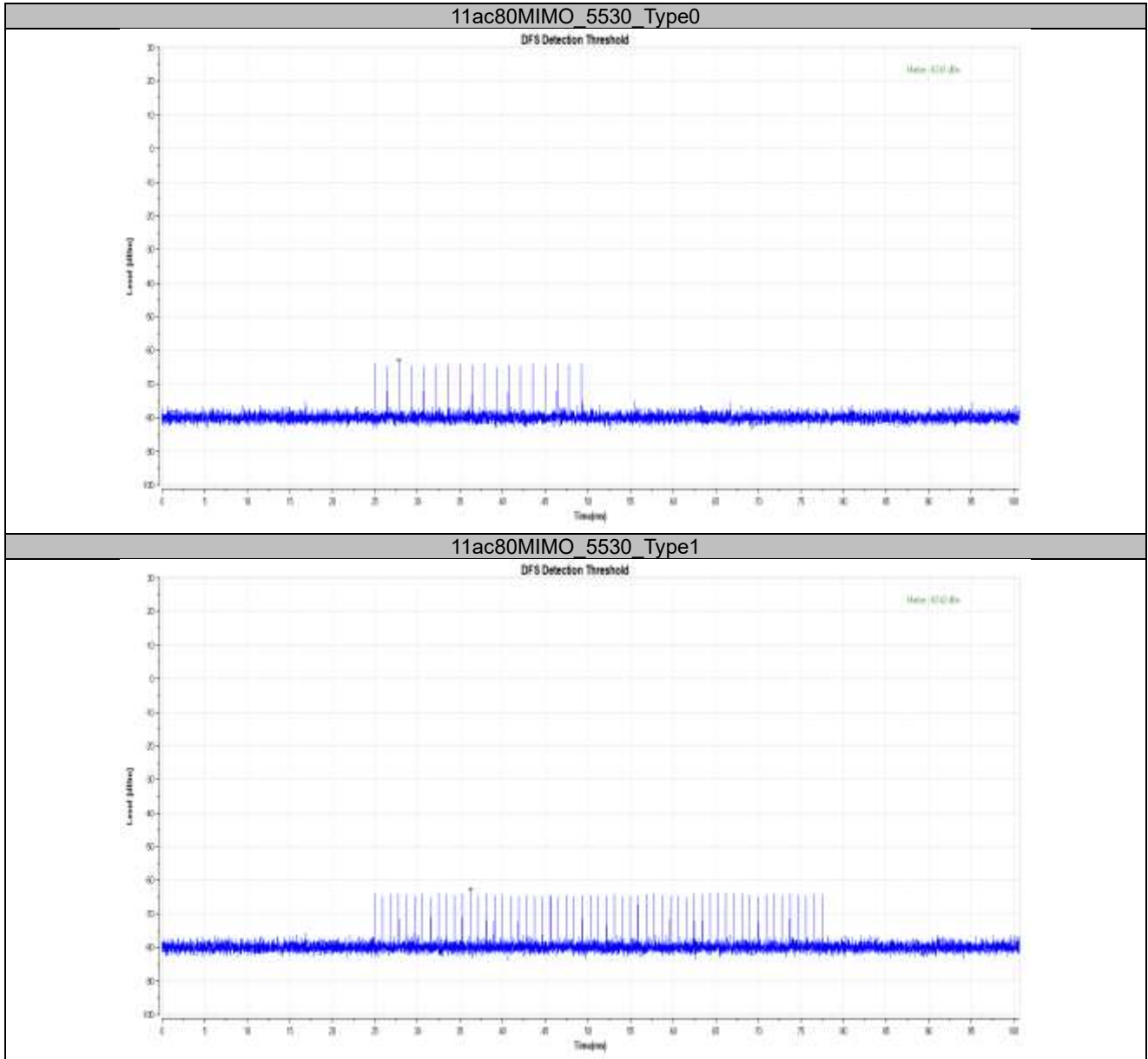

Unless otherwise agreed in writing, this document is issued by the Company subject to its General Conditions of Service printed overleaf, available on request or accessible at <http://www.sgs.com/en/Terms-and-Conditions.aspx> and, for electronic format documents, subject to Terms and Conditions for Electronic Documents at <http://www.sgs.com/en/Terms-and-Conditions/Terms-e-Document.aspx>. Attention is drawn to the limitation of liability, indemnification and jurisdiction issues defined therein. Any holder of this document is advised that information contained herein reflects the Company's findings at the time of its intervention only and within the limits of Client's instructions, if any. The Company's sole responsibility is to its Client and this document does not exonerate parties to a transaction from exercising all their rights and obligations under the transaction documents. This document cannot be reproduced except in full, without prior written approval of the Company. Any unauthorized alteration, forgery or falsification of the content or appearance of this document is unlawful and offenders may be prosecuted to the fullest extent of the law. Unless otherwise stated the results shown in this test report refer only to the sample(s) tested and such sample(s) are retained for 30 days only.

Attention: To check the authenticity of testing/inspection report & certificate, please contact us at telephone: (86-755) 8307 1443, or email: [CN.Doccheck@sgs.com](mailto:CN.Doccheck@sgs.com)  
 (X'ian Office) SGS-CSTC Standards Technical Services (Xi'an) Co., Ltd. | WE Unit D Building 1, Kanghong Orange Science Park, No.137, Keyuan 3rd Road, Fengling New Town, Xi'an, Shaanxi, China | 710086 | t (86-29) 6282 7885 | www.sgs.com.cn  
 中国·西安·沣东新城科园三路137号康鸿橙方科技园1号楼D单元1层 | 邮编: 710086 | t (86-29) 6282 7885 | sgs.china@sgs.com

11ac80MIMO\_5530\_Type2

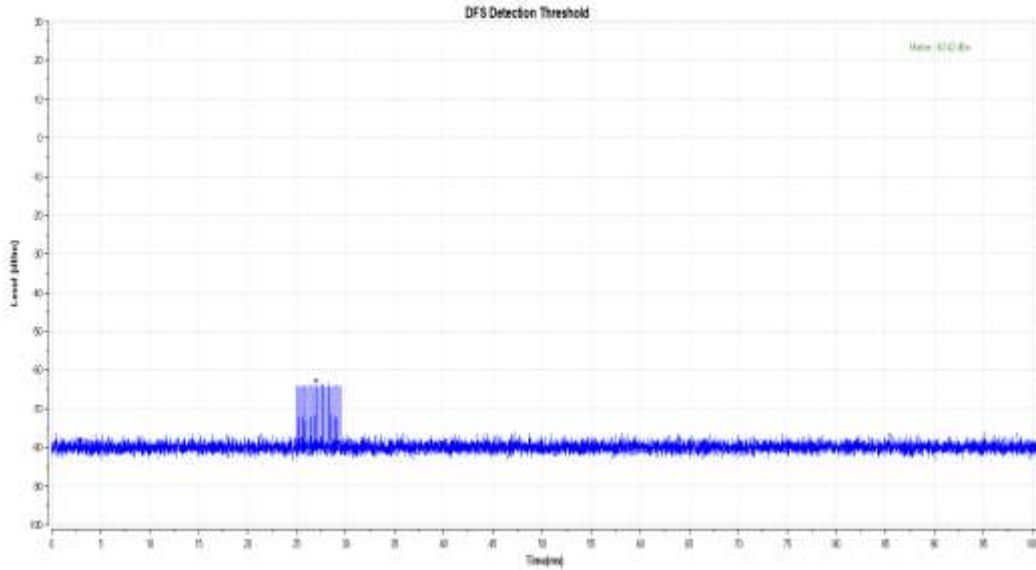

11ac80MIMO\_5530\_Type3

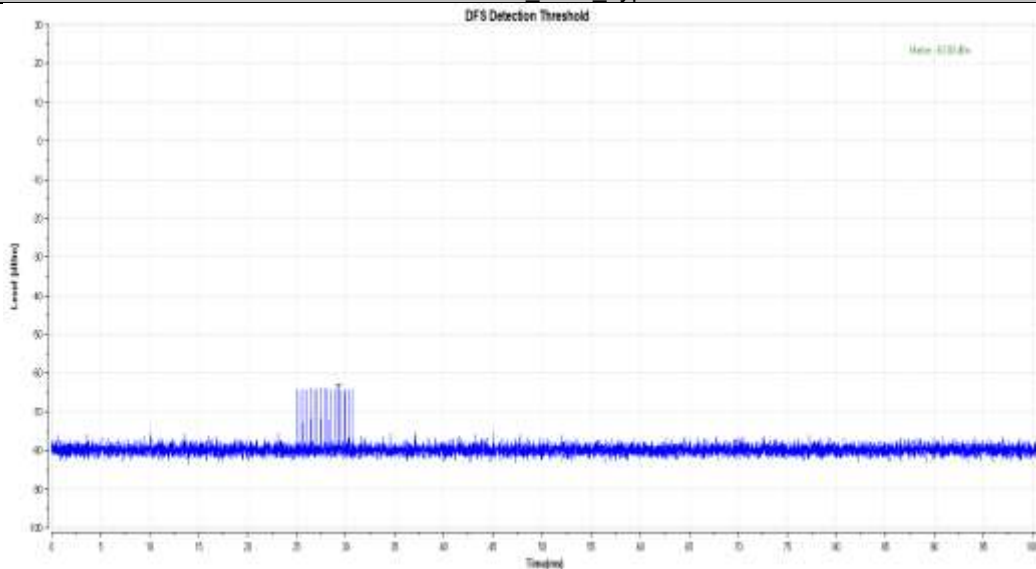

Unless otherwise agreed in writing, this document is issued by the Company subject to its General Conditions of Service printed overleaf, available on request or accessible at <http://www.sgs.com/en/Terms-and-Conditions.aspx> and, for electronic format documents, subject to Terms and Conditions for Electronic Documents at <http://www.sgs.com/en/Terms-and-Conditions/Terms-e-Documents.aspx>. Attention is drawn to the limitation of liability, indemnification and jurisdiction issues defined therein. Any holder of this document is advised that information contained herein reflects the Company's findings at the time of its intervention only and within the limits of Client's instructions, if any. The Company's sole responsibility is to its Client and this document does not exonerate parties to a transaction from exercising all their rights and obligations under the transaction documents. This document cannot be reproduced except in full, without prior written approval of the Company. Any unauthorized alteration, forgery or falsification of the content or appearance of this document is unlawful and offenders may be prosecuted to the fullest extent of the law. Unless otherwise stated the results shown in this test report refer only to the sample(s) tested and such sample(s) are retained for 30 days only.

Attention: To check the authenticity of testing/inspection report & certificate, please contact us at telephone: (86-755) 4307 1443, or email: [CN.Doccheck@sgs.com](mailto:CN.Doccheck@sgs.com)

11ac80MIMO\_5530\_Type4

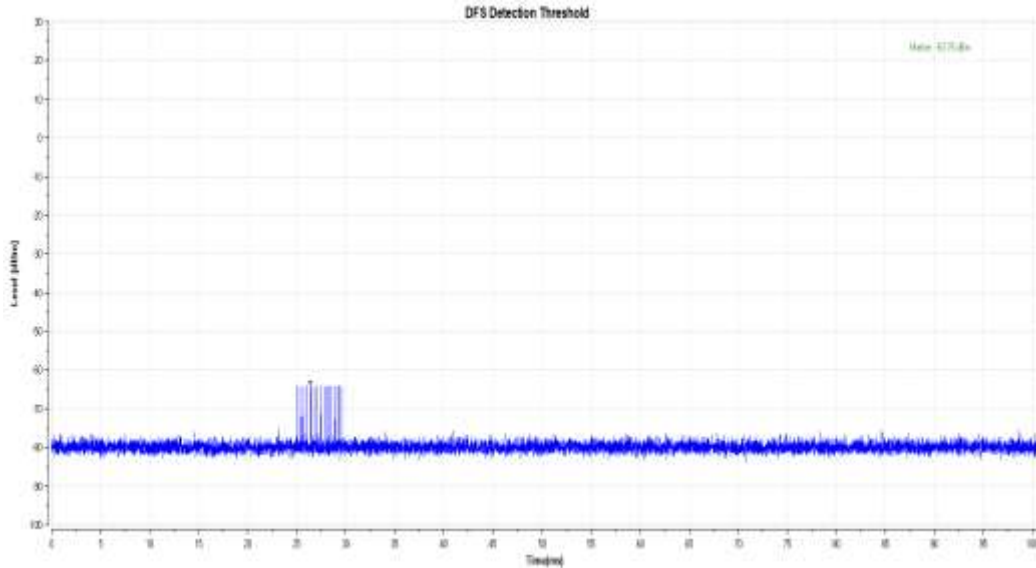

11ac80MIMO\_5530\_Type5

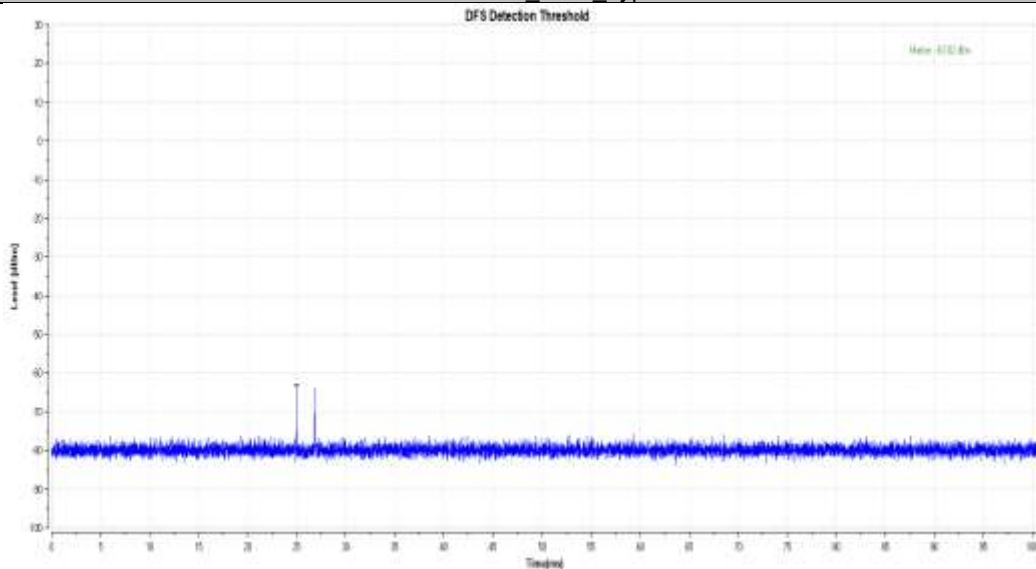

Unless otherwise agreed in writing, this document is issued by the Company subject to its General Conditions of Service printed overleaf, available on request or accessible at <http://www.sgs.com/en/Terms-and-Conditions.aspx> and, for electronic format documents, subject to Terms and Conditions for Electronic Documents at <http://www.sgs.com/en/Terms-and-Conditions/Terms-e-Documents.aspx>. Attention is drawn to the limitation of liability, indemnification and jurisdiction issues defined therein. Any holder of this document is advised that information contained herein reflects the Company's findings at the time of its intervention only and within the limits of Client's instructions, if any. The Company's sole responsibility is to its Client and this document does not exonerate parties to a transaction from exercising all their rights and obligations under the transaction documents. This document cannot be reproduced except in full, without prior written approval of the Company. Any unauthorized alteration, forgery or falsification of the content or appearance of this document is unlawful and offenders may be prosecuted to the fullest extent of the law. Unless otherwise stated the results shown in this test report refer only to the sample(s) tested and such sample(s) are retained for 30 days only.

Attention: To check the authenticity of testing/inspection report & certificate, please contact us at telephone: (86-755) 8307 1443, or email: [CN.Doccheck@sgs.com](mailto:CN.Doccheck@sgs.com)  
 (X'ian) Unit D, Building 1, Kanghong Orange Science Park, No.137, Keyuan3rd Road, Fengping New Town, Xi'an, Shaanxi, China 710086  
 t (86-29) 6282 7885 www.sgs.com.cn  
 中国·西安·沣东新城科园三路137号康鸿橙方科技园1号楼D单元1层 邮编: 710086 t (86-29) 6282 7885 sgs.china@sgs.com



Report No.: XEWA2310000070RG05

Rev.: 01

Page: 33 of 267

11ac80MIMO 5530 Type6

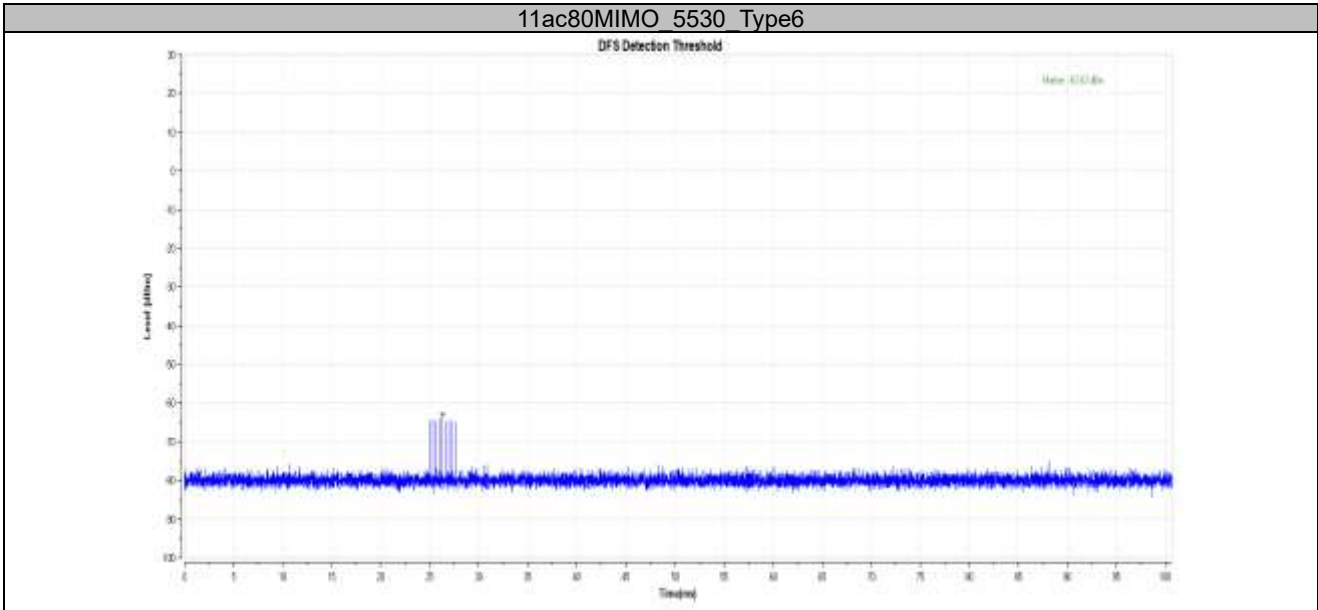

Unless otherwise agreed in writing, this document is issued by the Company subject to its General Conditions of Service printed overleaf, available on request or accessible at <http://www.sgs.com/en/Terms-and-Conditions.aspx> and, for electronic format documents, subject to Terms and Conditions for Electronic Documents at <http://www.sgs.com/en/Terms-and-Conditions/Terms-e-Document.aspx>. Attention is drawn to the limitation of liability, indemnification and jurisdiction issues defined therein. Any holder of this document is advised that information contained herein reflects the Company's findings at the time of its intervention only and within the limits of Client's instructions, if any. The Company's sole responsibility is to its Client and this document does not exonerate parties to a transaction from exercising all their rights and obligations under the transaction documents. This document cannot be reproduced except in full, without prior written approval of the Company. Any unauthorized alteration, forgery or falsification of the content or appearance of this document is unlawful and offenders may be prosecuted to the fullest extent of the law. Unless otherwise stated the results shown in this test report refer only to the sample(s) tested and such sample(s) are retained for 30 days only.

Attention: To check the authenticity of testing/inspection report & certificate, please contact us at telephone: (86-755) 8307 1443, or email: [CN.Doccheck@sgs.com](mailto:CN.Doccheck@sgs.com)

SGS-CSTC Standards Technical Services (Xi'an) Co., Ltd.	WE Unit D Building 1, Kanglong Orange Science Park, No.137, Keyuan 3rd Road, Fengling New Town, Xi'an, Shaanxi, China	710086	t (86-29) 6282 7885	<a href="http://www.sgs.com">www.sgs.com</a>
<a href="http://www.sgs.com">www.sgs.com</a>	中国·西安·沣东新城科园三路137号康鸿橙方科技园1号楼D单元1层	邮编: 710086	t (86-29) 6282 7885	<a href="mailto:sgs.china@sgs.com">sgs.china@sgs.com</a>

Report No.: XEWA2310000070RG05  
 Rev.: 01  
 Page: 34 of 267

### Channel Loading Test Result

TestMode	Frequency[MHz]	Result	Limit [%]	Verdict
11ac80MIMO	5530	37.41	17	PASS

### Test Graphs

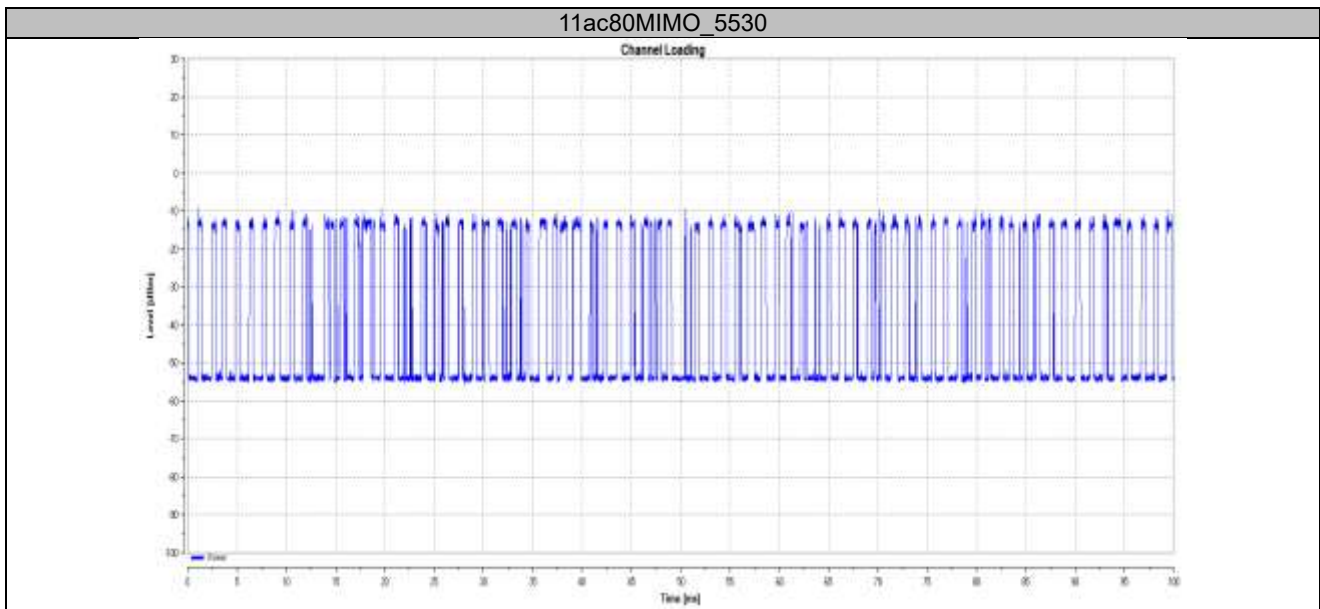

Unless otherwise agreed in writing, this document is issued by the Company subject to its General Conditions of Service printed overleaf, available on request or accessible at <http://www.sgs.com/en/Terms-and-Conditions.aspx> and, for electronic format documents, subject to Terms and Conditions for Electronic Documents at <http://www.sgs.com/en/Terms-and-Conditions/Terms-e-Document.aspx>. Attention is drawn to the limitation of liability, indemnification and jurisdiction issues defined therein. Any holder of this document is advised that information contained herein reflects the Company's findings at the time of its intervention only and within the limits of Client's instructions, if any. The Company's sole responsibility is to its Client and this document does not exonerate parties to a transaction from exercising all their rights and obligations under the transaction documents. This document cannot be reproduced except in full, without prior written approval of the Company. Any unauthorized alteration, forgery or falsification of the content or appearance of this document is unlawful and offenders may be prosecuted to the fullest extent of the law. Unless otherwise stated the results shown in this test report refer only to the sample(s) tested and such sample(s) are retained for 30 days only.

Report No.: XEWA2310000070RG05  
 Rev.: 01  
 Page: 35 of 267

## Channel Availability Check Time Test Result

TestMode	Frequency[MHz]	Initial CAC	Verdict
11ac80MIMO	5530	See test Graph	PASS

TestMode	Frequency[MHz]	Beginning CAC	Verdict
11ac80MIMO	5530	See test Graph	PASS

  

TestMode	Frequency[MHz]	End CAC	Verdict
11ac80MIMO	5530	See test Graph	PASS



Unless otherwise agreed in writing, this document is issued by the Company subject to its General Conditions of Service printed overleaf, available on request or accessible at <http://www.sgs.com/en/Terms-and-Conditions.aspx> and, for electronic format documents, subject to Terms and Conditions for Electronic Documents at <http://www.sgs.com/en/Terms-and-Conditions/Terms-e-Documents.aspx>. Attention is drawn to the limitation of liability, indemnification and jurisdiction issues defined therein. Any holder of this document is advised that information contained herein reflects the Company's findings at the time of its intervention only and within the limits of Client's instructions, if any. The Company's sole responsibility is to its Client and this document does not exonerate parties to a transaction from exercising all their rights and obligations under the transaction documents. This document cannot be reproduced except in full, without prior written approval of the Company. Any unauthorized alteration, forgery or falsification of the content or appearance of this document is unlawful and offenders may be prosecuted to the fullest extent of the law. Unless otherwise stated the results shown in this test report refer only to the sample(s) tested and such sample(s) are retained for 30 days only.

Test Graphs

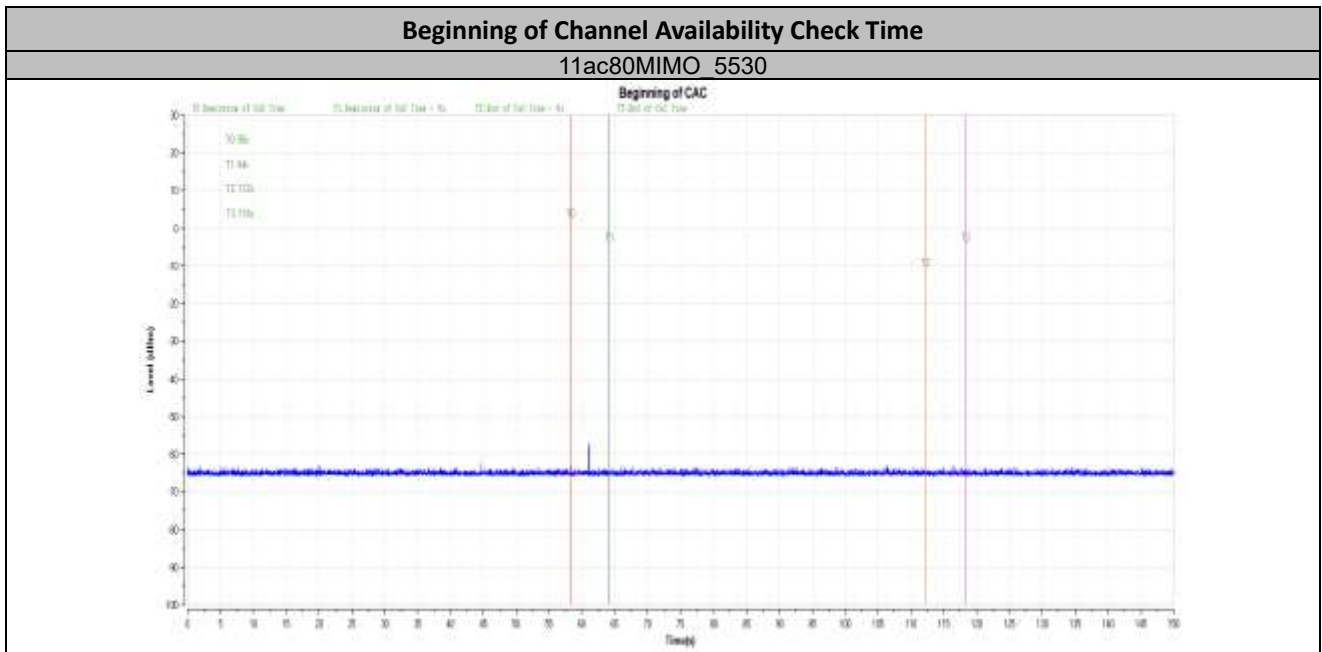
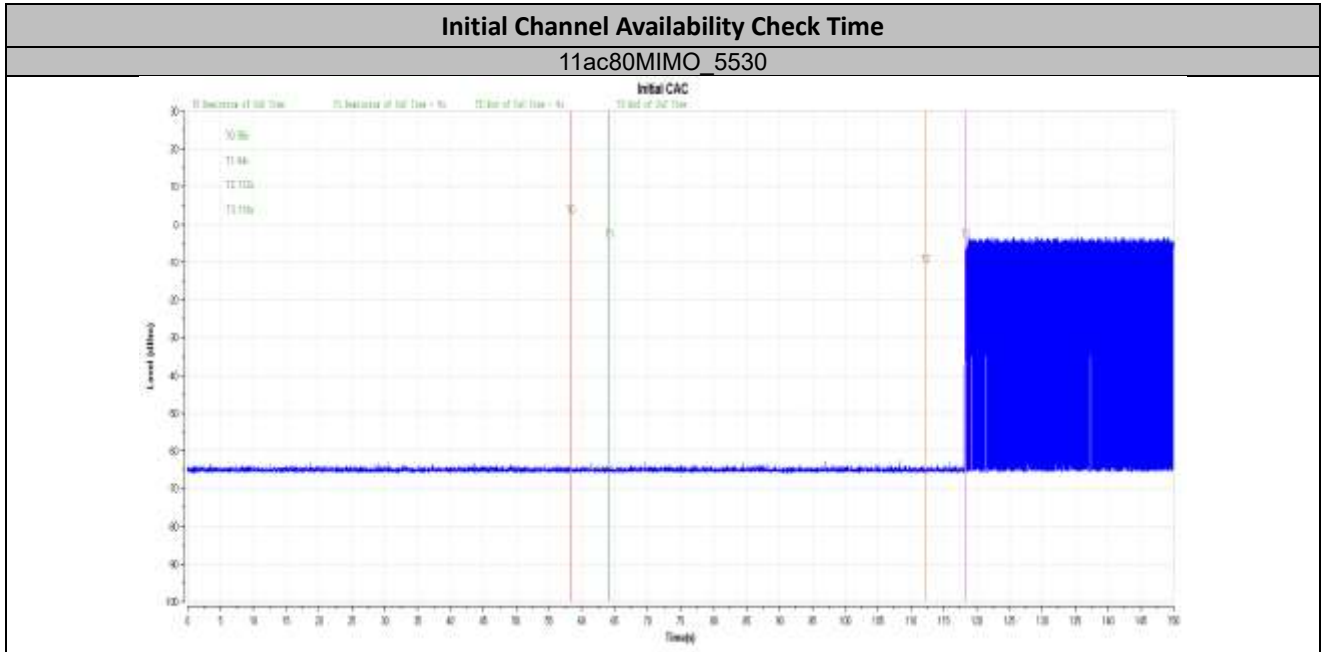

Unless otherwise agreed in writing, this document is issued by the Company subject to its General Conditions of Service printed overleaf, available on request or accessible at <http://www.sgs.com/en/Terms-and-Conditions.aspx> and, for electronic format documents, subject to Terms and Conditions for Electronic Documents at <http://www.sgs.com/en/Terms-and-Conditions/Terms-e-Document.aspx>. Attention is drawn to the limitation of liability, indemnification and jurisdiction issues defined therein. Any holder of this document is advised that information contained herein reflects the Company's findings at the time of its intervention only and within the limits of Client's instructions, if any. The Company's sole responsibility is to its Client and this document does not exonerate parties to a transaction from exercising all their rights and obligations under the transaction documents. This document cannot be reproduced except in full, without prior written approval of the Company. Any unauthorized alteration, forgery or falsification of the content or appearance of this document is unlawful and offenders may be prosecuted to the fullest extent of the law. Unless otherwise stated the results shown in this test report refer only to the sample(s) tested and such sample(s) are retained for 30 days only.

Attention: To check the authenticity of testing/inspection report & certificate, please contact us at telephone: (86-755) 8307 1443, or email: [CN.Doccheck@sgs.com](mailto:CN.Doccheck@sgs.com)  
 (X) Unit D, Building 1, Kanghong Orange Science Park, No.137, Keyuan 3rd Road, Fengjing New Town, Xi'an, Shaanxi, China 710086 t (86-29) 6282 7885 www.sgs.com.cn  
 中国·西安·沣东新城科园三路137号康鸿橙方科技园1号楼D单元1层 邮编: 710086 t (86-29) 6282 7885 sgs.china@sgs.com

End of Channel Availability Check Time

11ac80MIMO\_5530

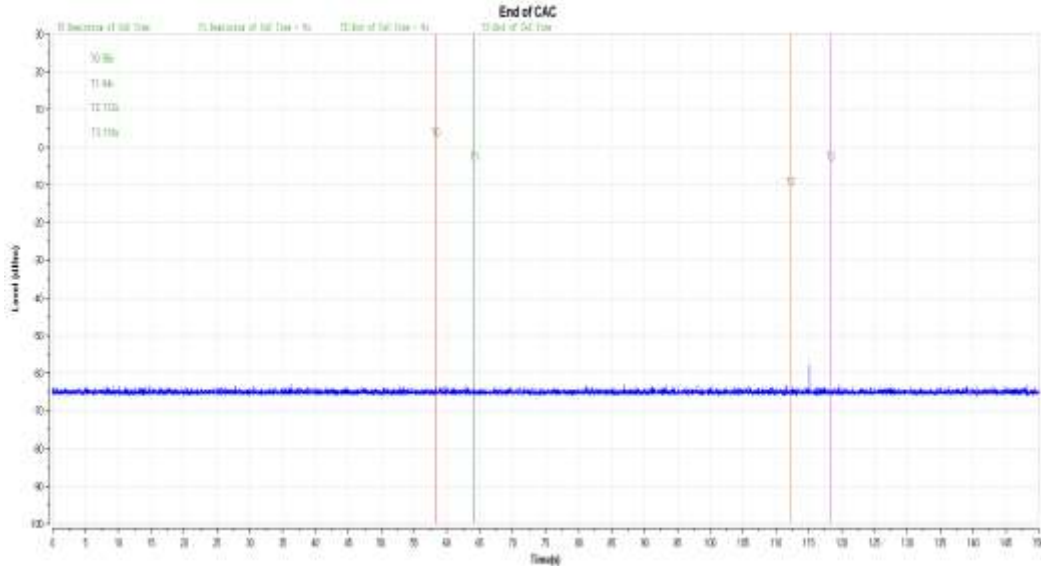

Unless otherwise agreed in writing, this document is issued by the Company subject to its General Conditions of Service printed overleaf, available on request or accessible at <http://www.sgs.com/en/Terms-and-Conditions.aspx> and, for electronic format documents, subject to Terms and Conditions for Electronic Documents at <http://www.sgs.com/en/Terms-and-Conditions/Terms-e-Documents.aspx>. Attention is drawn to the limitation of liability, indemnification and jurisdiction issues defined therein. Any holder of this document is advised that information contained herein reflects the Company's findings at the time of its intervention only and within the limits of Client's instructions, if any. The Company's sole responsibility is to its Client and this document does not exonerate parties to a transaction from exercising all their rights and obligations under the transaction documents. This document cannot be reproduced except in full, without prior written approval of the Company. Any unauthorized alteration, forgery or falsification of the content or appearance of this document is unlawful and offenders may be prosecuted to the fullest extent of the law. Unless otherwise stated the results shown in this test report refer only to the sample(s) tested and such sample(s) are retained for 30 days only.

Attention: To check the authenticity of testing/inspection report & certificate, please contact us at telephone: (86-755) 8307 1443, or email: [CN.Doccheck@sgs.com](mailto:CN.Doccheck@sgs.com)  
 (X'ian Unit) SGS-CSTC Standards Technical Services (Xi'an) Co., Ltd. | (X'ian Unit) SGS-CSTC Standards Technical Services (Xi'an) Co., Ltd. | 710086 | t (86-29) 6282 7885 | www.sgs.com.cn  
 中国·西安·沣东新城科星三路137号康鸿楼方科技园1号楼D单元1层 | 邮编: 710086 | t (86-29) 6282 7885 | sgs.china@sgs.com

Report No.: XEWA2310000070RG05  
 Rev.: 01  
 Page: 38 of 267

### Channel Move Time and Channel Closing Transmission Time Test Result

TestMode	Frequency[MHz]	CCTT[ms]	Limit[ms]	CMT[ms]	Limit[ms]	Verdict
11ac80MIMO	5530	200+10.4	200+60	889.2	10000	PASS

### Test Graphs

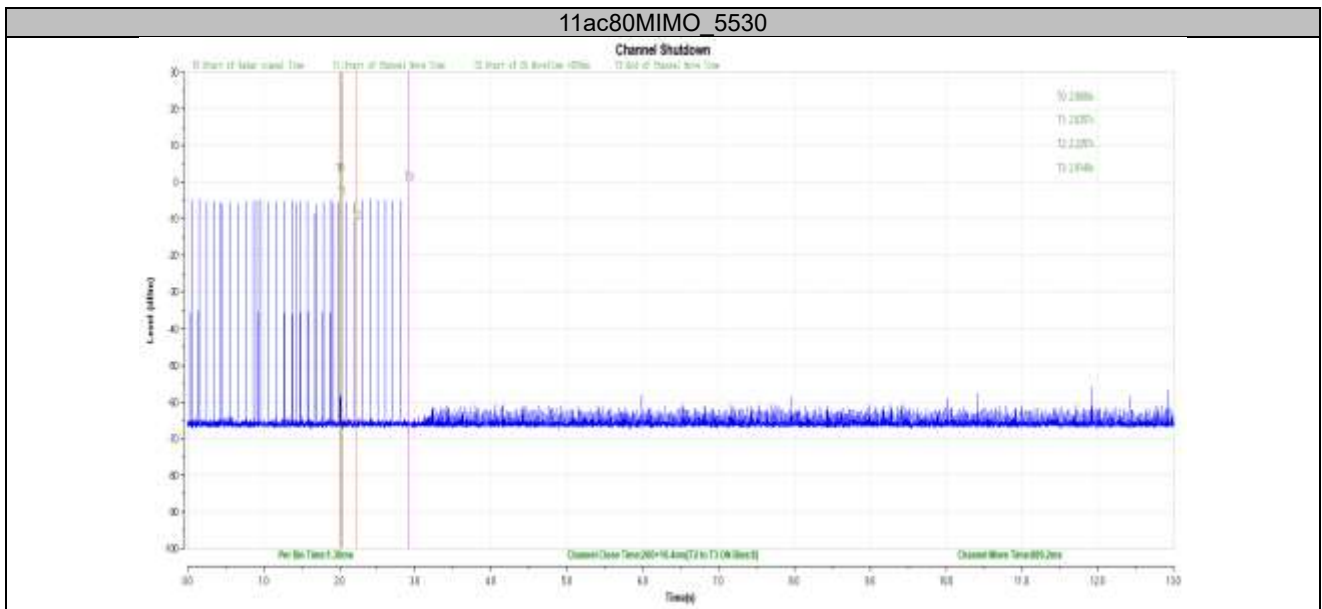

Unless otherwise agreed in writing, this document is issued by the Company subject to its General Conditions of Service printed overleaf, available on request or accessible at <http://www.sgs.com/en/Terms-and-Conditions.aspx> and, for electronic format documents, subject to Terms and Conditions for Electronic Documents at <http://www.sgs.com/en/Terms-and-Conditions/Terms-e-Documents.aspx>. Attention is drawn to the limitation of liability, indemnification and jurisdiction issues defined therein. Any holder of this document is advised that information contained herein reflects the Company's findings at the time of its intervention only and within the limits of Client's instructions, if any. The Company's sole responsibility is to its Client and this document does not exonerate parties to a transaction from exercising all their rights and obligations under the transaction documents. This document cannot be reproduced except in full, without prior written approval of the Company. Any unauthorized alteration, forgery or falsification of the content or appearance of this document is unlawful and offenders may be prosecuted to the fullest extent of the law. Unless otherwise stated the results shown in this test report refer only to the sample(s) tested and such sample(s) are retained for 30 days only.

Attention: To check the authenticity of testing/inspection report & certificate, please contact us at telephone: (86-755) 8307 1443, or email: CN.Doccheck@sgs.com

SGS-CSTC Standards Technical Services (Xi'an) Co., Ltd. | WE Unit D Building 1, Kanghong Orange Science Park, No.137, Keyuan 3rd Road, Fengling New Town, Xi'an, Shaanxi, China | 710086 | t (86-29) 6282 7885 | www.sgs.com.cn  
 中国·西安·沣东新城科园三路137号康鸿橙方科技园1号楼D单元1层 | 邮编: 710086 | t (86-29) 6282 7885 | sgs.china@sgs.com

Report No.: XEWA2310000070RG05  
 Rev.: 01  
 Page: 39 of 267

### Non-Occupancy Period

#### Test Result

TestMode	Frequency[MHz]	Result	Limit[s]	Verdict
11ac80MIMO	5530	see test graph	≥1800	PASS

#### Test Graphs

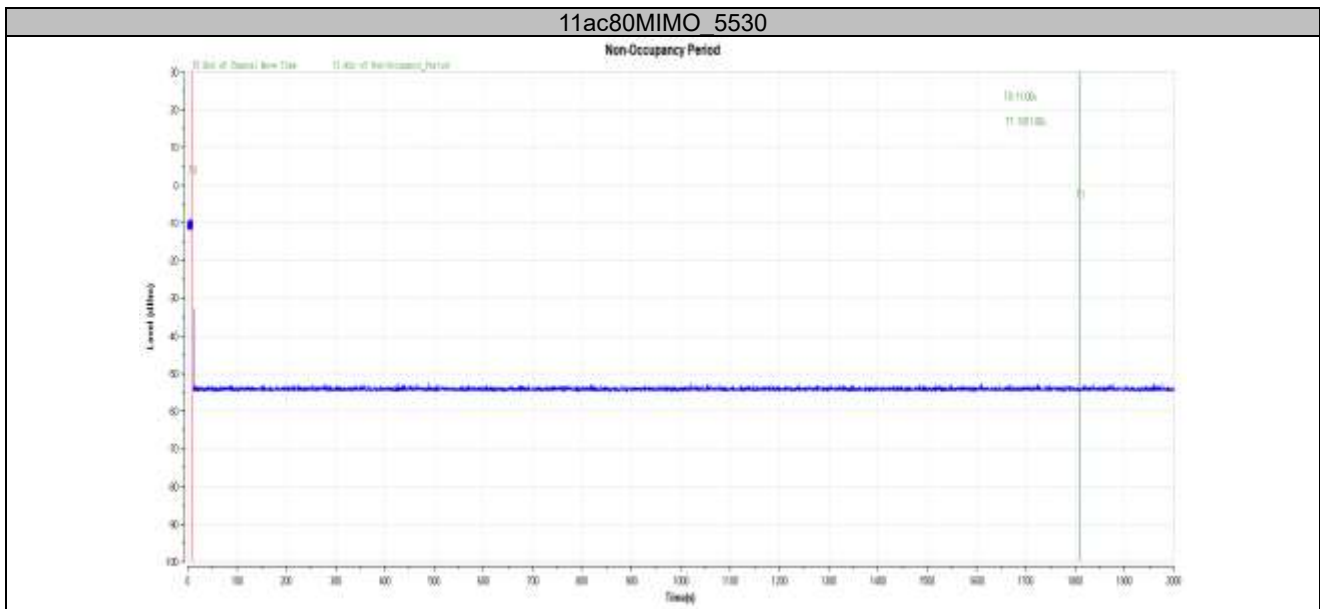

Unless otherwise agreed in writing, this document is issued by the Company subject to its General Conditions of Service printed overleaf, available on request or accessible at <http://www.sgs.com/en/Terms-and-Conditions.aspx> and, for electronic format documents, subject to Terms and Conditions for Electronic Documents at <http://www.sgs.com/en/Terms-and-Conditions/Terms-e-Documents.aspx>. Attention is drawn to the limitation of liability, indemnification and jurisdiction issues defined therein. Any holder of this document is advised that information contained herein reflects the Company's findings at the time of its intervention only and within the limits of Client's instructions, if any. The Company's sole responsibility is to its Client and this document does not exonerate parties to a transaction from exercising all their rights and obligations under the transaction documents. This document cannot be reproduced except in full, without prior written approval of the Company. Any unauthorized alteration, forgery or falsification of the content or appearance of this document is unlawful and offenders may be prosecuted to the fullest extent of the law. Unless otherwise stated the results shown in this test report refer only to the sample(s) tested and such sample(s) are retained for 30 days only.

Attention: To check the authenticity of testing/inspection report & certificate, please contact us at telephone: (86-755) 4307 1443, or email: [CN.Doccheck@sgs.com](mailto:CN.Doccheck@sgs.com)

SGS-CSTC Standards Technical Services (Xi'an) Co., Ltd. | WE Unit D Building 1, Kanghong Orange Science Park, No.137, Keyuan 3rd Road, Fengdong New Town, Xi'an, Shaanxi, China | 710086 | t (86-29) 6282 7885 | www.sgs.com.cn  
 中国·西安·沣东新城科园三路137号康鸿橙方科技园1号楼D单元1层 | 邮编: 710086 | t (86-29) 6282 7885 | sgs.china@sgs.com

### U-NII Detection Bandwidth

#### Test Result

TestMode	Frequency[MHz]	FL[MHz]	FH[MHz]	Detection Bandwidth [MHz]	OCB [MHz]	Ratio [%]	Limit [%]	Verdict
11ac20MIMO	5500	5490	5510	20	15.395	129.91	≥100	PASS
11ac40MIMO	5510	5490	5530	40	34.821	114.87	≥100	PASS
11ac80MIMO	5530	5490	5570	80	75.820	105.51	≥100	PASS

Test Mode	Frequency[MHz]	Radar Freq.	Trial 1	Trial 2	Trial 3	Trial 4	Trial 5	Trial 6	Trial 7	Trial 8	Trial 9	Trial 10	Ratio (%)	
11ac20MIMO	5500	5489	0	0	0	0	0	0	0	0	0	0	0	
		5490	1	1	1	1	1	1	1	1	1	1	100	
		5495	1	1	1	1	1	1	1	1	1	1	1	100
		5500	1	1	1	1	1	1	1	1	1	1	1	100
		5505	1	1	1	1	1	1	1	1	1	1	1	100
		5510	1	1	1	1	1	1	1	1	1	1	1	100
11ac40MIMO	5510	5511	0	0	0	0	0	0	0	0	0	0	0	
		5489	0	0	0	0	0	0	0	0	0	0	0	
		5490	1	1	1	1	1	1	1	1	1	1	1	100
		5495	1	1	1	1	1	1	1	1	1	1	1	100
		5500	1	1	1	1	1	1	1	1	1	1	1	100
		5505	1	1	1	1	1	1	1	1	1	1	1	100
		5510	1	1	1	1	1	1	1	1	1	1	1	100
		5515	1	1	1	1	1	1	1	1	1	1	1	100
		5520	1	1	1	1	1	1	1	1	1	1	1	100
		5525	1	1	1	1	1	1	1	1	1	1	1	100
11ac80MIMO	5530	5530	1	1	1	1	1	1	1	1	1	1	1	100
		5531	0	0	0	0	0	0	0	0	0	0	0	0
		5489	0	0	0	0	0	0	0	0	0	0	0	0
		5490	1	1	1	1	1	1	1	1	1	1	1	100
		5495	1	1	1	1	1	1	1	1	1	1	1	100
		5500	1	1	1	1	1	1	1	1	1	1	1	100
		5505	1	1	1	1	1	1	1	1	1	1	1	100
		5510	1	1	1	1	1	1	1	1	1	1	1	100
		5515	1	1	1	1	1	1	1	1	1	1	1	100
		5520	1	1	1	1	1	1	1	1	1	1	1	100
		5525	1	1	1	1	1	1	1	1	1	1	1	100
		5530	1	1	1	1	1	1	1	1	1	1	1	100
		5535	1	1	1	1	1	1	1	1	1	1	1	100
		5540	1	1	1	1	1	1	1	1	1	1	1	100
		5545	1	1	1	1	1	1	1	1	1	1	1	100
		5550	1	1	1	1	1	1	1	1	1	1	1	100
		5555	1	1	1	1	1	1	1	1	1	1	1	100
5560	1	1	1	1	1	1	0	1	1	1	1	90		
5565	1	1	1	1	1	1	1	1	1	1	1	100		
5570	1	1	1	1	1	1	1	1	1	1	1	100		
5571	0	0	0	0	0	0	0	0	0	0	0	0		



Unless otherwise agreed in writing, this document is issued by the Company subject to its General Conditions of Service printed overleaf, available on request or accessible at <http://www.sgs.com/en/Terms-and-Conditions.aspx> and, for electronic format documents, subject to Terms and Conditions for Electronic Documents at <http://www.sgs.com/en/Terms-and-Conditions/Terms-e-Documents.aspx>. Attention is drawn to the limitation of liability, indemnification and jurisdiction issues defined therein. Any holder of this document is advised that information contained herein reflects the Company's findings at the time of its intervention only and within the limits of Client's instructions, if any. The Company's sole responsibility is to its Client and this document does not exonerate parties to a transaction from exercising all their rights and obligations under the transaction documents. This document cannot be reproduced except in full, without prior written approval of the Company. Any unauthorized alteration, forgery or falsification of the content or appearance of this document is unlawful and offenders may be prosecuted to the fullest extent of the law. Unless otherwise stated the results shown in this test report refer only to the sample(s) tested and such sample(s) are retained for 30 days only.

Attention: To check the authenticity of testing/inspection report & certificate, please contact us at telephone: (86-755) 8307 1443, or email: CN\_Doccheck@sgs.com

SGS-CSTC Standards Technical Services (Xi'an) Co., Ltd. | 1/E Unit D, Building 1, Kanglong Orange Science Park, No.157, Keyuan 3rd Road, Fengyang New Town, Xi'an, Shaanxi, China | 710086 | t (86-29) 6282 7885 | www.sgs.com.cn  
 中国·西安·沣东新城科园三路157号康隆橙方科技园1号楼D单元1层 | 邮编: 710086 | t (86-29) 6282 7885 | sgs.china@sgs.com



Report No.: XEWA2310000070RG05  
 Rev.: 01  
 Page: 41 of 267

Test Graphs

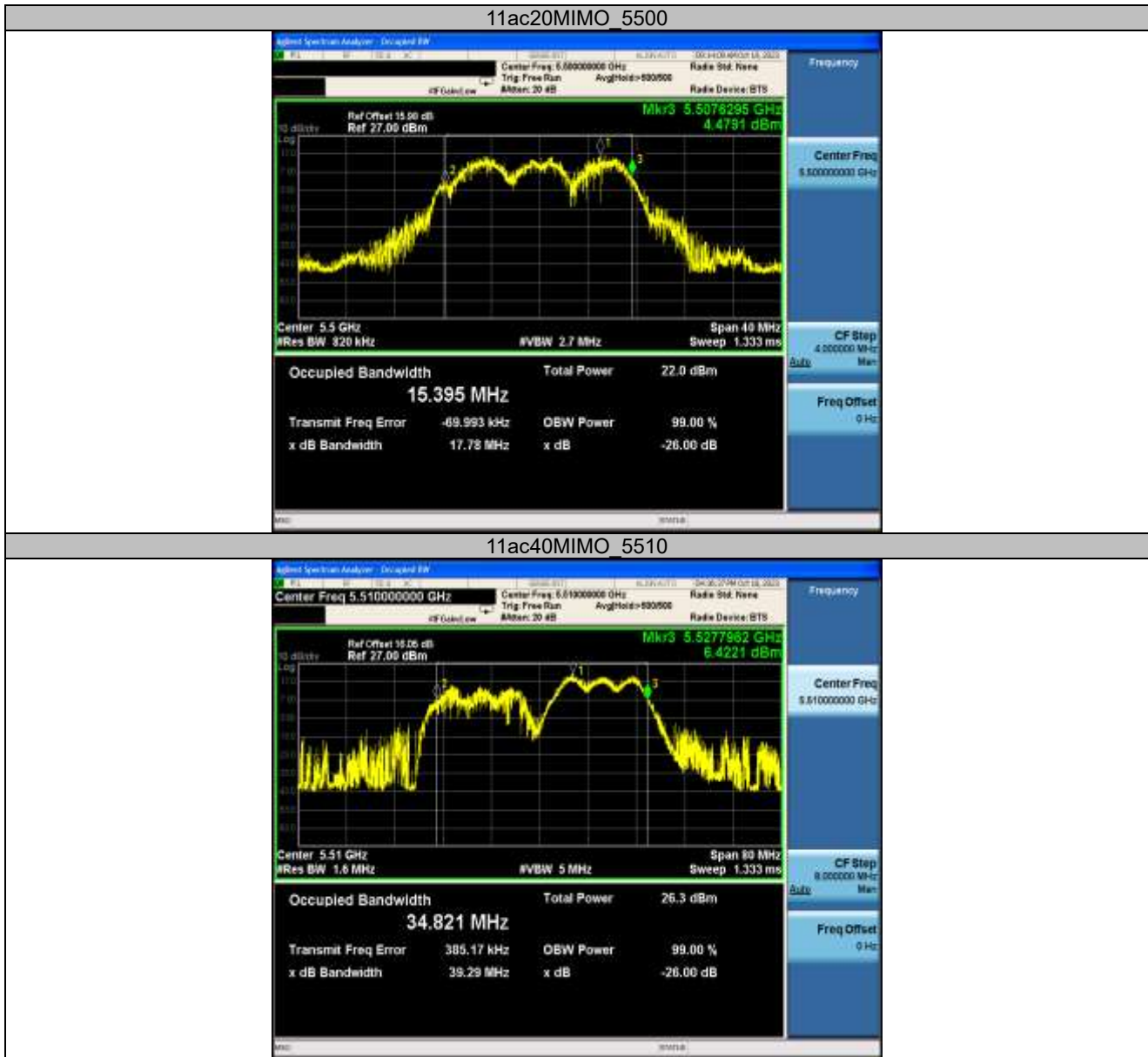

Unless otherwise agreed in writing, this document is issued by the Company subject to its General Conditions of Service printed overleaf, available on request or accessible at <http://www.sgs.com/en/Terms-and-Conditions.aspx> and, for electronic format documents, subject to Terms and Conditions for Electronic Documents at <http://www.sgs.com/en/Terms-and-Conditions/Terms-e-Documents.aspx>. Attention is drawn to the limitation of liability, indemnification and jurisdiction issues defined therein. Any holder of this document is advised that information contained herein reflects the Company's findings at the time of its intervention only and within the limits of Client's instructions, if any. The Company's sole responsibility is to its Client and this document does not exonerate parties to a transaction from exercising all their rights and obligations under the transaction documents. This document cannot be reproduced except in full, without prior written approval of the Company. Any unauthorized alteration, forgery or falsification of the content or appearance of this document is unlawful and offenders may be prosecuted to the fullest extent of the law. Unless otherwise stated the results shown in this test report refer only to the sample(s) tested and such sample(s) are retained for 30 days only.

Attention: To check the authenticity of testing/inspection report & certificate, please contact us at telephone: (86-755) 8307 1443, or email: CN.Doccheck@sgs.com  
 (X'ian) 710086 t (86-29) 6282 7885 www.sgs.com.cn  
 中国·西安·沣东新城科星三路137号康鸿楼方科技园1号楼D单元1层 邮编: 710086 t (86-29) 6282 7885 sgs.china@sgs.com

11ac80MIMO 5530

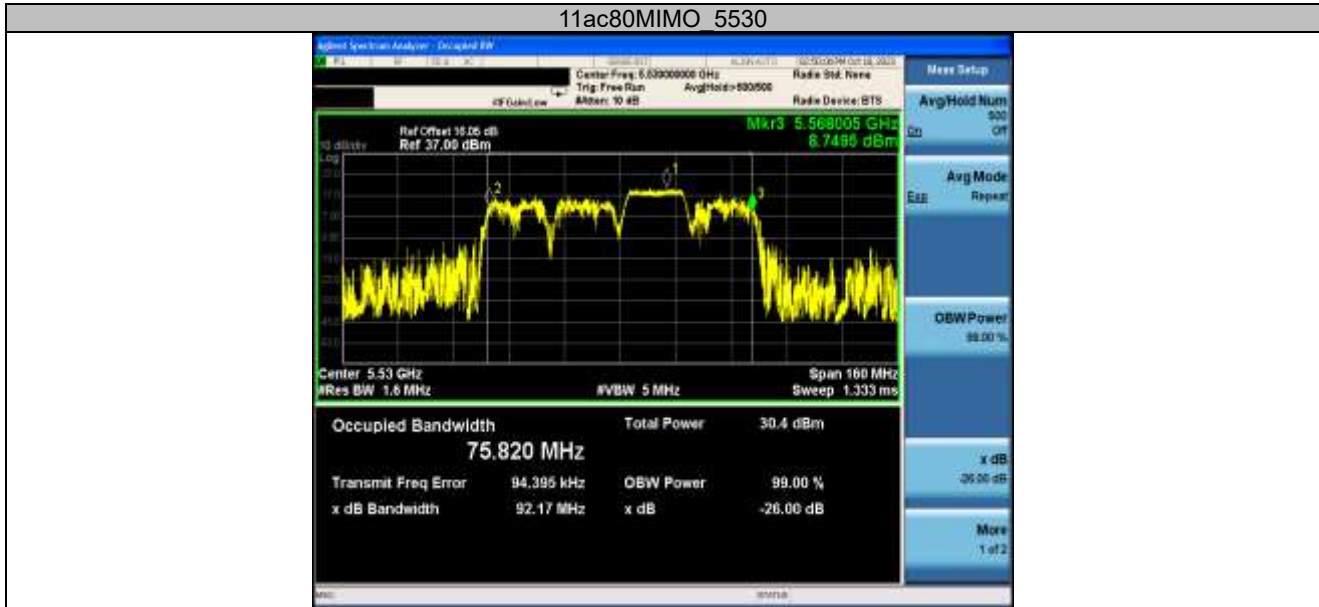

Unless otherwise agreed in writing, this document is issued by the Company subject to its General Conditions of Service printed overleaf, available on request or accessible at <http://www.sgs.com/en/Terms-and-Conditions.aspx> and, for electronic format documents, subject to Terms and Conditions for Electronic Documents at <http://www.sgs.com/en/Terms-and-Conditions/Terms-e-Documents.aspx>. Attention is drawn to the limitation of liability, indemnification and jurisdiction issues defined therein. Any holder of this document is advised that information contained herein reflects the Company's findings at the time of its intervention only and within the limits of Client's instructions, if any. The Company's sole responsibility is to its Client and this document does not exonerate parties to a transaction from exercising all their rights and obligations under the transaction documents. This document cannot be reproduced except in full, without prior written approval of the Company. Any unauthorized alteration, forgery or falsification of the content or appearance of this document is unlawful and offenders may be prosecuted to the fullest extent of the law. Unless otherwise stated the results shown in this test report refer only to the sample(s) tested and such sample(s) are retained for 30 days only.

Attention: To check the authenticity of testing/inspection report & certificate, please contact us at telephone: (86-755) 8307 1443, or email: [CN.Doccheck@sgs.com](mailto:CN.Doccheck@sgs.com)

SGS-CSTC Standards Technical Services (Xi'an) Co., Ltd. | WE Unit D, Building 1, Kanghong Orange Science Park, No.137, Keyuan 3rd Road, Fengcheng New Town, Xi'an, Shaanxi, China | 710086 | t (86-29) 6282 7885 | www.sgs.com.cn  
 中国·西安·沣东新城科园三路137号康鸿橙方科技园1号楼D单元1层 | 邮编: 710086 | t (86-29) 6282 7885 | sgs.china@sgs.com

### Statistical Performance check

#### Test Result

TestMode	Frequency[MHz]	Radar Type	Pass Times	Fail Times	Probability (%)	Limit (%)	Verdict
11ac20MIMO	5500	Type1	30	0	100.00	60	PASS
		Type2	30	0	100.00	60	PASS
		Type3	30	0	100.00	60	PASS
		Type4	30	0	100.00	60	PASS
		Type 1-4	---	---	100.00	80	PASS
		Type5	30	0	100.00	80	PASS
11ac40MIMO	5510	Type1	30	0	100.00	60	PASS
		Type2	30	0	100.00	60	PASS
		Type3	30	0	100.00	60	PASS
		Type4	30	0	100.00	60	PASS
		Type 1-4	---	---	100.00	80	PASS
		Type5	30	0	100.00	80	PASS
11ac80MIMO	5530	Type1	30	0	100.00	60	PASS
		Type2	30	0	100.00	60	PASS
		Type3	30	0	100.00	60	PASS
		Type4	30	0	100.00	60	PASS
		Type 1-4	---	---	100.00	80	PASS
		Type5	30	0	100.00	80	PASS
		Type6	30	0	100.00	70	PASS



Unless otherwise agreed in writing, this document is issued by the Company subject to its General Conditions of Service printed overleaf, available on request or accessible at <http://www.sgs.com/en/Terms-and-Conditions.aspx> and, for electronic format documents, subject to Terms and Conditions for Electronic Documents at <http://www.sgs.com/en/Terms-and-Conditions/Terms-e-Documents.aspx>. Attention is drawn to the limitation of liability, indemnification and jurisdiction issues defined therein. Any holder of this document is advised that information contained herein reflects the Company's findings at the time of its intervention only and within the limits of Client's instructions, if any. The Company's sole responsibility is to its Client and this document does not exonerate parties to a transaction from exercising all their rights and obligations under the transaction documents. This document cannot be reproduced except in full, without prior written approval of the Company. Any unauthorized alteration, forgery or falsification of the content or appearance of this document is unlawful and offenders may be prosecuted to the fullest extent of the law. Unless otherwise stated the results shown in this test report refer only to the sample(s) tested and such sample(s) are retained for 30 days only.

Attention: To check the authenticity of testing/inspection report & certificate, please contact us at telephone: (86-755) 8307 1443, or email: [CN.Doccheck@sgs.com](mailto:CN.Doccheck@sgs.com)  
 (X'ian Office) 710086 t (86-29) 6282 7885 www.sgs.com.cn  
 (Xi'an Office) 710086 t (86-29) 6282 7885 sgs.china@sgs.com

TestMode	Frequency[MHz]	Radar Type	Trial ID	Pulse width(μs)	PRI(μs)	Pulses per Burst	Detection (1: Yes; 0: No)
11ac20MIMO	5500	Type1	0	1.0	938.0	57	1
		Type1	1	1.0	698.0	76	1
		Type1	2	1.0	618.0	86	1
		Type1	3	1.0	538.0	99	1
		Type1	4	1.0	878.0	61	1
		Type1	5	1.0	3066.0	18	1
		Type1	6	1.0	638.0	83	1
		Type1	7	1.0	918.0	58	1
		Type1	8	1.0	838.0	63	1
		Type1	9	1.0	858.0	62	1
		Type1	10	1.0	798.0	67	1
		Type1	11	1.0	718.0	74	1
		Type1	12	1.0	578.0	92	1
		Type1	13	1.0	598.0	89	1
		Type1	14	1.0	558.0	95	1
		Type1	15	1.0	2536.0	21	1
		Type1	16	1.0	966.0	55	1
		Type1	17	1.0	827.0	64	1
		Type1	18	1.0	2501.0	22	1
		Type1	19	1.0	2595.0	21	1
		Type1	20	1.0	1114.0	48	1
		Type1	21	1.0	1302.0	41	1
		Type1	22	1.0	3045.0	18	1
		Type1	23	1.0	1624.0	33	1
		Type1	24	1.0	2878.0	19	1
		Type1	25	1.0	1027.0	52	1
		Type1	26	1.0	2485.0	22	1
		Type1	27	1.0	1600.0	33	1
		Type1	28	1.0	1172.0	46	1
		Type1	29	1.0	1177.0	45	1
		Type2	0	3.2	179.0	26	1
		Type2	1	1.1	207.0	23	1
		Type2	2	2.1	230.0	24	1
		Type2	3	4.8	200.0	29	1
		Type2	4	3.9	214.0	28	1
		Type2	5	2.9	222.0	26	1
		Type2	6	3.2	204.0	26	1
		Type2	7	2.5	192.0	25	1
		Type2	8	3.1	164.0	26	1
Type2	9	1.2	156.0	23	1		
Type2	10	3.9	210.0	27	1		
Type2	11	4.6	201.0	29	1		
Type2	12	3.2	162.0	26	1		
Type2	13	2.2	197.0	25	1		
Type2	14	4.5	163.0	29	1		
Type2	15	3.0	203.0	26	1		
Type2	16	5.0	168.0	29	1		
Type2	17	2.4	217.0	25	1		
Type2	18	2.9	191.0	26	1		
Type2	19	2.3	166.0	25	1		



Unless otherwise agreed in writing, this document is issued by the Company subject to its General Conditions of Service printed overleaf, available on request or accessible at <http://www.sgs.com/en/Terms-and-Conditions.aspx> and, for electronic format documents, subject to Terms and Conditions for Electronic Documents at <http://www.sgs.com/en/Terms-and-Conditions/Terms-e-Documents.aspx>. Attention is drawn to the limitation of liability, indemnification and jurisdiction issues defined therein. Any holder of this document is advised that information contained herein reflects the Company's findings at the time of its intervention only and within the limits of Client's instructions, if any. The Company's sole responsibility is to its Client and this document does not exonerate parties to a transaction from exercising all their rights and obligations under the transaction documents. This document cannot be reproduced except in full, without prior written approval of the Company. Any unauthorized alteration, forgery or falsification of the content or appearance of this document is unlawful and offenders may be prosecuted to the fullest extent of the law. Unless otherwise stated the results shown in this test report refer only to the sample(s) tested and such sample(s) are retained for 30 days only.

Attention: To check the authenticity of testing/inspection report & certificate, please contact us at telephone: (86-755) 8307 1443, or email: [CN.Doccheck@sgs.com](mailto:CN.Doccheck@sgs.com)

Type2	20	3.7	150.0	27	1
Type2	21	2.2	176.0	25	1
Type2	22	4.9	195.0	29	1
Type2	23	2.9	202.0	26	1
Type2	24	2.5	178.0	25	1
Type2	25	1.1	206.0	23	1
Type2	26	3.8	155.0	27	1
Type2	27	4.7	157.0	29	1
Type2	28	2.4	224.0	25	1
Type2	29	4.2	159.0	28	1
Type3	0	8.2	355.0	17	1
Type3	1	6.1	487.0	16	1
Type3	2	7.1	344.0	16	1
Type3	3	9.8	288.0	18	1
Type3	4	8.9	230.0	18	1
Type3	5	7.9	432.0	17	1
Type3	6	8.2	207.0	17	1
Type3	7	7.5	443.0	17	1
Type3	8	8.1	439.0	17	1
Type3	9	6.2	223.0	16	1
Type3	10	8.9	208.0	18	1
Type3	11	9.6	463.0	18	1
Type3	12	8.2	441.0	17	1
Type3	13	7.2	323.0	16	1
Type3	14	9.5	297.0	18	1
Type3	15	8.0	412.0	17	1
Type3	16	10.0	324.0	18	1
Type3	17	7.4	271.0	17	1
Type3	18	7.9	349.0	17	1
Type3	19	7.3	409.0	16	1
Type3	20	8.7	373.0	18	1
Type3	21	7.2	254.0	16	1
Type3	22	9.9	274.0	18	1
Type3	23	7.9	278.0	17	1
Type3	24	7.5	317.0	17	1
Type3	25	6.1	260.0	16	1
Type3	26	8.8	211.0	18	1
Type3	27	9.7	272.0	18	1
Type3	28	7.4	264.0	17	1
Type3	29	9.2	284.0	18	1
Type4	0	16.0	355.0	14	1
Type4	1	11.3	487.0	12	1
Type4	2	13.5	344.0	13	1
Type4	3	19.4	288.0	16	1
Type4	4	17.5	230.0	15	1
Type4	5	15.3	432.0	14	1
Type4	6	15.9	207.0	14	1
Type4	7	14.3	443.0	13	1
Type4	8	15.8	439.0	14	1
Type4	9	11.5	223.0	12	1
Type4	10	17.4	208.0	15	1
Type4	11	19.0	463.0	16	1
Type4	12	16.0	441.0	14	1



Unless otherwise agreed in writing, this document is issued by the Company subject to its General Conditions of Service printed overleaf, available on request or accessible at <http://www.sgs.com/en/Terms-and-Conditions.aspx> and, for electronic format documents, subject to Terms and Conditions for Electronic Documents at <http://www.sgs.com/en/Terms-and-Conditions/Terms-e-Documents.aspx>. Attention is drawn to the limitation of liability, indemnification and jurisdiction issues defined therein. Any holder of this document is advised that information contained herein reflects the Company's findings at the time of its intervention only and within the limits of Client's instructions, if any. The Company's sole responsibility is to its Client and this document does not exonerate parties to a transaction from exercising all their rights and obligations under the transaction documents. This document cannot be reproduced except in full, without prior written approval of the Company. Any unauthorized alteration, forgery or falsification of the content or appearance of this document is unlawful and offenders may be prosecuted to the fullest extent of the law. Unless otherwise stated the results shown in this test report refer only to the sample(s) tested and such sample(s) are retained for 30 days only.

Attention: To check the authenticity of testing/inspection report & certificate, please contact us at telephone: (86-755) 8307 1443, or email: [CN.Doccheck@sgs.com](mailto:CN.Doccheck@sgs.com)

SGS-CSTC Standards Technical Services (Xi'an) Co., Ltd. | 1/E Unit D, Building 1, Kanglong Orange Science Park, No.157, Keyuan3rd Road, Fengling New Town, Xian, Shaanxi, China | 710086 | t: (86-29) 6282 7885 | www.sgs.com.cn  
 中国·西安·沣东新城科里三路157号康隆橙方科技园1号楼D单元1层 | 邮编: 710086 | t: (86-29) 6282 7885 | sgs.china@sgs.com

		Type4	13	13.8	323.0	13	1		
		Type4	14	18.9	297.0	16	1		
		Type4	15	15.5	412.0	14	1		
		Type4	16	19.9	324.0	16	1		
		Type4	17	14.1	271.0	13	1		
		Type4	18	15.2	349.0	14	1		
		Type4	19	13.8	409.0	13	1		
		Type4	20	17.1	373.0	15	1		
		Type4	21	13.8	254.0	13	1		
		Type4	22	19.8	274.0	16	1		
		Type4	23	15.3	278.0	14	1		
		Type4	24	14.5	317.0	13	1		
		Type4	25	11.3	260.0	12	1		
		Type4	26	17.3	211.0	15	1		
		Type4	27	19.2	272.0	16	1		
		Type4	28	14.2	264.0	13	1		
		Type4	29	18.2	284.0	15	1		
11ac40MIMO	5510	Type1	0	1.0	938.0	57	1		
		Type1	1	1.0	698.0	76	1		
		Type1	2	1.0	618.0	86	1		
		Type1	3	1.0	538.0	99	1		
		Type1	4	1.0	878.0	61	1		
		Type1	5	1.0	3066.0	18	1		
		Type1	6	1.0	638.0	83	1		
		Type1	7	1.0	918.0	58	1		
		Type1	8	1.0	838.0	63	1		
		Type1	9	1.0	858.0	62	1		
		Type1	10	1.0	798.0	67	1		
		Type1	11	1.0	718.0	74	1		
		Type1	12	1.0	578.0	92	1		
		Type1	13	1.0	598.0	89	1		
		Type1	14	1.0	558.0	95	1		
		Type1	15	1.0	2536.0	21	1		
		Type1	16	1.0	966.0	55	1		
		Type1	17	1.0	827.0	64	1		
		Type1	18	1.0	2501.0	22	1		
		Type1	19	1.0	2595.0	21	1		
		Type1	20	1.0	1114.0	48	1		
		Type1	21	1.0	1302.0	41	1		
		Type1	22	1.0	3045.0	18	1		
		Type1	23	1.0	1624.0	33	1		
		Type1	24	1.0	2878.0	19	1		
		Type1	25	1.0	1027.0	52	1		
		Type1	26	1.0	2485.0	22	1		
		Type1	27	1.0	1600.0	33	1		
		Type1	28	1.0	1172.0	46	1		
		Type1	29	1.0	1177.0	45	1		
				Type2	0	3.2	179.0	26	1
				Type2	1	1.1	207.0	23	1
		Type2	2	2.1	230.0	24	1		
		Type2	3	4.8	200.0	29	1		
		Type2	4	3.9	214.0	28	1		
		Type2	5	2.9	222.0	26	1		



Unless otherwise agreed in writing, this document is issued by the Company subject to its General Conditions of Service printed overleaf, available on request or accessible at <http://www.sgs.com/en/Terms-and-Conditions.aspx> and, for electronic format documents, subject to Terms and Conditions for Electronic Documents at <http://www.sgs.com/en/Terms-and-Conditions/Terms-e-Documents.aspx>. Attention is drawn to the limitation of liability, indemnification and jurisdiction issues defined therein. Any holder of this document is advised that information contained herein reflects the Company's findings at the time of its intervention only and within the limits of Client's instructions, if any. The Company's sole responsibility is to its Client and this document does not exonerate parties to a transaction from exercising all their rights and obligations under the transaction documents. This document cannot be reproduced except in full, without prior written approval of the Company. Any unauthorized alteration, forgery or falsification of the content or appearance of this document is unlawful and offenders may be prosecuted to the fullest extent of the law. Unless otherwise stated the results shown in this test report refer only to the sample(s) tested and such sample(s) are retained for 30 days only.

Attention: To check the authenticity of testing/inspection report & certificate, please contact us at telephone: (86-755) 8307 1443, or email: [CN\\_Doccheck@sgs.com](mailto:CN_Doccheck@sgs.com)

SGS-CSTC Standards Technical Services (Xi'an) Co., Ltd. | 1/E Unit D, Building 1, Kanglong Orange Science Park, No.157, Keyuan 3rd Road, Fengling New Town, Xian, Shaanxi, China | 710086 | t: (86-29) 6282 7885 | www.sgs.com.cn  
 中国·西安·沣东新城科里三路157号康隆橙方科技园1号楼D单元1层 | 邮编: 710086 | t: (86-29) 6282 7885 | sgs.china@sgs.com

Report No.: XEWA2310000070RG05  
 Rev.: 01  
 Page: 47 of 267

Type2	6	3.2	204.0	26	1
Type2	7	2.5	192.0	25	1
Type2	8	3.1	164.0	26	1
Type2	9	1.2	156.0	23	1
Type2	10	3.9	210.0	27	1
Type2	11	4.6	201.0	29	1
Type2	12	3.2	162.0	26	1
Type2	13	2.2	197.0	25	1
Type2	14	4.5	163.0	29	1
Type2	15	3.0	203.0	26	1
Type2	16	5.0	168.0	29	1
Type2	17	2.4	217.0	25	1
Type2	18	2.9	191.0	26	1
Type2	19	2.3	166.0	25	1
Type2	20	3.7	150.0	27	1
Type2	21	2.2	176.0	25	1
Type2	22	4.9	195.0	29	1
Type2	23	2.9	202.0	26	1
Type2	24	2.5	178.0	25	1
Type2	25	1.1	206.0	23	1
Type2	26	3.8	155.0	27	1
Type2	27	4.7	157.0	29	1
Type2	28	2.4	224.0	25	1
Type2	29	4.2	159.0	28	1
Type3	0	8.2	355.0	17	1
Type3	1	6.1	487.0	16	1
Type3	2	7.1	344.0	16	1
Type3	3	9.8	288.0	18	1
Type3	4	8.9	230.0	18	1
Type3	5	7.9	432.0	17	1
Type3	6	8.2	207.0	17	1
Type3	7	7.5	443.0	17	1
Type3	8	8.1	439.0	17	1
Type3	9	6.2	223.0	16	1
Type3	10	8.9	208.0	18	1
Type3	11	9.6	463.0	18	1
Type3	12	8.2	441.0	17	1
Type3	13	7.2	323.0	16	1
Type3	14	9.5	297.0	18	1
Type3	15	8.0	412.0	17	1
Type3	16	10.0	324.0	18	1
Type3	17	7.4	271.0	17	1
Type3	18	7.9	349.0	17	1
Type3	19	7.3	409.0	16	1
Type3	20	8.7	373.0	18	1
Type3	21	7.2	254.0	16	1
Type3	22	9.9	274.0	18	1
Type3	23	7.9	278.0	17	1
Type3	24	7.5	317.0	17	1
Type3	25	6.1	260.0	16	1
Type3	26	8.8	211.0	18	1
Type3	27	9.7	272.0	18	1
Type3	28	7.4	264.0	17	1



Unless otherwise agreed in writing, this document is issued by the Company subject to its General Conditions of Service printed overleaf, available on request or accessible at <http://www.sgs.com/en/Terms-and-Conditions.aspx> and, for electronic format documents, subject to Terms and Conditions for Electronic Documents at <http://www.sgs.com/en/Terms-and-Conditions/Terms-e-Documents.aspx>. Attention is drawn to the limitation of liability, indemnification and jurisdiction issues defined therein. Any holder of this document is advised that information contained herein reflects the Company's findings at the time of its intervention only and within the limits of Client's instructions, if any. The Company's sole responsibility is to its Client and this document does not exonerate parties to a transaction from exercising all their rights and obligations under the transaction documents. This document cannot be reproduced except in full, without prior written approval of the Company. Any unauthorized alteration, forgery or falsification of the content or appearance of this document is unlawful and offenders may be prosecuted to the fullest extent of the law. Unless otherwise stated the results shown in this test report refer only to the sample(s) tested and such sample(s) are retained for 30 days only.

SGS-CSTC Standards Technical Services (Xi'an) Co., Ltd.  
 Inspection & Testing Services

Attention: To check the authenticity of testing/inspection report & certificate, please contact us at telephone: (86-755) 8307 1443, or email: [CN\\_Doccheck@sgs.com](mailto:CN_Doccheck@sgs.com)  
 (SE Unit) Building 1, Kanglong Orange Science Park, No.157, Keyuan 3rd Road, Fenglong New Town, Xian, Shaanxi, China 710086  
 t (86-29) 6282 7885 www.sgs.com.cn  
 中国·西安·沣东新城科园三路157号康隆橙方科技园1号楼D单元1层 邮编: 710086 t (86-29) 6282 7885 sgs.china@sgs.com

		Type3	29	9.2	284.0	18	1
		Type4	0	16.0	355.0	14	1
		Type4	1	11.3	487.0	12	1
		Type4	2	13.5	344.0	13	1
		Type4	3	19.4	288.0	16	1
		Type4	4	17.5	230.0	15	1
		Type4	5	15.3	432.0	14	1
		Type4	6	15.9	207.0	14	1
		Type4	7	14.3	443.0	13	1
		Type4	8	15.8	439.0	14	1
		Type4	9	11.5	223.0	12	1
		Type4	10	17.4	208.0	15	1
		Type4	11	19.0	463.0	16	1
		Type4	12	16.0	441.0	14	1
		Type4	13	13.8	323.0	13	1
		Type4	14	18.9	297.0	16	1
		Type4	15	15.5	412.0	14	1
		Type4	16	19.9	324.0	16	1
		Type4	17	14.1	271.0	13	1
		Type4	18	15.2	349.0	14	1
		Type4	19	13.8	409.0	13	1
		Type4	20	17.1	373.0	15	1
		Type4	21	13.8	254.0	13	1
		Type4	22	19.8	274.0	16	1
		Type4	23	15.3	278.0	14	1
		Type4	24	14.5	317.0	13	1
		Type4	25	11.3	260.0	12	1
		Type4	26	17.3	211.0	15	1
		Type4	27	19.2	272.0	16	1
		Type4	28	14.2	264.0	13	1
		Type4	29	18.2	284.0	15	1
11ac80MIMO	5530	Type1	0	1.0	938.0	57	1
		Type1	1	1.0	698.0	76	1
		Type1	2	1.0	618.0	86	1
		Type1	3	1.0	538.0	99	1
		Type1	4	1.0	878.0	61	1
		Type1	5	1.0	3066.0	18	1
		Type1	6	1.0	638.0	83	1
		Type1	7	1.0	918.0	58	1
		Type1	8	1.0	838.0	63	1
		Type1	9	1.0	858.0	62	1
		Type1	10	1.0	798.0	67	1
		Type1	11	1.0	718.0	74	1
		Type1	12	1.0	578.0	92	1
		Type1	13	1.0	598.0	89	1
		Type1	14	1.0	558.0	95	1
		Type1	15	1.0	2536.0	21	1
		Type1	16	1.0	966.0	55	1
		Type1	17	1.0	827.0	64	1
		Type1	18	1.0	2501.0	22	1
		Type1	19	1.0	2595.0	21	1
		Type1	20	1.0	1114.0	48	1
Type1	21	1.0	1302.0	41	1		



Unless otherwise agreed in writing, this document is issued by the Company subject to its General Conditions of Service printed overleaf, available on request or accessible at <http://www.sgs.com/en/Terms-and-Conditions.aspx> and, for electronic format documents, subject to Terms and Conditions for Electronic Documents at <http://www.sgs.com/en/Terms-and-Conditions/Terms-e-Documents.aspx>. Attention is drawn to the limitation of liability, indemnification and jurisdiction issues defined therein. Any holder of this document is advised that information contained herein reflects the Company's findings at the time of its intervention only and within the limits of Client's instructions, if any. The Company's sole responsibility is to its Client and this document does not exonerate parties to a transaction from exercising all their rights and obligations under the transaction documents. This document cannot be reproduced except in full, without prior written approval of the Company. Any unauthorized alteration, forgery or falsification of the content or appearance of this document is unlawful and offenders may be prosecuted to the fullest extent of the law. Unless otherwise stated the results shown in this test report refer only to the sample(s) tested and such sample(s) are retained for 30 days only.

Attention: To check the authenticity of testing/inspection report & certificate, please contact us at telephone: (86-755) 8307 1443, or email: [CN.Doccheck@sgs.com](mailto:CN.Doccheck@sgs.com)

SGS-CSTC Standards Technical Services (Xi'an) Co., Ltd. | 1/E Unit D, Building 1, Kaifeng Orange Science Park, No.157, Keyuan 3rd Road, Fengfeng New Town, Xian, Shaanxi, China | 710086 | t (86-29) 6282 7885 | www.sgs.com.cn  
 中国·西安·沣东新城科里三路157号康鸿橙方科技园1号楼D单元1层 | 邮编: 710086 | t (86-29) 6282 7885 | sgs.china@sgs.com



Type1	22	1.0	3045.0	18	1
Type1	23	1.0	1624.0	33	1
Type1	24	1.0	2878.0	19	1
Type1	25	1.0	1027.0	52	1
Type1	26	1.0	2485.0	22	1
Type1	27	1.0	1600.0	33	1
Type1	28	1.0	1172.0	46	1
Type1	29	1.0	1177.0	45	1
Type2	0	3.2	179.0	26	1
Type2	1	1.1	207.0	23	1
Type2	2	2.1	230.0	24	1
Type2	3	4.8	200.0	29	1
Type2	4	3.9	214.0	28	1
Type2	5	2.9	222.0	26	1
Type2	6	3.2	204.0	26	1
Type2	7	2.5	192.0	25	1
Type2	8	3.1	164.0	26	1
Type2	9	1.2	156.0	23	1
Type2	10	3.9	210.0	27	1
Type2	11	4.6	201.0	29	1
Type2	12	3.2	162.0	26	1
Type2	13	2.2	197.0	25	1
Type2	14	4.5	163.0	29	1
Type2	15	3.0	203.0	26	1
Type2	16	5.0	168.0	29	1
Type2	17	2.4	217.0	25	1
Type2	18	2.9	191.0	26	1
Type2	19	2.3	166.0	25	1
Type2	20	3.7	150.0	27	1
Type2	21	2.2	176.0	25	1
Type2	22	4.9	195.0	29	1
Type2	23	2.9	202.0	26	1
Type2	24	2.5	178.0	25	1
Type2	25	1.1	206.0	23	1
Type2	26	3.8	155.0	27	1
Type2	27	4.7	157.0	29	1
Type2	28	2.4	224.0	25	1
Type2	29	4.2	159.0	28	1
Type3	0	8.2	355.0	17	1
Type3	1	6.1	487.0	16	1
Type3	2	7.1	344.0	16	1
Type3	3	9.8	288.0	18	1
Type3	4	8.9	230.0	18	1
Type3	5	7.9	432.0	17	1
Type3	6	8.2	207.0	17	1
Type3	7	7.5	443.0	17	1
Type3	8	8.1	439.0	17	1
Type3	9	6.2	223.0	16	1
Type3	10	8.9	208.0	18	1
Type3	11	9.6	463.0	18	1
Type3	12	8.2	441.0	17	1
Type3	13	7.2	323.0	16	1
Type3	14	9.5	297.0	18	1



Unless otherwise agreed in writing, this document is issued by the Company subject to its General Conditions of Service printed overleaf, available on request or accessible at <http://www.sgs.com/en/Terms-and-Conditions.aspx> and, for electronic format documents, subject to Terms and Conditions for Electronic Documents at <http://www.sgs.com/en/Terms-and-Conditions/Terms-e-Documents.aspx>. Attention is drawn to the limitation of liability, indemnification and jurisdiction issues defined therein. Any holder of this document is advised that information contained herein reflects the Company's findings at the time of its intervention only and within the limits of Client's instructions, if any. The Company's sole responsibility is to its Client and this document does not exonerate parties to a transaction from exercising all their rights and obligations under the transaction documents. This document cannot be reproduced except in full, without prior written approval of the Company. Any unauthorized alteration, forgery or falsification of the content or appearance of this document is unlawful and offenders may be prosecuted to the fullest extent of the law. Unless otherwise stated the results shown in this test report refer only to the sample(s) tested and such sample(s) are retained for 30 days only.

Attention: To check the authenticity of testing/inspection report & certificate, please contact us at telephone: (86-755) 8307 1443, or email: [CN\\_DocCheck@sgs.com](mailto:CN_DocCheck@sgs.com)

SGS-CSTC Standards Technical Services (Xi'an) Co., Ltd. | 1/E Unit D, Building 1, Kanglong Orange Science Park, No.137, Keyuan 3rd Road, Fengling/Yue Tan, Xian, Shaanxi, China | 710086 | t: (86-29) 6282 7885 | www.sgs.com.cn  
 中国·西安·沣东新城科源三路137号康隆橙方科技园1号楼D单元1层 | 邮编: 710086 | t: (86-29) 6282 7885 | sgs.china@sgs.com

Type3	15	8.0	412.0	17	1
Type3	16	10.0	324.0	18	1
Type3	17	7.4	271.0	17	1
Type3	18	7.9	349.0	17	1
Type3	19	7.3	409.0	16	1
Type3	20	8.7	373.0	18	1
Type3	21	7.2	254.0	16	1
Type3	22	9.9	274.0	18	1
Type3	23	7.9	278.0	17	1
Type3	24	7.5	317.0	17	1
Type3	25	6.1	260.0	16	1
Type3	26	8.8	211.0	18	1
Type3	27	9.7	272.0	18	1
Type3	28	7.4	264.0	17	1
Type3	29	9.2	284.0	18	1
Type4	0	16.0	355.0	14	1
Type4	1	11.3	487.0	12	1
Type4	2	13.5	344.0	13	1
Type4	3	19.4	288.0	16	1
Type4	4	17.5	230.0	15	1
Type4	5	15.3	432.0	14	1
Type4	6	15.9	207.0	14	1
Type4	7	14.3	443.0	13	1
Type4	8	15.8	439.0	14	1
Type4	9	11.5	223.0	12	1
Type4	10	17.4	208.0	15	1
Type4	11	19.0	463.0	16	1
Type4	12	16.0	441.0	14	1
Type4	13	13.8	323.0	13	1
Type4	14	18.9	297.0	16	1
Type4	15	15.5	412.0	14	1
Type4	16	19.9	324.0	16	1
Type4	17	14.1	271.0	13	1
Type4	18	15.2	349.0	14	1
Type4	19	13.8	409.0	13	1
Type4	20	17.1	373.0	15	1
Type4	21	13.8	254.0	13	1
Type4	22	19.8	274.0	16	1
Type4	23	15.3	278.0	14	1
Type4	24	14.5	317.0	13	1
Type4	25	11.3	260.0	12	1
Type4	26	17.3	211.0	15	1
Type4	27	19.2	272.0	16	1
Type4	28	14.2	264.0	13	1
Type4	29	18.2	284.0	15	1



Unless otherwise agreed in writing, this document is issued by the Company subject to its General Conditions of Service printed overleaf, available on request or accessible at <http://www.sgs.com/en/Terms-and-Conditions.aspx> and, for electronic format documents, subject to Terms and Conditions for Electronic Documents at <http://www.sgs.com/en/Terms-and-Conditions/Terms-e-Documents.aspx>. Attention is drawn to the limitation of liability, indemnification and jurisdiction issues defined therein. Any holder of this document is advised that information contained herein reflects the Company's findings at the time of its intervention only and within the limits of Client's instructions, if any. The Company's sole responsibility is to its Client and this document does not exonerate parties to a transaction from exercising all their rights and obligations under the transaction documents. This document cannot be reproduced except in full, without prior written approval of the Company. Any unauthorized alteration, forgery or falsification of the content or appearance of this document is unlawful and offenders may be prosecuted to the fullest extent of the law. Unless otherwise stated the results shown in this test report refer only to the sample(s) tested and such sample(s) are retained for 30 days only.

Attention: To check the authenticity of testing/inspection report & certificate, please contact us at telephone: (86-755) 4307 1443, or email: [CN.Doccheck@sgs.com](mailto:CN.Doccheck@sgs.com)

SGS-CSTC Standards Technical Services (Xi'an) Co., Ltd. | (86-29) 6282 7885 | www.sgs.com.cn  
 中国·西安·沣东新城科星三路137号康鸿楼方科技园1号楼D单元1层 | 邮编: 710086 | (86-29) 6282 7885 | sgs.china@sgs.com

Report No.: XEWA231000070RG05

Rev.: 01

Page: 51 of 267

TestMode	Channel	Radar Type	Trial ID	Burst ID	Burst Offset (µs)	Chirp Width (MHz)	Number Of Pulses	Pulse Width (µs)	PRI1 (µs)	PRI2 (µs)	PRI3 (µs)	Detection (1: Yes; 0: No)
11ac80MIMO	5530	Type5	0	0	636185.0	13	2	77.8	1665.0	1477.0	---	1
11ac80MIMO	5530	Type5	0	1	32674.0	13	1	51.9	1074.0	---	---	1
11ac80MIMO	5530	Type5	0	2	226294.0	13	1	63.8	1584.0	---	---	1
11ac80MIMO	5530	Type5	0	3	417976.0	13	3	96.6	1682.0	1786.0	1843.0	1
11ac80MIMO	5530	Type5	0	4	611152.0	13	3	85.9	1795.0	1215.0	1729.0	1
11ac80MIMO	5530	Type5	0	5	8789.0	13	2	73.7	1198.0	1549.0	---	1
11ac80MIMO	5530	Type5	0	6	201917.0	13	2	77.2	1837.0	1819.0	---	1
11ac80MIMO	5530	Type5	0	7	395530.0	13	2	68.4	1587.0	1114.0	---	1
11ac80MIMO	5530	Type5	0	8	588564.0	13	2	76.7	2000.0	1155.0	---	1
11ac80MIMO	5530	Type5	0	9	783794.0	13	1	53.2	1147.0	---	---	1
11ac80MIMO	5530	Type5	0	10	177933.0	13	3	85.7	1433.0	1695.0	1394.0	1
11ac80MIMO	5530	Type5	0	11	370624.0	13	3	94.3	1670.0	1426.0	1935.0	1
11ac80MIMO	5530	Type5	0	12	564893.0	13	2	77.6	1294.0	1671.0	---	1
11ac80MIMO	5530	Type5	0	13	759583.0	13	1	65.7	1512.0	---	---	1
11ac80MIMO	5530	Type5	0	14	154262.0	13	3	93.5	1444.0	1130.0	1468.0	1
11ac40MIMO	5510	Type5	0	0	636185.0	13	2	77.8	1665.0	1477.0	---	1
11ac40MIMO	5510	Type5	0	1	32674.0	13	1	51.9	1074.0	---	---	1
11ac40MIMO	5510	Type5	0	2	226294.0	13	1	63.8	1584.0	---	---	1
11ac40MIMO	5510	Type5	0	3	417976.0	13	3	96.6	1682.0	1786.0	1843.0	1
11ac40MIMO	5510	Type5	0	4	611152.0	13	3	85.9	1795.0	1215.0	1729.0	1
11ac40MIMO	5510	Type5	0	5	8789.0	13	2	73.7	1198.0	1549.0	---	1
11ac40MIMO	5510	Type5	0	6	201917.0	13	2	77.2	1837.0	1819.0	---	1
11ac40MIMO	5510	Type5	0	7	395530.0	13	2	68.4	1587.0	1114.0	---	1
11ac40MIMO	5510	Type5	0	8	588564.0	13	2	76.7	2000.0	1155.0	---	1
11ac40MIMO	5510	Type5	0	9	783794.0	13	1	53.2	1147.0	---	---	1
11ac40MIMO	5510	Type5	0	10	177933.0	13	3	85.7	1433.0	1695.0	1394.0	1
11ac40MIMO	5510	Type5	0	11	370624.0	13	3	94.3	1670.0	1426.0	1935.0	1
11ac40MIMO	5510	Type5	0	12	564893.0	13	2	77.6	1294.0	1671.0	---	1
11ac40MIMO	5510	Type5	0	13	759583.0	13	1	65.7	1512.0	---	---	1
11ac40MIMO	5510	Type5	0	14	154262.0	13	3	93.5	1444.0	1130.0	1468.0	1
11ac20MIMO	5500	Type5	0	0	636185.0	13	2	77.8	1665.0	1477.0	---	1
11ac20MIMO	5500	Type5	0	1	32674.0	13	1	51.9	1074.0	---	---	1
11ac20MIMO	5500	Type5	0	2	226294.0	13	1	63.8	1584.0	---	---	1
11ac20MIMO	5500	Type5	0	3	417976.0	13	3	96.6	1682.0	1786.0	1843.0	1
11ac20MIMO	5500	Type5	0	4	611152.0	13	3	85.9	1795.0	1215.0	1729.0	1
11ac20MIMO	5500	Type5	0	5	8789.0	13	2	73.7	1198.0	1549.0	---	1
11ac20MIMO	5500	Type5	0	6	201917.0	13	2	77.2	1837.0	1819.0	---	1
11ac20MIMO	5500	Type5	0	7	395530.0	13	2	68.4	1587.0	1114.0	---	1
11ac20MIMO	5500	Type5	0	8	588564.0	13	2	76.7	2000.0	1155.0	---	1
11ac20MIMO	5500	Type5	0	9	783794.0	13	1	53.2	1147.0	---	---	1
11ac20MIMO	5500	Type5	0	10	177933.0	13	3	85.7	1433.0	1695.0	1394.0	1
11ac20MIMO	5500	Type5	0	11	370624.0	13	3	94.3	1670.0	1426.0	1935.0	1
11ac20MIMO	5500	Type5	0	12	564893.0	13	2	77.6	1294.0	1671.0	---	1
11ac20MIMO	5500	Type5	0	13	759583.0	13	1	65.7	1512.0	---	---	1
11ac20MIMO	5500	Type5	0	14	154262.0	13	3	93.5	1444.0	1130.0	1468.0	1



Unless otherwise agreed in writing, this document is issued by the Company subject to its General Conditions of Service printed overleaf, available on request or accessible at <http://www.sgs.com/en/Terms-and-Conditions.aspx> and, for electronic format documents, subject to Terms and Conditions for Electronic Documents at <http://www.sgs.com/en/Terms-and-Conditions/Terms-e-Documents.aspx>. Attention is drawn to the limitation of liability, indemnification and jurisdiction issues defined therein. Any holder of this document is advised that information contained herein reflects the Company's findings at the time of its intervention only and within the limits of Client's instructions, if any. The Company's sole responsibility is to its Client and this document does not exonerate parties to a transaction from exercising all their rights and obligations under the transaction documents. This document cannot be reproduced except in full, without prior written approval of the Company. Any unauthorized alteration, forgery or falsification of the content or appearance of this document is unlawful and offenders may be prosecuted to the fullest extent of the law. Unless otherwise stated the results shown in this test report refer only to the sample(s) tested and such sample(s) are retained for 30 days only.

Attention: To check the authenticity of testing/inspection report & certificate, please contact us at telephone: (86-755) 8307 1443, or email: [CN.Doccheck@sgs.com](mailto:CN.Doccheck@sgs.com)

SGS-CSTC Standards Technical Services (Xi'an) Co., Ltd. | 1/E Unit D, Building 1, Kanglong Orange Science Park, No.157, Keyuan 3rd Road, Fengling New Town, Xi'an, Shaanxi, China | 710086 | t: (86-29) 6282 7885 | www.sgs.com.cn | sgs.china@sgs.com  
 中国·西安·沣东新城科里三路137号康隆橙方科技园1号楼D单元1层 | 邮编: 710086 | t: (86-29) 6282 7885 | www.sgs.com.cn | sgs.china@sgs.com



Report No.: XEWA2310000070RG05

Rev.: 01

Page: 52 of 267

TestMode	Channel	Radar Type	Trial ID	Burst ID	Burst Offset (μs)	Chirp Width (MHz)	Number Of Pulses	Pulse Width (μs)	PRI1 (μs)	PRI2 (μs)	PRI3 (μs)	Detection (1: Yes; 0: No)
11ac80MIMO	5530	Type5	1	0	653020.0	5	2	75.0	1880.0	1527.0	---	1
11ac80MIMO	5530	Type5	1	1	1015643.0	5	3	99.4	1401.0	1262.0	1257.0	1
11ac80MIMO	5530	Type5	1	2	1379398.0	5	2	67.4	1531.0	1403.0	---	1
11ac80MIMO	5530	Type5	1	3	245489.0	5	2	73.6	1449.0	1041.0	---	1
11ac80MIMO	5530	Type5	1	4	609113.0	5	1	65.9	1432.0	---	---	1
11ac80MIMO	5530	Type5	1	5	970852.0	5	3	83.8	1356.0	1292.0	1419.0	1
11ac80MIMO	5530	Type5	1	6	1335913.0	5	1	65.5	1543.0	---	---	1
11ac80MIMO	5530	Type5	1	7	200406.0	5	3	98.6	1548.0	1796.0	1728.0	1
11ac40MIMO	5510	Type5	1	0	653020.0	5	2	75.0	1880.0	1527.0	---	1
11ac40MIMO	5510	Type5	1	1	1015643.0	5	3	99.4	1401.0	1262.0	1257.0	1
11ac40MIMO	5510	Type5	1	2	1379398.0	5	2	67.4	1531.0	1403.0	---	1
11ac40MIMO	5510	Type5	1	3	245489.0	5	2	73.6	1449.0	1041.0	---	1
11ac40MIMO	5510	Type5	1	4	609113.0	5	1	65.9	1432.0	---	---	1
11ac40MIMO	5510	Type5	1	5	970852.0	5	3	83.8	1356.0	1292.0	1419.0	1
11ac40MIMO	5510	Type5	1	6	1335913.0	5	1	65.5	1543.0	---	---	1
11ac40MIMO	5510	Type5	1	7	200406.0	5	3	98.6	1548.0	1796.0	1728.0	1
11ac20MIMO	5500	Type5	1	0	653020.0	5	2	75.0	1880.0	1527.0	---	1
11ac20MIMO	5500	Type5	1	1	1015643.0	5	3	99.4	1401.0	1262.0	1257.0	1
11ac20MIMO	5500	Type5	1	2	1379398.0	5	2	67.4	1531.0	1403.0	---	1
11ac20MIMO	5500	Type5	1	3	245489.0	5	2	73.6	1449.0	1041.0	---	1
11ac20MIMO	5500	Type5	1	4	609113.0	5	1	65.9	1432.0	---	---	1
11ac20MIMO	5500	Type5	1	5	970852.0	5	3	83.8	1356.0	1292.0	1419.0	1
11ac20MIMO	5500	Type5	1	6	1335913.0	5	1	65.5	1543.0	---	---	1
11ac20MIMO	5500	Type5	1	7	200406.0	5	3	98.6	1548.0	1796.0	1728.0	1



Unless otherwise agreed in writing, this document is issued by the Company subject to its General Conditions of Service printed overleaf, available on request or accessible at <http://www.sgs.com/en/Terms-and-Conditions.aspx> and, for electronic format documents, subject to Terms and Conditions for Electronic Documents at <http://www.sgs.com/en/Terms-and-Conditions/Terms-e-Documents.aspx>. Attention is drawn to the limitation of liability, indemnification and jurisdiction issues defined therein. Any holder of this document is advised that information contained herein reflects the Company's findings at the time of its intervention only and within the limits of Client's instructions, if any. The Company's sole responsibility is to its Client and this document does not exonerate parties to a transaction from exercising all their rights and obligations under the transaction documents. This document cannot be reproduced except in full, without prior written approval of the Company. Any unauthorized alteration, forgery or falsification of the content or appearance of this document is unlawful and offenders may be prosecuted to the fullest extent of the law. Unless otherwise stated the results shown in this test report refer only to the sample(s) tested and such sample(s) are retained for 30 days only.

Attention: To check the authenticity of testing/inspection report & certificate, please contact us at telephone: (86-755) 8307 1443, or email: CN\_Doccheck@sgs.com  
 (SGS) Ltd (Shanghai) Inspection & Testing Services Co., Ltd. | (SGS) Ltd (Xi'an) Standards Technical Services (Xi'an) Co., Ltd.  
 1/E Unit D, Building 1, Kanghong Orange Science Park, No.137, Kejian 3rd Road, Fengjing New Town, Xi'an, Shaanxi, China 710086 | t (86-29) 6282 7885 | www.sgs.com.cn  
 中国·西安·沣东新城科园三路137号康鸿橙方科技园1号楼D单元1层 邮编: 710086 | t (86-29) 6282 7885 | sgs.china@sgs.com



Report No.: XEWA231000070RG05  
 Rev.: 01  
 Page: 53 of 267

TestMode	Channel	Radar Type	Trial ID	Burst ID	Burst Offset (µs)	Chirp Width (MHz)	Number Of Pulses	Pulse Width (µs)	PRI1 (µs)	PRI2 (µs)	PRI3 (µs)	Detection (1: Yes; 0: No)
11ac80MIMO	5530	Type5	2	0	409565.0	9	2	73.8	1806.0	1538.0	---	1
11ac80MIMO	5530	Type5	2	1	673692.0	9	2	69.5	1117.0	1649.0	---	1
11ac80MIMO	5530	Type5	2	2	938562.0	9	1	51.9	1651.0	---	---	1
11ac80MIMO	5530	Type5	2	3	113209.0	9	3	84.6	1976.0	1032.0	1271.0	1
11ac80MIMO	5530	Type5	2	4	376726.0	9	3	95.4	1060.0	1903.0	1388.0	1
11ac80MIMO	5530	Type5	2	5	641212.0	9	2	68.0	1368.0	1351.0	---	1
11ac80MIMO	5530	Type5	2	6	903714.0	9	3	89.6	1338.0	1514.0	1573.0	1
11ac80MIMO	5530	Type5	2	7	80863.0	9	2	81.9	1022.0	1689.0	---	1
11ac80MIMO	5530	Type5	2	8	344067.0	9	3	88.3	1810.0	1330.0	1838.0	1
11ac80MIMO	5530	Type5	2	9	609331.0	9	1	53.7	1597.0	---	---	1
11ac80MIMO	5530	Type5	2	10	871542.0	9	3	91.3	1961.0	1106.0	1001.0	1
11ac40MIMO	5510	Type5	2	0	409565.0	9	2	73.8	1806.0	1538.0	---	1
11ac40MIMO	5510	Type5	2	1	673692.0	9	2	69.5	1117.0	1649.0	---	1
11ac40MIMO	5510	Type5	2	2	938562.0	9	1	51.9	1651.0	---	---	1
11ac40MIMO	5510	Type5	2	3	113209.0	9	3	84.6	1976.0	1032.0	1271.0	1
11ac40MIMO	5510	Type5	2	4	376726.0	9	3	95.4	1060.0	1903.0	1388.0	1
11ac40MIMO	5510	Type5	2	5	641212.0	9	2	68.0	1368.0	1351.0	---	1
11ac40MIMO	5510	Type5	2	6	903714.0	9	3	89.6	1338.0	1514.0	1573.0	1
11ac40MIMO	5510	Type5	2	7	80863.0	9	2	81.9	1022.0	1689.0	---	1
11ac40MIMO	5510	Type5	2	8	344067.0	9	3	88.3	1810.0	1330.0	1838.0	1
11ac40MIMO	5510	Type5	2	9	609331.0	9	1	53.7	1597.0	---	---	1
11ac40MIMO	5510	Type5	2	10	871542.0	9	3	91.3	1961.0	1106.0	1001.0	1
11ac20MIMO	5500	Type5	2	0	409565.0	9	2	73.8	1806.0	1538.0	---	1
11ac20MIMO	5500	Type5	2	1	673692.0	9	2	69.5	1117.0	1649.0	---	1
11ac20MIMO	5500	Type5	2	2	938562.0	9	1	51.9	1651.0	---	---	1
11ac20MIMO	5500	Type5	2	3	113209.0	9	3	84.6	1976.0	1032.0	1271.0	1
11ac20MIMO	5500	Type5	2	4	376726.0	9	3	95.4	1060.0	1903.0	1388.0	1
11ac20MIMO	5500	Type5	2	5	641212.0	9	2	68.0	1368.0	1351.0	---	1
11ac20MIMO	5500	Type5	2	6	903714.0	9	3	89.6	1338.0	1514.0	1573.0	1
11ac20MIMO	5500	Type5	2	7	80863.0	9	2	81.9	1022.0	1689.0	---	1
11ac20MIMO	5500	Type5	2	8	344067.0	9	3	88.3	1810.0	1330.0	1838.0	1
11ac20MIMO	5500	Type5	2	9	609331.0	9	1	53.7	1597.0	---	---	1
11ac20MIMO	5500	Type5	2	10	871542.0	9	3	91.3	1961.0	1106.0	1001.0	1



Unless otherwise agreed in writing, this document is issued by the Company subject to its General Conditions of Service printed overleaf, available on request or accessible at <http://www.sgs.com/en/Terms-and-Conditions.aspx> and, for electronic format documents, subject to Terms and Conditions for Electronic Documents at <http://www.sgs.com/en/Terms-and-Conditions/Terms-e-Document.aspx>. Attention is drawn to the limitation of liability, indemnification and jurisdiction issues defined therein. Any holder of this document is advised that information contained herein reflects the Company's findings at the time of its intervention only and within the limits of Client's instructions, if any. The Company's sole responsibility is to its Client and this document does not exonerate parties to a transaction from exercising all their rights and obligations under the transaction documents. This document cannot be reproduced except in full, without prior written approval of the Company. Any unauthorized alteration, forgery or falsification of the content or appearance of this document is unlawful and offenders may be prosecuted to the fullest extent of the law. Unless otherwise stated the results shown in this test report refer only to the sample(s) tested and such sample(s) are retained for 30 days only.

Attention: To check the authenticity of testing/inspection report & certificate, please contact us at telephone: (86-755) 4307 1443, or email: CN.Doccheck@sgs.com  
 (US) Unit D, Building 1, Kanghong Orange Science Park, No.157, Keyuan 3rd Road, Fenglong New Town, Xi'an, Shaanxi, China 710086 t (86-29) 6282 7885 www.sgs.com.cn  
 中国·西安·沣东新城科园三路157号康鸿橙方科技园1号楼D单元1层 邮编: 710086 t (86-29) 6282 7885 sgs.china@sgs.com



Report No.: XEWA2310000070RG05
Rev.: 01
Page: 54 of 267

Table with 14 columns: TestMode, Channel, Radar Type, Trial ID, Burst ID, Burst Offset (µs), Chirp Width (MHz), Number Of Pulses, Pulse Width (µs), PRI1 (µs), PRI2 (µs), PRI3 (µs), Detection (1: Yes; 0: No). Rows include various test configurations for 11ac80MIMO, 11ac40MIMO, and 11ac20MIMO.



Unless otherwise agreed in writing, this document is issued by the Company subject to its General Conditions of Service printed overleaf, available on request or accessible at http://www.sgs.com/en/Terms-and-Conditions.aspx and, for electronic format documents, subject to Terms and Conditions for Electronic Documents at http://www.sgs.com/en/Terms-and-Conditions/Terms-e-Documents.aspx. Attention is drawn to the limitation of liability, indemnification and jurisdiction issues defined therein. Any holder of this document is advised that information contained herein reflects the Company's findings at the time of its intervention only and within the limits of Client's instructions, if any. The Company's sole responsibility is to its Client and this document does not exonerate parties to a transaction from exercising all their rights and obligations under the transaction documents. This document cannot be reproduced except in full, without prior written approval of the Company. Any unauthorized alteration, forgery or falsification of the content or appearance of this document is unlawful and offenders may be prosecuted to the fullest extent of the law. Unless otherwise stated the results shown in this test report refer only to the sample(s) tested and such sample(s) are retained for 30 days only.

Attention: To check the authenticity of testing/inspection report & certificate, please contact us at telephone: (86-755) 8307 1443, or email: CN\_Doccheck@sgs.com
1/E Unit D, Building 1, Kanglong Orange Science Park, No.157, Keyuan 3rd Road, Fengjing/Yue Town, Xi'an, Shaanxi, China 710086 t (86-29) 6282 7885 www.sgs.com.cn
中国·西安·沣东新城科里三路157号康隆橙方科技园1号楼D单元1层 邮编: 710086 t (86-29) 6282 7885 sgs.china@sgs.com

Report No.: XEWA2310000070RG05  
 Rev.: 01  
 Page: 55 of 267

11ac20MIMO	5500	Type5	3	9	135674.0	19	2	82.8	1883.0	1005.0	---	1
11ac20MIMO	5500	Type5	3	10	279928.0	19	3	88.0	1061.0	1928.0	1101.0	1
11ac20MIMO	5500	Type5	3	11	424279.0	19	3	93.2	1207.0	1907.0	1223.0	1
11ac20MIMO	5500	Type5	3	12	570132.0	19	2	70.4	1526.0	1360.0	---	1
11ac20MIMO	5500	Type5	3	13	117439.0	19	3	95.3	1171.0	1955.0	1775.0	1
11ac20MIMO	5500	Type5	3	14	262502.0	19	2	81.9	1690.0	1545.0	---	1
11ac20MIMO	5500	Type5	3	15	406573.0	19	3	98.5	1975.0	1169.0	1062.0	1
11ac20MIMO	5500	Type5	3	16	553328.0	19	1	65.0	1767.0	---	---	1
11ac20MIMO	5500	Type5	3	17	99799.0	19	3	85.4	1011.0	1637.0	1425.0	1
11ac20MIMO	5500	Type5	3	18	244095.0	19	3	91.6	1878.0	1445.0	1325.0	1
11ac20MIMO	5500	Type5	3	19	390012.0	19	2	67.3	1091.0	1218.0	---	1



Unless otherwise agreed in writing, this document is issued by the Company subject to its General Conditions of Service printed overleaf, available on request or accessible at <http://www.sgs.com/en/Terms-and-Conditions.aspx> and, for electronic format documents, subject to Terms and Conditions for Electronic Documents at <http://www.sgs.com/en/Terms-and-Conditions/Terms-e-Documents.aspx>. Attention is drawn to the limitation of liability, indemnification and jurisdiction issues defined therein. Any holder of this document is advised that information contained herein reflects the Company's findings at the time of its intervention only and within the limits of Client's instructions, if any. The Company's sole responsibility is to its Client and this document does not exonerate parties to a transaction from exercising all their rights and obligations under the transaction documents. This document cannot be reproduced except in full, without prior written approval of the Company. Any unauthorized alteration, forgery or falsification of the content or appearance of this document is unlawful and offenders may be prosecuted to the fullest extent of the law. Unless otherwise stated the results shown in this test report refer only to the sample(s) tested and such sample(s) are retained for 30 days only.

Attention: To check the authenticity of testing/inspection report & certificate, please contact us at telephone: (86-755) 4307 1443, or email: [CN.Doccheck@sgs.com](mailto:CN.Doccheck@sgs.com)



Report No.: XEWA2310000070RG05

Rev.: 01

Page: 56 of 267

TestMode	Channel	Radar Type	Trial ID	Burst ID	Burst Offset (µs)	Chirp Width (MHz)	Number Of Pulses	Pulse Width (µs)	PRI1 (µs)	PRI2 (µs)	PRI3 (µs)	Detection (1: Yes; 0: No)
11ac80MIMO	5530	Type5	4	0	629614.0	16	2	67.9	1320.0	1133.0	---	1
11ac80MIMO	5530	Type5	4	1	96856.0	16	1	62.3	1957.0	---	---	1
11ac80MIMO	5530	Type5	4	2	267719.0	16	1	53.3	1592.0	---	---	1
11ac80MIMO	5530	Type5	4	3	436784.0	16	3	90.0	1900.0	1153.0	1346.0	1
11ac80MIMO	5530	Type5	4	4	608289.0	16	2	77.1	1166.0	1646.0	---	1
11ac80MIMO	5530	Type5	4	5	75610.0	16	3	83.9	1278.0	1232.0	1459.0	1
11ac80MIMO	5530	Type5	4	6	245638.0	16	3	89.1	1240.0	1384.0	1939.0	1
11ac80MIMO	5530	Type5	4	7	416355.0	16	2	81.8	1833.0	1676.0	---	1
11ac80MIMO	5530	Type5	4	8	588736.0	16	1	50.3	1075.0	---	---	1
11ac80MIMO	5530	Type5	4	9	54571.0	16	3	87.1	1116.0	1996.0	1756.0	1
11ac80MIMO	5530	Type5	4	10	225175.0	16	2	71.3	1225.0	1815.0	---	1
11ac80MIMO	5530	Type5	4	11	394825.0	16	3	97.5	1884.0	1465.0	1132.0	1
11ac80MIMO	5530	Type5	4	12	565361.0	16	3	90.6	1561.0	1040.0	1354.0	1
11ac80MIMO	5530	Type5	4	13	33643.0	16	3	86.3	1596.0	1183.0	1792.0	1
11ac80MIMO	5530	Type5	4	14	203957.0	16	3	97.6	1365.0	1073.0	1361.0	1
11ac80MIMO	5530	Type5	4	15	373812.0	16	3	84.7	1021.0	1718.0	1854.0	1
11ac80MIMO	5530	Type5	4	16	544060.0	16	3	99.7	1150.0	1244.0	1988.0	1
11ac40MIMO	5510	Type5	4	0	629614.0	16	2	67.9	1320.0	1133.0	---	1
11ac40MIMO	5510	Type5	4	1	96856.0	16	1	62.3	1957.0	---	---	1
11ac40MIMO	5510	Type5	4	2	267719.0	16	1	53.3	1592.0	---	---	1
11ac40MIMO	5510	Type5	4	3	436784.0	16	3	90.0	1900.0	1153.0	1346.0	1
11ac40MIMO	5510	Type5	4	4	608289.0	16	2	77.1	1166.0	1646.0	---	1
11ac40MIMO	5510	Type5	4	5	75610.0	16	3	83.9	1278.0	1232.0	1459.0	1
11ac40MIMO	5510	Type5	4	6	245638.0	16	3	89.1	1240.0	1384.0	1939.0	1
11ac40MIMO	5510	Type5	4	7	416355.0	16	2	81.8	1833.0	1676.0	---	1
11ac40MIMO	5510	Type5	4	8	588736.0	16	1	50.3	1075.0	---	---	1
11ac40MIMO	5510	Type5	4	9	54571.0	16	3	87.1	1116.0	1996.0	1756.0	1
11ac40MIMO	5510	Type5	4	10	225175.0	16	2	71.3	1225.0	1815.0	---	1
11ac40MIMO	5510	Type5	4	11	394825.0	16	3	97.5	1884.0	1465.0	1132.0	1
11ac40MIMO	5510	Type5	4	12	565361.0	16	3	90.6	1561.0	1040.0	1354.0	1
11ac40MIMO	5510	Type5	4	13	33643.0	16	3	86.3	1596.0	1183.0	1792.0	1
11ac40MIMO	5510	Type5	4	14	203957.0	16	3	97.6	1365.0	1073.0	1361.0	1
11ac40MIMO	5510	Type5	4	15	373812.0	16	3	84.7	1021.0	1718.0	1854.0	1
11ac40MIMO	5510	Type5	4	16	544060.0	16	3	99.7	1150.0	1244.0	1988.0	1
11ac20MIMO	5500	Type5	4	0	629614.0	16	2	67.9	1320.0	1133.0	---	1
11ac20MIMO	5500	Type5	4	1	96856.0	16	1	62.3	1957.0	---	---	1
11ac20MIMO	5500	Type5	4	2	267719.0	16	1	53.3	1592.0	---	---	1
11ac20MIMO	5500	Type5	4	3	436784.0	16	3	90.0	1900.0	1153.0	1346.0	1
11ac20MIMO	5500	Type5	4	4	608289.0	16	2	77.1	1166.0	1646.0	---	1
11ac20MIMO	5500	Type5	4	5	75610.0	16	3	83.9	1278.0	1232.0	1459.0	1
11ac20MIMO	5500	Type5	4	6	245638.0	16	3	89.1	1240.0	1384.0	1939.0	1
11ac20MIMO	5500	Type5	4	7	416355.0	16	2	81.8	1833.0	1676.0	---	1
11ac20MIMO	5500	Type5	4	8	588736.0	16	1	50.3	1075.0	---	---	1
11ac20MIMO	5500	Type5	4	9	54571.0	16	3	87.1	1116.0	1996.0	1756.0	1
11ac20MIMO	5500	Type5	4	10	225175.0	16	2	71.3	1225.0	1815.0	---	1
11ac20MIMO	5500	Type5	4	11	394825.0	16	3	97.5	1884.0	1465.0	1132.0	1
11ac20MIMO	5500	Type5	4	12	565361.0	16	3	90.6	1561.0	1040.0	1354.0	1
11ac20MIMO	5500	Type5	4	13	33643.0	16	3	86.3	1596.0	1183.0	1792.0	1
11ac20MIMO	5500	Type5	4	14	203957.0	16	3	97.6	1365.0	1073.0	1361.0	1
11ac20MIMO	5500	Type5	4	15	373812.0	16	3	84.7	1021.0	1718.0	1854.0	1
11ac20MIMO	5500	Type5	4	16	544060.0	16	3	99.7	1150.0	1244.0	1988.0	1



Unless otherwise agreed in writing, this document is issued by the Company subject to its General Conditions of Service printed overleaf, available on request or accessible at <http://www.sgs.com/en/Terms-and-Conditions.aspx> and, for electronic format documents, subject to Terms and Conditions for Electronic Documents at <http://www.sgs.com/en/Terms-and-Conditions/Terms-e-Documents.aspx>. Attention is drawn to the limitation of liability, indemnification and jurisdiction issues defined therein. Any holder of this document is advised that information contained herein reflects the Company's findings at the time of its intervention only and within the limits of Client's instructions, if any. The Company's sole responsibility is to its Client and this document does not exonerate parties to a transaction from exercising all their rights and obligations under the transaction documents. This document cannot be reproduced except in full, without prior written approval of the Company. Any unauthorized alteration, forgery or falsification of the content or appearance of this document is unlawful and offenders may be prosecuted to the fullest extent of the law. Unless otherwise stated the results shown in this test report refer only to the sample(s) tested and such sample(s) are retained for 30 days only.

Attention: To check the authenticity of testing/inspection report & certificate, please contact us at telephone: (86-755) 8307 1443, or email: [CN.Doccheck@sgs.com](mailto:CN.Doccheck@sgs.com)

SGS-CSTC Standards Technical Services (Xi'an) Co., Ltd.  
 (Xi'an Liaison Office)

1/F Unit D, Building 1, Kanghong Orange Science Park, No.157, Keyuan3rd Road, Fengjing/Yan Yuan, Xian, Shaanxi, China 710086  
 中国·西安·沣东新城科里三路157号康鸿橙方科技园1号楼D单元1层 邮编: 710086

t (86-29) 6282 7885 www.sgs.com.cn  
 t (86-29) 6282 7885 sgs.china@sgs.com





Report No.: XEWA2310000070RG05

Rev.: 01

Page: 57 of 267

TestMode	Channel	Radar Type	Trial ID	Burst ID	Burst Offset (µs)	Chirp Width (MHz)	Number Of Pulses	Pulse Width (µs)	PRI1 (µs)	PRI2 (µs)	PRI3 (µs)	Detection (1: Yes; 0: No)
11ac80MIMO	5530	Type5	5	0	15438.0	12	3	92.9	1085.0	1564.0	1407.0	1
11ac80MIMO	5530	Type5	5	1	222486.0	12	2	67.7	1744.0	1747.0	---	1
11ac80MIMO	5530	Type5	5	2	430731.0	12	1	65.8	1092.0	---	---	1
11ac80MIMO	5530	Type5	5	3	637784.0	12	1	56.3	1851.0	---	---	1
11ac80MIMO	5530	Type5	5	4	845342.0	12	1	53.7	1727.0	---	---	1
11ac80MIMO	5530	Type5	5	5	196720.0	12	3	83.5	1679.0	1930.0	1025.0	1
11ac80MIMO	5530	Type5	5	6	404955.0	12	1	65.8	1519.0	---	---	1
11ac80MIMO	5530	Type5	5	7	610711.0	12	3	85.9	1134.0	1034.0	1808.0	1
11ac80MIMO	5530	Type5	5	8	818057.0	12	2	76.3	1606.0	1926.0	---	1
11ac80MIMO	5530	Type5	5	9	171459.0	12	2	81.5	1891.0	1714.0	---	1
11ac80MIMO	5530	Type5	5	10	377969.0	12	3	89.4	1310.0	1594.0	1827.0	1
11ac80MIMO	5530	Type5	5	11	586875.0	12	1	63.4	1568.0	---	---	1
11ac80MIMO	5530	Type5	5	12	792834.0	12	2	69.6	1307.0	1925.0	---	1
11ac80MIMO	5530	Type5	5	13	146044.0	12	2	74.5	1264.0	1846.0	---	1
11ac40MIMO	5510	Type5	5	0	15438.0	12	3	92.9	1085.0	1564.0	1407.0	1
11ac40MIMO	5510	Type5	5	1	222486.0	12	2	67.7	1744.0	1747.0	---	1
11ac40MIMO	5510	Type5	5	2	430731.0	12	1	65.8	1092.0	---	---	1
11ac40MIMO	5510	Type5	5	3	637784.0	12	1	56.3	1851.0	---	---	1
11ac40MIMO	5510	Type5	5	4	845342.0	12	1	53.7	1727.0	---	---	1
11ac40MIMO	5510	Type5	5	5	196720.0	12	3	83.5	1679.0	1930.0	1025.0	1
11ac40MIMO	5510	Type5	5	6	404955.0	12	1	65.8	1519.0	---	---	1
11ac40MIMO	5510	Type5	5	7	610711.0	12	3	85.9	1134.0	1034.0	1808.0	1
11ac40MIMO	5510	Type5	5	8	818057.0	12	2	76.3	1606.0	1926.0	---	1
11ac40MIMO	5510	Type5	5	9	171459.0	12	2	81.5	1891.0	1714.0	---	1
11ac40MIMO	5510	Type5	5	10	377969.0	12	3	89.4	1310.0	1594.0	1827.0	1
11ac40MIMO	5510	Type5	5	11	586875.0	12	1	63.4	1568.0	---	---	1
11ac40MIMO	5510	Type5	5	12	792834.0	12	2	69.6	1307.0	1925.0	---	1
11ac40MIMO	5510	Type5	5	13	146044.0	12	2	74.5	1264.0	1846.0	---	1
11ac20MIMO	5500	Type5	5	0	15438.0	12	3	92.9	1085.0	1564.0	1407.0	1
11ac20MIMO	5500	Type5	5	1	222486.0	12	2	67.7	1744.0	1747.0	---	1
11ac20MIMO	5500	Type5	5	2	430731.0	12	1	65.8	1092.0	---	---	1
11ac20MIMO	5500	Type5	5	3	637784.0	12	1	56.3	1851.0	---	---	1
11ac20MIMO	5500	Type5	5	4	845342.0	12	1	53.7	1727.0	---	---	1
11ac20MIMO	5500	Type5	5	5	196720.0	12	3	83.5	1679.0	1930.0	1025.0	1
11ac20MIMO	5500	Type5	5	6	404955.0	12	1	65.8	1519.0	---	---	1
11ac20MIMO	5500	Type5	5	7	610711.0	12	3	85.9	1134.0	1034.0	1808.0	1
11ac20MIMO	5500	Type5	5	8	818057.0	12	2	76.3	1606.0	1926.0	---	1
11ac20MIMO	5500	Type5	5	9	171459.0	12	2	81.5	1891.0	1714.0	---	1
11ac20MIMO	5500	Type5	5	10	377969.0	12	3	89.4	1310.0	1594.0	1827.0	1
11ac20MIMO	5500	Type5	5	11	586875.0	12	1	63.4	1568.0	---	---	1
11ac20MIMO	5500	Type5	5	12	792834.0	12	2	69.6	1307.0	1925.0	---	1
11ac20MIMO	5500	Type5	5	13	146044.0	12	2	74.5	1264.0	1846.0	---	1



Unless otherwise agreed in writing, this document is issued by the Company subject to its General Conditions of Service printed overleaf, available on request or accessible at <http://www.sgs.com/en/Terms-and-Conditions.aspx> and, for electronic format documents, subject to Terms and Conditions for Electronic Documents at <http://www.sgs.com/en/Terms-and-Conditions/Terms-e-Document.aspx>. Attention is drawn to the limitation of liability, indemnification and jurisdiction issues defined therein. Any holder of this document is advised that information contained herein reflects the Company's findings at the time of its intervention only and within the limits of Client's instructions, if any. The Company's sole responsibility is to its Client and this document does not exonerate parties to a transaction from exercising all their rights and obligations under the transaction documents. This document cannot be reproduced except in full, without prior written approval of the Company. Any unauthorized alteration, forgery or falsification of the content or appearance of this document is unlawful and offenders may be prosecuted to the fullest extent of the law. Unless otherwise stated the results shown in this test report refer only to the sample(s) tested and such sample(s) are retained for 30 days only.

Attention: To check the authenticity of testing/inspection report & certificate, please contact us at telephone: (86-755) 8307 1443, or email: CN.Doccheck@sgs.com  
 (E) Unit D, Building 1, Kanglong Orange Science Park, No.157, Keyuan 3rd Road, Fengdong New Town, Xi'an, Shaanxi, China 710086 t (86-29) 6282 7885 www.sgs.com.cn  
 中国·西安·沣东新城科里三路157号康隆橙方科技园1号楼D单元1层 邮编: 710086 t (86-29) 6282 7885 sgs.china@sgs.com



TestMode	Channel	Radar Type	Trial ID	Burst ID	Burst Offset (µs)	Chirp Width (MHz)	Number Of Pulses	Pulse Width (µs)	PRI1 (µs)	PRI2 (µs)	PRI3 (µs)	Detection (1: Yes; 0: No)
11ac80MIMO	5530	Type5	6	0	329022.0	13	3	96.6	1182.0	1609.0	1581.0	1
11ac80MIMO	5530	Type5	6	1	521718.0	13	3	96.7	1829.0	1799.0	1154.0	1
11ac80MIMO	5530	Type5	6	2	714222.0	13	3	86.5	1923.0	1396.0	1865.0	1
11ac80MIMO	5530	Type5	6	3	112450.0	13	2	73.3	1908.0	1318.0	---	1
11ac80MIMO	5530	Type5	6	4	306283.0	13	1	55.8	1688.0	---	---	1
11ac80MIMO	5530	Type5	6	5	500239.0	13	1	55.4	1145.0	---	---	1
11ac80MIMO	5530	Type5	6	6	690932.0	13	3	85.3	1336.0	1504.0	1820.0	1
11ac80MIMO	5530	Type5	6	7	88645.0	13	2	79.4	1344.0	1893.0	---	1
11ac80MIMO	5530	Type5	6	8	282508.0	13	1	65.7	1476.0	---	---	1
11ac80MIMO	5530	Type5	6	9	475842.0	13	2	68.6	1008.0	1028.0	---	1
11ac80MIMO	5530	Type5	6	10	667887.0	13	2	77.7	1972.0	1835.0	---	1
11ac80MIMO	5530	Type5	6	11	64845.0	13	2	79.6	1882.0	1331.0	---	1
11ac80MIMO	5530	Type5	6	12	257755.0	13	3	94.9	1830.0	1070.0	1349.0	1
11ac80MIMO	5530	Type5	6	13	452335.0	13	1	61.4	1451.0	---	---	1
11ac80MIMO	5530	Type5	6	14	643395.0	13	3	90.6	1233.0	1562.0	1887.0	1
11ac40MIMO	5510	Type5	6	0	329022.0	13	3	96.6	1182.0	1609.0	1581.0	1
11ac40MIMO	5510	Type5	6	1	521718.0	13	3	96.7	1829.0	1799.0	1154.0	1
11ac40MIMO	5510	Type5	6	2	714222.0	13	3	86.5	1923.0	1396.0	1865.0	1
11ac40MIMO	5510	Type5	6	3	112450.0	13	2	73.3	1908.0	1318.0	---	1
11ac40MIMO	5510	Type5	6	4	306283.0	13	1	55.8	1688.0	---	---	1
11ac40MIMO	5510	Type5	6	5	500239.0	13	1	55.4	1145.0	---	---	1
11ac40MIMO	5510	Type5	6	6	690932.0	13	3	85.3	1336.0	1504.0	1820.0	1
11ac40MIMO	5510	Type5	6	7	88645.0	13	2	79.4	1344.0	1893.0	---	1
11ac40MIMO	5510	Type5	6	8	282508.0	13	1	65.7	1476.0	---	---	1
11ac40MIMO	5510	Type5	6	9	475842.0	13	2	68.6	1008.0	1028.0	---	1
11ac40MIMO	5510	Type5	6	10	667887.0	13	2	77.7	1972.0	1835.0	---	1
11ac40MIMO	5510	Type5	6	11	64845.0	13	2	79.6	1882.0	1331.0	---	1
11ac40MIMO	5510	Type5	6	12	257755.0	13	3	94.9	1830.0	1070.0	1349.0	1
11ac40MIMO	5510	Type5	6	13	452335.0	13	1	61.4	1451.0	---	---	1
11ac40MIMO	5510	Type5	6	14	643395.0	13	3	90.6	1233.0	1562.0	1887.0	1
11ac20MIMO	5500	Type5	6	0	329022.0	13	3	96.6	1182.0	1609.0	1581.0	1
11ac20MIMO	5500	Type5	6	1	521718.0	13	3	96.7	1829.0	1799.0	1154.0	1
11ac20MIMO	5500	Type5	6	2	714222.0	13	3	86.5	1923.0	1396.0	1865.0	1
11ac20MIMO	5500	Type5	6	3	112450.0	13	2	73.3	1908.0	1318.0	---	1
11ac20MIMO	5500	Type5	6	4	306283.0	13	1	55.8	1688.0	---	---	1
11ac20MIMO	5500	Type5	6	5	500239.0	13	1	55.4	1145.0	---	---	1
11ac20MIMO	5500	Type5	6	6	690932.0	13	3	85.3	1336.0	1504.0	1820.0	1
11ac20MIMO	5500	Type5	6	7	88645.0	13	2	79.4	1344.0	1893.0	---	1
11ac20MIMO	5500	Type5	6	8	282508.0	13	1	65.7	1476.0	---	---	1
11ac20MIMO	5500	Type5	6	9	475842.0	13	2	68.6	1008.0	1028.0	---	1
11ac20MIMO	5500	Type5	6	10	667887.0	13	2	77.7	1972.0	1835.0	---	1
11ac20MIMO	5500	Type5	6	11	64845.0	13	2	79.6	1882.0	1331.0	---	1
11ac20MIMO	5500	Type5	6	12	257755.0	13	3	94.9	1830.0	1070.0	1349.0	1
11ac20MIMO	5500	Type5	6	13	452335.0	13	1	61.4	1451.0	---	---	1
11ac20MIMO	5500	Type5	6	14	643395.0	13	3	90.6	1233.0	1562.0	1887.0	1



Unless otherwise agreed in writing, this document is issued by the Company subject to its General Conditions of Service printed overleaf, available on request or accessible at <http://www.sgs.com/en/Terms-and-Conditions.aspx> and, for electronic format documents, subject to Terms and Conditions for Electronic Documents at <http://www.sgs.com/en/Terms-and-Conditions/Terms-e-Documents.aspx>. Attention is drawn to the limitation of liability, indemnification and jurisdiction issues defined therein. Any holder of this document is advised that information contained herein reflects the Company's findings at the time of its intervention only and within the limits of Client's instructions, if any. The Company's sole responsibility is to its Client and this document does not exonerate parties to a transaction from exercising all their rights and obligations under the transaction documents. This document cannot be reproduced except in full, without prior written approval of the Company. Any unauthorized alteration, forgery or falsification of the content or appearance of this document is unlawful and offenders may be prosecuted to the fullest extent of the law. Unless otherwise stated the results shown in this test report refer only to the sample(s) tested and such sample(s) are retained for 30 days only.

Attention: To check the authenticity of testing/inspection report & certificate, please contact us at telephone: (86-755) 8307 1443, or email: [CN.Doccheck@sgs.com](mailto:CN.Doccheck@sgs.com)

SGS-CSTC Standards Technical Services (Xi'an) Co., Ltd. | 1/E Unit D, Building 1, Kanglong Orange Science Park, No.157, Keyan 3rd Road, Fengling New Town, Xi'an, Shaanxi, China | 710086 | t: (86-29) 6282 7885 | www.sgs.com.cn  
 中国·西安·沣东新城科里三路157号康隆橙方科技园1号楼D单元1层 | 邮编: 710086 | t: (86-29) 6282 7885 | sgs.china@sgs.com



TestMode	Channel	Radar Type	Trial ID	Burst ID	Burst Offset (µs)	Chirp Width (MHz)	Number Of Pulses	Pulse Width (µs)	PRI1 (µs)	PRI2 (µs)	PRI3 (µs)	Detection (1: Yes; 0: No)
11ac80MIMO	5530	Type5	7	0	51446.0	10	1	52.6	1210.0	---	---	1
11ac80MIMO	5530	Type5	7	1	292696.0	10	3	84.1	1314.0	1725.0	1529.0	1
11ac80MIMO	5530	Type5	7	2	533989.0	10	3	97.7	1139.0	1868.0	1805.0	1
11ac80MIMO	5530	Type5	7	3	775564.0	10	3	97.3	1341.0	1446.0	1755.0	1
11ac80MIMO	5530	Type5	7	4	21542.0	10	3	98.8	1544.0	1386.0	1302.0	1
11ac80MIMO	5530	Type5	7	5	263385.0	10	2	72.2	1771.0	1184.0	---	1
11ac80MIMO	5530	Type5	7	6	505581.0	10	2	67.6	1175.0	1027.0	---	1
11ac80MIMO	5530	Type5	7	7	747058.0	10	2	75.7	1026.0	1871.0	---	1
11ac80MIMO	5530	Type5	7	8	989976.0	10	1	60.9	1798.0	---	---	1
11ac80MIMO	5530	Type5	7	9	234024.0	10	1	64.2	1138.0	---	---	1
11ac80MIMO	5530	Type5	7	10	475207.0	10	2	78.8	1784.0	1604.0	---	1
11ac80MIMO	5530	Type5	7	11	715825.0	10	3	87.5	1511.0	1712.0	1683.0	1
11ac40MIMO	5510	Type5	7	0	51446.0	10	1	52.6	1210.0	---	---	1
11ac40MIMO	5510	Type5	7	1	292696.0	10	3	84.1	1314.0	1725.0	1529.0	1
11ac40MIMO	5510	Type5	7	2	533989.0	10	3	97.7	1139.0	1868.0	1805.0	1
11ac40MIMO	5510	Type5	7	3	775564.0	10	3	97.3	1341.0	1446.0	1755.0	1
11ac40MIMO	5510	Type5	7	4	21542.0	10	3	98.8	1544.0	1386.0	1302.0	1
11ac40MIMO	5510	Type5	7	5	263385.0	10	2	72.2	1771.0	1184.0	---	1
11ac40MIMO	5510	Type5	7	6	505581.0	10	2	67.6	1175.0	1027.0	---	1
11ac40MIMO	5510	Type5	7	7	747058.0	10	2	75.7	1026.0	1871.0	---	1
11ac40MIMO	5510	Type5	7	8	989976.0	10	1	60.9	1798.0	---	---	1
11ac40MIMO	5510	Type5	7	9	234024.0	10	1	64.2	1138.0	---	---	1
11ac40MIMO	5510	Type5	7	10	475207.0	10	2	78.8	1784.0	1604.0	---	1
11ac40MIMO	5510	Type5	7	11	715825.0	10	3	87.5	1511.0	1712.0	1683.0	1
11ac20MIMO	5500	Type5	7	0	51446.0	10	1	52.6	1210.0	---	---	1
11ac20MIMO	5500	Type5	7	1	292696.0	10	3	84.1	1314.0	1725.0	1529.0	1
11ac20MIMO	5500	Type5	7	2	533989.0	10	3	97.7	1139.0	1868.0	1805.0	1
11ac20MIMO	5500	Type5	7	3	775564.0	10	3	97.3	1341.0	1446.0	1755.0	1
11ac20MIMO	5500	Type5	7	4	21542.0	10	3	98.8	1544.0	1386.0	1302.0	1
11ac20MIMO	5500	Type5	7	5	263385.0	10	2	72.2	1771.0	1184.0	---	1
11ac20MIMO	5500	Type5	7	6	505581.0	10	2	67.6	1175.0	1027.0	---	1
11ac20MIMO	5500	Type5	7	7	747058.0	10	2	75.7	1026.0	1871.0	---	1
11ac20MIMO	5500	Type5	7	8	989976.0	10	1	60.9	1798.0	---	---	1
11ac20MIMO	5500	Type5	7	9	234024.0	10	1	64.2	1138.0	---	---	1
11ac20MIMO	5500	Type5	7	10	475207.0	10	2	78.8	1784.0	1604.0	---	1
11ac20MIMO	5500	Type5	7	11	715825.0	10	3	87.5	1511.0	1712.0	1683.0	1



Unless otherwise agreed in writing, this document is issued by the Company subject to its General Conditions of Service printed overleaf, available on request or accessible at <http://www.sgs.com/en/Terms-and-Conditions.aspx> and, for electronic format documents, subject to Terms and Conditions for Electronic Documents at <http://www.sgs.com/en/Terms-and-Conditions/Terms-e-Documents.aspx>. Attention is drawn to the limitation of liability, indemnification and jurisdiction issues defined therein. Any holder of this document is advised that information contained herein reflects the Company's findings at the time of its intervention only and within the limits of Client's instructions, if any. The Company's sole responsibility is to its Client and this document does not exonerate parties to a transaction from exercising all their rights and obligations under the transaction documents. This document cannot be reproduced except in full, without prior written approval of the Company. Any unauthorized alteration, forgery or falsification of the content or appearance of this document is unlawful and offenders may be prosecuted to the fullest extent of the law. Unless otherwise stated the results shown in this test report refer only to the sample(s) tested and such sample(s) are retained for 30 days only.

Attention: To check the authenticity of testing/inspection report & certificate, please contact us at telephone: (86-755) 4307 1443, or email: CN.Doccheck@sgs.com  
 (X) Ltd D Building 1, Kanghong Orange Science Park, No.137, Keyuan 3rd Road, Fengling New Town, Xi'an, Shaanxi, China 710086 t (86-29) 6282 7885 www.sgs.com.cn  
 中国·西安·沣东新城科园三路137号康鸿橙方科技园1号楼D单元1层 邮编: 710086 t (86-29) 6282 7885 sgs.china@sgs.com



TestMode	Channel	Radar Type	Trial ID	Burst ID	Burst Offset (µs)	Chirp Width (MHz)	Number Of Pulses	Pulse Width (µs)	PRI1 (µs)	PRI2 (µs)	PRI3 (µs)	Detection (1: Yes; 0: No)
11ac80MIMO	5530	Type5	8	0	823112.0	13	1	54.1	1415.0	---	---	1
11ac80MIMO	5530	Type5	8	1	174965.0	13	1	50.7	1221.0	---	---	1
11ac80MIMO	5530	Type5	8	2	382216.0	13	1	52.3	1974.0	---	---	1
11ac80MIMO	5530	Type5	8	3	587395.0	13	3	99.8	1558.0	1696.0	1949.0	1
11ac80MIMO	5530	Type5	8	4	796897.0	13	2	68.4	1014.0	1099.0	---	1
11ac80MIMO	5530	Type5	8	5	149042.0	13	2	80.8	1736.0	1505.0	---	1
11ac80MIMO	5530	Type5	8	6	356750.0	13	1	62.5	1778.0	---	---	1
11ac80MIMO	5530	Type5	8	7	563824.0	13	2	74.8	1149.0	1204.0	---	1
11ac80MIMO	5530	Type5	8	8	772314.0	13	1	50.8	1049.0	---	---	1
11ac80MIMO	5530	Type5	8	9	123796.0	13	1	54.0	1417.0	---	---	1
11ac80MIMO	5530	Type5	8	10	331215.0	13	1	63.0	1730.0	---	---	1
11ac80MIMO	5530	Type5	8	11	537402.0	13	3	91.8	1143.0	1270.0	1347.0	1
11ac80MIMO	5530	Type5	8	12	744805.0	13	2	79.3	1274.0	1992.0	---	1
11ac80MIMO	5530	Type5	8	13	98172.0	13	1	64.3	1937.0	---	---	1
11ac40MIMO	5510	Type5	8	0	823112.0	13	1	54.1	1415.0	---	---	1
11ac40MIMO	5510	Type5	8	1	174965.0	13	1	50.7	1221.0	---	---	1
11ac40MIMO	5510	Type5	8	2	382216.0	13	1	52.3	1974.0	---	---	1
11ac40MIMO	5510	Type5	8	3	587395.0	13	3	99.8	1558.0	1696.0	1949.0	1
11ac40MIMO	5510	Type5	8	4	796897.0	13	2	68.4	1014.0	1099.0	---	1
11ac40MIMO	5510	Type5	8	5	149042.0	13	2	80.8	1736.0	1505.0	---	1
11ac40MIMO	5510	Type5	8	6	356750.0	13	1	62.5	1778.0	---	---	1
11ac40MIMO	5510	Type5	8	7	563824.0	13	2	74.8	1149.0	1204.0	---	1
11ac40MIMO	5510	Type5	8	8	772314.0	13	1	50.8	1049.0	---	---	1
11ac40MIMO	5510	Type5	8	9	123796.0	13	1	54.0	1417.0	---	---	1
11ac40MIMO	5510	Type5	8	10	331215.0	13	1	63.0	1730.0	---	---	1
11ac40MIMO	5510	Type5	8	11	537402.0	13	3	91.8	1143.0	1270.0	1347.0	1
11ac40MIMO	5510	Type5	8	12	744805.0	13	2	79.3	1274.0	1992.0	---	1
11ac40MIMO	5510	Type5	8	13	98172.0	13	1	64.3	1937.0	---	---	1
11ac20MIMO	5500	Type5	8	0	823112.0	13	1	54.1	1415.0	---	---	1
11ac20MIMO	5500	Type5	8	1	174965.0	13	1	50.7	1221.0	---	---	1
11ac20MIMO	5500	Type5	8	2	382216.0	13	1	52.3	1974.0	---	---	1
11ac20MIMO	5500	Type5	8	3	587395.0	13	3	99.8	1558.0	1696.0	1949.0	1
11ac20MIMO	5500	Type5	8	4	796897.0	13	2	68.4	1014.0	1099.0	---	1
11ac20MIMO	5500	Type5	8	5	149042.0	13	2	80.8	1736.0	1505.0	---	1
11ac20MIMO	5500	Type5	8	6	356750.0	13	1	62.5	1778.0	---	---	1
11ac20MIMO	5500	Type5	8	7	563824.0	13	2	74.8	1149.0	1204.0	---	1
11ac20MIMO	5500	Type5	8	8	772314.0	13	1	50.8	1049.0	---	---	1
11ac20MIMO	5500	Type5	8	9	123796.0	13	1	54.0	1417.0	---	---	1
11ac20MIMO	5500	Type5	8	10	331215.0	13	1	63.0	1730.0	---	---	1
11ac20MIMO	5500	Type5	8	11	537402.0	13	3	91.8	1143.0	1270.0	1347.0	1
11ac20MIMO	5500	Type5	8	12	744805.0	13	2	79.3	1274.0	1992.0	---	1
11ac20MIMO	5500	Type5	8	13	98172.0	13	1	64.3	1937.0	---	---	1



Unless otherwise agreed in writing, this document is issued by the Company subject to its General Conditions of Service printed overleaf, available on request or accessible at <http://www.sgs.com/en/Terms-and-Conditions.aspx> and, for electronic format documents, subject to Terms and Conditions for Electronic Documents at <http://www.sgs.com/en/Terms-and-Conditions/Terms-e-Documents.aspx>. Attention is drawn to the limitation of liability, indemnification and jurisdiction issues defined therein. Any holder of this document is advised that information contained herein reflects the Company's findings at the time of its intervention only and within the limits of Client's instructions, if any. The Company's sole responsibility is to its Client and this document does not exonerate parties to a transaction from exercising all their rights and obligations under the transaction documents. This document cannot be reproduced except in full, without prior written approval of the Company. Any unauthorized alteration, forgery or falsification of the content or appearance of this document is unlawful and offenders may be prosecuted to the fullest extent of the law. Unless otherwise stated the results shown in this test report refer only to the sample(s) tested and such sample(s) are retained for 30 days only.

Attention: To check the authenticity of testing/inspection report & certificate, please contact us at telephone: (86-755) 8307 1443, or email: CN.Doccheck@sgs.com  
 1/E Unit D, Building 1, Kanglong Orange Science Park, No.137, Keyuan 3rd Road, Fengling New Town, Xi'an, Shaanxi, China 710086 t (86-29) 6282 7885 www.sgs.com.cn  
 中国·西安·沣东新城科园三路137号康隆橙方科技园1号楼D单元1层 邮编: 710086 t (86-29) 6282 7885 sgs.china@sgs.com

Report No.: XEWA2310000070RG05  
 Rev.: 01  
 Page: 61 of 267

TestMode	Channel	Radar Type	Trial ID	Burst ID	Burst Offset (μs)	Chirp Width (MHz)	Number Of Pulses	Pulse Width (μs)	PRI1 (μs)	PRI2 (μs)	PRI3 (μs)	Detection (1: Yes; 0: No)
11ac80MIMO	5530	Type5	9	0	535615.0	6	1	63.4	1043.0	---	---	1
11ac80MIMO	5530	Type5	9	1	898668.0	6	1	52.0	1863.0	---	---	1
11ac80MIMO	5530	Type5	9	2	1259235.0	6	3	97.2	1973.0	1605.0	1583.0	1
11ac80MIMO	5530	Type5	9	3	127106.0	6	2	78.7	1466.0	1743.0	---	1
11ac80MIMO	5530	Type5	9	4	490358.0	6	2	74.2	1280.0	1219.0	---	1
11ac80MIMO	5530	Type5	9	5	852409.0	6	3	88.7	1293.0	1934.0	1273.0	1
11ac80MIMO	5530	Type5	9	6	1217152.0	6	1	54.3	1991.0	---	---	1
11ac80MIMO	5530	Type5	9	7	82296.0	6	3	95.4	1580.0	1555.0	1791.0	1
11ac40MIMO	5510	Type5	9	0	535615.0	6	1	63.4	1043.0	---	---	1
11ac40MIMO	5510	Type5	9	1	898668.0	6	1	52.0	1863.0	---	---	1
11ac40MIMO	5510	Type5	9	2	1259235.0	6	3	97.2	1973.0	1605.0	1583.0	1
11ac40MIMO	5510	Type5	9	3	127106.0	6	2	78.7	1466.0	1743.0	---	1
11ac40MIMO	5510	Type5	9	4	490358.0	6	2	74.2	1280.0	1219.0	---	1
11ac40MIMO	5510	Type5	9	5	852409.0	6	3	88.7	1293.0	1934.0	1273.0	1
11ac40MIMO	5510	Type5	9	6	1217152.0	6	1	54.3	1991.0	---	---	1
11ac40MIMO	5510	Type5	9	7	82296.0	6	3	95.4	1580.0	1555.0	1791.0	1
11ac20MIMO	5500	Type5	9	0	535615.0	6	1	63.4	1043.0	---	---	1
11ac20MIMO	5500	Type5	9	1	898668.0	6	1	52.0	1863.0	---	---	1
11ac20MIMO	5500	Type5	9	2	1259235.0	6	3	97.2	1973.0	1605.0	1583.0	1
11ac20MIMO	5500	Type5	9	3	127106.0	6	2	78.7	1466.0	1743.0	---	1
11ac20MIMO	5500	Type5	9	4	490358.0	6	2	74.2	1280.0	1219.0	---	1
11ac20MIMO	5500	Type5	9	5	852409.0	6	3	88.7	1293.0	1934.0	1273.0	1
11ac20MIMO	5500	Type5	9	6	1217152.0	6	1	54.3	1991.0	---	---	1
11ac20MIMO	5500	Type5	9	7	82296.0	6	3	95.4	1580.0	1555.0	1791.0	1



Unless otherwise agreed in writing, this document is issued by the Company subject to its General Conditions of Service printed overleaf, available on request or accessible at <http://www.sgs.com/en/Terms-and-Conditions.aspx> and, for electronic format documents, subject to Terms and Conditions for Electronic Documents at <http://www.sgs.com/en/Terms-and-Conditions/Terms-e-Documents.aspx>. Attention is drawn to the limitation of liability, indemnification and jurisdiction issues defined therein. Any holder of this document is advised that information contained herein reflects the Company's findings at the time of its intervention only and within the limits of Client's instructions, if any. The Company's sole responsibility is to its Client and this document does not exonerate parties to a transaction from exercising all their rights and obligations under the transaction documents. This document cannot be reproduced except in full, without prior written approval of the Company. Any unauthorized alteration, forgery or falsification of the content or appearance of this document is unlawful and offenders may be prosecuted to the fullest extent of the law. Unless otherwise stated the results shown in this test report refer only to the sample(s) tested and such sample(s) are retained for 30 days only.

Attention: To check the authenticity of testing/inspection report & certificate, please contact us at telephone: (86-755) 8307 1443, or email: [CN.Doccheck@sgs.com](mailto:CN.Doccheck@sgs.com)  
 (X'ian) Ltd D. Building 1, Kanghong Orange Science Park, No.137, Kejun 3rd Road, Fengling New Town, Xi'an, Shaanxi, China 710086 t (86-29) 6282 7885 www.sgs.com.cn  
 中国·西安·沣东新城科园三路137号康鸿橙方科技园1号楼D单元1层 邮编: 710086 t (86-29) 6282 7885 sgs.china@sgs.com



Report No.: XEWA2310000070RG05
Rev.: 01
Page: 62 of 267

Table with 13 columns: TestMode, Channel, Radar Type, Trial ID, Burst ID, Burst Offset (µs), Chirp Width (MHz), Number Of Pulses, Pulse Width (µs), PRI1 (µs), PRI2 (µs), PRI3 (µs), Detection (1: Yes; 0: No). Rows include test data for 11ac80MIMO, 11ac40MIMO, and 11ac20MIMO channels.



Unless otherwise agreed in writing, this document is issued by the Company subject to its General Conditions of Service printed overleaf... Attention: To check the authenticity of testing/inspection report & certificate, please contact us at telephone: (86-755) 8307 1443, or email: CN\_Doccheck@sgs.com



Report No.: XEWA2310000070RG05

Rev.: 01

Page: 63 of 267

TestMode	Channel	Radar Type	Trial ID	Burst ID	Burst Offset (µs)	Chirp Width (MHz)	Number Of Pulses	Pulse Width (µs)	PRI1 (µs)	PRI2 (µs)	PRI3 (µs)	Detection (1: Yes; 0: No)
11ac80MIMO	5530	Type5	11	0	263736.0	19	3	98.9	1381.0	1680.0	1488.0	1
11ac80MIMO	5530	Type5	11	1	416459.0	19	2	82.3	1716.0	1855.0	---	1
11ac80MIMO	5530	Type5	11	2	567902.0	19	3	86.7	1211.0	1400.0	1919.0	1
11ac80MIMO	5530	Type5	11	3	92979.0	19	3	89.7	1861.0	1068.0	1282.0	1
11ac80MIMO	5530	Type5	11	4	245155.0	19	3	98.6	1507.0	1194.0	1461.0	1
11ac80MIMO	5530	Type5	11	5	397609.0	19	2	71.1	1921.0	1789.0	---	1
11ac80MIMO	5530	Type5	11	6	551431.0	19	1	55.9	1947.0	---	---	1
11ac80MIMO	5530	Type5	11	7	74413.0	19	2	67.9	1350.0	1372.0	---	1
11ac80MIMO	5530	Type5	11	8	226559.0	19	3	84.4	1203.0	1107.0	1443.0	1
11ac80MIMO	5530	Type5	11	9	380056.0	19	1	58.8	1715.0	---	---	1
11ac80MIMO	5530	Type5	11	10	533408.0	19	1	65.6	1017.0	---	---	1
11ac80MIMO	5530	Type5	11	11	55547.0	19	2	78.5	1911.0	1704.0	---	1
11ac80MIMO	5530	Type5	11	12	207876.0	19	2	82.3	1845.0	1686.0	---	1
11ac80MIMO	5530	Type5	11	13	359771.0	19	3	90.1	1938.0	1071.0	1266.0	1
11ac80MIMO	5530	Type5	11	14	511297.0	19	3	90.2	1989.0	1089.0	1950.0	1
11ac80MIMO	5530	Type5	11	15	36803.0	19	2	83.1	1943.0	1406.0	---	1
11ac80MIMO	5530	Type5	11	16	189652.0	19	1	58.8	1742.0	---	---	1
11ac80MIMO	5530	Type5	11	17	341809.0	19	2	77.0	1187.0	1657.0	---	1
11ac80MIMO	5530	Type5	11	18	495737.0	19	1	55.0	1012.0	---	---	1
11ac40MIMO	5510	Type5	11	0	263736.0	19	3	98.9	1381.0	1680.0	1488.0	1
11ac40MIMO	5510	Type5	11	1	416459.0	19	2	82.3	1716.0	1855.0	---	1
11ac40MIMO	5510	Type5	11	2	567902.0	19	3	86.7	1211.0	1400.0	1919.0	1
11ac40MIMO	5510	Type5	11	3	92979.0	19	3	89.7	1861.0	1068.0	1282.0	1
11ac40MIMO	5510	Type5	11	4	245155.0	19	3	98.6	1507.0	1194.0	1461.0	1
11ac40MIMO	5510	Type5	11	5	397609.0	19	2	71.1	1921.0	1789.0	---	1
11ac40MIMO	5510	Type5	11	6	551431.0	19	1	55.9	1947.0	---	---	1
11ac40MIMO	5510	Type5	11	7	74413.0	19	2	67.9	1350.0	1372.0	---	1
11ac40MIMO	5510	Type5	11	8	226559.0	19	3	84.4	1203.0	1107.0	1443.0	1
11ac40MIMO	5510	Type5	11	9	380056.0	19	1	58.8	1715.0	---	---	1
11ac40MIMO	5510	Type5	11	10	533408.0	19	1	65.6	1017.0	---	---	1
11ac40MIMO	5510	Type5	11	11	55547.0	19	2	78.5	1911.0	1704.0	---	1
11ac40MIMO	5510	Type5	11	12	207876.0	19	2	82.3	1845.0	1686.0	---	1
11ac40MIMO	5510	Type5	11	13	359771.0	19	3	90.1	1938.0	1071.0	1266.0	1
11ac40MIMO	5510	Type5	11	14	511297.0	19	3	90.2	1989.0	1089.0	1950.0	1
11ac40MIMO	5510	Type5	11	15	36803.0	19	2	83.1	1943.0	1406.0	---	1
11ac40MIMO	5510	Type5	11	16	189652.0	19	1	58.8	1742.0	---	---	1
11ac40MIMO	5510	Type5	11	17	341809.0	19	2	77.0	1187.0	1657.0	---	1
11ac40MIMO	5510	Type5	11	18	495737.0	19	1	55.0	1012.0	---	---	1
11ac20MIMO	5500	Type5	11	0	263736.0	19	3	98.9	1381.0	1680.0	1488.0	1
11ac20MIMO	5500	Type5	11	1	416459.0	19	2	82.3	1716.0	1855.0	---	1
11ac20MIMO	5500	Type5	11	2	567902.0	19	3	86.7	1211.0	1400.0	1919.0	1
11ac20MIMO	5500	Type5	11	3	92979.0	19	3	89.7	1861.0	1068.0	1282.0	1
11ac20MIMO	5500	Type5	11	4	245155.0	19	3	98.6	1507.0	1194.0	1461.0	1
11ac20MIMO	5500	Type5	11	5	397609.0	19	2	71.1	1921.0	1789.0	---	1
11ac20MIMO	5500	Type5	11	6	551431.0	19	1	55.9	1947.0	---	---	1
11ac20MIMO	5500	Type5	11	7	74413.0	19	2	67.9	1350.0	1372.0	---	1
11ac20MIMO	5500	Type5	11	8	226559.0	19	3	84.4	1203.0	1107.0	1443.0	1
11ac20MIMO	5500	Type5	11	9	380056.0	19	1	58.8	1715.0	---	---	1



Unless otherwise agreed in writing, this document is issued by the Company subject to its General Conditions of Service printed overleaf, available on request or accessible at <http://www.sgs.com/en/Terms-and-Conditions.aspx> and, for electronic format documents, subject to Terms and Conditions for Electronic Documents at <http://www.sgs.com/en/Terms-and-Conditions/Terms-e-Document.aspx>. Attention is drawn to the limitation of liability, indemnification and jurisdiction issues defined therein. Any holder of this document is advised that information contained herein reflects the Company's findings at the time of its intervention only and within the limits of Client's instructions, if any. The Company's sole responsibility is to its Client and this document does not exonerate parties to a transaction from exercising all their rights and obligations under the transaction documents. This document cannot be reproduced except in full, without prior written approval of the Company. Any unauthorized alteration, forgery or falsification of the content or appearance of this document is unlawful and offenders may be prosecuted to the fullest extent of the law. Unless otherwise stated the results shown in this test report refer only to the sample(s) tested and such sample(s) are retained for 30 days only.

Attention: To check the authenticity of testing/inspection report & certificate, please contact us at telephone: (86-755) 8307 1443, or email: CN\_Doccheck@sgs.com

SGS-CSTC Standards Technical Services (Xi'an) Co., Ltd.  
Xi'an, Shaanxi

1/E Unit D, Building 1, Kanglong Orange Source Park, No.157, Keyuan 3rd Road, Fengfeng/Yan Tan, Xi'an, Shaanxi, China 710086  
中国·西安·沣东新城科里三路137号康隆橙方科技园1号楼D单元1层 邮编: 710086

t (86-29) 6282 7885 www.sgs.com.cn  
t (86-29) 6282 7885 sgs.china@sgs.com

Report No.: XEWA2310000070RG05

Rev.: 01

Page: 64 of 267

11ac20MIMO	5500	Type5	11	10	533408.0	19	1	65.6	1017.0	---	---	1
11ac20MIMO	5500	Type5	11	11	55547.0	19	2	78.5	1911.0	1704.0	---	1
11ac20MIMO	5500	Type5	11	12	207876.0	19	2	82.3	1845.0	1686.0	---	1
11ac20MIMO	5500	Type5	11	13	359771.0	19	3	90.1	1938.0	1071.0	1266.0	1
11ac20MIMO	5500	Type5	11	14	511297.0	19	3	90.2	1989.0	1089.0	1950.0	1
11ac20MIMO	5500	Type5	11	15	36803.0	19	2	83.1	1943.0	1406.0	---	1
11ac20MIMO	5500	Type5	11	16	189652.0	19	1	58.8	1742.0	---	---	1
11ac20MIMO	5500	Type5	11	17	341809.0	19	2	77.0	1187.0	1657.0	---	1
11ac20MIMO	5500	Type5	11	18	495737.0	19	1	55.0	1012.0	---	---	1



Unless otherwise agreed in writing, this document is issued by the Company subject to its General Conditions of Service printed overleaf, available on request or accessible at <http://www.sgs.com/en/Terms-and-Conditions.aspx> and, for electronic format documents, subject to Terms and Conditions for Electronic Documents at <http://www.sgs.com/en/Terms-and-Conditions/Terms-e-Documents.aspx>. Attention is drawn to the limitation of liability, indemnification and jurisdiction issues defined therein. Any holder of this document is advised that information contained herein reflects the Company's findings at the time of its intervention only and within the limits of Client's instructions, if any. The Company's sole responsibility is to its Client and this document does not exonerate parties to a transaction from exercising all their rights and obligations under the transaction documents. This document cannot be reproduced except in full, without prior written approval of the Company. Any unauthorized alteration, forgery or falsification of the content or appearance of this document is unlawful and offenders may be prosecuted to the fullest extent of the law. Unless otherwise stated the results shown in this test report refer only to the sample(s) tested and such sample(s) are retained for 30 days only.

Attention: To check the authenticity of testing/inspection report & certificate, please contact us at telephone: (86-755) 8307 1443, or email: [CN.Doccheck@sgs.com](mailto:CN.Doccheck@sgs.com)

(E) Unit D, Building 1, Kanghong Orange Science Park, No.137, Kejun3rd Road, Fengcheng New Town, Xi'an, Shaanxi, China 710086      t (86-29) 6282 7885      www.sgs.com.cn  
 中国·西安·沣东新城科园三路137号康鸿橙方科技园1号楼D单元1层      邮编: 710086      t (86-29) 6282 7885      sgs.china@sgs.com





Report No.: XEWA2310000070RG05

Rev.: 01

Page: 65 of 267

TestMode	Channel	Radar Type	Trial ID	Burst ID	Burst Offset (µs)	Chirp Width (MHz)	Number Of Pulses	Pulse Width (µs)	PRI1 (µs)	PRI2 (µs)	PRI3 (µs)	Detection (1: Yes; 0: No)
11ac80MIMO	5530	Type5	12	0	22911.0	13	1	58.1	1929.0	---	---	1
11ac80MIMO	5530	Type5	12	1	216473.0	13	1	52.1	1910.0	---	---	1
11ac80MIMO	5530	Type5	12	2	410004.0	13	1	59.9	1971.0	---	---	1
11ac80MIMO	5530	Type5	12	3	603671.0	13	1	60.2	1812.0	---	---	1
11ac80MIMO	5530	Type5	12	4	794160.0	13	3	95.9	1399.0	1906.0	1608.0	1
11ac80MIMO	5530	Type5	12	5	192251.0	13	2	79.9	1626.0	1859.0	---	1
11ac80MIMO	5530	Type5	12	6	385590.0	13	2	78.5	1238.0	1917.0	---	1
11ac80MIMO	5530	Type5	12	7	579862.0	13	1	53.8	1763.0	---	---	1
11ac80MIMO	5530	Type5	12	8	773423.0	13	1	64.7	1800.0	---	---	1
11ac80MIMO	5530	Type5	12	9	168898.0	13	1	61.4	1390.0	---	---	1
11ac80MIMO	5530	Type5	12	10	361606.0	13	2	83.2	1692.0	1858.0	---	1
11ac80MIMO	5530	Type5	12	11	553866.0	13	3	84.7	1533.0	1677.0	1638.0	1
11ac80MIMO	5530	Type5	12	12	747241.0	13	3	88.7	1703.0	1528.0	1058.0	1
11ac80MIMO	5530	Type5	12	13	144710.0	13	2	78.3	1258.0	1951.0	---	1
11ac80MIMO	5530	Type5	12	14	337856.0	13	2	69.3	1731.0	1717.0	---	1
11ac40MIMO	5510	Type5	12	0	22911.0	13	1	58.1	1929.0	---	---	1
11ac40MIMO	5510	Type5	12	1	216473.0	13	1	52.1	1910.0	---	---	1
11ac40MIMO	5510	Type5	12	2	410004.0	13	1	59.9	1971.0	---	---	1
11ac40MIMO	5510	Type5	12	3	603671.0	13	1	60.2	1812.0	---	---	1
11ac40MIMO	5510	Type5	12	4	794160.0	13	3	95.9	1399.0	1906.0	1608.0	1
11ac40MIMO	5510	Type5	12	5	192251.0	13	2	79.9	1626.0	1859.0	---	1
11ac40MIMO	5510	Type5	12	6	385590.0	13	2	78.5	1238.0	1917.0	---	1
11ac40MIMO	5510	Type5	12	7	579862.0	13	1	53.8	1763.0	---	---	1
11ac40MIMO	5510	Type5	12	8	773423.0	13	1	64.7	1800.0	---	---	1
11ac40MIMO	5510	Type5	12	9	168898.0	13	1	61.4	1390.0	---	---	1
11ac40MIMO	5510	Type5	12	10	361606.0	13	2	83.2	1692.0	1858.0	---	1
11ac40MIMO	5510	Type5	12	11	553866.0	13	3	84.7	1533.0	1677.0	1638.0	1
11ac40MIMO	5510	Type5	12	12	747241.0	13	3	88.7	1703.0	1528.0	1058.0	1
11ac40MIMO	5510	Type5	12	13	144710.0	13	2	78.3	1258.0	1951.0	---	1
11ac40MIMO	5510	Type5	12	14	337856.0	13	2	69.3	1731.0	1717.0	---	1
11ac20MIMO	5500	Type5	12	0	22911.0	13	1	58.1	1929.0	---	---	1
11ac20MIMO	5500	Type5	12	1	216473.0	13	1	52.1	1910.0	---	---	1
11ac20MIMO	5500	Type5	12	2	410004.0	13	1	59.9	1971.0	---	---	1
11ac20MIMO	5500	Type5	12	3	603671.0	13	1	60.2	1812.0	---	---	1
11ac20MIMO	5500	Type5	12	4	794160.0	13	3	95.9	1399.0	1906.0	1608.0	1
11ac20MIMO	5500	Type5	12	5	192251.0	13	2	79.9	1626.0	1859.0	---	1
11ac20MIMO	5500	Type5	12	6	385590.0	13	2	78.5	1238.0	1917.0	---	1
11ac20MIMO	5500	Type5	12	7	579862.0	13	1	53.8	1763.0	---	---	1
11ac20MIMO	5500	Type5	12	8	773423.0	13	1	64.7	1800.0	---	---	1
11ac20MIMO	5500	Type5	12	9	168898.0	13	1	61.4	1390.0	---	---	1
11ac20MIMO	5500	Type5	12	10	361606.0	13	2	83.2	1692.0	1858.0	---	1
11ac20MIMO	5500	Type5	12	11	553866.0	13	3	84.7	1533.0	1677.0	1638.0	1
11ac20MIMO	5500	Type5	12	12	747241.0	13	3	88.7	1703.0	1528.0	1058.0	1
11ac20MIMO	5500	Type5	12	13	144710.0	13	2	78.3	1258.0	1951.0	---	1
11ac20MIMO	5500	Type5	12	14	337856.0	13	2	69.3	1731.0	1717.0	---	1



Unless otherwise agreed in writing, this document is issued by the Company subject to its General Conditions of Service printed overleaf, available on request or accessible at <http://www.sgs.com/en/Terms-and-Conditions.aspx> and, for electronic format documents, subject to Terms and Conditions for Electronic Documents at <http://www.sgs.com/en/Terms-and-Conditions/Terms-e-Documents.aspx>. Attention is drawn to the limitation of liability, indemnification and jurisdiction issues defined therein. Any holder of this document is advised that information contained herein reflects the Company's findings at the time of its intervention only and within the limits of Client's instructions, if any. The Company's sole responsibility is to its Client and this document does not exonerate parties to a transaction from exercising all their rights and obligations under the transaction documents. This document cannot be reproduced except in full, without prior written approval of the Company. Any unauthorized alteration, forgery or falsification of the content or appearance of this document is unlawful and offenders may be prosecuted to the fullest extent of the law. Unless otherwise stated the results shown in this test report refer only to the sample(s) tested and such sample(s) are retained for 30 days only.

Attention: To check the authenticity of testing/inspection report & certificate, please contact us at telephone: (86-755) 8307 1443, or email: CN.Doccheck@sgs.com  
 (X'ian) Ltd D. Building 1, Kanglong Orange Source Park, No.137, Keyuan 3rd Road, Fengling New Town, Xi'an, Shaanxi, China 710086  
 t (86-29) 6282 7885 www.sgs.com.cn  
 中国·西安·沣东新城科里三路137号康隆橙源科技园1号楼D单元1层 邮编: 710086 t (86-29) 6282 7885 sgs.china@sgs.com

TestMode	Channel	Radar Type	Trial ID	Burst ID	Burst Offset (µs)	Chirp Width (MHz)	Number Of Pulses	Pulse Width (µs)	PRI1 (µs)	PRI2 (µs)	PRI3 (µs)	Detection (1: Yes; 0: No)
11ac80MIMO	5530	Type5	13	0	664275.0	10	2	75.3	1994.0	1612.0	---	1
11ac80MIMO	5530	Type5	13	1	907886.0	10	1	56.3	1456.0	---	---	1
11ac80MIMO	5530	Type5	13	2	151316.0	10	2	67.7	1617.0	1185.0	---	1
11ac80MIMO	5530	Type5	13	3	393746.0	10	1	55.6	1337.0	---	---	1
11ac80MIMO	5530	Type5	13	4	635093.0	10	2	75.2	1421.0	1267.0	---	1
11ac80MIMO	5530	Type5	13	5	876993.0	10	2	76.3	1359.0	1305.0	---	1
11ac80MIMO	5530	Type5	13	6	121278.0	10	3	85.7	1547.0	1362.0	1924.0	1
11ac80MIMO	5530	Type5	13	7	362696.0	10	3	98.4	1873.0	1550.0	1249.0	1
11ac80MIMO	5530	Type5	13	8	604342.0	10	3	86.4	1779.0	1439.0	1046.0	1
11ac80MIMO	5530	Type5	13	9	846453.0	10	3	93.6	1059.0	1031.0	1452.0	1
11ac80MIMO	5530	Type5	13	10	91871.0	10	1	63.3	1328.0	---	---	1
11ac80MIMO	5530	Type5	13	11	333050.0	10	3	92.4	1412.0	1673.0	1322.0	1
11ac40MIMO	5510	Type5	13	0	664275.0	10	2	75.3	1994.0	1612.0	---	1
11ac40MIMO	5510	Type5	13	1	907886.0	10	1	56.3	1456.0	---	---	1
11ac40MIMO	5510	Type5	13	2	151316.0	10	2	67.7	1617.0	1185.0	---	1
11ac40MIMO	5510	Type5	13	3	393746.0	10	1	55.6	1337.0	---	---	1
11ac40MIMO	5510	Type5	13	4	635093.0	10	2	75.2	1421.0	1267.0	---	1
11ac40MIMO	5510	Type5	13	5	876993.0	10	2	76.3	1359.0	1305.0	---	1
11ac40MIMO	5510	Type5	13	6	121278.0	10	3	85.7	1547.0	1362.0	1924.0	1
11ac40MIMO	5510	Type5	13	7	362696.0	10	3	98.4	1873.0	1550.0	1249.0	1
11ac40MIMO	5510	Type5	13	8	604342.0	10	3	86.4	1779.0	1439.0	1046.0	1
11ac40MIMO	5510	Type5	13	9	846453.0	10	3	93.6	1059.0	1031.0	1452.0	1
11ac40MIMO	5510	Type5	13	10	91871.0	10	1	63.3	1328.0	---	---	1
11ac40MIMO	5510	Type5	13	11	333050.0	10	3	92.4	1412.0	1673.0	1322.0	1
11ac20MIMO	5500	Type5	13	0	664275.0	10	2	75.3	1994.0	1612.0	---	1
11ac20MIMO	5500	Type5	13	1	907886.0	10	1	56.3	1456.0	---	---	1
11ac20MIMO	5500	Type5	13	2	151316.0	10	2	67.7	1617.0	1185.0	---	1
11ac20MIMO	5500	Type5	13	3	393746.0	10	1	55.6	1337.0	---	---	1
11ac20MIMO	5500	Type5	13	4	635093.0	10	2	75.2	1421.0	1267.0	---	1
11ac20MIMO	5500	Type5	13	5	876993.0	10	2	76.3	1359.0	1305.0	---	1
11ac20MIMO	5500	Type5	13	6	121278.0	10	3	85.7	1547.0	1362.0	1924.0	1
11ac20MIMO	5500	Type5	13	7	362696.0	10	3	98.4	1873.0	1550.0	1249.0	1
11ac20MIMO	5500	Type5	13	8	604342.0	10	3	86.4	1779.0	1439.0	1046.0	1
11ac20MIMO	5500	Type5	13	9	846453.0	10	3	93.6	1059.0	1031.0	1452.0	1
11ac20MIMO	5500	Type5	13	10	91871.0	10	1	63.3	1328.0	---	---	1
11ac20MIMO	5500	Type5	13	11	333050.0	10	3	92.4	1412.0	1673.0	1322.0	1



Unless otherwise agreed in writing, this document is issued by the Company subject to its General Conditions of Service printed overleaf, available on request or accessible at <http://www.sgs.com/en/Terms-and-Conditions.aspx> and, for electronic format documents, subject to Terms and Conditions for Electronic Documents at <http://www.sgs.com/en/Terms-and-Conditions/Terms-e-Documents.aspx>. Attention is drawn to the limitation of liability, indemnification and jurisdiction issues defined therein. Any holder of this document is advised that information contained herein reflects the Company's findings at the time of its intervention only and within the limits of Client's instructions, if any. The Company's sole responsibility is to its Client and this document does not exonerate parties to a transaction from exercising all their rights and obligations under the transaction documents. This document cannot be reproduced except in full, without prior written approval of the Company. Any unauthorized alteration, forgery or falsification of the content or appearance of this document is unlawful and offenders may be prosecuted to the fullest extent of the law. Unless otherwise stated the results shown in this test report refer only to the sample(s) tested and such sample(s) are retained for 30 days only.

Attention: To check the authenticity of testing/inspection report & certificate, please contact us at telephone: (86-755) 4307 1443, or email: [CN.Doccheck@sgs.com](mailto:CN.Doccheck@sgs.com)  
 US: Unit D, Building 1, Kanghong Orange Science Park, No.157, Keyuan 3rd Road, Fengling New Town, Xi'an, Shaanxi, China 710086 t: (86-29) 6282 7885 www.sgs.com.cn  
 中国·西安·沣东新城科园三路157号康鸿橙方科技园1号楼D单元1层 邮编: 710086 t: (86-29) 6282 7885 sgs.china@sgs.com



Report No.: XEWA2310000070RG05

Rev.: 01

Page: 67 of 267

TestMode	Channel	Radar Type	Trial ID	Burst ID	Burst Offset (µs)	Chirp Width (MHz)	Number Of Pulses	Pulse Width (µs)	PRI1 (µs)	PRI2 (µs)	PRI3 (µs)	Detection (1: Yes; 0: No)
11ac80MIMO	5530	Type5	14	0	361323.0	18	3	93.3	1983.0	1912.0	1535.0	1
11ac80MIMO	5530	Type5	14	1	515261.0	18	2	69.1	1102.0	1794.0	---	1
11ac80MIMO	5530	Type5	14	2	39025.0	18	3	86.9	1044.0	1152.0	1148.0	1
11ac80MIMO	5530	Type5	14	3	190900.0	18	3	84.9	1894.0	1948.0	1118.0	1
11ac80MIMO	5530	Type5	14	4	343941.0	18	2	72.3	1094.0	1916.0	---	1
11ac80MIMO	5530	Type5	14	5	497624.0	18	1	51.7	1447.0	---	---	1
11ac80MIMO	5530	Type5	14	6	20319.0	18	1	58.3	1429.0	---	---	1
11ac80MIMO	5530	Type5	14	7	172999.0	18	1	60.8	1979.0	---	---	1
11ac80MIMO	5530	Type5	14	8	325872.0	18	1	57.1	1641.0	---	---	1
11ac80MIMO	5530	Type5	14	9	475841.0	18	3	88.9	1886.0	1964.0	1489.0	1
11ac80MIMO	5530	Type5	14	10	1489.0	18	2	72.0	1909.0	1297.0	---	1
11ac80MIMO	5530	Type5	14	11	153647.0	18	3	90.9	1261.0	1566.0	1370.0	1
11ac80MIMO	5530	Type5	14	12	307096.0	18	1	59.8	1552.0	---	---	1
11ac80MIMO	5530	Type5	14	13	458804.0	18	2	70.0	1759.0	1291.0	---	1
11ac80MIMO	5530	Type5	14	14	610798.0	18	2	67.2	1625.0	1881.0	---	1
11ac80MIMO	5530	Type5	14	15	134759.0	18	3	91.2	1382.0	1832.0	1661.0	1
11ac80MIMO	5530	Type5	14	16	288306.0	18	1	56.5	1483.0	---	---	1
11ac80MIMO	5530	Type5	14	17	441296.0	18	1	51.2	1237.0	---	---	1
11ac80MIMO	5530	Type5	14	18	592780.0	18	2	74.1	1471.0	1245.0	---	1
11ac40MIMO	5510	Type5	14	0	361323.0	18	3	93.3	1983.0	1912.0	1535.0	1
11ac40MIMO	5510	Type5	14	1	515261.0	18	2	69.1	1102.0	1794.0	---	1
11ac40MIMO	5510	Type5	14	2	39025.0	18	3	86.9	1044.0	1152.0	1148.0	1
11ac40MIMO	5510	Type5	14	3	190900.0	18	3	84.9	1894.0	1948.0	1118.0	1
11ac40MIMO	5510	Type5	14	4	343941.0	18	2	72.3	1094.0	1916.0	---	1
11ac40MIMO	5510	Type5	14	5	497624.0	18	1	51.7	1447.0	---	---	1
11ac40MIMO	5510	Type5	14	6	20319.0	18	1	58.3	1429.0	---	---	1
11ac40MIMO	5510	Type5	14	7	172999.0	18	1	60.8	1979.0	---	---	1
11ac40MIMO	5510	Type5	14	8	325872.0	18	1	57.1	1641.0	---	---	1
11ac40MIMO	5510	Type5	14	9	475841.0	18	3	88.9	1886.0	1964.0	1489.0	1
11ac40MIMO	5510	Type5	14	10	1489.0	18	2	72.0	1909.0	1297.0	---	1
11ac40MIMO	5510	Type5	14	11	153647.0	18	3	90.9	1261.0	1566.0	1370.0	1
11ac40MIMO	5510	Type5	14	12	307096.0	18	1	59.8	1552.0	---	---	1
11ac40MIMO	5510	Type5	14	13	458804.0	18	2	70.0	1759.0	1291.0	---	1
11ac40MIMO	5510	Type5	14	14	610798.0	18	2	67.2	1625.0	1881.0	---	1
11ac40MIMO	5510	Type5	14	15	134759.0	18	3	91.2	1382.0	1832.0	1661.0	1
11ac40MIMO	5510	Type5	14	16	288306.0	18	1	56.5	1483.0	---	---	1
11ac40MIMO	5510	Type5	14	17	441296.0	18	1	51.2	1237.0	---	---	1
11ac40MIMO	5510	Type5	14	18	592780.0	18	2	74.1	1471.0	1245.0	---	1
11ac20MIMO	5500	Type5	14	0	361323.0	18	3	93.3	1983.0	1912.0	1535.0	1
11ac20MIMO	5500	Type5	14	1	515261.0	18	2	69.1	1102.0	1794.0	---	1
11ac20MIMO	5500	Type5	14	2	39025.0	18	3	86.9	1044.0	1152.0	1148.0	1
11ac20MIMO	5500	Type5	14	3	190900.0	18	3	84.9	1894.0	1948.0	1118.0	1
11ac20MIMO	5500	Type5	14	4	343941.0	18	2	72.3	1094.0	1916.0	---	1
11ac20MIMO	5500	Type5	14	5	497624.0	18	1	51.7	1447.0	---	---	1
11ac20MIMO	5500	Type5	14	6	20319.0	18	1	58.3	1429.0	---	---	1
11ac20MIMO	5500	Type5	14	7	172999.0	18	1	60.8	1979.0	---	---	1
11ac20MIMO	5500	Type5	14	8	325872.0	18	1	57.1	1641.0	---	---	1
11ac20MIMO	5500	Type5	14	9	475841.0	18	3	88.9	1886.0	1964.0	1489.0	1
11ac20MIMO	5500	Type5	14	10	1489.0	18	2	72.0	1909.0	1297.0	---	1



Unless otherwise agreed in writing, this document is issued by the Company subject to its General Conditions of Service printed overleaf, available on request or accessible at <http://www.sgs.com/en/Terms-and-Conditions.aspx> and, for electronic format documents, subject to Terms and Conditions for Electronic Documents at <http://www.sgs.com/en/Terms-and-Conditions/Terms-e-Documents.aspx>. Attention is drawn to the limitation of liability, indemnification and jurisdiction issues defined therein. Any holder of this document is advised that information contained herein reflects the Company's findings at the time of its intervention only and within the limits of Client's instructions, if any. The Company's sole responsibility is to its Client and this document does not exonerate parties to a transaction from exercising all their rights and obligations under the transaction documents. This document cannot be reproduced except in full, without prior written approval of the Company. Any unauthorized alteration, forgery or falsification of the content or appearance of this document is unlawful and offenders may be prosecuted to the fullest extent of the law. Unless otherwise stated the results shown in this test report refer only to the sample(s) tested and such sample(s) are retained for 30 days only.

Attention: To check the authenticity of testing/inspection report & certificate, please contact us at telephone: (86-755) 8307 1443, or email: [CN.Doccheck@sgs.com](mailto:CN.Doccheck@sgs.com)  
 (SGS-CSTC) Standards Technical Services (Xi'an) Co., Ltd. | 1/F Unit D, Building 1, Kanglong Orange Science Park, No.137, Keyuan 3rd Road, Fengjing/Yan Yuan, Xi'an, Shaanxi, China | 710086 | t: (86-29) 6282 7885 | www.sgs.com.cn | sgs.china@sgs.com  
 中国·西安·沣东新城科里三路137号康隆橙方科技园1号楼D单元1层 | 邮编: 710086 | t: (86-29) 6282 7885 | sgs.china@sgs.com

Report No.: XEWA2310000070RG05  
 Rev.: 01  
 Page: 68 of 267

11ac20MIMO	5500	Type5	14	11	153647.0	18	3	90.9	1261.0	1566.0	1370.0	1
11ac20MIMO	5500	Type5	14	12	307096.0	18	1	59.8	1552.0	---	---	1
11ac20MIMO	5500	Type5	14	13	458804.0	18	2	70.0	1759.0	1291.0	---	1
11ac20MIMO	5500	Type5	14	14	610798.0	18	2	67.2	1625.0	1881.0	---	1
11ac20MIMO	5500	Type5	14	15	134759.0	18	3	91.2	1382.0	1832.0	1661.0	1
11ac20MIMO	5500	Type5	14	16	288306.0	18	1	56.5	1483.0	---	---	1
11ac20MIMO	5500	Type5	14	17	441296.0	18	1	51.2	1237.0	---	---	1
11ac20MIMO	5500	Type5	14	18	592780.0	18	2	74.1	1471.0	1245.0	---	1



Unless otherwise agreed in writing, this document is issued by the Company subject to its General Conditions of Service printed overleaf, available on request or accessible at <http://www.sgs.com/en/Terms-and-Conditions.aspx> and, for electronic format documents, subject to Terms and Conditions for Electronic Documents at <http://www.sgs.com/en/Terms-and-Conditions/Terms-e-Documents.aspx>. Attention is drawn to the limitation of liability, indemnification and jurisdiction issues defined therein. Any holder of this document is advised that information contained herein reflects the Company's findings at the time of its intervention only and within the limits of Client's instructions, if any. The Company's sole responsibility is to its Client and this document does not exonerate parties to a transaction from exercising all their rights and obligations under the transaction documents. This document cannot be reproduced except in full, without prior written approval of the Company. Any unauthorized alteration, forgery or falsification of the content or appearance of this document is unlawful and offenders may be prosecuted to the fullest extent of the law. Unless otherwise stated the results shown in this test report refer only to the sample(s) tested and such sample(s) are retained for 30 days only.

Attention: To check the authenticity of testing/inspection report & certificate, please contact us at telephone: (86-755) 8307 1443, or email: [CN.Doccheck@sgs.com](mailto:CN.Doccheck@sgs.com)  
 (Xi'an) Ltd. | (86-29) 6282 7885 | [www.sgs.com.cn](http://www.sgs.com.cn)  
 中国·西安·沣东新城科园三路137号康鸿楼方科技园1号楼D单元1层 | 邮编: 710086 | (86-29) 6282 7885 | [sgs.china@sgs.com](mailto:sgs.china@sgs.com)



Report No.: XEWA2310000070RG05

Rev.: 01

Page: 69 of 267

TestMode	Channel	Radar Type	Trial ID	Burst ID	Burst Offset (µs)	Chirp Width (MHz)	Number Of Pulses	Pulse Width (µs)	PRI1 (µs)	PRI2 (µs)	PRI3 (µs)	Detection (1: Yes; 0: No)
11ac80MIMO	5530	Type5	15	0	158286.0	12	2	76.9	1110.0	1140.0	---	1
11ac80MIMO	5530	Type5	15	1	366024.0	12	1	50.2	1316.0	---	---	1
11ac80MIMO	5530	Type5	15	2	573452.0	12	1	62.9	1520.0	---	---	1
11ac80MIMO	5530	Type5	15	3	780619.0	12	1	64.7	1902.0	---	---	1
11ac80MIMO	5530	Type5	15	4	132455.0	12	3	83.8	1410.0	1097.0	1621.0	1
11ac80MIMO	5530	Type5	15	5	340207.0	12	1	65.4	1944.0	---	---	1
11ac80MIMO	5530	Type5	15	6	548208.0	12	1	53.2	1024.0	---	---	1
11ac80MIMO	5530	Type5	15	7	755333.0	12	1	51.7	1603.0	---	---	1
11ac80MIMO	5530	Type5	15	8	107117.0	12	2	78.7	1804.0	1168.0	---	1
11ac80MIMO	5530	Type5	15	9	314500.0	12	2	72.4	1030.0	1343.0	---	1
11ac80MIMO	5530	Type5	15	10	522447.0	12	1	53.8	1327.0	---	---	1
11ac80MIMO	5530	Type5	15	11	728517.0	12	2	73.6	1524.0	1553.0	---	1
11ac80MIMO	5530	Type5	15	12	81611.0	12	2	66.7	1722.0	1122.0	---	1
11ac80MIMO	5530	Type5	15	13	288948.0	12	2	82.5	1404.0	1019.0	---	1
11ac40MIMO	5510	Type5	15	0	158286.0	12	2	76.9	1110.0	1140.0	---	1
11ac40MIMO	5510	Type5	15	1	366024.0	12	1	50.2	1316.0	---	---	1
11ac40MIMO	5510	Type5	15	2	573452.0	12	1	62.9	1520.0	---	---	1
11ac40MIMO	5510	Type5	15	3	780619.0	12	1	64.7	1902.0	---	---	1
11ac40MIMO	5510	Type5	15	4	132455.0	12	3	83.8	1410.0	1097.0	1621.0	1
11ac40MIMO	5510	Type5	15	5	340207.0	12	1	65.4	1944.0	---	---	1
11ac40MIMO	5510	Type5	15	6	548208.0	12	1	53.2	1024.0	---	---	1
11ac40MIMO	5510	Type5	15	7	755333.0	12	1	51.7	1603.0	---	---	1
11ac40MIMO	5510	Type5	15	8	107117.0	12	2	78.7	1804.0	1168.0	---	1
11ac40MIMO	5510	Type5	15	9	314500.0	12	2	72.4	1030.0	1343.0	---	1
11ac40MIMO	5510	Type5	15	10	522447.0	12	1	53.8	1327.0	---	---	1
11ac40MIMO	5510	Type5	15	11	728517.0	12	2	73.6	1524.0	1553.0	---	1
11ac40MIMO	5510	Type5	15	12	81611.0	12	2	66.7	1722.0	1122.0	---	1
11ac40MIMO	5510	Type5	15	13	288948.0	12	2	82.5	1404.0	1019.0	---	1
11ac20MIMO	5500	Type5	15	0	158286.0	12	2	76.9	1110.0	1140.0	---	1
11ac20MIMO	5500	Type5	15	1	366024.0	12	1	50.2	1316.0	---	---	1
11ac20MIMO	5500	Type5	15	2	573452.0	12	1	62.9	1520.0	---	---	1
11ac20MIMO	5500	Type5	15	3	780619.0	12	1	64.7	1902.0	---	---	1
11ac20MIMO	5500	Type5	15	4	132455.0	12	3	83.8	1410.0	1097.0	1621.0	1
11ac20MIMO	5500	Type5	15	5	340207.0	12	1	65.4	1944.0	---	---	1
11ac20MIMO	5500	Type5	15	6	548208.0	12	1	53.2	1024.0	---	---	1
11ac20MIMO	5500	Type5	15	7	755333.0	12	1	51.7	1603.0	---	---	1
11ac20MIMO	5500	Type5	15	8	107117.0	12	2	78.7	1804.0	1168.0	---	1
11ac20MIMO	5500	Type5	15	9	314500.0	12	2	72.4	1030.0	1343.0	---	1
11ac20MIMO	5500	Type5	15	10	522447.0	12	1	53.8	1327.0	---	---	1
11ac20MIMO	5500	Type5	15	11	728517.0	12	2	73.6	1524.0	1553.0	---	1
11ac20MIMO	5500	Type5	15	12	81611.0	12	2	66.7	1722.0	1122.0	---	1
11ac20MIMO	5500	Type5	15	13	288948.0	12	2	82.5	1404.0	1019.0	---	1



Unless otherwise agreed in writing, this document is issued by the Company subject to its General Conditions of Service printed overleaf, available on request or accessible at <http://www.sgs.com/en/Terms-and-Conditions.aspx> and, for electronic format documents, subject to Terms and Conditions for Electronic Documents at <http://www.sgs.com/en/Terms-and-Conditions/Terms-e-Document.aspx>. Attention is drawn to the limitation of liability, indemnification and jurisdiction issues defined therein. Any holder of this document is advised that information contained herein reflects the Company's findings at the time of its intervention only and within the limits of Client's instructions, if any. The Company's sole responsibility is to its Client and this document does not exonerate parties to a transaction from exercising all their rights and obligations under the transaction documents. This document cannot be reproduced except in full, without prior written approval of the Company. Any unauthorized alteration, forgery or falsification of the content or appearance of this document is unlawful and offenders may be prosecuted to the fullest extent of the law. Unless otherwise stated the results shown in this test report refer only to the sample(s) tested and such sample(s) are retained for 30 days only.

Attention: To check the authenticity of testing inspection report & certificate, please contact us at telephone: (86-755) 4307 1443, or email: CN.Doccheck@sgs.com  
 1/E Unit D, Building 1, Kanglong Orange Science Park, No.137, Keyuan 3rd Road, Fengling New Town, Xi'an, Shaanxi, China 710086 t (86-29) 6282 7885 www.sgs.com.cn  
 中国·西安·沣东新城科园三路137号康隆橙方科技园1号楼D单元1层 邮编: 710086 t (86-29) 6282 7885 sgs.china@sgs.com



Report No.: XEWA2310000070RG05
Rev.: 01
Page: 70 of 267

Table with 13 columns: TestMode, Channel, Radar Type, Trial ID, Burst ID, Burst Offset (µs), Chirp Width (MHz), Number Of Pulses, Pulse Width (µs), PRI1 (µs), PRI2 (µs), PRI3 (µs), Detection (1: Yes; 0: No). Rows include test data for channels 5530, 5510, and 5500.



Unless otherwise agreed in writing, this document is issued by the Company subject to its General Conditions of Service printed overleaf, available on request or accessible at http://www.sgs.com/en/Terms-and-Conditions.aspx and, for electronic format documents, subject to Terms and Conditions for Electronic Documents at http://www.sgs.com/en/Terms-and-Conditions/Terms-e-Documents.aspx. Attention is drawn to the limitation of liability, indemnification and jurisdiction issues defined therein. Any holder of this document is advised that information contained herein reflects the Company's findings at the time of its intervention only and within the limits of Client's instructions, if any. The Company's sole responsibility is to its Client and this document does not exonerate parties to a transaction from exercising all their rights and obligations under the transaction documents. This document cannot be reproduced except in full, without prior written approval of the Company. Any unauthorized alteration, forgery or falsification of the content or appearance of this document is unlawful and offenders may be prosecuted to the fullest extent of the law. Unless otherwise stated the results shown in this test report refer only to the sample(s) tested and such sample(s) are retained for 30 days only.

Attention: To check the authenticity of testing inspection report & certificate, please contact us at telephone: (86-755) 8307 1443, or email: CN\_Doccheck@sgs.com
1/E Unit D, Building 1, Kanglong Orange Science Park, No.137, Keyuan 3rd Road, Fengjing/Yan Tuan, Xi'an, Shaanxi, China 710086 t (86-29) 6282 7885 www.sgs.com.cn
中国·西安·沣东新城科里三路137号康隆橙方科技园1号楼D单元1层 邮编: 710086 t (86-29) 6282 7885 sgs.china@sgs.com



Report No.: XEWA2310000070RG05

Rev.: 01

Page: 71 of 267

11ac20MIMO	5500	Type5	16	9	456884.0	20	1	62.1	1495.0	---	---	1
11ac20MIMO	5500	Type5	16	10	3515.0	20	3	86.4	1773.0	1966.0	1263.0	1
11ac20MIMO	5500	Type5	16	11	147928.0	20	3	84.3	1593.0	1188.0	1788.0	1
11ac20MIMO	5500	Type5	16	12	293225.0	20	2	76.9	1226.0	1537.0	---	1
11ac20MIMO	5500	Type5	16	13	436922.0	20	3	95.8	1192.0	1298.0	1844.0	1
11ac20MIMO	5500	Type5	16	14	584015.0	20	1	55.2	1644.0	---	---	1
11ac20MIMO	5500	Type5	16	15	130832.0	20	1	59.0	1402.0	---	---	1
11ac20MIMO	5500	Type5	16	16	274684.0	20	3	94.5	1296.0	1700.0	1283.0	1
11ac20MIMO	5500	Type5	16	17	418579.0	20	3	91.9	1970.0	1978.0	1165.0	1
11ac20MIMO	5500	Type5	16	18	563464.0	20	3	85.2	1732.0	1551.0	1189.0	1
11ac20MIMO	5500	Type5	16	19	112787.0	20	2	69.5	1038.0	1224.0	---	1



Unless otherwise agreed in writing, this document is issued by the Company subject to its General Conditions of Service printed overleaf, available on request or accessible at <http://www.sgs.com/en/Terms-and-Conditions.aspx> and, for electronic format documents, subject to Terms and Conditions for Electronic Documents at <http://www.sgs.com/en/Terms-and-Conditions/Terms-e-Documents.aspx>. Attention is drawn to the limitation of liability, indemnification and jurisdiction issues defined therein. Any holder of this document is advised that information contained herein reflects the Company's findings at the time of its intervention only and within the limits of Client's instructions, if any. The Company's sole responsibility is to its Client and this document does not exonerate parties to a transaction from exercising all their rights and obligations under the transaction documents. This document cannot be reproduced except in full, without prior written approval of the Company. Any unauthorized alteration, forgery or falsification of the content or appearance of this document is unlawful and offenders may be prosecuted to the fullest extent of the law. Unless otherwise stated the results shown in this test report refer only to the sample(s) tested and such sample(s) are retained for 30 days only.

Attention: To check the authenticity of testing/inspection report & certificate, please contact us at telephone: (86-755) 8307 1443, or email: [CN.Doccheck@sgs.com](mailto:CN.Doccheck@sgs.com)  
 (X'ian Unit) 710086 t (86-29) 6282 7885 www.sgs.com.cn  
 中国·西安·沣东新城科园三路137号康鸿楼方科技园1号楼D单元1层 邮编: 710086 t (86-29) 6282 7885 sgs.china@sgs.com



Report No.: XEWA2310000070RG05

Rev.: 01

Page: 72 of 267

TestMode	Channel	Radar Type	Trial ID	Burst ID	Burst Offset (µs)	Chirp Width (MHz)	Number Of Pulses	Pulse Width (µs)	PRI1 (µs)	PRI2 (µs)	PRI3 (µs)	Detection (1: Yes; 0: No)
11ac80MIMO	5530	Type5	17	0	429224.0	10	3	86.4	1259.0	1918.0	1455.0	1
11ac80MIMO	5530	Type5	17	1	670241.0	10	3	92.2	1598.0	1719.0	1895.0	1
11ac80MIMO	5530	Type5	17	2	912880.0	10	2	80.4	1816.0	1899.0	---	1
11ac80MIMO	5530	Type5	17	3	158603.0	10	1	54.3	1335.0	---	---	1
11ac80MIMO	5530	Type5	17	4	400824.0	10	1	53.1	1303.0	---	---	1
11ac80MIMO	5530	Type5	17	5	641915.0	10	2	69.4	1503.0	1546.0	---	1
11ac80MIMO	5530	Type5	17	6	883823.0	10	2	69.1	1279.0	1639.0	---	1
11ac80MIMO	5530	Type5	17	7	128373.0	10	3	100.0	1375.0	1438.0	1595.0	1
11ac80MIMO	5530	Type5	17	8	370379.0	10	2	79.6	1239.0	1705.0	---	1
11ac80MIMO	5530	Type5	17	9	611194.0	10	3	88.4	1374.0	1579.0	1623.0	1
11ac80MIMO	5530	Type5	17	10	855665.0	10	1	53.3	1016.0	---	---	1
11ac80MIMO	5530	Type5	17	11	98897.0	10	1	65.3	1709.0	---	---	1
11ac40MIMO	5510	Type5	17	0	429224.0	10	3	86.4	1259.0	1918.0	1455.0	1
11ac40MIMO	5510	Type5	17	1	670241.0	10	3	92.2	1598.0	1719.0	1895.0	1
11ac40MIMO	5510	Type5	17	2	912880.0	10	2	80.4	1816.0	1899.0	---	1
11ac40MIMO	5510	Type5	17	3	158603.0	10	1	54.3	1335.0	---	---	1
11ac40MIMO	5510	Type5	17	4	400824.0	10	1	53.1	1303.0	---	---	1
11ac40MIMO	5510	Type5	17	5	641915.0	10	2	69.4	1503.0	1546.0	---	1
11ac40MIMO	5510	Type5	17	6	883823.0	10	2	69.1	1279.0	1639.0	---	1
11ac40MIMO	5510	Type5	17	7	128373.0	10	3	100.0	1375.0	1438.0	1595.0	1
11ac40MIMO	5510	Type5	17	8	370379.0	10	2	79.6	1239.0	1705.0	---	1
11ac40MIMO	5510	Type5	17	9	611194.0	10	3	88.4	1374.0	1579.0	1623.0	1
11ac40MIMO	5510	Type5	17	10	855665.0	10	1	53.3	1016.0	---	---	1
11ac40MIMO	5510	Type5	17	11	98897.0	10	1	65.3	1709.0	---	---	1
11ac20MIMO	5500	Type5	17	0	429224.0	10	3	86.4	1259.0	1918.0	1455.0	1
11ac20MIMO	5500	Type5	17	1	670241.0	10	3	92.2	1598.0	1719.0	1895.0	1
11ac20MIMO	5500	Type5	17	2	912880.0	10	2	80.4	1816.0	1899.0	---	1
11ac20MIMO	5500	Type5	17	3	158603.0	10	1	54.3	1335.0	---	---	1
11ac20MIMO	5500	Type5	17	4	400824.0	10	1	53.1	1303.0	---	---	1
11ac20MIMO	5500	Type5	17	5	641915.0	10	2	69.4	1503.0	1546.0	---	1
11ac20MIMO	5500	Type5	17	6	883823.0	10	2	69.1	1279.0	1639.0	---	1
11ac20MIMO	5500	Type5	17	7	128373.0	10	3	100.0	1375.0	1438.0	1595.0	1
11ac20MIMO	5500	Type5	17	8	370379.0	10	2	79.6	1239.0	1705.0	---	1
11ac20MIMO	5500	Type5	17	9	611194.0	10	3	88.4	1374.0	1579.0	1623.0	1
11ac20MIMO	5500	Type5	17	10	855665.0	10	1	53.3	1016.0	---	---	1
11ac20MIMO	5500	Type5	17	11	98897.0	10	1	65.3	1709.0	---	---	1



Unless otherwise agreed in writing, this document is issued by the Company subject to its General Conditions of Service printed overleaf, available on request or accessible at <http://www.sgs.com/en/Terms-and-Conditions.aspx> and, for electronic format documents, subject to Terms and Conditions for Electronic Documents at <http://www.sgs.com/en/Terms-and-Conditions/Terms-e-Documents.aspx>. Attention is drawn to the limitation of liability, indemnification and jurisdiction issues defined therein. Any holder of this document is advised that information contained herein reflects the Company's findings at the time of its intervention only and within the limits of Client's instructions, if any. The Company's sole responsibility is to its Client and this document does not exonerate parties to a transaction from exercising all their rights and obligations under the transaction documents. This document cannot be reproduced except in full, without prior written approval of the Company. Any unauthorized alteration, forgery or falsification of the content or appearance of this document is unlawful and offenders may be prosecuted to the fullest extent of the law. Unless otherwise stated the results shown in this test report refer only to the sample(s) tested and such sample(s) are retained for 30 days only.

Attention: To check the authenticity of testing/inspection report & certificate, please contact us at telephone: (86-755) 4307 1443, or email: CN.Doccheck@sgs.com

SGS-CSTC Standards Technical Services (Xi'an) Co., Ltd. | 1/E Unit D, Building 1, Kanghong Orange Science Park, No.137, Kejian 3rd Road, Fengling New Town, Xi'an, Shaanxi, China | 710086 | t (86-29) 6282 7885 | www.sgs.com.cn  
 中国·西安·沣东新城科里三路137号康鸿橙方科技园1号楼D单元1层 | 邮编: 710086 | t (86-29) 6282 7885 | sgs.china@sgs.com



TestMode	Channel	Radar Type	Trial ID	Burst ID	Burst Offset (µs)	Chirp Width (MHz)	Number Of Pulses	Pulse Width (µs)	PRI1 (µs)	PRI2 (µs)	PRI3 (µs)	Detection (1: Yes; 0: No)
11ac80MIMO	5530	Type5	18	0	292143.0	12	1	55.3	1920.0	---	---	1
11ac80MIMO	5530	Type5	18	1	499633.0	12	1	58.3	1797.0	---	---	1
11ac80MIMO	5530	Type5	18	2	706377.0	12	2	72.3	1610.0	1039.0	---	1
11ac80MIMO	5530	Type5	18	3	58989.0	12	3	84.8	1131.0	1761.0	1721.0	1
11ac80MIMO	5530	Type5	18	4	266161.0	12	2	82.5	1875.0	1431.0	---	1
11ac80MIMO	5530	Type5	18	5	474469.0	12	1	63.3	1095.0	---	---	1
11ac80MIMO	5530	Type5	18	6	680544.0	12	2	80.0	1119.0	1913.0	---	1
11ac80MIMO	5530	Type5	18	7	33519.0	12	3	90.3	1660.0	1853.0	1123.0	1
11ac80MIMO	5530	Type5	18	8	240319.0	12	3	91.1	1539.0	1783.0	1172.0	1
11ac80MIMO	5530	Type5	18	9	447400.0	12	3	96.6	1525.0	1036.0	1385.0	1
11ac80MIMO	5530	Type5	18	10	654516.0	12	2	82.7	1710.0	1990.0	---	1
11ac80MIMO	5530	Type5	18	11	8083.0	12	1	50.7	1234.0	---	---	1
11ac80MIMO	5530	Type5	18	12	215435.0	12	2	78.4	1047.0	1109.0	---	1
11ac80MIMO	5530	Type5	18	13	421325.0	12	3	99.5	1299.0	1965.0	1869.0	1
11ac40MIMO	5510	Type5	18	0	292143.0	12	1	55.3	1920.0	---	---	1
11ac40MIMO	5510	Type5	18	1	499633.0	12	1	58.3	1797.0	---	---	1
11ac40MIMO	5510	Type5	18	2	706377.0	12	2	72.3	1610.0	1039.0	---	1
11ac40MIMO	5510	Type5	18	3	58989.0	12	3	84.8	1131.0	1761.0	1721.0	1
11ac40MIMO	5510	Type5	18	4	266161.0	12	2	82.5	1875.0	1431.0	---	1
11ac40MIMO	5510	Type5	18	5	474469.0	12	1	63.3	1095.0	---	---	1
11ac40MIMO	5510	Type5	18	6	680544.0	12	2	80.0	1119.0	1913.0	---	1
11ac40MIMO	5510	Type5	18	7	33519.0	12	3	90.3	1660.0	1853.0	1123.0	1
11ac40MIMO	5510	Type5	18	8	240319.0	12	3	91.1	1539.0	1783.0	1172.0	1
11ac40MIMO	5510	Type5	18	9	447400.0	12	3	96.6	1525.0	1036.0	1385.0	1
11ac40MIMO	5510	Type5	18	10	654516.0	12	2	82.7	1710.0	1990.0	---	1
11ac40MIMO	5510	Type5	18	11	8083.0	12	1	50.7	1234.0	---	---	1
11ac40MIMO	5510	Type5	18	12	215435.0	12	2	78.4	1047.0	1109.0	---	1
11ac40MIMO	5510	Type5	18	13	421325.0	12	3	99.5	1299.0	1965.0	1869.0	1
11ac20MIMO	5500	Type5	18	0	292143.0	12	1	55.3	1920.0	---	---	1
11ac20MIMO	5500	Type5	18	1	499633.0	12	1	58.3	1797.0	---	---	1
11ac20MIMO	5500	Type5	18	2	706377.0	12	2	72.3	1610.0	1039.0	---	1
11ac20MIMO	5500	Type5	18	3	58989.0	12	3	84.8	1131.0	1761.0	1721.0	1
11ac20MIMO	5500	Type5	18	4	266161.0	12	2	82.5	1875.0	1431.0	---	1
11ac20MIMO	5500	Type5	18	5	474469.0	12	1	63.3	1095.0	---	---	1
11ac20MIMO	5500	Type5	18	6	680544.0	12	2	80.0	1119.0	1913.0	---	1
11ac20MIMO	5500	Type5	18	7	33519.0	12	3	90.3	1660.0	1853.0	1123.0	1
11ac20MIMO	5500	Type5	18	8	240319.0	12	3	91.1	1539.0	1783.0	1172.0	1
11ac20MIMO	5500	Type5	18	9	447400.0	12	3	96.6	1525.0	1036.0	1385.0	1
11ac20MIMO	5500	Type5	18	10	654516.0	12	2	82.7	1710.0	1990.0	---	1
11ac20MIMO	5500	Type5	18	11	8083.0	12	1	50.7	1234.0	---	---	1
11ac20MIMO	5500	Type5	18	12	215435.0	12	2	78.4	1047.0	1109.0	---	1
11ac20MIMO	5500	Type5	18	13	421325.0	12	3	99.5	1299.0	1965.0	1869.0	1



Unless otherwise agreed in writing, this document is issued by the Company subject to its General Conditions of Service printed overleaf, available on request or accessible at <http://www.sgs.com/en/Terms-and-Conditions.aspx> and, for electronic format documents, subject to Terms and Conditions for Electronic Documents at <http://www.sgs.com/en/Terms-and-Conditions/Terms-e-Documents.aspx>. Attention is drawn to the limitation of liability, indemnification and jurisdiction issues defined therein. Any holder of this document is advised that information contained herein reflects the Company's findings at the time of its intervention only and within the limits of Client's instructions, if any. The Company's sole responsibility is to its Client and this document does not exonerate parties to a transaction from exercising all their rights and obligations under the transaction documents. This document cannot be reproduced except in full, without prior written approval of the Company. Any unauthorized alteration, forgery or falsification of the content or appearance of this document is unlawful and offenders may be prosecuted to the fullest extent of the law. Unless otherwise stated the results shown in this test report refer only to the sample(s) tested and such sample(s) are retained for 30 days only.

Attention: To check the authenticity of testing/inspection report & certificate, please contact us at telephone: (86-755) 8307 1443, or email: [CN.Doccheck@sgs.com](mailto:CN.Doccheck@sgs.com)

SGS-CSTC Standards Technical Services (Xi'an) Co., Ltd. | 1/F Unit D, Building 1, Kanglong Orange Science Park, No.137, Keyuan 3rd Road, Fengling New Town, Xi'an, Shaanxi, China | 710086 | t: (86-29) 6282 7885 | www.sgs.com.cn  
 中国·西安·沣东新城科里三路137号康隆橙方科技园1号楼D单元1层 | 邮编: 710086 | t: (86-29) 6282 7885 | sgs.china@sgs.com



Report No.: XEWA2310000070RG05

Rev.: 01

Page: 74 of 267

TestMode	Channel	Radar Type	Trial ID	Burst ID	Burst Offset (µs)	Chirp Width (MHz)	Number Of Pulses	Pulse Width (µs)	PRI1 (µs)	PRI2 (µs)	PRI3 (µs)	Detection (1: Yes; 0: No)
11ac80MIMO	5530	Type5	19	0	733725.0	10	3	88.6	1501.0	1067.0	1927.0	1
11ac80MIMO	5530	Type5	19	1	977882.0	10	1	57.4	1723.0	---	---	1
11ac80MIMO	5530	Type5	19	2	221197.0	10	3	96.6	1086.0	1658.0	1324.0	1
11ac80MIMO	5530	Type5	19	3	462915.0	10	2	69.7	1751.0	1945.0	---	1
11ac80MIMO	5530	Type5	19	4	705071.0	10	2	77.9	1642.0	1317.0	---	1
11ac80MIMO	5530	Type5	19	5	947923.0	10	1	62.0	1866.0	---	---	1
11ac80MIMO	5530	Type5	19	6	191373.0	10	3	88.4	1997.0	1077.0	1366.0	1
11ac80MIMO	5530	Type5	19	7	432561.0	10	3	97.3	1790.0	1896.0	1367.0	1
11ac80MIMO	5530	Type5	19	8	674004.0	10	3	96.2	1391.0	1787.0	1672.0	1
11ac80MIMO	5530	Type5	19	9	915842.0	10	3	95.4	1020.0	1892.0	1414.0	1
11ac80MIMO	5530	Type5	19	10	162176.0	10	1	54.8	1084.0	---	---	1
11ac80MIMO	5530	Type5	19	11	403553.0	10	2	80.4	1850.0	1436.0	---	1
11ac40MIMO	5510	Type5	19	0	733725.0	10	3	88.6	1501.0	1067.0	1927.0	1
11ac40MIMO	5510	Type5	19	1	977882.0	10	1	57.4	1723.0	---	---	1
11ac40MIMO	5510	Type5	19	2	221197.0	10	3	96.6	1086.0	1658.0	1324.0	1
11ac40MIMO	5510	Type5	19	3	462915.0	10	2	69.7	1751.0	1945.0	---	1
11ac40MIMO	5510	Type5	19	4	705071.0	10	2	77.9	1642.0	1317.0	---	1
11ac40MIMO	5510	Type5	19	5	947923.0	10	1	62.0	1866.0	---	---	1
11ac40MIMO	5510	Type5	19	6	191373.0	10	3	88.4	1997.0	1077.0	1366.0	1
11ac40MIMO	5510	Type5	19	7	432561.0	10	3	97.3	1790.0	1896.0	1367.0	1
11ac40MIMO	5510	Type5	19	8	674004.0	10	3	96.2	1391.0	1787.0	1672.0	1
11ac40MIMO	5510	Type5	19	9	915842.0	10	3	95.4	1020.0	1892.0	1414.0	1
11ac40MIMO	5510	Type5	19	10	162176.0	10	1	54.8	1084.0	---	---	1
11ac40MIMO	5510	Type5	19	11	403553.0	10	2	80.4	1850.0	1436.0	---	1
11ac20MIMO	5500	Type5	19	0	733725.0	10	3	88.6	1501.0	1067.0	1927.0	1
11ac20MIMO	5500	Type5	19	1	977882.0	10	1	57.4	1723.0	---	---	1
11ac20MIMO	5500	Type5	19	2	221197.0	10	3	96.6	1086.0	1658.0	1324.0	1
11ac20MIMO	5500	Type5	19	3	462915.0	10	2	69.7	1751.0	1945.0	---	1
11ac20MIMO	5500	Type5	19	4	705071.0	10	2	77.9	1642.0	1317.0	---	1
11ac20MIMO	5500	Type5	19	5	947923.0	10	1	62.0	1866.0	---	---	1
11ac20MIMO	5500	Type5	19	6	191373.0	10	3	88.4	1997.0	1077.0	1366.0	1
11ac20MIMO	5500	Type5	19	7	432561.0	10	3	97.3	1790.0	1896.0	1367.0	1
11ac20MIMO	5500	Type5	19	8	674004.0	10	3	96.2	1391.0	1787.0	1672.0	1
11ac20MIMO	5500	Type5	19	9	915842.0	10	3	95.4	1020.0	1892.0	1414.0	1
11ac20MIMO	5500	Type5	19	10	162176.0	10	1	54.8	1084.0	---	---	1
11ac20MIMO	5500	Type5	19	11	403553.0	10	2	80.4	1850.0	1436.0	---	1



Unless otherwise agreed in writing, this document is issued by the Company subject to its General Conditions of Service printed overleaf, available on request or accessible at <http://www.sgs.com/en/Terms-and-Conditions.aspx> and, for electronic format documents, subject to Terms and Conditions for Electronic Documents at <http://www.sgs.com/en/Terms-and-Conditions/Terms-e-Documents.aspx>. Attention is drawn to the limitation of liability, indemnification and jurisdiction issues defined therein. Any holder of this document is advised that information contained herein reflects the Company's findings at the time of its intervention only and within the limits of Client's instructions, if any. The Company's sole responsibility is to its Client and this document does not exonerate parties to a transaction from exercising all their rights and obligations under the transaction documents. This document cannot be reproduced except in full, without prior written approval of the Company. Any unauthorized alteration, forgery or falsification of the content or appearance of this document is unlawful and offenders may be prosecuted to the fullest extent of the law. Unless otherwise stated the results shown in this test report refer only to the sample(s) tested and such sample(s) are retained for 30 days only.

Attention: To check the authenticity of testing/inspection report & certificate, please contact us at telephone: (86-755) 4307 1443, or email: CN.Doccheck@sgs.com  
 (SGS-CSTC) Standards Technical Services (Xi'an) Co., Ltd. 710086 t (86-29) 6282 7885 www.sgs.com.cn  
 中国·西安·沣东新城科园三路137号康鸿楼方科技园1号楼D单元1层 邮编: 710086 t (86-29) 6282 7885 sgs.china@sgs.com



TestMode	Channel	Radar Type	Trial ID	Burst ID	Burst Offset (µs)	Chirp Width (MHz)	Number Of Pulses	Pulse Width (µs)	PRI1 (µs)	PRI2 (µs)	PRI3 (µs)	Detection (1: Yes; 0: No)
11ac80MIMO	5530	Type5	20	0	483470.0	15	2	74.7	1619.0	1611.0	---	1
11ac80MIMO	5530	Type5	20	1	666072.0	15	1	57.1	1560.0	---	---	1
11ac80MIMO	5530	Type5	20	2	98810.0	15	3	91.9	1392.0	1475.0	1276.0	1
11ac80MIMO	5530	Type5	20	3	279914.0	15	2	83.1	1809.0	1772.0	---	1
11ac80MIMO	5530	Type5	20	4	462536.0	15	1	50.7	1003.0	---	---	1
11ac80MIMO	5530	Type5	20	5	642324.0	15	2	79.2	1574.0	1600.0	---	1
11ac80MIMO	5530	Type5	20	6	76831.0	15	1	58.7	1186.0	---	---	1
11ac80MIMO	5530	Type5	20	7	257785.0	15	2	71.0	1521.0	1567.0	---	1
11ac80MIMO	5530	Type5	20	8	438554.0	15	2	79.0	1777.0	1960.0	---	1
11ac80MIMO	5530	Type5	20	9	620397.0	15	2	68.5	1284.0	1428.0	---	1
11ac80MIMO	5530	Type5	20	10	54310.0	15	2	73.5	1904.0	1352.0	---	1
11ac80MIMO	5530	Type5	20	11	235506.0	15	2	70.5	1864.0	1115.0	---	1
11ac80MIMO	5530	Type5	20	12	417036.0	15	2	76.6	1045.0	1300.0	---	1
11ac80MIMO	5530	Type5	20	13	597974.0	15	2	81.2	1160.0	1675.0	---	1
11ac80MIMO	5530	Type5	20	14	32086.0	15	1	61.8	1277.0	---	---	1
11ac80MIMO	5530	Type5	20	15	212751.0	15	3	94.9	1450.0	1206.0	1860.0	1
11ac40MIMO	5510	Type5	20	0	483470.0	15	2	74.7	1619.0	1611.0	---	1
11ac40MIMO	5510	Type5	20	1	666072.0	15	1	57.1	1560.0	---	---	1
11ac40MIMO	5510	Type5	20	2	98810.0	15	3	91.9	1392.0	1475.0	1276.0	1
11ac40MIMO	5510	Type5	20	3	279914.0	15	2	83.1	1809.0	1772.0	---	1
11ac40MIMO	5510	Type5	20	4	462536.0	15	1	50.7	1003.0	---	---	1
11ac40MIMO	5510	Type5	20	5	642324.0	15	2	79.2	1574.0	1600.0	---	1
11ac40MIMO	5510	Type5	20	6	76831.0	15	1	58.7	1186.0	---	---	1
11ac40MIMO	5510	Type5	20	7	257785.0	15	2	71.0	1521.0	1567.0	---	1
11ac40MIMO	5510	Type5	20	8	438554.0	15	2	79.0	1777.0	1960.0	---	1
11ac40MIMO	5510	Type5	20	9	620397.0	15	2	68.5	1284.0	1428.0	---	1
11ac40MIMO	5510	Type5	20	10	54310.0	15	2	73.5	1904.0	1352.0	---	1
11ac40MIMO	5510	Type5	20	11	235506.0	15	2	70.5	1864.0	1115.0	---	1
11ac40MIMO	5510	Type5	20	12	417036.0	15	2	76.6	1045.0	1300.0	---	1
11ac40MIMO	5510	Type5	20	13	597974.0	15	2	81.2	1160.0	1675.0	---	1
11ac40MIMO	5510	Type5	20	14	32086.0	15	1	61.8	1277.0	---	---	1
11ac40MIMO	5510	Type5	20	15	212751.0	15	3	94.9	1450.0	1206.0	1860.0	1
11ac20MIMO	5500	Type5	20	0	483470.0	15	2	74.7	1619.0	1611.0	---	1
11ac20MIMO	5500	Type5	20	1	666072.0	15	1	57.1	1560.0	---	---	1
11ac20MIMO	5500	Type5	20	2	98810.0	15	3	91.9	1392.0	1475.0	1276.0	1
11ac20MIMO	5500	Type5	20	3	279914.0	15	2	83.1	1809.0	1772.0	---	1
11ac20MIMO	5500	Type5	20	4	462536.0	15	1	50.7	1003.0	---	---	1
11ac20MIMO	5500	Type5	20	5	642324.0	15	2	79.2	1574.0	1600.0	---	1
11ac20MIMO	5500	Type5	20	6	76831.0	15	1	58.7	1186.0	---	---	1
11ac20MIMO	5500	Type5	20	7	257785.0	15	2	71.0	1521.0	1567.0	---	1
11ac20MIMO	5500	Type5	20	8	438554.0	15	2	79.0	1777.0	1960.0	---	1
11ac20MIMO	5500	Type5	20	9	620397.0	15	2	68.5	1284.0	1428.0	---	1
11ac20MIMO	5500	Type5	20	10	54310.0	15	2	73.5	1904.0	1352.0	---	1
11ac20MIMO	5500	Type5	20	11	235506.0	15	2	70.5	1864.0	1115.0	---	1
11ac20MIMO	5500	Type5	20	12	417036.0	15	2	76.6	1045.0	1300.0	---	1
11ac20MIMO	5500	Type5	20	13	597974.0	15	2	81.2	1160.0	1675.0	---	1
11ac20MIMO	5500	Type5	20	14	32086.0	15	1	61.8	1277.0	---	---	1
11ac20MIMO	5500	Type5	20	15	212751.0	15	3	94.9	1450.0	1206.0	1860.0	1



Unless otherwise agreed in writing, this document is issued by the Company subject to its General Conditions of Service printed overleaf, available on request or accessible at <http://www.sgs.com/en/Terms-and-Conditions.aspx> and, for electronic format documents, subject to Terms and Conditions for Electronic Documents at <http://www.sgs.com/en/Terms-and-Conditions/Terms-e-Documents.aspx>. Attention is drawn to the limitation of liability, indemnification and jurisdiction issues defined therein. Any holder of this document is advised that information contained herein reflects the Company's findings at the time of its intervention only and within the limits of Client's instructions, if any. The Company's sole responsibility is to its Client and this document does not exonerate parties to a transaction from exercising all their rights and obligations under the transaction documents. This document cannot be reproduced except in full, without prior written approval of the Company. Any unauthorized alteration, forgery or falsification of the content or appearance of this document is unlawful and offenders may be prosecuted to the fullest extent of the law. Unless otherwise stated the results shown in this test report refer only to the sample(s) tested and such sample(s) are retained for 30 days only.

Attention: To check the authenticity of testing/inspection report & certificate, please contact us at telephone: (86-755) 8307 1443, or email: CN\_Doccheck@sgs.com

SGS-CSTC Standards Technical Services (Xi'an) Co., Ltd. | 1/F Unit D, Building 1, Kanglong Orange Science Park, No.137, Keyuan3rd Road, Fengling/Yue Town, Xian, Shaanxi, China | 710086 | t: (86-29) 6282 7885 | www.sgs.com.cn | sgs.china@sgs.com  
 中国·西安·沣东新城科里三路137号康隆橙方科技园1号楼D单元1层 | 邮编: 710086 | t: (86-29) 6282 7885 | sgs.china@sgs.com



Report No.: XEWA2310000070RG05

Rev.: 01

Page: 76 of 267

TestMode	Channel	Radar Type	Trial ID	Burst ID	Burst Offset (µs)	Chirp Width (MHz)	Number Of Pulses	Pulse Width (µs)	PRI1 (µs)	PRI2 (µs)	PRI3 (µs)	Detection (1: Yes; 0: No)
11ac80MIMO	5530	Type5	21	0	526149.0	9	2	78.5	1653.0	1698.0	---	1
11ac80MIMO	5530	Type5	21	1	767135.0	9	3	89.8	1174.0	1962.0	1167.0	1
11ac80MIMO	5530	Type5	21	2	12955.0	9	1	59.4	1982.0	---	---	1
11ac80MIMO	5530	Type5	21	3	254612.0	9	2	79.6	1633.0	1890.0	---	1
11ac80MIMO	5530	Type5	21	4	496588.0	9	2	76.0	1112.0	1811.0	---	1
11ac80MIMO	5530	Type5	21	5	739728.0	9	1	53.6	1144.0	---	---	1
11ac80MIMO	5530	Type5	21	6	980872.0	9	2	80.9	1220.0	1053.0	---	1
11ac80MIMO	5530	Type5	21	7	225249.0	9	1	61.6	1724.0	---	---	1
11ac80MIMO	5530	Type5	21	8	467279.0	9	1	53.4	1901.0	---	---	1
11ac80MIMO	5530	Type5	21	9	709720.0	9	1	59.9	1379.0	---	---	1
11ac80MIMO	5530	Type5	21	10	951847.0	9	1	60.4	1453.0	---	---	1
11ac80MIMO	5530	Type5	21	11	194839.0	9	3	91.4	1768.0	1726.0	1227.0	1
11ac40MIMO	5510	Type5	21	0	526149.0	9	2	78.5	1653.0	1698.0	---	1
11ac40MIMO	5510	Type5	21	1	767135.0	9	3	89.8	1174.0	1962.0	1167.0	1
11ac40MIMO	5510	Type5	21	2	12955.0	9	1	59.4	1982.0	---	---	1
11ac40MIMO	5510	Type5	21	3	254612.0	9	2	79.6	1633.0	1890.0	---	1
11ac40MIMO	5510	Type5	21	4	496588.0	9	2	76.0	1112.0	1811.0	---	1
11ac40MIMO	5510	Type5	21	5	739728.0	9	1	53.6	1144.0	---	---	1
11ac40MIMO	5510	Type5	21	6	980872.0	9	2	80.9	1220.0	1053.0	---	1
11ac40MIMO	5510	Type5	21	7	225249.0	9	1	61.6	1724.0	---	---	1
11ac40MIMO	5510	Type5	21	8	467279.0	9	1	53.4	1901.0	---	---	1
11ac40MIMO	5510	Type5	21	9	709720.0	9	1	59.9	1379.0	---	---	1
11ac40MIMO	5510	Type5	21	10	951847.0	9	1	60.4	1453.0	---	---	1
11ac40MIMO	5510	Type5	21	11	194839.0	9	3	91.4	1768.0	1726.0	1227.0	1
11ac20MIMO	5500	Type5	21	0	526149.0	9	2	78.5	1653.0	1698.0	---	1
11ac20MIMO	5500	Type5	21	1	767135.0	9	3	89.8	1174.0	1962.0	1167.0	1
11ac20MIMO	5500	Type5	21	2	12955.0	9	1	59.4	1982.0	---	---	1
11ac20MIMO	5500	Type5	21	3	254612.0	9	2	79.6	1633.0	1890.0	---	1
11ac20MIMO	5500	Type5	21	4	496588.0	9	2	76.0	1112.0	1811.0	---	1
11ac20MIMO	5500	Type5	21	5	739728.0	9	1	53.6	1144.0	---	---	1
11ac20MIMO	5500	Type5	21	6	980872.0	9	2	80.9	1220.0	1053.0	---	1
11ac20MIMO	5500	Type5	21	7	225249.0	9	1	61.6	1724.0	---	---	1
11ac20MIMO	5500	Type5	21	8	467279.0	9	1	53.4	1901.0	---	---	1
11ac20MIMO	5500	Type5	21	9	709720.0	9	1	59.9	1379.0	---	---	1
11ac20MIMO	5500	Type5	21	10	951847.0	9	1	60.4	1453.0	---	---	1
11ac20MIMO	5500	Type5	21	11	194839.0	9	3	91.4	1768.0	1726.0	1227.0	1



Unless otherwise agreed in writing, this document is issued by the Company subject to its General Conditions of Service printed overleaf, available on request or accessible at <http://www.sgs.com/en/Terms-and-Conditions.aspx> and, for electronic format documents, subject to Terms and Conditions for Electronic Documents at <http://www.sgs.com/en/Terms-and-Conditions/Terms-e-Documents.aspx>. Attention is drawn to the limitation of liability, indemnification and jurisdiction issues defined therein. Any holder of this document is advised that information contained herein reflects the Company's findings at the time of its intervention only and within the limits of Client's instructions, if any. The Company's sole responsibility is to its Client and this document does not exonerate parties to a transaction from exercising all their rights and obligations under the transaction documents. This document cannot be reproduced except in full, without prior written approval of the Company. Any unauthorized alteration, forgery or falsification of the content or appearance of this document is unlawful and offenders may be prosecuted to the fullest extent of the law. Unless otherwise stated the results shown in this test report refer only to the sample(s) tested and such sample(s) are retained for 30 days only.

Attention: To check the authenticity of testing/inspection report & certificate, please contact us at telephone: (86-755) 4307 1443, or email: CN.Doccheck@sgs.com

SGS-CSTC Standards Technical Services (Xi'an) Co., Ltd. | 710086 | t (86-29) 6282 7885 | www.sgs.com.cn  
 中国·西安·沣东新城科园三路137号康鸿楼方科技园1号楼D单元1层 | 邮编: 710086 | t (86-29) 6282 7885 | sgs.china@sgs.com



Report No.: XEWA2310000070RG05

Rev.: 01

Page: 77 of 267

TestMode	Channel	Radar Type	Trial ID	Burst ID	Burst Offset (µs)	Chirp Width (MHz)	Number Of Pulses	Pulse Width (µs)	PRI1 (µs)	PRI2 (µs)	PRI3 (µs)	Detection (1: Yes; 0: No)
11ac80MIMO	5530	Type5	22	0	261858.0	20	2	77.0	1191.0	1363.0	---	1
11ac80MIMO	5530	Type5	22	1	407646.0	20	1	58.1	1248.0	---	---	1
11ac80MIMO	5530	Type5	22	2	552319.0	20	1	62.1	1836.0	---	---	1
11ac80MIMO	5530	Type5	22	3	99107.0	20	2	76.9	1334.0	1236.0	---	1
11ac80MIMO	5530	Type5	22	4	243514.0	20	2	80.0	1914.0	1852.0	---	1
11ac80MIMO	5530	Type5	22	5	389464.0	20	1	52.0	1701.0	---	---	1
11ac80MIMO	5530	Type5	22	6	531093.0	20	3	88.6	1693.0	1995.0	1905.0	1
11ac80MIMO	5530	Type5	22	7	81159.0	20	2	72.9	1922.0	1387.0	---	1
11ac80MIMO	5530	Type5	22	8	225245.0	20	3	98.5	1839.0	1746.0	1389.0	1
11ac80MIMO	5530	Type5	22	9	371906.0	20	1	57.9	1193.0	---	---	1
11ac80MIMO	5530	Type5	22	10	514197.0	20	3	95.9	1659.0	1870.0	1066.0	1
11ac80MIMO	5530	Type5	22	11	63561.0	20	1	53.5	1162.0	---	---	1
11ac80MIMO	5530	Type5	22	12	207510.0	20	3	92.0	1745.0	1654.0	1458.0	1
11ac80MIMO	5530	Type5	22	13	353638.0	20	1	57.3	1834.0	---	---	1
11ac80MIMO	5530	Type5	22	14	497515.0	20	2	70.5	1684.0	1586.0	---	1
11ac80MIMO	5530	Type5	22	15	45553.0	20	2	70.0	1042.0	1664.0	---	1
11ac80MIMO	5530	Type5	22	16	189821.0	20	3	84.0	1765.0	1630.0	1176.0	1
11ac80MIMO	5530	Type5	22	17	335330.0	20	2	76.1	1557.0	1057.0	---	1
11ac80MIMO	5530	Type5	22	18	478825.0	20	3	93.2	1985.0	1018.0	1340.0	1
11ac80MIMO	5530	Type5	22	19	27594.0	20	3	96.8	1760.0	1614.0	1817.0	1
11ac40MIMO	5510	Type5	22	0	261858.0	20	2	77.0	1191.0	1363.0	---	1
11ac40MIMO	5510	Type5	22	1	407646.0	20	1	58.1	1248.0	---	---	1
11ac40MIMO	5510	Type5	22	2	552319.0	20	1	62.1	1836.0	---	---	1
11ac40MIMO	5510	Type5	22	3	99107.0	20	2	76.9	1334.0	1236.0	---	1
11ac40MIMO	5510	Type5	22	4	243514.0	20	2	80.0	1914.0	1852.0	---	1
11ac40MIMO	5510	Type5	22	5	389464.0	20	1	52.0	1701.0	---	---	1
11ac40MIMO	5510	Type5	22	6	531093.0	20	3	88.6	1693.0	1995.0	1905.0	1
11ac40MIMO	5510	Type5	22	7	81159.0	20	2	72.9	1922.0	1387.0	---	1
11ac40MIMO	5510	Type5	22	8	225245.0	20	3	98.5	1839.0	1746.0	1389.0	1
11ac40MIMO	5510	Type5	22	9	371906.0	20	1	57.9	1193.0	---	---	1
11ac40MIMO	5510	Type5	22	10	514197.0	20	3	95.9	1659.0	1870.0	1066.0	1
11ac40MIMO	5510	Type5	22	11	63561.0	20	1	53.5	1162.0	---	---	1
11ac40MIMO	5510	Type5	22	12	207510.0	20	3	92.0	1745.0	1654.0	1458.0	1
11ac40MIMO	5510	Type5	22	13	353638.0	20	1	57.3	1834.0	---	---	1
11ac40MIMO	5510	Type5	22	14	497515.0	20	2	70.5	1684.0	1586.0	---	1
11ac40MIMO	5510	Type5	22	15	45553.0	20	2	70.0	1042.0	1664.0	---	1
11ac40MIMO	5510	Type5	22	16	189821.0	20	3	84.0	1765.0	1630.0	1176.0	1
11ac40MIMO	5510	Type5	22	17	335330.0	20	2	76.1	1557.0	1057.0	---	1
11ac40MIMO	5510	Type5	22	18	478825.0	20	3	93.2	1985.0	1018.0	1340.0	1
11ac40MIMO	5510	Type5	22	19	27594.0	20	3	96.8	1760.0	1614.0	1817.0	1
11ac20MIMO	5500	Type5	22	0	261858.0	20	2	77.0	1191.0	1363.0	---	1
11ac20MIMO	5500	Type5	22	1	407646.0	20	1	58.1	1248.0	---	---	1
11ac20MIMO	5500	Type5	22	2	552319.0	20	1	62.1	1836.0	---	---	1
11ac20MIMO	5500	Type5	22	3	99107.0	20	2	76.9	1334.0	1236.0	---	1
11ac20MIMO	5500	Type5	22	4	243514.0	20	2	80.0	1914.0	1852.0	---	1
11ac20MIMO	5500	Type5	22	5	389464.0	20	1	52.0	1701.0	---	---	1
11ac20MIMO	5500	Type5	22	6	531093.0	20	3	88.6	1693.0	1995.0	1905.0	1
11ac20MIMO	5500	Type5	22	7	81159.0	20	2	72.9	1922.0	1387.0	---	1
11ac20MIMO	5500	Type5	22	8	225245.0	20	3	98.5	1839.0	1746.0	1389.0	1



Unless otherwise agreed in writing, this document is issued by the Company subject to its General Conditions of Service printed overleaf, available on request or accessible at <http://www.sgs.com/en/Terms-and-Conditions.aspx> and, for electronic format documents, subject to Terms and Conditions for Electronic Documents at <http://www.sgs.com/en/Terms-and-Conditions/Terms-e-Document.aspx>. Attention is drawn to the limitation of liability, indemnification and jurisdiction issues defined therein. Any holder of this document is advised that information contained herein reflects the Company's findings at the time of its intervention only and within the limits of Client's instructions, if any. The Company's sole responsibility is to its Client and this document does not exonerate parties to a transaction from exercising all their rights and obligations under the transaction documents. This document cannot be reproduced except in full, without prior written approval of the Company. Any unauthorized alteration, forgery or falsification of the content or appearance of this document is unlawful and offenders may be prosecuted to the fullest extent of the law. Unless otherwise stated the results shown in this test report refer only to the sample(s) tested and such sample(s) are retained for 30 days only.

Attention: To check the authenticity of testing/inspection report & certificate, please contact us at telephone: (86-755) 8307 1443, or email: CN\_Doccheck@sgs.com

SGS-CSTC Standards Technical Services (Xi'an) Co., Ltd. | 1/F Unit D, Building 1, Kanglong Orange Science Park, No.137, Keyuan 3rd Road, Fengjingyuan Town, Xi'an, Shaanxi, China | 710086 | t: (86-29) 6282 7885 | www.sgs.com.cn | sgs.china@sgs.com  
 中国·西安·沣东新城科里三路137号康隆橙方科技园1号楼D单元1层 | 邮编: 710086 | t: (86-29) 6282 7885 | sgs.china@sgs.com



Report No.: XEWA2310000070RG05

Rev.: 01

Page: 78 of 267

11ac20MIMO	5500	Type5	22	9	371906.0	20	1	57.9	1193.0	---	---	1
11ac20MIMO	5500	Type5	22	10	514197.0	20	3	95.9	1659.0	1870.0	1066.0	1
11ac20MIMO	5500	Type5	22	11	63561.0	20	1	53.5	1162.0	---	---	1
11ac20MIMO	5500	Type5	22	12	207510.0	20	3	92.0	1745.0	1654.0	1458.0	1
11ac20MIMO	5500	Type5	22	13	353638.0	20	1	57.3	1834.0	---	---	1
11ac20MIMO	5500	Type5	22	14	497515.0	20	2	70.5	1684.0	1586.0	---	1
11ac20MIMO	5500	Type5	22	15	45553.0	20	2	70.0	1042.0	1664.0	---	1
11ac20MIMO	5500	Type5	22	16	189821.0	20	3	84.0	1765.0	1630.0	1176.0	1
11ac20MIMO	5500	Type5	22	17	335330.0	20	2	76.1	1557.0	1057.0	---	1
11ac20MIMO	5500	Type5	22	18	478825.0	20	3	93.2	1985.0	1018.0	1340.0	1
11ac20MIMO	5500	Type5	22	19	27594.0	20	3	96.8	1760.0	1614.0	1817.0	1



Unless otherwise agreed in writing, this document is issued by the Company subject to its General Conditions of Service printed overleaf, available on request or accessible at <http://www.sgs.com/en/Terms-and-Conditions.aspx> and, for electronic format documents, subject to Terms and Conditions for Electronic Documents at <http://www.sgs.com/en/Terms-and-Conditions/Terms-e-Documents.aspx>. Attention is drawn to the limitation of liability, indemnification and jurisdiction issues defined therein. Any holder of this document is advised that information contained herein reflects the Company's findings at the time of its intervention only and within the limits of Client's instructions, if any. The Company's sole responsibility is to its Client and this document does not exonerate parties to a transaction from exercising all their rights and obligations under the transaction documents. This document cannot be reproduced except in full, without prior written approval of the Company. Any unauthorized alteration, forgery or falsification of the content or appearance of this document is unlawful and offenders may be prosecuted to the fullest extent of the law. Unless otherwise stated the results shown in this test report refer only to the sample(s) tested and such sample(s) are retained for 30 days only.

Attention: To check the authenticity of testing/inspection report & certificate, please contact us at telephone: (86-755) 4307 1443, or email: [CN.Doccheck@sgs.com](mailto:CN.Doccheck@sgs.com)  
 (X'ian Office) SGS-CSTC Standards Technical Services (Xi'an) Co., Ltd. | (86-29) 6282 7885 | www.sgs.com.cn  
 中国·西安·沣东新城科园三路137号康鸿楼方科技园1号楼D单元1层 | 邮编: 710086 | (86-29) 6282 7885 | sgs.china@sgs.com

TestMode	Channel	Radar Type	Trial ID	Burst ID	Burst Offset (µs)	Chirp Width (MHz)	Number Of Pulses	Pulse Width (µs)	PRI1 (µs)	PRI2 (µs)	PRI3 (µs)	Detection (1: Yes; 0: No)
11ac80MIMO	5530	Type5	23	0	247117.0	12	1	50.1	1841.0	---	---	1
11ac80MIMO	5530	Type5	23	1	453362.0	12	3	93.5	1590.0	1081.0	1413.0	1
11ac80MIMO	5530	Type5	23	2	660875.0	12	2	68.8	1707.0	1577.0	---	1
11ac80MIMO	5530	Type5	23	3	14140.0	12	1	56.3	1056.0	---	---	1
11ac80MIMO	5530	Type5	23	4	220734.0	12	3	86.0	1953.0	1108.0	1987.0	1
11ac80MIMO	5530	Type5	23	5	428367.0	12	2	75.2	1572.0	1536.0	---	1
11ac80MIMO	5530	Type5	23	6	636681.0	12	1	54.4	1517.0	---	---	1
11ac80MIMO	5530	Type5	23	7	843157.0	12	2	71.1	1329.0	1243.0	---	1
11ac80MIMO	5530	Type5	23	8	195585.0	12	2	76.2	1940.0	1770.0	---	1
11ac80MIMO	5530	Type5	23	9	403231.0	12	2	80.2	1098.0	1209.0	---	1
11ac80MIMO	5530	Type5	23	10	610202.0	12	2	79.7	1588.0	1214.0	---	1
11ac80MIMO	5530	Type5	23	11	815229.0	12	3	90.9	1615.0	1862.0	1601.0	1
11ac80MIMO	5530	Type5	23	12	170267.0	12	2	68.7	1377.0	1441.0	---	1
11ac80MIMO	5530	Type5	23	13	377306.0	12	2	67.4	1872.0	1313.0	---	1
11ac40MIMO	5510	Type5	23	0	247117.0	12	1	50.1	1841.0	---	---	1
11ac40MIMO	5510	Type5	23	1	453362.0	12	3	93.5	1590.0	1081.0	1413.0	1
11ac40MIMO	5510	Type5	23	2	660875.0	12	2	68.8	1707.0	1577.0	---	1
11ac40MIMO	5510	Type5	23	3	14140.0	12	1	56.3	1056.0	---	---	1
11ac40MIMO	5510	Type5	23	4	220734.0	12	3	86.0	1953.0	1108.0	1987.0	1
11ac40MIMO	5510	Type5	23	5	428367.0	12	2	75.2	1572.0	1536.0	---	1
11ac40MIMO	5510	Type5	23	6	636681.0	12	1	54.4	1517.0	---	---	1
11ac40MIMO	5510	Type5	23	7	843157.0	12	2	71.1	1329.0	1243.0	---	1
11ac40MIMO	5510	Type5	23	8	195585.0	12	2	76.2	1940.0	1770.0	---	1
11ac40MIMO	5510	Type5	23	9	403231.0	12	2	80.2	1098.0	1209.0	---	1
11ac40MIMO	5510	Type5	23	10	610202.0	12	2	79.7	1588.0	1214.0	---	1
11ac40MIMO	5510	Type5	23	11	815229.0	12	3	90.9	1615.0	1862.0	1601.0	1
11ac40MIMO	5510	Type5	23	12	170267.0	12	2	68.7	1377.0	1441.0	---	1
11ac40MIMO	5510	Type5	23	13	377306.0	12	2	67.4	1872.0	1313.0	---	1
11ac20MIMO	5500	Type5	23	0	247117.0	12	1	50.1	1841.0	---	---	1
11ac20MIMO	5500	Type5	23	1	453362.0	12	3	93.5	1590.0	1081.0	1413.0	1
11ac20MIMO	5500	Type5	23	2	660875.0	12	2	68.8	1707.0	1577.0	---	1
11ac20MIMO	5500	Type5	23	3	14140.0	12	1	56.3	1056.0	---	---	1
11ac20MIMO	5500	Type5	23	4	220734.0	12	3	86.0	1953.0	1108.0	1987.0	1
11ac20MIMO	5500	Type5	23	5	428367.0	12	2	75.2	1572.0	1536.0	---	1
11ac20MIMO	5500	Type5	23	6	636681.0	12	1	54.4	1517.0	---	---	1
11ac20MIMO	5500	Type5	23	7	843157.0	12	2	71.1	1329.0	1243.0	---	1
11ac20MIMO	5500	Type5	23	8	195585.0	12	2	76.2	1940.0	1770.0	---	1
11ac20MIMO	5500	Type5	23	9	403231.0	12	2	80.2	1098.0	1209.0	---	1
11ac20MIMO	5500	Type5	23	10	610202.0	12	2	79.7	1588.0	1214.0	---	1
11ac20MIMO	5500	Type5	23	11	815229.0	12	3	90.9	1615.0	1862.0	1601.0	1
11ac20MIMO	5500	Type5	23	12	170267.0	12	2	68.7	1377.0	1441.0	---	1
11ac20MIMO	5500	Type5	23	13	377306.0	12	2	67.4	1872.0	1313.0	---	1



Unless otherwise agreed in writing, this document is issued by the Company subject to its General Conditions of Service printed overleaf, available on request or accessible at <http://www.sgs.com/en/Terms-and-Conditions.aspx> and, for electronic format documents, subject to Terms and Conditions for Electronic Documents at <http://www.sgs.com/en/Terms-and-Conditions/Terms-e-Documents.aspx>. Attention is drawn to the limitation of liability, indemnification and jurisdiction issues defined therein. Any holder of this document is advised that information contained herein reflects the Company's findings at the time of its intervention only and within the limits of Client's instructions, if any. The Company's sole responsibility is to its Client and this document does not exonerate parties to a transaction from exercising all their rights and obligations under the transaction documents. This document cannot be reproduced except in full, without prior written approval of the Company. Any unauthorized alteration, forgery or falsification of the content or appearance of this document is unlawful and offenders may be prosecuted to the fullest extent of the law. Unless otherwise stated the results shown in this test report refer only to the sample(s) tested and such sample(s) are retained for 30 days only.

Attention: To check the authenticity of testing/inspection report & certificate, please contact us at telephone: (86-755) 8307 1443, or email: [CN.Doccheck@sgs.com](mailto:CN.Doccheck@sgs.com)  
 1/F Unit D, Building 1, Kanglong Orange Science Park, No.137, Keyuan 3rd Road, Fengling New Town, Xi'an, Shaanxi, China 710086 t (86-29) 6282 7885 www.sgs.com.cn  
 中国·西安·沣东新城科园三路137号康隆橙方科技园1号楼D单元1层 邮编: 710086 t (86-29) 6282 7885 sgs.china@sgs.com



Report No.: XEWA231000070RG05

Rev.: 01

Page: 80 of 267

TestMode	Channel	Radar Type	Trial ID	Burst ID	Burst Offset (µs)	Chirp Width (MHz)	Number Of Pulses	Pulse Width (µs)	PRI1 (µs)	PRI2 (µs)	PRI3 (µs)	Detection (1: Yes; 0: No)
11ac80MIMO	5530	Type5	24	0	628071.0	11	3	94.0	1643.0	1748.0	1941.0	1
11ac80MIMO	5530	Type5	24	1	853391.0	11	2	70.8	1177.0	1201.0	---	1
11ac80MIMO	5530	Type5	24	2	156223.0	11	1	56.3	1006.0	---	---	1
11ac80MIMO	5530	Type5	24	3	378734.0	11	3	96.7	1230.0	1163.0	1332.0	1
11ac80MIMO	5530	Type5	24	4	601331.0	11	3	90.6	1217.0	1582.0	1498.0	1
11ac80MIMO	5530	Type5	24	5	825462.0	11	2	74.5	1569.0	1281.0	---	1
11ac80MIMO	5530	Type5	24	6	128265.0	11	3	92.6	1065.0	1669.0	1222.0	1
11ac80MIMO	5530	Type5	24	7	351161.0	11	3	89.0	1493.0	1135.0	1380.0	1
11ac80MIMO	5530	Type5	24	8	573425.0	11	3	96.5	1607.0	1822.0	1602.0	1
11ac80MIMO	5530	Type5	24	9	798431.0	11	2	70.5	1141.0	1178.0	---	1
11ac80MIMO	5530	Type5	24	10	100737.0	11	3	94.0	1009.0	1629.0	1956.0	1
11ac80MIMO	5530	Type5	24	11	324661.0	11	1	55.8	1290.0	---	---	1
11ac80MIMO	5530	Type5	24	12	546278.0	11	3	87.7	1435.0	1963.0	1164.0	1
11ac40MIMO	5510	Type5	24	0	628071.0	11	3	94.0	1643.0	1748.0	1941.0	1
11ac40MIMO	5510	Type5	24	1	853391.0	11	2	70.8	1177.0	1201.0	---	1
11ac40MIMO	5510	Type5	24	2	156223.0	11	1	56.3	1006.0	---	---	1
11ac40MIMO	5510	Type5	24	3	378734.0	11	3	96.7	1230.0	1163.0	1332.0	1
11ac40MIMO	5510	Type5	24	4	601331.0	11	3	90.6	1217.0	1582.0	1498.0	1
11ac40MIMO	5510	Type5	24	5	825462.0	11	2	74.5	1569.0	1281.0	---	1
11ac40MIMO	5510	Type5	24	6	128265.0	11	3	92.6	1065.0	1669.0	1222.0	1
11ac40MIMO	5510	Type5	24	7	351161.0	11	3	89.0	1493.0	1135.0	1380.0	1
11ac40MIMO	5510	Type5	24	8	573425.0	11	3	96.5	1607.0	1822.0	1602.0	1
11ac40MIMO	5510	Type5	24	9	798431.0	11	2	70.5	1141.0	1178.0	---	1
11ac40MIMO	5510	Type5	24	10	100737.0	11	3	94.0	1009.0	1629.0	1956.0	1
11ac40MIMO	5510	Type5	24	11	324661.0	11	1	55.8	1290.0	---	---	1
11ac40MIMO	5510	Type5	24	12	546278.0	11	3	87.7	1435.0	1963.0	1164.0	1
11ac20MIMO	5500	Type5	24	0	628071.0	11	3	94.0	1643.0	1748.0	1941.0	1
11ac20MIMO	5500	Type5	24	1	853391.0	11	2	70.8	1177.0	1201.0	---	1
11ac20MIMO	5500	Type5	24	2	156223.0	11	1	56.3	1006.0	---	---	1
11ac20MIMO	5500	Type5	24	3	378734.0	11	3	96.7	1230.0	1163.0	1332.0	1
11ac20MIMO	5500	Type5	24	4	601331.0	11	3	90.6	1217.0	1582.0	1498.0	1
11ac20MIMO	5500	Type5	24	5	825462.0	11	2	74.5	1569.0	1281.0	---	1
11ac20MIMO	5500	Type5	24	6	128265.0	11	3	92.6	1065.0	1669.0	1222.0	1
11ac20MIMO	5500	Type5	24	7	351161.0	11	3	89.0	1493.0	1135.0	1380.0	1
11ac20MIMO	5500	Type5	24	8	573425.0	11	3	96.5	1607.0	1822.0	1602.0	1
11ac20MIMO	5500	Type5	24	9	798431.0	11	2	70.5	1141.0	1178.0	---	1
11ac20MIMO	5500	Type5	24	10	100737.0	11	3	94.0	1009.0	1629.0	1956.0	1
11ac20MIMO	5500	Type5	24	11	324661.0	11	1	55.8	1290.0	---	---	1
11ac20MIMO	5500	Type5	24	12	546278.0	11	3	87.7	1435.0	1963.0	1164.0	1



Unless otherwise agreed in writing, this document is issued by the Company subject to its General Conditions of Service printed overleaf, available on request or accessible at <http://www.sgs.com/en/Terms-and-Conditions.aspx> and, for electronic format documents, subject to Terms and Conditions for Electronic Documents at <http://www.sgs.com/en/Terms-and-Conditions/Terms-e-Documents.aspx>. Attention is drawn to the limitation of liability, indemnification and jurisdiction issues defined therein. Any holder of this document is advised that information contained herein reflects the Company's findings at the time of its intervention only and within the limits of Client's instructions, if any. The Company's sole responsibility is to its Client and this document does not exonerate parties to a transaction from exercising all their rights and obligations under the transaction documents. This document cannot be reproduced except in full, without prior written approval of the Company. Any unauthorized alteration, forgery or falsification of the content or appearance of this document is unlawful and offenders may be prosecuted to the fullest extent of the law. Unless otherwise stated the results shown in this test report refer only to the sample(s) tested and such sample(s) are retained for 30 days only.

Attention: To check the authenticity of testing inspection report & certificate, please contact us at telephone: (86-755) 8307 1443, or email: CN.Doccheck@sgs.com  
 1/E Unit D, Building 1, Kanghong Orange Science Park, No.137, Keyuan 3rd Road, Fengling New Town, Xi'an, Shaanxi, China 710086 t (86-29) 6282 7885 www.sgs.com.cn  
 中国·西安·沣东新城科园三路137号康鸿橙方科技园1号楼D单元1层 邮编: 710086 t (86-29) 6282 7885 sgs.china@sgs.com



Report No.: XEWA2310000070RG05

Rev.: 01

Page: 81 of 267

TestMode	Channel	Radar Type	Trial ID	Burst ID	Burst Offset (μs)	Chirp Width (MHz)	Number Of Pulses	Pulse Width (μs)	PRI1 (μs)	PRI2 (μs)	PRI3 (μs)	Detection (1: Yes; 0: No)
11ac80MIMO	5530	Type5	25	0	1253842.0	5	2	68.6	1306.0	1161.0	---	1
11ac80MIMO	5530	Type5	25	1	119486.0	5	2	83.1	1420.0	1315.0	---	1
11ac80MIMO	5530	Type5	25	2	482958.0	5	1	60.9	1687.0	---	---	1
11ac80MIMO	5530	Type5	25	3	845641.0	5	2	77.7	1776.0	1158.0	---	1
11ac80MIMO	5530	Type5	25	4	1208428.0	5	2	77.4	1793.0	1510.0	---	1
11ac80MIMO	5530	Type5	25	5	74748.0	5	2	66.8	1576.0	1323.0	---	1
11ac80MIMO	5530	Type5	25	6	438300.0	5	1	63.7	1333.0	---	---	1
11ac80MIMO	5530	Type5	25	7	800152.0	5	3	91.2	1409.0	1681.0	1275.0	1
11ac40MIMO	5510	Type5	25	0	1253842.0	5	2	68.6	1306.0	1161.0	---	1
11ac40MIMO	5510	Type5	25	1	119486.0	5	2	83.1	1420.0	1315.0	---	1
11ac40MIMO	5510	Type5	25	2	482958.0	5	1	60.9	1687.0	---	---	1
11ac40MIMO	5510	Type5	25	3	845641.0	5	2	77.7	1776.0	1158.0	---	1
11ac40MIMO	5510	Type5	25	4	1208428.0	5	2	77.4	1793.0	1510.0	---	1
11ac40MIMO	5510	Type5	25	5	74748.0	5	2	66.8	1576.0	1323.0	---	1
11ac40MIMO	5510	Type5	25	6	438300.0	5	1	63.7	1333.0	---	---	1
11ac40MIMO	5510	Type5	25	7	800152.0	5	3	91.2	1409.0	1681.0	1275.0	1
11ac20MIMO	5500	Type5	25	0	1253842.0	5	2	68.6	1306.0	1161.0	---	1
11ac20MIMO	5500	Type5	25	1	119486.0	5	2	83.1	1420.0	1315.0	---	1
11ac20MIMO	5500	Type5	25	2	482958.0	5	1	60.9	1687.0	---	---	1
11ac20MIMO	5500	Type5	25	3	845641.0	5	2	77.7	1776.0	1158.0	---	1
11ac20MIMO	5500	Type5	25	4	1208428.0	5	2	77.4	1793.0	1510.0	---	1
11ac20MIMO	5500	Type5	25	5	74748.0	5	2	66.8	1576.0	1323.0	---	1
11ac20MIMO	5500	Type5	25	6	438300.0	5	1	63.7	1333.0	---	---	1
11ac20MIMO	5500	Type5	25	7	800152.0	5	3	91.2	1409.0	1681.0	1275.0	1



Unless otherwise agreed in writing, this document is issued by the Company subject to its General Conditions of Service printed overleaf, available on request or accessible at <http://www.sgs.com/en/Terms-and-Conditions.aspx> and, for electronic format documents, subject to Terms and Conditions for Electronic Documents at <http://www.sgs.com/en/Terms-and-Conditions/Terms-e-Documents.aspx>. Attention is drawn to the limitation of liability, indemnification and jurisdiction issues defined therein. Any holder of this document is advised that information contained herein reflects the Company's findings at the time of its intervention only and within the limits of Client's instructions, if any. The Company's sole responsibility is to its Client and this document does not exonerate parties to a transaction from exercising all their rights and obligations under the transaction documents. This document cannot be reproduced except in full, without prior written approval of the Company. Any unauthorized alteration, forgery or falsification of the content or appearance of this document is unlawful and offenders may be prosecuted to the fullest extent of the law. Unless otherwise stated the results shown in this test report refer only to the sample(s) tested and such sample(s) are retained for 30 days only.

Attention: To check the authenticity of testing/inspection report & certificate, please contact us at telephone: (86-755) 8307 1443, or email: [CN\\_Doccheck@sgs.com](mailto:CN_Doccheck@sgs.com)  
 S/E Unit D, Building 1, Kanglong Orange Science Park, No.137, Kejun 3rd Road, Fengjiao New Town, Xi'an, Shaanxi, China 710086 t (86-29) 6282 7885 www.sgs.com.cn  
 中国·西安·沣东新城科园三路137号康隆橙方科技园1号楼D单元1层 邮编: 710086 t (86-29) 6282 7885 sgs.china@sgs.com



Report No.: XEWA2310000070RG05

Rev.: 01

Page: 82 of 267

Table with 13 columns: TestMode, Channel, Radar Type, Trial ID, Burst ID, Burst Offset (µs), Chirp Width (MHz), Number Of Pulses, Pulse Width (µs), PRI1 (µs), PRI2 (µs), PRI3 (µs), Detection (1: Yes; 0: No). Rows include test data for 11ac80MIMO, 11ac40MIMO, and 11ac20MIMO channels.



Unless otherwise agreed in writing, this document is issued by the Company subject to its General Conditions of Service printed overleaf, available on request or accessible at http://www.sgs.com/en/Terms-and-Conditions.aspx and, for electronic format documents, subject to Terms and Conditions for Electronic Documents at http://www.sgs.com/en/Terms-and-Conditions/Terms-e-Documents.aspx. Attention is drawn to the limitation of liability, indemnification and jurisdiction issues defined therein. Any holder of this document is advised that information contained herein reflects the Company's findings at the time of its intervention only and within the limits of Client's instructions, if any. The Company's sole responsibility is to its Client and this document does not exonerate parties to a transaction from exercising all their rights and obligations under the transaction documents. This document cannot be reproduced except in full, without prior written approval of the Company. Any unauthorized alteration, forgery or falsification of the content or appearance of this document is unlawful and offenders may be prosecuted to the fullest extent of the law. Unless otherwise stated the results shown in this test report refer only to the sample(s) tested and such sample(s) are retained for 30 days only.

Attention: To check the authenticity of testing/inspection report & certificate, please contact us at telephone: (86-755) 8307 1443, or email: CN\_Doccheck@sgs.com  
1/E Unit D, Building 1, Kanghong Orange Science Park, No.157, Keyuan3rd Road, Fengjing/Yan Tuan, Xian, Shaanxi, China 710086 t (86-29) 6282 7885 www.sgs.com.cn  
中国·西安·沣东新城科里三路157号康鸿橙方科技园1号楼D单元1层 邮编: 710086 t (86-29) 6282 7885 sgs.china@sgs.com



Report No.: XEWA2310000070RG05

Rev.: 01

Page: 83 of 267

TestMode	Channel	Radar Type	Trial ID	Burst ID	Burst Offset (μs)	Chirp Width (MHz)	Number Of Pulses	Pulse Width (μs)	PRI1 (μs)	PRI2 (μs)	PRI3 (μs)	Detection (1: Yes; 0: No)
11ac80MIMO	5530	Type5	27	0	565136.0	19	3	85.6	1946.0	1078.0	1015.0	1
11ac80MIMO	5530	Type5	27	1	89970.0	19	2	68.6	1029.0	1780.0	---	1
11ac80MIMO	5530	Type5	27	2	243121.0	19	1	54.2	1111.0	---	---	1
11ac80MIMO	5530	Type5	27	3	396034.0	19	1	61.2	1104.0	---	---	1
11ac80MIMO	5530	Type5	27	4	546225.0	19	3	97.1	1157.0	1969.0	1100.0	1
11ac80MIMO	5530	Type5	27	5	70998.0	19	3	98.3	1142.0	1699.0	1622.0	1
11ac80MIMO	5530	Type5	27	6	224093.0	19	1	62.4	1655.0	---	---	1
11ac80MIMO	5530	Type5	27	7	376127.0	19	2	80.2	1126.0	1769.0	---	1
11ac80MIMO	5530	Type5	27	8	527806.0	19	3	87.5	1216.0	1448.0	1179.0	1
11ac80MIMO	5530	Type5	27	9	52247.0	19	3	85.8	1847.0	1348.0	1472.0	1
11ac80MIMO	5530	Type5	27	10	204582.0	19	3	88.1	1023.0	1124.0	1631.0	1
11ac80MIMO	5530	Type5	27	11	357941.0	19	1	65.3	1848.0	---	---	1
11ac80MIMO	5530	Type5	27	12	510977.0	19	1	52.5	1470.0	---	---	1
11ac80MIMO	5530	Type5	27	13	33698.0	19	1	52.3	1312.0	---	---	1
11ac80MIMO	5530	Type5	27	14	186023.0	19	2	74.1	1915.0	1200.0	---	1
11ac80MIMO	5530	Type5	27	15	339327.0	19	1	54.9	1479.0	---	---	1
11ac80MIMO	5530	Type5	27	16	491053.0	19	2	76.2	1376.0	1502.0	---	1
11ac80MIMO	5530	Type5	27	17	14858.0	19	1	60.4	1758.0	---	---	1
11ac80MIMO	5530	Type5	27	18	167387.0	19	2	81.5	1491.0	1103.0	---	1
11ac40MIMO	5510	Type5	27	0	565136.0	19	3	85.6	1946.0	1078.0	1015.0	1
11ac40MIMO	5510	Type5	27	1	89970.0	19	2	68.6	1029.0	1780.0	---	1
11ac40MIMO	5510	Type5	27	2	243121.0	19	1	54.2	1111.0	---	---	1
11ac40MIMO	5510	Type5	27	3	396034.0	19	1	61.2	1104.0	---	---	1
11ac40MIMO	5510	Type5	27	4	546225.0	19	3	97.1	1157.0	1969.0	1100.0	1
11ac40MIMO	5510	Type5	27	5	70998.0	19	3	98.3	1142.0	1699.0	1622.0	1
11ac40MIMO	5510	Type5	27	6	224093.0	19	1	62.4	1655.0	---	---	1
11ac40MIMO	5510	Type5	27	7	376127.0	19	2	80.2	1126.0	1769.0	---	1
11ac40MIMO	5510	Type5	27	8	527806.0	19	3	87.5	1216.0	1448.0	1179.0	1
11ac40MIMO	5510	Type5	27	9	52247.0	19	3	85.8	1847.0	1348.0	1472.0	1
11ac40MIMO	5510	Type5	27	10	204582.0	19	3	88.1	1023.0	1124.0	1631.0	1
11ac40MIMO	5510	Type5	27	11	357941.0	19	1	65.3	1848.0	---	---	1
11ac40MIMO	5510	Type5	27	12	510977.0	19	1	52.5	1470.0	---	---	1
11ac40MIMO	5510	Type5	27	13	33698.0	19	1	52.3	1312.0	---	---	1
11ac40MIMO	5510	Type5	27	14	186023.0	19	2	74.1	1915.0	1200.0	---	1
11ac40MIMO	5510	Type5	27	15	339327.0	19	1	54.9	1479.0	---	---	1
11ac40MIMO	5510	Type5	27	16	491053.0	19	2	76.2	1376.0	1502.0	---	1
11ac40MIMO	5510	Type5	27	17	14858.0	19	1	60.4	1758.0	---	---	1
11ac40MIMO	5510	Type5	27	18	167387.0	19	2	81.5	1491.0	1103.0	---	1
11ac20MIMO	5500	Type5	27	0	565136.0	19	3	85.6	1946.0	1078.0	1015.0	1
11ac20MIMO	5500	Type5	27	1	89970.0	19	2	68.6	1029.0	1780.0	---	1
11ac20MIMO	5500	Type5	27	2	243121.0	19	1	54.2	1111.0	---	---	1
11ac20MIMO	5500	Type5	27	3	396034.0	19	1	61.2	1104.0	---	---	1
11ac20MIMO	5500	Type5	27	4	546225.0	19	3	97.1	1157.0	1969.0	1100.0	1
11ac20MIMO	5500	Type5	27	5	70998.0	19	3	98.3	1142.0	1699.0	1622.0	1
11ac20MIMO	5500	Type5	27	6	224093.0	19	1	62.4	1655.0	---	---	1
11ac20MIMO	5500	Type5	27	7	376127.0	19	2	80.2	1126.0	1769.0	---	1
11ac20MIMO	5500	Type5	27	8	527806.0	19	3	87.5	1216.0	1448.0	1179.0	1
11ac20MIMO	5500	Type5	27	9	52247.0	19	3	85.8	1847.0	1348.0	1472.0	1
11ac20MIMO	5500	Type5	27	10	204582.0	19	3	88.1	1023.0	1124.0	1631.0	1



Unless otherwise agreed in writing, this document is issued by the Company subject to its General Conditions of Service printed overleaf, available on request or accessible at <http://www.sgs.com/en/Terms-and-Conditions.aspx> and, for electronic format documents, subject to Terms and Conditions for Electronic Documents at <http://www.sgs.com/en/Terms-and-Conditions/Terms-e-Documents.aspx>. Attention is drawn to the limitation of liability, indemnification and jurisdiction issues defined therein. Any holder of this document is advised that information contained herein reflects the Company's findings at the time of its intervention only and within the limits of Client's instructions, if any. The Company's sole responsibility is to its Client and this document does not exonerate parties to a transaction from exercising all their rights and obligations under the transaction documents. This document cannot be reproduced except in full, without prior written approval of the Company. Any unauthorized alteration, forgery or falsification of the content or appearance of this document is unlawful and offenders may be prosecuted to the fullest extent of the law. Unless otherwise stated the results shown in this test report refer only to the sample(s) tested and such sample(s) are retained for 30 days only.

Attention: To check the authenticity of testing/inspection report & certificate, please contact us at telephone: (86-755) 8307 1443, or email: [CN.Doccheck@sgs.com](mailto:CN.Doccheck@sgs.com)  
 (SGS-CSTC) Standards Technical Services (Xi'an) Co., Ltd. | 1/F Unit D, Building 1, Kanglong Orange Science Park, No.137, Keyuan 3rd Road, Fengyang New Town, Xi'an, Shaanxi, China | 710086 | t: (86-29) 6282 7885 | www.sgs.com.cn | sgs.china@sgs.com  
 中国·西安·沣东新城科里三路137号康隆橙方科技园1号楼D单元1层 | 邮编: 710086 | t: (86-29) 6282 7885 | sgs.china@sgs.com

Report No.: XEWA2310000070RG05

Rev.: 01

Page: 84 of 267

11ac20MIMO	5500	Type5	27	11	357941.0	19	1	65.3	1848.0	---	---	1
11ac20MIMO	5500	Type5	27	12	510977.0	19	1	52.5	1470.0	---	---	1
11ac20MIMO	5500	Type5	27	13	33698.0	19	1	52.3	1312.0	---	---	1
11ac20MIMO	5500	Type5	27	14	186023.0	19	2	74.1	1915.0	1200.0	---	1
11ac20MIMO	5500	Type5	27	15	339327.0	19	1	54.9	1479.0	---	---	1
11ac20MIMO	5500	Type5	27	16	491053.0	19	2	76.2	1376.0	1502.0	---	1
11ac20MIMO	5500	Type5	27	17	14858.0	19	1	60.4	1758.0	---	---	1
11ac20MIMO	5500	Type5	27	18	167387.0	19	2	81.5	1491.0	1103.0	---	1



Unless otherwise agreed in writing, this document is issued by the Company subject to its General Conditions of Service printed overleaf, available on request or accessible at <http://www.sgs.com/en/Terms-and-Conditions.aspx> and, for electronic format documents, subject to Terms and Conditions for Electronic Documents at <http://www.sgs.com/en/Terms-and-Conditions/Terms-e-Documents.aspx>. Attention is drawn to the limitation of liability, indemnification and jurisdiction issues defined therein. Any holder of this document is advised that information contained herein reflects the Company's findings at the time of its intervention only and within the limits of Client's instructions, if any. The Company's sole responsibility is to its Client and this document does not exonerate parties to a transaction from exercising all their rights and obligations under the transaction documents. This document cannot be reproduced except in full, without prior written approval of the Company. Any unauthorized alteration, forgery or falsification of the content or appearance of this document is unlawful and offenders may be prosecuted to the fullest extent of the law. Unless otherwise stated the results shown in this test report refer only to the sample(s) tested and such sample(s) are retained for 30 days only.

SGS-CSTC Standards Technical Services (Xi'an) Co., Ltd.  
 (Website: [www.sgs.com](http://www.sgs.com))

1/E Unit D Building 1, Kanghong Orange Science Park, No.137, Keyuan 3rd Road, Fengling New Town, Xi'an, Shaanxi, China 710086  
 中国·西安·沣东新城科源三路137号康鸿橙方科技园1号楼D单元1层 邮编: 710086

t (86-29) 6282 7885 www.sgs.com.cn  
 t (86-29) 6282 7885 sgs.china@sgs.com



Report No.: XEWA2310000070RG05

Rev.: 01

Page: 85 of 267

TestMode	Channel	Radar Type	Trial ID	Burst ID	Burst Offset (µs)	Chirp Width (MHz)	Number Of Pulses	Pulse Width (µs)	PRI1 (µs)	PRI2 (µs)	PRI3 (µs)	Detection (1: Yes; 0: No)
11ac80MIMO	5530	Type5	28	0	507709.0	10	1	50.5	1857.0	---	---	1
11ac80MIMO	5530	Type5	28	1	750249.0	10	1	55.7	1246.0	---	---	1
11ac80MIMO	5530	Type5	28	2	989003.0	10	3	85.8	1774.0	1002.0	1967.0	1
11ac80MIMO	5530	Type5	28	3	235634.0	10	2	76.9	1125.0	1474.0	---	1
11ac80MIMO	5530	Type5	28	4	477675.0	10	2	75.1	1254.0	1052.0	---	1
11ac80MIMO	5530	Type5	28	5	718312.0	10	3	92.3	1180.0	1486.0	1492.0	1
11ac80MIMO	5530	Type5	28	6	960895.0	10	2	78.1	1301.0	1757.0	---	1
11ac80MIMO	5530	Type5	28	7	205370.0	10	3	92.2	1898.0	1252.0	1713.0	1
11ac80MIMO	5530	Type5	28	8	446940.0	10	3	89.0	1260.0	1706.0	1411.0	1
11ac80MIMO	5530	Type5	28	9	689225.0	10	2	70.9	1578.0	1620.0	---	1
11ac80MIMO	5530	Type5	28	10	932305.0	10	1	63.1	1782.0	---	---	1
11ac80MIMO	5530	Type5	28	11	176231.0	10	1	55.3	1522.0	---	---	1
11ac40MIMO	5510	Type5	28	0	507709.0	10	1	50.5	1857.0	---	---	1
11ac40MIMO	5510	Type5	28	1	750249.0	10	1	55.7	1246.0	---	---	1
11ac40MIMO	5510	Type5	28	2	989003.0	10	3	85.8	1774.0	1002.0	1967.0	1
11ac40MIMO	5510	Type5	28	3	235634.0	10	2	76.9	1125.0	1474.0	---	1
11ac40MIMO	5510	Type5	28	4	477675.0	10	2	75.1	1254.0	1052.0	---	1
11ac40MIMO	5510	Type5	28	5	718312.0	10	3	92.3	1180.0	1486.0	1492.0	1
11ac40MIMO	5510	Type5	28	6	960895.0	10	2	78.1	1301.0	1757.0	---	1
11ac40MIMO	5510	Type5	28	7	205370.0	10	3	92.2	1898.0	1252.0	1713.0	1
11ac40MIMO	5510	Type5	28	8	446940.0	10	3	89.0	1260.0	1706.0	1411.0	1
11ac40MIMO	5510	Type5	28	9	689225.0	10	2	70.9	1578.0	1620.0	---	1
11ac40MIMO	5510	Type5	28	10	932305.0	10	1	63.1	1782.0	---	---	1
11ac40MIMO	5510	Type5	28	11	176231.0	10	1	55.3	1522.0	---	---	1
11ac20MIMO	5500	Type5	28	0	507709.0	10	1	50.5	1857.0	---	---	1
11ac20MIMO	5500	Type5	28	1	750249.0	10	1	55.7	1246.0	---	---	1
11ac20MIMO	5500	Type5	28	2	989003.0	10	3	85.8	1774.0	1002.0	1967.0	1
11ac20MIMO	5500	Type5	28	3	235634.0	10	2	76.9	1125.0	1474.0	---	1
11ac20MIMO	5500	Type5	28	4	477675.0	10	2	75.1	1254.0	1052.0	---	1
11ac20MIMO	5500	Type5	28	5	718312.0	10	3	92.3	1180.0	1486.0	1492.0	1
11ac20MIMO	5500	Type5	28	6	960895.0	10	2	78.1	1301.0	1757.0	---	1
11ac20MIMO	5500	Type5	28	7	205370.0	10	3	92.2	1898.0	1252.0	1713.0	1
11ac20MIMO	5500	Type5	28	8	446940.0	10	3	89.0	1260.0	1706.0	1411.0	1
11ac20MIMO	5500	Type5	28	9	689225.0	10	2	70.9	1578.0	1620.0	---	1
11ac20MIMO	5500	Type5	28	10	932305.0	10	1	63.1	1782.0	---	---	1
11ac20MIMO	5500	Type5	28	11	176231.0	10	1	55.3	1522.0	---	---	1



Unless otherwise agreed in writing, this document is issued by the Company subject to its General Conditions of Service printed overleaf, available on request or accessible at <http://www.sgs.com/en/Terms-and-Conditions.aspx> and, for electronic format documents, subject to Terms and Conditions for Electronic Documents at <http://www.sgs.com/en/Terms-and-Conditions/Terms-e-Documents.aspx>. Attention is drawn to the limitation of liability, indemnification and jurisdiction issues defined therein. Any holder of this document is advised that information contained herein reflects the Company's findings at the time of its intervention only and within the limits of Client's instructions, if any. The Company's sole responsibility is to its Client and this document does not exonerate parties to a transaction from exercising all their rights and obligations under the transaction documents. This document cannot be reproduced except in full, without prior written approval of the Company. Any unauthorized alteration, forgery or falsification of the content or appearance of this document is unlawful and offenders may be prosecuted to the fullest extent of the law. Unless otherwise stated the results shown in this test report refer only to the sample(s) tested and such sample(s) are retained for 30 days only.

Attention: To check the authenticity of testing/inspection report & certificate, please contact us at telephone: (86-755) 4307 1443, or email: CN.Doccheck@sgs.com  
 (US) Unit D, Building 1, Kanghong Orange Science Park, No.157, Keyuan 3rd Road, Fengling New Town, Xi'an, Shaanxi, China 710086 t (86-29) 6282 7885 www.sgs.com.cn  
 中国·西安·沣东新城科园三路157号康鸿橙方科技园1号楼D单元1层 邮编: 710086 t (86-29) 6282 7885 sgs.china@sgs.com



Report No.: XEWA2310000070RG05

Rev.: 01

Page: 86 of 267

TestMode	Channel	Radar Type	Trial ID	Burst ID	Burst Offset (µs)	Chirp Width (MHz)	Number Of Pulses	Pulse Width (µs)	PRI1 (µs)	PRI2 (µs)	PRI3 (µs)	Detection (1: Yes; 0: No)
11ac80MIMO	5530	Type5	29	0	277485.0	17	3	83.4	1454.0	1205.0	1801.0	1
11ac80MIMO	5530	Type5	29	1	437880.0	17	3	97.3	1319.0	1826.0	1635.0	1
11ac80MIMO	5530	Type5	29	2	598445.0	17	3	90.4	1079.0	1986.0	1674.0	1
11ac80MIMO	5530	Type5	29	3	97088.0	17	3	91.8	1563.0	1151.0	1802.0	1
11ac80MIMO	5530	Type5	29	4	257251.0	17	3	98.2	1876.0	1977.0	1766.0	1
11ac80MIMO	5530	Type5	29	5	419893.0	17	1	59.5	1952.0	---	---	1
11ac80MIMO	5530	Type5	29	6	580724.0	17	2	80.0	1253.0	1137.0	---	1
11ac80MIMO	5530	Type5	29	7	77366.0	17	3	86.5	1054.0	1128.0	1828.0	1
11ac80MIMO	5530	Type5	29	8	238032.0	17	3	91.1	1105.0	1599.0	1442.0	1
11ac80MIMO	5530	Type5	29	9	398605.0	17	3	93.5	1867.0	1373.0	1087.0	1
11ac80MIMO	5530	Type5	29	10	562025.0	17	1	60.7	1033.0	---	---	1
11ac80MIMO	5530	Type5	29	11	57684.0	17	2	67.2	1288.0	1405.0	---	1
11ac80MIMO	5530	Type5	29	12	219083.0	17	1	61.8	1585.0	---	---	1
11ac80MIMO	5530	Type5	29	13	379234.0	17	2	79.4	1933.0	1667.0	---	1
11ac80MIMO	5530	Type5	29	14	540896.0	17	2	81.4	1096.0	1464.0	---	1
11ac80MIMO	5530	Type5	29	15	37916.0	17	1	65.7	1496.0	---	---	1
11ac80MIMO	5530	Type5	29	16	198794.0	17	2	76.0	1733.0	1255.0	---	1
11ac80MIMO	5530	Type5	29	17	359754.0	17	2	81.0	1326.0	1668.0	---	1
11ac40MIMO	5510	Type5	29	0	277485.0	17	3	83.4	1454.0	1205.0	1801.0	1
11ac40MIMO	5510	Type5	29	1	437880.0	17	3	97.3	1319.0	1826.0	1635.0	1
11ac40MIMO	5510	Type5	29	2	598445.0	17	3	90.4	1079.0	1986.0	1674.0	1
11ac40MIMO	5510	Type5	29	3	97088.0	17	3	91.8	1563.0	1151.0	1802.0	1
11ac40MIMO	5510	Type5	29	4	257251.0	17	3	98.2	1876.0	1977.0	1766.0	1
11ac40MIMO	5510	Type5	29	5	419893.0	17	1	59.5	1952.0	---	---	1
11ac40MIMO	5510	Type5	29	6	580724.0	17	2	80.0	1253.0	1137.0	---	1
11ac40MIMO	5510	Type5	29	7	77366.0	17	3	86.5	1054.0	1128.0	1828.0	1
11ac40MIMO	5510	Type5	29	8	238032.0	17	3	91.1	1105.0	1599.0	1442.0	1
11ac40MIMO	5510	Type5	29	9	398605.0	17	3	93.5	1867.0	1373.0	1087.0	1
11ac40MIMO	5510	Type5	29	10	562025.0	17	1	60.7	1033.0	---	---	1
11ac40MIMO	5510	Type5	29	11	57684.0	17	2	67.2	1288.0	1405.0	---	1
11ac40MIMO	5510	Type5	29	12	219083.0	17	1	61.8	1585.0	---	---	1
11ac40MIMO	5510	Type5	29	13	379234.0	17	2	79.4	1933.0	1667.0	---	1
11ac40MIMO	5510	Type5	29	14	540896.0	17	2	81.4	1096.0	1464.0	---	1
11ac40MIMO	5510	Type5	29	15	37916.0	17	1	65.7	1496.0	---	---	1
11ac40MIMO	5510	Type5	29	16	198794.0	17	2	76.0	1733.0	1255.0	---	1
11ac40MIMO	5510	Type5	29	17	359754.0	17	2	81.0	1326.0	1668.0	---	1
11ac20MIMO	5500	Type5	29	0	277485.0	17	3	83.4	1454.0	1205.0	1801.0	1
11ac20MIMO	5500	Type5	29	1	437880.0	17	3	97.3	1319.0	1826.0	1635.0	1
11ac20MIMO	5500	Type5	29	2	598445.0	17	3	90.4	1079.0	1986.0	1674.0	1
11ac20MIMO	5500	Type5	29	3	97088.0	17	3	91.8	1563.0	1151.0	1802.0	1
11ac20MIMO	5500	Type5	29	4	257251.0	17	3	98.2	1876.0	1977.0	1766.0	1
11ac20MIMO	5500	Type5	29	5	419893.0	17	1	59.5	1952.0	---	---	1
11ac20MIMO	5500	Type5	29	6	580724.0	17	2	80.0	1253.0	1137.0	---	1
11ac20MIMO	5500	Type5	29	7	77366.0	17	3	86.5	1054.0	1128.0	1828.0	1
11ac20MIMO	5500	Type5	29	8	238032.0	17	3	91.1	1105.0	1599.0	1442.0	1
11ac20MIMO	5500	Type5	29	9	398605.0	17	3	93.5	1867.0	1373.0	1087.0	1
11ac20MIMO	5500	Type5	29	10	562025.0	17	1	60.7	1033.0	---	---	1
11ac20MIMO	5500	Type5	29	11	57684.0	17	2	67.2	1288.0	1405.0	---	1
11ac20MIMO	5500	Type5	29	12	219083.0	17	1	61.8	1585.0	---	---	1



Unless otherwise agreed in writing, this document is issued by the Company subject to its General Conditions of Service printed overleaf, available on request or accessible at <http://www.sgs.com/en/Terms-and-Conditions.aspx> and, for electronic format documents, subject to Terms and Conditions for Electronic Documents at <http://www.sgs.com/en/Terms-and-Conditions/Terms-e-Document.aspx>. Attention is drawn to the limitation of liability, indemnification and jurisdiction issues defined therein. Any holder of this document is advised that information contained herein reflects the Company's findings at the time of its intervention only and within the limits of Client's instructions, if any. The Company's sole responsibility is to its Client and this document does not exonerate parties to a transaction from exercising all their rights and obligations under the transaction documents. This document cannot be reproduced except in full, without prior written approval of the Company. Any unauthorized alteration, forgery or falsification of the content or appearance of this document is unlawful and offenders may be prosecuted to the fullest extent of the law. Unless otherwise stated the results shown in this test report refer only to the sample(s) tested and such sample(s) are retained for 30 days only.

Attention: To check the authenticity of testing/inspection report & certificate, please contact us at telephone: (86-755) 8307 1443, or email: CN\_Doccheck@sgs.com

SGS-CSTC Standards Technical Services (Xi'an) Co., Ltd. | 1/F Unit D, Building 1, Kanglong Orange Science Park, No.137, Keyuan 3rd Road, Fengling/Yan Town, Xi'an, Shaanxi, China | 710086 | t: (86-29) 6282 7885 | www.sgs.com.cn | sgs.china@sgs.com  
 中国·西安·沣东新城科里三路137号康隆橙方科技园1号楼D单元1层 | 邮编: 710086 | t: (86-29) 6282 7885 | sgs.china@sgs.com

Report No.: XEWA2310000070RG05

Rev.: 01

Page: 87 of 267

11ac20MIMO	5500	Type5	29	13	379234.0	17	2	79.4	1933.0	1667.0	---	1
11ac20MIMO	5500	Type5	29	14	540896.0	17	2	81.4	1096.0	1464.0	---	1
11ac20MIMO	5500	Type5	29	15	37916.0	17	1	65.7	1496.0	---	---	1
11ac20MIMO	5500	Type5	29	16	198794.0	17	2	76.0	1733.0	1255.0	---	1
11ac20MIMO	5500	Type5	29	17	359754.0	17	2	81.0	1326.0	1668.0	---	1



Unless otherwise agreed in writing, this document is issued by the Company subject to its General Conditions of Service printed overleaf, available on request or accessible at <http://www.sgs.com/en/Terms-and-Conditions.aspx> and, for electronic format documents, subject to Terms and Conditions for Electronic Documents at <http://www.sgs.com/en/Terms-and-Conditions/Terms-e-Documents.aspx>. Attention is drawn to the limitation of liability, indemnification and jurisdiction issues defined therein. Any holder of this document is advised that information contained herein reflects the Company's findings at the time of its intervention only and within the limits of Client's instructions, if any. The Company's sole responsibility is to its Client and this document does not exonerate parties to a transaction from exercising all their rights and obligations under the transaction documents. This document cannot be reproduced except in full, without prior written approval of the Company. Any unauthorized alteration, forgery or falsification of the content or appearance of this document is unlawful and offenders may be prosecuted to the fullest extent of the law. Unless otherwise stated the results shown in this test report refer only to the sample(s) tested and such sample(s) are retained for 30 days only.

Attention: To check the authenticity of testing/inspection report & certificate, please contact us at telephone: (86-755) 8307 1443, or email: [CN.Doccheck@sgs.com](mailto:CN.Doccheck@sgs.com)

SGS-CSTC Standards Technical Services (Xi'an) Co., Ltd. | WE Unit D Building 1, Kanghong Orange Science Park, No.137, Keyuan 3rd Road, Fengfeng New Town, Xi'an, Shaanxi, China 710086 | t (86-29) 6282 7885 | [www.sgs.com](http://www.sgs.com)  
 中国·西安·沣东新城科园三路137号康鸿橙方科技园1号楼D单元1层 邮编: 710086 | t (86-29) 6282 7885 | [sgs.china@sgs.com](mailto:sgs.china@sgs.com)

TestMode	Channel	Radar Type	Trial ID	Pulse width (μs)	PRI (μs)	Pulses per Hop	Hop Rate (kHz)	Hop Sequence Length(ms)	Center Frequency (MHz)	Detection (1: Yes; 0: No)
11ac80MIMO	5530	Type6	0	1	333.3	9	0.3333	300	5364	1
11ac80MIMO	5530	Type6	0	1	333.3	9	0.3333	300	5717	1
11ac80MIMO	5530	Type6	0	1	333.3	9	0.3333	300	5334	1
11ac80MIMO	5530	Type6	0	1	333.3	9	0.3333	300	5705	1
11ac80MIMO	5530	Type6	0	1	333.3	9	0.3333	300	5549	1
11ac80MIMO	5530	Type6	0	1	333.3	9	0.3333	300	5312	1
11ac80MIMO	5530	Type6	0	1	333.3	9	0.3333	300	5260	1
11ac80MIMO	5530	Type6	0	1	333.3	9	0.3333	300	5635	1
11ac80MIMO	5530	Type6	0	1	333.3	9	0.3333	300	5503	1
11ac80MIMO	5530	Type6	0	1	333.3	9	0.3333	300	5570	1
11ac80MIMO	5530	Type6	0	1	333.3	9	0.3333	300	5347	1
11ac80MIMO	5530	Type6	0	1	333.3	9	0.3333	300	5508	1
11ac80MIMO	5530	Type6	0	1	333.3	9	0.3333	300	5292	1
11ac80MIMO	5530	Type6	0	1	333.3	9	0.3333	300	5447	1
11ac80MIMO	5530	Type6	0	1	333.3	9	0.3333	300	5588	1
11ac80MIMO	5530	Type6	0	1	333.3	9	0.3333	300	5621	1
11ac80MIMO	5530	Type6	0	1	333.3	9	0.3333	300	5638	1
11ac80MIMO	5530	Type6	0	1	333.3	9	0.3333	300	5296	1
11ac80MIMO	5530	Type6	0	1	333.3	9	0.3333	300	5482	1
11ac80MIMO	5530	Type6	0	1	333.3	9	0.3333	300	5455	1
11ac80MIMO	5530	Type6	0	1	333.3	9	0.3333	300	5636	1
11ac80MIMO	5530	Type6	0	1	333.3	9	0.3333	300	5593	1
11ac80MIMO	5530	Type6	0	1	333.3	9	0.3333	300	5434	1
11ac80MIMO	5530	Type6	0	1	333.3	9	0.3333	300	5306	1
11ac80MIMO	5530	Type6	0	1	333.3	9	0.3333	300	5411	1
11ac80MIMO	5530	Type6	0	1	333.3	9	0.3333	300	5556	1
11ac80MIMO	5530	Type6	0	1	333.3	9	0.3333	300	5378	1
11ac80MIMO	5530	Type6	0	1	333.3	9	0.3333	300	5478	1
11ac80MIMO	5530	Type6	0	1	333.3	9	0.3333	300	5432	1
11ac80MIMO	5530	Type6	0	1	333.3	9	0.3333	300	5341	1
11ac80MIMO	5530	Type6	0	1	333.3	9	0.3333	300	5438	1
11ac80MIMO	5530	Type6	0	1	333.3	9	0.3333	300	5294	1
11ac80MIMO	5530	Type6	0	1	333.3	9	0.3333	300	5496	1
11ac80MIMO	5530	Type6	0	1	333.3	9	0.3333	300	5285	1
11ac80MIMO	5530	Type6	0	1	333.3	9	0.3333	300	5327	1
11ac80MIMO	5530	Type6	0	1	333.3	9	0.3333	300	5293	1
11ac80MIMO	5530	Type6	0	1	333.3	9	0.3333	300	5502	1
11ac80MIMO	5530	Type6	0	1	333.3	9	0.3333	300	5277	1
11ac80MIMO	5530	Type6	0	1	333.3	9	0.3333	300	5403	1
11ac80MIMO	5530	Type6	0	1	333.3	9	0.3333	300	5330	1
11ac80MIMO	5530	Type6	0	1	333.3	9	0.3333	300	5612	1
11ac80MIMO	5530	Type6	0	1	333.3	9	0.3333	300	5720	1
11ac80MIMO	5530	Type6	0	1	333.3	9	0.3333	300	5544	1
11ac80MIMO	5530	Type6	0	1	333.3	9	0.3333	300	5615	1
11ac80MIMO	5530	Type6	0	1	333.3	9	0.3333	300	5561	1
11ac80MIMO	5530	Type6	0	1	333.3	9	0.3333	300	5676	1
11ac80MIMO	5530	Type6	0	1	333.3	9	0.3333	300	5704	1
11ac80MIMO	5530	Type6	0	1	333.3	9	0.3333	300	5366	1
11ac80MIMO	5530	Type6	0	1	333.3	9	0.3333	300	5290	1



Unless otherwise agreed in writing, this document is issued by the Company subject to its General Conditions of Service printed overleaf, available on request or accessible at <http://www.sgs.com/en/Terms-and-Conditions.aspx> and, for electronic format documents, subject to Terms and Conditions for Electronic Documents at <http://www.sgs.com/en/Terms-and-Conditions/Terms-e-Documents.aspx>. Attention is drawn to the limitation of liability, indemnification and jurisdiction issues defined therein. Any holder of this document is advised that information contained herein reflects the Company's findings at the time of its intervention only and within the limits of Client's instructions, if any. The Company's sole responsibility is to its Client and this document does not exonerate parties to a transaction from exercising all their rights and obligations under the transaction documents. This document cannot be reproduced except in full, without prior written approval of the Company. Any unauthorized alteration, forgery or falsification of the content or appearance of this document is unlawful and offenders may be prosecuted to the fullest extent of the law. Unless otherwise stated the results shown in this test report refer only to the sample(s) tested and such sample(s) are retained for 30 days only.

Attention: To check the authenticity of testing/inspection report & certificate, please contact us at telephone: (86-755) 8307 1443, or email: [CN.Doccheck@sgs.com](mailto:CN.Doccheck@sgs.com)

SGS-CSTC Standards Technical Services (Xi'an) Co., Ltd. | 1/E Unit D, Building 1, Kanglong Orange Science Park, No.157, Keyuan 3rd Road, Fengjing/Yue Town, Xi'an, Shaanxi, China | 710086 | t (86-29) 6282 7885 | www.sgs.com.cn  
 中国·西安·沣东新城科里三路157号康鸿橙方科技园1号楼D单元1层 | 邮编: 710086 | t (86-29) 6282 7885 | sgs.china@sgs.com





11ac80MIMO	5530	Type6	0	1	333.3	9	0.3333	300	5387	1
11ac80MIMO	5530	Type6	0	1	333.3	9	0.3333	300	5278	1
11ac80MIMO	5530	Type6	0	1	333.3	9	0.3333	300	5723	1
11ac80MIMO	5530	Type6	0	1	333.3	9	0.3333	300	5383	1
11ac80MIMO	5530	Type6	0	1	333.3	9	0.3333	300	5368	1
11ac80MIMO	5530	Type6	0	1	333.3	9	0.3333	300	5263	1
11ac80MIMO	5530	Type6	0	1	333.3	9	0.3333	300	5630	1
11ac80MIMO	5530	Type6	0	1	333.3	9	0.3333	300	5375	1
11ac80MIMO	5530	Type6	0	1	333.3	9	0.3333	300	5718	1
11ac80MIMO	5530	Type6	0	1	333.3	9	0.3333	300	5281	1
11ac80MIMO	5530	Type6	0	1	333.3	9	0.3333	300	5604	1
11ac80MIMO	5530	Type6	0	1	333.3	9	0.3333	300	5453	1
11ac80MIMO	5530	Type6	0	1	333.3	9	0.3333	300	5509	1
11ac80MIMO	5530	Type6	0	1	333.3	9	0.3333	300	5479	1
11ac80MIMO	5530	Type6	0	1	333.3	9	0.3333	300	5400	1
11ac80MIMO	5530	Type6	0	1	333.3	9	0.3333	300	5262	1
11ac80MIMO	5530	Type6	0	1	333.3	9	0.3333	300	5354	1
11ac80MIMO	5530	Type6	0	1	333.3	9	0.3333	300	5467	1
11ac80MIMO	5530	Type6	0	1	333.3	9	0.3333	300	5545	1
11ac80MIMO	5530	Type6	0	1	333.3	9	0.3333	300	5466	1
11ac80MIMO	5530	Type6	0	1	333.3	9	0.3333	300	5611	1
11ac80MIMO	5530	Type6	0	1	333.3	9	0.3333	300	5715	1
11ac80MIMO	5530	Type6	0	1	333.3	9	0.3333	300	5402	1
11ac80MIMO	5530	Type6	0	1	333.3	9	0.3333	300	5568	1
11ac80MIMO	5530	Type6	0	1	333.3	9	0.3333	300	5641	1
11ac80MIMO	5530	Type6	0	1	333.3	9	0.3333	300	5396	1
11ac80MIMO	5530	Type6	0	1	333.3	9	0.3333	300	5567	1
11ac80MIMO	5530	Type6	0	1	333.3	9	0.3333	300	5557	1
11ac80MIMO	5530	Type6	0	1	333.3	9	0.3333	300	5674	1
11ac80MIMO	5530	Type6	0	1	333.3	9	0.3333	300	5359	1
11ac80MIMO	5530	Type6	0	1	333.3	9	0.3333	300	5392	1
11ac80MIMO	5530	Type6	0	1	333.3	9	0.3333	300	5313	1
11ac80MIMO	5530	Type6	0	1	333.3	9	0.3333	300	5537	1
11ac80MIMO	5530	Type6	0	1	333.3	9	0.3333	300	5258	1
11ac80MIMO	5530	Type6	0	1	333.3	9	0.3333	300	5475	1
11ac80MIMO	5530	Type6	0	1	333.3	9	0.3333	300	5272	1
11ac80MIMO	5530	Type6	0	1	333.3	9	0.3333	300	5388	1
11ac80MIMO	5530	Type6	0	1	333.3	9	0.3333	300	5474	1
11ac80MIMO	5530	Type6	0	1	333.3	9	0.3333	300	5555	1
11ac80MIMO	5530	Type6	0	1	333.3	9	0.3333	300	5410	1
11ac80MIMO	5530	Type6	0	1	333.3	9	0.3333	300	5355	1
11ac80MIMO	5530	Type6	0	1	333.3	9	0.3333	300	5517	1
11ac80MIMO	5530	Type6	0	1	333.3	9	0.3333	300	5382	1
11ac80MIMO	5530	Type6	0	1	333.3	9	0.3333	300	5386	1
11ac80MIMO	5530	Type6	0	1	333.3	9	0.3333	300	5664	1
11ac80MIMO	5530	Type6	0	1	333.3	9	0.3333	300	5697	1
11ac80MIMO	5530	Type6	0	1	333.3	9	0.3333	300	5721	1
11ac80MIMO	5530	Type6	0	1	333.3	9	0.3333	300	5268	1
11ac80MIMO	5530	Type6	0	1	333.3	9	0.3333	300	5489	1
11ac80MIMO	5530	Type6	0	1	333.3	9	0.3333	300	5706	1
11ac80MIMO	5530	Type6	0	1	333.3	9	0.3333	300	5525	1
11ac40MIMO	5510	Type6	0	1	333.3	9	0.3333	300	5364	1
11ac40MIMO	5510	Type6	0	1	333.3	9	0.3333	300	5717	1



Unless otherwise agreed in writing, this document is issued by the Company subject to its General Conditions of Service printed overleaf, available on request or accessible at <http://www.sgs.com/en/Terms-and-Conditions.aspx> and, for electronic format documents, subject to Terms and Conditions for Electronic Documents at <http://www.sgs.com/en/Terms-and-Conditions/Terms-e-Documents.aspx>. Attention is drawn to the limitation of liability, indemnification and jurisdiction issues defined therein. Any holder of this document is advised that information contained herein reflects the Company's findings at the time of its intervention only and within the limits of Client's instructions, if any. The Company's sole responsibility is to its Client and this document does not exonerate parties to a transaction from exercising all their rights and obligations under the transaction documents. This document cannot be reproduced except in full, without prior written approval of the Company. Any unauthorized alteration, forgery or falsification of the content or appearance of this document is unlawful and offenders may be prosecuted to the fullest extent of the law. Unless otherwise stated the results shown in this test report refer only to the sample(s) tested and such sample(s) are retained for 30 days only.

Attention: To check the authenticity of testing/inspection report & certificate, please contact us at telephone: (86-755) 8307 1443, or email: [CN.Doccheck@sgs.com](mailto:CN.Doccheck@sgs.com)  
 (E) Unit D, Building 1, Kanglong Orange Science Park, No.157, Keyuan 3rd Road, Fengyang New Town, Xi'an, Shaanxi, China 710086  
 t (86-29) 6282 7885 www.sgs.com.cn  
 中国·西安·沣东新城科里三路157号康隆橙方科技园1号楼D单元1层 邮编: 710086 t (86-29) 6282 7885 sgs.china@sgs.com



11ac40MIMO	5510	Type6	0	1	333.3	9	0.3333	300	5334	1
11ac40MIMO	5510	Type6	0	1	333.3	9	0.3333	300	5705	1
11ac40MIMO	5510	Type6	0	1	333.3	9	0.3333	300	5549	1
11ac40MIMO	5510	Type6	0	1	333.3	9	0.3333	300	5312	1
11ac40MIMO	5510	Type6	0	1	333.3	9	0.3333	300	5260	1
11ac40MIMO	5510	Type6	0	1	333.3	9	0.3333	300	5635	1
11ac40MIMO	5510	Type6	0	1	333.3	9	0.3333	300	5503	1
11ac40MIMO	5510	Type6	0	1	333.3	9	0.3333	300	5570	1
11ac40MIMO	5510	Type6	0	1	333.3	9	0.3333	300	5347	1
11ac40MIMO	5510	Type6	0	1	333.3	9	0.3333	300	5508	1
11ac40MIMO	5510	Type6	0	1	333.3	9	0.3333	300	5292	1
11ac40MIMO	5510	Type6	0	1	333.3	9	0.3333	300	5447	1
11ac40MIMO	5510	Type6	0	1	333.3	9	0.3333	300	5588	1
11ac40MIMO	5510	Type6	0	1	333.3	9	0.3333	300	5621	1
11ac40MIMO	5510	Type6	0	1	333.3	9	0.3333	300	5638	1
11ac40MIMO	5510	Type6	0	1	333.3	9	0.3333	300	5296	1
11ac40MIMO	5510	Type6	0	1	333.3	9	0.3333	300	5482	1
11ac40MIMO	5510	Type6	0	1	333.3	9	0.3333	300	5455	1
11ac40MIMO	5510	Type6	0	1	333.3	9	0.3333	300	5636	1
11ac40MIMO	5510	Type6	0	1	333.3	9	0.3333	300	5593	1
11ac40MIMO	5510	Type6	0	1	333.3	9	0.3333	300	5434	1
11ac40MIMO	5510	Type6	0	1	333.3	9	0.3333	300	5306	1
11ac40MIMO	5510	Type6	0	1	333.3	9	0.3333	300	5411	1
11ac40MIMO	5510	Type6	0	1	333.3	9	0.3333	300	5556	1
11ac40MIMO	5510	Type6	0	1	333.3	9	0.3333	300	5378	1
11ac40MIMO	5510	Type6	0	1	333.3	9	0.3333	300	5478	1
11ac40MIMO	5510	Type6	0	1	333.3	9	0.3333	300	5432	1
11ac40MIMO	5510	Type6	0	1	333.3	9	0.3333	300	5341	1
11ac40MIMO	5510	Type6	0	1	333.3	9	0.3333	300	5438	1
11ac40MIMO	5510	Type6	0	1	333.3	9	0.3333	300	5294	1
11ac40MIMO	5510	Type6	0	1	333.3	9	0.3333	300	5496	1
11ac40MIMO	5510	Type6	0	1	333.3	9	0.3333	300	5285	1
11ac40MIMO	5510	Type6	0	1	333.3	9	0.3333	300	5327	1
11ac40MIMO	5510	Type6	0	1	333.3	9	0.3333	300	5293	1
11ac40MIMO	5510	Type6	0	1	333.3	9	0.3333	300	5502	1
11ac40MIMO	5510	Type6	0	1	333.3	9	0.3333	300	5277	1
11ac40MIMO	5510	Type6	0	1	333.3	9	0.3333	300	5403	1
11ac40MIMO	5510	Type6	0	1	333.3	9	0.3333	300	5330	1
11ac40MIMO	5510	Type6	0	1	333.3	9	0.3333	300	5612	1
11ac40MIMO	5510	Type6	0	1	333.3	9	0.3333	300	5720	1
11ac40MIMO	5510	Type6	0	1	333.3	9	0.3333	300	5544	1
11ac40MIMO	5510	Type6	0	1	333.3	9	0.3333	300	5615	1
11ac40MIMO	5510	Type6	0	1	333.3	9	0.3333	300	5561	1
11ac40MIMO	5510	Type6	0	1	333.3	9	0.3333	300	5676	1
11ac40MIMO	5510	Type6	0	1	333.3	9	0.3333	300	5704	1
11ac40MIMO	5510	Type6	0	1	333.3	9	0.3333	300	5366	1
11ac40MIMO	5510	Type6	0	1	333.3	9	0.3333	300	5290	1
11ac40MIMO	5510	Type6	0	1	333.3	9	0.3333	300	5387	1
11ac40MIMO	5510	Type6	0	1	333.3	9	0.3333	300	5278	1
11ac40MIMO	5510	Type6	0	1	333.3	9	0.3333	300	5723	1
11ac40MIMO	5510	Type6	0	1	333.3	9	0.3333	300	5383	1
11ac40MIMO	5510	Type6	0	1	333.3	9	0.3333	300	5368	1
11ac40MIMO	5510	Type6	0	1	333.3	9	0.3333	300	5263	1



Unless otherwise agreed in writing, this document is issued by the Company subject to its General Conditions of Service printed overleaf, available on request or accessible at <http://www.sgs.com/en/Terms-and-Conditions.aspx> and, for electronic format documents, subject to Terms and Conditions for Electronic Documents at <http://www.sgs.com/en/Terms-and-Conditions/Terms-e-Documents.aspx>. Attention is drawn to the limitation of liability, indemnification and jurisdiction issues defined therein. Any holder of this document is advised that information contained herein reflects the Company's findings at the time of its intervention only and within the limits of Client's instructions, if any. The Company's sole responsibility is to its Client and this document does not exonerate parties to a transaction from exercising all their rights and obligations under the transaction documents. This document cannot be reproduced except in full, without prior written approval of the Company. Any unauthorized alteration, forgery or falsification of the content or appearance of this document is unlawful and offenders may be prosecuted to the fullest extent of the law. Unless otherwise stated the results shown in this test report refer only to the sample(s) tested and such sample(s) are retained for 30 days only.

Attention: To check the authenticity of testing/inspection report & certificate, please contact us at telephone: (86-755) 8307 1443, or email: [CN.Doccheck@sgs.com](mailto:CN.Doccheck@sgs.com)

SGS-CSTC Standards Technical Services (Xi'an) Co., Ltd. | 1/F Unit D, Building 1, Kanglong Orange Science Park, No.137, Keyuan 3rd Road, Fengyang New Town, Xi'an, Shaanxi, China | 710086 | t (86-29) 6282 7885 | www.sgs.com.cn  
 中国·西安·沣东新城科里三路137号康鸿橙方科技园1号楼D单元1层 | 邮编: 710086 | t (86-29) 6282 7885 | sgs.china@sgs.com



11ac40MIMO	5510	Type6	0	1	333.3	9	0.3333	300	5630	1
11ac40MIMO	5510	Type6	0	1	333.3	9	0.3333	300	5375	1
11ac40MIMO	5510	Type6	0	1	333.3	9	0.3333	300	5718	1
11ac40MIMO	5510	Type6	0	1	333.3	9	0.3333	300	5281	1
11ac40MIMO	5510	Type6	0	1	333.3	9	0.3333	300	5604	1
11ac40MIMO	5510	Type6	0	1	333.3	9	0.3333	300	5453	1
11ac40MIMO	5510	Type6	0	1	333.3	9	0.3333	300	5509	1
11ac40MIMO	5510	Type6	0	1	333.3	9	0.3333	300	5479	1
11ac40MIMO	5510	Type6	0	1	333.3	9	0.3333	300	5400	1
11ac40MIMO	5510	Type6	0	1	333.3	9	0.3333	300	5262	1
11ac40MIMO	5510	Type6	0	1	333.3	9	0.3333	300	5354	1
11ac40MIMO	5510	Type6	0	1	333.3	9	0.3333	300	5467	1
11ac40MIMO	5510	Type6	0	1	333.3	9	0.3333	300	5545	1
11ac40MIMO	5510	Type6	0	1	333.3	9	0.3333	300	5466	1
11ac40MIMO	5510	Type6	0	1	333.3	9	0.3333	300	5611	1
11ac40MIMO	5510	Type6	0	1	333.3	9	0.3333	300	5715	1
11ac40MIMO	5510	Type6	0	1	333.3	9	0.3333	300	5402	1
11ac40MIMO	5510	Type6	0	1	333.3	9	0.3333	300	5568	1
11ac40MIMO	5510	Type6	0	1	333.3	9	0.3333	300	5641	1
11ac40MIMO	5510	Type6	0	1	333.3	9	0.3333	300	5396	1
11ac40MIMO	5510	Type6	0	1	333.3	9	0.3333	300	5567	1
11ac40MIMO	5510	Type6	0	1	333.3	9	0.3333	300	5557	1
11ac40MIMO	5510	Type6	0	1	333.3	9	0.3333	300	5674	1
11ac40MIMO	5510	Type6	0	1	333.3	9	0.3333	300	5359	1
11ac40MIMO	5510	Type6	0	1	333.3	9	0.3333	300	5392	1
11ac40MIMO	5510	Type6	0	1	333.3	9	0.3333	300	5313	1
11ac40MIMO	5510	Type6	0	1	333.3	9	0.3333	300	5537	1
11ac40MIMO	5510	Type6	0	1	333.3	9	0.3333	300	5258	1
11ac40MIMO	5510	Type6	0	1	333.3	9	0.3333	300	5475	1
11ac40MIMO	5510	Type6	0	1	333.3	9	0.3333	300	5272	1
11ac40MIMO	5510	Type6	0	1	333.3	9	0.3333	300	5388	1
11ac40MIMO	5510	Type6	0	1	333.3	9	0.3333	300	5474	1
11ac40MIMO	5510	Type6	0	1	333.3	9	0.3333	300	5555	1
11ac40MIMO	5510	Type6	0	1	333.3	9	0.3333	300	5410	1
11ac40MIMO	5510	Type6	0	1	333.3	9	0.3333	300	5355	1
11ac40MIMO	5510	Type6	0	1	333.3	9	0.3333	300	5517	1
11ac40MIMO	5510	Type6	0	1	333.3	9	0.3333	300	5382	1
11ac40MIMO	5510	Type6	0	1	333.3	9	0.3333	300	5386	1
11ac40MIMO	5510	Type6	0	1	333.3	9	0.3333	300	5664	1
11ac40MIMO	5510	Type6	0	1	333.3	9	0.3333	300	5697	1
11ac40MIMO	5510	Type6	0	1	333.3	9	0.3333	300	5721	1
11ac40MIMO	5510	Type6	0	1	333.3	9	0.3333	300	5268	1
11ac40MIMO	5510	Type6	0	1	333.3	9	0.3333	300	5489	1
11ac40MIMO	5510	Type6	0	1	333.3	9	0.3333	300	5706	1
11ac40MIMO	5510	Type6	0	1	333.3	9	0.3333	300	5525	1
11ac20MIMO	5500	Type6	0	1	333.3	9	0.3333	300	5364	1
11ac20MIMO	5500	Type6	0	1	333.3	9	0.3333	300	5717	1
11ac20MIMO	5500	Type6	0	1	333.3	9	0.3333	300	5334	1
11ac20MIMO	5500	Type6	0	1	333.3	9	0.3333	300	5705	1
11ac20MIMO	5500	Type6	0	1	333.3	9	0.3333	300	5549	1
11ac20MIMO	5500	Type6	0	1	333.3	9	0.3333	300	5312	1
11ac20MIMO	5500	Type6	0	1	333.3	9	0.3333	300	5260	1
11ac20MIMO	5500	Type6	0	1	333.3	9	0.3333	300	5635	1



Unless otherwise agreed in writing, this document is issued by the Company subject to its General Conditions of Service printed overleaf, available on request or accessible at <http://www.sgs.com/en/Terms-and-Conditions.aspx> and, for electronic format documents, subject to Terms and Conditions for Electronic Documents at <http://www.sgs.com/en/Terms-and-Conditions/Terms-e-Documents.aspx>. Attention is drawn to the limitation of liability, indemnification and jurisdiction issues defined therein. Any holder of this document is advised that information contained herein reflects the Company's findings at the time of its intervention only and within the limits of Client's instructions, if any. The Company's sole responsibility is to its Client and this document does not exonerate parties to a transaction from exercising all their rights and obligations under the transaction documents. This document cannot be reproduced except in full, without prior written approval of the Company. Any unauthorized alteration, forgery or falsification of the content or appearance of this document is unlawful and offenders may be prosecuted to the fullest extent of the law. Unless otherwise stated the results shown in this test report refer only to the sample(s) tested and such sample(s) are retained for 30 days only.

Attention: To check the authenticity of testing/inspection report & certificate, please contact us at telephone: (86-755) 8307 1443, or email: [CN.Doccheck@sgs.com](mailto:CN.Doccheck@sgs.com)

SGS-CSTC Standards Technical Services (Xi'an) Co., Ltd. | 1/F Unit D, Building 1, Kanglong Orange Science Park, No.137, Keyuan 3rd Road, Fengyang New Town, Xi'an, Shaanxi, China | 710086 | t (86-29) 6282 7885 | www.sgs.com.cn  
 中国·西安·沣东新城科里三路137号康隆橙方科技园1号楼D单元1层 | 邮编: 710086 | t (86-29) 6282 7885 | sgs.china@sgs.com



Table with 11 columns: Item ID, Value, Type, and various test parameters. All 'Type' values are 'Type6' and all 'Value' values are '5500'. The table contains 40 rows of data.



Unless otherwise agreed in writing, this document is issued by the Company subject to its General Conditions of Service printed overleaf, available on request or accessible at <http://www.sgs.com/en/Terms-and-Conditions.aspx> and, for electronic format documents, subject to Terms and Conditions for Electronic Documents at <http://www.sgs.com/en/Terms-and-Conditions/Terms-e-Documents.aspx>. Attention is drawn to the limitation of liability, indemnification and jurisdiction issues defined therein. Any holder of this document is advised that information contained herein reflects the Company's findings at the time of its intervention only and within the limits of Client's instructions, if any. The Company's sole responsibility is to its Client and this document does not exonerate parties to a transaction from exercising all their rights and obligations under the transaction documents. This document cannot be reproduced except in full, without prior written approval of the Company. Any unauthorized alteration, forgery or falsification of the content or appearance of this document is unlawful and offenders may be prosecuted to the fullest extent of the law. Unless otherwise stated the results shown in this test report refer only to the sample(s) tested and such sample(s) are retained for 30 days only. Attention: To check the authenticity of testing/inspection report & certificate, please contact us at telephone: (86-755) 8307 1443, or email: CN.Doccheck@sgs.com

SGS-CSTC Standards Technical Services (Xi'an) Co., Ltd. | 1/F Unit D, Building 1, Kanglong Orange Science Park, No.137, Keyuan 3rd Road, Fengyang New Town, Xian, Shaanxi, China | 710086 | t (86-29) 6282 7885 | www.sgs.com.cn  
中国·西安·沣东新城科里三路137号康隆橙方科技园1号楼D单元1层 | 邮编: 710086 | t (86-29) 6282 7885 | sgs.china@sgs.com



Report No.: XEWA2310000070RG05

Rev.: 01

Page: 93 of 267

11ac20MIMO	5500	Type6	0	1	333.3	9	0.3333	300	5509	1
11ac20MIMO	5500	Type6	0	1	333.3	9	0.3333	300	5479	1
11ac20MIMO	5500	Type6	0	1	333.3	9	0.3333	300	5400	1
11ac20MIMO	5500	Type6	0	1	333.3	9	0.3333	300	5262	1
11ac20MIMO	5500	Type6	0	1	333.3	9	0.3333	300	5354	1
11ac20MIMO	5500	Type6	0	1	333.3	9	0.3333	300	5467	1
11ac20MIMO	5500	Type6	0	1	333.3	9	0.3333	300	5545	1
11ac20MIMO	5500	Type6	0	1	333.3	9	0.3333	300	5466	1
11ac20MIMO	5500	Type6	0	1	333.3	9	0.3333	300	5611	1
11ac20MIMO	5500	Type6	0	1	333.3	9	0.3333	300	5715	1
11ac20MIMO	5500	Type6	0	1	333.3	9	0.3333	300	5402	1
11ac20MIMO	5500	Type6	0	1	333.3	9	0.3333	300	5568	1
11ac20MIMO	5500	Type6	0	1	333.3	9	0.3333	300	5641	1
11ac20MIMO	5500	Type6	0	1	333.3	9	0.3333	300	5396	1
11ac20MIMO	5500	Type6	0	1	333.3	9	0.3333	300	5567	1
11ac20MIMO	5500	Type6	0	1	333.3	9	0.3333	300	5557	1
11ac20MIMO	5500	Type6	0	1	333.3	9	0.3333	300	5674	1
11ac20MIMO	5500	Type6	0	1	333.3	9	0.3333	300	5359	1
11ac20MIMO	5500	Type6	0	1	333.3	9	0.3333	300	5392	1
11ac20MIMO	5500	Type6	0	1	333.3	9	0.3333	300	5313	1
11ac20MIMO	5500	Type6	0	1	333.3	9	0.3333	300	5537	1
11ac20MIMO	5500	Type6	0	1	333.3	9	0.3333	300	5258	1
11ac20MIMO	5500	Type6	0	1	333.3	9	0.3333	300	5475	1
11ac20MIMO	5500	Type6	0	1	333.3	9	0.3333	300	5272	1
11ac20MIMO	5500	Type6	0	1	333.3	9	0.3333	300	5388	1
11ac20MIMO	5500	Type6	0	1	333.3	9	0.3333	300	5474	1
11ac20MIMO	5500	Type6	0	1	333.3	9	0.3333	300	5555	1
11ac20MIMO	5500	Type6	0	1	333.3	9	0.3333	300	5410	1
11ac20MIMO	5500	Type6	0	1	333.3	9	0.3333	300	5355	1
11ac20MIMO	5500	Type6	0	1	333.3	9	0.3333	300	5517	1
11ac20MIMO	5500	Type6	0	1	333.3	9	0.3333	300	5382	1
11ac20MIMO	5500	Type6	0	1	333.3	9	0.3333	300	5386	1
11ac20MIMO	5500	Type6	0	1	333.3	9	0.3333	300	5664	1
11ac20MIMO	5500	Type6	0	1	333.3	9	0.3333	300	5697	1
11ac20MIMO	5500	Type6	0	1	333.3	9	0.3333	300	5721	1
11ac20MIMO	5500	Type6	0	1	333.3	9	0.3333	300	5268	1
11ac20MIMO	5500	Type6	0	1	333.3	9	0.3333	300	5489	1
11ac20MIMO	5500	Type6	0	1	333.3	9	0.3333	300	5706	1
11ac20MIMO	5500	Type6	0	1	333.3	9	0.3333	300	5525	1



Unless otherwise agreed in writing, this document is issued by the Company subject to its General Conditions of Service printed overleaf, available on request or accessible at <http://www.sgs.com/en/Terms-and-Conditions.aspx> and, for electronic format documents, subject to Terms and Conditions for Electronic Documents at <http://www.sgs.com/en/Terms-and-Conditions/Terms-e-Documents.aspx>. Attention is drawn to the limitation of liability, indemnification and jurisdiction issues defined therein. Any holder of this document is advised that information contained herein reflects the Company's findings at the time of its intervention only and within the limits of Client's instructions, if any. The Company's sole responsibility is to its Client and this document does not exonerate parties to a transaction from exercising all their rights and obligations under the transaction documents. This document cannot be reproduced except in full, without prior written approval of the Company. Any unauthorized alteration, forgery or falsification of the content or appearance of this document is unlawful and offenders may be prosecuted to the fullest extent of the law. Unless otherwise stated the results shown in this test report refer only to the sample(s) tested and such sample(s) are retained for 30 days only.

Attention: To check the authenticity of testing/inspection report & certificate, please contact us at telephone: (86-755) 4307 1443, or email: CN.Doccheck@sgs.com

SGS-CSTC Standards Technical Services (Xi'an) Co., Ltd. | 1/E Unit D, Building 1, Kanglong Orange Source Park, No.137, Keyuan 3rd Road, Fengling New Town, Xi'an, Shaanxi, China | 710086 | t (86-29) 6282 7885 | www.sgs.com.cn  
 中国·西安·沣东新城科里三路137号康隆橙方科技园1号楼D单元1层 | 邮编: 710086 | t (86-29) 6282 7885 | sgs.china@sgs.com



TestMode	Channel	Radar Type	Trial ID	Pulse width (μs)	PRI (μs)	Pulses per Hop	Hop Rate (kHz)	Hop Sequence Length(ms)	Center Frequency (MHz)	Detection (1: Yes; 0: No)
11ac80MIMO	5530	Type6	1	1	333.3	9	0.3333	300	5619	1
11ac80MIMO	5530	Type6	1	1	333.3	9	0.3333	300	5578	1
11ac80MIMO	5530	Type6	1	1	333.3	9	0.3333	300	5270	1
11ac80MIMO	5530	Type6	1	1	333.3	9	0.3333	300	5294	1
11ac80MIMO	5530	Type6	1	1	333.3	9	0.3333	300	5354	1
11ac80MIMO	5530	Type6	1	1	333.3	9	0.3333	300	5660	1
11ac80MIMO	5530	Type6	1	1	333.3	9	0.3333	300	5710	1
11ac80MIMO	5530	Type6	1	1	333.3	9	0.3333	300	5666	1
11ac80MIMO	5530	Type6	1	1	333.3	9	0.3333	300	5399	1
11ac80MIMO	5530	Type6	1	1	333.3	9	0.3333	300	5656	1
11ac80MIMO	5530	Type6	1	1	333.3	9	0.3333	300	5297	1
11ac80MIMO	5530	Type6	1	1	333.3	9	0.3333	300	5333	1
11ac80MIMO	5530	Type6	1	1	333.3	9	0.3333	300	5642	1
11ac80MIMO	5530	Type6	1	1	333.3	9	0.3333	300	5609	1
11ac80MIMO	5530	Type6	1	1	333.3	9	0.3333	300	5709	1
11ac80MIMO	5530	Type6	1	1	333.3	9	0.3333	300	5668	1
11ac80MIMO	5530	Type6	1	1	333.3	9	0.3333	300	5527	1
11ac80MIMO	5530	Type6	1	1	333.3	9	0.3333	300	5647	1
11ac80MIMO	5530	Type6	1	1	333.3	9	0.3333	300	5547	1
11ac80MIMO	5530	Type6	1	1	333.3	9	0.3333	300	5284	1
11ac80MIMO	5530	Type6	1	1	333.3	9	0.3333	300	5375	1
11ac80MIMO	5530	Type6	1	1	333.3	9	0.3333	300	5395	1
11ac80MIMO	5530	Type6	1	1	333.3	9	0.3333	300	5384	1
11ac80MIMO	5530	Type6	1	1	333.3	9	0.3333	300	5444	1
11ac80MIMO	5530	Type6	1	1	333.3	9	0.3333	300	5705	1
11ac80MIMO	5530	Type6	1	1	333.3	9	0.3333	300	5584	1
11ac80MIMO	5530	Type6	1	1	333.3	9	0.3333	300	5536	1
11ac80MIMO	5530	Type6	1	1	333.3	9	0.3333	300	5480	1
11ac80MIMO	5530	Type6	1	1	333.3	9	0.3333	300	5658	1
11ac80MIMO	5530	Type6	1	1	333.3	9	0.3333	300	5453	1
11ac80MIMO	5530	Type6	1	1	333.3	9	0.3333	300	5403	1
11ac80MIMO	5530	Type6	1	1	333.3	9	0.3333	300	5576	1
11ac80MIMO	5530	Type6	1	1	333.3	9	0.3333	300	5588	1
11ac80MIMO	5530	Type6	1	1	333.3	9	0.3333	300	5641	1
11ac80MIMO	5530	Type6	1	1	333.3	9	0.3333	300	5465	1
11ac80MIMO	5530	Type6	1	1	333.3	9	0.3333	300	5674	1
11ac80MIMO	5530	Type6	1	1	333.3	9	0.3333	300	5580	1
11ac80MIMO	5530	Type6	1	1	333.3	9	0.3333	300	5623	1
11ac80MIMO	5530	Type6	1	1	333.3	9	0.3333	300	5559	1
11ac80MIMO	5530	Type6	1	1	333.3	9	0.3333	300	5627	1
11ac80MIMO	5530	Type6	1	1	333.3	9	0.3333	300	5553	1
11ac80MIMO	5530	Type6	1	1	333.3	9	0.3333	300	5704	1
11ac80MIMO	5530	Type6	1	1	333.3	9	0.3333	300	5673	1
11ac80MIMO	5530	Type6	1	1	333.3	9	0.3333	300	5633	1
11ac80MIMO	5530	Type6	1	1	333.3	9	0.3333	300	5724	1
11ac80MIMO	5530	Type6	1	1	333.3	9	0.3333	300	5373	1
11ac80MIMO	5530	Type6	1	1	333.3	9	0.3333	300	5348	1
11ac80MIMO	5530	Type6	1	1	333.3	9	0.3333	300	5331	1
11ac80MIMO	5530	Type6	1	1	333.3	9	0.3333	300	5513	1
11ac80MIMO	5530	Type6	1	1	333.3	9	0.3333	300	5637	1
11ac80MIMO	5530	Type6	1	1	333.3	9	0.3333	300	5544	1



Unless otherwise agreed in writing, this document is issued by the Company subject to its General Conditions of Service printed overleaf, available on request or accessible at <http://www.sgs.com/en/Terms-and-Conditions.aspx> and, for electronic format documents, subject to Terms and Conditions for Electronic Documents at <http://www.sgs.com/en/Terms-and-Conditions/Terms-e-Documents.aspx>. Attention is drawn to the limitation of liability, indemnification and jurisdiction issues defined therein. Any holder of this document is advised that information contained herein reflects the Company's findings at the time of its intervention only and within the limits of Client's instructions, if any. The Company's sole responsibility is to its Client and this document does not exonerate parties to a transaction from exercising all their rights and obligations under the transaction documents. This document cannot be reproduced except in full, without prior written approval of the Company. Any unauthorized alteration, forgery or falsification of the content or appearance of this document is unlawful and offenders may be prosecuted to the fullest extent of the law. Unless otherwise stated the results shown in this test report refer only to the sample(s) tested and such sample(s) are retained for 30 days only.

Attention: To check the authenticity of testing/inspection report & certificate, please contact us at telephone: (86-755) 8307 1443, or email: [CN.Doccheck@sgs.com](mailto:CN.Doccheck@sgs.com)  
 SCS-CSTC Standards Technical Services (Xi'an) Co., Ltd. | 1/F Unit D, Building 1, Kanghong Orange Science Park, No.137, Keyuan 3rd Road, Fengjing/Yue Town, Xi'an, Shaanxi, China | 710086 | t (86-29) 6282 7885 | [www.sgs.com.cn](http://www.sgs.com.cn)  
 中国·西安·沣东新城科里三路137号康鸿橙方科技园1号楼D单元1层 | 邮编: 710086 | t (86-29) 6282 7885 | [sgs.china@sgs.com](mailto:sgs.china@sgs.com)



Table with 11 columns: Sample ID, Weight, Type, and various test results. Rows include 11ac80MIMO and 11ac40MIMO series.



Unless otherwise agreed in writing, this document is issued by the Company subject to its General Conditions of Service printed overleaf, available on request or accessible at <http://www.sgs.com/en/Terms-and-Conditions.aspx> and, for electronic format documents, subject to Terms and Conditions for Electronic Documents at <http://www.sgs.com/en/Terms-and-Conditions/Terms-e-Documents.aspx>. Attention is drawn to the limitation of liability, indemnification and jurisdiction issues defined therein. Any holder of this document is advised that information contained herein reflects the Company's findings at the time of its intervention only and within the limits of Client's instructions, if any. The Company's sole responsibility is to its Client and this document does not exonerate parties to a transaction from exercising all their rights and obligations under the transaction documents. This document cannot be reproduced except in full, without prior written approval of the Company. Any unauthorized alteration, forgery or falsification of the content or appearance of this document is unlawful and offenders may be prosecuted to the fullest extent of the law. Unless otherwise stated the results shown in this test report refer only to the sample(s) tested and such sample(s) are retained for 30 days only.

Attention: To check the authenticity of testing/inspection report & certificate, please contact us at telephone: (86-755) 8307 1443, or email: [CN.Doccheck@sgs.com](mailto:CN.Doccheck@sgs.com)  
SGS-CSTC Standards Technical Services (Xi'an) Co., Ltd. | 1/F Unit D, Building 1, Kanglong Orange Science Park, No.157, Keyuan 3rd Road, Fengyang New Town, Xian, Shaanxi, China | 710086 | t (86-29) 6282 7885 | www.sgs.com.cn  
中国·西安·沣东新城科里三路157号康鸿橙方科技园1号楼D单元1层 | 邮编: 710086 | t (86-29) 6282 7885 | sgs.china@sgs.com



11ac40MIMO	5510	Type6	1	1	333.3	9	0.3333	300	5354	1
11ac40MIMO	5510	Type6	1	1	333.3	9	0.3333	300	5660	1
11ac40MIMO	5510	Type6	1	1	333.3	9	0.3333	300	5710	1
11ac40MIMO	5510	Type6	1	1	333.3	9	0.3333	300	5666	1
11ac40MIMO	5510	Type6	1	1	333.3	9	0.3333	300	5399	1
11ac40MIMO	5510	Type6	1	1	333.3	9	0.3333	300	5656	1
11ac40MIMO	5510	Type6	1	1	333.3	9	0.3333	300	5297	1
11ac40MIMO	5510	Type6	1	1	333.3	9	0.3333	300	5333	1
11ac40MIMO	5510	Type6	1	1	333.3	9	0.3333	300	5642	1
11ac40MIMO	5510	Type6	1	1	333.3	9	0.3333	300	5609	1
11ac40MIMO	5510	Type6	1	1	333.3	9	0.3333	300	5709	1
11ac40MIMO	5510	Type6	1	1	333.3	9	0.3333	300	5668	1
11ac40MIMO	5510	Type6	1	1	333.3	9	0.3333	300	5527	1
11ac40MIMO	5510	Type6	1	1	333.3	9	0.3333	300	5647	1
11ac40MIMO	5510	Type6	1	1	333.3	9	0.3333	300	5547	1
11ac40MIMO	5510	Type6	1	1	333.3	9	0.3333	300	5284	1
11ac40MIMO	5510	Type6	1	1	333.3	9	0.3333	300	5375	1
11ac40MIMO	5510	Type6	1	1	333.3	9	0.3333	300	5395	1
11ac40MIMO	5510	Type6	1	1	333.3	9	0.3333	300	5384	1
11ac40MIMO	5510	Type6	1	1	333.3	9	0.3333	300	5444	1
11ac40MIMO	5510	Type6	1	1	333.3	9	0.3333	300	5705	1
11ac40MIMO	5510	Type6	1	1	333.3	9	0.3333	300	5584	1
11ac40MIMO	5510	Type6	1	1	333.3	9	0.3333	300	5536	1
11ac40MIMO	5510	Type6	1	1	333.3	9	0.3333	300	5480	1
11ac40MIMO	5510	Type6	1	1	333.3	9	0.3333	300	5658	1
11ac40MIMO	5510	Type6	1	1	333.3	9	0.3333	300	5453	1
11ac40MIMO	5510	Type6	1	1	333.3	9	0.3333	300	5403	1
11ac40MIMO	5510	Type6	1	1	333.3	9	0.3333	300	5576	1
11ac40MIMO	5510	Type6	1	1	333.3	9	0.3333	300	5588	1
11ac40MIMO	5510	Type6	1	1	333.3	9	0.3333	300	5641	1
11ac40MIMO	5510	Type6	1	1	333.3	9	0.3333	300	5465	1
11ac40MIMO	5510	Type6	1	1	333.3	9	0.3333	300	5674	1
11ac40MIMO	5510	Type6	1	1	333.3	9	0.3333	300	5580	1
11ac40MIMO	5510	Type6	1	1	333.3	9	0.3333	300	5623	1
11ac40MIMO	5510	Type6	1	1	333.3	9	0.3333	300	5559	1
11ac40MIMO	5510	Type6	1	1	333.3	9	0.3333	300	5627	1
11ac40MIMO	5510	Type6	1	1	333.3	9	0.3333	300	5553	1
11ac40MIMO	5510	Type6	1	1	333.3	9	0.3333	300	5704	1
11ac40MIMO	5510	Type6	1	1	333.3	9	0.3333	300	5673	1
11ac40MIMO	5510	Type6	1	1	333.3	9	0.3333	300	5633	1
11ac40MIMO	5510	Type6	1	1	333.3	9	0.3333	300	5724	1
11ac40MIMO	5510	Type6	1	1	333.3	9	0.3333	300	5373	1
11ac40MIMO	5510	Type6	1	1	333.3	9	0.3333	300	5348	1
11ac40MIMO	5510	Type6	1	1	333.3	9	0.3333	300	5331	1
11ac40MIMO	5510	Type6	1	1	333.3	9	0.3333	300	5513	1
11ac40MIMO	5510	Type6	1	1	333.3	9	0.3333	300	5637	1
11ac40MIMO	5510	Type6	1	1	333.3	9	0.3333	300	5544	1
11ac40MIMO	5510	Type6	1	1	333.3	9	0.3333	300	5314	1
11ac40MIMO	5510	Type6	1	1	333.3	9	0.3333	300	5585	1
11ac40MIMO	5510	Type6	1	1	333.3	9	0.3333	300	5697	1
11ac40MIMO	5510	Type6	1	1	333.3	9	0.3333	300	5257	1
11ac40MIMO	5510	Type6	1	1	333.3	9	0.3333	300	5672	1
11ac40MIMO	5510	Type6	1	1	333.3	9	0.3333	300	5471	1



Unless otherwise agreed in writing, this document is issued by the Company subject to its General Conditions of Service printed overleaf, available on request or accessible at <http://www.sgs.com/en/Terms-and-Conditions.aspx> and, for electronic format documents, subject to Terms and Conditions for Electronic Documents at <http://www.sgs.com/en/Terms-and-Conditions/Terms-e-Documents.aspx>. Attention is drawn to the limitation of liability, indemnification and jurisdiction issues defined therein. Any holder of this document is advised that information contained herein reflects the Company's findings at the time of its intervention only and within the limits of Client's instructions, if any. The Company's sole responsibility is to its Client and this document does not exonerate parties to a transaction from exercising all their rights and obligations under the transaction documents. This document cannot be reproduced except in full, without prior written approval of the Company. Any unauthorized alteration, forgery or falsification of the content or appearance of this document is unlawful and offenders may be prosecuted to the fullest extent of the law. Unless otherwise stated the results shown in this test report refer only to the sample(s) tested and such sample(s) are retained for 30 days only.

Attention: To check the authenticity of testing/inspection report & certificate, please contact us at telephone: (86-755) 8307 1443, or email: [CN.Doccheck@sgs.com](mailto:CN.Doccheck@sgs.com)  
 (E) Unit D, Building 1, Kanglong Orange Science Park, No.157, Keyuan 3rd Road, Fengyang New Town, Xian, Shaanxi, China 710086 t (86-29) 6282 7885 www.sgs.com.cn  
 中国·西安·沣东新城科里三路157号康隆橙方科技园1号楼D单元1层 邮编: 710086 t (86-29) 6282 7885 sgs.china@sgs.com





11ac40MIMO	5510	Type6	1	1	333.3	9	0.3333	300	5423	1
11ac40MIMO	5510	Type6	1	1	333.3	9	0.3333	300	5424	1
11ac40MIMO	5510	Type6	1	1	333.3	9	0.3333	300	5638	1
11ac40MIMO	5510	Type6	1	1	333.3	9	0.3333	300	5644	1
11ac40MIMO	5510	Type6	1	1	333.3	9	0.3333	300	5345	1
11ac40MIMO	5510	Type6	1	1	333.3	9	0.3333	300	5569	1
11ac40MIMO	5510	Type6	1	1	333.3	9	0.3333	300	5655	1
11ac40MIMO	5510	Type6	1	1	333.3	9	0.3333	300	5413	1
11ac40MIMO	5510	Type6	1	1	333.3	9	0.3333	300	5271	1
11ac40MIMO	5510	Type6	1	1	333.3	9	0.3333	300	5415	1
11ac40MIMO	5510	Type6	1	1	333.3	9	0.3333	300	5550	1
11ac40MIMO	5510	Type6	1	1	333.3	9	0.3333	300	5371	1
11ac40MIMO	5510	Type6	1	1	333.3	9	0.3333	300	5335	1
11ac40MIMO	5510	Type6	1	1	333.3	9	0.3333	300	5382	1
11ac40MIMO	5510	Type6	1	1	333.3	9	0.3333	300	5416	1
11ac40MIMO	5510	Type6	1	1	333.3	9	0.3333	300	5533	1
11ac40MIMO	5510	Type6	1	1	333.3	9	0.3333	300	5706	1
11ac40MIMO	5510	Type6	1	1	333.3	9	0.3333	300	5558	1
11ac40MIMO	5510	Type6	1	1	333.3	9	0.3333	300	5535	1
11ac40MIMO	5510	Type6	1	1	333.3	9	0.3333	300	5692	1
11ac40MIMO	5510	Type6	1	1	333.3	9	0.3333	300	5256	1
11ac40MIMO	5510	Type6	1	1	333.3	9	0.3333	300	5436	1
11ac40MIMO	5510	Type6	1	1	333.3	9	0.3333	300	5716	1
11ac40MIMO	5510	Type6	1	1	333.3	9	0.3333	300	5385	1
11ac40MIMO	5510	Type6	1	1	333.3	9	0.3333	300	5669	1
11ac40MIMO	5510	Type6	1	1	333.3	9	0.3333	300	5458	1
11ac40MIMO	5510	Type6	1	1	333.3	9	0.3333	300	5349	1
11ac40MIMO	5510	Type6	1	1	333.3	9	0.3333	300	5456	1
11ac40MIMO	5510	Type6	1	1	333.3	9	0.3333	300	5336	1
11ac40MIMO	5510	Type6	1	1	333.3	9	0.3333	300	5634	1
11ac40MIMO	5510	Type6	1	1	333.3	9	0.3333	300	5703	1
11ac40MIMO	5510	Type6	1	1	333.3	9	0.3333	300	5352	1
11ac40MIMO	5510	Type6	1	1	333.3	9	0.3333	300	5280	1
11ac40MIMO	5510	Type6	1	1	333.3	9	0.3333	300	5506	1
11ac40MIMO	5510	Type6	1	1	333.3	9	0.3333	300	5313	1
11ac40MIMO	5510	Type6	1	1	333.3	9	0.3333	300	5690	1
11ac40MIMO	5510	Type6	1	1	333.3	9	0.3333	300	5326	1
11ac40MIMO	5510	Type6	1	1	333.3	9	0.3333	300	5631	1
11ac40MIMO	5510	Type6	1	1	333.3	9	0.3333	300	5628	1
11ac40MIMO	5510	Type6	1	1	333.3	9	0.3333	300	5546	1
11ac40MIMO	5510	Type6	1	1	333.3	9	0.3333	300	5289	1
11ac40MIMO	5510	Type6	1	1	333.3	9	0.3333	300	5490	1
11ac40MIMO	5510	Type6	1	1	333.3	9	0.3333	300	5590	1
11ac20MIMO	5500	Type6	1	1	333.3	9	0.3333	300	5619	1
11ac20MIMO	5500	Type6	1	1	333.3	9	0.3333	300	5578	1
11ac20MIMO	5500	Type6	1	1	333.3	9	0.3333	300	5270	1
11ac20MIMO	5500	Type6	1	1	333.3	9	0.3333	300	5294	1
11ac20MIMO	5500	Type6	1	1	333.3	9	0.3333	300	5354	1
11ac20MIMO	5500	Type6	1	1	333.3	9	0.3333	300	5660	1
11ac20MIMO	5500	Type6	1	1	333.3	9	0.3333	300	5710	1
11ac20MIMO	5500	Type6	1	1	333.3	9	0.3333	300	5666	1
11ac20MIMO	5500	Type6	1	1	333.3	9	0.3333	300	5399	1
11ac20MIMO	5500	Type6	1	1	333.3	9	0.3333	300	5656	1



Unless otherwise agreed in writing, this document is issued by the Company subject to its General Conditions of Service printed overleaf, available on request or accessible at <http://www.sgs.com/en/Terms-and-Conditions.aspx> and, for electronic format documents, subject to Terms and Conditions for Electronic Documents at <http://www.sgs.com/en/Terms-and-Conditions/Terms-e-Documents.aspx>. Attention is drawn to the limitation of liability, indemnification and jurisdiction issues defined therein. Any holder of this document is advised that information contained herein reflects the Company's findings at the time of its intervention only and within the limits of Client's instructions, if any. The Company's sole responsibility is to its Client and this document does not exonerate parties to a transaction from exercising all their rights and obligations under the transaction documents. This document cannot be reproduced except in full, without prior written approval of the Company. Any unauthorized alteration, forgery or falsification of the content or appearance of this document is unlawful and offenders may be prosecuted to the fullest extent of the law. Unless otherwise stated the results shown in this test report refer only to the sample(s) tested and such sample(s) are retained for 30 days only.

Attention: To check the authenticity of testing/inspection report & certificate, please contact us at telephone: (86-755) 8307 1443, or email: [CN.Doccheck@sgs.com](mailto:CN.Doccheck@sgs.com)

SGS-CSTC Standards Technical Services (Xi'an) Co., Ltd. | 1/F, Unit D, Building 1, Kanglong Orange Science Park, No.137, Keyuan3rd Road, Fengyang New Town, Xi'an, Shaanxi, China | 710086 | t: (86-29) 6282 7885 | www.sgs.com.cn  
 中国·西安·沣东新城科里三路137号康隆橙方科技园1号楼D单元1层 | 邮编: 710086 | t: (86-29) 6282 7885 | sgs.china@sgs.com

11ac20MIMO	5500	Type6	1	1	333.3	9	0.3333	300	5297	1
11ac20MIMO	5500	Type6	1	1	333.3	9	0.3333	300	5333	1
11ac20MIMO	5500	Type6	1	1	333.3	9	0.3333	300	5642	1
11ac20MIMO	5500	Type6	1	1	333.3	9	0.3333	300	5609	1
11ac20MIMO	5500	Type6	1	1	333.3	9	0.3333	300	5709	1
11ac20MIMO	5500	Type6	1	1	333.3	9	0.3333	300	5668	1
11ac20MIMO	5500	Type6	1	1	333.3	9	0.3333	300	5527	1
11ac20MIMO	5500	Type6	1	1	333.3	9	0.3333	300	5647	1
11ac20MIMO	5500	Type6	1	1	333.3	9	0.3333	300	5547	1
11ac20MIMO	5500	Type6	1	1	333.3	9	0.3333	300	5284	1
11ac20MIMO	5500	Type6	1	1	333.3	9	0.3333	300	5375	1
11ac20MIMO	5500	Type6	1	1	333.3	9	0.3333	300	5395	1
11ac20MIMO	5500	Type6	1	1	333.3	9	0.3333	300	5384	1
11ac20MIMO	5500	Type6	1	1	333.3	9	0.3333	300	5444	1
11ac20MIMO	5500	Type6	1	1	333.3	9	0.3333	300	5705	1
11ac20MIMO	5500	Type6	1	1	333.3	9	0.3333	300	5584	1
11ac20MIMO	5500	Type6	1	1	333.3	9	0.3333	300	5536	1
11ac20MIMO	5500	Type6	1	1	333.3	9	0.3333	300	5480	1
11ac20MIMO	5500	Type6	1	1	333.3	9	0.3333	300	5658	1
11ac20MIMO	5500	Type6	1	1	333.3	9	0.3333	300	5453	1
11ac20MIMO	5500	Type6	1	1	333.3	9	0.3333	300	5403	1
11ac20MIMO	5500	Type6	1	1	333.3	9	0.3333	300	5576	1
11ac20MIMO	5500	Type6	1	1	333.3	9	0.3333	300	5588	1
11ac20MIMO	5500	Type6	1	1	333.3	9	0.3333	300	5641	1
11ac20MIMO	5500	Type6	1	1	333.3	9	0.3333	300	5465	1
11ac20MIMO	5500	Type6	1	1	333.3	9	0.3333	300	5674	1
11ac20MIMO	5500	Type6	1	1	333.3	9	0.3333	300	5580	1
11ac20MIMO	5500	Type6	1	1	333.3	9	0.3333	300	5623	1
11ac20MIMO	5500	Type6	1	1	333.3	9	0.3333	300	5559	1
11ac20MIMO	5500	Type6	1	1	333.3	9	0.3333	300	5627	1
11ac20MIMO	5500	Type6	1	1	333.3	9	0.3333	300	5553	1
11ac20MIMO	5500	Type6	1	1	333.3	9	0.3333	300	5704	1
11ac20MIMO	5500	Type6	1	1	333.3	9	0.3333	300	5673	1
11ac20MIMO	5500	Type6	1	1	333.3	9	0.3333	300	5633	1
11ac20MIMO	5500	Type6	1	1	333.3	9	0.3333	300	5724	1
11ac20MIMO	5500	Type6	1	1	333.3	9	0.3333	300	5373	1
11ac20MIMO	5500	Type6	1	1	333.3	9	0.3333	300	5348	1
11ac20MIMO	5500	Type6	1	1	333.3	9	0.3333	300	5331	1
11ac20MIMO	5500	Type6	1	1	333.3	9	0.3333	300	5513	1
11ac20MIMO	5500	Type6	1	1	333.3	9	0.3333	300	5637	1
11ac20MIMO	5500	Type6	1	1	333.3	9	0.3333	300	5544	1
11ac20MIMO	5500	Type6	1	1	333.3	9	0.3333	300	5314	1
11ac20MIMO	5500	Type6	1	1	333.3	9	0.3333	300	5585	1
11ac20MIMO	5500	Type6	1	1	333.3	9	0.3333	300	5697	1
11ac20MIMO	5500	Type6	1	1	333.3	9	0.3333	300	5257	1
11ac20MIMO	5500	Type6	1	1	333.3	9	0.3333	300	5672	1
11ac20MIMO	5500	Type6	1	1	333.3	9	0.3333	300	5471	1
11ac20MIMO	5500	Type6	1	1	333.3	9	0.3333	300	5423	1
11ac20MIMO	5500	Type6	1	1	333.3	9	0.3333	300	5424	1
11ac20MIMO	5500	Type6	1	1	333.3	9	0.3333	300	5638	1
11ac20MIMO	5500	Type6	1	1	333.3	9	0.3333	300	5644	1
11ac20MIMO	5500	Type6	1	1	333.3	9	0.3333	300	5345	1
11ac20MIMO	5500	Type6	1	1	333.3	9	0.3333	300	5569	1



Unless otherwise agreed in writing, this document is issued by the Company subject to its General Conditions of Service printed overleaf, available on request or accessible at <http://www.sgs.com/en/Terms-and-Conditions.aspx> and, for electronic format documents, subject to Terms and Conditions for Electronic Documents at <http://www.sgs.com/en/Terms-and-Conditions/Terms-e-Documents.aspx>. Attention is drawn to the limitation of liability, indemnification and jurisdiction issues defined therein. Any holder of this document is advised that information contained herein reflects the Company's findings at the time of its intervention only and within the limits of Client's instructions, if any. The Company's sole responsibility is to its Client and this document does not exonerate parties to a transaction from exercising all their rights and obligations under the transaction documents. This document cannot be reproduced except in full, without prior written approval of the Company. Any unauthorized alteration, forgery or falsification of the content or appearance of this document is unlawful and offenders may be prosecuted to the fullest extent of the law. Unless otherwise stated the results shown in this test report refer only to the sample(s) tested and such sample(s) are retained for 30 days only.

Attention: To check the authenticity of testing/inspection report & certificate, please contact us at telephone: (86-755) 8307 1443, or email: [CN.Doccheck@sgs.com](mailto:CN.Doccheck@sgs.com)

SGS-CSTC Standards Technical Services (Xi'an) Co., Ltd. | 1/F Unit D, Building 1, Kanglong Orange Science Park, No.157, Keyuan 3rd Road, Fengyang New Town, Xi'an, Shaanxi, China | 710086 | t (86-29) 6282 7885 | www.sgs.com.cn  
 中国·西安·沣东新城科里三路157号康隆橙方科技园1号楼D单元1层 | 邮编: 710086 | t (86-29) 6282 7885 | sgs.china@sgs.com

11ac20MIMO	5500	Type6	1	1	333.3	9	0.3333	300	5655	1
11ac20MIMO	5500	Type6	1	1	333.3	9	0.3333	300	5413	1
11ac20MIMO	5500	Type6	1	1	333.3	9	0.3333	300	5271	1
11ac20MIMO	5500	Type6	1	1	333.3	9	0.3333	300	5415	1
11ac20MIMO	5500	Type6	1	1	333.3	9	0.3333	300	5550	1
11ac20MIMO	5500	Type6	1	1	333.3	9	0.3333	300	5371	1
11ac20MIMO	5500	Type6	1	1	333.3	9	0.3333	300	5335	1
11ac20MIMO	5500	Type6	1	1	333.3	9	0.3333	300	5382	1
11ac20MIMO	5500	Type6	1	1	333.3	9	0.3333	300	5416	1
11ac20MIMO	5500	Type6	1	1	333.3	9	0.3333	300	5533	1
11ac20MIMO	5500	Type6	1	1	333.3	9	0.3333	300	5706	1
11ac20MIMO	5500	Type6	1	1	333.3	9	0.3333	300	5558	1
11ac20MIMO	5500	Type6	1	1	333.3	9	0.3333	300	5535	1
11ac20MIMO	5500	Type6	1	1	333.3	9	0.3333	300	5692	1
11ac20MIMO	5500	Type6	1	1	333.3	9	0.3333	300	5256	1
11ac20MIMO	5500	Type6	1	1	333.3	9	0.3333	300	5436	1
11ac20MIMO	5500	Type6	1	1	333.3	9	0.3333	300	5716	1
11ac20MIMO	5500	Type6	1	1	333.3	9	0.3333	300	5385	1
11ac20MIMO	5500	Type6	1	1	333.3	9	0.3333	300	5669	1
11ac20MIMO	5500	Type6	1	1	333.3	9	0.3333	300	5458	1
11ac20MIMO	5500	Type6	1	1	333.3	9	0.3333	300	5349	1
11ac20MIMO	5500	Type6	1	1	333.3	9	0.3333	300	5456	1
11ac20MIMO	5500	Type6	1	1	333.3	9	0.3333	300	5336	1
11ac20MIMO	5500	Type6	1	1	333.3	9	0.3333	300	5634	1
11ac20MIMO	5500	Type6	1	1	333.3	9	0.3333	300	5703	1
11ac20MIMO	5500	Type6	1	1	333.3	9	0.3333	300	5352	1
11ac20MIMO	5500	Type6	1	1	333.3	9	0.3333	300	5280	1
11ac20MIMO	5500	Type6	1	1	333.3	9	0.3333	300	5506	1
11ac20MIMO	5500	Type6	1	1	333.3	9	0.3333	300	5313	1
11ac20MIMO	5500	Type6	1	1	333.3	9	0.3333	300	5690	1
11ac20MIMO	5500	Type6	1	1	333.3	9	0.3333	300	5326	1
11ac20MIMO	5500	Type6	1	1	333.3	9	0.3333	300	5631	1
11ac20MIMO	5500	Type6	1	1	333.3	9	0.3333	300	5628	1
11ac20MIMO	5500	Type6	1	1	333.3	9	0.3333	300	5546	1
11ac20MIMO	5500	Type6	1	1	333.3	9	0.3333	300	5289	1
11ac20MIMO	5500	Type6	1	1	333.3	9	0.3333	300	5490	1
11ac20MIMO	5500	Type6	1	1	333.3	9	0.3333	300	5590	1



Unless otherwise agreed in writing, this document is issued by the Company subject to its General Conditions of Service printed overleaf, available on request or accessible at <http://www.sgs.com/en/Terms-and-Conditions.aspx> and, for electronic format documents, subject to Terms and Conditions for Electronic Documents at <http://www.sgs.com/en/Terms-and-Conditions/Terms-e-Documents.aspx>. Attention is drawn to the limitation of liability, indemnification and jurisdiction issues defined therein. Any holder of this document is advised that information contained herein reflects the Company's findings at the time of its intervention only and within the limits of Client's instructions, if any. The Company's sole responsibility is to its Client and this document does not exonerate parties to a transaction from exercising all their rights and obligations under the transaction documents. This document cannot be reproduced except in full, without prior written approval of the Company. Any unauthorized alteration, forgery or falsification of the content or appearance of this document is unlawful and offenders may be prosecuted to the fullest extent of the law. Unless otherwise stated the results shown in this test report refer only to the sample(s) tested and such sample(s) are retained for 30 days only.

Attention: To check the authenticity of testing/inspection report & certificate, please contact us at telephone: (86-755) 4307 1443, or email: CN\_Doccheck@sgs.com

TestMode	Channel	Radar Type	Trial ID	Pulse width (μs)	PRI (μs)	Pulses per Hop	Hop Rate (kHz)	Hop Sequence Length(ms)	Center Frequency (MHz)	Detection (1: Yes; 0: No)
11ac80MIMO	5530	Type6	2	1	333.3	9	0.3333	300	5302	1
11ac80MIMO	5530	Type6	2	1	333.3	9	0.3333	300	5342	1
11ac80MIMO	5530	Type6	2	1	333.3	9	0.3333	300	5681	1
11ac80MIMO	5530	Type6	2	1	333.3	9	0.3333	300	5455	1
11ac80MIMO	5530	Type6	2	1	333.3	9	0.3333	300	5611	1
11ac80MIMO	5530	Type6	2	1	333.3	9	0.3333	300	5493	1
11ac80MIMO	5530	Type6	2	1	333.3	9	0.3333	300	5682	1
11ac80MIMO	5530	Type6	2	1	333.3	9	0.3333	300	5310	1
11ac80MIMO	5530	Type6	2	1	333.3	9	0.3333	300	5257	1
11ac80MIMO	5530	Type6	2	1	333.3	9	0.3333	300	5606	1
11ac80MIMO	5530	Type6	2	1	333.3	9	0.3333	300	5587	1
11ac80MIMO	5530	Type6	2	1	333.3	9	0.3333	300	5561	1
11ac80MIMO	5530	Type6	2	1	333.3	9	0.3333	300	5374	1
11ac80MIMO	5530	Type6	2	1	333.3	9	0.3333	300	5362	1
11ac80MIMO	5530	Type6	2	1	333.3	9	0.3333	300	5630	1
11ac80MIMO	5530	Type6	2	1	333.3	9	0.3333	300	5322	1
11ac80MIMO	5530	Type6	2	1	333.3	9	0.3333	300	5320	1
11ac80MIMO	5530	Type6	2	1	333.3	9	0.3333	300	5502	1
11ac80MIMO	5530	Type6	2	1	333.3	9	0.3333	300	5475	1
11ac80MIMO	5530	Type6	2	1	333.3	9	0.3333	300	5364	1
11ac80MIMO	5530	Type6	2	1	333.3	9	0.3333	300	5555	1
11ac80MIMO	5530	Type6	2	1	333.3	9	0.3333	300	5353	1
11ac80MIMO	5530	Type6	2	1	333.3	9	0.3333	300	5316	1
11ac80MIMO	5530	Type6	2	1	333.3	9	0.3333	300	5387	1
11ac80MIMO	5530	Type6	2	1	333.3	9	0.3333	300	5357	1
11ac80MIMO	5530	Type6	2	1	333.3	9	0.3333	300	5332	1
11ac80MIMO	5530	Type6	2	1	333.3	9	0.3333	300	5654	1
11ac80MIMO	5530	Type6	2	1	333.3	9	0.3333	300	5312	1
11ac80MIMO	5530	Type6	2	1	333.3	9	0.3333	300	5262	1
11ac80MIMO	5530	Type6	2	1	333.3	9	0.3333	300	5409	1
11ac80MIMO	5530	Type6	2	1	333.3	9	0.3333	300	5522	1
11ac80MIMO	5530	Type6	2	1	333.3	9	0.3333	300	5547	1
11ac80MIMO	5530	Type6	2	1	333.3	9	0.3333	300	5410	1
11ac80MIMO	5530	Type6	2	1	333.3	9	0.3333	300	5618	1
11ac80MIMO	5530	Type6	2	1	333.3	9	0.3333	300	5253	1
11ac80MIMO	5530	Type6	2	1	333.3	9	0.3333	300	5311	1
11ac80MIMO	5530	Type6	2	1	333.3	9	0.3333	300	5683	1
11ac80MIMO	5530	Type6	2	1	333.3	9	0.3333	300	5556	1
11ac80MIMO	5530	Type6	2	1	333.3	9	0.3333	300	5470	1
11ac80MIMO	5530	Type6	2	1	333.3	9	0.3333	300	5258	1
11ac80MIMO	5530	Type6	2	1	333.3	9	0.3333	300	5537	1
11ac80MIMO	5530	Type6	2	1	333.3	9	0.3333	300	5398	1
11ac80MIMO	5530	Type6	2	1	333.3	9	0.3333	300	5710	1
11ac80MIMO	5530	Type6	2	1	333.3	9	0.3333	300	5491	1
11ac80MIMO	5530	Type6	2	1	333.3	9	0.3333	300	5469	1
11ac80MIMO	5530	Type6	2	1	333.3	9	0.3333	300	5670	1
11ac80MIMO	5530	Type6	2	1	333.3	9	0.3333	300	5465	1
11ac80MIMO	5530	Type6	2	1	333.3	9	0.3333	300	5704	1
11ac80MIMO	5530	Type6	2	1	333.3	9	0.3333	300	5456	1
11ac80MIMO	5530	Type6	2	1	333.3	9	0.3333	300	5406	1
11ac80MIMO	5530	Type6	2	1	333.3	9	0.3333	300	5384	1



Unless otherwise agreed in writing, this document is issued by the Company subject to its General Conditions of Service printed overleaf, available on request or accessible at <http://www.sgs.com/en/Terms-and-Conditions.aspx> and, for electronic format documents, subject to Terms and Conditions for Electronic Documents at <http://www.sgs.com/en/Terms-and-Conditions/Terms-e-Documents.aspx>. Attention is drawn to the limitation of liability, indemnification and jurisdiction issues defined therein. Any holder of this document is advised that information contained herein reflects the Company's findings at the time of its intervention only and within the limits of Client's instructions, if any. The Company's sole responsibility is to its Client and this document does not exonerate parties to a transaction from exercising all their rights and obligations under the transaction documents. This document cannot be reproduced except in full, without prior written approval of the Company. Any unauthorized alteration, forgery or falsification of the content or appearance of this document is unlawful and offenders may be prosecuted to the fullest extent of the law. Unless otherwise stated the results shown in this test report refer only to the sample(s) tested and such sample(s) are retained for 30 days only.

Attention: To check the authenticity of testing/inspection report & certificate, please contact us at telephone: (86-755) 8307 1443, or email: [CN.Doccheck@sgs.com](mailto:CN.Doccheck@sgs.com)  
 1/E Unit D, Building 1, Kanglong Orange Science Park, No.157, Keyuan 3rd Road, Fengjing/Yue Tian, Xian, Shaanxi, China 710086 t (86-29) 6282 7885 www.sgs.com.cn  
 中国·西安·沣东新城科里三路157号康隆橙方科技园1号楼D单元1层 邮编: 710086 t (86-29) 6282 7885 sgs.china@sgs.com

11ac80MIMO	5530	Type6	2	1	333.3	9	0.3333	300	5400	1
11ac80MIMO	5530	Type6	2	1	333.3	9	0.3333	300	5513	1
11ac80MIMO	5530	Type6	2	1	333.3	9	0.3333	300	5720	1
11ac80MIMO	5530	Type6	2	1	333.3	9	0.3333	300	5365	1
11ac80MIMO	5530	Type6	2	1	333.3	9	0.3333	300	5296	1
11ac80MIMO	5530	Type6	2	1	333.3	9	0.3333	300	5276	1
11ac80MIMO	5530	Type6	2	1	333.3	9	0.3333	300	5641	1
11ac80MIMO	5530	Type6	2	1	333.3	9	0.3333	300	5445	1
11ac80MIMO	5530	Type6	2	1	333.3	9	0.3333	300	5626	1
11ac80MIMO	5530	Type6	2	1	333.3	9	0.3333	300	5564	1
11ac80MIMO	5530	Type6	2	1	333.3	9	0.3333	300	5620	1
11ac80MIMO	5530	Type6	2	1	333.3	9	0.3333	300	5395	1
11ac80MIMO	5530	Type6	2	1	333.3	9	0.3333	300	5334	1
11ac80MIMO	5530	Type6	2	1	333.3	9	0.3333	300	5290	1
11ac80MIMO	5530	Type6	2	1	333.3	9	0.3333	300	5401	1
11ac80MIMO	5530	Type6	2	1	333.3	9	0.3333	300	5578	1
11ac80MIMO	5530	Type6	2	1	333.3	9	0.3333	300	5359	1
11ac80MIMO	5530	Type6	2	1	333.3	9	0.3333	300	5569	1
11ac80MIMO	5530	Type6	2	1	333.3	9	0.3333	300	5586	1
11ac80MIMO	5530	Type6	2	1	333.3	9	0.3333	300	5282	1
11ac80MIMO	5530	Type6	2	1	333.3	9	0.3333	300	5649	1
11ac80MIMO	5530	Type6	2	1	333.3	9	0.3333	300	5407	1
11ac80MIMO	5530	Type6	2	1	333.3	9	0.3333	300	5368	1
11ac80MIMO	5530	Type6	2	1	333.3	9	0.3333	300	5647	1
11ac80MIMO	5530	Type6	2	1	333.3	9	0.3333	300	5643	1
11ac80MIMO	5530	Type6	2	1	333.3	9	0.3333	300	5509	1
11ac80MIMO	5530	Type6	2	1	333.3	9	0.3333	300	5592	1
11ac80MIMO	5530	Type6	2	1	333.3	9	0.3333	300	5675	1
11ac80MIMO	5530	Type6	2	1	333.3	9	0.3333	300	5678	1
11ac80MIMO	5530	Type6	2	1	333.3	9	0.3333	300	5581	1
11ac80MIMO	5530	Type6	2	1	333.3	9	0.3333	300	5275	1
11ac80MIMO	5530	Type6	2	1	333.3	9	0.3333	300	5381	1
11ac80MIMO	5530	Type6	2	1	333.3	9	0.3333	300	5512	1
11ac80MIMO	5530	Type6	2	1	333.3	9	0.3333	300	5600	1
11ac80MIMO	5530	Type6	2	1	333.3	9	0.3333	300	5304	1
11ac80MIMO	5530	Type6	2	1	333.3	9	0.3333	300	5382	1
11ac80MIMO	5530	Type6	2	1	333.3	9	0.3333	300	5389	1
11ac80MIMO	5530	Type6	2	1	333.3	9	0.3333	300	5458	1
11ac80MIMO	5530	Type6	2	1	333.3	9	0.3333	300	5666	1
11ac80MIMO	5530	Type6	2	1	333.3	9	0.3333	300	5419	1
11ac80MIMO	5530	Type6	2	1	333.3	9	0.3333	300	5642	1
11ac80MIMO	5530	Type6	2	1	333.3	9	0.3333	300	5350	1
11ac80MIMO	5530	Type6	2	1	333.3	9	0.3333	300	5526	1
11ac80MIMO	5530	Type6	2	1	333.3	9	0.3333	300	5519	1
11ac80MIMO	5530	Type6	2	1	333.3	9	0.3333	300	5709	1
11ac80MIMO	5530	Type6	2	1	333.3	9	0.3333	300	5692	1
11ac80MIMO	5530	Type6	2	1	333.3	9	0.3333	300	5418	1
11ac80MIMO	5530	Type6	2	1	333.3	9	0.3333	300	5653	1
11ac80MIMO	5530	Type6	2	1	333.3	9	0.3333	300	5354	1
11ac40MIMO	5510	Type6	2	1	333.3	9	0.3333	300	5302	1
11ac40MIMO	5510	Type6	2	1	333.3	9	0.3333	300	5342	1
11ac40MIMO	5510	Type6	2	1	333.3	9	0.3333	300	5681	1
11ac40MIMO	5510	Type6	2	1	333.3	9	0.3333	300	5455	1



Unless otherwise agreed in writing, this document is issued by the Company subject to its General Conditions of Service printed overleaf, available on request or accessible at <http://www.sgs.com/en/Terms-and-Conditions.aspx> and, for electronic format documents, subject to Terms and Conditions for Electronic Documents at <http://www.sgs.com/en/Terms-and-Conditions/Terms-e-Documents.aspx>. Attention is drawn to the limitation of liability, indemnification and jurisdiction issues defined therein. Any holder of this document is advised that information contained herein reflects the Company's findings at the time of its intervention only and within the limits of Client's instructions, if any. The Company's sole responsibility is to its Client and this document does not exonerate parties to a transaction from exercising all their rights and obligations under the transaction documents. This document cannot be reproduced except in full, without prior written approval of the Company. Any unauthorized alteration, forgery or falsification of the content or appearance of this document is unlawful and offenders may be prosecuted to the fullest extent of the law. Unless otherwise stated the results shown in this test report refer only to the sample(s) tested and such sample(s) are retained for 30 days only.

Attention: To check the authenticity of testing/inspection report & certificate, please contact us at telephone: (86-755) 8307 1443, or email: [CN.Doccheck@sgs.com](mailto:CN.Doccheck@sgs.com)

SGS-CSTC Standards Technical Services (Xi'an) Co., Ltd. | 1F, Unit D, Building 1, Kanglong Orange Science Park, No.157, Keyuan 3rd Road, Fengyang New Town, Xian, Shaanxi, China | 710086 | t: (86-29) 6282 7885 | [www.sgs.com.cn](http://www.sgs.com.cn)  
 中国·西安·沣东新城科里三路157号康隆橙方科技园1号楼D单元1层 | 邮编: 710086 | t: (86-29) 6282 7885 | [sgs.china@sgs.com](mailto:sgs.china@sgs.com)



11ac40MIMO	5510	Type6	2	1	333.3	9	0.3333	300	5611	1
11ac40MIMO	5510	Type6	2	1	333.3	9	0.3333	300	5493	1
11ac40MIMO	5510	Type6	2	1	333.3	9	0.3333	300	5682	1
11ac40MIMO	5510	Type6	2	1	333.3	9	0.3333	300	5310	1
11ac40MIMO	5510	Type6	2	1	333.3	9	0.3333	300	5257	1
11ac40MIMO	5510	Type6	2	1	333.3	9	0.3333	300	5606	1
11ac40MIMO	5510	Type6	2	1	333.3	9	0.3333	300	5587	1
11ac40MIMO	5510	Type6	2	1	333.3	9	0.3333	300	5561	1
11ac40MIMO	5510	Type6	2	1	333.3	9	0.3333	300	5374	1
11ac40MIMO	5510	Type6	2	1	333.3	9	0.3333	300	5362	1
11ac40MIMO	5510	Type6	2	1	333.3	9	0.3333	300	5630	1
11ac40MIMO	5510	Type6	2	1	333.3	9	0.3333	300	5322	1
11ac40MIMO	5510	Type6	2	1	333.3	9	0.3333	300	5320	1
11ac40MIMO	5510	Type6	2	1	333.3	9	0.3333	300	5502	1
11ac40MIMO	5510	Type6	2	1	333.3	9	0.3333	300	5475	1
11ac40MIMO	5510	Type6	2	1	333.3	9	0.3333	300	5364	1
11ac40MIMO	5510	Type6	2	1	333.3	9	0.3333	300	5555	1
11ac40MIMO	5510	Type6	2	1	333.3	9	0.3333	300	5353	1
11ac40MIMO	5510	Type6	2	1	333.3	9	0.3333	300	5316	1
11ac40MIMO	5510	Type6	2	1	333.3	9	0.3333	300	5387	1
11ac40MIMO	5510	Type6	2	1	333.3	9	0.3333	300	5357	1
11ac40MIMO	5510	Type6	2	1	333.3	9	0.3333	300	5332	1
11ac40MIMO	5510	Type6	2	1	333.3	9	0.3333	300	5654	1
11ac40MIMO	5510	Type6	2	1	333.3	9	0.3333	300	5312	1
11ac40MIMO	5510	Type6	2	1	333.3	9	0.3333	300	5262	1
11ac40MIMO	5510	Type6	2	1	333.3	9	0.3333	300	5409	1
11ac40MIMO	5510	Type6	2	1	333.3	9	0.3333	300	5522	1
11ac40MIMO	5510	Type6	2	1	333.3	9	0.3333	300	5547	1
11ac40MIMO	5510	Type6	2	1	333.3	9	0.3333	300	5410	1
11ac40MIMO	5510	Type6	2	1	333.3	9	0.3333	300	5618	1
11ac40MIMO	5510	Type6	2	1	333.3	9	0.3333	300	5253	1
11ac40MIMO	5510	Type6	2	1	333.3	9	0.3333	300	5311	1
11ac40MIMO	5510	Type6	2	1	333.3	9	0.3333	300	5683	1
11ac40MIMO	5510	Type6	2	1	333.3	9	0.3333	300	5556	1
11ac40MIMO	5510	Type6	2	1	333.3	9	0.3333	300	5470	1
11ac40MIMO	5510	Type6	2	1	333.3	9	0.3333	300	5258	1
11ac40MIMO	5510	Type6	2	1	333.3	9	0.3333	300	5537	1
11ac40MIMO	5510	Type6	2	1	333.3	9	0.3333	300	5398	1
11ac40MIMO	5510	Type6	2	1	333.3	9	0.3333	300	5710	1
11ac40MIMO	5510	Type6	2	1	333.3	9	0.3333	300	5491	1
11ac40MIMO	5510	Type6	2	1	333.3	9	0.3333	300	5469	1
11ac40MIMO	5510	Type6	2	1	333.3	9	0.3333	300	5670	1
11ac40MIMO	5510	Type6	2	1	333.3	9	0.3333	300	5465	1
11ac40MIMO	5510	Type6	2	1	333.3	9	0.3333	300	5704	1
11ac40MIMO	5510	Type6	2	1	333.3	9	0.3333	300	5456	1
11ac40MIMO	5510	Type6	2	1	333.3	9	0.3333	300	5406	1
11ac40MIMO	5510	Type6	2	1	333.3	9	0.3333	300	5384	1
11ac40MIMO	5510	Type6	2	1	333.3	9	0.3333	300	5400	1
11ac40MIMO	5510	Type6	2	1	333.3	9	0.3333	300	5513	1
11ac40MIMO	5510	Type6	2	1	333.3	9	0.3333	300	5720	1
11ac40MIMO	5510	Type6	2	1	333.3	9	0.3333	300	5365	1
11ac40MIMO	5510	Type6	2	1	333.3	9	0.3333	300	5296	1
11ac40MIMO	5510	Type6	2	1	333.3	9	0.3333	300	5276	1



Unless otherwise agreed in writing, this document is issued by the Company subject to its General Conditions of Service printed overleaf, available on request or accessible at <http://www.sgs.com/en/Terms-and-Conditions.aspx> and, for electronic format documents, subject to Terms and Conditions for Electronic Documents at <http://www.sgs.com/en/Terms-and-Conditions/Terms-e-Documents.aspx>. Attention is drawn to the limitation of liability, indemnification and jurisdiction issues defined therein. Any holder of this document is advised that information contained herein reflects the Company's findings at the time of its intervention only and within the limits of Client's instructions, if any. The Company's sole responsibility is to its Client and this document does not exonerate parties to a transaction from exercising all their rights and obligations under the transaction documents. This document cannot be reproduced except in full, without prior written approval of the Company. Any unauthorized alteration, forgery or falsification of the content or appearance of this document is unlawful and offenders may be prosecuted to the fullest extent of the law. Unless otherwise stated the results shown in this test report refer only to the sample(s) tested and such sample(s) are retained for 30 days only.

Attention: To check the authenticity of testing/inspection report & certificate, please contact us at telephone: (86-755) 8307 1443, or email: [CN.Doccheck@sgs.com](mailto:CN.Doccheck@sgs.com)

SGS-CSTC Standards Technical Services (Xi'an) Co., Ltd. | 1/F Unit D, Building 1, Kanglong Orange Science Park, No.137, Keyuan 3rd Road, Fengyang New Town, Xi'an, Shaanxi, China | 710086 | T (86-29) 6282 7885 | [www.sgs.com](http://www.sgs.com)  
 中国·西安·沣东新城科里三路137号康隆橙方科技园1号楼D单元1层 | 邮编: 710086 | T (86-29) 6282 7885 | [sgs.china@sgs.com](mailto:sgs.china@sgs.com)

11ac40MIMO	5510	Type6	2	1	333.3	9	0.3333	300	5641	1
11ac40MIMO	5510	Type6	2	1	333.3	9	0.3333	300	5445	1
11ac40MIMO	5510	Type6	2	1	333.3	9	0.3333	300	5626	1
11ac40MIMO	5510	Type6	2	1	333.3	9	0.3333	300	5564	1
11ac40MIMO	5510	Type6	2	1	333.3	9	0.3333	300	5620	1
11ac40MIMO	5510	Type6	2	1	333.3	9	0.3333	300	5395	1
11ac40MIMO	5510	Type6	2	1	333.3	9	0.3333	300	5334	1
11ac40MIMO	5510	Type6	2	1	333.3	9	0.3333	300	5290	1
11ac40MIMO	5510	Type6	2	1	333.3	9	0.3333	300	5401	1
11ac40MIMO	5510	Type6	2	1	333.3	9	0.3333	300	5578	1
11ac40MIMO	5510	Type6	2	1	333.3	9	0.3333	300	5359	1
11ac40MIMO	5510	Type6	2	1	333.3	9	0.3333	300	5569	1
11ac40MIMO	5510	Type6	2	1	333.3	9	0.3333	300	5586	1
11ac40MIMO	5510	Type6	2	1	333.3	9	0.3333	300	5282	1
11ac40MIMO	5510	Type6	2	1	333.3	9	0.3333	300	5649	1
11ac40MIMO	5510	Type6	2	1	333.3	9	0.3333	300	5407	1
11ac40MIMO	5510	Type6	2	1	333.3	9	0.3333	300	5368	1
11ac40MIMO	5510	Type6	2	1	333.3	9	0.3333	300	5647	1
11ac40MIMO	5510	Type6	2	1	333.3	9	0.3333	300	5643	1
11ac40MIMO	5510	Type6	2	1	333.3	9	0.3333	300	5509	1
11ac40MIMO	5510	Type6	2	1	333.3	9	0.3333	300	5592	1
11ac40MIMO	5510	Type6	2	1	333.3	9	0.3333	300	5675	1
11ac40MIMO	5510	Type6	2	1	333.3	9	0.3333	300	5678	1
11ac40MIMO	5510	Type6	2	1	333.3	9	0.3333	300	5581	1
11ac40MIMO	5510	Type6	2	1	333.3	9	0.3333	300	5275	1
11ac40MIMO	5510	Type6	2	1	333.3	9	0.3333	300	5381	1
11ac40MIMO	5510	Type6	2	1	333.3	9	0.3333	300	5512	1
11ac40MIMO	5510	Type6	2	1	333.3	9	0.3333	300	5600	1
11ac40MIMO	5510	Type6	2	1	333.3	9	0.3333	300	5304	1
11ac40MIMO	5510	Type6	2	1	333.3	9	0.3333	300	5382	1
11ac40MIMO	5510	Type6	2	1	333.3	9	0.3333	300	5389	1
11ac40MIMO	5510	Type6	2	1	333.3	9	0.3333	300	5458	1
11ac40MIMO	5510	Type6	2	1	333.3	9	0.3333	300	5666	1
11ac40MIMO	5510	Type6	2	1	333.3	9	0.3333	300	5419	1
11ac40MIMO	5510	Type6	2	1	333.3	9	0.3333	300	5642	1
11ac40MIMO	5510	Type6	2	1	333.3	9	0.3333	300	5350	1
11ac40MIMO	5510	Type6	2	1	333.3	9	0.3333	300	5526	1
11ac40MIMO	5510	Type6	2	1	333.3	9	0.3333	300	5519	1
11ac40MIMO	5510	Type6	2	1	333.3	9	0.3333	300	5709	1
11ac40MIMO	5510	Type6	2	1	333.3	9	0.3333	300	5692	1
11ac40MIMO	5510	Type6	2	1	333.3	9	0.3333	300	5418	1
11ac40MIMO	5510	Type6	2	1	333.3	9	0.3333	300	5653	1
11ac40MIMO	5510	Type6	2	1	333.3	9	0.3333	300	5354	1
11ac20MIMO	5500	Type6	2	1	333.3	9	0.3333	300	5302	1
11ac20MIMO	5500	Type6	2	1	333.3	9	0.3333	300	5342	1
11ac20MIMO	5500	Type6	2	1	333.3	9	0.3333	300	5681	1
11ac20MIMO	5500	Type6	2	1	333.3	9	0.3333	300	5455	1
11ac20MIMO	5500	Type6	2	1	333.3	9	0.3333	300	5611	1
11ac20MIMO	5500	Type6	2	1	333.3	9	0.3333	300	5493	1
11ac20MIMO	5500	Type6	2	1	333.3	9	0.3333	300	5682	1
11ac20MIMO	5500	Type6	2	1	333.3	9	0.3333	300	5310	1
11ac20MIMO	5500	Type6	2	1	333.3	9	0.3333	300	5257	1
11ac20MIMO	5500	Type6	2	1	333.3	9	0.3333	300	5606	1



Unless otherwise agreed in writing, this document is issued by the Company subject to its General Conditions of Service printed overleaf, available on request or accessible at <http://www.sgs.com/en/Terms-and-Conditions.aspx> and, for electronic format documents, subject to Terms and Conditions for Electronic Documents at <http://www.sgs.com/en/Terms-and-Conditions/Terms-e-Document.aspx>. Attention is drawn to the limitation of liability, indemnification and jurisdiction issues defined therein. Any holder of this document is advised that information contained herein reflects the Company's findings at the time of its intervention only and within the limits of Client's instructions, if any. The Company's sole responsibility is to its Client and this document does not exonerate parties to a transaction from exercising all their rights and obligations under the transaction documents. This document cannot be reproduced except in full, without prior written approval of the Company. Any unauthorized alteration, forgery or falsification of the content or appearance of this document is unlawful and offenders may be prosecuted to the fullest extent of the law. Unless otherwise stated the results shown in this test report refer only to the sample(s) tested and such sample(s) are retained for 30 days only.

Attention: To check the authenticity of testing/inspection report & certificate, please contact us at telephone: (86-755) 8307 1443, or email: [CN.Doccheck@sgs.com](mailto:CN.Doccheck@sgs.com)  
 (E) Unit D, Building 1, Kanglong Orange Science Park, No.157, Keyuan 3rd Road, Fengyang New Town, Xi'an, Shaanxi, China 710086  
 t (86-29) 6282 7885 www.sgs.com.cn  
 中国·西安·沣东新城科里三路157号康隆橙方科技园1号楼D单元1层 邮编: 710086 t (86-29) 6282 7885 sgs.china@sgs.com

11ac20MIMO	5500	Type6	2	1	333.3	9	0.3333	300	5587	1
11ac20MIMO	5500	Type6	2	1	333.3	9	0.3333	300	5561	1
11ac20MIMO	5500	Type6	2	1	333.3	9	0.3333	300	5374	1
11ac20MIMO	5500	Type6	2	1	333.3	9	0.3333	300	5362	1
11ac20MIMO	5500	Type6	2	1	333.3	9	0.3333	300	5630	1
11ac20MIMO	5500	Type6	2	1	333.3	9	0.3333	300	5322	1
11ac20MIMO	5500	Type6	2	1	333.3	9	0.3333	300	5320	1
11ac20MIMO	5500	Type6	2	1	333.3	9	0.3333	300	5502	1
11ac20MIMO	5500	Type6	2	1	333.3	9	0.3333	300	5475	1
11ac20MIMO	5500	Type6	2	1	333.3	9	0.3333	300	5364	1
11ac20MIMO	5500	Type6	2	1	333.3	9	0.3333	300	5555	1
11ac20MIMO	5500	Type6	2	1	333.3	9	0.3333	300	5353	1
11ac20MIMO	5500	Type6	2	1	333.3	9	0.3333	300	5316	1
11ac20MIMO	5500	Type6	2	1	333.3	9	0.3333	300	5387	1
11ac20MIMO	5500	Type6	2	1	333.3	9	0.3333	300	5357	1
11ac20MIMO	5500	Type6	2	1	333.3	9	0.3333	300	5332	1
11ac20MIMO	5500	Type6	2	1	333.3	9	0.3333	300	5654	1
11ac20MIMO	5500	Type6	2	1	333.3	9	0.3333	300	5312	1
11ac20MIMO	5500	Type6	2	1	333.3	9	0.3333	300	5262	1
11ac20MIMO	5500	Type6	2	1	333.3	9	0.3333	300	5409	1
11ac20MIMO	5500	Type6	2	1	333.3	9	0.3333	300	5522	1
11ac20MIMO	5500	Type6	2	1	333.3	9	0.3333	300	5547	1
11ac20MIMO	5500	Type6	2	1	333.3	9	0.3333	300	5410	1
11ac20MIMO	5500	Type6	2	1	333.3	9	0.3333	300	5618	1
11ac20MIMO	5500	Type6	2	1	333.3	9	0.3333	300	5253	1
11ac20MIMO	5500	Type6	2	1	333.3	9	0.3333	300	5311	1
11ac20MIMO	5500	Type6	2	1	333.3	9	0.3333	300	5683	1
11ac20MIMO	5500	Type6	2	1	333.3	9	0.3333	300	5556	1
11ac20MIMO	5500	Type6	2	1	333.3	9	0.3333	300	5470	1
11ac20MIMO	5500	Type6	2	1	333.3	9	0.3333	300	5258	1
11ac20MIMO	5500	Type6	2	1	333.3	9	0.3333	300	5537	1
11ac20MIMO	5500	Type6	2	1	333.3	9	0.3333	300	5398	1
11ac20MIMO	5500	Type6	2	1	333.3	9	0.3333	300	5710	1
11ac20MIMO	5500	Type6	2	1	333.3	9	0.3333	300	5491	1
11ac20MIMO	5500	Type6	2	1	333.3	9	0.3333	300	5469	1
11ac20MIMO	5500	Type6	2	1	333.3	9	0.3333	300	5670	1
11ac20MIMO	5500	Type6	2	1	333.3	9	0.3333	300	5465	1
11ac20MIMO	5500	Type6	2	1	333.3	9	0.3333	300	5704	1
11ac20MIMO	5500	Type6	2	1	333.3	9	0.3333	300	5456	1
11ac20MIMO	5500	Type6	2	1	333.3	9	0.3333	300	5406	1
11ac20MIMO	5500	Type6	2	1	333.3	9	0.3333	300	5384	1
11ac20MIMO	5500	Type6	2	1	333.3	9	0.3333	300	5400	1
11ac20MIMO	5500	Type6	2	1	333.3	9	0.3333	300	5513	1
11ac20MIMO	5500	Type6	2	1	333.3	9	0.3333	300	5720	1
11ac20MIMO	5500	Type6	2	1	333.3	9	0.3333	300	5365	1
11ac20MIMO	5500	Type6	2	1	333.3	9	0.3333	300	5296	1
11ac20MIMO	5500	Type6	2	1	333.3	9	0.3333	300	5276	1
11ac20MIMO	5500	Type6	2	1	333.3	9	0.3333	300	5641	1
11ac20MIMO	5500	Type6	2	1	333.3	9	0.3333	300	5445	1
11ac20MIMO	5500	Type6	2	1	333.3	9	0.3333	300	5626	1
11ac20MIMO	5500	Type6	2	1	333.3	9	0.3333	300	5564	1
11ac20MIMO	5500	Type6	2	1	333.3	9	0.3333	300	5620	1
11ac20MIMO	5500	Type6	2	1	333.3	9	0.3333	300	5395	1



Unless otherwise agreed in writing, this document is issued by the Company subject to its General Conditions of Service printed overleaf, available on request or accessible at <http://www.sgs.com/en/Terms-and-Conditions.aspx> and, for electronic format documents, subject to Terms and Conditions for Electronic Documents at <http://www.sgs.com/en/Terms-and-Conditions/Terms-e-Documents.aspx>. Attention is drawn to the limitation of liability, indemnification and jurisdiction issues defined therein. Any holder of this document is advised that information contained herein reflects the Company's findings at the time of its intervention only and within the limits of Client's instructions, if any. The Company's sole responsibility is to its Client and this document does not exonerate parties to a transaction from exercising all their rights and obligations under the transaction documents. This document cannot be reproduced except in full, without prior written approval of the Company. Any unauthorized alteration, forgery or falsification of the content or appearance of this document is unlawful and offenders may be prosecuted to the fullest extent of the law. Unless otherwise stated the results shown in this test report refer only to the sample(s) tested and such sample(s) are retained for 30 days only.

Attention: To check the authenticity of testing/inspection report & certificate, please contact us at telephone: (86-755) 8307 1443, or email: [CN.Doccheck@sgs.com](mailto:CN.Doccheck@sgs.com)

SGS-CSTC Standards Technical Services (Xi'an) Co., Ltd. | 1/F Unit D, Building 1, Kanglong Orange Science Park, No.137, Keyuan3rd Road, Fengyang New Town, Xian, Shaanxi, China | 710086 | t (86-29) 6282 7885 | www.sgs.com.cn  
 中国·西安·沣东新城科里三路137号康鸿橙方科技园1号楼D单元1层 | 邮编: 710086 | t (86-29) 6282 7885 | sgs.china@sgs.com





11ac20MIMO	5500	Type6	2	1	333.3	9	0.3333	300	5334	1
11ac20MIMO	5500	Type6	2	1	333.3	9	0.3333	300	5290	1
11ac20MIMO	5500	Type6	2	1	333.3	9	0.3333	300	5401	1
11ac20MIMO	5500	Type6	2	1	333.3	9	0.3333	300	5578	1
11ac20MIMO	5500	Type6	2	1	333.3	9	0.3333	300	5359	1
11ac20MIMO	5500	Type6	2	1	333.3	9	0.3333	300	5569	1
11ac20MIMO	5500	Type6	2	1	333.3	9	0.3333	300	5586	1
11ac20MIMO	5500	Type6	2	1	333.3	9	0.3333	300	5282	1
11ac20MIMO	5500	Type6	2	1	333.3	9	0.3333	300	5649	1
11ac20MIMO	5500	Type6	2	1	333.3	9	0.3333	300	5407	1
11ac20MIMO	5500	Type6	2	1	333.3	9	0.3333	300	5368	1
11ac20MIMO	5500	Type6	2	1	333.3	9	0.3333	300	5647	1
11ac20MIMO	5500	Type6	2	1	333.3	9	0.3333	300	5643	1
11ac20MIMO	5500	Type6	2	1	333.3	9	0.3333	300	5509	1
11ac20MIMO	5500	Type6	2	1	333.3	9	0.3333	300	5592	1
11ac20MIMO	5500	Type6	2	1	333.3	9	0.3333	300	5675	1
11ac20MIMO	5500	Type6	2	1	333.3	9	0.3333	300	5678	1
11ac20MIMO	5500	Type6	2	1	333.3	9	0.3333	300	5581	1
11ac20MIMO	5500	Type6	2	1	333.3	9	0.3333	300	5275	1
11ac20MIMO	5500	Type6	2	1	333.3	9	0.3333	300	5381	1
11ac20MIMO	5500	Type6	2	1	333.3	9	0.3333	300	5512	1
11ac20MIMO	5500	Type6	2	1	333.3	9	0.3333	300	5600	1
11ac20MIMO	5500	Type6	2	1	333.3	9	0.3333	300	5304	1
11ac20MIMO	5500	Type6	2	1	333.3	9	0.3333	300	5382	1
11ac20MIMO	5500	Type6	2	1	333.3	9	0.3333	300	5389	1
11ac20MIMO	5500	Type6	2	1	333.3	9	0.3333	300	5458	1
11ac20MIMO	5500	Type6	2	1	333.3	9	0.3333	300	5666	1
11ac20MIMO	5500	Type6	2	1	333.3	9	0.3333	300	5419	1
11ac20MIMO	5500	Type6	2	1	333.3	9	0.3333	300	5642	1
11ac20MIMO	5500	Type6	2	1	333.3	9	0.3333	300	5350	1
11ac20MIMO	5500	Type6	2	1	333.3	9	0.3333	300	5526	1
11ac20MIMO	5500	Type6	2	1	333.3	9	0.3333	300	5519	1
11ac20MIMO	5500	Type6	2	1	333.3	9	0.3333	300	5709	1
11ac20MIMO	5500	Type6	2	1	333.3	9	0.3333	300	5692	1
11ac20MIMO	5500	Type6	2	1	333.3	9	0.3333	300	5418	1
11ac20MIMO	5500	Type6	2	1	333.3	9	0.3333	300	5653	1
11ac20MIMO	5500	Type6	2	1	333.3	9	0.3333	300	5354	1



Unless otherwise agreed in writing, this document is issued by the Company subject to its General Conditions of Service printed overleaf, available on request or accessible at <http://www.sgs.com/en/Terms-and-Conditions.aspx> and, for electronic format documents, subject to Terms and Conditions for Electronic Documents at <http://www.sgs.com/en/Terms-and-Conditions/Terms-e-Documents.aspx>. Attention is drawn to the limitation of liability, indemnification and jurisdiction issues defined therein. Any holder of this document is advised that information contained herein reflects the Company's findings at the time of its intervention only and within the limits of Client's instructions, if any. The Company's sole responsibility is to its Client and this document does not exonerate parties to a transaction from exercising all their rights and obligations under the transaction documents. This document cannot be reproduced except in full, without prior written approval of the Company. Any unauthorized alteration, forgery or falsification of the content or appearance of this document is unlawful and offenders may be prosecuted to the fullest extent of the law. Unless otherwise stated the results shown in this test report refer only to the sample(s) tested and such sample(s) are retained for 30 days only.

Attention: To check the authenticity of testing/inspection report & certificate, please contact us at telephone: (86-755) 4307 1443, or email: CN.Doccheck@sgs.com

SGS-CSTC Standards Technical Services (Xi'an) Co., Ltd. | 1/E Unit D, Building 1, Kanglong Orange Science Park, No.137, Kejian 3rd Road, Fengling New Town, Xi'an, Shaanxi, China | 710086 | t (86-29) 6282 7885 | www.sgs.com.cn  
 中国·西安·沣东新城科里三路137号康隆橙方科技园1号楼D单元1层 | 邮编: 710086 | t (86-29) 6282 7885 | sgs.china@sgs.com

TestMode	Channel	Radar Type	Trial ID	Pulse width (μs)	PRI (μs)	Pulses per Hop	Hop Rate (kHz)	Hop Sequence Length(ms)	Center Frequency (MHz)	Detection (1: Yes; 0: No)
11ac80MIMO	5530	Type6	3	1	333.3	9	0.3333	300	5557	1
11ac80MIMO	5530	Type6	3	1	333.3	9	0.3333	300	5581	1
11ac80MIMO	5530	Type6	3	1	333.3	9	0.3333	300	5617	1
11ac80MIMO	5530	Type6	3	1	333.3	9	0.3333	300	5616	1
11ac80MIMO	5530	Type6	3	1	333.3	9	0.3333	300	5356	1
11ac80MIMO	5530	Type6	3	1	333.3	9	0.3333	300	5535	1
11ac80MIMO	5530	Type6	3	1	333.3	9	0.3333	300	5704	1
11ac80MIMO	5530	Type6	3	1	333.3	9	0.3333	300	5385	1
11ac80MIMO	5530	Type6	3	1	333.3	9	0.3333	300	5420	1
11ac80MIMO	5530	Type6	3	1	333.3	9	0.3333	300	5338	1
11ac80MIMO	5530	Type6	3	1	333.3	9	0.3333	300	5518	1
11ac80MIMO	5530	Type6	3	1	333.3	9	0.3333	300	5350	1
11ac80MIMO	5530	Type6	3	1	333.3	9	0.3333	300	5415	1
11ac80MIMO	5530	Type6	3	1	333.3	9	0.3333	300	5651	1
11ac80MIMO	5530	Type6	3	1	333.3	9	0.3333	300	5313	1
11ac80MIMO	5530	Type6	3	1	333.3	9	0.3333	300	5447	1
11ac80MIMO	5530	Type6	3	1	333.3	9	0.3333	300	5605	1
11ac80MIMO	5530	Type6	3	1	333.3	9	0.3333	300	5520	1
11ac80MIMO	5530	Type6	3	1	333.3	9	0.3333	300	5653	1
11ac80MIMO	5530	Type6	3	1	333.3	9	0.3333	300	5563	1
11ac80MIMO	5530	Type6	3	1	333.3	9	0.3333	300	5519	1
11ac80MIMO	5530	Type6	3	1	333.3	9	0.3333	300	5257	1
11ac80MIMO	5530	Type6	3	1	333.3	9	0.3333	300	5476	1
11ac80MIMO	5530	Type6	3	1	333.3	9	0.3333	300	5330	1
11ac80MIMO	5530	Type6	3	1	333.3	9	0.3333	300	5598	1
11ac80MIMO	5530	Type6	3	1	333.3	9	0.3333	300	5506	1
11ac80MIMO	5530	Type6	3	1	333.3	9	0.3333	300	5515	1
11ac80MIMO	5530	Type6	3	1	333.3	9	0.3333	300	5366	1
11ac80MIMO	5530	Type6	3	1	333.3	9	0.3333	300	5443	1
11ac80MIMO	5530	Type6	3	1	333.3	9	0.3333	300	5661	1
11ac80MIMO	5530	Type6	3	1	333.3	9	0.3333	300	5533	1
11ac80MIMO	5530	Type6	3	1	333.3	9	0.3333	300	5367	1
11ac80MIMO	5530	Type6	3	1	333.3	9	0.3333	300	5358	1
11ac80MIMO	5530	Type6	3	1	333.3	9	0.3333	300	5502	1
11ac80MIMO	5530	Type6	3	1	333.3	9	0.3333	300	5606	1
11ac80MIMO	5530	Type6	3	1	333.3	9	0.3333	300	5347	1
11ac80MIMO	5530	Type6	3	1	333.3	9	0.3333	300	5647	1
11ac80MIMO	5530	Type6	3	1	333.3	9	0.3333	300	5266	1
11ac80MIMO	5530	Type6	3	1	333.3	9	0.3333	300	5411	1
11ac80MIMO	5530	Type6	3	1	333.3	9	0.3333	300	5451	1
11ac80MIMO	5530	Type6	3	1	333.3	9	0.3333	300	5334	1
11ac80MIMO	5530	Type6	3	1	333.3	9	0.3333	300	5332	1
11ac80MIMO	5530	Type6	3	1	333.3	9	0.3333	300	5709	1
11ac80MIMO	5530	Type6	3	1	333.3	9	0.3333	300	5667	1
11ac80MIMO	5530	Type6	3	1	333.3	9	0.3333	300	5394	1
11ac80MIMO	5530	Type6	3	1	333.3	9	0.3333	300	5684	1
11ac80MIMO	5530	Type6	3	1	333.3	9	0.3333	300	5539	1
11ac80MIMO	5530	Type6	3	1	333.3	9	0.3333	300	5464	1
11ac80MIMO	5530	Type6	3	1	333.3	9	0.3333	300	5437	1



Unless otherwise agreed in writing, this document is issued by the Company subject to its General Conditions of Service printed overleaf, available on request or accessible at <http://www.sgs.com/en/Terms-and-Conditions.aspx> and, for electronic format documents, subject to Terms and Conditions for Electronic Documents at <http://www.sgs.com/en/Terms-and-Conditions/Terms-e-Documents.aspx>. Attention is drawn to the limitation of liability, indemnification and jurisdiction issues defined therein. Any holder of this document is advised that information contained herein reflects the Company's findings at the time of its intervention only and within the limits of Client's instructions, if any. The Company's sole responsibility is to its Client and this document does not exonerate parties to a transaction from exercising all their rights and obligations under the transaction documents. This document cannot be reproduced except in full, without prior written approval of the Company. Any unauthorized alteration, forgery or falsification of the content or appearance of this document is unlawful and offenders may be prosecuted to the fullest extent of the law. Unless otherwise stated the results shown in this test report refer only to the sample(s) tested and such sample(s) are retained for 30 days only.

Attention: To check the authenticity of testing/inspection report & certificate, please contact us at telephone: (86-755) 8307 1443, or email: [CN.Doccheck@sgs.com](mailto:CN.Doccheck@sgs.com)

SGS-CSTC Standards Technical Services (Xi'an) Co., Ltd. | 1/E Unit D, Building 1, Kanglong Orange Science Park, No.157, Keyuan 3rd Road, Fengjing/Yue Town, Xi'an, Shaanxi, China | 710086 | t (86-29) 6282 7885 | www.sgs.com.cn  
 中国·西安·沣东新城科里三路157号康隆橙方科技园1号楼D单元1层 | 邮编: 710086 | t (86-29) 6282 7885 | sgs.china@sgs.com

11ac80MIMO	5530	Type6	3	1	333.3	9	0.3333	300	5665	1
11ac80MIMO	5530	Type6	3	1	333.3	9	0.3333	300	5389	1
11ac80MIMO	5530	Type6	3	1	333.3	9	0.3333	300	5421	1
11ac80MIMO	5530	Type6	3	1	333.3	9	0.3333	300	5416	1
11ac80MIMO	5530	Type6	3	1	333.3	9	0.3333	300	5574	1
11ac80MIMO	5530	Type6	3	1	333.3	9	0.3333	300	5488	1
11ac80MIMO	5530	Type6	3	1	333.3	9	0.3333	300	5536	1
11ac80MIMO	5530	Type6	3	1	333.3	9	0.3333	300	5580	1
11ac80MIMO	5530	Type6	3	1	333.3	9	0.3333	300	5279	1
11ac80MIMO	5530	Type6	3	1	333.3	9	0.3333	300	5439	1
11ac80MIMO	5530	Type6	3	1	333.3	9	0.3333	300	5324	1
11ac80MIMO	5530	Type6	3	1	333.3	9	0.3333	300	5499	1
11ac80MIMO	5530	Type6	3	1	333.3	9	0.3333	300	5710	1
11ac80MIMO	5530	Type6	3	1	333.3	9	0.3333	300	5708	1
11ac80MIMO	5530	Type6	3	1	333.3	9	0.3333	300	5404	1
11ac80MIMO	5530	Type6	3	1	333.3	9	0.3333	300	5305	1
11ac80MIMO	5530	Type6	3	1	333.3	9	0.3333	300	5295	1
11ac80MIMO	5530	Type6	3	1	333.3	9	0.3333	300	5525	1
11ac80MIMO	5530	Type6	3	1	333.3	9	0.3333	300	5589	1
11ac80MIMO	5530	Type6	3	1	333.3	9	0.3333	300	5359	1
11ac80MIMO	5530	Type6	3	1	333.3	9	0.3333	300	5452	1
11ac80MIMO	5530	Type6	3	1	333.3	9	0.3333	300	5576	1
11ac80MIMO	5530	Type6	3	1	333.3	9	0.3333	300	5272	1
11ac80MIMO	5530	Type6	3	1	333.3	9	0.3333	300	5492	1
11ac80MIMO	5530	Type6	3	1	333.3	9	0.3333	300	5388	1
11ac80MIMO	5530	Type6	3	1	333.3	9	0.3333	300	5551	1
11ac80MIMO	5530	Type6	3	1	333.3	9	0.3333	300	5547	1
11ac80MIMO	5530	Type6	3	1	333.3	9	0.3333	300	5323	1
11ac80MIMO	5530	Type6	3	1	333.3	9	0.3333	300	5724	1
11ac80MIMO	5530	Type6	3	1	333.3	9	0.3333	300	5256	1
11ac80MIMO	5530	Type6	3	1	333.3	9	0.3333	300	5721	1
11ac80MIMO	5530	Type6	3	1	333.3	9	0.3333	300	5293	1
11ac80MIMO	5530	Type6	3	1	333.3	9	0.3333	300	5379	1
11ac80MIMO	5530	Type6	3	1	333.3	9	0.3333	300	5584	1
11ac80MIMO	5530	Type6	3	1	333.3	9	0.3333	300	5361	1
11ac80MIMO	5530	Type6	3	1	333.3	9	0.3333	300	5508	1
11ac80MIMO	5530	Type6	3	1	333.3	9	0.3333	300	5479	1
11ac80MIMO	5530	Type6	3	1	333.3	9	0.3333	300	5693	1
11ac80MIMO	5530	Type6	3	1	333.3	9	0.3333	300	5341	1
11ac80MIMO	5530	Type6	3	1	333.3	9	0.3333	300	5655	1
11ac80MIMO	5530	Type6	3	1	333.3	9	0.3333	300	5715	1
11ac80MIMO	5530	Type6	3	1	333.3	9	0.3333	300	5629	1
11ac80MIMO	5530	Type6	3	1	333.3	9	0.3333	300	5494	1
11ac80MIMO	5530	Type6	3	1	333.3	9	0.3333	300	5401	1
11ac80MIMO	5530	Type6	3	1	333.3	9	0.3333	300	5637	1
11ac80MIMO	5530	Type6	3	1	333.3	9	0.3333	300	5423	1
11ac80MIMO	5530	Type6	3	1	333.3	9	0.3333	300	5280	1
11ac80MIMO	5530	Type6	3	1	333.3	9	0.3333	300	5316	1
11ac80MIMO	5530	Type6	3	1	333.3	9	0.3333	300	5662	1
11ac80MIMO	5530	Type6	3	1	333.3	9	0.3333	300	5281	1
11ac80MIMO	5530	Type6	3	1	333.3	9	0.3333	300	5649	1
11ac40MIMO	5510	Type6	3	1	333.3	9	0.3333	300	5557	1
11ac40MIMO	5510	Type6	3	1	333.3	9	0.3333	300	5581	1



Unless otherwise agreed in writing, this document is issued by the Company subject to its General Conditions of Service printed overleaf, available on request or accessible at <http://www.sgs.com/en/Terms-and-Conditions.aspx> and, for electronic format documents, subject to Terms and Conditions for Electronic Documents at <http://www.sgs.com/en/Terms-and-Conditions/Terms-e-Documents.aspx>. Attention is drawn to the limitation of liability, indemnification and jurisdiction issues defined therein. Any holder of this document is advised that information contained herein reflects the Company's findings at the time of its intervention only and within the limits of Client's instructions, if any. The Company's sole responsibility is to its Client and this document does not exonerate parties to a transaction from exercising all their rights and obligations under the transaction documents. This document cannot be reproduced except in full, without prior written approval of the Company. Any unauthorized alteration, forgery or falsification of the content or appearance of this document is unlawful and offenders may be prosecuted to the fullest extent of the law. Unless otherwise stated the results shown in this test report refer only to the sample(s) tested and such sample(s) are retained for 30 days only.

Attention: To check the authenticity of testing/inspection report & certificate, please contact us at telephone: (86-755) 8307 1443, or email: [CN.Doccheck@sgs.com](mailto:CN.Doccheck@sgs.com)  
 (E) Unit D, Building 1, Kanglong Orange Science Park, No.157, Keyuan 3rd Road, Fengjing New Town, Xian, Shaanxi, China 710086  
 t (86-29) 6282 7885 www.sgs.com.cn  
 中国·西安·沣东新城科里三路157号康隆橙方科技园1号楼D单元1层 邮编: 710086 t (86-29) 6282 7885 sgs.china@sgs.com



11ac40MIMO	5510	Type6	3	1	333.3	9	0.3333	300	5617	1
11ac40MIMO	5510	Type6	3	1	333.3	9	0.3333	300	5616	1
11ac40MIMO	5510	Type6	3	1	333.3	9	0.3333	300	5356	1
11ac40MIMO	5510	Type6	3	1	333.3	9	0.3333	300	5535	1
11ac40MIMO	5510	Type6	3	1	333.3	9	0.3333	300	5704	1
11ac40MIMO	5510	Type6	3	1	333.3	9	0.3333	300	5385	1
11ac40MIMO	5510	Type6	3	1	333.3	9	0.3333	300	5420	1
11ac40MIMO	5510	Type6	3	1	333.3	9	0.3333	300	5338	1
11ac40MIMO	5510	Type6	3	1	333.3	9	0.3333	300	5518	1
11ac40MIMO	5510	Type6	3	1	333.3	9	0.3333	300	5350	1
11ac40MIMO	5510	Type6	3	1	333.3	9	0.3333	300	5415	1
11ac40MIMO	5510	Type6	3	1	333.3	9	0.3333	300	5651	1
11ac40MIMO	5510	Type6	3	1	333.3	9	0.3333	300	5313	1
11ac40MIMO	5510	Type6	3	1	333.3	9	0.3333	300	5447	1
11ac40MIMO	5510	Type6	3	1	333.3	9	0.3333	300	5605	1
11ac40MIMO	5510	Type6	3	1	333.3	9	0.3333	300	5520	1
11ac40MIMO	5510	Type6	3	1	333.3	9	0.3333	300	5653	1
11ac40MIMO	5510	Type6	3	1	333.3	9	0.3333	300	5563	1
11ac40MIMO	5510	Type6	3	1	333.3	9	0.3333	300	5519	1
11ac40MIMO	5510	Type6	3	1	333.3	9	0.3333	300	5257	1
11ac40MIMO	5510	Type6	3	1	333.3	9	0.3333	300	5476	1
11ac40MIMO	5510	Type6	3	1	333.3	9	0.3333	300	5330	1
11ac40MIMO	5510	Type6	3	1	333.3	9	0.3333	300	5598	1
11ac40MIMO	5510	Type6	3	1	333.3	9	0.3333	300	5506	1
11ac40MIMO	5510	Type6	3	1	333.3	9	0.3333	300	5515	1
11ac40MIMO	5510	Type6	3	1	333.3	9	0.3333	300	5366	1
11ac40MIMO	5510	Type6	3	1	333.3	9	0.3333	300	5443	1
11ac40MIMO	5510	Type6	3	1	333.3	9	0.3333	300	5661	1
11ac40MIMO	5510	Type6	3	1	333.3	9	0.3333	300	5533	1
11ac40MIMO	5510	Type6	3	1	333.3	9	0.3333	300	5367	1
11ac40MIMO	5510	Type6	3	1	333.3	9	0.3333	300	5358	1
11ac40MIMO	5510	Type6	3	1	333.3	9	0.3333	300	5502	1
11ac40MIMO	5510	Type6	3	1	333.3	9	0.3333	300	5606	1
11ac40MIMO	5510	Type6	3	1	333.3	9	0.3333	300	5347	1
11ac40MIMO	5510	Type6	3	1	333.3	9	0.3333	300	5647	1
11ac40MIMO	5510	Type6	3	1	333.3	9	0.3333	300	5266	1
11ac40MIMO	5510	Type6	3	1	333.3	9	0.3333	300	5411	1
11ac40MIMO	5510	Type6	3	1	333.3	9	0.3333	300	5451	1
11ac40MIMO	5510	Type6	3	1	333.3	9	0.3333	300	5334	1
11ac40MIMO	5510	Type6	3	1	333.3	9	0.3333	300	5332	1
11ac40MIMO	5510	Type6	3	1	333.3	9	0.3333	300	5709	1
11ac40MIMO	5510	Type6	3	1	333.3	9	0.3333	300	5667	1
11ac40MIMO	5510	Type6	3	1	333.3	9	0.3333	300	5394	1
11ac40MIMO	5510	Type6	3	1	333.3	9	0.3333	300	5684	1
11ac40MIMO	5510	Type6	3	1	333.3	9	0.3333	300	5539	1
11ac40MIMO	5510	Type6	3	1	333.3	9	0.3333	300	5464	1
11ac40MIMO	5510	Type6	3	1	333.3	9	0.3333	300	5437	1
11ac40MIMO	5510	Type6	3	1	333.3	9	0.3333	300	5665	1
11ac40MIMO	5510	Type6	3	1	333.3	9	0.3333	300	5389	1
11ac40MIMO	5510	Type6	3	1	333.3	9	0.3333	300	5421	1
11ac40MIMO	5510	Type6	3	1	333.3	9	0.3333	300	5416	1
11ac40MIMO	5510	Type6	3	1	333.3	9	0.3333	300	5574	1
11ac40MIMO	5510	Type6	3	1	333.3	9	0.3333	300	5488	1



Unless otherwise agreed in writing, this document is issued by the Company subject to its General Conditions of Service printed overleaf, available on request or accessible at <http://www.sgs.com/en/Terms-and-Conditions.aspx> and, for electronic format documents, subject to Terms and Conditions for Electronic Documents at <http://www.sgs.com/en/Terms-and-Conditions/Terms-e-Documents.aspx>. Attention is drawn to the limitation of liability, indemnification and jurisdiction issues defined therein. Any holder of this document is advised that information contained herein reflects the Company's findings at the time of its intervention only and within the limits of Client's instructions, if any. The Company's sole responsibility is to its Client and this document does not exonerate parties to a transaction from exercising all their rights and obligations under the transaction documents. This document cannot be reproduced except in full, without prior written approval of the Company. Any unauthorized alteration, forgery or falsification of the content or appearance of this document is unlawful and offenders may be prosecuted to the fullest extent of the law. Unless otherwise stated the results shown in this test report refer only to the sample(s) tested and such sample(s) are retained for 30 days only.

Attention: To check the authenticity of testing/inspection report & certificate, please contact us at telephone: (86-755) 8307 1443, or email: [CN.Doccheck@sgs.com](mailto:CN.Doccheck@sgs.com)  
 (E) Unit D, Building 1, Kanglong Orange Science Park, No.157, Keyuan 3rd Road, Fengyang New Town, Xian, Shaanxi, China 710086 t (86-29) 6282 7885 www.sgs.com.cn  
 中国·西安·沣东新城科里三路157号康隆橙方科技园1号楼D单元1层 邮编: 710086 t (86-29) 6282 7885 sgs.china@sgs.com

11ac40MIMO	5510	Type6	3	1	333.3	9	0.3333	300	5536	1
11ac40MIMO	5510	Type6	3	1	333.3	9	0.3333	300	5580	1
11ac40MIMO	5510	Type6	3	1	333.3	9	0.3333	300	5279	1
11ac40MIMO	5510	Type6	3	1	333.3	9	0.3333	300	5439	1
11ac40MIMO	5510	Type6	3	1	333.3	9	0.3333	300	5324	1
11ac40MIMO	5510	Type6	3	1	333.3	9	0.3333	300	5499	1
11ac40MIMO	5510	Type6	3	1	333.3	9	0.3333	300	5710	1
11ac40MIMO	5510	Type6	3	1	333.3	9	0.3333	300	5708	1
11ac40MIMO	5510	Type6	3	1	333.3	9	0.3333	300	5404	1
11ac40MIMO	5510	Type6	3	1	333.3	9	0.3333	300	5305	1
11ac40MIMO	5510	Type6	3	1	333.3	9	0.3333	300	5295	1
11ac40MIMO	5510	Type6	3	1	333.3	9	0.3333	300	5525	1
11ac40MIMO	5510	Type6	3	1	333.3	9	0.3333	300	5589	1
11ac40MIMO	5510	Type6	3	1	333.3	9	0.3333	300	5359	1
11ac40MIMO	5510	Type6	3	1	333.3	9	0.3333	300	5452	1
11ac40MIMO	5510	Type6	3	1	333.3	9	0.3333	300	5576	1
11ac40MIMO	5510	Type6	3	1	333.3	9	0.3333	300	5272	1
11ac40MIMO	5510	Type6	3	1	333.3	9	0.3333	300	5492	1
11ac40MIMO	5510	Type6	3	1	333.3	9	0.3333	300	5388	1
11ac40MIMO	5510	Type6	3	1	333.3	9	0.3333	300	5551	1
11ac40MIMO	5510	Type6	3	1	333.3	9	0.3333	300	5547	1
11ac40MIMO	5510	Type6	3	1	333.3	9	0.3333	300	5323	1
11ac40MIMO	5510	Type6	3	1	333.3	9	0.3333	300	5724	1
11ac40MIMO	5510	Type6	3	1	333.3	9	0.3333	300	5256	1
11ac40MIMO	5510	Type6	3	1	333.3	9	0.3333	300	5721	1
11ac40MIMO	5510	Type6	3	1	333.3	9	0.3333	300	5293	1
11ac40MIMO	5510	Type6	3	1	333.3	9	0.3333	300	5379	1
11ac40MIMO	5510	Type6	3	1	333.3	9	0.3333	300	5584	1
11ac40MIMO	5510	Type6	3	1	333.3	9	0.3333	300	5361	1
11ac40MIMO	5510	Type6	3	1	333.3	9	0.3333	300	5508	1
11ac40MIMO	5510	Type6	3	1	333.3	9	0.3333	300	5479	1
11ac40MIMO	5510	Type6	3	1	333.3	9	0.3333	300	5693	1
11ac40MIMO	5510	Type6	3	1	333.3	9	0.3333	300	5341	1
11ac40MIMO	5510	Type6	3	1	333.3	9	0.3333	300	5655	1
11ac40MIMO	5510	Type6	3	1	333.3	9	0.3333	300	5715	1
11ac40MIMO	5510	Type6	3	1	333.3	9	0.3333	300	5629	1
11ac40MIMO	5510	Type6	3	1	333.3	9	0.3333	300	5494	1
11ac40MIMO	5510	Type6	3	1	333.3	9	0.3333	300	5401	1
11ac40MIMO	5510	Type6	3	1	333.3	9	0.3333	300	5637	1
11ac40MIMO	5510	Type6	3	1	333.3	9	0.3333	300	5423	1
11ac40MIMO	5510	Type6	3	1	333.3	9	0.3333	300	5280	1
11ac40MIMO	5510	Type6	3	1	333.3	9	0.3333	300	5316	1
11ac40MIMO	5510	Type6	3	1	333.3	9	0.3333	300	5662	1
11ac40MIMO	5510	Type6	3	1	333.3	9	0.3333	300	5281	1
11ac40MIMO	5510	Type6	3	1	333.3	9	0.3333	300	5649	1
11ac20MIMO	5500	Type6	3	1	333.3	9	0.3333	300	5557	1
11ac20MIMO	5500	Type6	3	1	333.3	9	0.3333	300	5581	1
11ac20MIMO	5500	Type6	3	1	333.3	9	0.3333	300	5617	1
11ac20MIMO	5500	Type6	3	1	333.3	9	0.3333	300	5616	1
11ac20MIMO	5500	Type6	3	1	333.3	9	0.3333	300	5356	1
11ac20MIMO	5500	Type6	3	1	333.3	9	0.3333	300	5535	1
11ac20MIMO	5500	Type6	3	1	333.3	9	0.3333	300	5704	1
11ac20MIMO	5500	Type6	3	1	333.3	9	0.3333	300	5385	1



Unless otherwise agreed in writing, this document is issued by the Company subject to its General Conditions of Service printed overleaf, available on request or accessible at <http://www.sgs.com/en/Terms-and-Conditions.aspx> and, for electronic format documents, subject to Terms and Conditions for Electronic Documents at <http://www.sgs.com/en/Terms-and-Conditions/Terms-e-Document.aspx>. Attention is drawn to the limitation of liability, indemnification and jurisdiction issues defined therein. Any holder of this document is advised that information contained herein reflects the Company's findings at the time of its intervention only and within the limits of Client's instructions, if any. The Company's sole responsibility is to its Client and this document does not exonerate parties to a transaction from exercising all their rights and obligations under the transaction documents. This document cannot be reproduced except in full, without prior written approval of the Company. Any unauthorized alteration, forgery or falsification of the content or appearance of this document is unlawful and offenders may be prosecuted to the fullest extent of the law. Unless otherwise stated the results shown in this test report refer only to the sample(s) tested and such sample(s) are retained for 30 days only.

Attention: To check the authenticity of testing/inspection report & certificate, please contact us at telephone: (86-755) 8307 1443, or email: [CN.Doccheck@sgs.com](mailto:CN.Doccheck@sgs.com)

SGS-CSTC Standards Technical Services (Xi'an) Co., Ltd. | 1/F Unit D, Building 1, Kanglong Orange Science Park, No.137, Keyuan 3rd Road, Fengyang New Town, Xi'an, Shaanxi, China | 710086 | T (86-29) 6282 7885 | [www.sgs.com](http://www.sgs.com)  
 中国·西安·沣东新城科里三路137号康隆橙方科技园1号楼D单元1层 | 邮编: 710086 | T (86-29) 6282 7885 | [sgs.china@sgs.com](mailto:sgs.china@sgs.com)



11ac20MIMO	5500	Type6	3	1	333.3	9	0.3333	300	5420	1
11ac20MIMO	5500	Type6	3	1	333.3	9	0.3333	300	5338	1
11ac20MIMO	5500	Type6	3	1	333.3	9	0.3333	300	5518	1
11ac20MIMO	5500	Type6	3	1	333.3	9	0.3333	300	5350	1
11ac20MIMO	5500	Type6	3	1	333.3	9	0.3333	300	5415	1
11ac20MIMO	5500	Type6	3	1	333.3	9	0.3333	300	5651	1
11ac20MIMO	5500	Type6	3	1	333.3	9	0.3333	300	5313	1
11ac20MIMO	5500	Type6	3	1	333.3	9	0.3333	300	5447	1
11ac20MIMO	5500	Type6	3	1	333.3	9	0.3333	300	5605	1
11ac20MIMO	5500	Type6	3	1	333.3	9	0.3333	300	5520	1
11ac20MIMO	5500	Type6	3	1	333.3	9	0.3333	300	5653	1
11ac20MIMO	5500	Type6	3	1	333.3	9	0.3333	300	5563	1
11ac20MIMO	5500	Type6	3	1	333.3	9	0.3333	300	5519	1
11ac20MIMO	5500	Type6	3	1	333.3	9	0.3333	300	5257	1
11ac20MIMO	5500	Type6	3	1	333.3	9	0.3333	300	5476	1
11ac20MIMO	5500	Type6	3	1	333.3	9	0.3333	300	5330	1
11ac20MIMO	5500	Type6	3	1	333.3	9	0.3333	300	5598	1
11ac20MIMO	5500	Type6	3	1	333.3	9	0.3333	300	5506	1
11ac20MIMO	5500	Type6	3	1	333.3	9	0.3333	300	5515	1
11ac20MIMO	5500	Type6	3	1	333.3	9	0.3333	300	5366	1
11ac20MIMO	5500	Type6	3	1	333.3	9	0.3333	300	5443	1
11ac20MIMO	5500	Type6	3	1	333.3	9	0.3333	300	5661	1
11ac20MIMO	5500	Type6	3	1	333.3	9	0.3333	300	5533	1
11ac20MIMO	5500	Type6	3	1	333.3	9	0.3333	300	5367	1
11ac20MIMO	5500	Type6	3	1	333.3	9	0.3333	300	5358	1
11ac20MIMO	5500	Type6	3	1	333.3	9	0.3333	300	5502	1
11ac20MIMO	5500	Type6	3	1	333.3	9	0.3333	300	5606	1
11ac20MIMO	5500	Type6	3	1	333.3	9	0.3333	300	5347	1
11ac20MIMO	5500	Type6	3	1	333.3	9	0.3333	300	5647	1
11ac20MIMO	5500	Type6	3	1	333.3	9	0.3333	300	5266	1
11ac20MIMO	5500	Type6	3	1	333.3	9	0.3333	300	5411	1
11ac20MIMO	5500	Type6	3	1	333.3	9	0.3333	300	5451	1
11ac20MIMO	5500	Type6	3	1	333.3	9	0.3333	300	5334	1
11ac20MIMO	5500	Type6	3	1	333.3	9	0.3333	300	5332	1
11ac20MIMO	5500	Type6	3	1	333.3	9	0.3333	300	5709	1
11ac20MIMO	5500	Type6	3	1	333.3	9	0.3333	300	5667	1
11ac20MIMO	5500	Type6	3	1	333.3	9	0.3333	300	5394	1
11ac20MIMO	5500	Type6	3	1	333.3	9	0.3333	300	5684	1
11ac20MIMO	5500	Type6	3	1	333.3	9	0.3333	300	5539	1
11ac20MIMO	5500	Type6	3	1	333.3	9	0.3333	300	5464	1
11ac20MIMO	5500	Type6	3	1	333.3	9	0.3333	300	5437	1
11ac20MIMO	5500	Type6	3	1	333.3	9	0.3333	300	5665	1
11ac20MIMO	5500	Type6	3	1	333.3	9	0.3333	300	5389	1
11ac20MIMO	5500	Type6	3	1	333.3	9	0.3333	300	5421	1
11ac20MIMO	5500	Type6	3	1	333.3	9	0.3333	300	5416	1
11ac20MIMO	5500	Type6	3	1	333.3	9	0.3333	300	5574	1
11ac20MIMO	5500	Type6	3	1	333.3	9	0.3333	300	5488	1
11ac20MIMO	5500	Type6	3	1	333.3	9	0.3333	300	5536	1
11ac20MIMO	5500	Type6	3	1	333.3	9	0.3333	300	5580	1
11ac20MIMO	5500	Type6	3	1	333.3	9	0.3333	300	5279	1
11ac20MIMO	5500	Type6	3	1	333.3	9	0.3333	300	5439	1
11ac20MIMO	5500	Type6	3	1	333.3	9	0.3333	300	5324	1
11ac20MIMO	5500	Type6	3	1	333.3	9	0.3333	300	5499	1



Unless otherwise agreed in writing, this document is issued by the Company subject to its General Conditions of Service printed overleaf, available on request or accessible at <http://www.sgs.com/en/Terms-and-Conditions.aspx> and, for electronic format documents, subject to Terms and Conditions for Electronic Documents at <http://www.sgs.com/en/Terms-and-Conditions/Terms-e-Documents.aspx>. Attention is drawn to the limitation of liability, indemnification and jurisdiction issues defined therein. Any holder of this document is advised that information contained herein reflects the Company's findings at the time of its intervention only and within the limits of Client's instructions, if any. The Company's sole responsibility is to its Client and this document does not exonerate parties to a transaction from exercising all their rights and obligations under the transaction documents. This document cannot be reproduced except in full, without prior written approval of the Company. Any unauthorized alteration, forgery or falsification of the content or appearance of this document is unlawful and offenders may be prosecuted to the fullest extent of the law. Unless otherwise stated the results shown in this test report refer only to the sample(s) tested and such sample(s) are retained for 30 days only.

Attention: To check the authenticity of testing/inspection report & certificate, please contact us at telephone: (86-755) 8307 1443, or email: [CN.Doccheck@sgs.com](mailto:CN.Doccheck@sgs.com)

SGS-CSTC Standards Technical Services (Xi'an) Co., Ltd. | 1/F, Unit D, Building 1, Kanglong Orange Science Park, No.157, Keyuan3rd Road, Fengyang New Town, Xian, Shaanxi, China | 710086 | t: (86-29) 6282 7885 | www.sgs.com.cn  
 中国·西安·沣东新城科里三路157号康鸿橙方科技园1号楼D单元1层 | 邮编: 710086 | t: (86-29) 6282 7885 | sgs.china@sgs.com

Report No.: XEWA2310000070RG05

Rev.: 01

Page: 111 of 267

11ac20MIMO	5500	Type6	3	1	333.3	9	0.3333	300	5710	1
11ac20MIMO	5500	Type6	3	1	333.3	9	0.3333	300	5708	1
11ac20MIMO	5500	Type6	3	1	333.3	9	0.3333	300	5404	1
11ac20MIMO	5500	Type6	3	1	333.3	9	0.3333	300	5305	1
11ac20MIMO	5500	Type6	3	1	333.3	9	0.3333	300	5295	1
11ac20MIMO	5500	Type6	3	1	333.3	9	0.3333	300	5525	1
11ac20MIMO	5500	Type6	3	1	333.3	9	0.3333	300	5589	1
11ac20MIMO	5500	Type6	3	1	333.3	9	0.3333	300	5359	1
11ac20MIMO	5500	Type6	3	1	333.3	9	0.3333	300	5452	1
11ac20MIMO	5500	Type6	3	1	333.3	9	0.3333	300	5576	1
11ac20MIMO	5500	Type6	3	1	333.3	9	0.3333	300	5272	1
11ac20MIMO	5500	Type6	3	1	333.3	9	0.3333	300	5492	1
11ac20MIMO	5500	Type6	3	1	333.3	9	0.3333	300	5388	1
11ac20MIMO	5500	Type6	3	1	333.3	9	0.3333	300	5551	1
11ac20MIMO	5500	Type6	3	1	333.3	9	0.3333	300	5547	1
11ac20MIMO	5500	Type6	3	1	333.3	9	0.3333	300	5323	1
11ac20MIMO	5500	Type6	3	1	333.3	9	0.3333	300	5724	1
11ac20MIMO	5500	Type6	3	1	333.3	9	0.3333	300	5256	1
11ac20MIMO	5500	Type6	3	1	333.3	9	0.3333	300	5721	1
11ac20MIMO	5500	Type6	3	1	333.3	9	0.3333	300	5293	1
11ac20MIMO	5500	Type6	3	1	333.3	9	0.3333	300	5379	1
11ac20MIMO	5500	Type6	3	1	333.3	9	0.3333	300	5584	1
11ac20MIMO	5500	Type6	3	1	333.3	9	0.3333	300	5361	1
11ac20MIMO	5500	Type6	3	1	333.3	9	0.3333	300	5508	1
11ac20MIMO	5500	Type6	3	1	333.3	9	0.3333	300	5479	1
11ac20MIMO	5500	Type6	3	1	333.3	9	0.3333	300	5693	1
11ac20MIMO	5500	Type6	3	1	333.3	9	0.3333	300	5341	1
11ac20MIMO	5500	Type6	3	1	333.3	9	0.3333	300	5655	1
11ac20MIMO	5500	Type6	3	1	333.3	9	0.3333	300	5715	1
11ac20MIMO	5500	Type6	3	1	333.3	9	0.3333	300	5629	1
11ac20MIMO	5500	Type6	3	1	333.3	9	0.3333	300	5494	1
11ac20MIMO	5500	Type6	3	1	333.3	9	0.3333	300	5401	1
11ac20MIMO	5500	Type6	3	1	333.3	9	0.3333	300	5637	1
11ac20MIMO	5500	Type6	3	1	333.3	9	0.3333	300	5423	1
11ac20MIMO	5500	Type6	3	1	333.3	9	0.3333	300	5280	1
11ac20MIMO	5500	Type6	3	1	333.3	9	0.3333	300	5316	1
11ac20MIMO	5500	Type6	3	1	333.3	9	0.3333	300	5662	1
11ac20MIMO	5500	Type6	3	1	333.3	9	0.3333	300	5281	1
11ac20MIMO	5500	Type6	3	1	333.3	9	0.3333	300	5649	1



Unless otherwise agreed in writing, this document is issued by the Company subject to its General Conditions of Service printed overleaf, available on request or accessible at <http://www.sgs.com/en/Terms-and-Conditions.aspx> and, for electronic format documents, subject to Terms and Conditions for Electronic Documents at <http://www.sgs.com/en/Terms-and-Conditions/Terms-e-Documents.aspx>. Attention is drawn to the limitation of liability, indemnification and jurisdiction issues defined therein. Any holder of this document is advised that information contained herein reflects the Company's findings at the time of its intervention only and within the limits of Client's instructions, if any. The Company's sole responsibility is to its Client and this document does not exonerate parties to a transaction from exercising all their rights and obligations under the transaction documents. This document cannot be reproduced except in full, without prior written approval of the Company. Any unauthorized alteration, forgery or falsification of the content or appearance of this document is unlawful and offenders may be prosecuted to the fullest extent of the law. Unless otherwise stated the results shown in this test report refer only to the sample(s) tested and such sample(s) are retained for 30 days only.

Attention: To check the authenticity of testing/inspection report & certificate, please contact us at telephone: (86-755) 8307 1443, or email: [CN.Doccheck@sgs.com](mailto:CN.Doccheck@sgs.com)

SGS-CSTC Standards Technical Services (Xi'an) Co., Ltd.  
 (Xi'an) (China)

1/E Unit D, Building 1, Kanglong Orange Source Park, No.137, Keyuan 3rd Road, Fengling New Town, Xi'an, Shaanxi, China 710086  
 中国·西安·沣东新城科里三路137号康隆橙方科技园1号楼D单元1层 邮编: 710086

t (86-29) 6282 7885 www.sgs.com.cn  
 t (86-29) 6282 7885 sgs.china@sgs.com

TestMode	Channel	Radar Type	Trial ID	Pulse width (μs)	PRI (μs)	Pulses per Hop	Hop Rate (kHz)	Hop Sequence Length(ms)	Center Frequency (MHz)	Detection (1: Yes; 0: No)
11ac80MIMO	5530	Type6	4	1	333.3	9	0.3333	300	5337	1
11ac80MIMO	5530	Type6	4	1	333.3	9	0.3333	300	5345	1
11ac80MIMO	5530	Type6	4	1	333.3	9	0.3333	300	5553	1
11ac80MIMO	5530	Type6	4	1	333.3	9	0.3333	300	5302	1
11ac80MIMO	5530	Type6	4	1	333.3	9	0.3333	300	5673	1
11ac80MIMO	5530	Type6	4	1	333.3	9	0.3333	300	5577	1
11ac80MIMO	5530	Type6	4	1	333.3	9	0.3333	300	5629	1
11ac80MIMO	5530	Type6	4	1	333.3	9	0.3333	300	5460	1
11ac80MIMO	5530	Type6	4	1	333.3	9	0.3333	300	5583	1
11ac80MIMO	5530	Type6	4	1	333.3	9	0.3333	300	5642	1
11ac80MIMO	5530	Type6	4	1	333.3	9	0.3333	300	5352	1
11ac80MIMO	5530	Type6	4	1	333.3	9	0.3333	300	5614	1
11ac80MIMO	5530	Type6	4	1	333.3	9	0.3333	300	5456	1
11ac80MIMO	5530	Type6	4	1	333.3	9	0.3333	300	5655	1
11ac80MIMO	5530	Type6	4	1	333.3	9	0.3333	300	5672	1
11ac80MIMO	5530	Type6	4	1	333.3	9	0.3333	300	5401	1
11ac80MIMO	5530	Type6	4	1	333.3	9	0.3333	300	5574	1
11ac80MIMO	5530	Type6	4	1	333.3	9	0.3333	300	5611	1
11ac80MIMO	5530	Type6	4	1	333.3	9	0.3333	300	5565	1
11ac80MIMO	5530	Type6	4	1	333.3	9	0.3333	300	5370	1
11ac80MIMO	5530	Type6	4	1	333.3	9	0.3333	300	5571	1
11ac80MIMO	5530	Type6	4	1	333.3	9	0.3333	300	5588	1
11ac80MIMO	5530	Type6	4	1	333.3	9	0.3333	300	5295	1
11ac80MIMO	5530	Type6	4	1	333.3	9	0.3333	300	5468	1
11ac80MIMO	5530	Type6	4	1	333.3	9	0.3333	300	5303	1
11ac80MIMO	5530	Type6	4	1	333.3	9	0.3333	300	5486	1
11ac80MIMO	5530	Type6	4	1	333.3	9	0.3333	300	5358	1
11ac80MIMO	5530	Type6	4	1	333.3	9	0.3333	300	5718	1
11ac80MIMO	5530	Type6	4	1	333.3	9	0.3333	300	5470	1
11ac80MIMO	5530	Type6	4	1	333.3	9	0.3333	300	5380	1
11ac80MIMO	5530	Type6	4	1	333.3	9	0.3333	300	5703	1
11ac80MIMO	5530	Type6	4	1	333.3	9	0.3333	300	5422	1
11ac80MIMO	5530	Type6	4	1	333.3	9	0.3333	300	5324	1
11ac80MIMO	5530	Type6	4	1	333.3	9	0.3333	300	5573	1
11ac80MIMO	5530	Type6	4	1	333.3	9	0.3333	300	5654	1
11ac80MIMO	5530	Type6	4	1	333.3	9	0.3333	300	5426	1
11ac80MIMO	5530	Type6	4	1	333.3	9	0.3333	300	5263	1
11ac80MIMO	5530	Type6	4	1	333.3	9	0.3333	300	5634	1
11ac80MIMO	5530	Type6	4	1	333.3	9	0.3333	300	5661	1
11ac80MIMO	5530	Type6	4	1	333.3	9	0.3333	300	5462	1
11ac80MIMO	5530	Type6	4	1	333.3	9	0.3333	300	5648	1
11ac80MIMO	5530	Type6	4	1	333.3	9	0.3333	300	5498	1
11ac80MIMO	5530	Type6	4	1	333.3	9	0.3333	300	5270	1
11ac80MIMO	5530	Type6	4	1	333.3	9	0.3333	300	5474	1
11ac80MIMO	5530	Type6	4	1	333.3	9	0.3333	300	5664	1
11ac80MIMO	5530	Type6	4	1	333.3	9	0.3333	300	5701	1
11ac80MIMO	5530	Type6	4	1	333.3	9	0.3333	300	5622	1
11ac80MIMO	5530	Type6	4	1	333.3	9	0.3333	300	5425	1
11ac80MIMO	5530	Type6	4	1	333.3	9	0.3333	300	5490	1



Unless otherwise agreed in writing, this document is issued by the Company subject to its General Conditions of Service printed overleaf, available on request or accessible at <http://www.sgs.com/en/Terms-and-Conditions.aspx> and, for electronic format documents, subject to Terms and Conditions for Electronic Documents at <http://www.sgs.com/en/Terms-and-Conditions/Terms-e-Documents.aspx>. Attention is drawn to the limitation of liability, indemnification and jurisdiction issues defined therein. Any holder of this document is advised that information contained herein reflects the Company's findings at the time of its intervention only and within the limits of Client's instructions, if any. The Company's sole responsibility is to its Client and this document does not exonerate parties to a transaction from exercising all their rights and obligations under the transaction documents. This document cannot be reproduced except in full, without prior written approval of the Company. Any unauthorized alteration, forgery or falsification of the content or appearance of this document is unlawful and offenders may be prosecuted to the fullest extent of the law. Unless otherwise stated the results shown in this test report refer only to the sample(s) tested and such sample(s) are retained for 30 days only.

Attention: To check the authenticity of testing/inspection report & certificate, please contact us at telephone: (86-755) 8307 1443, or email: [CN.Doccheck@sgs.com](mailto:CN.Doccheck@sgs.com)

SGS-CSTC Standards Technical Services (Xi'an) Co., Ltd. | 1/E Unit D, Building 1, Kanglong Orange Science Park, No.157, Keyuan3rd Road, Fengjing/Yue Town, Xi'an, Shaanxi, China | 710086 | t (86-29) 6282 7885 | www.sgs.com.cn  
 中国·西安·沣东新城科里三路157号康隆橙方科技园1号楼D单元1层 | 邮编: 710086 | t (86-29) 6282 7885 | sgs.china@sgs.com





11ac80MIMO	5530	Type6	4	1	333.3	9	0.3333	300	5552	1
11ac80MIMO	5530	Type6	4	1	333.3	9	0.3333	300	5265	1
11ac80MIMO	5530	Type6	4	1	333.3	9	0.3333	300	5597	1
11ac80MIMO	5530	Type6	4	1	333.3	9	0.3333	300	5467	1
11ac80MIMO	5530	Type6	4	1	333.3	9	0.3333	300	5300	1
11ac80MIMO	5530	Type6	4	1	333.3	9	0.3333	300	5432	1
11ac80MIMO	5530	Type6	4	1	333.3	9	0.3333	300	5724	1
11ac80MIMO	5530	Type6	4	1	333.3	9	0.3333	300	5437	1
11ac80MIMO	5530	Type6	4	1	333.3	9	0.3333	300	5469	1
11ac80MIMO	5530	Type6	4	1	333.3	9	0.3333	300	5258	1
11ac80MIMO	5530	Type6	4	1	333.3	9	0.3333	300	5715	1
11ac80MIMO	5530	Type6	4	1	333.3	9	0.3333	300	5453	1
11ac80MIMO	5530	Type6	4	1	333.3	9	0.3333	300	5277	1
11ac80MIMO	5530	Type6	4	1	333.3	9	0.3333	300	5637	1
11ac80MIMO	5530	Type6	4	1	333.3	9	0.3333	300	5705	1
11ac80MIMO	5530	Type6	4	1	333.3	9	0.3333	300	5348	1
11ac80MIMO	5530	Type6	4	1	333.3	9	0.3333	300	5593	1
11ac80MIMO	5530	Type6	4	1	333.3	9	0.3333	300	5262	1
11ac80MIMO	5530	Type6	4	1	333.3	9	0.3333	300	5561	1
11ac80MIMO	5530	Type6	4	1	333.3	9	0.3333	300	5251	1
11ac80MIMO	5530	Type6	4	1	333.3	9	0.3333	300	5255	1
11ac80MIMO	5530	Type6	4	1	333.3	9	0.3333	300	5275	1
11ac80MIMO	5530	Type6	4	1	333.3	9	0.3333	300	5341	1
11ac80MIMO	5530	Type6	4	1	333.3	9	0.3333	300	5364	1
11ac80MIMO	5530	Type6	4	1	333.3	9	0.3333	300	5510	1
11ac80MIMO	5530	Type6	4	1	333.3	9	0.3333	300	5516	1
11ac80MIMO	5530	Type6	4	1	333.3	9	0.3333	300	5346	1
11ac80MIMO	5530	Type6	4	1	333.3	9	0.3333	300	5712	1
11ac80MIMO	5530	Type6	4	1	333.3	9	0.3333	300	5504	1
11ac80MIMO	5530	Type6	4	1	333.3	9	0.3333	300	5549	1
11ac80MIMO	5530	Type6	4	1	333.3	9	0.3333	300	5356	1
11ac80MIMO	5530	Type6	4	1	333.3	9	0.3333	300	5527	1
11ac80MIMO	5530	Type6	4	1	333.3	9	0.3333	300	5376	1
11ac80MIMO	5530	Type6	4	1	333.3	9	0.3333	300	5264	1
11ac80MIMO	5530	Type6	4	1	333.3	9	0.3333	300	5447	1
11ac80MIMO	5530	Type6	4	1	333.3	9	0.3333	300	5442	1
11ac80MIMO	5530	Type6	4	1	333.3	9	0.3333	300	5454	1
11ac80MIMO	5530	Type6	4	1	333.3	9	0.3333	300	5658	1
11ac80MIMO	5530	Type6	4	1	333.3	9	0.3333	300	5428	1
11ac80MIMO	5530	Type6	4	1	333.3	9	0.3333	300	5544	1
11ac80MIMO	5530	Type6	4	1	333.3	9	0.3333	300	5374	1
11ac80MIMO	5530	Type6	4	1	333.3	9	0.3333	300	5343	1
11ac80MIMO	5530	Type6	4	1	333.3	9	0.3333	300	5663	1
11ac80MIMO	5530	Type6	4	1	333.3	9	0.3333	300	5478	1
11ac80MIMO	5530	Type6	4	1	333.3	9	0.3333	300	5689	1
11ac80MIMO	5530	Type6	4	1	333.3	9	0.3333	300	5384	1
11ac80MIMO	5530	Type6	4	1	333.3	9	0.3333	300	5372	1
11ac80MIMO	5530	Type6	4	1	333.3	9	0.3333	300	5707	1
11ac80MIMO	5530	Type6	4	1	333.3	9	0.3333	300	5274	1
11ac80MIMO	5530	Type6	4	1	333.3	9	0.3333	300	5292	1
11ac80MIMO	5530	Type6	4	1	333.3	9	0.3333	300	5466	1
11ac40MIMO	5510	Type6	4	1	333.3	9	0.3333	300	5337	1
11ac40MIMO	5510	Type6	4	1	333.3	9	0.3333	300	5345	1



Unless otherwise agreed in writing, this document is issued by the Company subject to its General Conditions of Service printed overleaf, available on request or accessible at <http://www.sgs.com/en/Terms-and-Conditions.aspx> and, for electronic format documents, subject to Terms and Conditions for Electronic Documents at <http://www.sgs.com/en/Terms-and-Conditions/Terms-e-Documents.aspx>. Attention is drawn to the limitation of liability, indemnification and jurisdiction issues defined therein. Any holder of this document is advised that information contained herein reflects the Company's findings at the time of its intervention only and within the limits of Client's instructions, if any. The Company's sole responsibility is to its Client and this document does not exonerate parties to a transaction from exercising all their rights and obligations under the transaction documents. This document cannot be reproduced except in full, without prior written approval of the Company. Any unauthorized alteration, forgery or falsification of the content or appearance of this document is unlawful and offenders may be prosecuted to the fullest extent of the law. Unless otherwise stated the results shown in this test report refer only to the sample(s) tested and such sample(s) are retained for 30 days only.

Attention: To check the authenticity of testing/inspection report & certificate, please contact us at telephone: (86-755) 8307 1443, or email: [CN.Doccheck@sgs.com](mailto:CN.Doccheck@sgs.com)  
 (E) Unit D, Building 1, Kanglong Orange Science Park, No.157, Keyuan 3rd Road, Fengjing/Yue Town, Xian, Shaanxi, China 710086  
 t (86-29) 6282 7885 www.sgs.com.cn  
 中国·西安·沣东新城科里三路157号康隆橙方科技园1号楼D单元1层 邮编: 710086 t (86-29) 6282 7885 sgs.china@sgs.com

11ac40MIMO	5510	Type6	4	1	333.3	9	0.3333	300	5553	1
11ac40MIMO	5510	Type6	4	1	333.3	9	0.3333	300	5302	1
11ac40MIMO	5510	Type6	4	1	333.3	9	0.3333	300	5673	1
11ac40MIMO	5510	Type6	4	1	333.3	9	0.3333	300	5577	1
11ac40MIMO	5510	Type6	4	1	333.3	9	0.3333	300	5629	1
11ac40MIMO	5510	Type6	4	1	333.3	9	0.3333	300	5460	1
11ac40MIMO	5510	Type6	4	1	333.3	9	0.3333	300	5583	1
11ac40MIMO	5510	Type6	4	1	333.3	9	0.3333	300	5642	1
11ac40MIMO	5510	Type6	4	1	333.3	9	0.3333	300	5352	1
11ac40MIMO	5510	Type6	4	1	333.3	9	0.3333	300	5614	1
11ac40MIMO	5510	Type6	4	1	333.3	9	0.3333	300	5456	1
11ac40MIMO	5510	Type6	4	1	333.3	9	0.3333	300	5655	1
11ac40MIMO	5510	Type6	4	1	333.3	9	0.3333	300	5672	1
11ac40MIMO	5510	Type6	4	1	333.3	9	0.3333	300	5401	1
11ac40MIMO	5510	Type6	4	1	333.3	9	0.3333	300	5574	1
11ac40MIMO	5510	Type6	4	1	333.3	9	0.3333	300	5611	1
11ac40MIMO	5510	Type6	4	1	333.3	9	0.3333	300	5565	1
11ac40MIMO	5510	Type6	4	1	333.3	9	0.3333	300	5370	1
11ac40MIMO	5510	Type6	4	1	333.3	9	0.3333	300	5571	1
11ac40MIMO	5510	Type6	4	1	333.3	9	0.3333	300	5588	1
11ac40MIMO	5510	Type6	4	1	333.3	9	0.3333	300	5295	1
11ac40MIMO	5510	Type6	4	1	333.3	9	0.3333	300	5468	1
11ac40MIMO	5510	Type6	4	1	333.3	9	0.3333	300	5303	1
11ac40MIMO	5510	Type6	4	1	333.3	9	0.3333	300	5486	1
11ac40MIMO	5510	Type6	4	1	333.3	9	0.3333	300	5358	1
11ac40MIMO	5510	Type6	4	1	333.3	9	0.3333	300	5718	1
11ac40MIMO	5510	Type6	4	1	333.3	9	0.3333	300	5470	1
11ac40MIMO	5510	Type6	4	1	333.3	9	0.3333	300	5380	1
11ac40MIMO	5510	Type6	4	1	333.3	9	0.3333	300	5703	1
11ac40MIMO	5510	Type6	4	1	333.3	9	0.3333	300	5422	1
11ac40MIMO	5510	Type6	4	1	333.3	9	0.3333	300	5324	1
11ac40MIMO	5510	Type6	4	1	333.3	9	0.3333	300	5573	1
11ac40MIMO	5510	Type6	4	1	333.3	9	0.3333	300	5654	1
11ac40MIMO	5510	Type6	4	1	333.3	9	0.3333	300	5426	1
11ac40MIMO	5510	Type6	4	1	333.3	9	0.3333	300	5263	1
11ac40MIMO	5510	Type6	4	1	333.3	9	0.3333	300	5634	1
11ac40MIMO	5510	Type6	4	1	333.3	9	0.3333	300	5661	1
11ac40MIMO	5510	Type6	4	1	333.3	9	0.3333	300	5462	1
11ac40MIMO	5510	Type6	4	1	333.3	9	0.3333	300	5648	1
11ac40MIMO	5510	Type6	4	1	333.3	9	0.3333	300	5498	1
11ac40MIMO	5510	Type6	4	1	333.3	9	0.3333	300	5270	1
11ac40MIMO	5510	Type6	4	1	333.3	9	0.3333	300	5474	1
11ac40MIMO	5510	Type6	4	1	333.3	9	0.3333	300	5664	1
11ac40MIMO	5510	Type6	4	1	333.3	9	0.3333	300	5701	1
11ac40MIMO	5510	Type6	4	1	333.3	9	0.3333	300	5622	1
11ac40MIMO	5510	Type6	4	1	333.3	9	0.3333	300	5425	1
11ac40MIMO	5510	Type6	4	1	333.3	9	0.3333	300	5490	1
11ac40MIMO	5510	Type6	4	1	333.3	9	0.3333	300	5552	1
11ac40MIMO	5510	Type6	4	1	333.3	9	0.3333	300	5265	1
11ac40MIMO	5510	Type6	4	1	333.3	9	0.3333	300	5597	1
11ac40MIMO	5510	Type6	4	1	333.3	9	0.3333	300	5467	1
11ac40MIMO	5510	Type6	4	1	333.3	9	0.3333	300	5300	1
11ac40MIMO	5510	Type6	4	1	333.3	9	0.3333	300	5432	1



Unless otherwise agreed in writing, this document is issued by the Company subject to its General Conditions of Service printed overleaf, available on request or accessible at <http://www.sgs.com/en/Terms-and-Conditions.aspx> and, for electronic format documents, subject to Terms and Conditions for Electronic Documents at <http://www.sgs.com/en/Terms-and-Conditions/Terms-e-Document.aspx>. Attention is drawn to the limitation of liability, indemnification and jurisdiction issues defined therein. Any holder of this document is advised that information contained herein reflects the Company's findings at the time of its intervention only and within the limits of Client's instructions, if any. The Company's sole responsibility is to its Client and this document does not exonerate parties to a transaction from exercising all their rights and obligations under the transaction documents. This document cannot be reproduced except in full, without prior written approval of the Company. Any unauthorized alteration, forgery or falsification of the content or appearance of this document is unlawful and offenders may be prosecuted to the fullest extent of the law. Unless otherwise stated the results shown in this test report refer only to the sample(s) tested and such sample(s) are retained for 30 days only.

Attention: To check the authenticity of testing/inspection report & certificate, please contact us at telephone: (86-755) 8307 1443, or email: [CN.Doccheck@sgs.com](mailto:CN.Doccheck@sgs.com)  
 (E) Unit D, Building 1, Kanglong Orange Science Park, No.157, Keyuan 3rd Road, Fengjing/Yue Town, Xian, Shaanxi, China 710086  
 t (86-29) 6282 7885 www.sgs.com.cn  
 中国·西安·沣东新城科里三路157号康隆橙方科技园1号楼D单元1层 邮编: 710086 t (86-29) 6282 7885 sgs.china@sgs.com



11ac40MIMO	5510	Type6	4	1	333.3	9	0.3333	300	5724	1
11ac40MIMO	5510	Type6	4	1	333.3	9	0.3333	300	5437	1
11ac40MIMO	5510	Type6	4	1	333.3	9	0.3333	300	5469	1
11ac40MIMO	5510	Type6	4	1	333.3	9	0.3333	300	5258	1
11ac40MIMO	5510	Type6	4	1	333.3	9	0.3333	300	5715	1
11ac40MIMO	5510	Type6	4	1	333.3	9	0.3333	300	5453	1
11ac40MIMO	5510	Type6	4	1	333.3	9	0.3333	300	5277	1
11ac40MIMO	5510	Type6	4	1	333.3	9	0.3333	300	5637	1
11ac40MIMO	5510	Type6	4	1	333.3	9	0.3333	300	5705	1
11ac40MIMO	5510	Type6	4	1	333.3	9	0.3333	300	5348	1
11ac40MIMO	5510	Type6	4	1	333.3	9	0.3333	300	5593	1
11ac40MIMO	5510	Type6	4	1	333.3	9	0.3333	300	5262	1
11ac40MIMO	5510	Type6	4	1	333.3	9	0.3333	300	5561	1
11ac40MIMO	5510	Type6	4	1	333.3	9	0.3333	300	5251	1
11ac40MIMO	5510	Type6	4	1	333.3	9	0.3333	300	5255	1
11ac40MIMO	5510	Type6	4	1	333.3	9	0.3333	300	5275	1
11ac40MIMO	5510	Type6	4	1	333.3	9	0.3333	300	5341	1
11ac40MIMO	5510	Type6	4	1	333.3	9	0.3333	300	5364	1
11ac40MIMO	5510	Type6	4	1	333.3	9	0.3333	300	5510	1
11ac40MIMO	5510	Type6	4	1	333.3	9	0.3333	300	5516	1
11ac40MIMO	5510	Type6	4	1	333.3	9	0.3333	300	5346	1
11ac40MIMO	5510	Type6	4	1	333.3	9	0.3333	300	5712	1
11ac40MIMO	5510	Type6	4	1	333.3	9	0.3333	300	5504	1
11ac40MIMO	5510	Type6	4	1	333.3	9	0.3333	300	5549	1
11ac40MIMO	5510	Type6	4	1	333.3	9	0.3333	300	5356	1
11ac40MIMO	5510	Type6	4	1	333.3	9	0.3333	300	5527	1
11ac40MIMO	5510	Type6	4	1	333.3	9	0.3333	300	5376	1
11ac40MIMO	5510	Type6	4	1	333.3	9	0.3333	300	5264	1
11ac40MIMO	5510	Type6	4	1	333.3	9	0.3333	300	5447	1
11ac40MIMO	5510	Type6	4	1	333.3	9	0.3333	300	5442	1
11ac40MIMO	5510	Type6	4	1	333.3	9	0.3333	300	5454	1
11ac40MIMO	5510	Type6	4	1	333.3	9	0.3333	300	5658	1
11ac40MIMO	5510	Type6	4	1	333.3	9	0.3333	300	5428	1
11ac40MIMO	5510	Type6	4	1	333.3	9	0.3333	300	5544	1
11ac40MIMO	5510	Type6	4	1	333.3	9	0.3333	300	5374	1
11ac40MIMO	5510	Type6	4	1	333.3	9	0.3333	300	5343	1
11ac40MIMO	5510	Type6	4	1	333.3	9	0.3333	300	5663	1
11ac40MIMO	5510	Type6	4	1	333.3	9	0.3333	300	5478	1
11ac40MIMO	5510	Type6	4	1	333.3	9	0.3333	300	5689	1
11ac40MIMO	5510	Type6	4	1	333.3	9	0.3333	300	5384	1
11ac40MIMO	5510	Type6	4	1	333.3	9	0.3333	300	5372	1
11ac40MIMO	5510	Type6	4	1	333.3	9	0.3333	300	5707	1
11ac40MIMO	5510	Type6	4	1	333.3	9	0.3333	300	5274	1
11ac40MIMO	5510	Type6	4	1	333.3	9	0.3333	300	5292	1
11ac40MIMO	5510	Type6	4	1	333.3	9	0.3333	300	5466	1
11ac20MIMO	5500	Type6	4	1	333.3	9	0.3333	300	5337	1
11ac20MIMO	5500	Type6	4	1	333.3	9	0.3333	300	5345	1
11ac20MIMO	5500	Type6	4	1	333.3	9	0.3333	300	5553	1
11ac20MIMO	5500	Type6	4	1	333.3	9	0.3333	300	5302	1
11ac20MIMO	5500	Type6	4	1	333.3	9	0.3333	300	5673	1
11ac20MIMO	5500	Type6	4	1	333.3	9	0.3333	300	5577	1
11ac20MIMO	5500	Type6	4	1	333.3	9	0.3333	300	5629	1
11ac20MIMO	5500	Type6	4	1	333.3	9	0.3333	300	5460	1



Unless otherwise agreed in writing, this document is issued by the Company subject to its General Conditions of Service printed overleaf, available on request or accessible at <http://www.sgs.com/en/Terms-and-Conditions.aspx> and, for electronic format documents, subject to Terms and Conditions for Electronic Documents at <http://www.sgs.com/en/Terms-and-Conditions/Terms-e-Documents.aspx>. Attention is drawn to the limitation of liability, indemnification and jurisdiction issues defined therein. Any holder of this document is advised that information contained herein reflects the Company's findings at the time of its intervention only and within the limits of Client's instructions, if any. The Company's sole responsibility is to its Client and this document does not exonerate parties to a transaction from exercising all their rights and obligations under the transaction documents. This document cannot be reproduced except in full, without prior written approval of the Company. Any unauthorized alteration, forgery or falsification of the content or appearance of this document is unlawful and offenders may be prosecuted to the fullest extent of the law. Unless otherwise stated the results shown in this test report refer only to the sample(s) tested and such sample(s) are retained for 30 days only.

Attention: To check the authenticity of testing/inspection report & certificate, please contact us at telephone: (86-755) 8307 1443, or email: [CN.Doccheck@sgs.com](mailto:CN.Doccheck@sgs.com)  
 (E) Unit D, Building 1, Kanglong Orange Science Park, No.157, Keyuan 3rd Road, Fengyang New Town, Xi'an, Shaanxi, China 710086  
 t (86-29) 6282 7885 www.sgs.com.cn  
 中国·西安·沣东新城科里三路157号康隆橙方科技园1号楼D单元1层 邮编: 710086 t (86-29) 6282 7885 sgs.china@sgs.com

11ac20MIMO	5500	Type6	4	1	333.3	9	0.3333	300	5583	1
11ac20MIMO	5500	Type6	4	1	333.3	9	0.3333	300	5642	1
11ac20MIMO	5500	Type6	4	1	333.3	9	0.3333	300	5352	1
11ac20MIMO	5500	Type6	4	1	333.3	9	0.3333	300	5614	1
11ac20MIMO	5500	Type6	4	1	333.3	9	0.3333	300	5456	1
11ac20MIMO	5500	Type6	4	1	333.3	9	0.3333	300	5655	1
11ac20MIMO	5500	Type6	4	1	333.3	9	0.3333	300	5672	1
11ac20MIMO	5500	Type6	4	1	333.3	9	0.3333	300	5401	1
11ac20MIMO	5500	Type6	4	1	333.3	9	0.3333	300	5574	1
11ac20MIMO	5500	Type6	4	1	333.3	9	0.3333	300	5611	1
11ac20MIMO	5500	Type6	4	1	333.3	9	0.3333	300	5565	1
11ac20MIMO	5500	Type6	4	1	333.3	9	0.3333	300	5370	1
11ac20MIMO	5500	Type6	4	1	333.3	9	0.3333	300	5571	1
11ac20MIMO	5500	Type6	4	1	333.3	9	0.3333	300	5588	1
11ac20MIMO	5500	Type6	4	1	333.3	9	0.3333	300	5295	1
11ac20MIMO	5500	Type6	4	1	333.3	9	0.3333	300	5468	1
11ac20MIMO	5500	Type6	4	1	333.3	9	0.3333	300	5303	1
11ac20MIMO	5500	Type6	4	1	333.3	9	0.3333	300	5486	1
11ac20MIMO	5500	Type6	4	1	333.3	9	0.3333	300	5358	1
11ac20MIMO	5500	Type6	4	1	333.3	9	0.3333	300	5718	1
11ac20MIMO	5500	Type6	4	1	333.3	9	0.3333	300	5470	1
11ac20MIMO	5500	Type6	4	1	333.3	9	0.3333	300	5380	1
11ac20MIMO	5500	Type6	4	1	333.3	9	0.3333	300	5703	1
11ac20MIMO	5500	Type6	4	1	333.3	9	0.3333	300	5422	1
11ac20MIMO	5500	Type6	4	1	333.3	9	0.3333	300	5324	1
11ac20MIMO	5500	Type6	4	1	333.3	9	0.3333	300	5573	1
11ac20MIMO	5500	Type6	4	1	333.3	9	0.3333	300	5654	1
11ac20MIMO	5500	Type6	4	1	333.3	9	0.3333	300	5426	1
11ac20MIMO	5500	Type6	4	1	333.3	9	0.3333	300	5263	1
11ac20MIMO	5500	Type6	4	1	333.3	9	0.3333	300	5634	1
11ac20MIMO	5500	Type6	4	1	333.3	9	0.3333	300	5661	1
11ac20MIMO	5500	Type6	4	1	333.3	9	0.3333	300	5462	1
11ac20MIMO	5500	Type6	4	1	333.3	9	0.3333	300	5648	1
11ac20MIMO	5500	Type6	4	1	333.3	9	0.3333	300	5498	1
11ac20MIMO	5500	Type6	4	1	333.3	9	0.3333	300	5270	1
11ac20MIMO	5500	Type6	4	1	333.3	9	0.3333	300	5474	1
11ac20MIMO	5500	Type6	4	1	333.3	9	0.3333	300	5664	1
11ac20MIMO	5500	Type6	4	1	333.3	9	0.3333	300	5701	1
11ac20MIMO	5500	Type6	4	1	333.3	9	0.3333	300	5622	1
11ac20MIMO	5500	Type6	4	1	333.3	9	0.3333	300	5425	1
11ac20MIMO	5500	Type6	4	1	333.3	9	0.3333	300	5490	1
11ac20MIMO	5500	Type6	4	1	333.3	9	0.3333	300	5552	1
11ac20MIMO	5500	Type6	4	1	333.3	9	0.3333	300	5265	1
11ac20MIMO	5500	Type6	4	1	333.3	9	0.3333	300	5597	1
11ac20MIMO	5500	Type6	4	1	333.3	9	0.3333	300	5467	1
11ac20MIMO	5500	Type6	4	1	333.3	9	0.3333	300	5300	1
11ac20MIMO	5500	Type6	4	1	333.3	9	0.3333	300	5432	1
11ac20MIMO	5500	Type6	4	1	333.3	9	0.3333	300	5724	1
11ac20MIMO	5500	Type6	4	1	333.3	9	0.3333	300	5437	1
11ac20MIMO	5500	Type6	4	1	333.3	9	0.3333	300	5469	1
11ac20MIMO	5500	Type6	4	1	333.3	9	0.3333	300	5258	1
11ac20MIMO	5500	Type6	4	1	333.3	9	0.3333	300	5715	1
11ac20MIMO	5500	Type6	4	1	333.3	9	0.3333	300	5453	1



Unless otherwise agreed in writing, this document is issued by the Company subject to its General Conditions of Service printed overleaf, available on request or accessible at <http://www.sgs.com/en/Terms-and-Conditions.aspx> and, for electronic format documents, subject to Terms and Conditions for Electronic Documents at <http://www.sgs.com/en/Terms-and-Conditions/Terms-e-Documents.aspx>. Attention is drawn to the limitation of liability, indemnification and jurisdiction issues defined therein. Any holder of this document is advised that information contained herein reflects the Company's findings at the time of its intervention only and within the limits of Client's instructions, if any. The Company's sole responsibility is to its Client and this document does not exonerate parties to a transaction from exercising all their rights and obligations under the transaction documents. This document cannot be reproduced except in full, without prior written approval of the Company. Any unauthorized alteration, forgery or falsification of the content or appearance of this document is unlawful and offenders may be prosecuted to the fullest extent of the law. Unless otherwise stated the results shown in this test report refer only to the sample(s) tested and such sample(s) are retained for 30 days only.

Attention: To check the authenticity of testing/inspection report & certificate, please contact us at telephone: (86-755) 8307 1443, or email: [CN.Doccheck@sgs.com](mailto:CN.Doccheck@sgs.com)

SGS-CSTC Standards Technical Services (Xi'an) Co., Ltd. | U/E Unit D, Building 1, Kanglong Orange Science Park, No.137, Keyuan 3rd Road, Fengyang New Town, Xi'an, Shaanxi, China | 710086 | T (86-29) 6282 7885 | [www.sgs.com](http://www.sgs.com)  
 中国·西安·沣东新城科里三路137号康隆橙方科技园1号楼D单元1层 | 邮编: 710086 | T (86-29) 6282 7885 | [sgs.china@sgs.com](mailto:sgs.china@sgs.com)

Report No.: XEWA2310000070RG05

Rev.: 01

Page: 117 of 267

11ac20MIMO	5500	Type6	4	1	333.3	9	0.3333	300	5277	1
11ac20MIMO	5500	Type6	4	1	333.3	9	0.3333	300	5637	1
11ac20MIMO	5500	Type6	4	1	333.3	9	0.3333	300	5705	1
11ac20MIMO	5500	Type6	4	1	333.3	9	0.3333	300	5348	1
11ac20MIMO	5500	Type6	4	1	333.3	9	0.3333	300	5593	1
11ac20MIMO	5500	Type6	4	1	333.3	9	0.3333	300	5262	1
11ac20MIMO	5500	Type6	4	1	333.3	9	0.3333	300	5561	1
11ac20MIMO	5500	Type6	4	1	333.3	9	0.3333	300	5251	1
11ac20MIMO	5500	Type6	4	1	333.3	9	0.3333	300	5255	1
11ac20MIMO	5500	Type6	4	1	333.3	9	0.3333	300	5275	1
11ac20MIMO	5500	Type6	4	1	333.3	9	0.3333	300	5341	1
11ac20MIMO	5500	Type6	4	1	333.3	9	0.3333	300	5364	1
11ac20MIMO	5500	Type6	4	1	333.3	9	0.3333	300	5510	1
11ac20MIMO	5500	Type6	4	1	333.3	9	0.3333	300	5516	1
11ac20MIMO	5500	Type6	4	1	333.3	9	0.3333	300	5346	1
11ac20MIMO	5500	Type6	4	1	333.3	9	0.3333	300	5712	1
11ac20MIMO	5500	Type6	4	1	333.3	9	0.3333	300	5504	1
11ac20MIMO	5500	Type6	4	1	333.3	9	0.3333	300	5549	1
11ac20MIMO	5500	Type6	4	1	333.3	9	0.3333	300	5356	1
11ac20MIMO	5500	Type6	4	1	333.3	9	0.3333	300	5527	1
11ac20MIMO	5500	Type6	4	1	333.3	9	0.3333	300	5376	1
11ac20MIMO	5500	Type6	4	1	333.3	9	0.3333	300	5264	1
11ac20MIMO	5500	Type6	4	1	333.3	9	0.3333	300	5447	1
11ac20MIMO	5500	Type6	4	1	333.3	9	0.3333	300	5442	1
11ac20MIMO	5500	Type6	4	1	333.3	9	0.3333	300	5454	1
11ac20MIMO	5500	Type6	4	1	333.3	9	0.3333	300	5658	1
11ac20MIMO	5500	Type6	4	1	333.3	9	0.3333	300	5428	1
11ac20MIMO	5500	Type6	4	1	333.3	9	0.3333	300	5544	1
11ac20MIMO	5500	Type6	4	1	333.3	9	0.3333	300	5374	1
11ac20MIMO	5500	Type6	4	1	333.3	9	0.3333	300	5343	1
11ac20MIMO	5500	Type6	4	1	333.3	9	0.3333	300	5663	1
11ac20MIMO	5500	Type6	4	1	333.3	9	0.3333	300	5478	1
11ac20MIMO	5500	Type6	4	1	333.3	9	0.3333	300	5689	1
11ac20MIMO	5500	Type6	4	1	333.3	9	0.3333	300	5384	1
11ac20MIMO	5500	Type6	4	1	333.3	9	0.3333	300	5372	1
11ac20MIMO	5500	Type6	4	1	333.3	9	0.3333	300	5707	1
11ac20MIMO	5500	Type6	4	1	333.3	9	0.3333	300	5274	1
11ac20MIMO	5500	Type6	4	1	333.3	9	0.3333	300	5292	1
11ac20MIMO	5500	Type6	4	1	333.3	9	0.3333	300	5466	1



Unless otherwise agreed in writing, this document is issued by the Company subject to its General Conditions of Service printed overleaf, available on request or accessible at <http://www.sgs.com/en/Terms-and-Conditions.aspx> and, for electronic format documents, subject to Terms and Conditions for Electronic Documents at <http://www.sgs.com/en/Terms-and-Conditions/Terms-e-Documents.aspx>. Attention is drawn to the limitation of liability, indemnification and jurisdiction issues defined therein. Any holder of this document is advised that information contained herein reflects the Company's findings at the time of its intervention only and within the limits of Client's instructions, if any. The Company's sole responsibility is to its Client and this document does not exonerate parties to a transaction from exercising all their rights and obligations under the transaction documents. This document cannot be reproduced except in full, without prior written approval of the Company. Any unauthorized alteration, forgery or falsification of the content or appearance of this document is unlawful and offenders may be prosecuted to the fullest extent of the law. Unless otherwise stated the results shown in this test report refer only to the sample(s) tested and such sample(s) are retained for 30 days only.

Attention: To check the authenticity of testing/inspection report & certificate, please contact us at telephone: (86-755) 4307 1443, or email: [CN.Doccheck@sgs.com](mailto:CN.Doccheck@sgs.com)  
 (SGS-CSTC) Standards Technical Services (Xi'an) Co., Ltd. | 1 (86-29) 6282 7885 | [www.sgs.com.cn](http://www.sgs.com.cn)  
 中国·西安·沣东新城科星三路137号康鸿楼方科技园1号楼D单元1层 | 邮编: 710086 | 1 (86-29) 6282 7885 | [sgs.china@sgs.com](mailto:sgs.china@sgs.com)

TestMode	Channel	Radar Type	Trial ID	Pulse width (μs)	PRI (μs)	Pulses per Hop	Hop Rate (kHz)	Hop Sequence Length(ms)	Center Frequency (MHz)	Detection (1: Yes; 0: No)
11ac80MIMO	5530	Type6	5	1	333.3	9	0.3333	300	5592	1
11ac80MIMO	5530	Type6	5	1	333.3	9	0.3333	300	5584	1
11ac80MIMO	5530	Type6	5	1	333.3	9	0.3333	300	5489	1
11ac80MIMO	5530	Type6	5	1	333.3	9	0.3333	300	5463	1
11ac80MIMO	5530	Type6	5	1	333.3	9	0.3333	300	5418	1
11ac80MIMO	5530	Type6	5	1	333.3	9	0.3333	300	5619	1
11ac80MIMO	5530	Type6	5	1	333.3	9	0.3333	300	5651	1
11ac80MIMO	5530	Type6	5	1	333.3	9	0.3333	300	5535	1
11ac80MIMO	5530	Type6	5	1	333.3	9	0.3333	300	5271	1
11ac80MIMO	5530	Type6	5	1	333.3	9	0.3333	300	5374	1
11ac80MIMO	5530	Type6	5	1	333.3	9	0.3333	300	5283	1
11ac80MIMO	5530	Type6	5	1	333.3	9	0.3333	300	5500	1
11ac80MIMO	5530	Type6	5	1	333.3	9	0.3333	300	5594	1
11ac80MIMO	5530	Type6	5	1	333.3	9	0.3333	300	5375	1
11ac80MIMO	5530	Type6	5	1	333.3	9	0.3333	300	5693	1
11ac80MIMO	5530	Type6	5	1	333.3	9	0.3333	300	5604	1
11ac80MIMO	5530	Type6	5	1	333.3	9	0.3333	300	5714	1
11ac80MIMO	5530	Type6	5	1	333.3	9	0.3333	300	5610	1
11ac80MIMO	5530	Type6	5	1	333.3	9	0.3333	300	5562	1
11ac80MIMO	5530	Type6	5	1	333.3	9	0.3333	300	5482	1
11ac80MIMO	5530	Type6	5	1	333.3	9	0.3333	300	5279	1
11ac80MIMO	5530	Type6	5	1	333.3	9	0.3333	300	5711	1
11ac80MIMO	5530	Type6	5	1	333.3	9	0.3333	300	5557	1
11ac80MIMO	5530	Type6	5	1	333.3	9	0.3333	300	5276	1
11ac80MIMO	5530	Type6	5	1	333.3	9	0.3333	300	5277	1
11ac80MIMO	5530	Type6	5	1	333.3	9	0.3333	300	5307	1
11ac80MIMO	5530	Type6	5	1	333.3	9	0.3333	300	5446	1
11ac80MIMO	5530	Type6	5	1	333.3	9	0.3333	300	5574	1
11ac80MIMO	5530	Type6	5	1	333.3	9	0.3333	300	5414	1
11ac80MIMO	5530	Type6	5	1	333.3	9	0.3333	300	5270	1
11ac80MIMO	5530	Type6	5	1	333.3	9	0.3333	300	5408	1
11ac80MIMO	5530	Type6	5	1	333.3	9	0.3333	300	5281	1
11ac80MIMO	5530	Type6	5	1	333.3	9	0.3333	300	5691	1
11ac80MIMO	5530	Type6	5	1	333.3	9	0.3333	300	5428	1
11ac80MIMO	5530	Type6	5	1	333.3	9	0.3333	300	5624	1
11ac80MIMO	5530	Type6	5	1	333.3	9	0.3333	300	5625	1
11ac80MIMO	5530	Type6	5	1	333.3	9	0.3333	300	5354	1
11ac80MIMO	5530	Type6	5	1	333.3	9	0.3333	300	5430	1
11ac80MIMO	5530	Type6	5	1	333.3	9	0.3333	300	5339	1
11ac80MIMO	5530	Type6	5	1	333.3	9	0.3333	300	5376	1
11ac80MIMO	5530	Type6	5	1	333.3	9	0.3333	300	5487	1
11ac80MIMO	5530	Type6	5	1	333.3	9	0.3333	300	5581	1
11ac80MIMO	5530	Type6	5	1	333.3	9	0.3333	300	5683	1
11ac80MIMO	5530	Type6	5	1	333.3	9	0.3333	300	5617	1
11ac80MIMO	5530	Type6	5	1	333.3	9	0.3333	300	5630	1
11ac80MIMO	5530	Type6	5	1	333.3	9	0.3333	300	5644	1
11ac80MIMO	5530	Type6	5	1	333.3	9	0.3333	300	5705	1
11ac80MIMO	5530	Type6	5	1	333.3	9	0.3333	300	5483	1
11ac80MIMO	5530	Type6	5	1	333.3	9	0.3333	300	5342	1



Unless otherwise agreed in writing, this document is issued by the Company subject to its General Conditions of Service printed overleaf, available on request or accessible at <http://www.sgs.com/en/Terms-and-Conditions.aspx> and, for electronic format documents, subject to Terms and Conditions for Electronic Documents at <http://www.sgs.com/en/Terms-and-Conditions/Terms-e-Documents.aspx>. Attention is drawn to the limitation of liability, indemnification and jurisdiction issues defined therein. Any holder of this document is advised that information contained herein reflects the Company's findings at the time of its intervention only and within the limits of Client's instructions, if any. The Company's sole responsibility is to its Client and this document does not exonerate parties to a transaction from exercising all their rights and obligations under the transaction documents. This document cannot be reproduced except in full, without prior written approval of the Company. Any unauthorized alteration, forgery or falsification of the content or appearance of this document is unlawful and offenders may be prosecuted to the fullest extent of the law. Unless otherwise stated the results shown in this test report refer only to the sample(s) tested and such sample(s) are retained for 30 days only.

Attention: To check the authenticity of testing/inspection report & certificate, please contact us at telephone: (86-755) 8307 1443, or email: [CN.Doccheck@sgs.com](mailto:CN.Doccheck@sgs.com)

SGS-CSTC Standards Technical Services (Xi'an) Co., Ltd. | 1/E Unit D, Building 1, Kanglong Orange Science Park, No.157, Keyuan 3rd Road, Fengjing/Yue Town, Xi'an, Shaanxi, China | 710086 | t (86-29) 6282 7885 | www.sgs.com.cn  
 中国·西安·沣东新城科里三路157号康隆橙方科技园1号楼D单元1层 | 邮编: 710086 | t (86-29) 6282 7885 | sgs.china@sgs.com

11ac80MIMO	5530	Type6	5	1	333.3	9	0.3333	300	5519	1
11ac80MIMO	5530	Type6	5	1	333.3	9	0.3333	300	5298	1
11ac80MIMO	5530	Type6	5	1	333.3	9	0.3333	300	5518	1
11ac80MIMO	5530	Type6	5	1	333.3	9	0.3333	300	5563	1
11ac80MIMO	5530	Type6	5	1	333.3	9	0.3333	300	5598	1
11ac80MIMO	5530	Type6	5	1	333.3	9	0.3333	300	5437	1
11ac80MIMO	5530	Type6	5	1	333.3	9	0.3333	300	5391	1
11ac80MIMO	5530	Type6	5	1	333.3	9	0.3333	300	5659	1
11ac80MIMO	5530	Type6	5	1	333.3	9	0.3333	300	5455	1
11ac80MIMO	5530	Type6	5	1	333.3	9	0.3333	300	5686	1
11ac80MIMO	5530	Type6	5	1	333.3	9	0.3333	300	5582	1
11ac80MIMO	5530	Type6	5	1	333.3	9	0.3333	300	5697	1
11ac80MIMO	5530	Type6	5	1	333.3	9	0.3333	300	5469	1
11ac80MIMO	5530	Type6	5	1	333.3	9	0.3333	300	5628	1
11ac80MIMO	5530	Type6	5	1	333.3	9	0.3333	300	5294	1
11ac80MIMO	5530	Type6	5	1	333.3	9	0.3333	300	5319	1
11ac80MIMO	5530	Type6	5	1	333.3	9	0.3333	300	5597	1
11ac80MIMO	5530	Type6	5	1	333.3	9	0.3333	300	5631	1
11ac80MIMO	5530	Type6	5	1	333.3	9	0.3333	300	5521	1
11ac80MIMO	5530	Type6	5	1	333.3	9	0.3333	300	5436	1
11ac80MIMO	5530	Type6	5	1	333.3	9	0.3333	300	5423	1
11ac80MIMO	5530	Type6	5	1	333.3	9	0.3333	300	5278	1
11ac80MIMO	5530	Type6	5	1	333.3	9	0.3333	300	5665	1
11ac80MIMO	5530	Type6	5	1	333.3	9	0.3333	300	5340	1
11ac80MIMO	5530	Type6	5	1	333.3	9	0.3333	300	5485	1
11ac80MIMO	5530	Type6	5	1	333.3	9	0.3333	300	5466	1
11ac80MIMO	5530	Type6	5	1	333.3	9	0.3333	300	5438	1
11ac80MIMO	5530	Type6	5	1	333.3	9	0.3333	300	5315	1
11ac80MIMO	5530	Type6	5	1	333.3	9	0.3333	300	5275	1
11ac80MIMO	5530	Type6	5	1	333.3	9	0.3333	300	5614	1
11ac80MIMO	5530	Type6	5	1	333.3	9	0.3333	300	5330	1
11ac80MIMO	5530	Type6	5	1	333.3	9	0.3333	300	5520	1
11ac80MIMO	5530	Type6	5	1	333.3	9	0.3333	300	5590	1
11ac80MIMO	5530	Type6	5	1	333.3	9	0.3333	300	5596	1
11ac80MIMO	5530	Type6	5	1	333.3	9	0.3333	300	5264	1
11ac80MIMO	5530	Type6	5	1	333.3	9	0.3333	300	5289	1
11ac80MIMO	5530	Type6	5	1	333.3	9	0.3333	300	5405	1
11ac80MIMO	5530	Type6	5	1	333.3	9	0.3333	300	5646	1
11ac80MIMO	5530	Type6	5	1	333.3	9	0.3333	300	5526	1
11ac80MIMO	5530	Type6	5	1	333.3	9	0.3333	300	5346	1
11ac80MIMO	5530	Type6	5	1	333.3	9	0.3333	300	5676	1
11ac80MIMO	5530	Type6	5	1	333.3	9	0.3333	300	5267	1
11ac80MIMO	5530	Type6	5	1	333.3	9	0.3333	300	5539	1
11ac80MIMO	5530	Type6	5	1	333.3	9	0.3333	300	5349	1
11ac80MIMO	5530	Type6	5	1	333.3	9	0.3333	300	5600	1
11ac80MIMO	5530	Type6	5	1	333.3	9	0.3333	300	5258	1
11ac80MIMO	5530	Type6	5	1	333.3	9	0.3333	300	5671	1
11ac80MIMO	5530	Type6	5	1	333.3	9	0.3333	300	5533	1
11ac80MIMO	5530	Type6	5	1	333.3	9	0.3333	300	5345	1
11ac80MIMO	5530	Type6	5	1	333.3	9	0.3333	300	5587	1
11ac80MIMO	5530	Type6	5	1	333.3	9	0.3333	300	5523	1
11ac40MIMO	5510	Type6	5	1	333.3	9	0.3333	300	5592	1
11ac40MIMO	5510	Type6	5	1	333.3	9	0.3333	300	5584	1



Unless otherwise agreed in writing, this document is issued by the Company subject to its General Conditions of Service printed overleaf, available on request or accessible at <http://www.sgs.com/en/Terms-and-Conditions.aspx> and, for electronic format documents, subject to Terms and Conditions for Electronic Documents at <http://www.sgs.com/en/Terms-and-Conditions/Terms-e-Documents.aspx>. Attention is drawn to the limitation of liability, indemnification and jurisdiction issues defined therein. Any holder of this document is advised that information contained herein reflects the Company's findings at the time of its intervention only and within the limits of Client's instructions, if any. The Company's sole responsibility is to its Client and this document does not exonerate parties to a transaction from exercising all their rights and obligations under the transaction documents. This document cannot be reproduced except in full, without prior written approval of the Company. Any unauthorized alteration, forgery or falsification of the content or appearance of this document is unlawful and offenders may be prosecuted to the fullest extent of the law. Unless otherwise stated the results shown in this test report refer only to the sample(s) tested and such sample(s) are retained for 30 days only.

Attention: To check the authenticity of testing/inspection report & certificate, please contact us at telephone: (86-755) 8307 1443, or email: [CN.Doccheck@sgs.com](mailto:CN.Doccheck@sgs.com)

SGS-CSTC Standards Technical Services (Xi'an) Co., Ltd. | 1/F, Unit D, Building 1, Kanglong Orange Science Park, No.157, Keyuan 3rd Road, Fengyang New Town, Xi'an, Shaanxi, China | 710086 | t: (86-29) 6282 7885 | www.sgs.com.cn  
 中国·西安·沣东新城科里三路157号康隆橙方科技园1号楼D单元1层 | 邮编: 710086 | t: (86-29) 6282 7885 | sgs.china@sgs.com

11ac40MIMO	5510	Type6	5	1	333.3	9	0.3333	300	5489	1
11ac40MIMO	5510	Type6	5	1	333.3	9	0.3333	300	5463	1
11ac40MIMO	5510	Type6	5	1	333.3	9	0.3333	300	5418	1
11ac40MIMO	5510	Type6	5	1	333.3	9	0.3333	300	5619	1
11ac40MIMO	5510	Type6	5	1	333.3	9	0.3333	300	5651	1
11ac40MIMO	5510	Type6	5	1	333.3	9	0.3333	300	5535	1
11ac40MIMO	5510	Type6	5	1	333.3	9	0.3333	300	5271	1
11ac40MIMO	5510	Type6	5	1	333.3	9	0.3333	300	5374	1
11ac40MIMO	5510	Type6	5	1	333.3	9	0.3333	300	5283	1
11ac40MIMO	5510	Type6	5	1	333.3	9	0.3333	300	5500	1
11ac40MIMO	5510	Type6	5	1	333.3	9	0.3333	300	5594	1
11ac40MIMO	5510	Type6	5	1	333.3	9	0.3333	300	5375	1
11ac40MIMO	5510	Type6	5	1	333.3	9	0.3333	300	5693	1
11ac40MIMO	5510	Type6	5	1	333.3	9	0.3333	300	5604	1
11ac40MIMO	5510	Type6	5	1	333.3	9	0.3333	300	5714	1
11ac40MIMO	5510	Type6	5	1	333.3	9	0.3333	300	5610	1
11ac40MIMO	5510	Type6	5	1	333.3	9	0.3333	300	5562	1
11ac40MIMO	5510	Type6	5	1	333.3	9	0.3333	300	5482	1
11ac40MIMO	5510	Type6	5	1	333.3	9	0.3333	300	5279	1
11ac40MIMO	5510	Type6	5	1	333.3	9	0.3333	300	5711	1
11ac40MIMO	5510	Type6	5	1	333.3	9	0.3333	300	5557	1
11ac40MIMO	5510	Type6	5	1	333.3	9	0.3333	300	5276	1
11ac40MIMO	5510	Type6	5	1	333.3	9	0.3333	300	5277	1
11ac40MIMO	5510	Type6	5	1	333.3	9	0.3333	300	5307	1
11ac40MIMO	5510	Type6	5	1	333.3	9	0.3333	300	5446	1
11ac40MIMO	5510	Type6	5	1	333.3	9	0.3333	300	5574	1
11ac40MIMO	5510	Type6	5	1	333.3	9	0.3333	300	5414	1
11ac40MIMO	5510	Type6	5	1	333.3	9	0.3333	300	5270	1
11ac40MIMO	5510	Type6	5	1	333.3	9	0.3333	300	5408	1
11ac40MIMO	5510	Type6	5	1	333.3	9	0.3333	300	5281	1
11ac40MIMO	5510	Type6	5	1	333.3	9	0.3333	300	5691	1
11ac40MIMO	5510	Type6	5	1	333.3	9	0.3333	300	5428	1
11ac40MIMO	5510	Type6	5	1	333.3	9	0.3333	300	5624	1
11ac40MIMO	5510	Type6	5	1	333.3	9	0.3333	300	5625	1
11ac40MIMO	5510	Type6	5	1	333.3	9	0.3333	300	5354	1
11ac40MIMO	5510	Type6	5	1	333.3	9	0.3333	300	5430	1
11ac40MIMO	5510	Type6	5	1	333.3	9	0.3333	300	5339	1
11ac40MIMO	5510	Type6	5	1	333.3	9	0.3333	300	5376	1
11ac40MIMO	5510	Type6	5	1	333.3	9	0.3333	300	5487	1
11ac40MIMO	5510	Type6	5	1	333.3	9	0.3333	300	5581	1
11ac40MIMO	5510	Type6	5	1	333.3	9	0.3333	300	5683	1
11ac40MIMO	5510	Type6	5	1	333.3	9	0.3333	300	5617	1
11ac40MIMO	5510	Type6	5	1	333.3	9	0.3333	300	5630	1
11ac40MIMO	5510	Type6	5	1	333.3	9	0.3333	300	5644	1
11ac40MIMO	5510	Type6	5	1	333.3	9	0.3333	300	5705	1
11ac40MIMO	5510	Type6	5	1	333.3	9	0.3333	300	5483	1
11ac40MIMO	5510	Type6	5	1	333.3	9	0.3333	300	5342	1
11ac40MIMO	5510	Type6	5	1	333.3	9	0.3333	300	5519	1
11ac40MIMO	5510	Type6	5	1	333.3	9	0.3333	300	5298	1
11ac40MIMO	5510	Type6	5	1	333.3	9	0.3333	300	5518	1
11ac40MIMO	5510	Type6	5	1	333.3	9	0.3333	300	5563	1
11ac40MIMO	5510	Type6	5	1	333.3	9	0.3333	300	5598	1
11ac40MIMO	5510	Type6	5	1	333.3	9	0.3333	300	5437	1



Unless otherwise agreed in writing, this document is issued by the Company subject to its General Conditions of Service printed overleaf, available on request or accessible at <http://www.sgs.com/en/Terms-and-Conditions.aspx> and, for electronic format documents, subject to Terms and Conditions for Electronic Documents at <http://www.sgs.com/en/Terms-and-Conditions/Terms-e-Document.aspx>. Attention is drawn to the limitation of liability, indemnification and jurisdiction issues defined therein. Any holder of this document is advised that information contained herein reflects the Company's findings at the time of its intervention only and within the limits of Client's instructions, if any. The Company's sole responsibility is to its Client and this document does not exonerate parties to a transaction from exercising all their rights and obligations under the transaction documents. This document cannot be reproduced except in full, without prior written approval of the Company. Any unauthorized alteration, forgery or falsification of the content or appearance of this document is unlawful and offenders may be prosecuted to the fullest extent of the law. Unless otherwise stated the results shown in this test report refer only to the sample(s) tested and such sample(s) are retained for 30 days only.

Attention: To check the authenticity of testing/inspection report & certificate, please contact us at telephone: (86-755) 8307 1443, or email: [CN.Doccheck@sgs.com](mailto:CN.Doccheck@sgs.com)  
 (E) Unit D, Building 1, Kanglong Orange Science Park, No.157, Keyuan 3rd Road, Fengjing/Yue Town, Xian, Shaanxi, China 710086  
 t (86-29) 6282 7885 www.sgs.com.cn  
 中国·西安·沣东新城科里三路157号康隆橙方科技园1号楼D单元1层 邮编: 710086 t (86-29) 6282 7885 sgs.china@sgs.com



11ac40MIMO	5510	Type6	5	1	333.3	9	0.3333	300	5391	1
11ac40MIMO	5510	Type6	5	1	333.3	9	0.3333	300	5659	1
11ac40MIMO	5510	Type6	5	1	333.3	9	0.3333	300	5455	1
11ac40MIMO	5510	Type6	5	1	333.3	9	0.3333	300	5686	1
11ac40MIMO	5510	Type6	5	1	333.3	9	0.3333	300	5582	1
11ac40MIMO	5510	Type6	5	1	333.3	9	0.3333	300	5697	1
11ac40MIMO	5510	Type6	5	1	333.3	9	0.3333	300	5469	1
11ac40MIMO	5510	Type6	5	1	333.3	9	0.3333	300	5628	1
11ac40MIMO	5510	Type6	5	1	333.3	9	0.3333	300	5294	1
11ac40MIMO	5510	Type6	5	1	333.3	9	0.3333	300	5319	1
11ac40MIMO	5510	Type6	5	1	333.3	9	0.3333	300	5597	1
11ac40MIMO	5510	Type6	5	1	333.3	9	0.3333	300	5631	1
11ac40MIMO	5510	Type6	5	1	333.3	9	0.3333	300	5521	1
11ac40MIMO	5510	Type6	5	1	333.3	9	0.3333	300	5436	1
11ac40MIMO	5510	Type6	5	1	333.3	9	0.3333	300	5423	1
11ac40MIMO	5510	Type6	5	1	333.3	9	0.3333	300	5278	1
11ac40MIMO	5510	Type6	5	1	333.3	9	0.3333	300	5665	1
11ac40MIMO	5510	Type6	5	1	333.3	9	0.3333	300	5340	1
11ac40MIMO	5510	Type6	5	1	333.3	9	0.3333	300	5485	1
11ac40MIMO	5510	Type6	5	1	333.3	9	0.3333	300	5466	1
11ac40MIMO	5510	Type6	5	1	333.3	9	0.3333	300	5438	1
11ac40MIMO	5510	Type6	5	1	333.3	9	0.3333	300	5315	1
11ac40MIMO	5510	Type6	5	1	333.3	9	0.3333	300	5275	1
11ac40MIMO	5510	Type6	5	1	333.3	9	0.3333	300	5614	1
11ac40MIMO	5510	Type6	5	1	333.3	9	0.3333	300	5330	1
11ac40MIMO	5510	Type6	5	1	333.3	9	0.3333	300	5520	1
11ac40MIMO	5510	Type6	5	1	333.3	9	0.3333	300	5590	1
11ac40MIMO	5510	Type6	5	1	333.3	9	0.3333	300	5596	1
11ac40MIMO	5510	Type6	5	1	333.3	9	0.3333	300	5264	1
11ac40MIMO	5510	Type6	5	1	333.3	9	0.3333	300	5289	1
11ac40MIMO	5510	Type6	5	1	333.3	9	0.3333	300	5405	1
11ac40MIMO	5510	Type6	5	1	333.3	9	0.3333	300	5646	1
11ac40MIMO	5510	Type6	5	1	333.3	9	0.3333	300	5526	1
11ac40MIMO	5510	Type6	5	1	333.3	9	0.3333	300	5346	1
11ac40MIMO	5510	Type6	5	1	333.3	9	0.3333	300	5676	1
11ac40MIMO	5510	Type6	5	1	333.3	9	0.3333	300	5267	1
11ac40MIMO	5510	Type6	5	1	333.3	9	0.3333	300	5539	1
11ac40MIMO	5510	Type6	5	1	333.3	9	0.3333	300	5349	1
11ac40MIMO	5510	Type6	5	1	333.3	9	0.3333	300	5600	1
11ac40MIMO	5510	Type6	5	1	333.3	9	0.3333	300	5258	1
11ac40MIMO	5510	Type6	5	1	333.3	9	0.3333	300	5671	1
11ac40MIMO	5510	Type6	5	1	333.3	9	0.3333	300	5533	1
11ac40MIMO	5510	Type6	5	1	333.3	9	0.3333	300	5345	1
11ac40MIMO	5510	Type6	5	1	333.3	9	0.3333	300	5587	1
11ac40MIMO	5510	Type6	5	1	333.3	9	0.3333	300	5523	1
11ac20MIMO	5500	Type6	5	1	333.3	9	0.3333	300	5592	1
11ac20MIMO	5500	Type6	5	1	333.3	9	0.3333	300	5584	1
11ac20MIMO	5500	Type6	5	1	333.3	9	0.3333	300	5489	1
11ac20MIMO	5500	Type6	5	1	333.3	9	0.3333	300	5463	1
11ac20MIMO	5500	Type6	5	1	333.3	9	0.3333	300	5418	1
11ac20MIMO	5500	Type6	5	1	333.3	9	0.3333	300	5619	1
11ac20MIMO	5500	Type6	5	1	333.3	9	0.3333	300	5651	1
11ac20MIMO	5500	Type6	5	1	333.3	9	0.3333	300	5535	1



Unless otherwise agreed in writing, this document is issued by the Company subject to its General Conditions of Service printed overleaf, available on request or accessible at <http://www.sgs.com/en/Terms-and-Conditions.aspx> and, for electronic format documents, subject to Terms and Conditions for Electronic Documents at <http://www.sgs.com/en/Terms-and-Conditions/Terms-e-Document.aspx>. Attention is drawn to the limitation of liability, indemnification and jurisdiction issues defined therein. Any holder of this document is advised that information contained herein reflects the Company's findings at the time of its intervention only and within the limits of Client's instructions, if any. The Company's sole responsibility is to its Client and this document does not exonerate parties to a transaction from exercising all their rights and obligations under the transaction documents. This document cannot be reproduced except in full, without prior written approval of the Company. Any unauthorized alteration, forgery or falsification of the content or appearance of this document is unlawful and offenders may be prosecuted to the fullest extent of the law. Unless otherwise stated the results shown in this test report refer only to the sample(s) tested and such sample(s) are retained for 30 days only.

Attention: To check the authenticity of testing/inspection report & certificate, please contact us at telephone: (86-755) 8307 1443, or email: [CN.Doccheck@sgs.com](mailto:CN.Doccheck@sgs.com)  
 1/E Unit D, Building 1, Kanglong Orange Science Park, No.157, Keyuan 3rd Road, Fengyang New Town, Xi'an, Shaanxi, China 710086  
 t (86-29) 6282 7885 www.sgs.com.cn  
 中国·西安·沣东新城科里三路157号康隆橙方科技园1号楼D单元1层 邮编: 710086 t (86-29) 6282 7885 sgs.china@sgs.com

11ac20MIMO	5500	Type6	5	1	333.3	9	0.3333	300	5271	1
11ac20MIMO	5500	Type6	5	1	333.3	9	0.3333	300	5374	1
11ac20MIMO	5500	Type6	5	1	333.3	9	0.3333	300	5283	1
11ac20MIMO	5500	Type6	5	1	333.3	9	0.3333	300	5500	1
11ac20MIMO	5500	Type6	5	1	333.3	9	0.3333	300	5594	1
11ac20MIMO	5500	Type6	5	1	333.3	9	0.3333	300	5375	1
11ac20MIMO	5500	Type6	5	1	333.3	9	0.3333	300	5693	1
11ac20MIMO	5500	Type6	5	1	333.3	9	0.3333	300	5604	1
11ac20MIMO	5500	Type6	5	1	333.3	9	0.3333	300	5714	1
11ac20MIMO	5500	Type6	5	1	333.3	9	0.3333	300	5610	1
11ac20MIMO	5500	Type6	5	1	333.3	9	0.3333	300	5562	1
11ac20MIMO	5500	Type6	5	1	333.3	9	0.3333	300	5482	1
11ac20MIMO	5500	Type6	5	1	333.3	9	0.3333	300	5279	1
11ac20MIMO	5500	Type6	5	1	333.3	9	0.3333	300	5711	1
11ac20MIMO	5500	Type6	5	1	333.3	9	0.3333	300	5557	1
11ac20MIMO	5500	Type6	5	1	333.3	9	0.3333	300	5276	1
11ac20MIMO	5500	Type6	5	1	333.3	9	0.3333	300	5277	1
11ac20MIMO	5500	Type6	5	1	333.3	9	0.3333	300	5307	1
11ac20MIMO	5500	Type6	5	1	333.3	9	0.3333	300	5446	1
11ac20MIMO	5500	Type6	5	1	333.3	9	0.3333	300	5574	1
11ac20MIMO	5500	Type6	5	1	333.3	9	0.3333	300	5414	1
11ac20MIMO	5500	Type6	5	1	333.3	9	0.3333	300	5270	1
11ac20MIMO	5500	Type6	5	1	333.3	9	0.3333	300	5408	1
11ac20MIMO	5500	Type6	5	1	333.3	9	0.3333	300	5281	1
11ac20MIMO	5500	Type6	5	1	333.3	9	0.3333	300	5691	1
11ac20MIMO	5500	Type6	5	1	333.3	9	0.3333	300	5428	1
11ac20MIMO	5500	Type6	5	1	333.3	9	0.3333	300	5624	1
11ac20MIMO	5500	Type6	5	1	333.3	9	0.3333	300	5625	1
11ac20MIMO	5500	Type6	5	1	333.3	9	0.3333	300	5354	1
11ac20MIMO	5500	Type6	5	1	333.3	9	0.3333	300	5430	1
11ac20MIMO	5500	Type6	5	1	333.3	9	0.3333	300	5339	1
11ac20MIMO	5500	Type6	5	1	333.3	9	0.3333	300	5376	1
11ac20MIMO	5500	Type6	5	1	333.3	9	0.3333	300	5487	1
11ac20MIMO	5500	Type6	5	1	333.3	9	0.3333	300	5581	1
11ac20MIMO	5500	Type6	5	1	333.3	9	0.3333	300	5683	1
11ac20MIMO	5500	Type6	5	1	333.3	9	0.3333	300	5617	1
11ac20MIMO	5500	Type6	5	1	333.3	9	0.3333	300	5630	1
11ac20MIMO	5500	Type6	5	1	333.3	9	0.3333	300	5644	1
11ac20MIMO	5500	Type6	5	1	333.3	9	0.3333	300	5705	1
11ac20MIMO	5500	Type6	5	1	333.3	9	0.3333	300	5483	1
11ac20MIMO	5500	Type6	5	1	333.3	9	0.3333	300	5342	1
11ac20MIMO	5500	Type6	5	1	333.3	9	0.3333	300	5519	1
11ac20MIMO	5500	Type6	5	1	333.3	9	0.3333	300	5298	1
11ac20MIMO	5500	Type6	5	1	333.3	9	0.3333	300	5518	1
11ac20MIMO	5500	Type6	5	1	333.3	9	0.3333	300	5563	1
11ac20MIMO	5500	Type6	5	1	333.3	9	0.3333	300	5598	1
11ac20MIMO	5500	Type6	5	1	333.3	9	0.3333	300	5437	1
11ac20MIMO	5500	Type6	5	1	333.3	9	0.3333	300	5391	1
11ac20MIMO	5500	Type6	5	1	333.3	9	0.3333	300	5659	1
11ac20MIMO	5500	Type6	5	1	333.3	9	0.3333	300	5455	1
11ac20MIMO	5500	Type6	5	1	333.3	9	0.3333	300	5686	1
11ac20MIMO	5500	Type6	5	1	333.3	9	0.3333	300	5582	1
11ac20MIMO	5500	Type6	5	1	333.3	9	0.3333	300	5697	1



Unless otherwise agreed in writing, this document is issued by the Company subject to its General Conditions of Service printed overleaf, available on request or accessible at <http://www.sgs.com/en/Terms-and-Conditions.aspx> and, for electronic format documents, subject to Terms and Conditions for Electronic Documents at <http://www.sgs.com/en/Terms-and-Conditions/Terms-e-Documents.aspx>. Attention is drawn to the limitation of liability, indemnification and jurisdiction issues defined therein. Any holder of this document is advised that information contained herein reflects the Company's findings at the time of its intervention only and within the limits of Client's instructions, if any. The Company's sole responsibility is to its Client and this document does not exonerate parties to a transaction from exercising all their rights and obligations under the transaction documents. This document cannot be reproduced except in full, without prior written approval of the Company. Any unauthorized alteration, forgery or falsification of the content or appearance of this document is unlawful and offenders may be prosecuted to the fullest extent of the law. Unless otherwise stated the results shown in this test report refer only to the sample(s) tested and such sample(s) are retained for 30 days only.

Attention: To check the authenticity of testing/inspection report & certificate, please contact us at telephone: (86-755) 8307 1443, or email: [CN.Doccheck@sgs.com](mailto:CN.Doccheck@sgs.com)  
 1/E Unit D, Building 1, Kanglong Orange Science Park, No.157, Keyuan 3rd Road, Fengfeng New Town, Xi'an, Shaanxi, China 710086  
 中国·西安·沣东新城科里三路157号康隆橙方科技园1号楼D单元1层 邮编: 710086  
 t (86-29) 6282 7885 www.sgs.com.cn  
 t (86-29) 6282 7885 sgs.china@sgs.com



11ac20MIMO	5500	Type6	5	1	333.3	9	0.3333	300	5469	1
11ac20MIMO	5500	Type6	5	1	333.3	9	0.3333	300	5628	1
11ac20MIMO	5500	Type6	5	1	333.3	9	0.3333	300	5294	1
11ac20MIMO	5500	Type6	5	1	333.3	9	0.3333	300	5319	1
11ac20MIMO	5500	Type6	5	1	333.3	9	0.3333	300	5597	1
11ac20MIMO	5500	Type6	5	1	333.3	9	0.3333	300	5631	1
11ac20MIMO	5500	Type6	5	1	333.3	9	0.3333	300	5521	1
11ac20MIMO	5500	Type6	5	1	333.3	9	0.3333	300	5436	1
11ac20MIMO	5500	Type6	5	1	333.3	9	0.3333	300	5423	1
11ac20MIMO	5500	Type6	5	1	333.3	9	0.3333	300	5278	1
11ac20MIMO	5500	Type6	5	1	333.3	9	0.3333	300	5665	1
11ac20MIMO	5500	Type6	5	1	333.3	9	0.3333	300	5340	1
11ac20MIMO	5500	Type6	5	1	333.3	9	0.3333	300	5485	1
11ac20MIMO	5500	Type6	5	1	333.3	9	0.3333	300	5466	1
11ac20MIMO	5500	Type6	5	1	333.3	9	0.3333	300	5438	1
11ac20MIMO	5500	Type6	5	1	333.3	9	0.3333	300	5315	1
11ac20MIMO	5500	Type6	5	1	333.3	9	0.3333	300	5275	1
11ac20MIMO	5500	Type6	5	1	333.3	9	0.3333	300	5614	1
11ac20MIMO	5500	Type6	5	1	333.3	9	0.3333	300	5330	1
11ac20MIMO	5500	Type6	5	1	333.3	9	0.3333	300	5520	1
11ac20MIMO	5500	Type6	5	1	333.3	9	0.3333	300	5590	1
11ac20MIMO	5500	Type6	5	1	333.3	9	0.3333	300	5596	1
11ac20MIMO	5500	Type6	5	1	333.3	9	0.3333	300	5264	1
11ac20MIMO	5500	Type6	5	1	333.3	9	0.3333	300	5289	1
11ac20MIMO	5500	Type6	5	1	333.3	9	0.3333	300	5405	1
11ac20MIMO	5500	Type6	5	1	333.3	9	0.3333	300	5646	1
11ac20MIMO	5500	Type6	5	1	333.3	9	0.3333	300	5526	1
11ac20MIMO	5500	Type6	5	1	333.3	9	0.3333	300	5346	1
11ac20MIMO	5500	Type6	5	1	333.3	9	0.3333	300	5676	1
11ac20MIMO	5500	Type6	5	1	333.3	9	0.3333	300	5267	1
11ac20MIMO	5500	Type6	5	1	333.3	9	0.3333	300	5539	1
11ac20MIMO	5500	Type6	5	1	333.3	9	0.3333	300	5349	1
11ac20MIMO	5500	Type6	5	1	333.3	9	0.3333	300	5600	1
11ac20MIMO	5500	Type6	5	1	333.3	9	0.3333	300	5258	1
11ac20MIMO	5500	Type6	5	1	333.3	9	0.3333	300	5671	1
11ac20MIMO	5500	Type6	5	1	333.3	9	0.3333	300	5533	1
11ac20MIMO	5500	Type6	5	1	333.3	9	0.3333	300	5345	1
11ac20MIMO	5500	Type6	5	1	333.3	9	0.3333	300	5587	1
11ac20MIMO	5500	Type6	5	1	333.3	9	0.3333	300	5523	1



Unless otherwise agreed in writing, this document is issued by the Company subject to its General Conditions of Service printed overleaf, available on request or accessible at <http://www.sgs.com/en/Terms-and-Conditions.aspx> and, for electronic format documents, subject to Terms and Conditions for Electronic Documents at <http://www.sgs.com/en/Terms-and-Conditions/Terms-e-Documents.aspx>. Attention is drawn to the limitation of liability, indemnification and jurisdiction issues defined therein. Any holder of this document is advised that information contained herein reflects the Company's findings at the time of its intervention only and within the limits of Client's instructions, if any. The Company's sole responsibility is to its Client and this document does not exonerate parties to a transaction from exercising all their rights and obligations under the transaction documents. This document cannot be reproduced except in full, without prior written approval of the Company. Any unauthorized alteration, forgery or falsification of the content or appearance of this document is unlawful and offenders may be prosecuted to the fullest extent of the law. Unless otherwise stated the results shown in this test report refer only to the sample(s) tested and such sample(s) are retained for 30 days only.

Attention: To check the authenticity of testing/inspection report & certificate, please contact us at telephone: (86-755) 4307 1443, or email: CN\_Doccheck@sgs.com

SGS-CSTC Standards Technical Services (Xi'an) Co., Ltd. | 1F Unit D, Building 1, Kanghong Orange Source Park, No.137, Kejian 3rd Road, Fengling New Town, Xi'an, Shaanxi, China | 710086 | t (86-29) 6282 7885 | www.sgs.com.cn  
 中国·西安·沣东新城科里三路137号康鸿橙方科技园1号楼D单元1层 | 邮编: 710086 | t (86-29) 6282 7885 | sgs.china@sgs.com

TestMode	Channel	Radar Type	Trial ID	Pulse width (μs)	PRI (μs)	Pulses per Hop	Hop Rate (kHz)	Hop Sequence Length(ms)	Center Frequency (MHz)	Detection (1: Yes; 0: No)
11ac80MIMO	5530	Type6	6	1	333.3	9	0.3333	300	5372	1
11ac80MIMO	5530	Type6	6	1	333.3	9	0.3333	300	5348	1
11ac80MIMO	5530	Type6	6	1	333.3	9	0.3333	300	5425	1
11ac80MIMO	5530	Type6	6	1	333.3	9	0.3333	300	5624	1
11ac80MIMO	5530	Type6	6	1	333.3	9	0.3333	300	5260	1
11ac80MIMO	5530	Type6	6	1	333.3	9	0.3333	300	5283	1
11ac80MIMO	5530	Type6	6	1	333.3	9	0.3333	300	5576	1
11ac80MIMO	5530	Type6	6	1	333.3	9	0.3333	300	5610	1
11ac80MIMO	5530	Type6	6	1	333.3	9	0.3333	300	5434	1
11ac80MIMO	5530	Type6	6	1	333.3	9	0.3333	300	5581	1
11ac80MIMO	5530	Type6	6	1	333.3	9	0.3333	300	5689	1
11ac80MIMO	5530	Type6	6	1	333.3	9	0.3333	300	5289	1
11ac80MIMO	5530	Type6	6	1	333.3	9	0.3333	300	5635	1
11ac80MIMO	5530	Type6	6	1	333.3	9	0.3333	300	5570	1
11ac80MIMO	5530	Type6	6	1	333.3	9	0.3333	300	5714	1
11ac80MIMO	5530	Type6	6	1	333.3	9	0.3333	300	5577	1
11ac80MIMO	5530	Type6	6	1	333.3	9	0.3333	300	5256	1
11ac80MIMO	5530	Type6	6	1	333.3	9	0.3333	300	5342	1
11ac80MIMO	5530	Type6	6	1	333.3	9	0.3333	300	5558	1
11ac80MIMO	5530	Type6	6	1	333.3	9	0.3333	300	5279	1
11ac80MIMO	5530	Type6	6	1	333.3	9	0.3333	300	5490	1
11ac80MIMO	5530	Type6	6	1	333.3	9	0.3333	300	5652	1
11ac80MIMO	5530	Type6	6	1	333.3	9	0.3333	300	5549	1
11ac80MIMO	5530	Type6	6	1	333.3	9	0.3333	300	5724	1
11ac80MIMO	5530	Type6	6	1	333.3	9	0.3333	300	5640	1
11ac80MIMO	5530	Type6	6	1	333.3	9	0.3333	300	5634	1
11ac80MIMO	5530	Type6	6	1	333.3	9	0.3333	300	5552	1
11ac80MIMO	5530	Type6	6	1	333.3	9	0.3333	300	5300	1
11ac80MIMO	5530	Type6	6	1	333.3	9	0.3333	300	5448	1
11ac80MIMO	5530	Type6	6	1	333.3	9	0.3333	300	5409	1
11ac80MIMO	5530	Type6	6	1	333.3	9	0.3333	300	5297	1
11ac80MIMO	5530	Type6	6	1	333.3	9	0.3333	300	5713	1
11ac80MIMO	5530	Type6	6	1	333.3	9	0.3333	300	5431	1
11ac80MIMO	5530	Type6	6	1	333.3	9	0.3333	300	5580	1
11ac80MIMO	5530	Type6	6	1	333.3	9	0.3333	300	5444	1
11ac80MIMO	5530	Type6	6	1	333.3	9	0.3333	300	5667	1
11ac80MIMO	5530	Type6	6	1	333.3	9	0.3333	300	5445	1
11ac80MIMO	5530	Type6	6	1	333.3	9	0.3333	300	5701	1
11ac80MIMO	5530	Type6	6	1	333.3	9	0.3333	300	5492	1
11ac80MIMO	5530	Type6	6	1	333.3	9	0.3333	300	5290	1
11ac80MIMO	5530	Type6	6	1	333.3	9	0.3333	300	5326	1
11ac80MIMO	5530	Type6	6	1	333.3	9	0.3333	300	5286	1
11ac80MIMO	5530	Type6	6	1	333.3	9	0.3333	300	5621	1
11ac80MIMO	5530	Type6	6	1	333.3	9	0.3333	300	5382	1
11ac80MIMO	5530	Type6	6	1	333.3	9	0.3333	300	5280	1
11ac80MIMO	5530	Type6	6	1	333.3	9	0.3333	300	5559	1
11ac80MIMO	5530	Type6	6	1	333.3	9	0.3333	300	5313	1
11ac80MIMO	5530	Type6	6	1	333.3	9	0.3333	300	5541	1
11ac80MIMO	5530	Type6	6	1	333.3	9	0.3333	300	5499	1



Unless otherwise agreed in writing, this document is issued by the Company subject to its General Conditions of Service printed overleaf, available on request or accessible at <http://www.sgs.com/en/Terms-and-Conditions.aspx> and, for electronic format documents, subject to Terms and Conditions for Electronic Documents at <http://www.sgs.com/en/Terms-and-Conditions/Terms-e-Documents.aspx>. Attention is drawn to the limitation of liability, indemnification and jurisdiction issues defined therein. Any holder of this document is advised that information contained herein reflects the Company's findings at the time of its intervention only and within the limits of Client's instructions, if any. The Company's sole responsibility is to its Client and this document does not exonerate parties to a transaction from exercising all their rights and obligations under the transaction documents. This document cannot be reproduced except in full, without prior written approval of the Company. Any unauthorized alteration, forgery or falsification of the content or appearance of this document is unlawful and offenders may be prosecuted to the fullest extent of the law. Unless otherwise stated the results shown in this test report refer only to the sample(s) tested and such sample(s) are retained for 30 days only.

Attention: To check the authenticity of testing/inspection report & certificate, please contact us at telephone: (86-755) 8307 1443, or email: [CN.Doccheck@sgs.com](mailto:CN.Doccheck@sgs.com)  
 S/GS-CSTC Standards Technical Services (Xi'an) Co., Ltd. | 1/E Unit D, Building 1, Kanglong Orange Science Park, No.157, Keyuan 3rd Road, Fengjing/Yue Town, Xi'an, Shaanxi, China | 710086 | t: (86-29) 6282 7885 | www.sgs.com.cn  
 中国·西安·沣东新城科里三路157号康隆橙方科技园1号楼D单元1层 | 邮编: 710086 | t: (86-29) 6282 7885 | sgs.china@sgs.com



11ac80MIMO	5530	Type6	6	1	333.3	9	0.3333	300	5704	1
11ac80MIMO	5530	Type6	6	1	333.3	9	0.3333	300	5395	1
11ac80MIMO	5530	Type6	6	1	333.3	9	0.3333	300	5474	1
11ac80MIMO	5530	Type6	6	1	333.3	9	0.3333	300	5569	1
11ac80MIMO	5530	Type6	6	1	333.3	9	0.3333	300	5274	1
11ac80MIMO	5530	Type6	6	1	333.3	9	0.3333	300	5421	1
11ac80MIMO	5530	Type6	6	1	333.3	9	0.3333	300	5698	1
11ac80MIMO	5530	Type6	6	1	333.3	9	0.3333	300	5625	1
11ac80MIMO	5530	Type6	6	1	333.3	9	0.3333	300	5345	1
11ac80MIMO	5530	Type6	6	1	333.3	9	0.3333	300	5374	1
11ac80MIMO	5530	Type6	6	1	333.3	9	0.3333	300	5657	1
11ac80MIMO	5530	Type6	6	1	333.3	9	0.3333	300	5711	1
11ac80MIMO	5530	Type6	6	1	333.3	9	0.3333	300	5519	1
11ac80MIMO	5530	Type6	6	1	333.3	9	0.3333	300	5642	1
11ac80MIMO	5530	Type6	6	1	333.3	9	0.3333	300	5301	1
11ac80MIMO	5530	Type6	6	1	333.3	9	0.3333	300	5454	1
11ac80MIMO	5530	Type6	6	1	333.3	9	0.3333	300	5715	1
11ac80MIMO	5530	Type6	6	1	333.3	9	0.3333	300	5520	1
11ac80MIMO	5530	Type6	6	1	333.3	9	0.3333	300	5536	1
11ac80MIMO	5530	Type6	6	1	333.3	9	0.3333	300	5366	1
11ac80MIMO	5530	Type6	6	1	333.3	9	0.3333	300	5413	1
11ac80MIMO	5530	Type6	6	1	333.3	9	0.3333	300	5414	1
11ac80MIMO	5530	Type6	6	1	333.3	9	0.3333	300	5378	1
11ac80MIMO	5530	Type6	6	1	333.3	9	0.3333	300	5417	1
11ac80MIMO	5530	Type6	6	1	333.3	9	0.3333	300	5316	1
11ac80MIMO	5530	Type6	6	1	333.3	9	0.3333	300	5428	1
11ac80MIMO	5530	Type6	6	1	333.3	9	0.3333	300	5357	1
11ac80MIMO	5530	Type6	6	1	333.3	9	0.3333	300	5586	1
11ac80MIMO	5530	Type6	6	1	333.3	9	0.3333	300	5484	1
11ac80MIMO	5530	Type6	6	1	333.3	9	0.3333	300	5296	1
11ac80MIMO	5530	Type6	6	1	333.3	9	0.3333	300	5430	1
11ac80MIMO	5530	Type6	6	1	333.3	9	0.3333	300	5627	1
11ac80MIMO	5530	Type6	6	1	333.3	9	0.3333	300	5684	1
11ac80MIMO	5530	Type6	6	1	333.3	9	0.3333	300	5653	1
11ac80MIMO	5530	Type6	6	1	333.3	9	0.3333	300	5273	1
11ac80MIMO	5530	Type6	6	1	333.3	9	0.3333	300	5606	1
11ac80MIMO	5530	Type6	6	1	333.3	9	0.3333	300	5465	1
11ac80MIMO	5530	Type6	6	1	333.3	9	0.3333	300	5363	1
11ac80MIMO	5530	Type6	6	1	333.3	9	0.3333	300	5491	1
11ac80MIMO	5530	Type6	6	1	333.3	9	0.3333	300	5352	1
11ac80MIMO	5530	Type6	6	1	333.3	9	0.3333	300	5355	1
11ac80MIMO	5530	Type6	6	1	333.3	9	0.3333	300	5518	1
11ac80MIMO	5530	Type6	6	1	333.3	9	0.3333	300	5631	1
11ac80MIMO	5530	Type6	6	1	333.3	9	0.3333	300	5688	1
11ac80MIMO	5530	Type6	6	1	333.3	9	0.3333	300	5588	1
11ac80MIMO	5530	Type6	6	1	333.3	9	0.3333	300	5329	1
11ac80MIMO	5530	Type6	6	1	333.3	9	0.3333	300	5485	1
11ac80MIMO	5530	Type6	6	1	333.3	9	0.3333	300	5502	1
11ac80MIMO	5530	Type6	6	1	333.3	9	0.3333	300	5590	1
11ac80MIMO	5530	Type6	6	1	333.3	9	0.3333	300	5390	1
11ac80MIMO	5530	Type6	6	1	333.3	9	0.3333	300	5531	1
11ac40MIMO	5510	Type6	6	1	333.3	9	0.3333	300	5372	1
11ac40MIMO	5510	Type6	6	1	333.3	9	0.3333	300	5348	1



Unless otherwise agreed in writing, this document is issued by the Company subject to its General Conditions of Service printed overleaf, available on request or accessible at <http://www.sgs.com/en/Terms-and-Conditions.aspx> and, for electronic format documents, subject to Terms and Conditions for Electronic Documents at <http://www.sgs.com/en/Terms-and-Conditions/Terms-e-Documents.aspx>. Attention is drawn to the limitation of liability, indemnification and jurisdiction issues defined therein. Any holder of this document is advised that information contained herein reflects the Company's findings at the time of its intervention only and within the limits of Client's instructions, if any. The Company's sole responsibility is to its Client and this document does not exonerate parties to a transaction from exercising all their rights and obligations under the transaction documents. This document cannot be reproduced except in full, without prior written approval of the Company. Any unauthorized alteration, forgery or falsification of the content or appearance of this document is unlawful and offenders may be prosecuted to the fullest extent of the law. Unless otherwise stated the results shown in this test report refer only to the sample(s) tested and such sample(s) are retained for 30 days only.

Attention: To check the authenticity of testing/inspection report & certificate, please contact us at telephone: (86-755) 8307 1443, or email: [CN.Doccheck@sgs.com](mailto:CN.Doccheck@sgs.com)

SGS-CSTC Standards Technical Services (Xi'an) Co., Ltd. | 1/F, Unit D, Building 1, Kanglong Orange Science Park, No.157, Keyuan 3rd Road, Fengyang New Town, Xian, Shaanxi, China | 710086 | T (86-29) 6282 7885 | [www.sgs.com.cn](http://www.sgs.com.cn)  
 中国·西安·沣东新城科里三路157号康隆橙方科技园1号楼D单元1层 | 邮编: 710086 | T (86-29) 6282 7885 | [sgs.china@sgs.com](mailto:sgs.china@sgs.com)



Table with 11 columns: Item ID, Value, Type, and various numerical parameters. The table contains 40 rows of data, all with 'Type6' and a value of 300.



Unless otherwise agreed in writing, this document is issued by the Company subject to its General Conditions of Service printed overleaf, available on request or accessible at <http://www.sgs.com/en/Terms-and-Conditions.aspx> and, for electronic format documents, subject to Terms and Conditions for Electronic Documents at <http://www.sgs.com/en/Terms-and-Conditions/Terms-e-Documents.aspx>. Attention is drawn to the limitation of liability, indemnification and jurisdiction issues defined therein. Any holder of this document is advised that information contained herein reflects the Company's findings at the time of its intervention only and within the limits of Client's instructions, if any. The Company's sole responsibility is to its Client and this document does not exonerate parties to a transaction from exercising all their rights and obligations under the transaction documents. This document cannot be reproduced except in full, without prior written approval of the Company. Any unauthorized alteration, forgery or falsification of the content or appearance of this document is unlawful and offenders may be prosecuted to the fullest extent of the law. Unless otherwise stated the results shown in this test report refer only to the sample(s) tested and such sample(s) are retained for 30 days only. Attention: To check the authenticity of testing/inspection report & certificate, please contact us at telephone: (86-755) 8307 1443, or email: CN.Doccheck@sgs.com

SGS-CSTC Standards Technical Services (Xi'an) Co., Ltd. | 1/F Unit D, Building 1, Kanglong Orange Science Park, No.137, Keyuan 3rd Road, Fengyang New Town, Xian, Shaanxi, China | 710086 | t (86-29) 6282 7885 | www.sgs.com.cn  
中国·西安·沣东新城科里三路137号康鸿橙方科技园1号楼D单元1层 | 邮编: 710086 | t (86-29) 6282 7885 | sgs.china@sgs.com



11ac40MIMO	5510	Type6	6	1	333.3	9	0.3333	300	5698	1
11ac40MIMO	5510	Type6	6	1	333.3	9	0.3333	300	5625	1
11ac40MIMO	5510	Type6	6	1	333.3	9	0.3333	300	5345	1
11ac40MIMO	5510	Type6	6	1	333.3	9	0.3333	300	5374	1
11ac40MIMO	5510	Type6	6	1	333.3	9	0.3333	300	5657	1
11ac40MIMO	5510	Type6	6	1	333.3	9	0.3333	300	5711	1
11ac40MIMO	5510	Type6	6	1	333.3	9	0.3333	300	5519	1
11ac40MIMO	5510	Type6	6	1	333.3	9	0.3333	300	5642	1
11ac40MIMO	5510	Type6	6	1	333.3	9	0.3333	300	5301	1
11ac40MIMO	5510	Type6	6	1	333.3	9	0.3333	300	5454	1
11ac40MIMO	5510	Type6	6	1	333.3	9	0.3333	300	5715	1
11ac40MIMO	5510	Type6	6	1	333.3	9	0.3333	300	5520	1
11ac40MIMO	5510	Type6	6	1	333.3	9	0.3333	300	5536	1
11ac40MIMO	5510	Type6	6	1	333.3	9	0.3333	300	5366	1
11ac40MIMO	5510	Type6	6	1	333.3	9	0.3333	300	5413	1
11ac40MIMO	5510	Type6	6	1	333.3	9	0.3333	300	5414	1
11ac40MIMO	5510	Type6	6	1	333.3	9	0.3333	300	5378	1
11ac40MIMO	5510	Type6	6	1	333.3	9	0.3333	300	5417	1
11ac40MIMO	5510	Type6	6	1	333.3	9	0.3333	300	5316	1
11ac40MIMO	5510	Type6	6	1	333.3	9	0.3333	300	5428	1
11ac40MIMO	5510	Type6	6	1	333.3	9	0.3333	300	5357	1
11ac40MIMO	5510	Type6	6	1	333.3	9	0.3333	300	5586	1
11ac40MIMO	5510	Type6	6	1	333.3	9	0.3333	300	5484	1
11ac40MIMO	5510	Type6	6	1	333.3	9	0.3333	300	5296	1
11ac40MIMO	5510	Type6	6	1	333.3	9	0.3333	300	5430	1
11ac40MIMO	5510	Type6	6	1	333.3	9	0.3333	300	5627	1
11ac40MIMO	5510	Type6	6	1	333.3	9	0.3333	300	5684	1
11ac40MIMO	5510	Type6	6	1	333.3	9	0.3333	300	5653	1
11ac40MIMO	5510	Type6	6	1	333.3	9	0.3333	300	5273	1
11ac40MIMO	5510	Type6	6	1	333.3	9	0.3333	300	5606	1
11ac40MIMO	5510	Type6	6	1	333.3	9	0.3333	300	5465	1
11ac40MIMO	5510	Type6	6	1	333.3	9	0.3333	300	5363	1
11ac40MIMO	5510	Type6	6	1	333.3	9	0.3333	300	5491	1
11ac40MIMO	5510	Type6	6	1	333.3	9	0.3333	300	5352	1
11ac40MIMO	5510	Type6	6	1	333.3	9	0.3333	300	5355	1
11ac40MIMO	5510	Type6	6	1	333.3	9	0.3333	300	5518	1
11ac40MIMO	5510	Type6	6	1	333.3	9	0.3333	300	5631	1
11ac40MIMO	5510	Type6	6	1	333.3	9	0.3333	300	5688	1
11ac40MIMO	5510	Type6	6	1	333.3	9	0.3333	300	5588	1
11ac40MIMO	5510	Type6	6	1	333.3	9	0.3333	300	5329	1
11ac40MIMO	5510	Type6	6	1	333.3	9	0.3333	300	5485	1
11ac40MIMO	5510	Type6	6	1	333.3	9	0.3333	300	5502	1
11ac40MIMO	5510	Type6	6	1	333.3	9	0.3333	300	5590	1
11ac40MIMO	5510	Type6	6	1	333.3	9	0.3333	300	5390	1
11ac40MIMO	5510	Type6	6	1	333.3	9	0.3333	300	5531	1
11ac20MIMO	5500	Type6	6	1	333.3	9	0.3333	300	5372	1
11ac20MIMO	5500	Type6	6	1	333.3	9	0.3333	300	5348	1
11ac20MIMO	5500	Type6	6	1	333.3	9	0.3333	300	5425	1
11ac20MIMO	5500	Type6	6	1	333.3	9	0.3333	300	5624	1
11ac20MIMO	5500	Type6	6	1	333.3	9	0.3333	300	5260	1
11ac20MIMO	5500	Type6	6	1	333.3	9	0.3333	300	5283	1
11ac20MIMO	5500	Type6	6	1	333.3	9	0.3333	300	5576	1
11ac20MIMO	5500	Type6	6	1	333.3	9	0.3333	300	5610	1



Unless otherwise agreed in writing, this document is issued by the Company subject to its General Conditions of Service printed overleaf, available on request or accessible at <http://www.sgs.com/en/Terms-and-Conditions.aspx> and, for electronic format documents, subject to Terms and Conditions for Electronic Documents at <http://www.sgs.com/en/Terms-and-Conditions/Terms-e-Documents.aspx>. Attention is drawn to the limitation of liability, indemnification and jurisdiction issues defined therein. Any holder of this document is advised that information contained herein reflects the Company's findings at the time of its intervention only and within the limits of Client's instructions, if any. The Company's sole responsibility is to its Client and this document does not exonerate parties to a transaction from exercising all their rights and obligations under the transaction documents. This document cannot be reproduced except in full, without prior written approval of the Company. Any unauthorized alteration, forgery or falsification of the content or appearance of this document is unlawful and offenders may be prosecuted to the fullest extent of the law. Unless otherwise stated the results shown in this test report refer only to the sample(s) tested and such sample(s) are retained for 30 days only.

Attention: To check the authenticity of testing/inspection report & certificate, please contact us at telephone: (86-755) 8307 1443, or email: [CN.Doccheck@sgs.com](mailto:CN.Doccheck@sgs.com)

SGS-CSTC Standards Technical Services (Xi'an) Co., Ltd. | 1/F Unit D, Building 1, Kanglong Orange Science Park, No.137, Keyuan 3rd Road, Fengyang New Town, Xi'an, Shaanxi, China | 710086 | t (86-29) 6282 7885 | www.sgs.com.cn  
 中国·西安·沣东新城科里三路137号康鸿橙方科技园1号楼D单元1层 | 邮编: 710086 | t (86-29) 6282 7885 | sgs.china@sgs.com

11ac20MIMO	5500	Type6	6	1	333.3	9	0.3333	300	5434	1
11ac20MIMO	5500	Type6	6	1	333.3	9	0.3333	300	5581	1
11ac20MIMO	5500	Type6	6	1	333.3	9	0.3333	300	5689	1
11ac20MIMO	5500	Type6	6	1	333.3	9	0.3333	300	5289	1
11ac20MIMO	5500	Type6	6	1	333.3	9	0.3333	300	5635	1
11ac20MIMO	5500	Type6	6	1	333.3	9	0.3333	300	5570	1
11ac20MIMO	5500	Type6	6	1	333.3	9	0.3333	300	5714	1
11ac20MIMO	5500	Type6	6	1	333.3	9	0.3333	300	5577	1
11ac20MIMO	5500	Type6	6	1	333.3	9	0.3333	300	5256	1
11ac20MIMO	5500	Type6	6	1	333.3	9	0.3333	300	5342	1
11ac20MIMO	5500	Type6	6	1	333.3	9	0.3333	300	5558	1
11ac20MIMO	5500	Type6	6	1	333.3	9	0.3333	300	5279	1
11ac20MIMO	5500	Type6	6	1	333.3	9	0.3333	300	5490	1
11ac20MIMO	5500	Type6	6	1	333.3	9	0.3333	300	5652	1
11ac20MIMO	5500	Type6	6	1	333.3	9	0.3333	300	5549	1
11ac20MIMO	5500	Type6	6	1	333.3	9	0.3333	300	5724	1
11ac20MIMO	5500	Type6	6	1	333.3	9	0.3333	300	5640	1
11ac20MIMO	5500	Type6	6	1	333.3	9	0.3333	300	5634	1
11ac20MIMO	5500	Type6	6	1	333.3	9	0.3333	300	5552	1
11ac20MIMO	5500	Type6	6	1	333.3	9	0.3333	300	5300	1
11ac20MIMO	5500	Type6	6	1	333.3	9	0.3333	300	5448	1
11ac20MIMO	5500	Type6	6	1	333.3	9	0.3333	300	5409	1
11ac20MIMO	5500	Type6	6	1	333.3	9	0.3333	300	5297	1
11ac20MIMO	5500	Type6	6	1	333.3	9	0.3333	300	5713	1
11ac20MIMO	5500	Type6	6	1	333.3	9	0.3333	300	5431	1
11ac20MIMO	5500	Type6	6	1	333.3	9	0.3333	300	5580	1
11ac20MIMO	5500	Type6	6	1	333.3	9	0.3333	300	5444	1
11ac20MIMO	5500	Type6	6	1	333.3	9	0.3333	300	5667	1
11ac20MIMO	5500	Type6	6	1	333.3	9	0.3333	300	5445	1
11ac20MIMO	5500	Type6	6	1	333.3	9	0.3333	300	5701	1
11ac20MIMO	5500	Type6	6	1	333.3	9	0.3333	300	5492	1
11ac20MIMO	5500	Type6	6	1	333.3	9	0.3333	300	5290	1
11ac20MIMO	5500	Type6	6	1	333.3	9	0.3333	300	5326	1
11ac20MIMO	5500	Type6	6	1	333.3	9	0.3333	300	5286	1
11ac20MIMO	5500	Type6	6	1	333.3	9	0.3333	300	5621	1
11ac20MIMO	5500	Type6	6	1	333.3	9	0.3333	300	5382	1
11ac20MIMO	5500	Type6	6	1	333.3	9	0.3333	300	5280	1
11ac20MIMO	5500	Type6	6	1	333.3	9	0.3333	300	5559	1
11ac20MIMO	5500	Type6	6	1	333.3	9	0.3333	300	5313	1
11ac20MIMO	5500	Type6	6	1	333.3	9	0.3333	300	5541	1
11ac20MIMO	5500	Type6	6	1	333.3	9	0.3333	300	5499	1
11ac20MIMO	5500	Type6	6	1	333.3	9	0.3333	300	5704	1
11ac20MIMO	5500	Type6	6	1	333.3	9	0.3333	300	5395	1
11ac20MIMO	5500	Type6	6	1	333.3	9	0.3333	300	5474	1
11ac20MIMO	5500	Type6	6	1	333.3	9	0.3333	300	5569	1
11ac20MIMO	5500	Type6	6	1	333.3	9	0.3333	300	5274	1
11ac20MIMO	5500	Type6	6	1	333.3	9	0.3333	300	5421	1
11ac20MIMO	5500	Type6	6	1	333.3	9	0.3333	300	5698	1
11ac20MIMO	5500	Type6	6	1	333.3	9	0.3333	300	5625	1
11ac20MIMO	5500	Type6	6	1	333.3	9	0.3333	300	5345	1
11ac20MIMO	5500	Type6	6	1	333.3	9	0.3333	300	5374	1
11ac20MIMO	5500	Type6	6	1	333.3	9	0.3333	300	5657	1
11ac20MIMO	5500	Type6	6	1	333.3	9	0.3333	300	5711	1



Unless otherwise agreed in writing, this document is issued by the Company subject to its General Conditions of Service printed overleaf, available on request or accessible at <http://www.sgs.com/en/Terms-and-Conditions.aspx> and, for electronic format documents, subject to Terms and Conditions for Electronic Documents at <http://www.sgs.com/en/Terms-and-Conditions/Terms-e-Documents.aspx>. Attention is drawn to the limitation of liability, indemnification and jurisdiction issues defined therein. Any holder of this document is advised that information contained herein reflects the Company's findings at the time of its intervention only and within the limits of Client's instructions, if any. The Company's sole responsibility is to its Client and this document does not exonerate parties to a transaction from exercising all their rights and obligations under the transaction documents. This document cannot be reproduced except in full, without prior written approval of the Company. Any unauthorized alteration, forgery or falsification of the content or appearance of this document is unlawful and offenders may be prosecuted to the fullest extent of the law. Unless otherwise stated the results shown in this test report refer only to the sample(s) tested and such sample(s) are retained for 30 days only.

Attention: To check the authenticity of testing/inspection report & certificate, please contact us at telephone: (86-755) 8307 1443, or email: [CN.Doccheck@sgs.com](mailto:CN.Doccheck@sgs.com)

SGS-CSTC Standards Technical Services (Xi'an) Co., Ltd. | 1/E Unit D, Building 1, Kanglong Orange Science Park, No.157, Keyuan 3rd Road, Fengyang New Town, Xian, Shaanxi, China | 710086 | T (86-29) 6282 7885 | [www.sgs.com](http://www.sgs.com)  
 中国·西安·沣东新城科里三路157号康隆橙方科技园1号楼D单元1层 | 邮编: 710086 | T (86-29) 6282 7885 | [sgs.china@sgs.com](mailto:sgs.china@sgs.com)





Report No.: XEWA2310000070RG05

Rev.: 01

Page: 129 of 267

11ac20MIMO	5500	Type6	6	1	333.3	9	0.3333	300	5519	1
11ac20MIMO	5500	Type6	6	1	333.3	9	0.3333	300	5642	1
11ac20MIMO	5500	Type6	6	1	333.3	9	0.3333	300	5301	1
11ac20MIMO	5500	Type6	6	1	333.3	9	0.3333	300	5454	1
11ac20MIMO	5500	Type6	6	1	333.3	9	0.3333	300	5715	1
11ac20MIMO	5500	Type6	6	1	333.3	9	0.3333	300	5520	1
11ac20MIMO	5500	Type6	6	1	333.3	9	0.3333	300	5536	1
11ac20MIMO	5500	Type6	6	1	333.3	9	0.3333	300	5366	1
11ac20MIMO	5500	Type6	6	1	333.3	9	0.3333	300	5413	1
11ac20MIMO	5500	Type6	6	1	333.3	9	0.3333	300	5414	1
11ac20MIMO	5500	Type6	6	1	333.3	9	0.3333	300	5378	1
11ac20MIMO	5500	Type6	6	1	333.3	9	0.3333	300	5417	1
11ac20MIMO	5500	Type6	6	1	333.3	9	0.3333	300	5316	1
11ac20MIMO	5500	Type6	6	1	333.3	9	0.3333	300	5428	1
11ac20MIMO	5500	Type6	6	1	333.3	9	0.3333	300	5357	1
11ac20MIMO	5500	Type6	6	1	333.3	9	0.3333	300	5586	1
11ac20MIMO	5500	Type6	6	1	333.3	9	0.3333	300	5484	1
11ac20MIMO	5500	Type6	6	1	333.3	9	0.3333	300	5296	1
11ac20MIMO	5500	Type6	6	1	333.3	9	0.3333	300	5430	1
11ac20MIMO	5500	Type6	6	1	333.3	9	0.3333	300	5627	1
11ac20MIMO	5500	Type6	6	1	333.3	9	0.3333	300	5684	1
11ac20MIMO	5500	Type6	6	1	333.3	9	0.3333	300	5653	1
11ac20MIMO	5500	Type6	6	1	333.3	9	0.3333	300	5273	1
11ac20MIMO	5500	Type6	6	1	333.3	9	0.3333	300	5606	1
11ac20MIMO	5500	Type6	6	1	333.3	9	0.3333	300	5465	1
11ac20MIMO	5500	Type6	6	1	333.3	9	0.3333	300	5363	1
11ac20MIMO	5500	Type6	6	1	333.3	9	0.3333	300	5491	1
11ac20MIMO	5500	Type6	6	1	333.3	9	0.3333	300	5352	1
11ac20MIMO	5500	Type6	6	1	333.3	9	0.3333	300	5355	1
11ac20MIMO	5500	Type6	6	1	333.3	9	0.3333	300	5518	1
11ac20MIMO	5500	Type6	6	1	333.3	9	0.3333	300	5631	1
11ac20MIMO	5500	Type6	6	1	333.3	9	0.3333	300	5688	1
11ac20MIMO	5500	Type6	6	1	333.3	9	0.3333	300	5588	1
11ac20MIMO	5500	Type6	6	1	333.3	9	0.3333	300	5329	1
11ac20MIMO	5500	Type6	6	1	333.3	9	0.3333	300	5485	1
11ac20MIMO	5500	Type6	6	1	333.3	9	0.3333	300	5502	1
11ac20MIMO	5500	Type6	6	1	333.3	9	0.3333	300	5590	1
11ac20MIMO	5500	Type6	6	1	333.3	9	0.3333	300	5390	1
11ac20MIMO	5500	Type6	6	1	333.3	9	0.3333	300	5531	1



Unless otherwise agreed in writing, this document is issued by the Company subject to its General Conditions of Service printed overleaf, available on request or accessible at <http://www.sgs.com/en/Terms-and-Conditions.aspx> and, for electronic format documents, subject to Terms and Conditions for Electronic Documents at <http://www.sgs.com/en/Terms-and-Conditions/Terms-e-Documents.aspx>. Attention is drawn to the limitation of liability, indemnification and jurisdiction issues defined therein. Any holder of this document is advised that information contained herein reflects the Company's findings at the time of its intervention only and within the limits of Client's instructions, if any. The Company's sole responsibility is to its Client and this document does not exonerate parties to a transaction from exercising all their rights and obligations under the transaction documents. This document cannot be reproduced except in full, without prior written approval of the Company. Any unauthorized alteration, forgery or falsification of the content or appearance of this document is unlawful and offenders may be prosecuted to the fullest extent of the law. Unless otherwise stated the results shown in this test report refer only to the sample(s) tested and such sample(s) are retained for 30 days only.

Attention: To check the authenticity of testing/inspection report & certificate, please contact us at telephone: (86-755) 4307 1443, or email: CN.Doccheck@sgs.com

SGS-CSTC Standards Technical Services (Xi'an) Co., Ltd. | 1/E Unit D, Building 1, Kanglong Orange Source Park, No.137, Keyuan 3rd Road, Fengling New Town, Xi'an, Shaanxi, China | 710086 | t: (86-29) 6282 7885 | www.sgs.com.cn  
 中国·西安·沣东新城科里三路137号康隆橙方科技园1号楼D单元1层 | 邮编: 710086 | t: (86-29) 6282 7885 | sgs.china@sgs.com

TestMode	Channel	Radar Type	Trial ID	Pulse width (μs)	PRI (μs)	Pulses per Hop	Hop Rate (kHz)	Hop Sequence Length(ms)	Center Frequency (MHz)	Detection (1: Yes; 0: No)
11ac80MIMO	5530	Type6	7	1	333.3	9	0.3333	300	5530	1
11ac80MIMO	5530	Type6	7	1	333.3	9	0.3333	300	5587	1
11ac80MIMO	5530	Type6	7	1	333.3	9	0.3333	300	5361	1
11ac80MIMO	5530	Type6	7	1	333.3	9	0.3333	300	5310	1
11ac80MIMO	5530	Type6	7	1	333.3	9	0.3333	300	5480	1
11ac80MIMO	5530	Type6	7	1	333.3	9	0.3333	300	5325	1
11ac80MIMO	5530	Type6	7	1	333.3	9	0.3333	300	5598	1
11ac80MIMO	5530	Type6	7	1	333.3	9	0.3333	300	5685	1
11ac80MIMO	5530	Type6	7	1	333.3	9	0.3333	300	5500	1
11ac80MIMO	5530	Type6	7	1	333.3	9	0.3333	300	5410	1
11ac80MIMO	5530	Type6	7	1	333.3	9	0.3333	300	5523	1
11ac80MIMO	5530	Type6	7	1	333.3	9	0.3333	300	5553	1
11ac80MIMO	5530	Type6	7	1	333.3	9	0.3333	300	5676	1
11ac80MIMO	5530	Type6	7	1	333.3	9	0.3333	300	5290	1
11ac80MIMO	5530	Type6	7	1	333.3	9	0.3333	300	5260	1
11ac80MIMO	5530	Type6	7	1	333.3	9	0.3333	300	5568	1
11ac80MIMO	5530	Type6	7	1	333.3	9	0.3333	300	5383	1
11ac80MIMO	5530	Type6	7	1	333.3	9	0.3333	300	5445	1
11ac80MIMO	5530	Type6	7	1	333.3	9	0.3333	300	5603	1
11ac80MIMO	5530	Type6	7	1	333.3	9	0.3333	300	5471	1
11ac80MIMO	5530	Type6	7	1	333.3	9	0.3333	300	5498	1
11ac80MIMO	5530	Type6	7	1	333.3	9	0.3333	300	5514	1
11ac80MIMO	5530	Type6	7	1	333.3	9	0.3333	300	5690	1
11ac80MIMO	5530	Type6	7	1	333.3	9	0.3333	300	5638	1
11ac80MIMO	5530	Type6	7	1	333.3	9	0.3333	300	5697	1
11ac80MIMO	5530	Type6	7	1	333.3	9	0.3333	300	5431	1
11ac80MIMO	5530	Type6	7	1	333.3	9	0.3333	300	5583	1
11ac80MIMO	5530	Type6	7	1	333.3	9	0.3333	300	5280	1
11ac80MIMO	5530	Type6	7	1	333.3	9	0.3333	300	5404	1
11ac80MIMO	5530	Type6	7	1	333.3	9	0.3333	300	5482	1
11ac80MIMO	5530	Type6	7	1	333.3	9	0.3333	300	5451	1
11ac80MIMO	5530	Type6	7	1	333.3	9	0.3333	300	5661	1
11ac80MIMO	5530	Type6	7	1	333.3	9	0.3333	300	5670	1
11ac80MIMO	5530	Type6	7	1	333.3	9	0.3333	300	5646	1
11ac80MIMO	5530	Type6	7	1	333.3	9	0.3333	300	5354	1
11ac80MIMO	5530	Type6	7	1	333.3	9	0.3333	300	5642	1
11ac80MIMO	5530	Type6	7	1	333.3	9	0.3333	300	5331	1
11ac80MIMO	5530	Type6	7	1	333.3	9	0.3333	300	5633	1
11ac80MIMO	5530	Type6	7	1	333.3	9	0.3333	300	5594	1
11ac80MIMO	5530	Type6	7	1	333.3	9	0.3333	300	5267	1
11ac80MIMO	5530	Type6	7	1	333.3	9	0.3333	300	5301	1
11ac80MIMO	5530	Type6	7	1	333.3	9	0.3333	300	5640	1
11ac80MIMO	5530	Type6	7	1	333.3	9	0.3333	300	5369	1
11ac80MIMO	5530	Type6	7	1	333.3	9	0.3333	300	5559	1
11ac80MIMO	5530	Type6	7	1	333.3	9	0.3333	300	5622	1
11ac80MIMO	5530	Type6	7	1	333.3	9	0.3333	300	5277	1
11ac80MIMO	5530	Type6	7	1	333.3	9	0.3333	300	5391	1
11ac80MIMO	5530	Type6	7	1	333.3	9	0.3333	300	5507	1
11ac80MIMO	5530	Type6	7	1	333.3	9	0.3333	300	5396	1



Unless otherwise agreed in writing, this document is issued by the Company subject to its General Conditions of Service printed overleaf, available on request or accessible at <http://www.sgs.com/en/Terms-and-Conditions.aspx> and, for electronic format documents, subject to Terms and Conditions for Electronic Documents at <http://www.sgs.com/en/Terms-and-Conditions/Terms-e-Documents.aspx>. Attention is drawn to the limitation of liability, indemnification and jurisdiction issues defined therein. Any holder of this document is advised that information contained herein reflects the Company's findings at the time of its intervention only and within the limits of Client's instructions, if any. The Company's sole responsibility is to its Client and this document does not exonerate parties to a transaction from exercising all their rights and obligations under the transaction documents. This document cannot be reproduced except in full, without prior written approval of the Company. Any unauthorized alteration, forgery or falsification of the content or appearance of this document is unlawful and offenders may be prosecuted to the fullest extent of the law. Unless otherwise stated the results shown in this test report refer only to the sample(s) tested and such sample(s) are retained for 30 days only.

Attention: To check the authenticity of testing/inspection report & certificate, please contact us at telephone: (86-755) 8307 1443, or email: [CN.Doccheck@sgs.com](mailto:CN.Doccheck@sgs.com)

SGS-CSTC Standards Technical Services (Xi'an) Co., Ltd. | 1/E Unit D, Building 1, Kanglong Orange Science Park, No.157, Keyuan3rd Road, Fengjing/Yue Town, Xi'an, Shaanxi, China | 710086 | t (86-29) 6282 7885 | www.sgs.com.cn  
 中国·西安·沣东新城科里三路157号康鸿橙方科技园1号楼D单元1层 | 邮编: 710086 | t (86-29) 6282 7885 | sgs.china@sgs.com

11ac80MIMO	5530	Type6	7	1	333.3	9	0.3333	300	5502	1
11ac80MIMO	5530	Type6	7	1	333.3	9	0.3333	300	5552	1
11ac80MIMO	5530	Type6	7	1	333.3	9	0.3333	300	5494	1
11ac80MIMO	5530	Type6	7	1	333.3	9	0.3333	300	5271	1
11ac80MIMO	5530	Type6	7	1	333.3	9	0.3333	300	5650	1
11ac80MIMO	5530	Type6	7	1	333.3	9	0.3333	300	5620	1
11ac80MIMO	5530	Type6	7	1	333.3	9	0.3333	300	5363	1
11ac80MIMO	5530	Type6	7	1	333.3	9	0.3333	300	5719	1
11ac80MIMO	5530	Type6	7	1	333.3	9	0.3333	300	5545	1
11ac80MIMO	5530	Type6	7	1	333.3	9	0.3333	300	5338	1
11ac80MIMO	5530	Type6	7	1	333.3	9	0.3333	300	5299	1
11ac80MIMO	5530	Type6	7	1	333.3	9	0.3333	300	5564	1
11ac80MIMO	5530	Type6	7	1	333.3	9	0.3333	300	5628	1
11ac80MIMO	5530	Type6	7	1	333.3	9	0.3333	300	5268	1
11ac80MIMO	5530	Type6	7	1	333.3	9	0.3333	300	5684	1
11ac80MIMO	5530	Type6	7	1	333.3	9	0.3333	300	5608	1
11ac80MIMO	5530	Type6	7	1	333.3	9	0.3333	300	5283	1
11ac80MIMO	5530	Type6	7	1	333.3	9	0.3333	300	5343	1
11ac80MIMO	5530	Type6	7	1	333.3	9	0.3333	300	5584	1
11ac80MIMO	5530	Type6	7	1	333.3	9	0.3333	300	5572	1
11ac80MIMO	5530	Type6	7	1	333.3	9	0.3333	300	5673	1
11ac80MIMO	5530	Type6	7	1	333.3	9	0.3333	300	5683	1
11ac80MIMO	5530	Type6	7	1	333.3	9	0.3333	300	5517	1
11ac80MIMO	5530	Type6	7	1	333.3	9	0.3333	300	5492	1
11ac80MIMO	5530	Type6	7	1	333.3	9	0.3333	300	5381	1
11ac80MIMO	5530	Type6	7	1	333.3	9	0.3333	300	5266	1
11ac80MIMO	5530	Type6	7	1	333.3	9	0.3333	300	5292	1
11ac80MIMO	5530	Type6	7	1	333.3	9	0.3333	300	5387	1
11ac80MIMO	5530	Type6	7	1	333.3	9	0.3333	300	5326	1
11ac80MIMO	5530	Type6	7	1	333.3	9	0.3333	300	5706	1
11ac80MIMO	5530	Type6	7	1	333.3	9	0.3333	300	5627	1
11ac80MIMO	5530	Type6	7	1	333.3	9	0.3333	300	5682	1
11ac80MIMO	5530	Type6	7	1	333.3	9	0.3333	300	5262	1
11ac80MIMO	5530	Type6	7	1	333.3	9	0.3333	300	5367	1
11ac80MIMO	5530	Type6	7	1	333.3	9	0.3333	300	5276	1
11ac80MIMO	5530	Type6	7	1	333.3	9	0.3333	300	5716	1
11ac80MIMO	5530	Type6	7	1	333.3	9	0.3333	300	5270	1
11ac80MIMO	5530	Type6	7	1	333.3	9	0.3333	300	5511	1
11ac80MIMO	5530	Type6	7	1	333.3	9	0.3333	300	5428	1
11ac80MIMO	5530	Type6	7	1	333.3	9	0.3333	300	5458	1
11ac80MIMO	5530	Type6	7	1	333.3	9	0.3333	300	5359	1
11ac80MIMO	5530	Type6	7	1	333.3	9	0.3333	300	5351	1
11ac80MIMO	5530	Type6	7	1	333.3	9	0.3333	300	5600	1
11ac80MIMO	5530	Type6	7	1	333.3	9	0.3333	300	5285	1
11ac80MIMO	5530	Type6	7	1	333.3	9	0.3333	300	5394	1
11ac80MIMO	5530	Type6	7	1	333.3	9	0.3333	300	5571	1
11ac80MIMO	5530	Type6	7	1	333.3	9	0.3333	300	5400	1
11ac80MIMO	5530	Type6	7	1	333.3	9	0.3333	300	5265	1
11ac80MIMO	5530	Type6	7	1	333.3	9	0.3333	300	5327	1
11ac80MIMO	5530	Type6	7	1	333.3	9	0.3333	300	5643	1
11ac80MIMO	5530	Type6	7	1	333.3	9	0.3333	300	5313	1
11ac40MIMO	5510	Type6	7	1	333.3	9	0.3333	300	5530	1
11ac40MIMO	5510	Type6	7	1	333.3	9	0.3333	300	5587	1



Unless otherwise agreed in writing, this document is issued by the Company subject to its General Conditions of Service printed overleaf, available on request or accessible at <http://www.sgs.com/en/Terms-and-Conditions.aspx> and, for electronic format documents, subject to Terms and Conditions for Electronic Documents at <http://www.sgs.com/en/Terms-and-Conditions/Terms-e-Documents.aspx>. Attention is drawn to the limitation of liability, indemnification and jurisdiction issues defined therein. Any holder of this document is advised that information contained herein reflects the Company's findings at the time of its intervention only and within the limits of Client's instructions, if any. The Company's sole responsibility is to its Client and this document does not exonerate parties to a transaction from exercising all their rights and obligations under the transaction documents. This document cannot be reproduced except in full, without prior written approval of the Company. Any unauthorized alteration, forgery or falsification of the content or appearance of this document is unlawful and offenders may be prosecuted to the fullest extent of the law. Unless otherwise stated the results shown in this test report refer only to the sample(s) tested and such sample(s) are retained for 30 days only.

Attention: To check the authenticity of testing/inspection report & certificate, please contact us at telephone: (86-755) 8307 1443, or email: [CN.Doccheck@sgs.com](mailto:CN.Doccheck@sgs.com)  
 (E) Unit D, Building 1, Kanglong Orange Science Park, No.157, Keyuan 3rd Road, Fengjing New Town, Xian, Shaanxi, China 710086  
 t (86-29) 6282 7885 www.sgs.com.cn  
 中国·西安·沣东新城科里三路157号康隆橙方科技园1号楼D单元1层 邮编: 710086 t (86-29) 6282 7885 sgs.china@sgs.com



11ac40MIMO	5510	Type6	7	1	333.3	9	0.3333	300	5361	1
11ac40MIMO	5510	Type6	7	1	333.3	9	0.3333	300	5310	1
11ac40MIMO	5510	Type6	7	1	333.3	9	0.3333	300	5480	1
11ac40MIMO	5510	Type6	7	1	333.3	9	0.3333	300	5325	1
11ac40MIMO	5510	Type6	7	1	333.3	9	0.3333	300	5598	1
11ac40MIMO	5510	Type6	7	1	333.3	9	0.3333	300	5685	1
11ac40MIMO	5510	Type6	7	1	333.3	9	0.3333	300	5500	1
11ac40MIMO	5510	Type6	7	1	333.3	9	0.3333	300	5410	1
11ac40MIMO	5510	Type6	7	1	333.3	9	0.3333	300	5523	1
11ac40MIMO	5510	Type6	7	1	333.3	9	0.3333	300	5553	1
11ac40MIMO	5510	Type6	7	1	333.3	9	0.3333	300	5676	1
11ac40MIMO	5510	Type6	7	1	333.3	9	0.3333	300	5290	1
11ac40MIMO	5510	Type6	7	1	333.3	9	0.3333	300	5260	1
11ac40MIMO	5510	Type6	7	1	333.3	9	0.3333	300	5568	1
11ac40MIMO	5510	Type6	7	1	333.3	9	0.3333	300	5383	1
11ac40MIMO	5510	Type6	7	1	333.3	9	0.3333	300	5445	1
11ac40MIMO	5510	Type6	7	1	333.3	9	0.3333	300	5603	1
11ac40MIMO	5510	Type6	7	1	333.3	9	0.3333	300	5471	1
11ac40MIMO	5510	Type6	7	1	333.3	9	0.3333	300	5498	1
11ac40MIMO	5510	Type6	7	1	333.3	9	0.3333	300	5514	1
11ac40MIMO	5510	Type6	7	1	333.3	9	0.3333	300	5690	1
11ac40MIMO	5510	Type6	7	1	333.3	9	0.3333	300	5638	1
11ac40MIMO	5510	Type6	7	1	333.3	9	0.3333	300	5697	1
11ac40MIMO	5510	Type6	7	1	333.3	9	0.3333	300	5431	1
11ac40MIMO	5510	Type6	7	1	333.3	9	0.3333	300	5583	1
11ac40MIMO	5510	Type6	7	1	333.3	9	0.3333	300	5280	1
11ac40MIMO	5510	Type6	7	1	333.3	9	0.3333	300	5404	1
11ac40MIMO	5510	Type6	7	1	333.3	9	0.3333	300	5482	1
11ac40MIMO	5510	Type6	7	1	333.3	9	0.3333	300	5451	1
11ac40MIMO	5510	Type6	7	1	333.3	9	0.3333	300	5661	1
11ac40MIMO	5510	Type6	7	1	333.3	9	0.3333	300	5670	1
11ac40MIMO	5510	Type6	7	1	333.3	9	0.3333	300	5646	1
11ac40MIMO	5510	Type6	7	1	333.3	9	0.3333	300	5354	1
11ac40MIMO	5510	Type6	7	1	333.3	9	0.3333	300	5642	1
11ac40MIMO	5510	Type6	7	1	333.3	9	0.3333	300	5331	1
11ac40MIMO	5510	Type6	7	1	333.3	9	0.3333	300	5633	1
11ac40MIMO	5510	Type6	7	1	333.3	9	0.3333	300	5594	1
11ac40MIMO	5510	Type6	7	1	333.3	9	0.3333	300	5267	1
11ac40MIMO	5510	Type6	7	1	333.3	9	0.3333	300	5301	1
11ac40MIMO	5510	Type6	7	1	333.3	9	0.3333	300	5640	1
11ac40MIMO	5510	Type6	7	1	333.3	9	0.3333	300	5369	1
11ac40MIMO	5510	Type6	7	1	333.3	9	0.3333	300	5559	1
11ac40MIMO	5510	Type6	7	1	333.3	9	0.3333	300	5622	1
11ac40MIMO	5510	Type6	7	1	333.3	9	0.3333	300	5277	1
11ac40MIMO	5510	Type6	7	1	333.3	9	0.3333	300	5391	1
11ac40MIMO	5510	Type6	7	1	333.3	9	0.3333	300	5507	1
11ac40MIMO	5510	Type6	7	1	333.3	9	0.3333	300	5396	1
11ac40MIMO	5510	Type6	7	1	333.3	9	0.3333	300	5502	1
11ac40MIMO	5510	Type6	7	1	333.3	9	0.3333	300	5552	1
11ac40MIMO	5510	Type6	7	1	333.3	9	0.3333	300	5494	1
11ac40MIMO	5510	Type6	7	1	333.3	9	0.3333	300	5271	1
11ac40MIMO	5510	Type6	7	1	333.3	9	0.3333	300	5650	1
11ac40MIMO	5510	Type6	7	1	333.3	9	0.3333	300	5620	1



Unless otherwise agreed in writing, this document is issued by the Company subject to its General Conditions of Service printed overleaf, available on request or accessible at <http://www.sgs.com/en/Terms-and-Conditions.aspx> and, for electronic format documents, subject to Terms and Conditions for Electronic Documents at <http://www.sgs.com/en/Terms-and-Conditions/Terms-e-Documents.aspx>. Attention is drawn to the limitation of liability, indemnification and jurisdiction issues defined therein. Any holder of this document is advised that information contained herein reflects the Company's findings at the time of its intervention only and within the limits of Client's instructions, if any. The Company's sole responsibility is to its Client and this document does not exonerate parties to a transaction from exercising all their rights and obligations under the transaction documents. This document cannot be reproduced except in full, without prior written approval of the Company. Any unauthorized alteration, forgery or falsification of the content or appearance of this document is unlawful and offenders may be prosecuted to the fullest extent of the law. Unless otherwise stated the results shown in this test report refer only to the sample(s) tested and such sample(s) are retained for 30 days only.

Attention: To check the authenticity of testing/inspection report & certificate, please contact us at telephone: (86-755) 8307 1443, or email: [CN.Doccheck@sgs.com](mailto:CN.Doccheck@sgs.com)  
 (E) Unit D, Building 1, Kanglong Orange Science Park, No.157, Keyuan 3rd Road, Fengjing/Yue Town, Xian, Shaanxi, China 710086 t (86-29) 6282 7885 www.sgs.com.cn  
 中国·西安·沣东新城科里三路157号康隆橙方科技园1号楼D单元1层 邮编: 710086 t (86-29) 6282 7885 sgs.china@sgs.com



Report No.: XEWA2310000070RG05

Rev.: 01

Page: 133 of 267

11ac40MIMO	5510	Type6	7	1	333.3	9	0.3333	300	5363	1
11ac40MIMO	5510	Type6	7	1	333.3	9	0.3333	300	5719	1
11ac40MIMO	5510	Type6	7	1	333.3	9	0.3333	300	5545	1
11ac40MIMO	5510	Type6	7	1	333.3	9	0.3333	300	5338	1
11ac40MIMO	5510	Type6	7	1	333.3	9	0.3333	300	5299	1
11ac40MIMO	5510	Type6	7	1	333.3	9	0.3333	300	5564	1
11ac40MIMO	5510	Type6	7	1	333.3	9	0.3333	300	5628	1
11ac40MIMO	5510	Type6	7	1	333.3	9	0.3333	300	5268	1
11ac40MIMO	5510	Type6	7	1	333.3	9	0.3333	300	5684	1
11ac40MIMO	5510	Type6	7	1	333.3	9	0.3333	300	5608	1
11ac40MIMO	5510	Type6	7	1	333.3	9	0.3333	300	5283	1
11ac40MIMO	5510	Type6	7	1	333.3	9	0.3333	300	5343	1
11ac40MIMO	5510	Type6	7	1	333.3	9	0.3333	300	5584	1
11ac40MIMO	5510	Type6	7	1	333.3	9	0.3333	300	5572	1
11ac40MIMO	5510	Type6	7	1	333.3	9	0.3333	300	5673	1
11ac40MIMO	5510	Type6	7	1	333.3	9	0.3333	300	5683	1
11ac40MIMO	5510	Type6	7	1	333.3	9	0.3333	300	5517	1
11ac40MIMO	5510	Type6	7	1	333.3	9	0.3333	300	5492	1
11ac40MIMO	5510	Type6	7	1	333.3	9	0.3333	300	5381	1
11ac40MIMO	5510	Type6	7	1	333.3	9	0.3333	300	5266	1
11ac40MIMO	5510	Type6	7	1	333.3	9	0.3333	300	5292	1
11ac40MIMO	5510	Type6	7	1	333.3	9	0.3333	300	5387	1
11ac40MIMO	5510	Type6	7	1	333.3	9	0.3333	300	5326	1
11ac40MIMO	5510	Type6	7	1	333.3	9	0.3333	300	5706	1
11ac40MIMO	5510	Type6	7	1	333.3	9	0.3333	300	5627	1
11ac40MIMO	5510	Type6	7	1	333.3	9	0.3333	300	5682	1
11ac40MIMO	5510	Type6	7	1	333.3	9	0.3333	300	5262	1
11ac40MIMO	5510	Type6	7	1	333.3	9	0.3333	300	5367	1
11ac40MIMO	5510	Type6	7	1	333.3	9	0.3333	300	5276	1
11ac40MIMO	5510	Type6	7	1	333.3	9	0.3333	300	5716	1
11ac40MIMO	5510	Type6	7	1	333.3	9	0.3333	300	5270	1
11ac40MIMO	5510	Type6	7	1	333.3	9	0.3333	300	5511	1
11ac40MIMO	5510	Type6	7	1	333.3	9	0.3333	300	5428	1
11ac40MIMO	5510	Type6	7	1	333.3	9	0.3333	300	5458	1
11ac40MIMO	5510	Type6	7	1	333.3	9	0.3333	300	5359	1
11ac40MIMO	5510	Type6	7	1	333.3	9	0.3333	300	5351	1
11ac40MIMO	5510	Type6	7	1	333.3	9	0.3333	300	5600	1
11ac40MIMO	5510	Type6	7	1	333.3	9	0.3333	300	5285	1
11ac40MIMO	5510	Type6	7	1	333.3	9	0.3333	300	5394	1
11ac40MIMO	5510	Type6	7	1	333.3	9	0.3333	300	5571	1
11ac40MIMO	5510	Type6	7	1	333.3	9	0.3333	300	5400	1
11ac40MIMO	5510	Type6	7	1	333.3	9	0.3333	300	5265	1
11ac40MIMO	5510	Type6	7	1	333.3	9	0.3333	300	5327	1
11ac40MIMO	5510	Type6	7	1	333.3	9	0.3333	300	5643	1
11ac40MIMO	5510	Type6	7	1	333.3	9	0.3333	300	5313	1
11ac20MIMO	5500	Type6	7	1	333.3	9	0.3333	300	5530	1
11ac20MIMO	5500	Type6	7	1	333.3	9	0.3333	300	5587	1
11ac20MIMO	5500	Type6	7	1	333.3	9	0.3333	300	5361	1
11ac20MIMO	5500	Type6	7	1	333.3	9	0.3333	300	5310	1
11ac20MIMO	5500	Type6	7	1	333.3	9	0.3333	300	5480	1
11ac20MIMO	5500	Type6	7	1	333.3	9	0.3333	300	5325	1
11ac20MIMO	5500	Type6	7	1	333.3	9	0.3333	300	5598	1
11ac20MIMO	5500	Type6	7	1	333.3	9	0.3333	300	5685	1



Unless otherwise agreed in writing, this document is issued by the Company subject to its General Conditions of Service printed overleaf, available on request or accessible at <http://www.sgs.com/en/Terms-and-Conditions.aspx> and, for electronic format documents, subject to Terms and Conditions for Electronic Documents at <http://www.sgs.com/en/Terms-and-Conditions/Terms-e-Documents.aspx>. Attention is drawn to the limitation of liability, indemnification and jurisdiction issues defined therein. Any holder of this document is advised that information contained herein reflects the Company's findings at the time of its intervention only and within the limits of Client's instructions, if any. The Company's sole responsibility is to its Client and this document does not exonerate parties to a transaction from exercising all their rights and obligations under the transaction documents. This document cannot be reproduced except in full, without prior written approval of the Company. Any unauthorized alteration, forgery or falsification of the content or appearance of this document is unlawful and offenders may be prosecuted to the fullest extent of the law. Unless otherwise stated the results shown in this test report refer only to the sample(s) tested and such sample(s) are retained for 30 days only.

Attention: To check the authenticity of testing/inspection report & certificate, please contact us at telephone: (86-755) 8307 1443, or email: [CN.Doccheck@sgs.com](mailto:CN.Doccheck@sgs.com)  
 (E) Unit D, Building 1, Kanglong Orange Science Park, No.157, Keyuan 3rd Road, Fengyang New Town, Xi'an, Shaanxi, China 710086  
 t (86-29) 6282 7885 www.sgs.com.cn  
 中国·西安·沣东新城科里三路157号康隆橙方科技园1号楼D单元1层 邮编: 710086 t (86-29) 6282 7885 sgs.china@sgs.com

11ac20MIMO	5500	Type6	7	1	333.3	9	0.3333	300	5500	1
11ac20MIMO	5500	Type6	7	1	333.3	9	0.3333	300	5410	1
11ac20MIMO	5500	Type6	7	1	333.3	9	0.3333	300	5523	1
11ac20MIMO	5500	Type6	7	1	333.3	9	0.3333	300	5553	1
11ac20MIMO	5500	Type6	7	1	333.3	9	0.3333	300	5676	1
11ac20MIMO	5500	Type6	7	1	333.3	9	0.3333	300	5290	1
11ac20MIMO	5500	Type6	7	1	333.3	9	0.3333	300	5260	1
11ac20MIMO	5500	Type6	7	1	333.3	9	0.3333	300	5568	1
11ac20MIMO	5500	Type6	7	1	333.3	9	0.3333	300	5383	1
11ac20MIMO	5500	Type6	7	1	333.3	9	0.3333	300	5445	1
11ac20MIMO	5500	Type6	7	1	333.3	9	0.3333	300	5603	1
11ac20MIMO	5500	Type6	7	1	333.3	9	0.3333	300	5471	1
11ac20MIMO	5500	Type6	7	1	333.3	9	0.3333	300	5498	1
11ac20MIMO	5500	Type6	7	1	333.3	9	0.3333	300	5514	1
11ac20MIMO	5500	Type6	7	1	333.3	9	0.3333	300	5690	1
11ac20MIMO	5500	Type6	7	1	333.3	9	0.3333	300	5638	1
11ac20MIMO	5500	Type6	7	1	333.3	9	0.3333	300	5697	1
11ac20MIMO	5500	Type6	7	1	333.3	9	0.3333	300	5431	1
11ac20MIMO	5500	Type6	7	1	333.3	9	0.3333	300	5583	1
11ac20MIMO	5500	Type6	7	1	333.3	9	0.3333	300	5280	1
11ac20MIMO	5500	Type6	7	1	333.3	9	0.3333	300	5404	1
11ac20MIMO	5500	Type6	7	1	333.3	9	0.3333	300	5482	1
11ac20MIMO	5500	Type6	7	1	333.3	9	0.3333	300	5451	1
11ac20MIMO	5500	Type6	7	1	333.3	9	0.3333	300	5661	1
11ac20MIMO	5500	Type6	7	1	333.3	9	0.3333	300	5670	1
11ac20MIMO	5500	Type6	7	1	333.3	9	0.3333	300	5646	1
11ac20MIMO	5500	Type6	7	1	333.3	9	0.3333	300	5354	1
11ac20MIMO	5500	Type6	7	1	333.3	9	0.3333	300	5642	1
11ac20MIMO	5500	Type6	7	1	333.3	9	0.3333	300	5331	1
11ac20MIMO	5500	Type6	7	1	333.3	9	0.3333	300	5633	1
11ac20MIMO	5500	Type6	7	1	333.3	9	0.3333	300	5594	1
11ac20MIMO	5500	Type6	7	1	333.3	9	0.3333	300	5267	1
11ac20MIMO	5500	Type6	7	1	333.3	9	0.3333	300	5301	1
11ac20MIMO	5500	Type6	7	1	333.3	9	0.3333	300	5640	1
11ac20MIMO	5500	Type6	7	1	333.3	9	0.3333	300	5369	1
11ac20MIMO	5500	Type6	7	1	333.3	9	0.3333	300	5559	1
11ac20MIMO	5500	Type6	7	1	333.3	9	0.3333	300	5622	1
11ac20MIMO	5500	Type6	7	1	333.3	9	0.3333	300	5277	1
11ac20MIMO	5500	Type6	7	1	333.3	9	0.3333	300	5391	1
11ac20MIMO	5500	Type6	7	1	333.3	9	0.3333	300	5507	1
11ac20MIMO	5500	Type6	7	1	333.3	9	0.3333	300	5396	1
11ac20MIMO	5500	Type6	7	1	333.3	9	0.3333	300	5502	1
11ac20MIMO	5500	Type6	7	1	333.3	9	0.3333	300	5552	1
11ac20MIMO	5500	Type6	7	1	333.3	9	0.3333	300	5494	1
11ac20MIMO	5500	Type6	7	1	333.3	9	0.3333	300	5271	1
11ac20MIMO	5500	Type6	7	1	333.3	9	0.3333	300	5650	1
11ac20MIMO	5500	Type6	7	1	333.3	9	0.3333	300	5620	1
11ac20MIMO	5500	Type6	7	1	333.3	9	0.3333	300	5363	1
11ac20MIMO	5500	Type6	7	1	333.3	9	0.3333	300	5719	1
11ac20MIMO	5500	Type6	7	1	333.3	9	0.3333	300	5545	1
11ac20MIMO	5500	Type6	7	1	333.3	9	0.3333	300	5338	1
11ac20MIMO	5500	Type6	7	1	333.3	9	0.3333	300	5299	1
11ac20MIMO	5500	Type6	7	1	333.3	9	0.3333	300	5564	1



Unless otherwise agreed in writing, this document is issued by the Company subject to its General Conditions of Service printed overleaf, available on request or accessible at <http://www.sgs.com/en/Terms-and-Conditions.aspx> and, for electronic format documents, subject to Terms and Conditions for Electronic Documents at <http://www.sgs.com/en/Terms-and-Conditions/Terms-e-Documents.aspx>. Attention is drawn to the limitation of liability, indemnification and jurisdiction issues defined therein. Any holder of this document is advised that information contained herein reflects the Company's findings at the time of its intervention only and within the limits of Client's instructions, if any. The Company's sole responsibility is to its Client and this document does not exonerate parties to a transaction from exercising all their rights and obligations under the transaction documents. This document cannot be reproduced except in full, without prior written approval of the Company. Any unauthorized alteration, forgery or falsification of the content or appearance of this document is unlawful and offenders may be prosecuted to the fullest extent of the law. Unless otherwise stated the results shown in this test report refer only to the sample(s) tested and such sample(s) are retained for 30 days only.

Attention: To check the authenticity of testing/inspection report & certificate, please contact us at telephone: (86-755) 8307 1443, or email: [CN.Doccheck@sgs.com](mailto:CN.Doccheck@sgs.com)

SGS-CSTC Standards Technical Services (Xi'an) Co., Ltd. | 1/E Unit D, Building 1, Kanglong Orange Science Park, No.157, Keyuan 3rd Road, Fengyang New Town, Xi'an, Shaanxi, China | 710086 | t (86-29) 6282 7885 | www.sgs.com.cn  
 中国·西安·沣东新城科里三路157号康鸿橙方科技园1号楼D单元1层 | 邮编: 710086 | t (86-29) 6282 7885 | sgs.china@sgs.com



11ac20MIMO	5500	Type6	7	1	333.3	9	0.3333	300	5628	1
11ac20MIMO	5500	Type6	7	1	333.3	9	0.3333	300	5268	1
11ac20MIMO	5500	Type6	7	1	333.3	9	0.3333	300	5684	1
11ac20MIMO	5500	Type6	7	1	333.3	9	0.3333	300	5608	1
11ac20MIMO	5500	Type6	7	1	333.3	9	0.3333	300	5283	1
11ac20MIMO	5500	Type6	7	1	333.3	9	0.3333	300	5343	1
11ac20MIMO	5500	Type6	7	1	333.3	9	0.3333	300	5584	1
11ac20MIMO	5500	Type6	7	1	333.3	9	0.3333	300	5572	1
11ac20MIMO	5500	Type6	7	1	333.3	9	0.3333	300	5673	1
11ac20MIMO	5500	Type6	7	1	333.3	9	0.3333	300	5683	1
11ac20MIMO	5500	Type6	7	1	333.3	9	0.3333	300	5517	1
11ac20MIMO	5500	Type6	7	1	333.3	9	0.3333	300	5492	1
11ac20MIMO	5500	Type6	7	1	333.3	9	0.3333	300	5381	1
11ac20MIMO	5500	Type6	7	1	333.3	9	0.3333	300	5266	1
11ac20MIMO	5500	Type6	7	1	333.3	9	0.3333	300	5292	1
11ac20MIMO	5500	Type6	7	1	333.3	9	0.3333	300	5387	1
11ac20MIMO	5500	Type6	7	1	333.3	9	0.3333	300	5326	1
11ac20MIMO	5500	Type6	7	1	333.3	9	0.3333	300	5706	1
11ac20MIMO	5500	Type6	7	1	333.3	9	0.3333	300	5627	1
11ac20MIMO	5500	Type6	7	1	333.3	9	0.3333	300	5682	1
11ac20MIMO	5500	Type6	7	1	333.3	9	0.3333	300	5262	1
11ac20MIMO	5500	Type6	7	1	333.3	9	0.3333	300	5367	1
11ac20MIMO	5500	Type6	7	1	333.3	9	0.3333	300	5276	1
11ac20MIMO	5500	Type6	7	1	333.3	9	0.3333	300	5716	1
11ac20MIMO	5500	Type6	7	1	333.3	9	0.3333	300	5270	1
11ac20MIMO	5500	Type6	7	1	333.3	9	0.3333	300	5511	1
11ac20MIMO	5500	Type6	7	1	333.3	9	0.3333	300	5428	1
11ac20MIMO	5500	Type6	7	1	333.3	9	0.3333	300	5458	1
11ac20MIMO	5500	Type6	7	1	333.3	9	0.3333	300	5359	1
11ac20MIMO	5500	Type6	7	1	333.3	9	0.3333	300	5351	1
11ac20MIMO	5500	Type6	7	1	333.3	9	0.3333	300	5600	1
11ac20MIMO	5500	Type6	7	1	333.3	9	0.3333	300	5285	1
11ac20MIMO	5500	Type6	7	1	333.3	9	0.3333	300	5394	1
11ac20MIMO	5500	Type6	7	1	333.3	9	0.3333	300	5571	1
11ac20MIMO	5500	Type6	7	1	333.3	9	0.3333	300	5400	1
11ac20MIMO	5500	Type6	7	1	333.3	9	0.3333	300	5265	1
11ac20MIMO	5500	Type6	7	1	333.3	9	0.3333	300	5327	1
11ac20MIMO	5500	Type6	7	1	333.3	9	0.3333	300	5643	1
11ac20MIMO	5500	Type6	7	1	333.3	9	0.3333	300	5313	1



Unless otherwise agreed in writing, this document is issued by the Company subject to its General Conditions of Service printed overleaf, available on request or accessible at <http://www.sgs.com/en/Terms-and-Conditions.aspx> and, for electronic format documents, subject to Terms and Conditions for Electronic Documents at <http://www.sgs.com/en/Terms-and-Conditions/Terms-e-Documents.aspx>. Attention is drawn to the limitation of liability, indemnification and jurisdiction issues defined therein. Any holder of this document is advised that information contained herein reflects the Company's findings at the time of its intervention only and within the limits of Client's instructions, if any. The Company's sole responsibility is to its Client and this document does not exonerate parties to a transaction from exercising all their rights and obligations under the transaction documents. This document cannot be reproduced except in full, without prior written approval of the Company. Any unauthorized alteration, forgery or falsification of the content or appearance of this document is unlawful and offenders may be prosecuted to the fullest extent of the law. Unless otherwise stated the results shown in this test report refer only to the sample(s) tested and such sample(s) are retained for 30 days only.

Attention: To check the authenticity of testing/inspection report & certificate, please contact us at telephone: (86-755) 4307 1443, or email: CN.Doccheck@sgs.com  
 (SGS-CSTC) Standards Technical Services (Xi'an) Co., Ltd. | 1 (86-29) 6282 7885 | www.sgs.com.cn  
 中国·西安·沣东新城科星三路137号康鸿楼方科技园1号楼D单元1层 | 邮编: 710086 | 1 (86-29) 6282 7885 | sgs.china@sgs.com

TestMode	Channel	Radar Type	Trial ID	Pulse width (μs)	PRI (μs)	Pulses per Hop	Hop Rate (kHz)	Hop Sequence Length(ms)	Center Frequency (MHz)	Detection (1: Yes; 0: No)
11ac80MIMO	5530	Type6	8	1	333.3	9	0.3333	300	5310	1
11ac80MIMO	5530	Type6	8	1	333.3	9	0.3333	300	5351	1
11ac80MIMO	5530	Type6	8	1	333.3	9	0.3333	300	5297	1
11ac80MIMO	5530	Type6	8	1	333.3	9	0.3333	300	5374	1
11ac80MIMO	5530	Type6	8	1	333.3	9	0.3333	300	5322	1
11ac80MIMO	5530	Type6	8	1	333.3	9	0.3333	300	5367	1
11ac80MIMO	5530	Type6	8	1	333.3	9	0.3333	300	5523	1
11ac80MIMO	5530	Type6	8	1	333.3	9	0.3333	300	5285	1
11ac80MIMO	5530	Type6	8	1	333.3	9	0.3333	300	5663	1
11ac80MIMO	5530	Type6	8	1	333.3	9	0.3333	300	5617	1
11ac80MIMO	5530	Type6	8	1	333.3	9	0.3333	300	5454	1
11ac80MIMO	5530	Type6	8	1	333.3	9	0.3333	300	5342	1
11ac80MIMO	5530	Type6	8	1	333.3	9	0.3333	300	5717	1
11ac80MIMO	5530	Type6	8	1	333.3	9	0.3333	300	5485	1
11ac80MIMO	5530	Type6	8	1	333.3	9	0.3333	300	5281	1
11ac80MIMO	5530	Type6	8	1	333.3	9	0.3333	300	5656	1
11ac80MIMO	5530	Type6	8	1	333.3	9	0.3333	300	5510	1
11ac80MIMO	5530	Type6	8	1	333.3	9	0.3333	300	5548	1
11ac80MIMO	5530	Type6	8	1	333.3	9	0.3333	300	5648	1
11ac80MIMO	5530	Type6	8	1	333.3	9	0.3333	300	5409	1
11ac80MIMO	5530	Type6	8	1	333.3	9	0.3333	300	5680	1
11ac80MIMO	5530	Type6	8	1	333.3	9	0.3333	300	5631	1
11ac80MIMO	5530	Type6	8	1	333.3	9	0.3333	300	5630	1
11ac80MIMO	5530	Type6	8	1	333.3	9	0.3333	300	5670	1
11ac80MIMO	5530	Type6	8	1	333.3	9	0.3333	300	5319	1
11ac80MIMO	5530	Type6	8	1	333.3	9	0.3333	300	5435	1
11ac80MIMO	5530	Type6	8	1	333.3	9	0.3333	300	5483	1
11ac80MIMO	5530	Type6	8	1	333.3	9	0.3333	300	5508	1
11ac80MIMO	5530	Type6	8	1	333.3	9	0.3333	300	5516	1
11ac80MIMO	5530	Type6	8	1	333.3	9	0.3333	300	5493	1
11ac80MIMO	5530	Type6	8	1	333.3	9	0.3333	300	5647	1
11ac80MIMO	5530	Type6	8	1	333.3	9	0.3333	300	5627	1
11ac80MIMO	5530	Type6	8	1	333.3	9	0.3333	300	5386	1
11ac80MIMO	5530	Type6	8	1	333.3	9	0.3333	300	5506	1
11ac80MIMO	5530	Type6	8	1	333.3	9	0.3333	300	5462	1
11ac80MIMO	5530	Type6	8	1	333.3	9	0.3333	300	5470	1
11ac80MIMO	5530	Type6	8	1	333.3	9	0.3333	300	5724	1
11ac80MIMO	5530	Type6	8	1	333.3	9	0.3333	300	5390	1
11ac80MIMO	5530	Type6	8	1	333.3	9	0.3333	300	5420	1
11ac80MIMO	5530	Type6	8	1	333.3	9	0.3333	300	5690	1
11ac80MIMO	5530	Type6	8	1	333.3	9	0.3333	300	5576	1
11ac80MIMO	5530	Type6	8	1	333.3	9	0.3333	300	5452	1
11ac80MIMO	5530	Type6	8	1	333.3	9	0.3333	300	5497	1
11ac80MIMO	5530	Type6	8	1	333.3	9	0.3333	300	5387	1
11ac80MIMO	5530	Type6	8	1	333.3	9	0.3333	300	5274	1
11ac80MIMO	5530	Type6	8	1	333.3	9	0.3333	300	5320	1
11ac80MIMO	5530	Type6	8	1	333.3	9	0.3333	300	5487	1
11ac80MIMO	5530	Type6	8	1	333.3	9	0.3333	300	5479	1
11ac80MIMO	5530	Type6	8	1	333.3	9	0.3333	300	5560	1



Unless otherwise agreed in writing, this document is issued by the Company subject to its General Conditions of Service printed overleaf, available on request or accessible at <http://www.sgs.com/en/Terms-and-Conditions.aspx> and, for electronic format documents, subject to Terms and Conditions for Electronic Documents at <http://www.sgs.com/en/Terms-and-Conditions/Terms-e-Documents.aspx>. Attention is drawn to the limitation of liability, indemnification and jurisdiction issues defined therein. Any holder of this document is advised that information contained herein reflects the Company's findings at the time of its intervention only and within the limits of Client's instructions, if any. The Company's sole responsibility is to its Client and this document does not exonerate parties to a transaction from exercising all their rights and obligations under the transaction documents. This document cannot be reproduced except in full, without prior written approval of the Company. Any unauthorized alteration, forgery or falsification of the content or appearance of this document is unlawful and offenders may be prosecuted to the fullest extent of the law. Unless otherwise stated the results shown in this test report refer only to the sample(s) tested and such sample(s) are retained for 30 days only.

Attention: To check the authenticity of testing/inspection report & certificate, please contact us at telephone: (86-755) 8307 1443, or email: [CN.Doccheck@sgs.com](mailto:CN.Doccheck@sgs.com)

SGS-CSTC Standards Technical Services (Xi'an) Co., Ltd. | 1/E Unit D, Building 1, Kanglong Orange Science Park, No.157, Keyuan3rd Road, Fengjing/Yue Town, Xi'an, Shaanxi, China | 710086 | t (86-29) 6282 7885 | www.sgs.com.cn  
 中国·西安·沣东新城科里三路157号康鸿橙方科技园1号楼D单元1层 | 邮编: 710086 | t (86-29) 6282 7885 | sgs.china@sgs.com





11ac80MIMO	5530	Type6	8	1	333.3	9	0.3333	300	5605	1
11ac80MIMO	5530	Type6	8	1	333.3	9	0.3333	300	5381	1
11ac80MIMO	5530	Type6	8	1	333.3	9	0.3333	300	5622	1
11ac80MIMO	5530	Type6	8	1	333.3	9	0.3333	300	5671	1
11ac80MIMO	5530	Type6	8	1	333.3	9	0.3333	300	5445	1
11ac80MIMO	5530	Type6	8	1	333.3	9	0.3333	300	5489	1
11ac80MIMO	5530	Type6	8	1	333.3	9	0.3333	300	5526	1
11ac80MIMO	5530	Type6	8	1	333.3	9	0.3333	300	5253	1
11ac80MIMO	5530	Type6	8	1	333.3	9	0.3333	300	5279	1
11ac80MIMO	5530	Type6	8	1	333.3	9	0.3333	300	5502	1
11ac80MIMO	5530	Type6	8	1	333.3	9	0.3333	300	5397	1
11ac80MIMO	5530	Type6	8	1	333.3	9	0.3333	300	5629	1
11ac80MIMO	5530	Type6	8	1	333.3	9	0.3333	300	5440	1
11ac80MIMO	5530	Type6	8	1	333.3	9	0.3333	300	5678	1
11ac80MIMO	5530	Type6	8	1	333.3	9	0.3333	300	5704	1
11ac80MIMO	5530	Type6	8	1	333.3	9	0.3333	300	5544	1
11ac80MIMO	5530	Type6	8	1	333.3	9	0.3333	300	5533	1
11ac80MIMO	5530	Type6	8	1	333.3	9	0.3333	300	5608	1
11ac80MIMO	5530	Type6	8	1	333.3	9	0.3333	300	5408	1
11ac80MIMO	5530	Type6	8	1	333.3	9	0.3333	300	5478	1
11ac80MIMO	5530	Type6	8	1	333.3	9	0.3333	300	5655	1
11ac80MIMO	5530	Type6	8	1	333.3	9	0.3333	300	5481	1
11ac80MIMO	5530	Type6	8	1	333.3	9	0.3333	300	5590	1
11ac80MIMO	5530	Type6	8	1	333.3	9	0.3333	300	5268	1
11ac80MIMO	5530	Type6	8	1	333.3	9	0.3333	300	5346	1
11ac80MIMO	5530	Type6	8	1	333.3	9	0.3333	300	5673	1
11ac80MIMO	5530	Type6	8	1	333.3	9	0.3333	300	5254	1
11ac80MIMO	5530	Type6	8	1	333.3	9	0.3333	300	5295	1
11ac80MIMO	5530	Type6	8	1	333.3	9	0.3333	300	5258	1
11ac80MIMO	5530	Type6	8	1	333.3	9	0.3333	300	5459	1
11ac80MIMO	5530	Type6	8	1	333.3	9	0.3333	300	5372	1
11ac80MIMO	5530	Type6	8	1	333.3	9	0.3333	300	5623	1
11ac80MIMO	5530	Type6	8	1	333.3	9	0.3333	300	5401	1
11ac80MIMO	5530	Type6	8	1	333.3	9	0.3333	300	5267	1
11ac80MIMO	5530	Type6	8	1	333.3	9	0.3333	300	5706	1
11ac80MIMO	5530	Type6	8	1	333.3	9	0.3333	300	5545	1
11ac80MIMO	5530	Type6	8	1	333.3	9	0.3333	300	5488	1
11ac80MIMO	5530	Type6	8	1	333.3	9	0.3333	300	5650	1
11ac80MIMO	5530	Type6	8	1	333.3	9	0.3333	300	5324	1
11ac80MIMO	5530	Type6	8	1	333.3	9	0.3333	300	5305	1
11ac80MIMO	5530	Type6	8	1	333.3	9	0.3333	300	5373	1
11ac80MIMO	5530	Type6	8	1	333.3	9	0.3333	300	5559	1
11ac80MIMO	5530	Type6	8	1	333.3	9	0.3333	300	5464	1
11ac80MIMO	5530	Type6	8	1	333.3	9	0.3333	300	5660	1
11ac80MIMO	5530	Type6	8	1	333.3	9	0.3333	300	5344	1
11ac80MIMO	5530	Type6	8	1	333.3	9	0.3333	300	5698	1
11ac80MIMO	5530	Type6	8	1	333.3	9	0.3333	300	5394	1
11ac80MIMO	5530	Type6	8	1	333.3	9	0.3333	300	5378	1
11ac80MIMO	5530	Type6	8	1	333.3	9	0.3333	300	5363	1
11ac80MIMO	5530	Type6	8	1	333.3	9	0.3333	300	5321	1
11ac80MIMO	5530	Type6	8	1	333.3	9	0.3333	300	5311	1
11ac40MIMO	5510	Type6	8	1	333.3	9	0.3333	300	5310	1
11ac40MIMO	5510	Type6	8	1	333.3	9	0.3333	300	5351	1



Unless otherwise agreed in writing, this document is issued by the Company subject to its General Conditions of Service printed overleaf, available on request or accessible at <http://www.sgs.com/en/Terms-and-Conditions.aspx> and, for electronic format documents, subject to Terms and Conditions for Electronic Documents at <http://www.sgs.com/en/Terms-and-Conditions/Terms-e-Documents.aspx>. Attention is drawn to the limitation of liability, indemnification and jurisdiction issues defined therein. Any holder of this document is advised that information contained herein reflects the Company's findings at the time of its intervention only and within the limits of Client's instructions, if any. The Company's sole responsibility is to its Client and this document does not exonerate parties to a transaction from exercising all their rights and obligations under the transaction documents. This document cannot be reproduced except in full, without prior written approval of the Company. Any unauthorized alteration, forgery or falsification of the content or appearance of this document is unlawful and offenders may be prosecuted to the fullest extent of the law. Unless otherwise stated the results shown in this test report refer only to the sample(s) tested and such sample(s) are retained for 30 days only.

Attention: To check the authenticity of testing inspection report & certificate, please contact us at telephone: (86-755) 8307 1443, or email: [CN.Doccheck@sgs.com](mailto:CN.Doccheck@sgs.com)  
 (E) Unit D, Building 1, Kanglong Orange Science Park, No.157, Keyuan 3rd Road, Fengyang New Town, Xian, Shaanxi, China 710086  
 t (86-29) 6282 7885 www.sgs.com.cn  
 中国·西安·沣东新城科里三路157号康隆橙方科技园1号楼D单元1层 邮编: 710086 t (86-29) 6282 7885 sgs.china@sgs.com



Report No.: XEWA2310000070RG05
Rev.: 01
Page: 138 of 267

Table with 11 columns: Sample ID, Value 1, Type, Value 2, Value 3, Value 4, Value 5, Value 6, Value 7, Value 8, Value 9. Rows contain data for 11ac40MIMO samples.



Unless otherwise agreed in writing, this document is issued by the Company subject to its General Conditions of Service printed overleaf... Attention: To check the authenticity of testing/inspection report & certificate, please contact us at telephone: (86-755) 8307 1443, or email: CN.Doccheck@sgs.com

11ac40MIMO	5510	Type6	8	1	333.3	9	0.3333	300	5526	1
11ac40MIMO	5510	Type6	8	1	333.3	9	0.3333	300	5253	1
11ac40MIMO	5510	Type6	8	1	333.3	9	0.3333	300	5279	1
11ac40MIMO	5510	Type6	8	1	333.3	9	0.3333	300	5502	1
11ac40MIMO	5510	Type6	8	1	333.3	9	0.3333	300	5397	1
11ac40MIMO	5510	Type6	8	1	333.3	9	0.3333	300	5629	1
11ac40MIMO	5510	Type6	8	1	333.3	9	0.3333	300	5440	1
11ac40MIMO	5510	Type6	8	1	333.3	9	0.3333	300	5678	1
11ac40MIMO	5510	Type6	8	1	333.3	9	0.3333	300	5704	1
11ac40MIMO	5510	Type6	8	1	333.3	9	0.3333	300	5544	1
11ac40MIMO	5510	Type6	8	1	333.3	9	0.3333	300	5533	1
11ac40MIMO	5510	Type6	8	1	333.3	9	0.3333	300	5608	1
11ac40MIMO	5510	Type6	8	1	333.3	9	0.3333	300	5408	1
11ac40MIMO	5510	Type6	8	1	333.3	9	0.3333	300	5478	1
11ac40MIMO	5510	Type6	8	1	333.3	9	0.3333	300	5655	1
11ac40MIMO	5510	Type6	8	1	333.3	9	0.3333	300	5481	1
11ac40MIMO	5510	Type6	8	1	333.3	9	0.3333	300	5590	1
11ac40MIMO	5510	Type6	8	1	333.3	9	0.3333	300	5268	1
11ac40MIMO	5510	Type6	8	1	333.3	9	0.3333	300	5346	1
11ac40MIMO	5510	Type6	8	1	333.3	9	0.3333	300	5673	1
11ac40MIMO	5510	Type6	8	1	333.3	9	0.3333	300	5254	1
11ac40MIMO	5510	Type6	8	1	333.3	9	0.3333	300	5295	1
11ac40MIMO	5510	Type6	8	1	333.3	9	0.3333	300	5258	1
11ac40MIMO	5510	Type6	8	1	333.3	9	0.3333	300	5459	1
11ac40MIMO	5510	Type6	8	1	333.3	9	0.3333	300	5372	1
11ac40MIMO	5510	Type6	8	1	333.3	9	0.3333	300	5623	1
11ac40MIMO	5510	Type6	8	1	333.3	9	0.3333	300	5401	1
11ac40MIMO	5510	Type6	8	1	333.3	9	0.3333	300	5267	1
11ac40MIMO	5510	Type6	8	1	333.3	9	0.3333	300	5706	1
11ac40MIMO	5510	Type6	8	1	333.3	9	0.3333	300	5545	1
11ac40MIMO	5510	Type6	8	1	333.3	9	0.3333	300	5488	1
11ac40MIMO	5510	Type6	8	1	333.3	9	0.3333	300	5650	1
11ac40MIMO	5510	Type6	8	1	333.3	9	0.3333	300	5324	1
11ac40MIMO	5510	Type6	8	1	333.3	9	0.3333	300	5305	1
11ac40MIMO	5510	Type6	8	1	333.3	9	0.3333	300	5373	1
11ac40MIMO	5510	Type6	8	1	333.3	9	0.3333	300	5559	1
11ac40MIMO	5510	Type6	8	1	333.3	9	0.3333	300	5464	1
11ac40MIMO	5510	Type6	8	1	333.3	9	0.3333	300	5660	1
11ac40MIMO	5510	Type6	8	1	333.3	9	0.3333	300	5344	1
11ac40MIMO	5510	Type6	8	1	333.3	9	0.3333	300	5698	1
11ac40MIMO	5510	Type6	8	1	333.3	9	0.3333	300	5394	1
11ac40MIMO	5510	Type6	8	1	333.3	9	0.3333	300	5378	1
11ac40MIMO	5510	Type6	8	1	333.3	9	0.3333	300	5363	1
11ac40MIMO	5510	Type6	8	1	333.3	9	0.3333	300	5321	1
11ac40MIMO	5510	Type6	8	1	333.3	9	0.3333	300	5311	1
11ac20MIMO	5500	Type6	8	1	333.3	9	0.3333	300	5310	1
11ac20MIMO	5500	Type6	8	1	333.3	9	0.3333	300	5351	1
11ac20MIMO	5500	Type6	8	1	333.3	9	0.3333	300	5297	1
11ac20MIMO	5500	Type6	8	1	333.3	9	0.3333	300	5374	1
11ac20MIMO	5500	Type6	8	1	333.3	9	0.3333	300	5322	1
11ac20MIMO	5500	Type6	8	1	333.3	9	0.3333	300	5367	1
11ac20MIMO	5500	Type6	8	1	333.3	9	0.3333	300	5523	1
11ac20MIMO	5500	Type6	8	1	333.3	9	0.3333	300	5285	1



Unless otherwise agreed in writing, this document is issued by the Company subject to its General Conditions of Service printed overleaf, available on request or accessible at <http://www.sgs.com/en/Terms-and-Conditions.aspx> and, for electronic format documents, subject to Terms and Conditions for Electronic Documents at <http://www.sgs.com/en/Terms-and-Conditions/Terms-e-Documents.aspx>. Attention is drawn to the limitation of liability, indemnification and jurisdiction issues defined therein. Any holder of this document is advised that information contained herein reflects the Company's findings at the time of its intervention only and within the limits of Client's instructions, if any. The Company's sole responsibility is to its Client and this document does not exonerate parties to a transaction from exercising all their rights and obligations under the transaction documents. This document cannot be reproduced except in full, without prior written approval of the Company. Any unauthorized alteration, forgery or falsification of the content or appearance of this document is unlawful and offenders may be prosecuted to the fullest extent of the law. Unless otherwise stated the results shown in this test report refer only to the sample(s) tested and such sample(s) are retained for 30 days only.

Attention: To check the authenticity of testing/inspection report & certificate, please contact us at telephone: (86-755) 8307 1443, or email: [CN.Doccheck@sgs.com](mailto:CN.Doccheck@sgs.com)

SGS-CSTC Standards Technical Services (Xi'an) Co., Ltd. | 1/F, Unit D, Building 1, Kanglong Orange Science Park, No.157, Keyuan 3rd Road, Fengyang New Town, Xi'an, Shaanxi, China | 710086 | t: (86-29) 6282 7885 | www.sgs.com.cn | sgs.china@sgs.com  
 中国·西安·沣东新城科里三路157号康隆橙方科技园1号楼D单元1层 | 邮编: 710086 | t: (86-29) 6282 7885 | sgs.china@sgs.com

11ac20MIMO	5500	Type6	8	1	333.3	9	0.3333	300	5663	1
11ac20MIMO	5500	Type6	8	1	333.3	9	0.3333	300	5617	1
11ac20MIMO	5500	Type6	8	1	333.3	9	0.3333	300	5454	1
11ac20MIMO	5500	Type6	8	1	333.3	9	0.3333	300	5342	1
11ac20MIMO	5500	Type6	8	1	333.3	9	0.3333	300	5717	1
11ac20MIMO	5500	Type6	8	1	333.3	9	0.3333	300	5485	1
11ac20MIMO	5500	Type6	8	1	333.3	9	0.3333	300	5281	1
11ac20MIMO	5500	Type6	8	1	333.3	9	0.3333	300	5656	1
11ac20MIMO	5500	Type6	8	1	333.3	9	0.3333	300	5510	1
11ac20MIMO	5500	Type6	8	1	333.3	9	0.3333	300	5548	1
11ac20MIMO	5500	Type6	8	1	333.3	9	0.3333	300	5648	1
11ac20MIMO	5500	Type6	8	1	333.3	9	0.3333	300	5409	1
11ac20MIMO	5500	Type6	8	1	333.3	9	0.3333	300	5680	1
11ac20MIMO	5500	Type6	8	1	333.3	9	0.3333	300	5631	1
11ac20MIMO	5500	Type6	8	1	333.3	9	0.3333	300	5630	1
11ac20MIMO	5500	Type6	8	1	333.3	9	0.3333	300	5670	1
11ac20MIMO	5500	Type6	8	1	333.3	9	0.3333	300	5319	1
11ac20MIMO	5500	Type6	8	1	333.3	9	0.3333	300	5435	1
11ac20MIMO	5500	Type6	8	1	333.3	9	0.3333	300	5483	1
11ac20MIMO	5500	Type6	8	1	333.3	9	0.3333	300	5508	1
11ac20MIMO	5500	Type6	8	1	333.3	9	0.3333	300	5516	1
11ac20MIMO	5500	Type6	8	1	333.3	9	0.3333	300	5493	1
11ac20MIMO	5500	Type6	8	1	333.3	9	0.3333	300	5647	1
11ac20MIMO	5500	Type6	8	1	333.3	9	0.3333	300	5627	1
11ac20MIMO	5500	Type6	8	1	333.3	9	0.3333	300	5386	1
11ac20MIMO	5500	Type6	8	1	333.3	9	0.3333	300	5506	1
11ac20MIMO	5500	Type6	8	1	333.3	9	0.3333	300	5462	1
11ac20MIMO	5500	Type6	8	1	333.3	9	0.3333	300	5470	1
11ac20MIMO	5500	Type6	8	1	333.3	9	0.3333	300	5724	1
11ac20MIMO	5500	Type6	8	1	333.3	9	0.3333	300	5390	1
11ac20MIMO	5500	Type6	8	1	333.3	9	0.3333	300	5420	1
11ac20MIMO	5500	Type6	8	1	333.3	9	0.3333	300	5690	1
11ac20MIMO	5500	Type6	8	1	333.3	9	0.3333	300	5576	1
11ac20MIMO	5500	Type6	8	1	333.3	9	0.3333	300	5452	1
11ac20MIMO	5500	Type6	8	1	333.3	9	0.3333	300	5497	1
11ac20MIMO	5500	Type6	8	1	333.3	9	0.3333	300	5387	1
11ac20MIMO	5500	Type6	8	1	333.3	9	0.3333	300	5274	1
11ac20MIMO	5500	Type6	8	1	333.3	9	0.3333	300	5320	1
11ac20MIMO	5500	Type6	8	1	333.3	9	0.3333	300	5487	1
11ac20MIMO	5500	Type6	8	1	333.3	9	0.3333	300	5479	1
11ac20MIMO	5500	Type6	8	1	333.3	9	0.3333	300	5560	1
11ac20MIMO	5500	Type6	8	1	333.3	9	0.3333	300	5605	1
11ac20MIMO	5500	Type6	8	1	333.3	9	0.3333	300	5381	1
11ac20MIMO	5500	Type6	8	1	333.3	9	0.3333	300	5622	1
11ac20MIMO	5500	Type6	8	1	333.3	9	0.3333	300	5671	1
11ac20MIMO	5500	Type6	8	1	333.3	9	0.3333	300	5445	1
11ac20MIMO	5500	Type6	8	1	333.3	9	0.3333	300	5489	1
11ac20MIMO	5500	Type6	8	1	333.3	9	0.3333	300	5526	1
11ac20MIMO	5500	Type6	8	1	333.3	9	0.3333	300	5253	1
11ac20MIMO	5500	Type6	8	1	333.3	9	0.3333	300	5279	1
11ac20MIMO	5500	Type6	8	1	333.3	9	0.3333	300	5502	1
11ac20MIMO	5500	Type6	8	1	333.3	9	0.3333	300	5397	1
11ac20MIMO	5500	Type6	8	1	333.3	9	0.3333	300	5629	1



Unless otherwise agreed in writing, this document is issued by the Company subject to its General Conditions of Service printed overleaf, available on request or accessible at <http://www.sgs.com/en/Terms-and-Conditions.aspx> and, for electronic format documents, subject to Terms and Conditions for Electronic Documents at <http://www.sgs.com/en/Terms-and-Conditions/Terms-e-Documents.aspx>. Attention is drawn to the limitation of liability, indemnification and jurisdiction issues defined therein. Any holder of this document is advised that information contained herein reflects the Company's findings at the time of its intervention only and within the limits of Client's instructions, if any. The Company's sole responsibility is to its Client and this document does not exonerate parties to a transaction from exercising all their rights and obligations under the transaction documents. This document cannot be reproduced except in full, without prior written approval of the Company. Any unauthorized alteration, forgery or falsification of the content or appearance of this document is unlawful and offenders may be prosecuted to the fullest extent of the law. Unless otherwise stated the results shown in this test report refer only to the sample(s) tested and such sample(s) are retained for 30 days only.

Attention: To check the authenticity of testing/inspection report & certificate, please contact us at telephone: (86-755) 8307 1443, or email: [CN.Doccheck@sgs.com](mailto:CN.Doccheck@sgs.com)  
 1/E Unit D, Building 1, Kanglong Orange Science Park, No.157, Keyuan 3rd Road, Fengyang New Town, Xian, Shaanxi, China 710086  
 t (86-29) 6282 7885 www.sgs.com.cn  
 中国·西安·沣东新城科里三路157号康隆橙方科技园1号楼D单元1层 邮编: 710086 t (86-29) 6282 7885 sgs.china@sgs.com



11ac20MIMO	5500	Type6	8	1	333.3	9	0.3333	300	5440	1
11ac20MIMO	5500	Type6	8	1	333.3	9	0.3333	300	5678	1
11ac20MIMO	5500	Type6	8	1	333.3	9	0.3333	300	5704	1
11ac20MIMO	5500	Type6	8	1	333.3	9	0.3333	300	5544	1
11ac20MIMO	5500	Type6	8	1	333.3	9	0.3333	300	5533	1
11ac20MIMO	5500	Type6	8	1	333.3	9	0.3333	300	5608	1
11ac20MIMO	5500	Type6	8	1	333.3	9	0.3333	300	5408	1
11ac20MIMO	5500	Type6	8	1	333.3	9	0.3333	300	5478	1
11ac20MIMO	5500	Type6	8	1	333.3	9	0.3333	300	5655	1
11ac20MIMO	5500	Type6	8	1	333.3	9	0.3333	300	5481	1
11ac20MIMO	5500	Type6	8	1	333.3	9	0.3333	300	5590	1
11ac20MIMO	5500	Type6	8	1	333.3	9	0.3333	300	5268	1
11ac20MIMO	5500	Type6	8	1	333.3	9	0.3333	300	5346	1
11ac20MIMO	5500	Type6	8	1	333.3	9	0.3333	300	5673	1
11ac20MIMO	5500	Type6	8	1	333.3	9	0.3333	300	5254	1
11ac20MIMO	5500	Type6	8	1	333.3	9	0.3333	300	5295	1
11ac20MIMO	5500	Type6	8	1	333.3	9	0.3333	300	5258	1
11ac20MIMO	5500	Type6	8	1	333.3	9	0.3333	300	5459	1
11ac20MIMO	5500	Type6	8	1	333.3	9	0.3333	300	5372	1
11ac20MIMO	5500	Type6	8	1	333.3	9	0.3333	300	5623	1
11ac20MIMO	5500	Type6	8	1	333.3	9	0.3333	300	5401	1
11ac20MIMO	5500	Type6	8	1	333.3	9	0.3333	300	5267	1
11ac20MIMO	5500	Type6	8	1	333.3	9	0.3333	300	5706	1
11ac20MIMO	5500	Type6	8	1	333.3	9	0.3333	300	5545	1
11ac20MIMO	5500	Type6	8	1	333.3	9	0.3333	300	5488	1
11ac20MIMO	5500	Type6	8	1	333.3	9	0.3333	300	5650	1
11ac20MIMO	5500	Type6	8	1	333.3	9	0.3333	300	5324	1
11ac20MIMO	5500	Type6	8	1	333.3	9	0.3333	300	5305	1
11ac20MIMO	5500	Type6	8	1	333.3	9	0.3333	300	5373	1
11ac20MIMO	5500	Type6	8	1	333.3	9	0.3333	300	5559	1
11ac20MIMO	5500	Type6	8	1	333.3	9	0.3333	300	5464	1
11ac20MIMO	5500	Type6	8	1	333.3	9	0.3333	300	5660	1
11ac20MIMO	5500	Type6	8	1	333.3	9	0.3333	300	5344	1
11ac20MIMO	5500	Type6	8	1	333.3	9	0.3333	300	5698	1
11ac20MIMO	5500	Type6	8	1	333.3	9	0.3333	300	5394	1
11ac20MIMO	5500	Type6	8	1	333.3	9	0.3333	300	5378	1
11ac20MIMO	5500	Type6	8	1	333.3	9	0.3333	300	5363	1
11ac20MIMO	5500	Type6	8	1	333.3	9	0.3333	300	5321	1
11ac20MIMO	5500	Type6	8	1	333.3	9	0.3333	300	5311	1



Unless otherwise agreed in writing, this document is issued by the Company subject to its General Conditions of Service printed overleaf, available on request or accessible at <http://www.sgs.com/en/Terms-and-Conditions.aspx> and, for electronic format documents, subject to Terms and Conditions for Electronic Documents at <http://www.sgs.com/en/Terms-and-Conditions/Terms-e-Documents.aspx>. Attention is drawn to the limitation of liability, indemnification and jurisdiction issues defined therein. Any holder of this document is advised that information contained herein reflects the Company's findings at the time of its intervention only and within the limits of Client's instructions, if any. The Company's sole responsibility is to its Client and this document does not exonerate parties to a transaction from exercising all their rights and obligations under the transaction documents. This document cannot be reproduced except in full, without prior written approval of the Company. Any unauthorized alteration, forgery or falsification of the content or appearance of this document is unlawful and offenders may be prosecuted to the fullest extent of the law. Unless otherwise stated the results shown in this test report refer only to the sample(s) tested and such sample(s) are retained for 30 days only.

Attention: To check the authenticity of testing/inspection report & certificate, please contact us at telephone: (86-755) 4307 1443, or email: [CN.Doccheck@sgs.com](mailto:CN.Doccheck@sgs.com)

SGS-CSTC Standards Technical Services (Xi'an) Co., Ltd. | 1/E Unit D, Building 1, Kangfeng Orange Source Park, No.137, Kejian 3rd Road, Fengling New Town, Xi'an, Shaanxi, China | 710086 | t: (86-29) 6282 7885 | www.sgs.com.cn  
 中国·西安·沣东新城科里三路137号康锦方科技园1号楼D单元1层 | 邮编: 710086 | t: (86-29) 6282 7885 | sgs.china@sgs.com

TestMode	Channel	Radar Type	Trial ID	Pulse width (μs)	PRI (μs)	Pulses per Hop	Hop Rate (kHz)	Hop Sequence Length(ms)	Center Frequency (MHz)	Detection (1: Yes; 0: No)
11ac80MIMO	5530	Type6	9	1	333.3	9	0.3333	300	5565	1
11ac80MIMO	5530	Type6	9	1	333.3	9	0.3333	300	5590	1
11ac80MIMO	5530	Type6	9	1	333.3	9	0.3333	300	5708	1
11ac80MIMO	5530	Type6	9	1	333.3	9	0.3333	300	5535	1
11ac80MIMO	5530	Type6	9	1	333.3	9	0.3333	300	5542	1
11ac80MIMO	5530	Type6	9	1	333.3	9	0.3333	300	5409	1
11ac80MIMO	5530	Type6	9	1	333.3	9	0.3333	300	5545	1
11ac80MIMO	5530	Type6	9	1	333.3	9	0.3333	300	5360	1
11ac80MIMO	5530	Type6	9	1	333.3	9	0.3333	300	5351	1
11ac80MIMO	5530	Type6	9	1	333.3	9	0.3333	300	5349	1
11ac80MIMO	5530	Type6	9	1	333.3	9	0.3333	300	5288	1
11ac80MIMO	5530	Type6	9	1	333.3	9	0.3333	300	5606	1
11ac80MIMO	5530	Type6	9	1	333.3	9	0.3333	300	5283	1
11ac80MIMO	5530	Type6	9	1	333.3	9	0.3333	300	5583	1
11ac80MIMO	5530	Type6	9	1	333.3	9	0.3333	300	5302	1
11ac80MIMO	5530	Type6	9	1	333.3	9	0.3333	300	5269	1
11ac80MIMO	5530	Type6	9	1	333.3	9	0.3333	300	5637	1
11ac80MIMO	5530	Type6	9	1	333.3	9	0.3333	300	5554	1
11ac80MIMO	5530	Type6	9	1	333.3	9	0.3333	300	5693	1
11ac80MIMO	5530	Type6	9	1	333.3	9	0.3333	300	5380	1
11ac80MIMO	5530	Type6	9	1	333.3	9	0.3333	300	5417	1
11ac80MIMO	5530	Type6	9	1	333.3	9	0.3333	300	5274	1
11ac80MIMO	5530	Type6	9	1	333.3	9	0.3333	300	5572	1
11ac80MIMO	5530	Type6	9	1	333.3	9	0.3333	300	5719	1
11ac80MIMO	5530	Type6	9	1	333.3	9	0.3333	300	5643	1
11ac80MIMO	5530	Type6	9	1	333.3	9	0.3333	300	5682	1
11ac80MIMO	5530	Type6	9	1	333.3	9	0.3333	300	5287	1
11ac80MIMO	5530	Type6	9	1	333.3	9	0.3333	300	5686	1
11ac80MIMO	5530	Type6	9	1	333.3	9	0.3333	300	5612	1
11ac80MIMO	5530	Type6	9	1	333.3	9	0.3333	300	5550	1
11ac80MIMO	5530	Type6	9	1	333.3	9	0.3333	300	5632	1
11ac80MIMO	5530	Type6	9	1	333.3	9	0.3333	300	5536	1
11ac80MIMO	5530	Type6	9	1	333.3	9	0.3333	300	5584	1
11ac80MIMO	5530	Type6	9	1	333.3	9	0.3333	300	5504	1
11ac80MIMO	5530	Type6	9	1	333.3	9	0.3333	300	5280	1
11ac80MIMO	5530	Type6	9	1	333.3	9	0.3333	300	5660	1
11ac80MIMO	5530	Type6	9	1	333.3	9	0.3333	300	5512	1
11ac80MIMO	5530	Type6	9	1	333.3	9	0.3333	300	5340	1
11ac80MIMO	5530	Type6	9	1	333.3	9	0.3333	300	5661	1
11ac80MIMO	5530	Type6	9	1	333.3	9	0.3333	300	5573	1
11ac80MIMO	5530	Type6	9	1	333.3	9	0.3333	300	5604	1
11ac80MIMO	5530	Type6	9	1	333.3	9	0.3333	300	5415	1
11ac80MIMO	5530	Type6	9	1	333.3	9	0.3333	300	5435	1
11ac80MIMO	5530	Type6	9	1	333.3	9	0.3333	300	5530	1
11ac80MIMO	5530	Type6	9	1	333.3	9	0.3333	300	5271	1
11ac80MIMO	5530	Type6	9	1	333.3	9	0.3333	300	5627	1
11ac80MIMO	5530	Type6	9	1	333.3	9	0.3333	300	5467	1
11ac80MIMO	5530	Type6	9	1	333.3	9	0.3333	300	5562	1
11ac80MIMO	5530	Type6	9	1	333.3	9	0.3333	300	5618	1



Unless otherwise agreed in writing, this document is issued by the Company subject to its General Conditions of Service printed overleaf, available on request or accessible at <http://www.sgs.com/en/Terms-and-Conditions.aspx> and, for electronic format documents, subject to Terms and Conditions for Electronic Documents at <http://www.sgs.com/en/Terms-and-Conditions/Terms-e-Documents.aspx>. Attention is drawn to the limitation of liability, indemnification and jurisdiction issues defined therein. Any holder of this document is advised that information contained herein reflects the Company's findings at the time of its intervention only and within the limits of Client's instructions, if any. The Company's sole responsibility is to its Client and this document does not exonerate parties to a transaction from exercising all their rights and obligations under the transaction documents. This document cannot be reproduced except in full, without prior written approval of the Company. Any unauthorized alteration, forgery or falsification of the content or appearance of this document is unlawful and offenders may be prosecuted to the fullest extent of the law. Unless otherwise stated the results shown in this test report refer only to the sample(s) tested and such sample(s) are retained for 30 days only.

Attention: To check the authenticity of testing/inspection report & certificate, please contact us at telephone: (86-755) 8307 1443, or email: [CN.Doccheck@sgs.com](mailto:CN.Doccheck@sgs.com)

SGS-CSTC Standards Technical Services (Xi'an) Co., Ltd. | 1/E Unit D, Building 1, Kanglong Orange Science Park, No.157, Keyuan 3rd Road, Fengjing/Yue Town, Xi'an, Shaanxi, China | 710086 | t (86-29) 6282 7885 | www.sgs.com.cn  
 中国·西安·沣东新城科里三路157号康隆橙方科技园1号楼D单元1层 | 邮编: 710086 | t (86-29) 6282 7885 | sgs.china@sgs.com



Table with 11 columns: Sample ID, Weight, Type, and various numerical values. Rows range from 11ac80MIMO to 11ac40MIMO.



Unless otherwise agreed in writing, this document is issued by the Company subject to its General Conditions of Service printed overleaf, available on request or accessible at http://www.sgs.com/en/Terms-and-Conditions.aspx and, for electronic format documents, subject to Terms and Conditions for Electronic Documents at http://www.sgs.com/en/Terms-and-Conditions/Terms-e-Documents.aspx. Attention is drawn to the limitation of liability, indemnification and jurisdiction issues defined therein. Any holder of this document is advised that information contained herein reflects the Company's findings at the time of its intervention only and within the limits of Client's instructions, if any. The Company's sole responsibility is to its Client and this document does not exonerate parties to a transaction from exercising all their rights and obligations under the transaction documents. This document cannot be reproduced except in full, without prior written approval of the Company. Any unauthorized alteration, forgery or falsification of the content or appearance of this document is unlawful and offenders may be prosecuted to the fullest extent of the law. Unless otherwise stated the results shown in this test report refer only to the sample(s) tested and such sample(s) are retained for 30 days only. Attention: To check the authenticity of testing/inspection report & certificate, please contact us at telephone: (86-755) 8307 1443, or email: CN.Doccheck@sgs.com.
SGS-CSTC Standards Technical Services (Xi'an) Co., Ltd. | 1/F, Unit D, Building 1, Kangrong Orange Science Park, No.137, Keyuan 3rd Road, Fengtong/Wei Town, Xi'an, Shaanxi, China | 710086 | t: (86-29) 6282 7885 | www.sgs.com.cn
中国·西安·沣东新城科里三路137号康融橙方科技园1号楼D单元1层 | 邮编: 710086 | t: (86-29) 6282 7885 | sgs.china@sgs.com



11ac40MIMO	5510	Type6	9	1	333.3	9	0.3333	300	5708	1
11ac40MIMO	5510	Type6	9	1	333.3	9	0.3333	300	5535	1
11ac40MIMO	5510	Type6	9	1	333.3	9	0.3333	300	5542	1
11ac40MIMO	5510	Type6	9	1	333.3	9	0.3333	300	5409	1
11ac40MIMO	5510	Type6	9	1	333.3	9	0.3333	300	5545	1
11ac40MIMO	5510	Type6	9	1	333.3	9	0.3333	300	5360	1
11ac40MIMO	5510	Type6	9	1	333.3	9	0.3333	300	5351	1
11ac40MIMO	5510	Type6	9	1	333.3	9	0.3333	300	5349	1
11ac40MIMO	5510	Type6	9	1	333.3	9	0.3333	300	5288	1
11ac40MIMO	5510	Type6	9	1	333.3	9	0.3333	300	5606	1
11ac40MIMO	5510	Type6	9	1	333.3	9	0.3333	300	5283	1
11ac40MIMO	5510	Type6	9	1	333.3	9	0.3333	300	5583	1
11ac40MIMO	5510	Type6	9	1	333.3	9	0.3333	300	5302	1
11ac40MIMO	5510	Type6	9	1	333.3	9	0.3333	300	5269	1
11ac40MIMO	5510	Type6	9	1	333.3	9	0.3333	300	5637	1
11ac40MIMO	5510	Type6	9	1	333.3	9	0.3333	300	5554	1
11ac40MIMO	5510	Type6	9	1	333.3	9	0.3333	300	5693	1
11ac40MIMO	5510	Type6	9	1	333.3	9	0.3333	300	5380	1
11ac40MIMO	5510	Type6	9	1	333.3	9	0.3333	300	5417	1
11ac40MIMO	5510	Type6	9	1	333.3	9	0.3333	300	5274	1
11ac40MIMO	5510	Type6	9	1	333.3	9	0.3333	300	5572	1
11ac40MIMO	5510	Type6	9	1	333.3	9	0.3333	300	5719	1
11ac40MIMO	5510	Type6	9	1	333.3	9	0.3333	300	5643	1
11ac40MIMO	5510	Type6	9	1	333.3	9	0.3333	300	5682	1
11ac40MIMO	5510	Type6	9	1	333.3	9	0.3333	300	5287	1
11ac40MIMO	5510	Type6	9	1	333.3	9	0.3333	300	5686	1
11ac40MIMO	5510	Type6	9	1	333.3	9	0.3333	300	5612	1
11ac40MIMO	5510	Type6	9	1	333.3	9	0.3333	300	5550	1
11ac40MIMO	5510	Type6	9	1	333.3	9	0.3333	300	5632	1
11ac40MIMO	5510	Type6	9	1	333.3	9	0.3333	300	5536	1
11ac40MIMO	5510	Type6	9	1	333.3	9	0.3333	300	5584	1
11ac40MIMO	5510	Type6	9	1	333.3	9	0.3333	300	5504	1
11ac40MIMO	5510	Type6	9	1	333.3	9	0.3333	300	5280	1
11ac40MIMO	5510	Type6	9	1	333.3	9	0.3333	300	5660	1
11ac40MIMO	5510	Type6	9	1	333.3	9	0.3333	300	5512	1
11ac40MIMO	5510	Type6	9	1	333.3	9	0.3333	300	5340	1
11ac40MIMO	5510	Type6	9	1	333.3	9	0.3333	300	5661	1
11ac40MIMO	5510	Type6	9	1	333.3	9	0.3333	300	5573	1
11ac40MIMO	5510	Type6	9	1	333.3	9	0.3333	300	5604	1
11ac40MIMO	5510	Type6	9	1	333.3	9	0.3333	300	5415	1
11ac40MIMO	5510	Type6	9	1	333.3	9	0.3333	300	5435	1
11ac40MIMO	5510	Type6	9	1	333.3	9	0.3333	300	5530	1
11ac40MIMO	5510	Type6	9	1	333.3	9	0.3333	300	5271	1
11ac40MIMO	5510	Type6	9	1	333.3	9	0.3333	300	5627	1
11ac40MIMO	5510	Type6	9	1	333.3	9	0.3333	300	5467	1
11ac40MIMO	5510	Type6	9	1	333.3	9	0.3333	300	5562	1
11ac40MIMO	5510	Type6	9	1	333.3	9	0.3333	300	5618	1
11ac40MIMO	5510	Type6	9	1	333.3	9	0.3333	300	5658	1
11ac40MIMO	5510	Type6	9	1	333.3	9	0.3333	300	5646	1
11ac40MIMO	5510	Type6	9	1	333.3	9	0.3333	300	5401	1
11ac40MIMO	5510	Type6	9	1	333.3	9	0.3333	300	5527	1
11ac40MIMO	5510	Type6	9	1	333.3	9	0.3333	300	5722	1
11ac40MIMO	5510	Type6	9	1	333.3	9	0.3333	300	5541	1



Unless otherwise agreed in writing, this document is issued by the Company subject to its General Conditions of Service printed overleaf, available on request or accessible at <http://www.sgs.com/en/Terms-and-Conditions.aspx> and, for electronic format documents, subject to Terms and Conditions for Electronic Documents at <http://www.sgs.com/en/Terms-and-Conditions/Terms-e-Documents.aspx>. Attention is drawn to the limitation of liability, indemnification and jurisdiction issues defined therein. Any holder of this document is advised that information contained herein reflects the Company's findings at the time of its intervention only and within the limits of Client's instructions, if any. The Company's sole responsibility is to its Client and this document does not exonerate parties to a transaction from exercising all their rights and obligations under the transaction documents. This document cannot be reproduced except in full, without prior written approval of the Company. Any unauthorized alteration, forgery or falsification of the content or appearance of this document is unlawful and offenders may be prosecuted to the fullest extent of the law. Unless otherwise stated the results shown in this test report refer only to the sample(s) tested and such sample(s) are retained for 30 days only.

Attention: To check the authenticity of testing/inspection report & certificate, please contact us at telephone: (86-755) 8307 1443, or email: [CN.Doccheck@sgs.com](mailto:CN.Doccheck@sgs.com)

SGS-CSTC Standards Technical Services (Xi'an) Co., Ltd. | 1/F Unit D, Building 1, Kanglong Orange Science Park, No.137, Keyuan 3rd Road, Fengyang New Town, Xian, Shaanxi, China | 710086 | T (86-29) 6282 7885 | [www.sgs.com](http://www.sgs.com)  
 中国·西安·沣东新城科里三路137号康隆橙方科技园1号楼D单元1层 | 邮编: 710086 | T (86-29) 6282 7885 | [sgs.china@sgs.com](mailto:sgs.china@sgs.com)



11ac40MIMO	5510	Type6	9	1	333.3	9	0.3333	300	5268	1
11ac40MIMO	5510	Type6	9	1	333.3	9	0.3333	300	5336	1
11ac40MIMO	5510	Type6	9	1	333.3	9	0.3333	300	5714	1
11ac40MIMO	5510	Type6	9	1	333.3	9	0.3333	300	5372	1
11ac40MIMO	5510	Type6	9	1	333.3	9	0.3333	300	5473	1
11ac40MIMO	5510	Type6	9	1	333.3	9	0.3333	300	5526	1
11ac40MIMO	5510	Type6	9	1	333.3	9	0.3333	300	5539	1
11ac40MIMO	5510	Type6	9	1	333.3	9	0.3333	300	5574	1
11ac40MIMO	5510	Type6	9	1	333.3	9	0.3333	300	5369	1
11ac40MIMO	5510	Type6	9	1	333.3	9	0.3333	300	5650	1
11ac40MIMO	5510	Type6	9	1	333.3	9	0.3333	300	5367	1
11ac40MIMO	5510	Type6	9	1	333.3	9	0.3333	300	5482	1
11ac40MIMO	5510	Type6	9	1	333.3	9	0.3333	300	5547	1
11ac40MIMO	5510	Type6	9	1	333.3	9	0.3333	300	5715	1
11ac40MIMO	5510	Type6	9	1	333.3	9	0.3333	300	5370	1
11ac40MIMO	5510	Type6	9	1	333.3	9	0.3333	300	5598	1
11ac40MIMO	5510	Type6	9	1	333.3	9	0.3333	300	5252	1
11ac40MIMO	5510	Type6	9	1	333.3	9	0.3333	300	5464	1
11ac40MIMO	5510	Type6	9	1	333.3	9	0.3333	300	5484	1
11ac40MIMO	5510	Type6	9	1	333.3	9	0.3333	300	5439	1
11ac40MIMO	5510	Type6	9	1	333.3	9	0.3333	300	5622	1
11ac40MIMO	5510	Type6	9	1	333.3	9	0.3333	300	5305	1
11ac40MIMO	5510	Type6	9	1	333.3	9	0.3333	300	5642	1
11ac40MIMO	5510	Type6	9	1	333.3	9	0.3333	300	5374	1
11ac40MIMO	5510	Type6	9	1	333.3	9	0.3333	300	5341	1
11ac40MIMO	5510	Type6	9	1	333.3	9	0.3333	300	5711	1
11ac40MIMO	5510	Type6	9	1	333.3	9	0.3333	300	5385	1
11ac40MIMO	5510	Type6	9	1	333.3	9	0.3333	300	5404	1
11ac40MIMO	5510	Type6	9	1	333.3	9	0.3333	300	5264	1
11ac40MIMO	5510	Type6	9	1	333.3	9	0.3333	300	5523	1
11ac40MIMO	5510	Type6	9	1	333.3	9	0.3333	300	5448	1
11ac40MIMO	5510	Type6	9	1	333.3	9	0.3333	300	5326	1
11ac40MIMO	5510	Type6	9	1	333.3	9	0.3333	300	5451	1
11ac40MIMO	5510	Type6	9	1	333.3	9	0.3333	300	5270	1
11ac40MIMO	5510	Type6	9	1	333.3	9	0.3333	300	5667	1
11ac40MIMO	5510	Type6	9	1	333.3	9	0.3333	300	5356	1
11ac40MIMO	5510	Type6	9	1	333.3	9	0.3333	300	5621	1
11ac40MIMO	5510	Type6	9	1	333.3	9	0.3333	300	5303	1
11ac40MIMO	5510	Type6	9	1	333.3	9	0.3333	300	5724	1
11ac40MIMO	5510	Type6	9	1	333.3	9	0.3333	300	5470	1
11ac40MIMO	5510	Type6	9	1	333.3	9	0.3333	300	5639	1
11ac40MIMO	5510	Type6	9	1	333.3	9	0.3333	300	5386	1
11ac40MIMO	5510	Type6	9	1	333.3	9	0.3333	300	5361	1
11ac40MIMO	5510	Type6	9	1	333.3	9	0.3333	300	5278	1
11ac40MIMO	5510	Type6	9	1	333.3	9	0.3333	300	5378	1
11ac20MIMO	5500	Type6	9	1	333.3	9	0.3333	300	5565	1
11ac20MIMO	5500	Type6	9	1	333.3	9	0.3333	300	5590	1
11ac20MIMO	5500	Type6	9	1	333.3	9	0.3333	300	5708	1
11ac20MIMO	5500	Type6	9	1	333.3	9	0.3333	300	5535	1
11ac20MIMO	5500	Type6	9	1	333.3	9	0.3333	300	5542	1
11ac20MIMO	5500	Type6	9	1	333.3	9	0.3333	300	5409	1
11ac20MIMO	5500	Type6	9	1	333.3	9	0.3333	300	5545	1
11ac20MIMO	5500	Type6	9	1	333.3	9	0.3333	300	5360	1



Unless otherwise agreed in writing, this document is issued by the Company subject to its General Conditions of Service printed overleaf, available on request or accessible at <http://www.sgs.com/en/Terms-and-Conditions.aspx> and, for electronic format documents, subject to Terms and Conditions for Electronic Documents at <http://www.sgs.com/en/Terms-and-Conditions/Terms-e-Document.aspx>. Attention is drawn to the limitation of liability, indemnification and jurisdiction issues defined therein. Any holder of this document is advised that information contained herein reflects the Company's findings at the time of its intervention only and within the limits of Client's instructions, if any. The Company's sole responsibility is to its Client and this document does not exonerate parties to a transaction from exercising all their rights and obligations under the transaction documents. This document cannot be reproduced except in full, without prior written approval of the Company. Any unauthorized alteration, forgery or falsification of the content or appearance of this document is unlawful and offenders may be prosecuted to the fullest extent of the law. Unless otherwise stated the results shown in this test report refer only to the sample(s) tested and such sample(s) are retained for 30 days only.

Attention: To check the authenticity of testing/inspection report & certificate, please contact us at telephone: (86-755) 8307 1443, or email: [CN.Doccheck@sgs.com](mailto:CN.Doccheck@sgs.com)  
 (E) Unit D, Building 1, Kanglong Orange Science Park, No.157, Keyuan 3rd Road, Fengjing/Yue Town, Xian, Shaanxi, China 710086  
 t (86-29) 6282 7885 www.sgs.com.cn  
 中国·西安·沣东新城科里三路157号康隆橙方科技园1号楼D单元1层 邮编: 710086 t (86-29) 6282 7885 sgs.china@sgs.com

11ac20MIMO	5500	Type6	9	1	333.3	9	0.3333	300	5351	1
11ac20MIMO	5500	Type6	9	1	333.3	9	0.3333	300	5349	1
11ac20MIMO	5500	Type6	9	1	333.3	9	0.3333	300	5288	1
11ac20MIMO	5500	Type6	9	1	333.3	9	0.3333	300	5606	1
11ac20MIMO	5500	Type6	9	1	333.3	9	0.3333	300	5283	1
11ac20MIMO	5500	Type6	9	1	333.3	9	0.3333	300	5583	1
11ac20MIMO	5500	Type6	9	1	333.3	9	0.3333	300	5302	1
11ac20MIMO	5500	Type6	9	1	333.3	9	0.3333	300	5269	1
11ac20MIMO	5500	Type6	9	1	333.3	9	0.3333	300	5637	1
11ac20MIMO	5500	Type6	9	1	333.3	9	0.3333	300	5554	1
11ac20MIMO	5500	Type6	9	1	333.3	9	0.3333	300	5693	1
11ac20MIMO	5500	Type6	9	1	333.3	9	0.3333	300	5380	1
11ac20MIMO	5500	Type6	9	1	333.3	9	0.3333	300	5417	1
11ac20MIMO	5500	Type6	9	1	333.3	9	0.3333	300	5274	1
11ac20MIMO	5500	Type6	9	1	333.3	9	0.3333	300	5572	1
11ac20MIMO	5500	Type6	9	1	333.3	9	0.3333	300	5719	1
11ac20MIMO	5500	Type6	9	1	333.3	9	0.3333	300	5643	1
11ac20MIMO	5500	Type6	9	1	333.3	9	0.3333	300	5682	1
11ac20MIMO	5500	Type6	9	1	333.3	9	0.3333	300	5287	1
11ac20MIMO	5500	Type6	9	1	333.3	9	0.3333	300	5686	1
11ac20MIMO	5500	Type6	9	1	333.3	9	0.3333	300	5612	1
11ac20MIMO	5500	Type6	9	1	333.3	9	0.3333	300	5550	1
11ac20MIMO	5500	Type6	9	1	333.3	9	0.3333	300	5632	1
11ac20MIMO	5500	Type6	9	1	333.3	9	0.3333	300	5536	1
11ac20MIMO	5500	Type6	9	1	333.3	9	0.3333	300	5584	1
11ac20MIMO	5500	Type6	9	1	333.3	9	0.3333	300	5504	1
11ac20MIMO	5500	Type6	9	1	333.3	9	0.3333	300	5280	1
11ac20MIMO	5500	Type6	9	1	333.3	9	0.3333	300	5660	1
11ac20MIMO	5500	Type6	9	1	333.3	9	0.3333	300	5512	1
11ac20MIMO	5500	Type6	9	1	333.3	9	0.3333	300	5340	1
11ac20MIMO	5500	Type6	9	1	333.3	9	0.3333	300	5661	1
11ac20MIMO	5500	Type6	9	1	333.3	9	0.3333	300	5573	1
11ac20MIMO	5500	Type6	9	1	333.3	9	0.3333	300	5604	1
11ac20MIMO	5500	Type6	9	1	333.3	9	0.3333	300	5415	1
11ac20MIMO	5500	Type6	9	1	333.3	9	0.3333	300	5435	1
11ac20MIMO	5500	Type6	9	1	333.3	9	0.3333	300	5530	1
11ac20MIMO	5500	Type6	9	1	333.3	9	0.3333	300	5271	1
11ac20MIMO	5500	Type6	9	1	333.3	9	0.3333	300	5627	1
11ac20MIMO	5500	Type6	9	1	333.3	9	0.3333	300	5467	1
11ac20MIMO	5500	Type6	9	1	333.3	9	0.3333	300	5562	1
11ac20MIMO	5500	Type6	9	1	333.3	9	0.3333	300	5618	1
11ac20MIMO	5500	Type6	9	1	333.3	9	0.3333	300	5658	1
11ac20MIMO	5500	Type6	9	1	333.3	9	0.3333	300	5646	1
11ac20MIMO	5500	Type6	9	1	333.3	9	0.3333	300	5401	1
11ac20MIMO	5500	Type6	9	1	333.3	9	0.3333	300	5527	1
11ac20MIMO	5500	Type6	9	1	333.3	9	0.3333	300	5722	1
11ac20MIMO	5500	Type6	9	1	333.3	9	0.3333	300	5541	1
11ac20MIMO	5500	Type6	9	1	333.3	9	0.3333	300	5268	1
11ac20MIMO	5500	Type6	9	1	333.3	9	0.3333	300	5336	1
11ac20MIMO	5500	Type6	9	1	333.3	9	0.3333	300	5714	1
11ac20MIMO	5500	Type6	9	1	333.3	9	0.3333	300	5372	1
11ac20MIMO	5500	Type6	9	1	333.3	9	0.3333	300	5473	1
11ac20MIMO	5500	Type6	9	1	333.3	9	0.3333	300	5526	1



Unless otherwise agreed in writing, this document is issued by the Company subject to its General Conditions of Service printed overleaf, available on request or accessible at <http://www.sgs.com/en/Terms-and-Conditions.aspx> and, for electronic format documents, subject to Terms and Conditions for Electronic Documents at <http://www.sgs.com/en/Terms-and-Conditions/Terms-e-Documents.aspx>. Attention is drawn to the limitation of liability, indemnification and jurisdiction issues defined therein. Any holder of this document is advised that information contained herein reflects the Company's findings at the time of its intervention only and within the limits of Client's instructions, if any. The Company's sole responsibility is to its Client and this document does not exonerate parties to a transaction from exercising all their rights and obligations under the transaction documents. This document cannot be reproduced except in full, without prior written approval of the Company. Any unauthorized alteration, forgery or falsification of the content or appearance of this document is unlawful and offenders may be prosecuted to the fullest extent of the law. Unless otherwise stated the results shown in this test report refer only to the sample(s) tested and such sample(s) are retained for 30 days only.

Attention: To check the authenticity of testing/inspection report & certificate, please contact us at telephone: (86-755) 8307 1443, or email: [CN.Doccheck@sgs.com](mailto:CN.Doccheck@sgs.com)  
 1/E Unit D, Building 1, Kanglong Orange Science Park, No.157, Keyuan 3rd Road, Fengfeng New Town, Xian, Shaanxi, China 710086  
 t (86-29) 6282 7885 www.sgs.com.cn  
 中国·西安·沣东新城科里三路157号康隆橙方科技园1号楼D单元1层 邮编: 710086 t (86-29) 6282 7885 sgs.china@sgs.com



11ac20MIMO	5500	Type6	9	1	333.3	9	0.3333	300	5539	1
11ac20MIMO	5500	Type6	9	1	333.3	9	0.3333	300	5574	1
11ac20MIMO	5500	Type6	9	1	333.3	9	0.3333	300	5369	1
11ac20MIMO	5500	Type6	9	1	333.3	9	0.3333	300	5650	1
11ac20MIMO	5500	Type6	9	1	333.3	9	0.3333	300	5367	1
11ac20MIMO	5500	Type6	9	1	333.3	9	0.3333	300	5482	1
11ac20MIMO	5500	Type6	9	1	333.3	9	0.3333	300	5547	1
11ac20MIMO	5500	Type6	9	1	333.3	9	0.3333	300	5715	1
11ac20MIMO	5500	Type6	9	1	333.3	9	0.3333	300	5370	1
11ac20MIMO	5500	Type6	9	1	333.3	9	0.3333	300	5598	1
11ac20MIMO	5500	Type6	9	1	333.3	9	0.3333	300	5252	1
11ac20MIMO	5500	Type6	9	1	333.3	9	0.3333	300	5464	1
11ac20MIMO	5500	Type6	9	1	333.3	9	0.3333	300	5484	1
11ac20MIMO	5500	Type6	9	1	333.3	9	0.3333	300	5439	1
11ac20MIMO	5500	Type6	9	1	333.3	9	0.3333	300	5622	1
11ac20MIMO	5500	Type6	9	1	333.3	9	0.3333	300	5305	1
11ac20MIMO	5500	Type6	9	1	333.3	9	0.3333	300	5642	1
11ac20MIMO	5500	Type6	9	1	333.3	9	0.3333	300	5374	1
11ac20MIMO	5500	Type6	9	1	333.3	9	0.3333	300	5341	1
11ac20MIMO	5500	Type6	9	1	333.3	9	0.3333	300	5711	1
11ac20MIMO	5500	Type6	9	1	333.3	9	0.3333	300	5385	1
11ac20MIMO	5500	Type6	9	1	333.3	9	0.3333	300	5404	1
11ac20MIMO	5500	Type6	9	1	333.3	9	0.3333	300	5264	1
11ac20MIMO	5500	Type6	9	1	333.3	9	0.3333	300	5523	1
11ac20MIMO	5500	Type6	9	1	333.3	9	0.3333	300	5448	1
11ac20MIMO	5500	Type6	9	1	333.3	9	0.3333	300	5326	1
11ac20MIMO	5500	Type6	9	1	333.3	9	0.3333	300	5451	1
11ac20MIMO	5500	Type6	9	1	333.3	9	0.3333	300	5270	1
11ac20MIMO	5500	Type6	9	1	333.3	9	0.3333	300	5667	1
11ac20MIMO	5500	Type6	9	1	333.3	9	0.3333	300	5356	1
11ac20MIMO	5500	Type6	9	1	333.3	9	0.3333	300	5621	1
11ac20MIMO	5500	Type6	9	1	333.3	9	0.3333	300	5303	1
11ac20MIMO	5500	Type6	9	1	333.3	9	0.3333	300	5724	1
11ac20MIMO	5500	Type6	9	1	333.3	9	0.3333	300	5470	1
11ac20MIMO	5500	Type6	9	1	333.3	9	0.3333	300	5639	1
11ac20MIMO	5500	Type6	9	1	333.3	9	0.3333	300	5386	1
11ac20MIMO	5500	Type6	9	1	333.3	9	0.3333	300	5361	1
11ac20MIMO	5500	Type6	9	1	333.3	9	0.3333	300	5278	1
11ac20MIMO	5500	Type6	9	1	333.3	9	0.3333	300	5378	1



Unless otherwise agreed in writing, this document is issued by the Company subject to its General Conditions of Service printed overleaf, available on request or accessible at <http://www.sgs.com/en/Terms-and-Conditions.aspx> and, for electronic format documents, subject to Terms and Conditions for Electronic Documents at <http://www.sgs.com/en/Terms-and-Conditions/Terms-e-Documents.aspx>. Attention is drawn to the limitation of liability, indemnification and jurisdiction issues defined therein. Any holder of this document is advised that information contained herein reflects the Company's findings at the time of its intervention only and within the limits of Client's instructions, if any. The Company's sole responsibility is to its Client and this document does not exonerate parties to a transaction from exercising all their rights and obligations under the transaction documents. This document cannot be reproduced except in full, without prior written approval of the Company. Any unauthorized alteration, forgery or falsification of the content or appearance of this document is unlawful and offenders may be prosecuted to the fullest extent of the law. Unless otherwise stated the results shown in this test report refer only to the sample(s) tested and such sample(s) are retained for 30 days only.

Attention: To check the authenticity of testing/inspection report & certificate, please contact us at telephone: (86-755) 4307 1443, or email: [CN.Doccheck@sgs.com](mailto:CN.Doccheck@sgs.com)  
 (SGS-CSTC) Standards Technical Services (Xi'an) Co., Ltd. | 1 (86-29) 6282 7885 | [www.sgs.com.cn](http://www.sgs.com.cn)  
 中国·西安·沣东新城科星三路137号康鸿楼方科技园1号楼D单元1层 | 邮编: 710086 | (86-29) 6282 7885 | [sgs.china@sgs.com](mailto:sgs.china@sgs.com)

TestMode	Channel	Radar Type	Trial ID	Pulse width (μs)	PRI (μs)	Pulses per Hop	Hop Rate (kHz)	Hop Sequence Length(ms)	Center Frequency (MHz)	Detection (1: Yes; 0: No)
11ac80MIMO	5530	Type6	10	1	333.3	9	0.3333	300	5345	1
11ac80MIMO	5530	Type6	10	1	333.3	9	0.3333	300	5354	1
11ac80MIMO	5530	Type6	10	1	333.3	9	0.3333	300	5644	1
11ac80MIMO	5530	Type6	10	1	333.3	9	0.3333	300	5696	1
11ac80MIMO	5530	Type6	10	1	333.3	9	0.3333	300	5384	1
11ac80MIMO	5530	Type6	10	1	333.3	9	0.3333	300	5548	1
11ac80MIMO	5530	Type6	10	1	333.3	9	0.3333	300	5470	1
11ac80MIMO	5530	Type6	10	1	333.3	9	0.3333	300	5435	1
11ac80MIMO	5530	Type6	10	1	333.3	9	0.3333	300	5514	1
11ac80MIMO	5530	Type6	10	1	333.3	9	0.3333	300	5653	1
11ac80MIMO	5530	Type6	10	1	333.3	9	0.3333	300	5694	1
11ac80MIMO	5530	Type6	10	1	333.3	9	0.3333	300	5492	1
11ac80MIMO	5530	Type6	10	1	333.3	9	0.3333	300	5324	1
11ac80MIMO	5530	Type6	10	1	333.3	9	0.3333	300	5303	1
11ac80MIMO	5530	Type6	10	1	333.3	9	0.3333	300	5323	1
11ac80MIMO	5530	Type6	10	1	333.3	9	0.3333	300	5357	1
11ac80MIMO	5530	Type6	10	1	333.3	9	0.3333	300	5667	1
11ac80MIMO	5530	Type6	10	1	333.3	9	0.3333	300	5657	1
11ac80MIMO	5530	Type6	10	1	333.3	9	0.3333	300	5641	1
11ac80MIMO	5530	Type6	10	1	333.3	9	0.3333	300	5572	1
11ac80MIMO	5530	Type6	10	1	333.3	9	0.3333	300	5425	1
11ac80MIMO	5530	Type6	10	1	333.3	9	0.3333	300	5440	1
11ac80MIMO	5530	Type6	10	1	333.3	9	0.3333	300	5610	1
11ac80MIMO	5530	Type6	10	1	333.3	9	0.3333	300	5711	1
11ac80MIMO	5530	Type6	10	1	333.3	9	0.3333	300	5616	1
11ac80MIMO	5530	Type6	10	1	333.3	9	0.3333	300	5473	1
11ac80MIMO	5530	Type6	10	1	333.3	9	0.3333	300	5414	1
11ac80MIMO	5530	Type6	10	1	333.3	9	0.3333	300	5338	1
11ac80MIMO	5530	Type6	10	1	333.3	9	0.3333	300	5584	1
11ac80MIMO	5530	Type6	10	1	333.3	9	0.3333	300	5674	1
11ac80MIMO	5530	Type6	10	1	333.3	9	0.3333	300	5541	1
11ac80MIMO	5530	Type6	10	1	333.3	9	0.3333	300	5719	1
11ac80MIMO	5530	Type6	10	1	333.3	9	0.3333	300	5432	1
11ac80MIMO	5530	Type6	10	1	333.3	9	0.3333	300	5480	1
11ac80MIMO	5530	Type6	10	1	333.3	9	0.3333	300	5651	1
11ac80MIMO	5530	Type6	10	1	333.3	9	0.3333	300	5431	1
11ac80MIMO	5530	Type6	10	1	333.3	9	0.3333	300	5457	1
11ac80MIMO	5530	Type6	10	1	333.3	9	0.3333	300	5348	1
11ac80MIMO	5530	Type6	10	1	333.3	9	0.3333	300	5615	1
11ac80MIMO	5530	Type6	10	1	333.3	9	0.3333	300	5254	1
11ac80MIMO	5530	Type6	10	1	333.3	9	0.3333	300	5715	1
11ac80MIMO	5530	Type6	10	1	333.3	9	0.3333	300	5373	1
11ac80MIMO	5530	Type6	10	1	333.3	9	0.3333	300	5295	1
11ac80MIMO	5530	Type6	10	1	333.3	9	0.3333	300	5365	1
11ac80MIMO	5530	Type6	10	1	333.3	9	0.3333	300	5556	1
11ac80MIMO	5530	Type6	10	1	333.3	9	0.3333	300	5447	1
11ac80MIMO	5530	Type6	10	1	333.3	9	0.3333	300	5645	1
11ac80MIMO	5530	Type6	10	1	333.3	9	0.3333	300	5579	1
11ac80MIMO	5530	Type6	10	1	333.3	9	0.3333	300	5533	1



Unless otherwise agreed in writing, this document is issued by the Company subject to its General Conditions of Service printed overleaf, available on request or accessible at <http://www.sgs.com/en/Terms-and-Conditions.aspx> and, for electronic format documents, subject to Terms and Conditions for Electronic Documents at <http://www.sgs.com/en/Terms-and-Conditions/Terms-e-Documents.aspx>. Attention is drawn to the limitation of liability, indemnification and jurisdiction issues defined therein. Any holder of this document is advised that information contained herein reflects the Company's findings at the time of its intervention only and within the limits of Client's instructions, if any. The Company's sole responsibility is to its Client and this document does not exonerate parties to a transaction from exercising all their rights and obligations under the transaction documents. This document cannot be reproduced except in full, without prior written approval of the Company. Any unauthorized alteration, forgery or falsification of the content or appearance of this document is unlawful and offenders may be prosecuted to the fullest extent of the law. Unless otherwise stated the results shown in this test report refer only to the sample(s) tested and such sample(s) are retained for 30 days only.

Attention: To check the authenticity of testing/inspection report & certificate, please contact us at telephone: (86-755) 8307 1443, or email: [CN.Doccheck@sgs.com](mailto:CN.Doccheck@sgs.com)

SGS-CSTC Standards Technical Services (Xi'an) Co., Ltd. | 1/E Unit D, Building 1, Kanglong Orange Science Park, No.157, Keyuan 3rd Road, Fengjing/Yue Town, Xi'an, Shaanxi, China | 710086 | t (86-29) 6282 7885 | www.sgs.com.cn  
 中国·西安·沣东新城科里三路157号康隆橙方科技园1号楼D单元1层 | 邮编: 710086 | t (86-29) 6282 7885 | sgs.china@sgs.com



Table with 11 columns: Item ID, Value, Type, Dimensions, Weight, Density, etc. Rows include items like 11ac80MIMO and 11ac40MIMO.



Unless otherwise agreed in writing, this document is issued by the Company subject to its General Conditions of Service printed overleaf, available on request or accessible at http://www.sgs.com/en/Terms-and-Conditions.aspx and, for electronic format documents, subject to Terms and Conditions for Electronic Documents at http://www.sgs.com/en/Terms-and-Conditions/Terms-e-Documents.aspx. Attention is drawn to the limitation of liability, indemnification and jurisdiction issues defined therein. Any holder of this document is advised that information contained herein reflects the Company's findings at the time of its intervention only and within the limits of Client's instructions, if any. The Company's sole responsibility is to its Client and this document does not exonerate parties to a transaction from exercising all their rights and obligations under the transaction documents. This document cannot be reproduced except in full, without prior written approval of the Company. Any unauthorized alteration, forgery or falsification of the content or appearance of this document is unlawful and offenders may be prosecuted to the fullest extent of the law. Unless otherwise stated the results shown in this test report refer only to the sample(s) tested and such sample(s) are retained for 30 days only. Attention: To check the authenticity of testing/inspection report & certificate, please contact us at telephone: (86-755) 8307 1443, or email: CN.Doccheck@sgs.com

11ac40MIMO	5510	Type6	10	1	333.3	9	0.3333	300	5644	1
11ac40MIMO	5510	Type6	10	1	333.3	9	0.3333	300	5696	1
11ac40MIMO	5510	Type6	10	1	333.3	9	0.3333	300	5384	1
11ac40MIMO	5510	Type6	10	1	333.3	9	0.3333	300	5548	1
11ac40MIMO	5510	Type6	10	1	333.3	9	0.3333	300	5470	1
11ac40MIMO	5510	Type6	10	1	333.3	9	0.3333	300	5435	1
11ac40MIMO	5510	Type6	10	1	333.3	9	0.3333	300	5514	1
11ac40MIMO	5510	Type6	10	1	333.3	9	0.3333	300	5653	1
11ac40MIMO	5510	Type6	10	1	333.3	9	0.3333	300	5694	1
11ac40MIMO	5510	Type6	10	1	333.3	9	0.3333	300	5492	1
11ac40MIMO	5510	Type6	10	1	333.3	9	0.3333	300	5324	1
11ac40MIMO	5510	Type6	10	1	333.3	9	0.3333	300	5303	1
11ac40MIMO	5510	Type6	10	1	333.3	9	0.3333	300	5323	1
11ac40MIMO	5510	Type6	10	1	333.3	9	0.3333	300	5357	1
11ac40MIMO	5510	Type6	10	1	333.3	9	0.3333	300	5667	1
11ac40MIMO	5510	Type6	10	1	333.3	9	0.3333	300	5657	1
11ac40MIMO	5510	Type6	10	1	333.3	9	0.3333	300	5641	1
11ac40MIMO	5510	Type6	10	1	333.3	9	0.3333	300	5572	1
11ac40MIMO	5510	Type6	10	1	333.3	9	0.3333	300	5425	1
11ac40MIMO	5510	Type6	10	1	333.3	9	0.3333	300	5440	1
11ac40MIMO	5510	Type6	10	1	333.3	9	0.3333	300	5610	1
11ac40MIMO	5510	Type6	10	1	333.3	9	0.3333	300	5711	1
11ac40MIMO	5510	Type6	10	1	333.3	9	0.3333	300	5616	1
11ac40MIMO	5510	Type6	10	1	333.3	9	0.3333	300	5473	1
11ac40MIMO	5510	Type6	10	1	333.3	9	0.3333	300	5414	1
11ac40MIMO	5510	Type6	10	1	333.3	9	0.3333	300	5338	1
11ac40MIMO	5510	Type6	10	1	333.3	9	0.3333	300	5584	1
11ac40MIMO	5510	Type6	10	1	333.3	9	0.3333	300	5674	1
11ac40MIMO	5510	Type6	10	1	333.3	9	0.3333	300	5541	1
11ac40MIMO	5510	Type6	10	1	333.3	9	0.3333	300	5719	1
11ac40MIMO	5510	Type6	10	1	333.3	9	0.3333	300	5432	1
11ac40MIMO	5510	Type6	10	1	333.3	9	0.3333	300	5480	1
11ac40MIMO	5510	Type6	10	1	333.3	9	0.3333	300	5651	1
11ac40MIMO	5510	Type6	10	1	333.3	9	0.3333	300	5431	1
11ac40MIMO	5510	Type6	10	1	333.3	9	0.3333	300	5457	1
11ac40MIMO	5510	Type6	10	1	333.3	9	0.3333	300	5348	1
11ac40MIMO	5510	Type6	10	1	333.3	9	0.3333	300	5615	1
11ac40MIMO	5510	Type6	10	1	333.3	9	0.3333	300	5254	1
11ac40MIMO	5510	Type6	10	1	333.3	9	0.3333	300	5715	1
11ac40MIMO	5510	Type6	10	1	333.3	9	0.3333	300	5373	1
11ac40MIMO	5510	Type6	10	1	333.3	9	0.3333	300	5295	1
11ac40MIMO	5510	Type6	10	1	333.3	9	0.3333	300	5365	1
11ac40MIMO	5510	Type6	10	1	333.3	9	0.3333	300	5556	1
11ac40MIMO	5510	Type6	10	1	333.3	9	0.3333	300	5447	1
11ac40MIMO	5510	Type6	10	1	333.3	9	0.3333	300	5645	1
11ac40MIMO	5510	Type6	10	1	333.3	9	0.3333	300	5579	1
11ac40MIMO	5510	Type6	10	1	333.3	9	0.3333	300	5533	1
11ac40MIMO	5510	Type6	10	1	333.3	9	0.3333	300	5277	1
11ac40MIMO	5510	Type6	10	1	333.3	9	0.3333	300	5703	1
11ac40MIMO	5510	Type6	10	1	333.3	9	0.3333	300	5298	1
11ac40MIMO	5510	Type6	10	1	333.3	9	0.3333	300	5252	1
11ac40MIMO	5510	Type6	10	1	333.3	9	0.3333	300	5566	1
11ac40MIMO	5510	Type6	10	1	333.3	9	0.3333	300	5280	1



Unless otherwise agreed in writing, this document is issued by the Company subject to its General Conditions of Service printed overleaf, available on request or accessible at <http://www.sgs.com/en/Terms-and-Conditions.aspx> and, for electronic format documents, subject to Terms and Conditions for Electronic Documents at <http://www.sgs.com/en/Terms-and-Conditions/Terms-e-Documents.aspx>. Attention is drawn to the limitation of liability, indemnification and jurisdiction issues defined therein. Any holder of this document is advised that information contained herein reflects the Company's findings at the time of its intervention only and within the limits of Client's instructions, if any. The Company's sole responsibility is to its Client and this document does not exonerate parties to a transaction from exercising all their rights and obligations under the transaction documents. This document cannot be reproduced except in full, without prior written approval of the Company. Any unauthorized alteration, forgery or falsification of the content or appearance of this document is unlawful and offenders may be prosecuted to the fullest extent of the law. Unless otherwise stated the results shown in this test report refer only to the sample(s) tested and such sample(s) are retained for 30 days only.

Attention: To check the authenticity of testing/inspection report & certificate, please contact us at telephone: (86-755) 8307 1443, or email: [CN.Doccheck@sgs.com](mailto:CN.Doccheck@sgs.com)

SGS-CSTC Standards Technical Services (Xi'an) Co., Ltd. | 1/F Unit D, Building 1, Kanglong Orange Science Park, No.137, Keyuan 3rd Road, Fengyang New Town, Xian, Shaanxi, China | 710086 | T (86-29) 6282 7885 | [www.sgs.com](http://www.sgs.com)  
 中国·西安·沣东新城科里三路137号康隆橙方科技园1号楼D单元1层 | 邮编: 710086 | T (86-29) 6282 7885 | [sgs.china@sgs.com](mailto:sgs.china@sgs.com)

11ac40MIMO	5510	Type6	10	1	333.3	9	0.3333	300	5330	1
11ac40MIMO	5510	Type6	10	1	333.3	9	0.3333	300	5636	1
11ac40MIMO	5510	Type6	10	1	333.3	9	0.3333	300	5562	1
11ac40MIMO	5510	Type6	10	1	333.3	9	0.3333	300	5403	1
11ac40MIMO	5510	Type6	10	1	333.3	9	0.3333	300	5444	1
11ac40MIMO	5510	Type6	10	1	333.3	9	0.3333	300	5655	1
11ac40MIMO	5510	Type6	10	1	333.3	9	0.3333	300	5704	1
11ac40MIMO	5510	Type6	10	1	333.3	9	0.3333	300	5519	1
11ac40MIMO	5510	Type6	10	1	333.3	9	0.3333	300	5676	1
11ac40MIMO	5510	Type6	10	1	333.3	9	0.3333	300	5427	1
11ac40MIMO	5510	Type6	10	1	333.3	9	0.3333	300	5596	1
11ac40MIMO	5510	Type6	10	1	333.3	9	0.3333	300	5568	1
11ac40MIMO	5510	Type6	10	1	333.3	9	0.3333	300	5583	1
11ac40MIMO	5510	Type6	10	1	333.3	9	0.3333	300	5450	1
11ac40MIMO	5510	Type6	10	1	333.3	9	0.3333	300	5640	1
11ac40MIMO	5510	Type6	10	1	333.3	9	0.3333	300	5304	1
11ac40MIMO	5510	Type6	10	1	333.3	9	0.3333	300	5421	1
11ac40MIMO	5510	Type6	10	1	333.3	9	0.3333	300	5547	1
11ac40MIMO	5510	Type6	10	1	333.3	9	0.3333	300	5288	1
11ac40MIMO	5510	Type6	10	1	333.3	9	0.3333	300	5598	1
11ac40MIMO	5510	Type6	10	1	333.3	9	0.3333	300	5264	1
11ac40MIMO	5510	Type6	10	1	333.3	9	0.3333	300	5494	1
11ac40MIMO	5510	Type6	10	1	333.3	9	0.3333	300	5484	1
11ac40MIMO	5510	Type6	10	1	333.3	9	0.3333	300	5695	1
11ac40MIMO	5510	Type6	10	1	333.3	9	0.3333	300	5488	1
11ac40MIMO	5510	Type6	10	1	333.3	9	0.3333	300	5495	1
11ac40MIMO	5510	Type6	10	1	333.3	9	0.3333	300	5660	1
11ac40MIMO	5510	Type6	10	1	333.3	9	0.3333	300	5293	1
11ac40MIMO	5510	Type6	10	1	333.3	9	0.3333	300	5527	1
11ac40MIMO	5510	Type6	10	1	333.3	9	0.3333	300	5639	1
11ac40MIMO	5510	Type6	10	1	333.3	9	0.3333	300	5718	1
11ac40MIMO	5510	Type6	10	1	333.3	9	0.3333	300	5351	1
11ac40MIMO	5510	Type6	10	1	333.3	9	0.3333	300	5643	1
11ac40MIMO	5510	Type6	10	1	333.3	9	0.3333	300	5511	1
11ac40MIMO	5510	Type6	10	1	333.3	9	0.3333	300	5462	1
11ac40MIMO	5510	Type6	10	1	333.3	9	0.3333	300	5632	1
11ac40MIMO	5510	Type6	10	1	333.3	9	0.3333	300	5310	1
11ac40MIMO	5510	Type6	10	1	333.3	9	0.3333	300	5394	1
11ac40MIMO	5510	Type6	10	1	333.3	9	0.3333	300	5501	1
11ac40MIMO	5510	Type6	10	1	333.3	9	0.3333	300	5476	1
11ac40MIMO	5510	Type6	10	1	333.3	9	0.3333	300	5576	1
11ac40MIMO	5510	Type6	10	1	333.3	9	0.3333	300	5327	1
11ac40MIMO	5510	Type6	10	1	333.3	9	0.3333	300	5378	1
11ac40MIMO	5510	Type6	10	1	333.3	9	0.3333	300	5333	1
11ac40MIMO	5510	Type6	10	1	333.3	9	0.3333	300	5362	1
11ac20MIMO	5500	Type6	10	1	333.3	9	0.3333	300	5345	1
11ac20MIMO	5500	Type6	10	1	333.3	9	0.3333	300	5354	1
11ac20MIMO	5500	Type6	10	1	333.3	9	0.3333	300	5644	1
11ac20MIMO	5500	Type6	10	1	333.3	9	0.3333	300	5696	1
11ac20MIMO	5500	Type6	10	1	333.3	9	0.3333	300	5384	1
11ac20MIMO	5500	Type6	10	1	333.3	9	0.3333	300	5548	1
11ac20MIMO	5500	Type6	10	1	333.3	9	0.3333	300	5470	1
11ac20MIMO	5500	Type6	10	1	333.3	9	0.3333	300	5435	1



Unless otherwise agreed in writing, this document is issued by the Company subject to its General Conditions of Service printed overleaf, available on request or accessible at <http://www.sgs.com/en/Terms-and-Conditions.aspx> and, for electronic format documents, subject to Terms and Conditions for Electronic Documents at <http://www.sgs.com/en/Terms-and-Conditions/Terms-e-Documents.aspx>. Attention is drawn to the limitation of liability, indemnification and jurisdiction issues defined therein. Any holder of this document is advised that information contained herein reflects the Company's findings at the time of its intervention only and within the limits of Client's instructions, if any. The Company's sole responsibility is to its Client and this document does not exonerate parties to a transaction from exercising all their rights and obligations under the transaction documents. This document cannot be reproduced except in full, without prior written approval of the Company. Any unauthorized alteration, forgery or falsification of the content or appearance of this document is unlawful and offenders may be prosecuted to the fullest extent of the law. Unless otherwise stated the results shown in this test report refer only to the sample(s) tested and such sample(s) are retained for 30 days only.

Attention: To check the authenticity of testing/inspection report & certificate, please contact us at telephone: (86-755) 8307 1443, or email: [CN.Doccheck@sgs.com](mailto:CN.Doccheck@sgs.com)

SGS-CSTC Standards Technical Services (Xi'an) Co., Ltd. | 1/F, Unit D, Building 1, Kanglong Orange Science Park, No.157, Keyuan 3rd Road, Fengyang New Town, Xi'an, Shaanxi, China | 710086 | T (86-29) 6282 7885 | [www.sgs.com](http://www.sgs.com)  
 中国·西安·沣东新城科里三路157号康隆橙方科技园1号楼D单元1层 | 邮编: 710086 | T (86-29) 6282 7885 | [sgs.china@sgs.com](mailto:sgs.china@sgs.com)

11ac20MIMO	5500	Type6	10	1	333.3	9	0.3333	300	5514	1
11ac20MIMO	5500	Type6	10	1	333.3	9	0.3333	300	5653	1
11ac20MIMO	5500	Type6	10	1	333.3	9	0.3333	300	5694	1
11ac20MIMO	5500	Type6	10	1	333.3	9	0.3333	300	5492	1
11ac20MIMO	5500	Type6	10	1	333.3	9	0.3333	300	5324	1
11ac20MIMO	5500	Type6	10	1	333.3	9	0.3333	300	5303	1
11ac20MIMO	5500	Type6	10	1	333.3	9	0.3333	300	5323	1
11ac20MIMO	5500	Type6	10	1	333.3	9	0.3333	300	5357	1
11ac20MIMO	5500	Type6	10	1	333.3	9	0.3333	300	5667	1
11ac20MIMO	5500	Type6	10	1	333.3	9	0.3333	300	5657	1
11ac20MIMO	5500	Type6	10	1	333.3	9	0.3333	300	5641	1
11ac20MIMO	5500	Type6	10	1	333.3	9	0.3333	300	5572	1
11ac20MIMO	5500	Type6	10	1	333.3	9	0.3333	300	5425	1
11ac20MIMO	5500	Type6	10	1	333.3	9	0.3333	300	5440	1
11ac20MIMO	5500	Type6	10	1	333.3	9	0.3333	300	5610	1
11ac20MIMO	5500	Type6	10	1	333.3	9	0.3333	300	5711	1
11ac20MIMO	5500	Type6	10	1	333.3	9	0.3333	300	5616	1
11ac20MIMO	5500	Type6	10	1	333.3	9	0.3333	300	5473	1
11ac20MIMO	5500	Type6	10	1	333.3	9	0.3333	300	5414	1
11ac20MIMO	5500	Type6	10	1	333.3	9	0.3333	300	5338	1
11ac20MIMO	5500	Type6	10	1	333.3	9	0.3333	300	5584	1
11ac20MIMO	5500	Type6	10	1	333.3	9	0.3333	300	5674	1
11ac20MIMO	5500	Type6	10	1	333.3	9	0.3333	300	5541	1
11ac20MIMO	5500	Type6	10	1	333.3	9	0.3333	300	5719	1
11ac20MIMO	5500	Type6	10	1	333.3	9	0.3333	300	5432	1
11ac20MIMO	5500	Type6	10	1	333.3	9	0.3333	300	5480	1
11ac20MIMO	5500	Type6	10	1	333.3	9	0.3333	300	5651	1
11ac20MIMO	5500	Type6	10	1	333.3	9	0.3333	300	5431	1
11ac20MIMO	5500	Type6	10	1	333.3	9	0.3333	300	5457	1
11ac20MIMO	5500	Type6	10	1	333.3	9	0.3333	300	5348	1
11ac20MIMO	5500	Type6	10	1	333.3	9	0.3333	300	5615	1
11ac20MIMO	5500	Type6	10	1	333.3	9	0.3333	300	5254	1
11ac20MIMO	5500	Type6	10	1	333.3	9	0.3333	300	5715	1
11ac20MIMO	5500	Type6	10	1	333.3	9	0.3333	300	5373	1
11ac20MIMO	5500	Type6	10	1	333.3	9	0.3333	300	5295	1
11ac20MIMO	5500	Type6	10	1	333.3	9	0.3333	300	5365	1
11ac20MIMO	5500	Type6	10	1	333.3	9	0.3333	300	5556	1
11ac20MIMO	5500	Type6	10	1	333.3	9	0.3333	300	5447	1
11ac20MIMO	5500	Type6	10	1	333.3	9	0.3333	300	5645	1
11ac20MIMO	5500	Type6	10	1	333.3	9	0.3333	300	5579	1
11ac20MIMO	5500	Type6	10	1	333.3	9	0.3333	300	5533	1
11ac20MIMO	5500	Type6	10	1	333.3	9	0.3333	300	5277	1
11ac20MIMO	5500	Type6	10	1	333.3	9	0.3333	300	5703	1
11ac20MIMO	5500	Type6	10	1	333.3	9	0.3333	300	5298	1
11ac20MIMO	5500	Type6	10	1	333.3	9	0.3333	300	5252	1
11ac20MIMO	5500	Type6	10	1	333.3	9	0.3333	300	5566	1
11ac20MIMO	5500	Type6	10	1	333.3	9	0.3333	300	5280	1
11ac20MIMO	5500	Type6	10	1	333.3	9	0.3333	300	5330	1
11ac20MIMO	5500	Type6	10	1	333.3	9	0.3333	300	5636	1
11ac20MIMO	5500	Type6	10	1	333.3	9	0.3333	300	5562	1
11ac20MIMO	5500	Type6	10	1	333.3	9	0.3333	300	5403	1
11ac20MIMO	5500	Type6	10	1	333.3	9	0.3333	300	5444	1
11ac20MIMO	5500	Type6	10	1	333.3	9	0.3333	300	5655	1



Unless otherwise agreed in writing, this document is issued by the Company subject to its General Conditions of Service printed overleaf, available on request or accessible at <http://www.sgs.com/en/Terms-and-Conditions.aspx> and, for electronic format documents, subject to Terms and Conditions for Electronic Documents at <http://www.sgs.com/en/Terms-and-Conditions/Terms-e-Document.aspx>. Attention is drawn to the limitation of liability, indemnification and jurisdiction issues defined therein. Any holder of this document is advised that information contained herein reflects the Company's findings at the time of its intervention only and within the limits of Client's instructions, if any. The Company's sole responsibility is to its Client and this document does not exonerate parties to a transaction from exercising all their rights and obligations under the transaction documents. This document cannot be reproduced except in full, without prior written approval of the Company. Any unauthorized alteration, forgery or falsification of the content or appearance of this document is unlawful and offenders may be prosecuted to the fullest extent of the law. Unless otherwise stated the results shown in this test report refer only to the sample(s) tested and such sample(s) are retained for 30 days only.

Attention: To check the authenticity of testing/inspection report & certificate, please contact us at telephone: (86-755) 8307 1443, or email: [CN.Doccheck@sgs.com](mailto:CN.Doccheck@sgs.com)  
 (E) Unit D, Building 1, Kanglong Orange Science Park, No.157, Keyuan 3rd Road, Fengyang New Town, Xi'an, Shaanxi, China 710086  
 t (86-29) 6282 7885 www.sgs.com.cn  
 中国·西安·沣东新城科里三路157号康隆橙方科技园1号楼D单元1层 邮编: 710086 t (86-29) 6282 7885 sgs.china@sgs.com



Report No.: XEWA2310000070RG05

Rev.: 01

Page: 153 of 267

11ac20MIMO	5500	Type6	10	1	333.3	9	0.3333	300	5704	1
11ac20MIMO	5500	Type6	10	1	333.3	9	0.3333	300	5519	1
11ac20MIMO	5500	Type6	10	1	333.3	9	0.3333	300	5676	1
11ac20MIMO	5500	Type6	10	1	333.3	9	0.3333	300	5427	1
11ac20MIMO	5500	Type6	10	1	333.3	9	0.3333	300	5596	1
11ac20MIMO	5500	Type6	10	1	333.3	9	0.3333	300	5568	1
11ac20MIMO	5500	Type6	10	1	333.3	9	0.3333	300	5583	1
11ac20MIMO	5500	Type6	10	1	333.3	9	0.3333	300	5450	1
11ac20MIMO	5500	Type6	10	1	333.3	9	0.3333	300	5640	1
11ac20MIMO	5500	Type6	10	1	333.3	9	0.3333	300	5304	1
11ac20MIMO	5500	Type6	10	1	333.3	9	0.3333	300	5421	1
11ac20MIMO	5500	Type6	10	1	333.3	9	0.3333	300	5547	1
11ac20MIMO	5500	Type6	10	1	333.3	9	0.3333	300	5288	1
11ac20MIMO	5500	Type6	10	1	333.3	9	0.3333	300	5598	1
11ac20MIMO	5500	Type6	10	1	333.3	9	0.3333	300	5264	1
11ac20MIMO	5500	Type6	10	1	333.3	9	0.3333	300	5494	1
11ac20MIMO	5500	Type6	10	1	333.3	9	0.3333	300	5484	1
11ac20MIMO	5500	Type6	10	1	333.3	9	0.3333	300	5695	1
11ac20MIMO	5500	Type6	10	1	333.3	9	0.3333	300	5488	1
11ac20MIMO	5500	Type6	10	1	333.3	9	0.3333	300	5495	1
11ac20MIMO	5500	Type6	10	1	333.3	9	0.3333	300	5660	1
11ac20MIMO	5500	Type6	10	1	333.3	9	0.3333	300	5293	1
11ac20MIMO	5500	Type6	10	1	333.3	9	0.3333	300	5527	1
11ac20MIMO	5500	Type6	10	1	333.3	9	0.3333	300	5639	1
11ac20MIMO	5500	Type6	10	1	333.3	9	0.3333	300	5718	1
11ac20MIMO	5500	Type6	10	1	333.3	9	0.3333	300	5351	1
11ac20MIMO	5500	Type6	10	1	333.3	9	0.3333	300	5643	1
11ac20MIMO	5500	Type6	10	1	333.3	9	0.3333	300	5511	1
11ac20MIMO	5500	Type6	10	1	333.3	9	0.3333	300	5462	1
11ac20MIMO	5500	Type6	10	1	333.3	9	0.3333	300	5632	1
11ac20MIMO	5500	Type6	10	1	333.3	9	0.3333	300	5310	1
11ac20MIMO	5500	Type6	10	1	333.3	9	0.3333	300	5394	1
11ac20MIMO	5500	Type6	10	1	333.3	9	0.3333	300	5501	1
11ac20MIMO	5500	Type6	10	1	333.3	9	0.3333	300	5476	1
11ac20MIMO	5500	Type6	10	1	333.3	9	0.3333	300	5576	1
11ac20MIMO	5500	Type6	10	1	333.3	9	0.3333	300	5327	1
11ac20MIMO	5500	Type6	10	1	333.3	9	0.3333	300	5378	1
11ac20MIMO	5500	Type6	10	1	333.3	9	0.3333	300	5333	1
11ac20MIMO	5500	Type6	10	1	333.3	9	0.3333	300	5362	1



Unless otherwise agreed in writing, this document is issued by the Company subject to its General Conditions of Service printed overleaf, available on request or accessible at <http://www.sgs.com/en/Terms-and-Conditions.aspx> and, for electronic format documents, subject to Terms and Conditions for Electronic Documents at <http://www.sgs.com/en/Terms-and-Conditions/Terms-e-Documents.aspx>. Attention is drawn to the limitation of liability, indemnification and jurisdiction issues defined therein. Any holder of this document is advised that information contained herein reflects the Company's findings at the time of its intervention only and within the limits of Client's instructions, if any. The Company's sole responsibility is to its Client and this document does not exonerate parties to a transaction from exercising all their rights and obligations under the transaction documents. This document cannot be reproduced except in full, without prior written approval of the Company. Any unauthorized alteration, forgery or falsification of the content or appearance of this document is unlawful and offenders may be prosecuted to the fullest extent of the law. Unless otherwise stated the results shown in this test report refer only to the sample(s) tested and such sample(s) are retained for 30 days only.

Attention: To check the authenticity of testing/inspection report & certificate, please contact us at telephone: (86-755) 4307 1443, or email: [CN.Doccheck@sgs.com](mailto:CN.Doccheck@sgs.com)  
 (SGS-CSTC) Standards Technical Services (Xi'an) Co., Ltd. | 1/E Unit D, Building 1, Kanghong Orange Source Park, No.137, Keyuan 3rd Road, Fengling New Town, Xi'an, Shaanxi, China | 710086 | t: (86-29) 6282 7885 | www.sgs.com.cn  
 中国·西安·沣东新城科园三路137号康鸿橙方科技园1号楼D单元1层 | 邮编: 710086 | t: (86-29) 6282 7885 | sgs.china@sgs.com

TestMode	Channel	Radar Type	Trial ID	Pulse width (μs)	PRI (μs)	Pulses per Hop	Hop Rate (kHz)	Hop Sequence Length(ms)	Center Frequency (MHz)	Detection (1: Yes; 0: No)
11ac80MIMO	5530	Type6	11	1	333.3	9	0.3333	300	5503	1
11ac80MIMO	5530	Type6	11	1	333.3	9	0.3333	300	5593	1
11ac80MIMO	5530	Type6	11	1	333.3	9	0.3333	300	5580	1
11ac80MIMO	5530	Type6	11	1	333.3	9	0.3333	300	5382	1
11ac80MIMO	5530	Type6	11	1	333.3	9	0.3333	300	5604	1
11ac80MIMO	5530	Type6	11	1	333.3	9	0.3333	300	5590	1
11ac80MIMO	5530	Type6	11	1	333.3	9	0.3333	300	5492	1
11ac80MIMO	5530	Type6	11	1	333.3	9	0.3333	300	5510	1
11ac80MIMO	5530	Type6	11	1	333.3	9	0.3333	300	5385	1
11ac80MIMO	5530	Type6	11	1	333.3	9	0.3333	300	5625	1
11ac80MIMO	5530	Type6	11	1	333.3	9	0.3333	300	5281	1
11ac80MIMO	5530	Type6	11	1	333.3	9	0.3333	300	5365	1
11ac80MIMO	5530	Type6	11	1	333.3	9	0.3333	300	5498	1
11ac80MIMO	5530	Type6	11	1	333.3	9	0.3333	300	5344	1
11ac80MIMO	5530	Type6	11	1	333.3	9	0.3333	300	5348	1
11ac80MIMO	5530	Type6	11	1	333.3	9	0.3333	300	5319	1
11ac80MIMO	5530	Type6	11	1	333.3	9	0.3333	300	5285	1
11ac80MIMO	5530	Type6	11	1	333.3	9	0.3333	300	5686	1
11ac80MIMO	5530	Type6	11	1	333.3	9	0.3333	300	5386	1
11ac80MIMO	5530	Type6	11	1	333.3	9	0.3333	300	5336	1
11ac80MIMO	5530	Type6	11	1	333.3	9	0.3333	300	5509	1
11ac80MIMO	5530	Type6	11	1	333.3	9	0.3333	300	5551	1
11ac80MIMO	5530	Type6	11	1	333.3	9	0.3333	300	5325	1
11ac80MIMO	5530	Type6	11	1	333.3	9	0.3333	300	5589	1
11ac80MIMO	5530	Type6	11	1	333.3	9	0.3333	300	5361	1
11ac80MIMO	5530	Type6	11	1	333.3	9	0.3333	300	5563	1
11ac80MIMO	5530	Type6	11	1	333.3	9	0.3333	300	5520	1
11ac80MIMO	5530	Type6	11	1	333.3	9	0.3333	300	5442	1
11ac80MIMO	5530	Type6	11	1	333.3	9	0.3333	300	5618	1
11ac80MIMO	5530	Type6	11	1	333.3	9	0.3333	300	5716	1
11ac80MIMO	5530	Type6	11	1	333.3	9	0.3333	300	5411	1
11ac80MIMO	5530	Type6	11	1	333.3	9	0.3333	300	5459	1
11ac80MIMO	5530	Type6	11	1	333.3	9	0.3333	300	5681	1
11ac80MIMO	5530	Type6	11	1	333.3	9	0.3333	300	5300	1
11ac80MIMO	5530	Type6	11	1	333.3	9	0.3333	300	5315	1
11ac80MIMO	5530	Type6	11	1	333.3	9	0.3333	300	5522	1
11ac80MIMO	5530	Type6	11	1	333.3	9	0.3333	300	5350	1
11ac80MIMO	5530	Type6	11	1	333.3	9	0.3333	300	5501	1
11ac80MIMO	5530	Type6	11	1	333.3	9	0.3333	300	5529	1
11ac80MIMO	5530	Type6	11	1	333.3	9	0.3333	300	5568	1
11ac80MIMO	5530	Type6	11	1	333.3	9	0.3333	300	5323	1
11ac80MIMO	5530	Type6	11	1	333.3	9	0.3333	300	5689	1
11ac80MIMO	5530	Type6	11	1	333.3	9	0.3333	300	5535	1
11ac80MIMO	5530	Type6	11	1	333.3	9	0.3333	300	5362	1
11ac80MIMO	5530	Type6	11	1	333.3	9	0.3333	300	5485	1
11ac80MIMO	5530	Type6	11	1	333.3	9	0.3333	300	5427	1
11ac80MIMO	5530	Type6	11	1	333.3	9	0.3333	300	5253	1
11ac80MIMO	5530	Type6	11	1	333.3	9	0.3333	300	5637	1
11ac80MIMO	5530	Type6	11	1	333.3	9	0.3333	300	5667	1



Unless otherwise agreed in writing, this document is issued by the Company subject to its General Conditions of Service printed overleaf, available on request or accessible at <http://www.sgs.com/en/Terms-and-Conditions.aspx> and, for electronic format documents, subject to Terms and Conditions for Electronic Documents at <http://www.sgs.com/en/Terms-and-Conditions/Terms-e-Documents.aspx>. Attention is drawn to the limitation of liability, indemnification and jurisdiction issues defined therein. Any holder of this document is advised that information contained herein reflects the Company's findings at the time of its intervention only and within the limits of Client's instructions, if any. The Company's sole responsibility is to its Client and this document does not exonerate parties to a transaction from exercising all their rights and obligations under the transaction documents. This document cannot be reproduced except in full, without prior written approval of the Company. Any unauthorized alteration, forgery or falsification of the content or appearance of this document is unlawful and offenders may be prosecuted to the fullest extent of the law. Unless otherwise stated the results shown in this test report refer only to the sample(s) tested and such sample(s) are retained for 30 days only.

Attention: To check the authenticity of testing/inspection report & certificate, please contact us at telephone: (86-755) 8307 1443, or email: [CN.Doccheck@sgs.com](mailto:CN.Doccheck@sgs.com)

SGS-CSTC Standards Technical Services (Xi'an) Co., Ltd. | 1/E Unit D, Building 1, Kanglong Orange Science Park, No.157, Keyuan 3rd Road, Fengjing/Yue Town, Xi'an, Shaanxi, China | 710086 | t (86-29) 6282 7885 | www.sgs.com.cn  
 中国·西安·沣东新城科里三路157号康隆橙方科技园1号楼D单元1层 | 邮编: 710086 | t (86-29) 6282 7885 | sgs.china@sgs.com

11ac80MIMO	5530	Type6	11	1	333.3	9	0.3333	300	5628	1
11ac80MIMO	5530	Type6	11	1	333.3	9	0.3333	300	5404	1
11ac80MIMO	5530	Type6	11	1	333.3	9	0.3333	300	5349	1
11ac80MIMO	5530	Type6	11	1	333.3	9	0.3333	300	5341	1
11ac80MIMO	5530	Type6	11	1	333.3	9	0.3333	300	5389	1
11ac80MIMO	5530	Type6	11	1	333.3	9	0.3333	300	5602	1
11ac80MIMO	5530	Type6	11	1	333.3	9	0.3333	300	5518	1
11ac80MIMO	5530	Type6	11	1	333.3	9	0.3333	300	5277	1
11ac80MIMO	5530	Type6	11	1	333.3	9	0.3333	300	5697	1
11ac80MIMO	5530	Type6	11	1	333.3	9	0.3333	300	5415	1
11ac80MIMO	5530	Type6	11	1	333.3	9	0.3333	300	5309	1
11ac80MIMO	5530	Type6	11	1	333.3	9	0.3333	300	5394	1
11ac80MIMO	5530	Type6	11	1	333.3	9	0.3333	300	5464	1
11ac80MIMO	5530	Type6	11	1	333.3	9	0.3333	300	5508	1
11ac80MIMO	5530	Type6	11	1	333.3	9	0.3333	300	5639	1
11ac80MIMO	5530	Type6	11	1	333.3	9	0.3333	300	5391	1
11ac80MIMO	5530	Type6	11	1	333.3	9	0.3333	300	5380	1
11ac80MIMO	5530	Type6	11	1	333.3	9	0.3333	300	5282	1
11ac80MIMO	5530	Type6	11	1	333.3	9	0.3333	300	5532	1
11ac80MIMO	5530	Type6	11	1	333.3	9	0.3333	300	5582	1
11ac80MIMO	5530	Type6	11	1	333.3	9	0.3333	300	5493	1
11ac80MIMO	5530	Type6	11	1	333.3	9	0.3333	300	5533	1
11ac80MIMO	5530	Type6	11	1	333.3	9	0.3333	300	5587	1
11ac80MIMO	5530	Type6	11	1	333.3	9	0.3333	300	5515	1
11ac80MIMO	5530	Type6	11	1	333.3	9	0.3333	300	5574	1
11ac80MIMO	5530	Type6	11	1	333.3	9	0.3333	300	5698	1
11ac80MIMO	5530	Type6	11	1	333.3	9	0.3333	300	5483	1
11ac80MIMO	5530	Type6	11	1	333.3	9	0.3333	300	5614	1
11ac80MIMO	5530	Type6	11	1	333.3	9	0.3333	300	5530	1
11ac80MIMO	5530	Type6	11	1	333.3	9	0.3333	300	5676	1
11ac80MIMO	5530	Type6	11	1	333.3	9	0.3333	300	5265	1
11ac80MIMO	5530	Type6	11	1	333.3	9	0.3333	300	5605	1
11ac80MIMO	5530	Type6	11	1	333.3	9	0.3333	300	5441	1
11ac80MIMO	5530	Type6	11	1	333.3	9	0.3333	300	5360	1
11ac80MIMO	5530	Type6	11	1	333.3	9	0.3333	300	5636	1
11ac80MIMO	5530	Type6	11	1	333.3	9	0.3333	300	5438	1
11ac80MIMO	5530	Type6	11	1	333.3	9	0.3333	300	5351	1
11ac80MIMO	5530	Type6	11	1	333.3	9	0.3333	300	5474	1
11ac80MIMO	5530	Type6	11	1	333.3	9	0.3333	300	5654	1
11ac80MIMO	5530	Type6	11	1	333.3	9	0.3333	300	5500	1
11ac80MIMO	5530	Type6	11	1	333.3	9	0.3333	300	5642	1
11ac80MIMO	5530	Type6	11	1	333.3	9	0.3333	300	5321	1
11ac80MIMO	5530	Type6	11	1	333.3	9	0.3333	300	5579	1
11ac80MIMO	5530	Type6	11	1	333.3	9	0.3333	300	5482	1
11ac80MIMO	5530	Type6	11	1	333.3	9	0.3333	300	5610	1
11ac80MIMO	5530	Type6	11	1	333.3	9	0.3333	300	5684	1
11ac80MIMO	5530	Type6	11	1	333.3	9	0.3333	300	5388	1
11ac80MIMO	5530	Type6	11	1	333.3	9	0.3333	300	5443	1
11ac80MIMO	5530	Type6	11	1	333.3	9	0.3333	300	5547	1
11ac80MIMO	5530	Type6	11	1	333.3	9	0.3333	300	5581	1
11ac80MIMO	5530	Type6	11	1	333.3	9	0.3333	300	5527	1
11ac40MIMO	5510	Type6	11	1	333.3	9	0.3333	300	5503	1
11ac40MIMO	5510	Type6	11	1	333.3	9	0.3333	300	5593	1



Unless otherwise agreed in writing, this document is issued by the Company subject to its General Conditions of Service printed overleaf, available on request or accessible at <http://www.sgs.com/en/Terms-and-Conditions.aspx> and, for electronic format documents, subject to Terms and Conditions for Electronic Documents at <http://www.sgs.com/en/Terms-and-Conditions/Terms-e-Documents.aspx>. Attention is drawn to the limitation of liability, indemnification and jurisdiction issues defined therein. Any holder of this document is advised that information contained herein reflects the Company's findings at the time of its intervention only and within the limits of Client's instructions, if any. The Company's sole responsibility is to its Client and this document does not exonerate parties to a transaction from exercising all their rights and obligations under the transaction documents. This document cannot be reproduced except in full, without prior written approval of the Company. Any unauthorized alteration, forgery or falsification of the content or appearance of this document is unlawful and offenders may be prosecuted to the fullest extent of the law. Unless otherwise stated the results shown in this test report refer only to the sample(s) tested and such sample(s) are retained for 30 days only.

Attention: To check the authenticity of testing/inspection report & certificate, please contact us at telephone: (86-755) 8307 1443, or email: CN.Doccheck@sgs.com

SGS-CSTC Standards Technical Services (Xi'an) Co., Ltd. | 1/F, Unit D, Building 1, Kanglong Orange Science Park, No.157, Keyuan 3rd Road, Fengfeng New Town, Xi'an, Shaanxi, China | 710086 | T (86-29) 6282 7885 | www.sgs.com.cn  
 中国·西安·沣东新城科里三路157号康隆橙方科技园1号楼D单元1层 | 邮编: 710086 | T (86-29) 6282 7885 | sgs.china@sgs.com



11ac40MIMO	5510	Type6	11	1	333.3	9	0.3333	300	5580	1
11ac40MIMO	5510	Type6	11	1	333.3	9	0.3333	300	5382	1
11ac40MIMO	5510	Type6	11	1	333.3	9	0.3333	300	5604	1
11ac40MIMO	5510	Type6	11	1	333.3	9	0.3333	300	5590	1
11ac40MIMO	5510	Type6	11	1	333.3	9	0.3333	300	5492	1
11ac40MIMO	5510	Type6	11	1	333.3	9	0.3333	300	5510	1
11ac40MIMO	5510	Type6	11	1	333.3	9	0.3333	300	5385	1
11ac40MIMO	5510	Type6	11	1	333.3	9	0.3333	300	5625	1
11ac40MIMO	5510	Type6	11	1	333.3	9	0.3333	300	5281	1
11ac40MIMO	5510	Type6	11	1	333.3	9	0.3333	300	5365	1
11ac40MIMO	5510	Type6	11	1	333.3	9	0.3333	300	5498	1
11ac40MIMO	5510	Type6	11	1	333.3	9	0.3333	300	5344	1
11ac40MIMO	5510	Type6	11	1	333.3	9	0.3333	300	5348	1
11ac40MIMO	5510	Type6	11	1	333.3	9	0.3333	300	5319	1
11ac40MIMO	5510	Type6	11	1	333.3	9	0.3333	300	5285	1
11ac40MIMO	5510	Type6	11	1	333.3	9	0.3333	300	5686	1
11ac40MIMO	5510	Type6	11	1	333.3	9	0.3333	300	5386	1
11ac40MIMO	5510	Type6	11	1	333.3	9	0.3333	300	5336	1
11ac40MIMO	5510	Type6	11	1	333.3	9	0.3333	300	5509	1
11ac40MIMO	5510	Type6	11	1	333.3	9	0.3333	300	5551	1
11ac40MIMO	5510	Type6	11	1	333.3	9	0.3333	300	5325	1
11ac40MIMO	5510	Type6	11	1	333.3	9	0.3333	300	5589	1
11ac40MIMO	5510	Type6	11	1	333.3	9	0.3333	300	5361	1
11ac40MIMO	5510	Type6	11	1	333.3	9	0.3333	300	5563	1
11ac40MIMO	5510	Type6	11	1	333.3	9	0.3333	300	5520	1
11ac40MIMO	5510	Type6	11	1	333.3	9	0.3333	300	5442	1
11ac40MIMO	5510	Type6	11	1	333.3	9	0.3333	300	5618	1
11ac40MIMO	5510	Type6	11	1	333.3	9	0.3333	300	5716	1
11ac40MIMO	5510	Type6	11	1	333.3	9	0.3333	300	5411	1
11ac40MIMO	5510	Type6	11	1	333.3	9	0.3333	300	5459	1
11ac40MIMO	5510	Type6	11	1	333.3	9	0.3333	300	5681	1
11ac40MIMO	5510	Type6	11	1	333.3	9	0.3333	300	5300	1
11ac40MIMO	5510	Type6	11	1	333.3	9	0.3333	300	5315	1
11ac40MIMO	5510	Type6	11	1	333.3	9	0.3333	300	5522	1
11ac40MIMO	5510	Type6	11	1	333.3	9	0.3333	300	5350	1
11ac40MIMO	5510	Type6	11	1	333.3	9	0.3333	300	5501	1
11ac40MIMO	5510	Type6	11	1	333.3	9	0.3333	300	5529	1
11ac40MIMO	5510	Type6	11	1	333.3	9	0.3333	300	5568	1
11ac40MIMO	5510	Type6	11	1	333.3	9	0.3333	300	5323	1
11ac40MIMO	5510	Type6	11	1	333.3	9	0.3333	300	5689	1
11ac40MIMO	5510	Type6	11	1	333.3	9	0.3333	300	5535	1
11ac40MIMO	5510	Type6	11	1	333.3	9	0.3333	300	5362	1
11ac40MIMO	5510	Type6	11	1	333.3	9	0.3333	300	5485	1
11ac40MIMO	5510	Type6	11	1	333.3	9	0.3333	300	5427	1
11ac40MIMO	5510	Type6	11	1	333.3	9	0.3333	300	5253	1
11ac40MIMO	5510	Type6	11	1	333.3	9	0.3333	300	5637	1
11ac40MIMO	5510	Type6	11	1	333.3	9	0.3333	300	5667	1
11ac40MIMO	5510	Type6	11	1	333.3	9	0.3333	300	5628	1
11ac40MIMO	5510	Type6	11	1	333.3	9	0.3333	300	5404	1
11ac40MIMO	5510	Type6	11	1	333.3	9	0.3333	300	5349	1
11ac40MIMO	5510	Type6	11	1	333.3	9	0.3333	300	5341	1
11ac40MIMO	5510	Type6	11	1	333.3	9	0.3333	300	5389	1
11ac40MIMO	5510	Type6	11	1	333.3	9	0.3333	300	5602	1



Unless otherwise agreed in writing, this document is issued by the Company subject to its General Conditions of Service printed overleaf, available on request or accessible at <http://www.sgs.com/en/Terms-and-Conditions.aspx> and, for electronic format documents, subject to Terms and Conditions for Electronic Documents at <http://www.sgs.com/en/Terms-and-Conditions/Terms-e-Documents.aspx>. Attention is drawn to the limitation of liability, indemnification and jurisdiction issues defined therein. Any holder of this document is advised that information contained herein reflects the Company's findings at the time of its intervention only and within the limits of Client's instructions, if any. The Company's sole responsibility is to its Client and this document does not exonerate parties to a transaction from exercising all their rights and obligations under the transaction documents. This document cannot be reproduced except in full, without prior written approval of the Company. Any unauthorized alteration, forgery or falsification of the content or appearance of this document is unlawful and offenders may be prosecuted to the fullest extent of the law. Unless otherwise stated the results shown in this test report refer only to the sample(s) tested and such sample(s) are retained for 30 days only.

Attention: To check the authenticity of testing/inspection report & certificate, please contact us at telephone: (86-755) 8307 1443, or email: [CN.Doccheck@sgs.com](mailto:CN.Doccheck@sgs.com)  
 (E) Unit D, Building 1, Kanglong Orange Science Park, No.157, Keyuan 3rd Road, Fengjing/Yue Town, Xian, Shaanxi, China 710086  
 t (86-29) 6282 7885 www.sgs.com.cn  
 中国·西安·沣东新城科里三路157号康隆橙方科技园1号楼D单元1层 邮编: 710086 t (86-29) 6282 7885 sgs.china@sgs.com



Table with 11 columns: Sample ID, Weight, Type, Dimensions, Density, etc. Rows include 11ac40MIMO and 11ac20MIMO series.



Unless otherwise agreed in writing, this document is issued by the Company subject to its General Conditions of Service printed overleaf, available on request or accessible at http://www.sgs.com/en/Terms-and-Conditions.aspx and, for electronic format documents, subject to Terms and Conditions for Electronic Documents at http://www.sgs.com/en/Terms-and-Conditions/Terms-e-Documents.aspx. Attention is drawn to the limitation of liability, indemnification and jurisdiction issues defined therein. Any holder of this document is advised that information contained herein reflects the Company's findings at the time of its intervention only and within the limits of Client's instructions, if any. The Company's sole responsibility is to its Client and this document does not exonerate parties to a transaction from exercising all their rights and obligations under the transaction documents. This document cannot be reproduced except in full, without prior written approval of the Company. Any unauthorized alteration, forgery or falsification of the content or appearance of this document is unlawful and offenders may be prosecuted to the fullest extent of the law. Unless otherwise stated the results shown in this test report refer only to the sample(s) tested and such sample(s) are retained for 30 days only. Attention: To check the authenticity of testing/inspection report & certificate, please contact us at telephone: (86-755) 8307 1443, or email: CN.Doccheck@sgs.com



11ac20MIMO	5500	Type6	11	1	333.3	9	0.3333	300	5385	1
11ac20MIMO	5500	Type6	11	1	333.3	9	0.3333	300	5625	1
11ac20MIMO	5500	Type6	11	1	333.3	9	0.3333	300	5281	1
11ac20MIMO	5500	Type6	11	1	333.3	9	0.3333	300	5365	1
11ac20MIMO	5500	Type6	11	1	333.3	9	0.3333	300	5498	1
11ac20MIMO	5500	Type6	11	1	333.3	9	0.3333	300	5344	1
11ac20MIMO	5500	Type6	11	1	333.3	9	0.3333	300	5348	1
11ac20MIMO	5500	Type6	11	1	333.3	9	0.3333	300	5319	1
11ac20MIMO	5500	Type6	11	1	333.3	9	0.3333	300	5285	1
11ac20MIMO	5500	Type6	11	1	333.3	9	0.3333	300	5686	1
11ac20MIMO	5500	Type6	11	1	333.3	9	0.3333	300	5386	1
11ac20MIMO	5500	Type6	11	1	333.3	9	0.3333	300	5336	1
11ac20MIMO	5500	Type6	11	1	333.3	9	0.3333	300	5509	1
11ac20MIMO	5500	Type6	11	1	333.3	9	0.3333	300	5551	1
11ac20MIMO	5500	Type6	11	1	333.3	9	0.3333	300	5325	1
11ac20MIMO	5500	Type6	11	1	333.3	9	0.3333	300	5589	1
11ac20MIMO	5500	Type6	11	1	333.3	9	0.3333	300	5361	1
11ac20MIMO	5500	Type6	11	1	333.3	9	0.3333	300	5563	1
11ac20MIMO	5500	Type6	11	1	333.3	9	0.3333	300	5520	1
11ac20MIMO	5500	Type6	11	1	333.3	9	0.3333	300	5442	1
11ac20MIMO	5500	Type6	11	1	333.3	9	0.3333	300	5618	1
11ac20MIMO	5500	Type6	11	1	333.3	9	0.3333	300	5716	1
11ac20MIMO	5500	Type6	11	1	333.3	9	0.3333	300	5411	1
11ac20MIMO	5500	Type6	11	1	333.3	9	0.3333	300	5459	1
11ac20MIMO	5500	Type6	11	1	333.3	9	0.3333	300	5681	1
11ac20MIMO	5500	Type6	11	1	333.3	9	0.3333	300	5300	1
11ac20MIMO	5500	Type6	11	1	333.3	9	0.3333	300	5315	1
11ac20MIMO	5500	Type6	11	1	333.3	9	0.3333	300	5522	1
11ac20MIMO	5500	Type6	11	1	333.3	9	0.3333	300	5350	1
11ac20MIMO	5500	Type6	11	1	333.3	9	0.3333	300	5501	1
11ac20MIMO	5500	Type6	11	1	333.3	9	0.3333	300	5529	1
11ac20MIMO	5500	Type6	11	1	333.3	9	0.3333	300	5568	1
11ac20MIMO	5500	Type6	11	1	333.3	9	0.3333	300	5323	1
11ac20MIMO	5500	Type6	11	1	333.3	9	0.3333	300	5689	1
11ac20MIMO	5500	Type6	11	1	333.3	9	0.3333	300	5535	1
11ac20MIMO	5500	Type6	11	1	333.3	9	0.3333	300	5362	1
11ac20MIMO	5500	Type6	11	1	333.3	9	0.3333	300	5485	1
11ac20MIMO	5500	Type6	11	1	333.3	9	0.3333	300	5427	1
11ac20MIMO	5500	Type6	11	1	333.3	9	0.3333	300	5253	1
11ac20MIMO	5500	Type6	11	1	333.3	9	0.3333	300	5637	1
11ac20MIMO	5500	Type6	11	1	333.3	9	0.3333	300	5667	1
11ac20MIMO	5500	Type6	11	1	333.3	9	0.3333	300	5628	1
11ac20MIMO	5500	Type6	11	1	333.3	9	0.3333	300	5404	1
11ac20MIMO	5500	Type6	11	1	333.3	9	0.3333	300	5349	1
11ac20MIMO	5500	Type6	11	1	333.3	9	0.3333	300	5341	1
11ac20MIMO	5500	Type6	11	1	333.3	9	0.3333	300	5389	1
11ac20MIMO	5500	Type6	11	1	333.3	9	0.3333	300	5602	1
11ac20MIMO	5500	Type6	11	1	333.3	9	0.3333	300	5518	1
11ac20MIMO	5500	Type6	11	1	333.3	9	0.3333	300	5277	1
11ac20MIMO	5500	Type6	11	1	333.3	9	0.3333	300	5697	1
11ac20MIMO	5500	Type6	11	1	333.3	9	0.3333	300	5415	1
11ac20MIMO	5500	Type6	11	1	333.3	9	0.3333	300	5309	1
11ac20MIMO	5500	Type6	11	1	333.3	9	0.3333	300	5394	1



Unless otherwise agreed in writing, this document is issued by the Company subject to its General Conditions of Service printed overleaf, available on request or accessible at <http://www.sgs.com/en/Terms-and-Conditions.aspx> and, for electronic format documents, subject to Terms and Conditions for Electronic Documents at <http://www.sgs.com/en/Terms-and-Conditions/Terms-e-Documents.aspx>. Attention is drawn to the limitation of liability, indemnification and jurisdiction issues defined therein. Any holder of this document is advised that information contained herein reflects the Company's findings at the time of its intervention only and within the limits of Client's instructions, if any. The Company's sole responsibility is to its Client and this document does not exonerate parties to a transaction from exercising all their rights and obligations under the transaction documents. This document cannot be reproduced except in full, without prior written approval of the Company. Any unauthorized alteration, forgery or falsification of the content or appearance of this document is unlawful and offenders may be prosecuted to the fullest extent of the law. Unless otherwise stated the results shown in this test report refer only to the sample(s) tested and such sample(s) are retained for 30 days only.

Attention: To check the authenticity of testing/inspection report & certificate, please contact us at telephone: (86-755) 8307 1443, or email: [CN.Doccheck@sgs.com](mailto:CN.Doccheck@sgs.com)  
 (E) Unit D, Building 1, Kanglong Orange Science Park, No.157, Keyuan 3rd Road, Fengfeng New Town, Xian, Shaanxi, China 710086  
 t (86-29) 6282 7885 www.sgs.com.cn  
 中国·西安·沣东新城科里三路157号康隆橙方科技园1号楼D单元1层 邮编: 710086 t (86-29) 6282 7885 sgs.china@sgs.com

Report No.: XEWA2310000070RG05

Rev.: 01

Page: 159 of 267

11ac20MIMO	5500	Type6	11	1	333.3	9	0.3333	300	5464	1
11ac20MIMO	5500	Type6	11	1	333.3	9	0.3333	300	5508	1
11ac20MIMO	5500	Type6	11	1	333.3	9	0.3333	300	5639	1
11ac20MIMO	5500	Type6	11	1	333.3	9	0.3333	300	5391	1
11ac20MIMO	5500	Type6	11	1	333.3	9	0.3333	300	5380	1
11ac20MIMO	5500	Type6	11	1	333.3	9	0.3333	300	5282	1
11ac20MIMO	5500	Type6	11	1	333.3	9	0.3333	300	5532	1
11ac20MIMO	5500	Type6	11	1	333.3	9	0.3333	300	5582	1
11ac20MIMO	5500	Type6	11	1	333.3	9	0.3333	300	5493	1
11ac20MIMO	5500	Type6	11	1	333.3	9	0.3333	300	5533	1
11ac20MIMO	5500	Type6	11	1	333.3	9	0.3333	300	5587	1
11ac20MIMO	5500	Type6	11	1	333.3	9	0.3333	300	5515	1
11ac20MIMO	5500	Type6	11	1	333.3	9	0.3333	300	5574	1
11ac20MIMO	5500	Type6	11	1	333.3	9	0.3333	300	5698	1
11ac20MIMO	5500	Type6	11	1	333.3	9	0.3333	300	5483	1
11ac20MIMO	5500	Type6	11	1	333.3	9	0.3333	300	5614	1
11ac20MIMO	5500	Type6	11	1	333.3	9	0.3333	300	5530	1
11ac20MIMO	5500	Type6	11	1	333.3	9	0.3333	300	5676	1
11ac20MIMO	5500	Type6	11	1	333.3	9	0.3333	300	5265	1
11ac20MIMO	5500	Type6	11	1	333.3	9	0.3333	300	5605	1
11ac20MIMO	5500	Type6	11	1	333.3	9	0.3333	300	5441	1
11ac20MIMO	5500	Type6	11	1	333.3	9	0.3333	300	5360	1
11ac20MIMO	5500	Type6	11	1	333.3	9	0.3333	300	5636	1
11ac20MIMO	5500	Type6	11	1	333.3	9	0.3333	300	5438	1
11ac20MIMO	5500	Type6	11	1	333.3	9	0.3333	300	5351	1
11ac20MIMO	5500	Type6	11	1	333.3	9	0.3333	300	5474	1
11ac20MIMO	5500	Type6	11	1	333.3	9	0.3333	300	5654	1
11ac20MIMO	5500	Type6	11	1	333.3	9	0.3333	300	5500	1
11ac20MIMO	5500	Type6	11	1	333.3	9	0.3333	300	5642	1
11ac20MIMO	5500	Type6	11	1	333.3	9	0.3333	300	5321	1
11ac20MIMO	5500	Type6	11	1	333.3	9	0.3333	300	5579	1
11ac20MIMO	5500	Type6	11	1	333.3	9	0.3333	300	5482	1
11ac20MIMO	5500	Type6	11	1	333.3	9	0.3333	300	5610	1
11ac20MIMO	5500	Type6	11	1	333.3	9	0.3333	300	5684	1
11ac20MIMO	5500	Type6	11	1	333.3	9	0.3333	300	5388	1
11ac20MIMO	5500	Type6	11	1	333.3	9	0.3333	300	5443	1
11ac20MIMO	5500	Type6	11	1	333.3	9	0.3333	300	5547	1
11ac20MIMO	5500	Type6	11	1	333.3	9	0.3333	300	5581	1
11ac20MIMO	5500	Type6	11	1	333.3	9	0.3333	300	5527	1



Unless otherwise agreed in writing, this document is issued by the Company subject to its General Conditions of Service printed overleaf, available on request or accessible at <http://www.sgs.com/en/Terms-and-Conditions.aspx> and, for electronic format documents, subject to Terms and Conditions for Electronic Documents at <http://www.sgs.com/en/Terms-and-Conditions/Terms-e-Documents.aspx>. Attention is drawn to the limitation of liability, indemnification and jurisdiction issues defined therein. Any holder of this document is advised that information contained herein reflects the Company's findings at the time of its intervention only and within the limits of Client's instructions, if any. The Company's sole responsibility is to its Client and this document does not exonerate parties to a transaction from exercising all their rights and obligations under the transaction documents. This document cannot be reproduced except in full, without prior written approval of the Company. Any unauthorized alteration, forgery or falsification of the content or appearance of this document is unlawful and offenders may be prosecuted to the fullest extent of the law. Unless otherwise stated the results shown in this test report refer only to the sample(s) tested and such sample(s) are retained for 30 days only.

Attention: To check the authenticity of testing/inspection report & certificate, please contact us at telephone: (86-755) 4307 1443, or email: [CN.Doccheck@sgs.com](mailto:CN.Doccheck@sgs.com)  
 (US) Unit D, Building 1, Kanghong Orange Science Park, No.157, Keyuan 3rd Road, Fenglong New Town, Xi'an, Shaanxi, China 710086 t (86-29) 6282 7885 www.sgs.com.cn  
 中国·西安·沣东新城科园三路157号康鸿橙方科技园1号楼D单元1层 邮编: 710086 t (86-29) 6282 7885 sgs.china@sgs.com

TestMode	Channel	Radar Type	Trial ID	Pulse width (μs)	PRI (μs)	Pulses per Hop	Hop Rate (kHz)	Hop Sequence Length(ms)	Center Frequency (MHz)	Detection (1: Yes; 0: No)
11ac80MIMO	5530	Type6	12	1	333.3	9	0.3333	300	5283	1
11ac80MIMO	5530	Type6	12	1	333.3	9	0.3333	300	5357	1
11ac80MIMO	5530	Type6	12	1	333.3	9	0.3333	300	5516	1
11ac80MIMO	5530	Type6	12	1	333.3	9	0.3333	300	5543	1
11ac80MIMO	5530	Type6	12	1	333.3	9	0.3333	300	5446	1
11ac80MIMO	5530	Type6	12	1	333.3	9	0.3333	300	5632	1
11ac80MIMO	5530	Type6	12	1	333.3	9	0.3333	300	5417	1
11ac80MIMO	5530	Type6	12	1	333.3	9	0.3333	300	5585	1
11ac80MIMO	5530	Type6	12	1	333.3	9	0.3333	300	5268	1
11ac80MIMO	5530	Type6	12	1	333.3	9	0.3333	300	5592	1
11ac80MIMO	5530	Type6	12	1	333.3	9	0.3333	300	5459	1
11ac80MIMO	5530	Type6	12	1	333.3	9	0.3333	300	5545	1
11ac80MIMO	5530	Type6	12	1	333.3	9	0.3333	300	5406	1
11ac80MIMO	5530	Type6	12	1	333.3	9	0.3333	300	5693	1
11ac80MIMO	5530	Type6	12	1	333.3	9	0.3333	300	5365	1
11ac80MIMO	5530	Type6	12	1	333.3	9	0.3333	300	5436	1
11ac80MIMO	5530	Type6	12	1	333.3	9	0.3333	300	5388	1
11ac80MIMO	5530	Type6	12	1	333.3	9	0.3333	300	5256	1
11ac80MIMO	5530	Type6	12	1	333.3	9	0.3333	300	5578	1
11ac80MIMO	5530	Type6	12	1	333.3	9	0.3333	300	5344	1
11ac80MIMO	5530	Type6	12	1	333.3	9	0.3333	300	5675	1
11ac80MIMO	5530	Type6	12	1	333.3	9	0.3333	300	5492	1
11ac80MIMO	5530	Type6	12	1	333.3	9	0.3333	300	5317	1
11ac80MIMO	5530	Type6	12	1	333.3	9	0.3333	300	5562	1
11ac80MIMO	5530	Type6	12	1	333.3	9	0.3333	300	5627	1
11ac80MIMO	5530	Type6	12	1	333.3	9	0.3333	300	5512	1
11ac80MIMO	5530	Type6	12	1	333.3	9	0.3333	300	5723	1
11ac80MIMO	5530	Type6	12	1	333.3	9	0.3333	300	5546	1
11ac80MIMO	5530	Type6	12	1	333.3	9	0.3333	300	5652	1
11ac80MIMO	5530	Type6	12	1	333.3	9	0.3333	300	5380	1
11ac80MIMO	5530	Type6	12	1	333.3	9	0.3333	300	5300	1
11ac80MIMO	5530	Type6	12	1	333.3	9	0.3333	300	5455	1
11ac80MIMO	5530	Type6	12	1	333.3	9	0.3333	300	5674	1
11ac80MIMO	5530	Type6	12	1	333.3	9	0.3333	300	5358	1
11ac80MIMO	5530	Type6	12	1	333.3	9	0.3333	300	5498	1
11ac80MIMO	5530	Type6	12	1	333.3	9	0.3333	300	5454	1
11ac80MIMO	5530	Type6	12	1	333.3	9	0.3333	300	5710	1
11ac80MIMO	5530	Type6	12	1	333.3	9	0.3333	300	5621	1
11ac80MIMO	5530	Type6	12	1	333.3	9	0.3333	300	5654	1
11ac80MIMO	5530	Type6	12	1	333.3	9	0.3333	300	5443	1
11ac80MIMO	5530	Type6	12	1	333.3	9	0.3333	300	5504	1
11ac80MIMO	5530	Type6	12	1	333.3	9	0.3333	300	5678	1
11ac80MIMO	5530	Type6	12	1	333.3	9	0.3333	300	5359	1
11ac80MIMO	5530	Type6	12	1	333.3	9	0.3333	300	5407	1
11ac80MIMO	5530	Type6	12	1	333.3	9	0.3333	300	5336	1
11ac80MIMO	5530	Type6	12	1	333.3	9	0.3333	300	5695	1
11ac80MIMO	5530	Type6	12	1	333.3	9	0.3333	300	5720	1
11ac80MIMO	5530	Type6	12	1	333.3	9	0.3333	300	5685	1
11ac80MIMO	5530	Type6	12	1	333.3	9	0.3333	300	5580	1



Unless otherwise agreed in writing, this document is issued by the Company subject to its General Conditions of Service printed overleaf, available on request or accessible at <http://www.sgs.com/en/Terms-and-Conditions.aspx> and, for electronic format documents, subject to Terms and Conditions for Electronic Documents at <http://www.sgs.com/en/Terms-and-Conditions/Terms-e-Documents.aspx>. Attention is drawn to the limitation of liability, indemnification and jurisdiction issues defined therein. Any holder of this document is advised that information contained herein reflects the Company's findings at the time of its intervention only and within the limits of Client's instructions, if any. The Company's sole responsibility is to its Client and this document does not exonerate parties to a transaction from exercising all their rights and obligations under the transaction documents. This document cannot be reproduced except in full, without prior written approval of the Company. Any unauthorized alteration, forgery or falsification of the content or appearance of this document is unlawful and offenders may be prosecuted to the fullest extent of the law. Unless otherwise stated the results shown in this test report refer only to the sample(s) tested and such sample(s) are retained for 30 days only.

Attention: To check the authenticity of testing/inspection report & certificate, please contact us at telephone: (86-755) 8307 1443, or email: [CN.Doccheck@sgs.com](mailto:CN.Doccheck@sgs.com)

SGS-CSTC Standards Technical Services (Xi'an) Co., Ltd. | 1/E Unit D, Building 1, Kanglong Orange Science Park, No.157, Keyuan 3rd Road, Fengjing/Yue Town, Xi'an, Shaanxi, China | 710086 | t (86-29) 6282 7885 | www.sgs.com.cn  
 中国·西安·沣东新城科里三路157号康隆橙方科技园1号楼D单元1层 | 邮编: 710086 | t (86-29) 6282 7885 | sgs.china@sgs.com



11ac80MIMO	5530	Type6	12	1	333.3	9	0.3333	300	5400	1
11ac80MIMO	5530	Type6	12	1	333.3	9	0.3333	300	5430	1
11ac80MIMO	5530	Type6	12	1	333.3	9	0.3333	300	5687	1
11ac80MIMO	5530	Type6	12	1	333.3	9	0.3333	300	5706	1
11ac80MIMO	5530	Type6	12	1	333.3	9	0.3333	300	5544	1
11ac80MIMO	5530	Type6	12	1	333.3	9	0.3333	300	5467	1
11ac80MIMO	5530	Type6	12	1	333.3	9	0.3333	300	5419	1
11ac80MIMO	5530	Type6	12	1	333.3	9	0.3333	300	5289	1
11ac80MIMO	5530	Type6	12	1	333.3	9	0.3333	300	5438	1
11ac80MIMO	5530	Type6	12	1	333.3	9	0.3333	300	5559	1
11ac80MIMO	5530	Type6	12	1	333.3	9	0.3333	300	5506	1
11ac80MIMO	5530	Type6	12	1	333.3	9	0.3333	300	5340	1
11ac80MIMO	5530	Type6	12	1	333.3	9	0.3333	300	5554	1
11ac80MIMO	5530	Type6	12	1	333.3	9	0.3333	300	5329	1
11ac80MIMO	5530	Type6	12	1	333.3	9	0.3333	300	5558	1
11ac80MIMO	5530	Type6	12	1	333.3	9	0.3333	300	5327	1
11ac80MIMO	5530	Type6	12	1	333.3	9	0.3333	300	5385	1
11ac80MIMO	5530	Type6	12	1	333.3	9	0.3333	300	5662	1
11ac80MIMO	5530	Type6	12	1	333.3	9	0.3333	300	5519	1
11ac80MIMO	5530	Type6	12	1	333.3	9	0.3333	300	5590	1
11ac80MIMO	5530	Type6	12	1	333.3	9	0.3333	300	5364	1
11ac80MIMO	5530	Type6	12	1	333.3	9	0.3333	300	5550	1
11ac80MIMO	5530	Type6	12	1	333.3	9	0.3333	300	5657	1
11ac80MIMO	5530	Type6	12	1	333.3	9	0.3333	300	5355	1
11ac80MIMO	5530	Type6	12	1	333.3	9	0.3333	300	5259	1
11ac80MIMO	5530	Type6	12	1	333.3	9	0.3333	300	5673	1
11ac80MIMO	5530	Type6	12	1	333.3	9	0.3333	300	5420	1
11ac80MIMO	5530	Type6	12	1	333.3	9	0.3333	300	5618	1
11ac80MIMO	5530	Type6	12	1	333.3	9	0.3333	300	5697	1
11ac80MIMO	5530	Type6	12	1	333.3	9	0.3333	300	5524	1
11ac80MIMO	5530	Type6	12	1	333.3	9	0.3333	300	5275	1
11ac80MIMO	5530	Type6	12	1	333.3	9	0.3333	300	5633	1
11ac80MIMO	5530	Type6	12	1	333.3	9	0.3333	300	5254	1
11ac80MIMO	5530	Type6	12	1	333.3	9	0.3333	300	5424	1
11ac80MIMO	5530	Type6	12	1	333.3	9	0.3333	300	5534	1
11ac80MIMO	5530	Type6	12	1	333.3	9	0.3333	300	5274	1
11ac80MIMO	5530	Type6	12	1	333.3	9	0.3333	300	5465	1
11ac80MIMO	5530	Type6	12	1	333.3	9	0.3333	300	5315	1
11ac80MIMO	5530	Type6	12	1	333.3	9	0.3333	300	5415	1
11ac80MIMO	5530	Type6	12	1	333.3	9	0.3333	300	5269	1
11ac80MIMO	5530	Type6	12	1	333.3	9	0.3333	300	5488	1
11ac80MIMO	5530	Type6	12	1	333.3	9	0.3333	300	5547	1
11ac80MIMO	5530	Type6	12	1	333.3	9	0.3333	300	5566	1
11ac80MIMO	5530	Type6	12	1	333.3	9	0.3333	300	5616	1
11ac80MIMO	5530	Type6	12	1	333.3	9	0.3333	300	5509	1
11ac80MIMO	5530	Type6	12	1	333.3	9	0.3333	300	5427	1
11ac80MIMO	5530	Type6	12	1	333.3	9	0.3333	300	5445	1
11ac80MIMO	5530	Type6	12	1	333.3	9	0.3333	300	5560	1
11ac80MIMO	5530	Type6	12	1	333.3	9	0.3333	300	5636	1
11ac80MIMO	5530	Type6	12	1	333.3	9	0.3333	300	5347	1
11ac80MIMO	5530	Type6	12	1	333.3	9	0.3333	300	5432	1
11ac40MIMO	5510	Type6	12	1	333.3	9	0.3333	300	5283	1
11ac40MIMO	5510	Type6	12	1	333.3	9	0.3333	300	5357	1



Unless otherwise agreed in writing, this document is issued by the Company subject to its General Conditions of Service printed overleaf, available on request or accessible at <http://www.sgs.com/en/Terms-and-Conditions.aspx> and, for electronic format documents, subject to Terms and Conditions for Electronic Documents at <http://www.sgs.com/en/Terms-and-Conditions/Terms-e-Documents.aspx>. Attention is drawn to the limitation of liability, indemnification and jurisdiction issues defined therein. Any holder of this document is advised that information contained herein reflects the Company's findings at the time of its intervention only and within the limits of Client's instructions, if any. The Company's sole responsibility is to its Client and this document does not exonerate parties to a transaction from exercising all their rights and obligations under the transaction documents. This document cannot be reproduced except in full, without prior written approval of the Company. Any unauthorized alteration, forgery or falsification of the content or appearance of this document is unlawful and offenders may be prosecuted to the fullest extent of the law. Unless otherwise stated the results shown in this test report refer only to the sample(s) tested and such sample(s) are retained for 30 days only.

Attention: To check the authenticity of testing inspection report & certificate, please contact us at telephone: (86-755) 8307 1443, or email: [CN.Doccheck@sgs.com](mailto:CN.Doccheck@sgs.com)  
 1/E Unit D, Building 1, Kanglong Orange Science Park, No.157, Keyuan 3rd Road, Fengjing/Ven Town, Xian, Shaanxi, China 710086  
 中国·西安·沣东新城科里三路157号康隆橙方科技园1号楼D单元1层 邮编: 710086  
 t (86-29) 6282 7885 www.sgs.com.cn  
 t (86-29) 6282 7885 sgs.china@sgs.com

11ac40MIMO	5510	Type6	12	1	333.3	9	0.3333	300	5516	1
11ac40MIMO	5510	Type6	12	1	333.3	9	0.3333	300	5543	1
11ac40MIMO	5510	Type6	12	1	333.3	9	0.3333	300	5446	1
11ac40MIMO	5510	Type6	12	1	333.3	9	0.3333	300	5632	1
11ac40MIMO	5510	Type6	12	1	333.3	9	0.3333	300	5417	1
11ac40MIMO	5510	Type6	12	1	333.3	9	0.3333	300	5585	1
11ac40MIMO	5510	Type6	12	1	333.3	9	0.3333	300	5268	1
11ac40MIMO	5510	Type6	12	1	333.3	9	0.3333	300	5592	1
11ac40MIMO	5510	Type6	12	1	333.3	9	0.3333	300	5459	1
11ac40MIMO	5510	Type6	12	1	333.3	9	0.3333	300	5545	1
11ac40MIMO	5510	Type6	12	1	333.3	9	0.3333	300	5406	1
11ac40MIMO	5510	Type6	12	1	333.3	9	0.3333	300	5693	1
11ac40MIMO	5510	Type6	12	1	333.3	9	0.3333	300	5365	1
11ac40MIMO	5510	Type6	12	1	333.3	9	0.3333	300	5436	1
11ac40MIMO	5510	Type6	12	1	333.3	9	0.3333	300	5388	1
11ac40MIMO	5510	Type6	12	1	333.3	9	0.3333	300	5256	1
11ac40MIMO	5510	Type6	12	1	333.3	9	0.3333	300	5578	1
11ac40MIMO	5510	Type6	12	1	333.3	9	0.3333	300	5344	1
11ac40MIMO	5510	Type6	12	1	333.3	9	0.3333	300	5675	1
11ac40MIMO	5510	Type6	12	1	333.3	9	0.3333	300	5492	1
11ac40MIMO	5510	Type6	12	1	333.3	9	0.3333	300	5317	1
11ac40MIMO	5510	Type6	12	1	333.3	9	0.3333	300	5562	1
11ac40MIMO	5510	Type6	12	1	333.3	9	0.3333	300	5627	1
11ac40MIMO	5510	Type6	12	1	333.3	9	0.3333	300	5512	1
11ac40MIMO	5510	Type6	12	1	333.3	9	0.3333	300	5723	1
11ac40MIMO	5510	Type6	12	1	333.3	9	0.3333	300	5546	1
11ac40MIMO	5510	Type6	12	1	333.3	9	0.3333	300	5652	1
11ac40MIMO	5510	Type6	12	1	333.3	9	0.3333	300	5380	1
11ac40MIMO	5510	Type6	12	1	333.3	9	0.3333	300	5300	1
11ac40MIMO	5510	Type6	12	1	333.3	9	0.3333	300	5455	1
11ac40MIMO	5510	Type6	12	1	333.3	9	0.3333	300	5674	1
11ac40MIMO	5510	Type6	12	1	333.3	9	0.3333	300	5358	1
11ac40MIMO	5510	Type6	12	1	333.3	9	0.3333	300	5498	1
11ac40MIMO	5510	Type6	12	1	333.3	9	0.3333	300	5454	1
11ac40MIMO	5510	Type6	12	1	333.3	9	0.3333	300	5710	1
11ac40MIMO	5510	Type6	12	1	333.3	9	0.3333	300	5621	1
11ac40MIMO	5510	Type6	12	1	333.3	9	0.3333	300	5654	1
11ac40MIMO	5510	Type6	12	1	333.3	9	0.3333	300	5443	1
11ac40MIMO	5510	Type6	12	1	333.3	9	0.3333	300	5504	1
11ac40MIMO	5510	Type6	12	1	333.3	9	0.3333	300	5678	1
11ac40MIMO	5510	Type6	12	1	333.3	9	0.3333	300	5359	1
11ac40MIMO	5510	Type6	12	1	333.3	9	0.3333	300	5407	1
11ac40MIMO	5510	Type6	12	1	333.3	9	0.3333	300	5336	1
11ac40MIMO	5510	Type6	12	1	333.3	9	0.3333	300	5695	1
11ac40MIMO	5510	Type6	12	1	333.3	9	0.3333	300	5720	1
11ac40MIMO	5510	Type6	12	1	333.3	9	0.3333	300	5685	1
11ac40MIMO	5510	Type6	12	1	333.3	9	0.3333	300	5580	1
11ac40MIMO	5510	Type6	12	1	333.3	9	0.3333	300	5400	1
11ac40MIMO	5510	Type6	12	1	333.3	9	0.3333	300	5430	1
11ac40MIMO	5510	Type6	12	1	333.3	9	0.3333	300	5687	1
11ac40MIMO	5510	Type6	12	1	333.3	9	0.3333	300	5706	1
11ac40MIMO	5510	Type6	12	1	333.3	9	0.3333	300	5544	1
11ac40MIMO	5510	Type6	12	1	333.3	9	0.3333	300	5467	1



Unless otherwise agreed in writing, this document is issued by the Company subject to its General Conditions of Service printed overleaf, available on request or accessible at <http://www.sgs.com/en/Terms-and-Conditions.aspx> and, for electronic format documents, subject to Terms and Conditions for Electronic Documents at <http://www.sgs.com/en/Terms-and-Conditions/Terms-e-Documents.aspx>. Attention is drawn to the limitation of liability, indemnification and jurisdiction issues defined therein. Any holder of this document is advised that information contained herein reflects the Company's findings at the time of its intervention only and within the limits of Client's instructions, if any. The Company's sole responsibility is to its Client and this document does not exonerate parties to a transaction from exercising all their rights and obligations under the transaction documents. This document cannot be reproduced except in full, without prior written approval of the Company. Any unauthorized alteration, forgery or falsification of the content or appearance of this document is unlawful and offenders may be prosecuted to the fullest extent of the law. Unless otherwise stated the results shown in this test report refer only to the sample(s) tested and such sample(s) are retained for 30 days only.

Attention: To check the authenticity of testing/inspection report & certificate, please contact us at telephone: (86-755) 8307 1443, or email: [CN.Doccheck@sgs.com](mailto:CN.Doccheck@sgs.com)  
 (E) Unit D, Building 1, Kanglong Orange Science Park, No.157, Keyuan 3rd Road, Fengjing/Yue Town, Xian, Shaanxi, China 710086  
 t (86-29) 6282 7885 www.sgs.com.cn  
 中国·西安·沣东新城科里三路157号康隆橙方科技园1号楼D单元1层 邮编: 710086 t (86-29) 6282 7885 sgs.china@sgs.com

11ac40MIMO	5510	Type6	12	1	333.3	9	0.3333	300	5419	1
11ac40MIMO	5510	Type6	12	1	333.3	9	0.3333	300	5289	1
11ac40MIMO	5510	Type6	12	1	333.3	9	0.3333	300	5438	1
11ac40MIMO	5510	Type6	12	1	333.3	9	0.3333	300	5559	1
11ac40MIMO	5510	Type6	12	1	333.3	9	0.3333	300	5506	1
11ac40MIMO	5510	Type6	12	1	333.3	9	0.3333	300	5340	1
11ac40MIMO	5510	Type6	12	1	333.3	9	0.3333	300	5554	1
11ac40MIMO	5510	Type6	12	1	333.3	9	0.3333	300	5329	1
11ac40MIMO	5510	Type6	12	1	333.3	9	0.3333	300	5558	1
11ac40MIMO	5510	Type6	12	1	333.3	9	0.3333	300	5327	1
11ac40MIMO	5510	Type6	12	1	333.3	9	0.3333	300	5385	1
11ac40MIMO	5510	Type6	12	1	333.3	9	0.3333	300	5662	1
11ac40MIMO	5510	Type6	12	1	333.3	9	0.3333	300	5519	1
11ac40MIMO	5510	Type6	12	1	333.3	9	0.3333	300	5590	1
11ac40MIMO	5510	Type6	12	1	333.3	9	0.3333	300	5364	1
11ac40MIMO	5510	Type6	12	1	333.3	9	0.3333	300	5550	1
11ac40MIMO	5510	Type6	12	1	333.3	9	0.3333	300	5657	1
11ac40MIMO	5510	Type6	12	1	333.3	9	0.3333	300	5355	1
11ac40MIMO	5510	Type6	12	1	333.3	9	0.3333	300	5259	1
11ac40MIMO	5510	Type6	12	1	333.3	9	0.3333	300	5673	1
11ac40MIMO	5510	Type6	12	1	333.3	9	0.3333	300	5420	1
11ac40MIMO	5510	Type6	12	1	333.3	9	0.3333	300	5618	1
11ac40MIMO	5510	Type6	12	1	333.3	9	0.3333	300	5697	1
11ac40MIMO	5510	Type6	12	1	333.3	9	0.3333	300	5524	1
11ac40MIMO	5510	Type6	12	1	333.3	9	0.3333	300	5275	1
11ac40MIMO	5510	Type6	12	1	333.3	9	0.3333	300	5633	1
11ac40MIMO	5510	Type6	12	1	333.3	9	0.3333	300	5254	1
11ac40MIMO	5510	Type6	12	1	333.3	9	0.3333	300	5424	1
11ac40MIMO	5510	Type6	12	1	333.3	9	0.3333	300	5534	1
11ac40MIMO	5510	Type6	12	1	333.3	9	0.3333	300	5274	1
11ac40MIMO	5510	Type6	12	1	333.3	9	0.3333	300	5465	1
11ac40MIMO	5510	Type6	12	1	333.3	9	0.3333	300	5315	1
11ac40MIMO	5510	Type6	12	1	333.3	9	0.3333	300	5415	1
11ac40MIMO	5510	Type6	12	1	333.3	9	0.3333	300	5269	1
11ac40MIMO	5510	Type6	12	1	333.3	9	0.3333	300	5488	1
11ac40MIMO	5510	Type6	12	1	333.3	9	0.3333	300	5547	1
11ac40MIMO	5510	Type6	12	1	333.3	9	0.3333	300	5566	1
11ac40MIMO	5510	Type6	12	1	333.3	9	0.3333	300	5616	1
11ac40MIMO	5510	Type6	12	1	333.3	9	0.3333	300	5509	1
11ac40MIMO	5510	Type6	12	1	333.3	9	0.3333	300	5427	1
11ac40MIMO	5510	Type6	12	1	333.3	9	0.3333	300	5445	1
11ac40MIMO	5510	Type6	12	1	333.3	9	0.3333	300	5560	1
11ac40MIMO	5510	Type6	12	1	333.3	9	0.3333	300	5636	1
11ac40MIMO	5510	Type6	12	1	333.3	9	0.3333	300	5347	1
11ac40MIMO	5510	Type6	12	1	333.3	9	0.3333	300	5432	1
11ac20MIMO	5500	Type6	12	1	333.3	9	0.3333	300	5283	1
11ac20MIMO	5500	Type6	12	1	333.3	9	0.3333	300	5357	1
11ac20MIMO	5500	Type6	12	1	333.3	9	0.3333	300	5516	1
11ac20MIMO	5500	Type6	12	1	333.3	9	0.3333	300	5543	1
11ac20MIMO	5500	Type6	12	1	333.3	9	0.3333	300	5446	1
11ac20MIMO	5500	Type6	12	1	333.3	9	0.3333	300	5632	1
11ac20MIMO	5500	Type6	12	1	333.3	9	0.3333	300	5417	1
11ac20MIMO	5500	Type6	12	1	333.3	9	0.3333	300	5585	1



Unless otherwise agreed in writing, this document is issued by the Company subject to its General Conditions of Service printed overleaf, available on request or accessible at <http://www.sgs.com/en/Terms-and-Conditions.aspx> and, for electronic format documents, subject to Terms and Conditions for Electronic Documents at <http://www.sgs.com/en/Terms-and-Conditions/Terms-e-Documents.aspx>. Attention is drawn to the limitation of liability, indemnification and jurisdiction issues defined therein. Any holder of this document is advised that information contained herein reflects the Company's findings at the time of its intervention only and within the limits of Client's instructions, if any. The Company's sole responsibility is to its Client and this document does not exonerate parties to a transaction from exercising all their rights and obligations under the transaction documents. This document cannot be reproduced except in full, without prior written approval of the Company. Any unauthorized alteration, forgery or falsification of the content or appearance of this document is unlawful and offenders may be prosecuted to the fullest extent of the law. Unless otherwise stated the results shown in this test report refer only to the sample(s) tested and such sample(s) are retained for 30 days only.

Attention: To check the authenticity of testing/inspection report & certificate, please contact us at telephone: (86-755) 8307 1443, or email: [CN.Doccheck@sgs.com](mailto:CN.Doccheck@sgs.com)  
 1/E Unit D, Building 1, Kanglong Orange Science Park, No.157, Keyuan 3rd Road, Fengjing/Yue Town, Xian, Shaanxi, China 710086  
 t (86-29) 6282 7885 www.sgs.com.cn  
 中国·西安·沣东新城科里三路157号康隆橙方科技园1号楼D单元1层 邮编: 710086 t (86-29) 6282 7885 sgs.china@sgs.com

11ac20MIMO	5500	Type6	12	1	333.3	9	0.3333	300	5268	1
11ac20MIMO	5500	Type6	12	1	333.3	9	0.3333	300	5592	1
11ac20MIMO	5500	Type6	12	1	333.3	9	0.3333	300	5459	1
11ac20MIMO	5500	Type6	12	1	333.3	9	0.3333	300	5545	1
11ac20MIMO	5500	Type6	12	1	333.3	9	0.3333	300	5406	1
11ac20MIMO	5500	Type6	12	1	333.3	9	0.3333	300	5693	1
11ac20MIMO	5500	Type6	12	1	333.3	9	0.3333	300	5365	1
11ac20MIMO	5500	Type6	12	1	333.3	9	0.3333	300	5436	1
11ac20MIMO	5500	Type6	12	1	333.3	9	0.3333	300	5388	1
11ac20MIMO	5500	Type6	12	1	333.3	9	0.3333	300	5256	1
11ac20MIMO	5500	Type6	12	1	333.3	9	0.3333	300	5578	1
11ac20MIMO	5500	Type6	12	1	333.3	9	0.3333	300	5344	1
11ac20MIMO	5500	Type6	12	1	333.3	9	0.3333	300	5675	1
11ac20MIMO	5500	Type6	12	1	333.3	9	0.3333	300	5492	1
11ac20MIMO	5500	Type6	12	1	333.3	9	0.3333	300	5317	1
11ac20MIMO	5500	Type6	12	1	333.3	9	0.3333	300	5562	1
11ac20MIMO	5500	Type6	12	1	333.3	9	0.3333	300	5627	1
11ac20MIMO	5500	Type6	12	1	333.3	9	0.3333	300	5512	1
11ac20MIMO	5500	Type6	12	1	333.3	9	0.3333	300	5723	1
11ac20MIMO	5500	Type6	12	1	333.3	9	0.3333	300	5546	1
11ac20MIMO	5500	Type6	12	1	333.3	9	0.3333	300	5652	1
11ac20MIMO	5500	Type6	12	1	333.3	9	0.3333	300	5380	1
11ac20MIMO	5500	Type6	12	1	333.3	9	0.3333	300	5300	1
11ac20MIMO	5500	Type6	12	1	333.3	9	0.3333	300	5455	1
11ac20MIMO	5500	Type6	12	1	333.3	9	0.3333	300	5674	1
11ac20MIMO	5500	Type6	12	1	333.3	9	0.3333	300	5358	1
11ac20MIMO	5500	Type6	12	1	333.3	9	0.3333	300	5498	1
11ac20MIMO	5500	Type6	12	1	333.3	9	0.3333	300	5454	1
11ac20MIMO	5500	Type6	12	1	333.3	9	0.3333	300	5710	1
11ac20MIMO	5500	Type6	12	1	333.3	9	0.3333	300	5621	1
11ac20MIMO	5500	Type6	12	1	333.3	9	0.3333	300	5654	1
11ac20MIMO	5500	Type6	12	1	333.3	9	0.3333	300	5443	1
11ac20MIMO	5500	Type6	12	1	333.3	9	0.3333	300	5504	1
11ac20MIMO	5500	Type6	12	1	333.3	9	0.3333	300	5678	1
11ac20MIMO	5500	Type6	12	1	333.3	9	0.3333	300	5359	1
11ac20MIMO	5500	Type6	12	1	333.3	9	0.3333	300	5407	1
11ac20MIMO	5500	Type6	12	1	333.3	9	0.3333	300	5336	1
11ac20MIMO	5500	Type6	12	1	333.3	9	0.3333	300	5695	1
11ac20MIMO	5500	Type6	12	1	333.3	9	0.3333	300	5720	1
11ac20MIMO	5500	Type6	12	1	333.3	9	0.3333	300	5685	1
11ac20MIMO	5500	Type6	12	1	333.3	9	0.3333	300	5580	1
11ac20MIMO	5500	Type6	12	1	333.3	9	0.3333	300	5400	1
11ac20MIMO	5500	Type6	12	1	333.3	9	0.3333	300	5430	1
11ac20MIMO	5500	Type6	12	1	333.3	9	0.3333	300	5687	1
11ac20MIMO	5500	Type6	12	1	333.3	9	0.3333	300	5706	1
11ac20MIMO	5500	Type6	12	1	333.3	9	0.3333	300	5544	1
11ac20MIMO	5500	Type6	12	1	333.3	9	0.3333	300	5467	1
11ac20MIMO	5500	Type6	12	1	333.3	9	0.3333	300	5419	1
11ac20MIMO	5500	Type6	12	1	333.3	9	0.3333	300	5289	1
11ac20MIMO	5500	Type6	12	1	333.3	9	0.3333	300	5438	1
11ac20MIMO	5500	Type6	12	1	333.3	9	0.3333	300	5559	1
11ac20MIMO	5500	Type6	12	1	333.3	9	0.3333	300	5506	1
11ac20MIMO	5500	Type6	12	1	333.3	9	0.3333	300	5340	1



Unless otherwise agreed in writing, this document is issued by the Company subject to its General Conditions of Service printed overleaf, available on request or accessible at <http://www.sgs.com/en/Terms-and-Conditions.aspx> and, for electronic format documents, subject to Terms and Conditions for Electronic Documents at <http://www.sgs.com/en/Terms-and-Conditions/Terms-e-Documents.aspx>. Attention is drawn to the limitation of liability, indemnification and jurisdiction issues defined therein. Any holder of this document is advised that information contained herein reflects the Company's findings at the time of its intervention only and within the limits of Client's instructions, if any. The Company's sole responsibility is to its Client and this document does not exonerate parties to a transaction from exercising all their rights and obligations under the transaction documents. This document cannot be reproduced except in full, without prior written approval of the Company. Any unauthorized alteration, forgery or falsification of the content or appearance of this document is unlawful and offenders may be prosecuted to the fullest extent of the law. Unless otherwise stated the results shown in this test report refer only to the sample(s) tested and such sample(s) are retained for 30 days only.

Attention: To check the authenticity of testing/inspection report & certificate, please contact us at telephone: (86-755) 8307 1443, or email: [CN.Doccheck@sgs.com](mailto:CN.Doccheck@sgs.com)  
 1/E Unit D, Building 1, Kanglong Orange Science Park, No.157, Keyuan 3rd Road, Fengyang New Town, Xi'an, Shaanxi, China 710086  
 中国·西安·沣东新城科里三路157号康隆橙方科技园1号楼D单元1层 邮编: 710086  
 t (86-29) 6282 7885 www.sgs.com.cn  
 t (86-29) 6282 7885 sgs.china@sgs.com

Report No.: XEWA2310000070RG05

Rev.: 01

Page: 165 of 267

11ac20MIMO	5500	Type6	12	1	333.3	9	0.3333	300	5554	1
11ac20MIMO	5500	Type6	12	1	333.3	9	0.3333	300	5329	1
11ac20MIMO	5500	Type6	12	1	333.3	9	0.3333	300	5558	1
11ac20MIMO	5500	Type6	12	1	333.3	9	0.3333	300	5327	1
11ac20MIMO	5500	Type6	12	1	333.3	9	0.3333	300	5385	1
11ac20MIMO	5500	Type6	12	1	333.3	9	0.3333	300	5662	1
11ac20MIMO	5500	Type6	12	1	333.3	9	0.3333	300	5519	1
11ac20MIMO	5500	Type6	12	1	333.3	9	0.3333	300	5590	1
11ac20MIMO	5500	Type6	12	1	333.3	9	0.3333	300	5364	1
11ac20MIMO	5500	Type6	12	1	333.3	9	0.3333	300	5550	1
11ac20MIMO	5500	Type6	12	1	333.3	9	0.3333	300	5657	1
11ac20MIMO	5500	Type6	12	1	333.3	9	0.3333	300	5355	1
11ac20MIMO	5500	Type6	12	1	333.3	9	0.3333	300	5259	1
11ac20MIMO	5500	Type6	12	1	333.3	9	0.3333	300	5673	1
11ac20MIMO	5500	Type6	12	1	333.3	9	0.3333	300	5420	1
11ac20MIMO	5500	Type6	12	1	333.3	9	0.3333	300	5618	1
11ac20MIMO	5500	Type6	12	1	333.3	9	0.3333	300	5697	1
11ac20MIMO	5500	Type6	12	1	333.3	9	0.3333	300	5524	1
11ac20MIMO	5500	Type6	12	1	333.3	9	0.3333	300	5275	1
11ac20MIMO	5500	Type6	12	1	333.3	9	0.3333	300	5633	1
11ac20MIMO	5500	Type6	12	1	333.3	9	0.3333	300	5254	1
11ac20MIMO	5500	Type6	12	1	333.3	9	0.3333	300	5424	1
11ac20MIMO	5500	Type6	12	1	333.3	9	0.3333	300	5534	1
11ac20MIMO	5500	Type6	12	1	333.3	9	0.3333	300	5274	1
11ac20MIMO	5500	Type6	12	1	333.3	9	0.3333	300	5465	1
11ac20MIMO	5500	Type6	12	1	333.3	9	0.3333	300	5315	1
11ac20MIMO	5500	Type6	12	1	333.3	9	0.3333	300	5415	1
11ac20MIMO	5500	Type6	12	1	333.3	9	0.3333	300	5269	1
11ac20MIMO	5500	Type6	12	1	333.3	9	0.3333	300	5488	1
11ac20MIMO	5500	Type6	12	1	333.3	9	0.3333	300	5547	1
11ac20MIMO	5500	Type6	12	1	333.3	9	0.3333	300	5566	1
11ac20MIMO	5500	Type6	12	1	333.3	9	0.3333	300	5616	1
11ac20MIMO	5500	Type6	12	1	333.3	9	0.3333	300	5509	1
11ac20MIMO	5500	Type6	12	1	333.3	9	0.3333	300	5427	1
11ac20MIMO	5500	Type6	12	1	333.3	9	0.3333	300	5445	1
11ac20MIMO	5500	Type6	12	1	333.3	9	0.3333	300	5560	1
11ac20MIMO	5500	Type6	12	1	333.3	9	0.3333	300	5636	1
11ac20MIMO	5500	Type6	12	1	333.3	9	0.3333	300	5347	1
11ac20MIMO	5500	Type6	12	1	333.3	9	0.3333	300	5432	1



Unless otherwise agreed in writing, this document is issued by the Company subject to its General Conditions of Service printed overleaf, available on request or accessible at <http://www.sgs.com/en/Terms-and-Conditions.aspx> and, for electronic format documents, subject to Terms and Conditions for Electronic Documents at <http://www.sgs.com/en/Terms-and-Conditions/Terms-e-Documents.aspx>. Attention is drawn to the limitation of liability, indemnification and jurisdiction issues defined therein. Any holder of this document is advised that information contained herein reflects the Company's findings at the time of its intervention only and within the limits of Client's instructions, if any. The Company's sole responsibility is to its Client and this document does not exonerate parties to a transaction from exercising all their rights and obligations under the transaction documents. This document cannot be reproduced except in full, without prior written approval of the Company. Any unauthorized alteration, forgery or falsification of the content or appearance of this document is unlawful and offenders may be prosecuted to the fullest extent of the law. Unless otherwise stated the results shown in this test report refer only to the sample(s) tested and such sample(s) are retained for 30 days only.

Attention: To check the authenticity of testing/inspection report & certificate, please contact us at telephone: (86-755) 4307 1443, or email: [CN.Doccheck@sgs.com](mailto:CN.Doccheck@sgs.com)

SGS-CSTC Standards Technical Services (Xi'an) Co., Ltd. | 1/E Unit D, Building 1, Kanghong Orange Source Park, No.137, Kejian 3rd Road, Fengling New Town, Xi'an, Shaanxi, China | 710086 | t (86-29) 6282 7885 | www.sgs.com.cn  
 中国·西安·沣东新城科里三路137号康鸿橙方科技园1号楼D单元1层 | 邮编: 710086 | t (86-29) 6282 7885 | sgs.china@sgs.com

TestMode	Channel	Radar Type	Trial ID	Pulse width (μs)	PRI (μs)	Pulses per Hop	Hop Rate (kHz)	Hop Sequence Length(ms)	Center Frequency (MHz)	Detection (1: Yes; 0: No)
11ac80MIMO	5530	Type6	13	1	333.3	9	0.3333	300	5538	1
11ac80MIMO	5530	Type6	13	1	333.3	9	0.3333	300	5596	1
11ac80MIMO	5530	Type6	13	1	333.3	9	0.3333	300	5452	1
11ac80MIMO	5530	Type6	13	1	333.3	9	0.3333	300	5704	1
11ac80MIMO	5530	Type6	13	1	333.3	9	0.3333	300	5666	1
11ac80MIMO	5530	Type6	13	1	333.3	9	0.3333	300	5674	1
11ac80MIMO	5530	Type6	13	1	333.3	9	0.3333	300	5439	1
11ac80MIMO	5530	Type6	13	1	333.3	9	0.3333	300	5660	1
11ac80MIMO	5530	Type6	13	1	333.3	9	0.3333	300	5431	1
11ac80MIMO	5530	Type6	13	1	333.3	9	0.3333	300	5324	1
11ac80MIMO	5530	Type6	13	1	333.3	9	0.3333	300	5390	1
11ac80MIMO	5530	Type6	13	1	333.3	9	0.3333	300	5334	1
11ac80MIMO	5530	Type6	13	1	333.3	9	0.3333	300	5544	1
11ac80MIMO	5530	Type6	13	1	333.3	9	0.3333	300	5413	1
11ac80MIMO	5530	Type6	13	1	333.3	9	0.3333	300	5386	1
11ac80MIMO	5530	Type6	13	1	333.3	9	0.3333	300	5524	1
11ac80MIMO	5530	Type6	13	1	333.3	9	0.3333	300	5573	1
11ac80MIMO	5530	Type6	13	1	333.3	9	0.3333	300	5491	1
11ac80MIMO	5530	Type6	13	1	333.3	9	0.3333	300	5301	1
11ac80MIMO	5530	Type6	13	1	333.3	9	0.3333	300	5295	1
11ac80MIMO	5530	Type6	13	1	333.3	9	0.3333	300	5352	1
11ac80MIMO	5530	Type6	13	1	333.3	9	0.3333	300	5269	1
11ac80MIMO	5530	Type6	13	1	333.3	9	0.3333	300	5530	1
11ac80MIMO	5530	Type6	13	1	333.3	9	0.3333	300	5406	1
11ac80MIMO	5530	Type6	13	1	333.3	9	0.3333	300	5535	1
11ac80MIMO	5530	Type6	13	1	333.3	9	0.3333	300	5515	1
11ac80MIMO	5530	Type6	13	1	333.3	9	0.3333	300	5364	1
11ac80MIMO	5530	Type6	13	1	333.3	9	0.3333	300	5451	1
11ac80MIMO	5530	Type6	13	1	333.3	9	0.3333	300	5650	1
11ac80MIMO	5530	Type6	13	1	333.3	9	0.3333	300	5686	1
11ac80MIMO	5530	Type6	13	1	333.3	9	0.3333	300	5422	1
11ac80MIMO	5530	Type6	13	1	333.3	9	0.3333	300	5664	1
11ac80MIMO	5530	Type6	13	1	333.3	9	0.3333	300	5412	1
11ac80MIMO	5530	Type6	13	1	333.3	9	0.3333	300	5317	1
11ac80MIMO	5530	Type6	13	1	333.3	9	0.3333	300	5607	1
11ac80MIMO	5530	Type6	13	1	333.3	9	0.3333	300	5318	1
11ac80MIMO	5530	Type6	13	1	333.3	9	0.3333	300	5496	1
11ac80MIMO	5530	Type6	13	1	333.3	9	0.3333	300	5326	1
11ac80MIMO	5530	Type6	13	1	333.3	9	0.3333	300	5417	1
11ac80MIMO	5530	Type6	13	1	333.3	9	0.3333	300	5429	1
11ac80MIMO	5530	Type6	13	1	333.3	9	0.3333	300	5454	1
11ac80MIMO	5530	Type6	13	1	333.3	9	0.3333	300	5343	1
11ac80MIMO	5530	Type6	13	1	333.3	9	0.3333	300	5489	1
11ac80MIMO	5530	Type6	13	1	333.3	9	0.3333	300	5565	1
11ac80MIMO	5530	Type6	13	1	333.3	9	0.3333	300	5443	1
11ac80MIMO	5530	Type6	13	1	333.3	9	0.3333	300	5356	1
11ac80MIMO	5530	Type6	13	1	333.3	9	0.3333	300	5721	1
11ac80MIMO	5530	Type6	13	1	333.3	9	0.3333	300	5387	1
11ac80MIMO	5530	Type6	13	1	333.3	9	0.3333	300	5419	1



Unless otherwise agreed in writing, this document is issued by the Company subject to its General Conditions of Service printed overleaf, available on request or accessible at <http://www.sgs.com/en/Terms-and-Conditions.aspx> and, for electronic format documents, subject to Terms and Conditions for Electronic Documents at <http://www.sgs.com/en/Terms-and-Conditions/Terms-e-Documents.aspx>. Attention is drawn to the limitation of liability, indemnification and jurisdiction issues defined therein. Any holder of this document is advised that information contained herein reflects the Company's findings at the time of its intervention only and within the limits of Client's instructions, if any. The Company's sole responsibility is to its Client and this document does not exonerate parties to a transaction from exercising all their rights and obligations under the transaction documents. This document cannot be reproduced except in full, without prior written approval of the Company. Any unauthorized alteration, forgery or falsification of the content or appearance of this document is unlawful and offenders may be prosecuted to the fullest extent of the law. Unless otherwise stated the results shown in this test report refer only to the sample(s) tested and such sample(s) are retained for 30 days only.

Attention: To check the authenticity of testing/inspection report & certificate, please contact us at telephone: (86-755) 8307 1443, or email: [CN.Doccheck@sgs.com](mailto:CN.Doccheck@sgs.com)

SGS-CSTC Standards Technical Services (Xi'an) Co., Ltd. | 1/E Unit D, Building 1, Kanglong Orange Science Park, No.157, Keyuan3rd Road, Fengjing/Yue Town, Xi'an, Shaanxi, China | 710086 | t (86-29) 6282 7885 | www.sgs.com.cn  
 中国·西安·沣东新城科里三路157号康隆橙方科技园1号楼D单元1层 | 邮编: 710086 | t (86-29) 6282 7885 | sgs.china@sgs.com

11ac80MIMO	5530	Type6	13	1	333.3	9	0.3333	300	5656	1
11ac80MIMO	5530	Type6	13	1	333.3	9	0.3333	300	5298	1
11ac80MIMO	5530	Type6	13	1	333.3	9	0.3333	300	5475	1
11ac80MIMO	5530	Type6	13	1	333.3	9	0.3333	300	5283	1
11ac80MIMO	5530	Type6	13	1	333.3	9	0.3333	300	5281	1
11ac80MIMO	5530	Type6	13	1	333.3	9	0.3333	300	5519	1
11ac80MIMO	5530	Type6	13	1	333.3	9	0.3333	300	5393	1
11ac80MIMO	5530	Type6	13	1	333.3	9	0.3333	300	5498	1
11ac80MIMO	5530	Type6	13	1	333.3	9	0.3333	300	5657	1
11ac80MIMO	5530	Type6	13	1	333.3	9	0.3333	300	5713	1
11ac80MIMO	5530	Type6	13	1	333.3	9	0.3333	300	5260	1
11ac80MIMO	5530	Type6	13	1	333.3	9	0.3333	300	5470	1
11ac80MIMO	5530	Type6	13	1	333.3	9	0.3333	300	5724	1
11ac80MIMO	5530	Type6	13	1	333.3	9	0.3333	300	5647	1
11ac80MIMO	5530	Type6	13	1	333.3	9	0.3333	300	5477	1
11ac80MIMO	5530	Type6	13	1	333.3	9	0.3333	300	5531	1
11ac80MIMO	5530	Type6	13	1	333.3	9	0.3333	300	5278	1
11ac80MIMO	5530	Type6	13	1	333.3	9	0.3333	300	5594	1
11ac80MIMO	5530	Type6	13	1	333.3	9	0.3333	300	5597	1
11ac80MIMO	5530	Type6	13	1	333.3	9	0.3333	300	5663	1
11ac80MIMO	5530	Type6	13	1	333.3	9	0.3333	300	5259	1
11ac80MIMO	5530	Type6	13	1	333.3	9	0.3333	300	5505	1
11ac80MIMO	5530	Type6	13	1	333.3	9	0.3333	300	5690	1
11ac80MIMO	5530	Type6	13	1	333.3	9	0.3333	300	5688	1
11ac80MIMO	5530	Type6	13	1	333.3	9	0.3333	300	5526	1
11ac80MIMO	5530	Type6	13	1	333.3	9	0.3333	300	5282	1
11ac80MIMO	5530	Type6	13	1	333.3	9	0.3333	300	5719	1
11ac80MIMO	5530	Type6	13	1	333.3	9	0.3333	300	5638	1
11ac80MIMO	5530	Type6	13	1	333.3	9	0.3333	300	5672	1
11ac80MIMO	5530	Type6	13	1	333.3	9	0.3333	300	5253	1
11ac80MIMO	5530	Type6	13	1	333.3	9	0.3333	300	5478	1
11ac80MIMO	5530	Type6	13	1	333.3	9	0.3333	300	5338	1
11ac80MIMO	5530	Type6	13	1	333.3	9	0.3333	300	5630	1
11ac80MIMO	5530	Type6	13	1	333.3	9	0.3333	300	5450	1
11ac80MIMO	5530	Type6	13	1	333.3	9	0.3333	300	5632	1
11ac80MIMO	5530	Type6	13	1	333.3	9	0.3333	300	5266	1
11ac80MIMO	5530	Type6	13	1	333.3	9	0.3333	300	5497	1
11ac80MIMO	5530	Type6	13	1	333.3	9	0.3333	300	5466	1
11ac80MIMO	5530	Type6	13	1	333.3	9	0.3333	300	5333	1
11ac80MIMO	5530	Type6	13	1	333.3	9	0.3333	300	5366	1
11ac80MIMO	5530	Type6	13	1	333.3	9	0.3333	300	5339	1
11ac80MIMO	5530	Type6	13	1	333.3	9	0.3333	300	5434	1
11ac80MIMO	5530	Type6	13	1	333.3	9	0.3333	300	5591	1
11ac80MIMO	5530	Type6	13	1	333.3	9	0.3333	300	5581	1
11ac80MIMO	5530	Type6	13	1	333.3	9	0.3333	300	5351	1
11ac80MIMO	5530	Type6	13	1	333.3	9	0.3333	300	5250	1
11ac80MIMO	5530	Type6	13	1	333.3	9	0.3333	300	5411	1
11ac80MIMO	5530	Type6	13	1	333.3	9	0.3333	300	5442	1
11ac80MIMO	5530	Type6	13	1	333.3	9	0.3333	300	5264	1
11ac80MIMO	5530	Type6	13	1	333.3	9	0.3333	300	5545	1
11ac80MIMO	5530	Type6	13	1	333.3	9	0.3333	300	5527	1
11ac40MIMO	5510	Type6	13	1	333.3	9	0.3333	300	5538	1
11ac40MIMO	5510	Type6	13	1	333.3	9	0.3333	300	5596	1



Unless otherwise agreed in writing, this document is issued by the Company subject to its General Conditions of Service printed overleaf, available on request or accessible at <http://www.sgs.com/en/Terms-and-Conditions.aspx> and, for electronic format documents, subject to Terms and Conditions for Electronic Documents at <http://www.sgs.com/en/Terms-and-Conditions/Terms-e-Documents.aspx>. Attention is drawn to the limitation of liability, indemnification and jurisdiction issues defined therein. Any holder of this document is advised that information contained herein reflects the Company's findings at the time of its intervention only and within the limits of Client's instructions, if any. The Company's sole responsibility is to its Client and this document does not exonerate parties to a transaction from exercising all their rights and obligations under the transaction documents. This document cannot be reproduced except in full, without prior written approval of the Company. Any unauthorized alteration, forgery or falsification of the content or appearance of this document is unlawful and offenders may be prosecuted to the fullest extent of the law. Unless otherwise stated the results shown in this test report refer only to the sample(s) tested and such sample(s) are retained for 30 days only.

Attention: To check the authenticity of testing/inspection report & certificate, please contact us at telephone: (86-755) 8307 1443, or email: [CN.Doccheck@sgs.com](mailto:CN.Doccheck@sgs.com)  
 (E) Unit D, Building 1, Kanglong Orange Science Park, No.157, Keyuan 3rd Road, Fengyang New Town, Xian, Shaanxi, China 710086  
 t (86-29) 6282 7885 www.sgs.com.cn  
 中国·西安·沣东新城科里三路157号康隆橙方科技园1号楼D单元1层 邮编: 710086 t (86-29) 6282 7885 sgs.china@sgs.com



11ac40MIMO	5510	Type6	13	1	333.3	9	0.3333	300	5452	1
11ac40MIMO	5510	Type6	13	1	333.3	9	0.3333	300	5704	1
11ac40MIMO	5510	Type6	13	1	333.3	9	0.3333	300	5666	1
11ac40MIMO	5510	Type6	13	1	333.3	9	0.3333	300	5674	1
11ac40MIMO	5510	Type6	13	1	333.3	9	0.3333	300	5439	1
11ac40MIMO	5510	Type6	13	1	333.3	9	0.3333	300	5660	1
11ac40MIMO	5510	Type6	13	1	333.3	9	0.3333	300	5431	1
11ac40MIMO	5510	Type6	13	1	333.3	9	0.3333	300	5324	1
11ac40MIMO	5510	Type6	13	1	333.3	9	0.3333	300	5390	1
11ac40MIMO	5510	Type6	13	1	333.3	9	0.3333	300	5334	1
11ac40MIMO	5510	Type6	13	1	333.3	9	0.3333	300	5544	1
11ac40MIMO	5510	Type6	13	1	333.3	9	0.3333	300	5413	1
11ac40MIMO	5510	Type6	13	1	333.3	9	0.3333	300	5386	1
11ac40MIMO	5510	Type6	13	1	333.3	9	0.3333	300	5524	1
11ac40MIMO	5510	Type6	13	1	333.3	9	0.3333	300	5573	1
11ac40MIMO	5510	Type6	13	1	333.3	9	0.3333	300	5491	1
11ac40MIMO	5510	Type6	13	1	333.3	9	0.3333	300	5301	1
11ac40MIMO	5510	Type6	13	1	333.3	9	0.3333	300	5295	1
11ac40MIMO	5510	Type6	13	1	333.3	9	0.3333	300	5352	1
11ac40MIMO	5510	Type6	13	1	333.3	9	0.3333	300	5269	1
11ac40MIMO	5510	Type6	13	1	333.3	9	0.3333	300	5530	1
11ac40MIMO	5510	Type6	13	1	333.3	9	0.3333	300	5406	1
11ac40MIMO	5510	Type6	13	1	333.3	9	0.3333	300	5535	1
11ac40MIMO	5510	Type6	13	1	333.3	9	0.3333	300	5515	1
11ac40MIMO	5510	Type6	13	1	333.3	9	0.3333	300	5364	1
11ac40MIMO	5510	Type6	13	1	333.3	9	0.3333	300	5451	1
11ac40MIMO	5510	Type6	13	1	333.3	9	0.3333	300	5650	1
11ac40MIMO	5510	Type6	13	1	333.3	9	0.3333	300	5686	1
11ac40MIMO	5510	Type6	13	1	333.3	9	0.3333	300	5422	1
11ac40MIMO	5510	Type6	13	1	333.3	9	0.3333	300	5664	1
11ac40MIMO	5510	Type6	13	1	333.3	9	0.3333	300	5412	1
11ac40MIMO	5510	Type6	13	1	333.3	9	0.3333	300	5317	1
11ac40MIMO	5510	Type6	13	1	333.3	9	0.3333	300	5607	1
11ac40MIMO	5510	Type6	13	1	333.3	9	0.3333	300	5318	1
11ac40MIMO	5510	Type6	13	1	333.3	9	0.3333	300	5496	1
11ac40MIMO	5510	Type6	13	1	333.3	9	0.3333	300	5326	1
11ac40MIMO	5510	Type6	13	1	333.3	9	0.3333	300	5417	1
11ac40MIMO	5510	Type6	13	1	333.3	9	0.3333	300	5429	1
11ac40MIMO	5510	Type6	13	1	333.3	9	0.3333	300	5454	1
11ac40MIMO	5510	Type6	13	1	333.3	9	0.3333	300	5343	1
11ac40MIMO	5510	Type6	13	1	333.3	9	0.3333	300	5489	1
11ac40MIMO	5510	Type6	13	1	333.3	9	0.3333	300	5565	1
11ac40MIMO	5510	Type6	13	1	333.3	9	0.3333	300	5443	1
11ac40MIMO	5510	Type6	13	1	333.3	9	0.3333	300	5356	1
11ac40MIMO	5510	Type6	13	1	333.3	9	0.3333	300	5721	1
11ac40MIMO	5510	Type6	13	1	333.3	9	0.3333	300	5387	1
11ac40MIMO	5510	Type6	13	1	333.3	9	0.3333	300	5419	1
11ac40MIMO	5510	Type6	13	1	333.3	9	0.3333	300	5656	1
11ac40MIMO	5510	Type6	13	1	333.3	9	0.3333	300	5298	1
11ac40MIMO	5510	Type6	13	1	333.3	9	0.3333	300	5475	1
11ac40MIMO	5510	Type6	13	1	333.3	9	0.3333	300	5283	1
11ac40MIMO	5510	Type6	13	1	333.3	9	0.3333	300	5281	1
11ac40MIMO	5510	Type6	13	1	333.3	9	0.3333	300	5519	1



Unless otherwise agreed in writing, this document is issued by the Company subject to its General Conditions of Service printed overleaf, available on request or accessible at <http://www.sgs.com/en/Terms-and-Conditions.aspx> and, for electronic format documents, subject to Terms and Conditions for Electronic Documents at <http://www.sgs.com/en/Terms-and-Conditions/Terms-e-Documents.aspx>. Attention is drawn to the limitation of liability, indemnification and jurisdiction issues defined therein. Any holder of this document is advised that information contained herein reflects the Company's findings at the time of its intervention only and within the limits of Client's instructions, if any. The Company's sole responsibility is to its Client and this document does not exonerate parties to a transaction from exercising all their rights and obligations under the transaction documents. This document cannot be reproduced except in full, without prior written approval of the Company. Any unauthorized alteration, forgery or falsification of the content or appearance of this document is unlawful and offenders may be prosecuted to the fullest extent of the law. Unless otherwise stated the results shown in this test report refer only to the sample(s) tested and such sample(s) are retained for 30 days only.

Attention: To check the authenticity of testing/inspection report & certificate, please contact us at telephone: (86-755) 8307 1443, or email: [CN.Doccheck@sgs.com](mailto:CN.Doccheck@sgs.com)  
 (E) Unit D, Building 1, Kanglong Orange Science Park, No.157, Keyuan 3rd Road, Fengyang New Town, Xi'an, Shaanxi, China 710086  
 t (86-29) 6282 7885 www.sgs.com.cn  
 中国·西安·沣东新城科里三路157号康隆橙方科技园1号楼D单元1层 邮编: 710086 t (86-29) 6282 7885 sgs.china@sgs.com





11ac40MIMO	5510	Type6	13	1	333.3	9	0.3333	300	5393	1
11ac40MIMO	5510	Type6	13	1	333.3	9	0.3333	300	5498	1
11ac40MIMO	5510	Type6	13	1	333.3	9	0.3333	300	5657	1
11ac40MIMO	5510	Type6	13	1	333.3	9	0.3333	300	5713	1
11ac40MIMO	5510	Type6	13	1	333.3	9	0.3333	300	5260	1
11ac40MIMO	5510	Type6	13	1	333.3	9	0.3333	300	5470	1
11ac40MIMO	5510	Type6	13	1	333.3	9	0.3333	300	5724	1
11ac40MIMO	5510	Type6	13	1	333.3	9	0.3333	300	5647	1
11ac40MIMO	5510	Type6	13	1	333.3	9	0.3333	300	5477	1
11ac40MIMO	5510	Type6	13	1	333.3	9	0.3333	300	5531	1
11ac40MIMO	5510	Type6	13	1	333.3	9	0.3333	300	5278	1
11ac40MIMO	5510	Type6	13	1	333.3	9	0.3333	300	5594	1
11ac40MIMO	5510	Type6	13	1	333.3	9	0.3333	300	5597	1
11ac40MIMO	5510	Type6	13	1	333.3	9	0.3333	300	5663	1
11ac40MIMO	5510	Type6	13	1	333.3	9	0.3333	300	5259	1
11ac40MIMO	5510	Type6	13	1	333.3	9	0.3333	300	5505	1
11ac40MIMO	5510	Type6	13	1	333.3	9	0.3333	300	5690	1
11ac40MIMO	5510	Type6	13	1	333.3	9	0.3333	300	5688	1
11ac40MIMO	5510	Type6	13	1	333.3	9	0.3333	300	5526	1
11ac40MIMO	5510	Type6	13	1	333.3	9	0.3333	300	5282	1
11ac40MIMO	5510	Type6	13	1	333.3	9	0.3333	300	5719	1
11ac40MIMO	5510	Type6	13	1	333.3	9	0.3333	300	5638	1
11ac40MIMO	5510	Type6	13	1	333.3	9	0.3333	300	5672	1
11ac40MIMO	5510	Type6	13	1	333.3	9	0.3333	300	5253	1
11ac40MIMO	5510	Type6	13	1	333.3	9	0.3333	300	5478	1
11ac40MIMO	5510	Type6	13	1	333.3	9	0.3333	300	5338	1
11ac40MIMO	5510	Type6	13	1	333.3	9	0.3333	300	5630	1
11ac40MIMO	5510	Type6	13	1	333.3	9	0.3333	300	5450	1
11ac40MIMO	5510	Type6	13	1	333.3	9	0.3333	300	5632	1
11ac40MIMO	5510	Type6	13	1	333.3	9	0.3333	300	5266	1
11ac40MIMO	5510	Type6	13	1	333.3	9	0.3333	300	5497	1
11ac40MIMO	5510	Type6	13	1	333.3	9	0.3333	300	5466	1
11ac40MIMO	5510	Type6	13	1	333.3	9	0.3333	300	5333	1
11ac40MIMO	5510	Type6	13	1	333.3	9	0.3333	300	5366	1
11ac40MIMO	5510	Type6	13	1	333.3	9	0.3333	300	5339	1
11ac40MIMO	5510	Type6	13	1	333.3	9	0.3333	300	5434	1
11ac40MIMO	5510	Type6	13	1	333.3	9	0.3333	300	5591	1
11ac40MIMO	5510	Type6	13	1	333.3	9	0.3333	300	5581	1
11ac40MIMO	5510	Type6	13	1	333.3	9	0.3333	300	5351	1
11ac40MIMO	5510	Type6	13	1	333.3	9	0.3333	300	5250	1
11ac40MIMO	5510	Type6	13	1	333.3	9	0.3333	300	5411	1
11ac40MIMO	5510	Type6	13	1	333.3	9	0.3333	300	5442	1
11ac40MIMO	5510	Type6	13	1	333.3	9	0.3333	300	5264	1
11ac40MIMO	5510	Type6	13	1	333.3	9	0.3333	300	5545	1
11ac40MIMO	5510	Type6	13	1	333.3	9	0.3333	300	5527	1
11ac20MIMO	5500	Type6	13	1	333.3	9	0.3333	300	5538	1
11ac20MIMO	5500	Type6	13	1	333.3	9	0.3333	300	5596	1
11ac20MIMO	5500	Type6	13	1	333.3	9	0.3333	300	5452	1
11ac20MIMO	5500	Type6	13	1	333.3	9	0.3333	300	5704	1
11ac20MIMO	5500	Type6	13	1	333.3	9	0.3333	300	5666	1
11ac20MIMO	5500	Type6	13	1	333.3	9	0.3333	300	5674	1
11ac20MIMO	5500	Type6	13	1	333.3	9	0.3333	300	5439	1
11ac20MIMO	5500	Type6	13	1	333.3	9	0.3333	300	5660	1



Unless otherwise agreed in writing, this document is issued by the Company subject to its General Conditions of Service printed overleaf, available on request or accessible at <http://www.sgs.com/en/Terms-and-Conditions.aspx> and, for electronic format documents, subject to Terms and Conditions for Electronic Documents at <http://www.sgs.com/en/Terms-and-Conditions/Terms-e-Document.aspx>. Attention is drawn to the limitation of liability, indemnification and jurisdiction issues defined therein. Any holder of this document is advised that information contained herein reflects the Company's findings at the time of its intervention only and within the limits of Client's instructions, if any. The Company's sole responsibility is to its Client and this document does not exonerate parties to a transaction from exercising all their rights and obligations under the transaction documents. This document cannot be reproduced except in full, without prior written approval of the Company. Any unauthorized alteration, forgery or falsification of the content or appearance of this document is unlawful and offenders may be prosecuted to the fullest extent of the law. Unless otherwise stated the results shown in this test report refer only to the sample(s) tested and such sample(s) are retained for 30 days only.

Attention: To check the authenticity of testing/inspection report & certificate, please contact us at telephone: (86-755) 8307 1443, or email: [CN.Doccheck@sgs.com](mailto:CN.Doccheck@sgs.com)  
 (E) Unit D, Building 1, Kanglong Orange Science Park, No.157, Keyuan 3rd Road, Fengyang New Town, Xi'an, Shaanxi, China 710086  
 t (86-29) 6282 7885 www.sgs.com.cn  
 中国·西安·沣东新城科里三路157号康隆橙方科技园1号楼D单元1层 邮编: 710086 t (86-29) 6282 7885 sgs.china@sgs.com

11ac20MIMO	5500	Type6	13	1	333.3	9	0.3333	300	5431	1
11ac20MIMO	5500	Type6	13	1	333.3	9	0.3333	300	5324	1
11ac20MIMO	5500	Type6	13	1	333.3	9	0.3333	300	5390	1
11ac20MIMO	5500	Type6	13	1	333.3	9	0.3333	300	5334	1
11ac20MIMO	5500	Type6	13	1	333.3	9	0.3333	300	5544	1
11ac20MIMO	5500	Type6	13	1	333.3	9	0.3333	300	5413	1
11ac20MIMO	5500	Type6	13	1	333.3	9	0.3333	300	5386	1
11ac20MIMO	5500	Type6	13	1	333.3	9	0.3333	300	5524	1
11ac20MIMO	5500	Type6	13	1	333.3	9	0.3333	300	5573	1
11ac20MIMO	5500	Type6	13	1	333.3	9	0.3333	300	5491	1
11ac20MIMO	5500	Type6	13	1	333.3	9	0.3333	300	5301	1
11ac20MIMO	5500	Type6	13	1	333.3	9	0.3333	300	5295	1
11ac20MIMO	5500	Type6	13	1	333.3	9	0.3333	300	5352	1
11ac20MIMO	5500	Type6	13	1	333.3	9	0.3333	300	5269	1
11ac20MIMO	5500	Type6	13	1	333.3	9	0.3333	300	5530	1
11ac20MIMO	5500	Type6	13	1	333.3	9	0.3333	300	5406	1
11ac20MIMO	5500	Type6	13	1	333.3	9	0.3333	300	5535	1
11ac20MIMO	5500	Type6	13	1	333.3	9	0.3333	300	5515	1
11ac20MIMO	5500	Type6	13	1	333.3	9	0.3333	300	5364	1
11ac20MIMO	5500	Type6	13	1	333.3	9	0.3333	300	5451	1
11ac20MIMO	5500	Type6	13	1	333.3	9	0.3333	300	5650	1
11ac20MIMO	5500	Type6	13	1	333.3	9	0.3333	300	5686	1
11ac20MIMO	5500	Type6	13	1	333.3	9	0.3333	300	5422	1
11ac20MIMO	5500	Type6	13	1	333.3	9	0.3333	300	5664	1
11ac20MIMO	5500	Type6	13	1	333.3	9	0.3333	300	5412	1
11ac20MIMO	5500	Type6	13	1	333.3	9	0.3333	300	5317	1
11ac20MIMO	5500	Type6	13	1	333.3	9	0.3333	300	5607	1
11ac20MIMO	5500	Type6	13	1	333.3	9	0.3333	300	5318	1
11ac20MIMO	5500	Type6	13	1	333.3	9	0.3333	300	5496	1
11ac20MIMO	5500	Type6	13	1	333.3	9	0.3333	300	5326	1
11ac20MIMO	5500	Type6	13	1	333.3	9	0.3333	300	5417	1
11ac20MIMO	5500	Type6	13	1	333.3	9	0.3333	300	5429	1
11ac20MIMO	5500	Type6	13	1	333.3	9	0.3333	300	5454	1
11ac20MIMO	5500	Type6	13	1	333.3	9	0.3333	300	5343	1
11ac20MIMO	5500	Type6	13	1	333.3	9	0.3333	300	5489	1
11ac20MIMO	5500	Type6	13	1	333.3	9	0.3333	300	5565	1
11ac20MIMO	5500	Type6	13	1	333.3	9	0.3333	300	5443	1
11ac20MIMO	5500	Type6	13	1	333.3	9	0.3333	300	5356	1
11ac20MIMO	5500	Type6	13	1	333.3	9	0.3333	300	5721	1
11ac20MIMO	5500	Type6	13	1	333.3	9	0.3333	300	5387	1
11ac20MIMO	5500	Type6	13	1	333.3	9	0.3333	300	5419	1
11ac20MIMO	5500	Type6	13	1	333.3	9	0.3333	300	5656	1
11ac20MIMO	5500	Type6	13	1	333.3	9	0.3333	300	5298	1
11ac20MIMO	5500	Type6	13	1	333.3	9	0.3333	300	5475	1
11ac20MIMO	5500	Type6	13	1	333.3	9	0.3333	300	5283	1
11ac20MIMO	5500	Type6	13	1	333.3	9	0.3333	300	5281	1
11ac20MIMO	5500	Type6	13	1	333.3	9	0.3333	300	5519	1
11ac20MIMO	5500	Type6	13	1	333.3	9	0.3333	300	5393	1
11ac20MIMO	5500	Type6	13	1	333.3	9	0.3333	300	5498	1
11ac20MIMO	5500	Type6	13	1	333.3	9	0.3333	300	5657	1
11ac20MIMO	5500	Type6	13	1	333.3	9	0.3333	300	5713	1
11ac20MIMO	5500	Type6	13	1	333.3	9	0.3333	300	5260	1
11ac20MIMO	5500	Type6	13	1	333.3	9	0.3333	300	5470	1



Unless otherwise agreed in writing, this document is issued by the Company subject to its General Conditions of Service printed overleaf, available on request or accessible at <http://www.sgs.com/en/Terms-and-Conditions.aspx> and, for electronic format documents, subject to Terms and Conditions for Electronic Documents at <http://www.sgs.com/en/Terms-and-Conditions/Terms-e-Documents.aspx>. Attention is drawn to the limitation of liability, indemnification and jurisdiction issues defined therein. Any holder of this document is advised that information contained herein reflects the Company's findings at the time of its intervention only and within the limits of Client's instructions, if any. The Company's sole responsibility is to its Client and this document does not exonerate parties to a transaction from exercising all their rights and obligations under the transaction documents. This document cannot be reproduced except in full, without prior written approval of the Company. Any unauthorized alteration, forgery or falsification of the content or appearance of this document is unlawful and offenders may be prosecuted to the fullest extent of the law. Unless otherwise stated the results shown in this test report refer only to the sample(s) tested and such sample(s) are retained for 30 days only.

Attention: To check the authenticity of testing/inspection report & certificate, please contact us at telephone: (86-755) 8307 1443, or email: [CN.Doccheck@sgs.com](mailto:CN.Doccheck@sgs.com)  
 (U) Ltd D Building 1, Kanglong Orange Science Park, No.157, Keyuan 3rd Road, Fengyang New Town, Xi'an, Shaanxi, China 710086  
 t (86-29) 6282 7885 www.sgs.com.cn  
 中国·西安·沣东新城科里三路157号康鸿橙方科技园1号楼D单元1层 邮编: 710086 t (86-29) 6282 7885 sgs.china@sgs.com

Report No.: XEWA2310000070RG05

Rev.: 01

Page: 171 of 267

11ac20MIMO	5500	Type6	13	1	333.3	9	0.3333	300	5724	1
11ac20MIMO	5500	Type6	13	1	333.3	9	0.3333	300	5647	1
11ac20MIMO	5500	Type6	13	1	333.3	9	0.3333	300	5477	1
11ac20MIMO	5500	Type6	13	1	333.3	9	0.3333	300	5531	1
11ac20MIMO	5500	Type6	13	1	333.3	9	0.3333	300	5278	1
11ac20MIMO	5500	Type6	13	1	333.3	9	0.3333	300	5594	1
11ac20MIMO	5500	Type6	13	1	333.3	9	0.3333	300	5597	1
11ac20MIMO	5500	Type6	13	1	333.3	9	0.3333	300	5663	1
11ac20MIMO	5500	Type6	13	1	333.3	9	0.3333	300	5259	1
11ac20MIMO	5500	Type6	13	1	333.3	9	0.3333	300	5505	1
11ac20MIMO	5500	Type6	13	1	333.3	9	0.3333	300	5690	1
11ac20MIMO	5500	Type6	13	1	333.3	9	0.3333	300	5688	1
11ac20MIMO	5500	Type6	13	1	333.3	9	0.3333	300	5526	1
11ac20MIMO	5500	Type6	13	1	333.3	9	0.3333	300	5282	1
11ac20MIMO	5500	Type6	13	1	333.3	9	0.3333	300	5719	1
11ac20MIMO	5500	Type6	13	1	333.3	9	0.3333	300	5638	1
11ac20MIMO	5500	Type6	13	1	333.3	9	0.3333	300	5672	1
11ac20MIMO	5500	Type6	13	1	333.3	9	0.3333	300	5253	1
11ac20MIMO	5500	Type6	13	1	333.3	9	0.3333	300	5478	1
11ac20MIMO	5500	Type6	13	1	333.3	9	0.3333	300	5338	1
11ac20MIMO	5500	Type6	13	1	333.3	9	0.3333	300	5630	1
11ac20MIMO	5500	Type6	13	1	333.3	9	0.3333	300	5450	1
11ac20MIMO	5500	Type6	13	1	333.3	9	0.3333	300	5632	1
11ac20MIMO	5500	Type6	13	1	333.3	9	0.3333	300	5266	1
11ac20MIMO	5500	Type6	13	1	333.3	9	0.3333	300	5497	1
11ac20MIMO	5500	Type6	13	1	333.3	9	0.3333	300	5466	1
11ac20MIMO	5500	Type6	13	1	333.3	9	0.3333	300	5333	1
11ac20MIMO	5500	Type6	13	1	333.3	9	0.3333	300	5366	1
11ac20MIMO	5500	Type6	13	1	333.3	9	0.3333	300	5339	1
11ac20MIMO	5500	Type6	13	1	333.3	9	0.3333	300	5434	1
11ac20MIMO	5500	Type6	13	1	333.3	9	0.3333	300	5591	1
11ac20MIMO	5500	Type6	13	1	333.3	9	0.3333	300	5581	1
11ac20MIMO	5500	Type6	13	1	333.3	9	0.3333	300	5351	1
11ac20MIMO	5500	Type6	13	1	333.3	9	0.3333	300	5250	1
11ac20MIMO	5500	Type6	13	1	333.3	9	0.3333	300	5411	1
11ac20MIMO	5500	Type6	13	1	333.3	9	0.3333	300	5442	1
11ac20MIMO	5500	Type6	13	1	333.3	9	0.3333	300	5264	1
11ac20MIMO	5500	Type6	13	1	333.3	9	0.3333	300	5545	1
11ac20MIMO	5500	Type6	13	1	333.3	9	0.3333	300	5527	1



Unless otherwise agreed in writing, this document is issued by the Company subject to its General Conditions of Service printed overleaf, available on request or accessible at <http://www.sgs.com/en/Terms-and-Conditions.aspx> and, for electronic format documents, subject to Terms and Conditions for Electronic Documents at <http://www.sgs.com/en/Terms-and-Conditions/Terms-e-Documents.aspx>. Attention is drawn to the limitation of liability, indemnification and jurisdiction issues defined therein. Any holder of this document is advised that information contained herein reflects the Company's findings at the time of its intervention only and within the limits of Client's instructions, if any. The Company's sole responsibility is to its Client and this document does not exonerate parties to a transaction from exercising all their rights and obligations under the transaction documents. This document cannot be reproduced except in full, without prior written approval of the Company. Any unauthorized alteration, forgery or falsification of the content or appearance of this document is unlawful and offenders may be prosecuted to the fullest extent of the law. Unless otherwise stated the results shown in this test report refer only to the sample(s) tested and such sample(s) are retained for 30 days only.

Attention: To check the authenticity of testing/inspection report & certificate, please contact us at telephone: (86-755) 4307 1443, or email: [CN.Doccheck@sgs.com](mailto:CN.Doccheck@sgs.com)  
 (SGS-CSTC) Standards Technical Services (Xi'an) Co., Ltd. | 1/E Unit D, Building 1, Kanghong Orange Source Park, No.137, Kejian 3rd Road, Fengling New Town, Xi'an, Shaanxi, China | 710086 | t: (86-29) 6282 7885 | www.sgs.com.cn  
 中国·西安·沣东新城科里三路137号康鸿橙方科技园1号楼D单元1层 | 邮编: 710086 | t: (86-29) 6282 7885 | sgs.china@sgs.com

TestMode	Channel	Radar Type	Trial ID	Pulse width (μs)	PRI (μs)	Pulses per Hop	Hop Rate (kHz)	Hop Sequence Length(ms)	Center Frequency (MHz)	Detection (1: Yes; 0: No)
11ac80MIMO	5530	Type6	14	1	333.3	9	0.3333	300	5318	1
11ac80MIMO	5530	Type6	14	1	333.3	9	0.3333	300	5360	1
11ac80MIMO	5530	Type6	14	1	333.3	9	0.3333	300	5388	1
11ac80MIMO	5530	Type6	14	1	333.3	9	0.3333	300	5390	1
11ac80MIMO	5530	Type6	14	1	333.3	9	0.3333	300	5508	1
11ac80MIMO	5530	Type6	14	1	333.3	9	0.3333	300	5338	1
11ac80MIMO	5530	Type6	14	1	333.3	9	0.3333	300	5364	1
11ac80MIMO	5530	Type6	14	1	333.3	9	0.3333	300	5260	1
11ac80MIMO	5530	Type6	14	1	333.3	9	0.3333	300	5594	1
11ac80MIMO	5530	Type6	14	1	333.3	9	0.3333	300	5628	1
11ac80MIMO	5530	Type6	14	1	333.3	9	0.3333	300	5321	1
11ac80MIMO	5530	Type6	14	1	333.3	9	0.3333	300	5598	1
11ac80MIMO	5530	Type6	14	1	333.3	9	0.3333	300	5585	1
11ac80MIMO	5530	Type6	14	1	333.3	9	0.3333	300	5511	1
11ac80MIMO	5530	Type6	14	1	333.3	9	0.3333	300	5407	1
11ac80MIMO	5530	Type6	14	1	333.3	9	0.3333	300	5612	1
11ac80MIMO	5530	Type6	14	1	333.3	9	0.3333	300	5700	1
11ac80MIMO	5530	Type6	14	1	333.3	9	0.3333	300	5497	1
11ac80MIMO	5530	Type6	14	1	333.3	9	0.3333	300	5724	1
11ac80MIMO	5530	Type6	14	1	333.3	9	0.3333	300	5487	1
11ac80MIMO	5530	Type6	14	1	333.3	9	0.3333	300	5263	1
11ac80MIMO	5530	Type6	14	1	333.3	9	0.3333	300	5435	1
11ac80MIMO	5530	Type6	14	1	333.3	9	0.3333	300	5471	1
11ac80MIMO	5530	Type6	14	1	333.3	9	0.3333	300	5398	1
11ac80MIMO	5530	Type6	14	1	333.3	9	0.3333	300	5306	1
11ac80MIMO	5530	Type6	14	1	333.3	9	0.3333	300	5691	1
11ac80MIMO	5530	Type6	14	1	333.3	9	0.3333	300	5654	1
11ac80MIMO	5530	Type6	14	1	333.3	9	0.3333	300	5279	1
11ac80MIMO	5530	Type6	14	1	333.3	9	0.3333	300	5720	1
11ac80MIMO	5530	Type6	14	1	333.3	9	0.3333	300	5464	1
11ac80MIMO	5530	Type6	14	1	333.3	9	0.3333	300	5650	1
11ac80MIMO	5530	Type6	14	1	333.3	9	0.3333	300	5369	1
11ac80MIMO	5530	Type6	14	1	333.3	9	0.3333	300	5532	1
11ac80MIMO	5530	Type6	14	1	333.3	9	0.3333	300	5284	1
11ac80MIMO	5530	Type6	14	1	333.3	9	0.3333	300	5516	1
11ac80MIMO	5530	Type6	14	1	333.3	9	0.3333	300	5635	1
11ac80MIMO	5530	Type6	14	1	333.3	9	0.3333	300	5417	1
11ac80MIMO	5530	Type6	14	1	333.3	9	0.3333	300	5310	1
11ac80MIMO	5530	Type6	14	1	333.3	9	0.3333	300	5582	1
11ac80MIMO	5530	Type6	14	1	333.3	9	0.3333	300	5368	1
11ac80MIMO	5530	Type6	14	1	333.3	9	0.3333	300	5657	1
11ac80MIMO	5530	Type6	14	1	333.3	9	0.3333	300	5669	1
11ac80MIMO	5530	Type6	14	1	333.3	9	0.3333	300	5503	1
11ac80MIMO	5530	Type6	14	1	333.3	9	0.3333	300	5683	1
11ac80MIMO	5530	Type6	14	1	333.3	9	0.3333	300	5353	1
11ac80MIMO	5530	Type6	14	1	333.3	9	0.3333	300	5553	1
11ac80MIMO	5530	Type6	14	1	333.3	9	0.3333	300	5270	1
11ac80MIMO	5530	Type6	14	1	333.3	9	0.3333	300	5502	1
11ac80MIMO	5530	Type6	14	1	333.3	9	0.3333	300	5714	1



Unless otherwise agreed in writing, this document is issued by the Company subject to its General Conditions of Service printed overleaf, available on request or accessible at <http://www.sgs.com/en/Terms-and-Conditions.aspx> and, for electronic format documents, subject to Terms and Conditions for Electronic Documents at <http://www.sgs.com/en/Terms-and-Conditions/Terms-e-Document.aspx>. Attention is drawn to the limitation of liability, indemnification and jurisdiction issues defined therein. Any holder of this document is advised that information contained herein reflects the Company's findings at the time of its intervention only and within the limits of Client's instructions, if any. The Company's sole responsibility is to its Client and this document does not exonerate parties to a transaction from exercising all their rights and obligations under the transaction documents. This document cannot be reproduced except in full, without prior written approval of the Company. Any unauthorized alteration, forgery or falsification of the content or appearance of this document is unlawful and offenders may be prosecuted to the fullest extent of the law. Unless otherwise stated the results shown in this test report refer only to the sample(s) tested and such sample(s) are retained for 30 days only.

Attention: To check the authenticity of testing/inspection report & certificate, please contact us at telephone: (86-755) 8307 1443, or email: [CN\\_Doccheck@sgs.com](mailto:CN_Doccheck@sgs.com)

SGS-CSTC Standards Technical Services (Xi'an) Co., Ltd. | 1/E Unit D, Building 1, Kanglong Orange Science Park, No.157, Keyuan 3rd Road, Fengjing/Yue Town, Xi'an, Shaanxi, China | 710086 | t (86-29) 6282 7885 | www.sgs.com.cn  
 中国·西安·沣东新城科里三路157号康隆橙方科技园1号楼D单元1层 | 邮编: 710086 | t (86-29) 6282 7885 | sgs.china@sgs.com



Table with 11 columns: Item ID, Value, Type, Dimensions, etc. Rows include 11ac80MIMO and 11ac40MIMO series.



Unless otherwise agreed in writing, this document is issued by the Company subject to its General Conditions of Service printed overleaf, available on request or accessible at http://www.sgs.com/en/Terms-and-Conditions.aspx and, for electronic format documents, subject to Terms and Conditions for Electronic Documents at http://www.sgs.com/en/Terms-and-Conditions/Terms-e-Documents.aspx. Attention is drawn to the limitation of liability, indemnification and jurisdiction issues defined therein. Any holder of this document is advised that information contained herein reflects the Company's findings at the time of its intervention only and within the limits of Client's instructions, if any. The Company's sole responsibility is to its Client and this document does not exonerate parties to a transaction from exercising all their rights and obligations under the transaction documents. This document cannot be reproduced except in full, without prior written approval of the Company. Any unauthorized alteration, forgery or falsification of the content or appearance of this document is unlawful and offenders may be prosecuted to the fullest extent of the law. Unless otherwise stated the results shown in this test report refer only to the sample(s) tested and such sample(s) are retained for 30 days only. Attention: To check the authenticity of testing/inspection report & certificate, please contact us at telephone: (86-755) 8307 1443, or email: CN.Doccheck@sgs.com

11ac40MIMO	5510	Type6	14	1	333.3	9	0.3333	300	5388	1
11ac40MIMO	5510	Type6	14	1	333.3	9	0.3333	300	5390	1
11ac40MIMO	5510	Type6	14	1	333.3	9	0.3333	300	5508	1
11ac40MIMO	5510	Type6	14	1	333.3	9	0.3333	300	5338	1
11ac40MIMO	5510	Type6	14	1	333.3	9	0.3333	300	5364	1
11ac40MIMO	5510	Type6	14	1	333.3	9	0.3333	300	5260	1
11ac40MIMO	5510	Type6	14	1	333.3	9	0.3333	300	5594	1
11ac40MIMO	5510	Type6	14	1	333.3	9	0.3333	300	5628	1
11ac40MIMO	5510	Type6	14	1	333.3	9	0.3333	300	5321	1
11ac40MIMO	5510	Type6	14	1	333.3	9	0.3333	300	5598	1
11ac40MIMO	5510	Type6	14	1	333.3	9	0.3333	300	5585	1
11ac40MIMO	5510	Type6	14	1	333.3	9	0.3333	300	5511	1
11ac40MIMO	5510	Type6	14	1	333.3	9	0.3333	300	5407	1
11ac40MIMO	5510	Type6	14	1	333.3	9	0.3333	300	5612	1
11ac40MIMO	5510	Type6	14	1	333.3	9	0.3333	300	5700	1
11ac40MIMO	5510	Type6	14	1	333.3	9	0.3333	300	5497	1
11ac40MIMO	5510	Type6	14	1	333.3	9	0.3333	300	5724	1
11ac40MIMO	5510	Type6	14	1	333.3	9	0.3333	300	5487	1
11ac40MIMO	5510	Type6	14	1	333.3	9	0.3333	300	5263	1
11ac40MIMO	5510	Type6	14	1	333.3	9	0.3333	300	5435	1
11ac40MIMO	5510	Type6	14	1	333.3	9	0.3333	300	5471	1
11ac40MIMO	5510	Type6	14	1	333.3	9	0.3333	300	5398	1
11ac40MIMO	5510	Type6	14	1	333.3	9	0.3333	300	5306	1
11ac40MIMO	5510	Type6	14	1	333.3	9	0.3333	300	5691	1
11ac40MIMO	5510	Type6	14	1	333.3	9	0.3333	300	5654	1
11ac40MIMO	5510	Type6	14	1	333.3	9	0.3333	300	5279	1
11ac40MIMO	5510	Type6	14	1	333.3	9	0.3333	300	5720	1
11ac40MIMO	5510	Type6	14	1	333.3	9	0.3333	300	5464	1
11ac40MIMO	5510	Type6	14	1	333.3	9	0.3333	300	5650	1
11ac40MIMO	5510	Type6	14	1	333.3	9	0.3333	300	5369	1
11ac40MIMO	5510	Type6	14	1	333.3	9	0.3333	300	5532	1
11ac40MIMO	5510	Type6	14	1	333.3	9	0.3333	300	5284	1
11ac40MIMO	5510	Type6	14	1	333.3	9	0.3333	300	5516	1
11ac40MIMO	5510	Type6	14	1	333.3	9	0.3333	300	5635	1
11ac40MIMO	5510	Type6	14	1	333.3	9	0.3333	300	5417	1
11ac40MIMO	5510	Type6	14	1	333.3	9	0.3333	300	5310	1
11ac40MIMO	5510	Type6	14	1	333.3	9	0.3333	300	5582	1
11ac40MIMO	5510	Type6	14	1	333.3	9	0.3333	300	5368	1
11ac40MIMO	5510	Type6	14	1	333.3	9	0.3333	300	5657	1
11ac40MIMO	5510	Type6	14	1	333.3	9	0.3333	300	5669	1
11ac40MIMO	5510	Type6	14	1	333.3	9	0.3333	300	5503	1
11ac40MIMO	5510	Type6	14	1	333.3	9	0.3333	300	5683	1
11ac40MIMO	5510	Type6	14	1	333.3	9	0.3333	300	5353	1
11ac40MIMO	5510	Type6	14	1	333.3	9	0.3333	300	5553	1
11ac40MIMO	5510	Type6	14	1	333.3	9	0.3333	300	5270	1
11ac40MIMO	5510	Type6	14	1	333.3	9	0.3333	300	5502	1
11ac40MIMO	5510	Type6	14	1	333.3	9	0.3333	300	5714	1
11ac40MIMO	5510	Type6	14	1	333.3	9	0.3333	300	5351	1
11ac40MIMO	5510	Type6	14	1	333.3	9	0.3333	300	5362	1
11ac40MIMO	5510	Type6	14	1	333.3	9	0.3333	300	5634	1
11ac40MIMO	5510	Type6	14	1	333.3	9	0.3333	300	5457	1
11ac40MIMO	5510	Type6	14	1	333.3	9	0.3333	300	5608	1
11ac40MIMO	5510	Type6	14	1	333.3	9	0.3333	300	5711	1



Unless otherwise agreed in writing, this document is issued by the Company subject to its General Conditions of Service printed overleaf, available on request or accessible at <http://www.sgs.com/en/Terms-and-Conditions.aspx> and, for electronic format documents, subject to Terms and Conditions for Electronic Documents at <http://www.sgs.com/en/Terms-and-Conditions/Terms-e-Documents.aspx>. Attention is drawn to the limitation of liability, indemnification and jurisdiction issues defined therein. Any holder of this document is advised that information contained herein reflects the Company's findings at the time of its intervention only and within the limits of Client's instructions, if any. The Company's sole responsibility is to its Client and this document does not exonerate parties to a transaction from exercising all their rights and obligations under the transaction documents. This document cannot be reproduced except in full, without prior written approval of the Company. Any unauthorized alteration, forgery or falsification of the content or appearance of this document is unlawful and offenders may be prosecuted to the fullest extent of the law. Unless otherwise stated the results shown in this test report refer only to the sample(s) tested and such sample(s) are retained for 30 days only.

Attention: To check the authenticity of testing/inspection report & certificate, please contact us at telephone: (86-755) 8307 1443, or email: [CN.Doccheck@sgs.com](mailto:CN.Doccheck@sgs.com)

SGS-CSTC Standards Technical Services (Xi'an) Co., Ltd. | 1/F Unit D, Building 1, Kanglong Orange Science Park, No.137, Keyuan 3rd Road, Fengjing/Yue Town, Xian, Shaanxi, China | 710086 | t (86-29) 6282 7885 | www.sgs.com.cn  
 中国·西安·沣东新城科里三路137号康鸿橙方科技园1号楼D单元1层 | 邮编: 710086 | t (86-29) 6282 7885 | sgs.china@sgs.com

11ac40MIMO	5510	Type6	14	1	333.3	9	0.3333	300	5337	1
11ac40MIMO	5510	Type6	14	1	333.3	9	0.3333	300	5607	1
11ac40MIMO	5510	Type6	14	1	333.3	9	0.3333	300	5452	1
11ac40MIMO	5510	Type6	14	1	333.3	9	0.3333	300	5372	1
11ac40MIMO	5510	Type6	14	1	333.3	9	0.3333	300	5706	1
11ac40MIMO	5510	Type6	14	1	333.3	9	0.3333	300	5599	1
11ac40MIMO	5510	Type6	14	1	333.3	9	0.3333	300	5414	1
11ac40MIMO	5510	Type6	14	1	333.3	9	0.3333	300	5396	1
11ac40MIMO	5510	Type6	14	1	333.3	9	0.3333	300	5576	1
11ac40MIMO	5510	Type6	14	1	333.3	9	0.3333	300	5303	1
11ac40MIMO	5510	Type6	14	1	333.3	9	0.3333	300	5574	1
11ac40MIMO	5510	Type6	14	1	333.3	9	0.3333	300	5616	1
11ac40MIMO	5510	Type6	14	1	333.3	9	0.3333	300	5702	1
11ac40MIMO	5510	Type6	14	1	333.3	9	0.3333	300	5533	1
11ac40MIMO	5510	Type6	14	1	333.3	9	0.3333	300	5534	1
11ac40MIMO	5510	Type6	14	1	333.3	9	0.3333	300	5489	1
11ac40MIMO	5510	Type6	14	1	333.3	9	0.3333	300	5466	1
11ac40MIMO	5510	Type6	14	1	333.3	9	0.3333	300	5428	1
11ac40MIMO	5510	Type6	14	1	333.3	9	0.3333	300	5588	1
11ac40MIMO	5510	Type6	14	1	333.3	9	0.3333	300	5693	1
11ac40MIMO	5510	Type6	14	1	333.3	9	0.3333	300	5537	1
11ac40MIMO	5510	Type6	14	1	333.3	9	0.3333	300	5478	1
11ac40MIMO	5510	Type6	14	1	333.3	9	0.3333	300	5293	1
11ac40MIMO	5510	Type6	14	1	333.3	9	0.3333	300	5402	1
11ac40MIMO	5510	Type6	14	1	333.3	9	0.3333	300	5387	1
11ac40MIMO	5510	Type6	14	1	333.3	9	0.3333	300	5716	1
11ac40MIMO	5510	Type6	14	1	333.3	9	0.3333	300	5449	1
11ac40MIMO	5510	Type6	14	1	333.3	9	0.3333	300	5266	1
11ac40MIMO	5510	Type6	14	1	333.3	9	0.3333	300	5259	1
11ac40MIMO	5510	Type6	14	1	333.3	9	0.3333	300	5377	1
11ac40MIMO	5510	Type6	14	1	333.3	9	0.3333	300	5401	1
11ac40MIMO	5510	Type6	14	1	333.3	9	0.3333	300	5627	1
11ac40MIMO	5510	Type6	14	1	333.3	9	0.3333	300	5645	1
11ac40MIMO	5510	Type6	14	1	333.3	9	0.3333	300	5632	1
11ac40MIMO	5510	Type6	14	1	333.3	9	0.3333	300	5583	1
11ac40MIMO	5510	Type6	14	1	333.3	9	0.3333	300	5557	1
11ac40MIMO	5510	Type6	14	1	333.3	9	0.3333	300	5561	1
11ac40MIMO	5510	Type6	14	1	333.3	9	0.3333	300	5298	1
11ac40MIMO	5510	Type6	14	1	333.3	9	0.3333	300	5320	1
11ac40MIMO	5510	Type6	14	1	333.3	9	0.3333	300	5339	1
11ac40MIMO	5510	Type6	14	1	333.3	9	0.3333	300	5597	1
11ac40MIMO	5510	Type6	14	1	333.3	9	0.3333	300	5518	1
11ac40MIMO	5510	Type6	14	1	333.3	9	0.3333	300	5708	1
11ac40MIMO	5510	Type6	14	1	333.3	9	0.3333	300	5262	1
11ac40MIMO	5510	Type6	14	1	333.3	9	0.3333	300	5543	1
11ac20MIMO	5500	Type6	14	1	333.3	9	0.3333	300	5318	1
11ac20MIMO	5500	Type6	14	1	333.3	9	0.3333	300	5360	1
11ac20MIMO	5500	Type6	14	1	333.3	9	0.3333	300	5388	1
11ac20MIMO	5500	Type6	14	1	333.3	9	0.3333	300	5390	1
11ac20MIMO	5500	Type6	14	1	333.3	9	0.3333	300	5508	1
11ac20MIMO	5500	Type6	14	1	333.3	9	0.3333	300	5338	1
11ac20MIMO	5500	Type6	14	1	333.3	9	0.3333	300	5364	1
11ac20MIMO	5500	Type6	14	1	333.3	9	0.3333	300	5260	1



Unless otherwise agreed in writing, this document is issued by the Company subject to its General Conditions of Service printed overleaf, available on request or accessible at <http://www.sgs.com/en/Terms-and-Conditions.aspx> and, for electronic format documents, subject to Terms and Conditions for Electronic Documents at <http://www.sgs.com/en/Terms-and-Conditions/Terms-e-Document.aspx>. Attention is drawn to the limitation of liability, indemnification and jurisdiction issues defined therein. Any holder of this document is advised that information contained herein reflects the Company's findings at the time of its intervention only and within the limits of Client's instructions, if any. The Company's sole responsibility is to its Client and this document does not exonerate parties to a transaction from exercising all their rights and obligations under the transaction documents. This document cannot be reproduced except in full, without prior written approval of the Company. Any unauthorized alteration, forgery or falsification of the content or appearance of this document is unlawful and offenders may be prosecuted to the fullest extent of the law. Unless otherwise stated the results shown in this test report refer only to the sample(s) tested and such sample(s) are retained for 30 days only.

Attention: To check the authenticity of testing/inspection report & certificate, please contact us at telephone: (86-755) 8307 1443, or email: [CN.Doccheck@sgs.com](mailto:CN.Doccheck@sgs.com)  
 (E) Unit D, Building 1, Kanglong Orange Science Park, No.157, Keyuan 3rd Road, Fengjing/Yue Town, Xian, Shaanxi, China 710086  
 t (86-29) 6282 7885 www.sgs.com.cn  
 中国·西安·沣东新城科里三路157号康隆橙方科技园1号楼D单元1层 邮编: 710086 t (86-29) 6282 7885 sgs.china@sgs.com

11ac20MIMO	5500	Type6	14	1	333.3	9	0.3333	300	5594	1
11ac20MIMO	5500	Type6	14	1	333.3	9	0.3333	300	5628	1
11ac20MIMO	5500	Type6	14	1	333.3	9	0.3333	300	5321	1
11ac20MIMO	5500	Type6	14	1	333.3	9	0.3333	300	5598	1
11ac20MIMO	5500	Type6	14	1	333.3	9	0.3333	300	5585	1
11ac20MIMO	5500	Type6	14	1	333.3	9	0.3333	300	5511	1
11ac20MIMO	5500	Type6	14	1	333.3	9	0.3333	300	5407	1
11ac20MIMO	5500	Type6	14	1	333.3	9	0.3333	300	5612	1
11ac20MIMO	5500	Type6	14	1	333.3	9	0.3333	300	5700	1
11ac20MIMO	5500	Type6	14	1	333.3	9	0.3333	300	5497	1
11ac20MIMO	5500	Type6	14	1	333.3	9	0.3333	300	5724	1
11ac20MIMO	5500	Type6	14	1	333.3	9	0.3333	300	5487	1
11ac20MIMO	5500	Type6	14	1	333.3	9	0.3333	300	5263	1
11ac20MIMO	5500	Type6	14	1	333.3	9	0.3333	300	5435	1
11ac20MIMO	5500	Type6	14	1	333.3	9	0.3333	300	5471	1
11ac20MIMO	5500	Type6	14	1	333.3	9	0.3333	300	5398	1
11ac20MIMO	5500	Type6	14	1	333.3	9	0.3333	300	5306	1
11ac20MIMO	5500	Type6	14	1	333.3	9	0.3333	300	5691	1
11ac20MIMO	5500	Type6	14	1	333.3	9	0.3333	300	5654	1
11ac20MIMO	5500	Type6	14	1	333.3	9	0.3333	300	5279	1
11ac20MIMO	5500	Type6	14	1	333.3	9	0.3333	300	5720	1
11ac20MIMO	5500	Type6	14	1	333.3	9	0.3333	300	5464	1
11ac20MIMO	5500	Type6	14	1	333.3	9	0.3333	300	5650	1
11ac20MIMO	5500	Type6	14	1	333.3	9	0.3333	300	5369	1
11ac20MIMO	5500	Type6	14	1	333.3	9	0.3333	300	5532	1
11ac20MIMO	5500	Type6	14	1	333.3	9	0.3333	300	5284	1
11ac20MIMO	5500	Type6	14	1	333.3	9	0.3333	300	5516	1
11ac20MIMO	5500	Type6	14	1	333.3	9	0.3333	300	5635	1
11ac20MIMO	5500	Type6	14	1	333.3	9	0.3333	300	5417	1
11ac20MIMO	5500	Type6	14	1	333.3	9	0.3333	300	5310	1
11ac20MIMO	5500	Type6	14	1	333.3	9	0.3333	300	5582	1
11ac20MIMO	5500	Type6	14	1	333.3	9	0.3333	300	5368	1
11ac20MIMO	5500	Type6	14	1	333.3	9	0.3333	300	5657	1
11ac20MIMO	5500	Type6	14	1	333.3	9	0.3333	300	5669	1
11ac20MIMO	5500	Type6	14	1	333.3	9	0.3333	300	5503	1
11ac20MIMO	5500	Type6	14	1	333.3	9	0.3333	300	5683	1
11ac20MIMO	5500	Type6	14	1	333.3	9	0.3333	300	5353	1
11ac20MIMO	5500	Type6	14	1	333.3	9	0.3333	300	5553	1
11ac20MIMO	5500	Type6	14	1	333.3	9	0.3333	300	5270	1
11ac20MIMO	5500	Type6	14	1	333.3	9	0.3333	300	5502	1
11ac20MIMO	5500	Type6	14	1	333.3	9	0.3333	300	5714	1
11ac20MIMO	5500	Type6	14	1	333.3	9	0.3333	300	5351	1
11ac20MIMO	5500	Type6	14	1	333.3	9	0.3333	300	5362	1
11ac20MIMO	5500	Type6	14	1	333.3	9	0.3333	300	5634	1
11ac20MIMO	5500	Type6	14	1	333.3	9	0.3333	300	5457	1
11ac20MIMO	5500	Type6	14	1	333.3	9	0.3333	300	5608	1
11ac20MIMO	5500	Type6	14	1	333.3	9	0.3333	300	5711	1
11ac20MIMO	5500	Type6	14	1	333.3	9	0.3333	300	5337	1
11ac20MIMO	5500	Type6	14	1	333.3	9	0.3333	300	5607	1
11ac20MIMO	5500	Type6	14	1	333.3	9	0.3333	300	5452	1
11ac20MIMO	5500	Type6	14	1	333.3	9	0.3333	300	5372	1
11ac20MIMO	5500	Type6	14	1	333.3	9	0.3333	300	5706	1
11ac20MIMO	5500	Type6	14	1	333.3	9	0.3333	300	5599	1



Unless otherwise agreed in writing, this document is issued by the Company subject to its General Conditions of Service printed overleaf, available on request or accessible at <http://www.sgs.com/en/Terms-and-Conditions.aspx> and, for electronic format documents, subject to Terms and Conditions for Electronic Documents at <http://www.sgs.com/en/Terms-and-Conditions/Terms-e-Documents.aspx>. Attention is drawn to the limitation of liability, indemnification and jurisdiction issues defined therein. Any holder of this document is advised that information contained herein reflects the Company's findings at the time of its intervention only and within the limits of Client's instructions, if any. The Company's sole responsibility is to its Client and this document does not exonerate parties to a transaction from exercising all their rights and obligations under the transaction documents. This document cannot be reproduced except in full, without prior written approval of the Company. Any unauthorized alteration, forgery or falsification of the content or appearance of this document is unlawful and offenders may be prosecuted to the fullest extent of the law. Unless otherwise stated the results shown in this test report refer only to the sample(s) tested and such sample(s) are retained for 30 days only.

Attention: To check the authenticity of testing/inspection report & certificate, please contact us at telephone: (86-755) 8307 1443, or email: [CN.Doccheck@sgs.com](mailto:CN.Doccheck@sgs.com)  
 S/E Unit D, Building 1, Kanglong Orange Science Park, No.157, Keyuan 3rd Road, Fengyang New Town, Xian, Shaanxi, China 710086  
 t (86-29) 6282 7885 www.sgs.com.cn  
 中国·西安·沣东新城科里三路157号康鸿橙方科技园1号楼D单元1层 邮编: 710086 t (86-29) 6282 7885 sgs.china@sgs.com





Report No.: XEWA2310000070RG05

Rev.: 01

Page: 177 of 267

11ac20MIMO	5500	Type6	14	1	333.3	9	0.3333	300	5414	1
11ac20MIMO	5500	Type6	14	1	333.3	9	0.3333	300	5396	1
11ac20MIMO	5500	Type6	14	1	333.3	9	0.3333	300	5576	1
11ac20MIMO	5500	Type6	14	1	333.3	9	0.3333	300	5303	1
11ac20MIMO	5500	Type6	14	1	333.3	9	0.3333	300	5574	1
11ac20MIMO	5500	Type6	14	1	333.3	9	0.3333	300	5616	1
11ac20MIMO	5500	Type6	14	1	333.3	9	0.3333	300	5702	1
11ac20MIMO	5500	Type6	14	1	333.3	9	0.3333	300	5533	1
11ac20MIMO	5500	Type6	14	1	333.3	9	0.3333	300	5534	1
11ac20MIMO	5500	Type6	14	1	333.3	9	0.3333	300	5489	1
11ac20MIMO	5500	Type6	14	1	333.3	9	0.3333	300	5466	1
11ac20MIMO	5500	Type6	14	1	333.3	9	0.3333	300	5428	1
11ac20MIMO	5500	Type6	14	1	333.3	9	0.3333	300	5588	1
11ac20MIMO	5500	Type6	14	1	333.3	9	0.3333	300	5693	1
11ac20MIMO	5500	Type6	14	1	333.3	9	0.3333	300	5537	1
11ac20MIMO	5500	Type6	14	1	333.3	9	0.3333	300	5478	1
11ac20MIMO	5500	Type6	14	1	333.3	9	0.3333	300	5293	1
11ac20MIMO	5500	Type6	14	1	333.3	9	0.3333	300	5402	1
11ac20MIMO	5500	Type6	14	1	333.3	9	0.3333	300	5387	1
11ac20MIMO	5500	Type6	14	1	333.3	9	0.3333	300	5716	1
11ac20MIMO	5500	Type6	14	1	333.3	9	0.3333	300	5449	1
11ac20MIMO	5500	Type6	14	1	333.3	9	0.3333	300	5266	1
11ac20MIMO	5500	Type6	14	1	333.3	9	0.3333	300	5259	1
11ac20MIMO	5500	Type6	14	1	333.3	9	0.3333	300	5377	1
11ac20MIMO	5500	Type6	14	1	333.3	9	0.3333	300	5401	1
11ac20MIMO	5500	Type6	14	1	333.3	9	0.3333	300	5627	1
11ac20MIMO	5500	Type6	14	1	333.3	9	0.3333	300	5645	1
11ac20MIMO	5500	Type6	14	1	333.3	9	0.3333	300	5632	1
11ac20MIMO	5500	Type6	14	1	333.3	9	0.3333	300	5583	1
11ac20MIMO	5500	Type6	14	1	333.3	9	0.3333	300	5557	1
11ac20MIMO	5500	Type6	14	1	333.3	9	0.3333	300	5561	1
11ac20MIMO	5500	Type6	14	1	333.3	9	0.3333	300	5298	1
11ac20MIMO	5500	Type6	14	1	333.3	9	0.3333	300	5320	1
11ac20MIMO	5500	Type6	14	1	333.3	9	0.3333	300	5339	1
11ac20MIMO	5500	Type6	14	1	333.3	9	0.3333	300	5597	1
11ac20MIMO	5500	Type6	14	1	333.3	9	0.3333	300	5518	1
11ac20MIMO	5500	Type6	14	1	333.3	9	0.3333	300	5708	1
11ac20MIMO	5500	Type6	14	1	333.3	9	0.3333	300	5262	1
11ac20MIMO	5500	Type6	14	1	333.3	9	0.3333	300	5543	1



Unless otherwise agreed in writing, this document is issued by the Company subject to its General Conditions of Service printed overleaf, available on request or accessible at <http://www.sgs.com/en/Terms-and-Conditions.aspx> and, for electronic format documents, subject to Terms and Conditions for Electronic Documents at <http://www.sgs.com/en/Terms-and-Conditions/Terms-e-Documents.aspx>. Attention is drawn to the limitation of liability, indemnification and jurisdiction issues defined therein. Any holder of this document is advised that information contained herein reflects the Company's findings at the time of its intervention only and within the limits of Client's instructions, if any. The Company's sole responsibility is to its Client and this document does not exonerate parties to a transaction from exercising all their rights and obligations under the transaction documents. This document cannot be reproduced except in full, without prior written approval of the Company. Any unauthorized alteration, forgery or falsification of the content or appearance of this document is unlawful and offenders may be prosecuted to the fullest extent of the law. Unless otherwise stated the results shown in this test report refer only to the sample(s) tested and such sample(s) are retained for 30 days only.

Attention: To check the authenticity of testing/inspection report & certificate, please contact us at telephone: (86-755) 4307 1443, or email: CN.Doccheck@sgs.com

SGS-CSTC Standards Technical Services (Xi'an) Co., Ltd. | 1/E Unit D, Building 1, Kanglong Orange Source Park, No.137, Kejian 3rd Road, Fengling New Town, Xi'an, Shaanxi, China | 710086 | t: (86-29) 6282 7885 | www.sgs.com.cn  
 中国·西安·沣东新城科里三路137号康隆橙方科技园1号楼D单元1层 | 邮编: 710086 | t: (86-29) 6282 7885 | sgs.china@sgs.com

TestMode	Channel	Radar Type	Trial ID	Pulse width (μs)	PRI (μs)	Pulses per Hop	Hop Rate (kHz)	Hop Sequence Length(ms)	Center Frequency (MHz)	Detection (1: Yes; 0: No)
11ac80MIMO	5530	Type6	15	1	333.3	9	0.3333	300	5573	1
11ac80MIMO	5530	Type6	15	1	333.3	9	0.3333	300	5599	1
11ac80MIMO	5530	Type6	15	1	333.3	9	0.3333	300	5324	1
11ac80MIMO	5530	Type6	15	1	333.3	9	0.3333	300	5551	1
11ac80MIMO	5530	Type6	15	1	333.3	9	0.3333	300	5253	1
11ac80MIMO	5530	Type6	15	1	333.3	9	0.3333	300	5380	1
11ac80MIMO	5530	Type6	15	1	333.3	9	0.3333	300	5386	1
11ac80MIMO	5530	Type6	15	1	333.3	9	0.3333	300	5335	1
11ac80MIMO	5530	Type6	15	1	333.3	9	0.3333	300	5660	1
11ac80MIMO	5530	Type6	15	1	333.3	9	0.3333	300	5360	1
11ac80MIMO	5530	Type6	15	1	333.3	9	0.3333	300	5630	1
11ac80MIMO	5530	Type6	15	1	333.3	9	0.3333	300	5484	1
11ac80MIMO	5530	Type6	15	1	333.3	9	0.3333	300	5626	1
11ac80MIMO	5530	Type6	15	1	333.3	9	0.3333	300	5706	1
11ac80MIMO	5530	Type6	15	1	333.3	9	0.3333	300	5428	1
11ac80MIMO	5530	Type6	15	1	333.3	9	0.3333	300	5603	1
11ac80MIMO	5530	Type6	15	1	333.3	9	0.3333	300	5255	1
11ac80MIMO	5530	Type6	15	1	333.3	9	0.3333	300	5600	1
11ac80MIMO	5530	Type6	15	1	333.3	9	0.3333	300	5294	1
11ac80MIMO	5530	Type6	15	1	333.3	9	0.3333	300	5679	1
11ac80MIMO	5530	Type6	15	1	333.3	9	0.3333	300	5271	1
11ac80MIMO	5530	Type6	15	1	333.3	9	0.3333	300	5504	1
11ac80MIMO	5530	Type6	15	1	333.3	9	0.3333	300	5412	1
11ac80MIMO	5530	Type6	15	1	333.3	9	0.3333	300	5487	1
11ac80MIMO	5530	Type6	15	1	333.3	9	0.3333	300	5481	1
11ac80MIMO	5530	Type6	15	1	333.3	9	0.3333	300	5669	1
11ac80MIMO	5530	Type6	15	1	333.3	9	0.3333	300	5640	1
11ac80MIMO	5530	Type6	15	1	333.3	9	0.3333	300	5382	1
11ac80MIMO	5530	Type6	15	1	333.3	9	0.3333	300	5480	1
11ac80MIMO	5530	Type6	15	1	333.3	9	0.3333	300	5279	1
11ac80MIMO	5530	Type6	15	1	333.3	9	0.3333	300	5506	1
11ac80MIMO	5530	Type6	15	1	333.3	9	0.3333	300	5539	1
11ac80MIMO	5530	Type6	15	1	333.3	9	0.3333	300	5326	1
11ac80MIMO	5530	Type6	15	1	333.3	9	0.3333	300	5272	1
11ac80MIMO	5530	Type6	15	1	333.3	9	0.3333	300	5533	1
11ac80MIMO	5530	Type6	15	1	333.3	9	0.3333	300	5336	1
11ac80MIMO	5530	Type6	15	1	333.3	9	0.3333	300	5299	1
11ac80MIMO	5530	Type6	15	1	333.3	9	0.3333	300	5508	1
11ac80MIMO	5530	Type6	15	1	333.3	9	0.3333	300	5581	1
11ac80MIMO	5530	Type6	15	1	333.3	9	0.3333	300	5260	1
11ac80MIMO	5530	Type6	15	1	333.3	9	0.3333	300	5282	1
11ac80MIMO	5530	Type6	15	1	333.3	9	0.3333	300	5496	1
11ac80MIMO	5530	Type6	15	1	333.3	9	0.3333	300	5277	1
11ac80MIMO	5530	Type6	15	1	333.3	9	0.3333	300	5441	1
11ac80MIMO	5530	Type6	15	1	333.3	9	0.3333	300	5448	1
11ac80MIMO	5530	Type6	15	1	333.3	9	0.3333	300	5447	1
11ac80MIMO	5530	Type6	15	1	333.3	9	0.3333	300	5482	1
11ac80MIMO	5530	Type6	15	1	333.3	9	0.3333	300	5250	1
11ac80MIMO	5530	Type6	15	1	333.3	9	0.3333	300	5585	1



Unless otherwise agreed in writing, this document is issued by the Company subject to its General Conditions of Service printed overleaf, available on request or accessible at <http://www.sgs.com/en/Terms-and-Conditions.aspx> and, for electronic format documents, subject to Terms and Conditions for Electronic Documents at <http://www.sgs.com/en/Terms-and-Conditions/Terms-e-Documents.aspx>. Attention is drawn to the limitation of liability, indemnification and jurisdiction issues defined therein. Any holder of this document is advised that information contained herein reflects the Company's findings at the time of its intervention only and within the limits of Client's instructions, if any. The Company's sole responsibility is to its Client and this document does not exonerate parties to a transaction from exercising all their rights and obligations under the transaction documents. This document cannot be reproduced except in full, without prior written approval of the Company. Any unauthorized alteration, forgery or falsification of the content or appearance of this document is unlawful and offenders may be prosecuted to the fullest extent of the law. Unless otherwise stated the results shown in this test report refer only to the sample(s) tested and such sample(s) are retained for 30 days only.

Attention: To check the authenticity of testing/inspection report & certificate, please contact us at telephone: (86-755) 8307 1443, or email: [CN.Doccheck@sgs.com](mailto:CN.Doccheck@sgs.com)  
 S/GS-CSTC Standards Technical Services (Xi'an) Co., Ltd. | 1/E Unit D, Building 1, Kanglong Orange Science Park, No.157, Keyuan 3rd Road, Fengjing/Yue Town, Xi'an, Shaanxi, China | 710086 | t (86-29) 6282 7885 | www.sgs.com.cn  
 中国·西安·沣东新城科里三路157号康隆橙方科技园1号楼D单元1层 | 邮编: 710086 | t (86-29) 6282 7885 | sgs.china@sgs.com

11ac80MIMO	5530	Type6	15	1	333.3	9	0.3333	300	5297	1
11ac80MIMO	5530	Type6	15	1	333.3	9	0.3333	300	5404	1
11ac80MIMO	5530	Type6	15	1	333.3	9	0.3333	300	5627	1
11ac80MIMO	5530	Type6	15	1	333.3	9	0.3333	300	5510	1
11ac80MIMO	5530	Type6	15	1	333.3	9	0.3333	300	5633	1
11ac80MIMO	5530	Type6	15	1	333.3	9	0.3333	300	5553	1
11ac80MIMO	5530	Type6	15	1	333.3	9	0.3333	300	5319	1
11ac80MIMO	5530	Type6	15	1	333.3	9	0.3333	300	5534	1
11ac80MIMO	5530	Type6	15	1	333.3	9	0.3333	300	5659	1
11ac80MIMO	5530	Type6	15	1	333.3	9	0.3333	300	5320	1
11ac80MIMO	5530	Type6	15	1	333.3	9	0.3333	300	5406	1
11ac80MIMO	5530	Type6	15	1	333.3	9	0.3333	300	5562	1
11ac80MIMO	5530	Type6	15	1	333.3	9	0.3333	300	5351	1
11ac80MIMO	5530	Type6	15	1	333.3	9	0.3333	300	5677	1
11ac80MIMO	5530	Type6	15	1	333.3	9	0.3333	300	5579	1
11ac80MIMO	5530	Type6	15	1	333.3	9	0.3333	300	5438	1
11ac80MIMO	5530	Type6	15	1	333.3	9	0.3333	300	5408	1
11ac80MIMO	5530	Type6	15	1	333.3	9	0.3333	300	5604	1
11ac80MIMO	5530	Type6	15	1	333.3	9	0.3333	300	5520	1
11ac80MIMO	5530	Type6	15	1	333.3	9	0.3333	300	5342	1
11ac80MIMO	5530	Type6	15	1	333.3	9	0.3333	300	5651	1
11ac80MIMO	5530	Type6	15	1	333.3	9	0.3333	300	5569	1
11ac80MIMO	5530	Type6	15	1	333.3	9	0.3333	300	5366	1
11ac80MIMO	5530	Type6	15	1	333.3	9	0.3333	300	5284	1
11ac80MIMO	5530	Type6	15	1	333.3	9	0.3333	300	5647	1
11ac80MIMO	5530	Type6	15	1	333.3	9	0.3333	300	5500	1
11ac80MIMO	5530	Type6	15	1	333.3	9	0.3333	300	5574	1
11ac80MIMO	5530	Type6	15	1	333.3	9	0.3333	300	5318	1
11ac80MIMO	5530	Type6	15	1	333.3	9	0.3333	300	5289	1
11ac80MIMO	5530	Type6	15	1	333.3	9	0.3333	300	5381	1
11ac80MIMO	5530	Type6	15	1	333.3	9	0.3333	300	5437	1
11ac80MIMO	5530	Type6	15	1	333.3	9	0.3333	300	5522	1
11ac80MIMO	5530	Type6	15	1	333.3	9	0.3333	300	5530	1
11ac80MIMO	5530	Type6	15	1	333.3	9	0.3333	300	5697	1
11ac80MIMO	5530	Type6	15	1	333.3	9	0.3333	300	5701	1
11ac80MIMO	5530	Type6	15	1	333.3	9	0.3333	300	5376	1
11ac80MIMO	5530	Type6	15	1	333.3	9	0.3333	300	5515	1
11ac80MIMO	5530	Type6	15	1	333.3	9	0.3333	300	5444	1
11ac80MIMO	5530	Type6	15	1	333.3	9	0.3333	300	5561	1
11ac80MIMO	5530	Type6	15	1	333.3	9	0.3333	300	5624	1
11ac80MIMO	5530	Type6	15	1	333.3	9	0.3333	300	5365	1
11ac80MIMO	5530	Type6	15	1	333.3	9	0.3333	300	5535	1
11ac80MIMO	5530	Type6	15	1	333.3	9	0.3333	300	5278	1
11ac80MIMO	5530	Type6	15	1	333.3	9	0.3333	300	5641	1
11ac80MIMO	5530	Type6	15	1	333.3	9	0.3333	300	5371	1
11ac80MIMO	5530	Type6	15	1	333.3	9	0.3333	300	5587	1
11ac80MIMO	5530	Type6	15	1	333.3	9	0.3333	300	5357	1
11ac80MIMO	5530	Type6	15	1	333.3	9	0.3333	300	5552	1
11ac80MIMO	5530	Type6	15	1	333.3	9	0.3333	300	5493	1
11ac80MIMO	5530	Type6	15	1	333.3	9	0.3333	300	5560	1
11ac80MIMO	5530	Type6	15	1	333.3	9	0.3333	300	5608	1
11ac40MIMO	5510	Type6	15	1	333.3	9	0.3333	300	5573	1
11ac40MIMO	5510	Type6	15	1	333.3	9	0.3333	300	5599	1



Unless otherwise agreed in writing, this document is issued by the Company subject to its General Conditions of Service printed overleaf, available on request or accessible at <http://www.sgs.com/en/Terms-and-Conditions.aspx> and, for electronic format documents, subject to Terms and Conditions for Electronic Documents at <http://www.sgs.com/en/Terms-and-Conditions/Terms-e-Documents.aspx>. Attention is drawn to the limitation of liability, indemnification and jurisdiction issues defined therein. Any holder of this document is advised that information contained herein reflects the Company's findings at the time of its intervention only and within the limits of Client's instructions, if any. The Company's sole responsibility is to its Client and this document does not exonerate parties to a transaction from exercising all their rights and obligations under the transaction documents. This document cannot be reproduced except in full, without prior written approval of the Company. Any unauthorized alteration, forgery or falsification of the content or appearance of this document is unlawful and offenders may be prosecuted to the fullest extent of the law. Unless otherwise stated the results shown in this test report refer only to the sample(s) tested and such sample(s) are retained for 30 days only.

Attention: To check the authenticity of testing/inspection report & certificate, please contact us at telephone: (86-755) 8307 1443, or email: [CN.Doccheck@sgs.com](mailto:CN.Doccheck@sgs.com)

SGS-CSTC Standards Technical Services (Xi'an) Co., Ltd. | 1/F Unit D, Building 1, Kanglong Orange Science Park, No.157, Keyuan 3rd Road, Fengyang New Town, Xian, Shaanxi, China | 710086 | T (86-29) 6282 7885 | [www.sgs.com](http://www.sgs.com)  
 中国·西安·沣东新城科里三路157号康隆橙方科技园1号楼D单元1层 | 邮编: 710086 | T (86-29) 6282 7885 | [sgs.china@sgs.com](mailto:sgs.china@sgs.com)

11ac40MIMO	5510	Type6	15	1	333.3	9	0.3333	300	5324	1
11ac40MIMO	5510	Type6	15	1	333.3	9	0.3333	300	5551	1
11ac40MIMO	5510	Type6	15	1	333.3	9	0.3333	300	5253	1
11ac40MIMO	5510	Type6	15	1	333.3	9	0.3333	300	5380	1
11ac40MIMO	5510	Type6	15	1	333.3	9	0.3333	300	5386	1
11ac40MIMO	5510	Type6	15	1	333.3	9	0.3333	300	5335	1
11ac40MIMO	5510	Type6	15	1	333.3	9	0.3333	300	5660	1
11ac40MIMO	5510	Type6	15	1	333.3	9	0.3333	300	5360	1
11ac40MIMO	5510	Type6	15	1	333.3	9	0.3333	300	5630	1
11ac40MIMO	5510	Type6	15	1	333.3	9	0.3333	300	5484	1
11ac40MIMO	5510	Type6	15	1	333.3	9	0.3333	300	5626	1
11ac40MIMO	5510	Type6	15	1	333.3	9	0.3333	300	5706	1
11ac40MIMO	5510	Type6	15	1	333.3	9	0.3333	300	5428	1
11ac40MIMO	5510	Type6	15	1	333.3	9	0.3333	300	5603	1
11ac40MIMO	5510	Type6	15	1	333.3	9	0.3333	300	5255	1
11ac40MIMO	5510	Type6	15	1	333.3	9	0.3333	300	5600	1
11ac40MIMO	5510	Type6	15	1	333.3	9	0.3333	300	5294	1
11ac40MIMO	5510	Type6	15	1	333.3	9	0.3333	300	5679	1
11ac40MIMO	5510	Type6	15	1	333.3	9	0.3333	300	5271	1
11ac40MIMO	5510	Type6	15	1	333.3	9	0.3333	300	5504	1
11ac40MIMO	5510	Type6	15	1	333.3	9	0.3333	300	5412	1
11ac40MIMO	5510	Type6	15	1	333.3	9	0.3333	300	5487	1
11ac40MIMO	5510	Type6	15	1	333.3	9	0.3333	300	5481	1
11ac40MIMO	5510	Type6	15	1	333.3	9	0.3333	300	5669	1
11ac40MIMO	5510	Type6	15	1	333.3	9	0.3333	300	5640	1
11ac40MIMO	5510	Type6	15	1	333.3	9	0.3333	300	5382	1
11ac40MIMO	5510	Type6	15	1	333.3	9	0.3333	300	5480	1
11ac40MIMO	5510	Type6	15	1	333.3	9	0.3333	300	5279	1
11ac40MIMO	5510	Type6	15	1	333.3	9	0.3333	300	5506	1
11ac40MIMO	5510	Type6	15	1	333.3	9	0.3333	300	5539	1
11ac40MIMO	5510	Type6	15	1	333.3	9	0.3333	300	5326	1
11ac40MIMO	5510	Type6	15	1	333.3	9	0.3333	300	5272	1
11ac40MIMO	5510	Type6	15	1	333.3	9	0.3333	300	5533	1
11ac40MIMO	5510	Type6	15	1	333.3	9	0.3333	300	5336	1
11ac40MIMO	5510	Type6	15	1	333.3	9	0.3333	300	5299	1
11ac40MIMO	5510	Type6	15	1	333.3	9	0.3333	300	5508	1
11ac40MIMO	5510	Type6	15	1	333.3	9	0.3333	300	5581	1
11ac40MIMO	5510	Type6	15	1	333.3	9	0.3333	300	5260	1
11ac40MIMO	5510	Type6	15	1	333.3	9	0.3333	300	5282	1
11ac40MIMO	5510	Type6	15	1	333.3	9	0.3333	300	5496	1
11ac40MIMO	5510	Type6	15	1	333.3	9	0.3333	300	5277	1
11ac40MIMO	5510	Type6	15	1	333.3	9	0.3333	300	5441	1
11ac40MIMO	5510	Type6	15	1	333.3	9	0.3333	300	5448	1
11ac40MIMO	5510	Type6	15	1	333.3	9	0.3333	300	5447	1
11ac40MIMO	5510	Type6	15	1	333.3	9	0.3333	300	5482	1
11ac40MIMO	5510	Type6	15	1	333.3	9	0.3333	300	5250	1
11ac40MIMO	5510	Type6	15	1	333.3	9	0.3333	300	5585	1
11ac40MIMO	5510	Type6	15	1	333.3	9	0.3333	300	5297	1
11ac40MIMO	5510	Type6	15	1	333.3	9	0.3333	300	5404	1
11ac40MIMO	5510	Type6	15	1	333.3	9	0.3333	300	5627	1
11ac40MIMO	5510	Type6	15	1	333.3	9	0.3333	300	5510	1
11ac40MIMO	5510	Type6	15	1	333.3	9	0.3333	300	5633	1
11ac40MIMO	5510	Type6	15	1	333.3	9	0.3333	300	5553	1



Unless otherwise agreed in writing, this document is issued by the Company subject to its General Conditions of Service printed overleaf, available on request or accessible at <http://www.sgs.com/en/Terms-and-Conditions.aspx> and, for electronic format documents, subject to Terms and Conditions for Electronic Documents at <http://www.sgs.com/en/Terms-and-Conditions/Terms-e-Documents.aspx>. Attention is drawn to the limitation of liability, indemnification and jurisdiction issues defined therein. Any holder of this document is advised that information contained herein reflects the Company's findings at the time of its intervention only and within the limits of Client's instructions, if any. The Company's sole responsibility is to its Client and this document does not exonerate parties to a transaction from exercising all their rights and obligations under the transaction documents. This document cannot be reproduced except in full, without prior written approval of the Company. Any unauthorized alteration, forgery or falsification of the content or appearance of this document is unlawful and offenders may be prosecuted to the fullest extent of the law. Unless otherwise stated the results shown in this test report refer only to the sample(s) tested and such sample(s) are retained for 30 days only.

Attention: To check the authenticity of testing/inspection report & certificate, please contact us at telephone: (86-755) 8307 1443, or email: [CN.Doccheck@sgs.com](mailto:CN.Doccheck@sgs.com)

SGS-CSTC Standards Technical Services (Xi'an) Co., Ltd. | 1/E Unit D, Building 1, Kanglong Orange Science Park, No.137, Keyuan 3rd Road, Fengyang New Town, Xian, Shaanxi, China | 710086 | T (86-29) 6282 7885 | [www.sgs.com](http://www.sgs.com)  
 中国·西安·沣东新城科里三路137号康隆橙方科技园1号楼D单元1层 | 邮编: 710086 | T (86-29) 6282 7885 | [sgs.china@sgs.com](mailto:sgs.china@sgs.com)

11ac40MIMO	5510	Type6	15	1	333.3	9	0.3333	300	5319	1
11ac40MIMO	5510	Type6	15	1	333.3	9	0.3333	300	5534	1
11ac40MIMO	5510	Type6	15	1	333.3	9	0.3333	300	5659	1
11ac40MIMO	5510	Type6	15	1	333.3	9	0.3333	300	5320	1
11ac40MIMO	5510	Type6	15	1	333.3	9	0.3333	300	5406	1
11ac40MIMO	5510	Type6	15	1	333.3	9	0.3333	300	5562	1
11ac40MIMO	5510	Type6	15	1	333.3	9	0.3333	300	5351	1
11ac40MIMO	5510	Type6	15	1	333.3	9	0.3333	300	5677	1
11ac40MIMO	5510	Type6	15	1	333.3	9	0.3333	300	5579	1
11ac40MIMO	5510	Type6	15	1	333.3	9	0.3333	300	5438	1
11ac40MIMO	5510	Type6	15	1	333.3	9	0.3333	300	5408	1
11ac40MIMO	5510	Type6	15	1	333.3	9	0.3333	300	5604	1
11ac40MIMO	5510	Type6	15	1	333.3	9	0.3333	300	5520	1
11ac40MIMO	5510	Type6	15	1	333.3	9	0.3333	300	5342	1
11ac40MIMO	5510	Type6	15	1	333.3	9	0.3333	300	5651	1
11ac40MIMO	5510	Type6	15	1	333.3	9	0.3333	300	5569	1
11ac40MIMO	5510	Type6	15	1	333.3	9	0.3333	300	5366	1
11ac40MIMO	5510	Type6	15	1	333.3	9	0.3333	300	5284	1
11ac40MIMO	5510	Type6	15	1	333.3	9	0.3333	300	5647	1
11ac40MIMO	5510	Type6	15	1	333.3	9	0.3333	300	5500	1
11ac40MIMO	5510	Type6	15	1	333.3	9	0.3333	300	5574	1
11ac40MIMO	5510	Type6	15	1	333.3	9	0.3333	300	5318	1
11ac40MIMO	5510	Type6	15	1	333.3	9	0.3333	300	5289	1
11ac40MIMO	5510	Type6	15	1	333.3	9	0.3333	300	5381	1
11ac40MIMO	5510	Type6	15	1	333.3	9	0.3333	300	5437	1
11ac40MIMO	5510	Type6	15	1	333.3	9	0.3333	300	5522	1
11ac40MIMO	5510	Type6	15	1	333.3	9	0.3333	300	5530	1
11ac40MIMO	5510	Type6	15	1	333.3	9	0.3333	300	5697	1
11ac40MIMO	5510	Type6	15	1	333.3	9	0.3333	300	5701	1
11ac40MIMO	5510	Type6	15	1	333.3	9	0.3333	300	5376	1
11ac40MIMO	5510	Type6	15	1	333.3	9	0.3333	300	5515	1
11ac40MIMO	5510	Type6	15	1	333.3	9	0.3333	300	5444	1
11ac40MIMO	5510	Type6	15	1	333.3	9	0.3333	300	5561	1
11ac40MIMO	5510	Type6	15	1	333.3	9	0.3333	300	5624	1
11ac40MIMO	5510	Type6	15	1	333.3	9	0.3333	300	5365	1
11ac40MIMO	5510	Type6	15	1	333.3	9	0.3333	300	5535	1
11ac40MIMO	5510	Type6	15	1	333.3	9	0.3333	300	5278	1
11ac40MIMO	5510	Type6	15	1	333.3	9	0.3333	300	5641	1
11ac40MIMO	5510	Type6	15	1	333.3	9	0.3333	300	5371	1
11ac40MIMO	5510	Type6	15	1	333.3	9	0.3333	300	5587	1
11ac40MIMO	5510	Type6	15	1	333.3	9	0.3333	300	5357	1
11ac40MIMO	5510	Type6	15	1	333.3	9	0.3333	300	5552	1
11ac40MIMO	5510	Type6	15	1	333.3	9	0.3333	300	5493	1
11ac40MIMO	5510	Type6	15	1	333.3	9	0.3333	300	5560	1
11ac40MIMO	5510	Type6	15	1	333.3	9	0.3333	300	5608	1
11ac20MIMO	5500	Type6	15	1	333.3	9	0.3333	300	5573	1
11ac20MIMO	5500	Type6	15	1	333.3	9	0.3333	300	5599	1
11ac20MIMO	5500	Type6	15	1	333.3	9	0.3333	300	5324	1
11ac20MIMO	5500	Type6	15	1	333.3	9	0.3333	300	5551	1
11ac20MIMO	5500	Type6	15	1	333.3	9	0.3333	300	5253	1
11ac20MIMO	5500	Type6	15	1	333.3	9	0.3333	300	5380	1
11ac20MIMO	5500	Type6	15	1	333.3	9	0.3333	300	5386	1
11ac20MIMO	5500	Type6	15	1	333.3	9	0.3333	300	5335	1



Unless otherwise agreed in writing, this document is issued by the Company subject to its General Conditions of Service printed overleaf, available on request or accessible at <http://www.sgs.com/en/Terms-and-Conditions.aspx> and, for electronic format documents, subject to Terms and Conditions for Electronic Documents at <http://www.sgs.com/en/Terms-and-Conditions/Terms-e-Document.aspx>. Attention is drawn to the limitation of liability, indemnification and jurisdiction issues defined therein. Any holder of this document is advised that information contained herein reflects the Company's findings at the time of its intervention only and within the limits of Client's instructions, if any. The Company's sole responsibility is to its Client and this document does not exonerate parties to a transaction from exercising all their rights and obligations under the transaction documents. This document cannot be reproduced except in full, without prior written approval of the Company. Any unauthorized alteration, forgery or falsification of the content or appearance of this document is unlawful and offenders may be prosecuted to the fullest extent of the law. Unless otherwise stated the results shown in this test report refer only to the sample(s) tested and such sample(s) are retained for 30 days only.

Attention: To check the authenticity of testing/inspection report & certificate, please contact us at telephone: (86-755) 8307 1443, or email: [CN.Doccheck@sgs.com](mailto:CN.Doccheck@sgs.com)

SGS-CSTC Standards Technical Services (Xi'an) Co., Ltd. | 1/E Unit D, Building 1, Kanglong Orange Science Park, No.137, Keyuan 3rd Road, Fengyang New Town, Xi'an, Shaanxi, China | 710086 | T (86-29) 6282 7885 | [www.sgs.com](http://www.sgs.com)  
 中国·西安·沣东新城科里三路137号康隆橙方科技园1号楼D单元1层 | 邮编: 710086 | T (86-29) 6282 7885 | [sgs.china@sgs.com](mailto:sgs.china@sgs.com)

11ac20MIMO	5500	Type6	15	1	333.3	9	0.3333	300	5660	1
11ac20MIMO	5500	Type6	15	1	333.3	9	0.3333	300	5360	1
11ac20MIMO	5500	Type6	15	1	333.3	9	0.3333	300	5630	1
11ac20MIMO	5500	Type6	15	1	333.3	9	0.3333	300	5484	1
11ac20MIMO	5500	Type6	15	1	333.3	9	0.3333	300	5626	1
11ac20MIMO	5500	Type6	15	1	333.3	9	0.3333	300	5706	1
11ac20MIMO	5500	Type6	15	1	333.3	9	0.3333	300	5428	1
11ac20MIMO	5500	Type6	15	1	333.3	9	0.3333	300	5603	1
11ac20MIMO	5500	Type6	15	1	333.3	9	0.3333	300	5255	1
11ac20MIMO	5500	Type6	15	1	333.3	9	0.3333	300	5600	1
11ac20MIMO	5500	Type6	15	1	333.3	9	0.3333	300	5294	1
11ac20MIMO	5500	Type6	15	1	333.3	9	0.3333	300	5679	1
11ac20MIMO	5500	Type6	15	1	333.3	9	0.3333	300	5271	1
11ac20MIMO	5500	Type6	15	1	333.3	9	0.3333	300	5504	1
11ac20MIMO	5500	Type6	15	1	333.3	9	0.3333	300	5412	1
11ac20MIMO	5500	Type6	15	1	333.3	9	0.3333	300	5487	1
11ac20MIMO	5500	Type6	15	1	333.3	9	0.3333	300	5481	1
11ac20MIMO	5500	Type6	15	1	333.3	9	0.3333	300	5669	1
11ac20MIMO	5500	Type6	15	1	333.3	9	0.3333	300	5640	1
11ac20MIMO	5500	Type6	15	1	333.3	9	0.3333	300	5382	1
11ac20MIMO	5500	Type6	15	1	333.3	9	0.3333	300	5480	1
11ac20MIMO	5500	Type6	15	1	333.3	9	0.3333	300	5279	1
11ac20MIMO	5500	Type6	15	1	333.3	9	0.3333	300	5506	1
11ac20MIMO	5500	Type6	15	1	333.3	9	0.3333	300	5539	1
11ac20MIMO	5500	Type6	15	1	333.3	9	0.3333	300	5326	1
11ac20MIMO	5500	Type6	15	1	333.3	9	0.3333	300	5272	1
11ac20MIMO	5500	Type6	15	1	333.3	9	0.3333	300	5533	1
11ac20MIMO	5500	Type6	15	1	333.3	9	0.3333	300	5336	1
11ac20MIMO	5500	Type6	15	1	333.3	9	0.3333	300	5299	1
11ac20MIMO	5500	Type6	15	1	333.3	9	0.3333	300	5508	1
11ac20MIMO	5500	Type6	15	1	333.3	9	0.3333	300	5581	1
11ac20MIMO	5500	Type6	15	1	333.3	9	0.3333	300	5260	1
11ac20MIMO	5500	Type6	15	1	333.3	9	0.3333	300	5282	1
11ac20MIMO	5500	Type6	15	1	333.3	9	0.3333	300	5496	1
11ac20MIMO	5500	Type6	15	1	333.3	9	0.3333	300	5277	1
11ac20MIMO	5500	Type6	15	1	333.3	9	0.3333	300	5441	1
11ac20MIMO	5500	Type6	15	1	333.3	9	0.3333	300	5448	1
11ac20MIMO	5500	Type6	15	1	333.3	9	0.3333	300	5447	1
11ac20MIMO	5500	Type6	15	1	333.3	9	0.3333	300	5482	1
11ac20MIMO	5500	Type6	15	1	333.3	9	0.3333	300	5250	1
11ac20MIMO	5500	Type6	15	1	333.3	9	0.3333	300	5585	1
11ac20MIMO	5500	Type6	15	1	333.3	9	0.3333	300	5297	1
11ac20MIMO	5500	Type6	15	1	333.3	9	0.3333	300	5404	1
11ac20MIMO	5500	Type6	15	1	333.3	9	0.3333	300	5627	1
11ac20MIMO	5500	Type6	15	1	333.3	9	0.3333	300	5510	1
11ac20MIMO	5500	Type6	15	1	333.3	9	0.3333	300	5633	1
11ac20MIMO	5500	Type6	15	1	333.3	9	0.3333	300	5553	1
11ac20MIMO	5500	Type6	15	1	333.3	9	0.3333	300	5319	1
11ac20MIMO	5500	Type6	15	1	333.3	9	0.3333	300	5534	1
11ac20MIMO	5500	Type6	15	1	333.3	9	0.3333	300	5659	1
11ac20MIMO	5500	Type6	15	1	333.3	9	0.3333	300	5320	1
11ac20MIMO	5500	Type6	15	1	333.3	9	0.3333	300	5406	1
11ac20MIMO	5500	Type6	15	1	333.3	9	0.3333	300	5562	1



Unless otherwise agreed in writing, this document is issued by the Company subject to its General Conditions of Service printed overleaf, available on request or accessible at <http://www.sgs.com/en/Terms-and-Conditions.aspx> and, for electronic format documents, subject to Terms and Conditions for Electronic Documents at <http://www.sgs.com/en/Terms-and-Conditions/Terms-e-Documents.aspx>. Attention is drawn to the limitation of liability, indemnification and jurisdiction issues defined therein. Any holder of this document is advised that information contained herein reflects the Company's findings at the time of its intervention only and within the limits of Client's instructions, if any. The Company's sole responsibility is to its Client and this document does not exonerate parties to a transaction from exercising all their rights and obligations under the transaction documents. This document cannot be reproduced except in full, without prior written approval of the Company. Any unauthorized alteration, forgery or falsification of the content or appearance of this document is unlawful and offenders may be prosecuted to the fullest extent of the law. Unless otherwise stated the results shown in this test report refer only to the sample(s) tested and such sample(s) are retained for 30 days only.

Attention: To check the authenticity of testing/inspection report & certificate, please contact us at telephone: (86-755) 8307 1443, or email: [CN.Doccheck@sgs.com](mailto:CN.Doccheck@sgs.com)

SGS-CSTC Standards Technical Services (Xi'an) Co., Ltd. | 1/E Unit D, Building 1, Kanglong Orange Science Park, No.137, Keyuan 3rd Road, Fengyang New Town, Xian, Shaanxi, China | 710086 | T (86-29) 6282 7885 | [www.sgs.com](http://www.sgs.com)  
 中国·西安·沣东新城科里三路137号康鸿橙方科技园1号楼D单元1层 | 邮编: 710086 | T (86-29) 6282 7885 | [sgs.china@sgs.com](mailto:sgs.china@sgs.com)

Report No.: XEWA2310000070RG05

Rev.: 01

Page: 183 of 267

11ac20MIMO	5500	Type6	15	1	333.3	9	0.3333	300	5351	1
11ac20MIMO	5500	Type6	15	1	333.3	9	0.3333	300	5677	1
11ac20MIMO	5500	Type6	15	1	333.3	9	0.3333	300	5579	1
11ac20MIMO	5500	Type6	15	1	333.3	9	0.3333	300	5438	1
11ac20MIMO	5500	Type6	15	1	333.3	9	0.3333	300	5408	1
11ac20MIMO	5500	Type6	15	1	333.3	9	0.3333	300	5604	1
11ac20MIMO	5500	Type6	15	1	333.3	9	0.3333	300	5520	1
11ac20MIMO	5500	Type6	15	1	333.3	9	0.3333	300	5342	1
11ac20MIMO	5500	Type6	15	1	333.3	9	0.3333	300	5651	1
11ac20MIMO	5500	Type6	15	1	333.3	9	0.3333	300	5569	1
11ac20MIMO	5500	Type6	15	1	333.3	9	0.3333	300	5366	1
11ac20MIMO	5500	Type6	15	1	333.3	9	0.3333	300	5284	1
11ac20MIMO	5500	Type6	15	1	333.3	9	0.3333	300	5647	1
11ac20MIMO	5500	Type6	15	1	333.3	9	0.3333	300	5500	1
11ac20MIMO	5500	Type6	15	1	333.3	9	0.3333	300	5574	1
11ac20MIMO	5500	Type6	15	1	333.3	9	0.3333	300	5318	1
11ac20MIMO	5500	Type6	15	1	333.3	9	0.3333	300	5289	1
11ac20MIMO	5500	Type6	15	1	333.3	9	0.3333	300	5381	1
11ac20MIMO	5500	Type6	15	1	333.3	9	0.3333	300	5437	1
11ac20MIMO	5500	Type6	15	1	333.3	9	0.3333	300	5522	1
11ac20MIMO	5500	Type6	15	1	333.3	9	0.3333	300	5530	1
11ac20MIMO	5500	Type6	15	1	333.3	9	0.3333	300	5697	1
11ac20MIMO	5500	Type6	15	1	333.3	9	0.3333	300	5701	1
11ac20MIMO	5500	Type6	15	1	333.3	9	0.3333	300	5376	1
11ac20MIMO	5500	Type6	15	1	333.3	9	0.3333	300	5515	1
11ac20MIMO	5500	Type6	15	1	333.3	9	0.3333	300	5444	1
11ac20MIMO	5500	Type6	15	1	333.3	9	0.3333	300	5561	1
11ac20MIMO	5500	Type6	15	1	333.3	9	0.3333	300	5624	1
11ac20MIMO	5500	Type6	15	1	333.3	9	0.3333	300	5365	1
11ac20MIMO	5500	Type6	15	1	333.3	9	0.3333	300	5535	1
11ac20MIMO	5500	Type6	15	1	333.3	9	0.3333	300	5278	1
11ac20MIMO	5500	Type6	15	1	333.3	9	0.3333	300	5641	1
11ac20MIMO	5500	Type6	15	1	333.3	9	0.3333	300	5371	1
11ac20MIMO	5500	Type6	15	1	333.3	9	0.3333	300	5587	1
11ac20MIMO	5500	Type6	15	1	333.3	9	0.3333	300	5357	1
11ac20MIMO	5500	Type6	15	1	333.3	9	0.3333	300	5552	1
11ac20MIMO	5500	Type6	15	1	333.3	9	0.3333	300	5493	1
11ac20MIMO	5500	Type6	15	1	333.3	9	0.3333	300	5560	1
11ac20MIMO	5500	Type6	15	1	333.3	9	0.3333	300	5608	1



Unless otherwise agreed in writing, this document is issued by the Company subject to its General Conditions of Service printed overleaf, available on request or accessible at <http://www.sgs.com/en/Terms-and-Conditions.aspx> and, for electronic format documents, subject to Terms and Conditions for Electronic Documents at <http://www.sgs.com/en/Terms-and-Conditions/Terms-e-Documents.aspx>. Attention is drawn to the limitation of liability, indemnification and jurisdiction issues defined therein. Any holder of this document is advised that information contained herein reflects the Company's findings at the time of its intervention only and within the limits of Client's instructions, if any. The Company's sole responsibility is to its Client and this document does not exonerate parties to a transaction from exercising all their rights and obligations under the transaction documents. This document cannot be reproduced except in full, without prior written approval of the Company. Any unauthorized alteration, forgery or falsification of the content or appearance of this document is unlawful and offenders may be prosecuted to the fullest extent of the law. Unless otherwise stated the results shown in this test report refer only to the sample(s) tested and such sample(s) are retained for 30 days only.

Attention: To check the authenticity of testing/inspection report & certificate, please contact us at telephone: (86-755) 4307 1443, or email: [CN.Doccheck@sgs.com](mailto:CN.Doccheck@sgs.com)  
 (SGS-CSTC) Standards Technical Services (Xi'an) Co., Ltd. | 1/E Unit D, Building 1, Kanghong Orange Source Park, No.137, Kejian 3rd Road, Fengling New Town, Xi'an, Shaanxi, China | 710086 | t: (86-29) 6282 7885 | www.sgs.com.cn  
 中国·西安·沣东新城科里三路137号康鸿橙方科技园1号楼D单元1层 | 邮编: 710086 | t: (86-29) 6282 7885 | sgs.china@sgs.com

TestMode	Channel	Radar Type	Trial ID	Pulse width (μs)	PRI (μs)	Pulses per Hop	Hop Rate (kHz)	Hop Sequence Length(ms)	Center Frequency (MHz)	Detection (1: Yes; 0: No)
11ac80MIMO	5530	Type6	16	1	333.3	9	0.3333	300	5256	1
11ac80MIMO	5530	Type6	16	1	333.3	9	0.3333	300	5460	1
11ac80MIMO	5530	Type6	16	1	333.3	9	0.3333	300	5260	1
11ac80MIMO	5530	Type6	16	1	333.3	9	0.3333	300	5615	1
11ac80MIMO	5530	Type6	16	1	333.3	9	0.3333	300	5570	1
11ac80MIMO	5530	Type6	16	1	333.3	9	0.3333	300	5422	1
11ac80MIMO	5530	Type6	16	1	333.3	9	0.3333	300	5311	1
11ac80MIMO	5530	Type6	16	1	333.3	9	0.3333	300	5410	1
11ac80MIMO	5530	Type6	16	1	333.3	9	0.3333	300	5348	1
11ac80MIMO	5530	Type6	16	1	333.3	9	0.3333	300	5567	1
11ac80MIMO	5530	Type6	16	1	333.3	9	0.3333	300	5561	1
11ac80MIMO	5530	Type6	16	1	333.3	9	0.3333	300	5273	1
11ac80MIMO	5530	Type6	16	1	333.3	9	0.3333	300	5667	1
11ac80MIMO	5530	Type6	16	1	333.3	9	0.3333	300	5426	1
11ac80MIMO	5530	Type6	16	1	333.3	9	0.3333	300	5449	1
11ac80MIMO	5530	Type6	16	1	333.3	9	0.3333	300	5691	1
11ac80MIMO	5530	Type6	16	1	333.3	9	0.3333	300	5382	1
11ac80MIMO	5530	Type6	16	1	333.3	9	0.3333	300	5703	1
11ac80MIMO	5530	Type6	16	1	333.3	9	0.3333	300	5339	1
11ac80MIMO	5530	Type6	16	1	333.3	9	0.3333	300	5396	1
11ac80MIMO	5530	Type6	16	1	333.3	9	0.3333	300	5279	1
11ac80MIMO	5530	Type6	16	1	333.3	9	0.3333	300	5670	1
11ac80MIMO	5530	Type6	16	1	333.3	9	0.3333	300	5353	1
11ac80MIMO	5530	Type6	16	1	333.3	9	0.3333	300	5479	1
11ac80MIMO	5530	Type6	16	1	333.3	9	0.3333	300	5454	1
11ac80MIMO	5530	Type6	16	1	333.3	9	0.3333	300	5557	1
11ac80MIMO	5530	Type6	16	1	333.3	9	0.3333	300	5492	1
11ac80MIMO	5530	Type6	16	1	333.3	9	0.3333	300	5488	1
11ac80MIMO	5530	Type6	16	1	333.3	9	0.3333	300	5584	1
11ac80MIMO	5530	Type6	16	1	333.3	9	0.3333	300	5313	1
11ac80MIMO	5530	Type6	16	1	333.3	9	0.3333	300	5645	1
11ac80MIMO	5530	Type6	16	1	333.3	9	0.3333	300	5525	1
11ac80MIMO	5530	Type6	16	1	333.3	9	0.3333	300	5283	1
11ac80MIMO	5530	Type6	16	1	333.3	9	0.3333	300	5487	1
11ac80MIMO	5530	Type6	16	1	333.3	9	0.3333	300	5685	1
11ac80MIMO	5530	Type6	16	1	333.3	9	0.3333	300	5534	1
11ac80MIMO	5530	Type6	16	1	333.3	9	0.3333	300	5341	1
11ac80MIMO	5530	Type6	16	1	333.3	9	0.3333	300	5599	1
11ac80MIMO	5530	Type6	16	1	333.3	9	0.3333	300	5377	1
11ac80MIMO	5530	Type6	16	1	333.3	9	0.3333	300	5413	1
11ac80MIMO	5530	Type6	16	1	333.3	9	0.3333	300	5671	1
11ac80MIMO	5530	Type6	16	1	333.3	9	0.3333	300	5335	1
11ac80MIMO	5530	Type6	16	1	333.3	9	0.3333	300	5360	1
11ac80MIMO	5530	Type6	16	1	333.3	9	0.3333	300	5379	1
11ac80MIMO	5530	Type6	16	1	333.3	9	0.3333	300	5591	1
11ac80MIMO	5530	Type6	16	1	333.3	9	0.3333	300	5444	1
11ac80MIMO	5530	Type6	16	1	333.3	9	0.3333	300	5411	1
11ac80MIMO	5530	Type6	16	1	333.3	9	0.3333	300	5705	1
11ac80MIMO	5530	Type6	16	1	333.3	9	0.3333	300	5668	1



Unless otherwise agreed in writing, this document is issued by the Company subject to its General Conditions of Service printed overleaf, available on request or accessible at <http://www.sgs.com/en/Terms-and-Conditions.aspx> and, for electronic format documents, subject to Terms and Conditions for Electronic Documents at <http://www.sgs.com/en/Terms-and-Conditions/Terms-e-Documents.aspx>. Attention is drawn to the limitation of liability, indemnification and jurisdiction issues defined therein. Any holder of this document is advised that information contained herein reflects the Company's findings at the time of its intervention only and within the limits of Client's instructions, if any. The Company's sole responsibility is to its Client and this document does not exonerate parties to a transaction from exercising all their rights and obligations under the transaction documents. This document cannot be reproduced except in full, without prior written approval of the Company. Any unauthorized alteration, forgery or falsification of the content or appearance of this document is unlawful and offenders may be prosecuted to the fullest extent of the law. Unless otherwise stated the results shown in this test report refer only to the sample(s) tested and such sample(s) are retained for 30 days only.

Attention: To check the authenticity of testing/inspection report & certificate, please contact us at telephone: (86-755) 8307 1443, or email: [CN.Doccheck@sgs.com](mailto:CN.Doccheck@sgs.com)  
 S/GS-CSTC Standards Technical Services (Xi'an) Co., Ltd. | 1/E Unit D, Building 1, Kanglong Orange Science Park, No.157, Keyuan 3rd Road, Fengjing/Yue Town, Xi'an, Shaanxi, China | 710086 | t (86-29) 6282 7885 | www.sgs.com.cn  
 中国·西安·沣东新城科里三路157号康隆橙方科技园1号楼D单元1层 | 邮编: 710086 | t (86-29) 6282 7885 | sgs.china@sgs.com



11ac80MIMO	5530	Type6	16	1	333.3	9	0.3333	300	5258	1
11ac80MIMO	5530	Type6	16	1	333.3	9	0.3333	300	5457	1
11ac80MIMO	5530	Type6	16	1	333.3	9	0.3333	300	5514	1
11ac80MIMO	5530	Type6	16	1	333.3	9	0.3333	300	5289	1
11ac80MIMO	5530	Type6	16	1	333.3	9	0.3333	300	5334	1
11ac80MIMO	5530	Type6	16	1	333.3	9	0.3333	300	5604	1
11ac80MIMO	5530	Type6	16	1	333.3	9	0.3333	300	5408	1
11ac80MIMO	5530	Type6	16	1	333.3	9	0.3333	300	5357	1
11ac80MIMO	5530	Type6	16	1	333.3	9	0.3333	300	5603	1
11ac80MIMO	5530	Type6	16	1	333.3	9	0.3333	300	5263	1
11ac80MIMO	5530	Type6	16	1	333.3	9	0.3333	300	5655	1
11ac80MIMO	5530	Type6	16	1	333.3	9	0.3333	300	5548	1
11ac80MIMO	5530	Type6	16	1	333.3	9	0.3333	300	5551	1
11ac80MIMO	5530	Type6	16	1	333.3	9	0.3333	300	5269	1
11ac80MIMO	5530	Type6	16	1	333.3	9	0.3333	300	5383	1
11ac80MIMO	5530	Type6	16	1	333.3	9	0.3333	300	5715	1
11ac80MIMO	5530	Type6	16	1	333.3	9	0.3333	300	5527	1
11ac80MIMO	5530	Type6	16	1	333.3	9	0.3333	300	5466	1
11ac80MIMO	5530	Type6	16	1	333.3	9	0.3333	300	5640	1
11ac80MIMO	5530	Type6	16	1	333.3	9	0.3333	300	5600	1
11ac80MIMO	5530	Type6	16	1	333.3	9	0.3333	300	5508	1
11ac80MIMO	5530	Type6	16	1	333.3	9	0.3333	300	5576	1
11ac80MIMO	5530	Type6	16	1	333.3	9	0.3333	300	5651	1
11ac80MIMO	5530	Type6	16	1	333.3	9	0.3333	300	5450	1
11ac80MIMO	5530	Type6	16	1	333.3	9	0.3333	300	5669	1
11ac80MIMO	5530	Type6	16	1	333.3	9	0.3333	300	5560	1
11ac80MIMO	5530	Type6	16	1	333.3	9	0.3333	300	5321	1
11ac80MIMO	5530	Type6	16	1	333.3	9	0.3333	300	5613	1
11ac80MIMO	5530	Type6	16	1	333.3	9	0.3333	300	5609	1
11ac80MIMO	5530	Type6	16	1	333.3	9	0.3333	300	5642	1
11ac80MIMO	5530	Type6	16	1	333.3	9	0.3333	300	5678	1
11ac80MIMO	5530	Type6	16	1	333.3	9	0.3333	300	5478	1
11ac80MIMO	5530	Type6	16	1	333.3	9	0.3333	300	5486	1
11ac80MIMO	5530	Type6	16	1	333.3	9	0.3333	300	5296	1
11ac80MIMO	5530	Type6	16	1	333.3	9	0.3333	300	5608	1
11ac80MIMO	5530	Type6	16	1	333.3	9	0.3333	300	5624	1
11ac80MIMO	5530	Type6	16	1	333.3	9	0.3333	300	5524	1
11ac80MIMO	5530	Type6	16	1	333.3	9	0.3333	300	5438	1
11ac80MIMO	5530	Type6	16	1	333.3	9	0.3333	300	5364	1
11ac80MIMO	5530	Type6	16	1	333.3	9	0.3333	300	5580	1
11ac80MIMO	5530	Type6	16	1	333.3	9	0.3333	300	5470	1
11ac80MIMO	5530	Type6	16	1	333.3	9	0.3333	300	5606	1
11ac80MIMO	5530	Type6	16	1	333.3	9	0.3333	300	5325	1
11ac80MIMO	5530	Type6	16	1	333.3	9	0.3333	300	5555	1
11ac80MIMO	5530	Type6	16	1	333.3	9	0.3333	300	5489	1
11ac80MIMO	5530	Type6	16	1	333.3	9	0.3333	300	5375	1
11ac80MIMO	5530	Type6	16	1	333.3	9	0.3333	300	5480	1
11ac80MIMO	5530	Type6	16	1	333.3	9	0.3333	300	5674	1
11ac80MIMO	5530	Type6	16	1	333.3	9	0.3333	300	5663	1
11ac80MIMO	5530	Type6	16	1	333.3	9	0.3333	300	5282	1
11ac80MIMO	5530	Type6	16	1	333.3	9	0.3333	300	5573	1
11ac40MIMO	5510	Type6	16	1	333.3	9	0.3333	300	5256	1
11ac40MIMO	5510	Type6	16	1	333.3	9	0.3333	300	5460	1



Unless otherwise agreed in writing, this document is issued by the Company subject to its General Conditions of Service printed overleaf, available on request or accessible at <http://www.sgs.com/en/Terms-and-Conditions.aspx> and, for electronic format documents, subject to Terms and Conditions for Electronic Documents at <http://www.sgs.com/en/Terms-and-Conditions/Terms-e-Documents.aspx>. Attention is drawn to the limitation of liability, indemnification and jurisdiction issues defined therein. Any holder of this document is advised that information contained herein reflects the Company's findings at the time of its intervention only and within the limits of Client's instructions, if any. The Company's sole responsibility is to its Client and this document does not exonerate parties to a transaction from exercising all their rights and obligations under the transaction documents. This document cannot be reproduced except in full, without prior written approval of the Company. Any unauthorized alteration, forgery or falsification of the content or appearance of this document is unlawful and offenders may be prosecuted to the fullest extent of the law. Unless otherwise stated the results shown in this test report refer only to the sample(s) tested and such sample(s) are retained for 30 days only.

Attention: To check the authenticity of testing/inspection report & certificate, please contact us at telephone: (86-755) 8307 1443, or email: [CN.Doccheck@sgs.com](mailto:CN.Doccheck@sgs.com)

SGS-CSTC Standards Technical Services (Xi'an) Co., Ltd. | 1/F Unit D, Building 1, Kanglong Orange Science Park, No.137, Keyuan 3rd Road, Fengyang New Town, Xian, Shaanxi, China | 710086 | T (86-29) 6282 7885 | [www.sgs.com.cn](http://www.sgs.com.cn)  
 中国·西安·沣东新城科里三路137号康隆橙方科技园1号楼D单元1层 | 邮编: 710086 | T (86-29) 6282 7885 | [sgs.china@sgs.com](mailto:sgs.china@sgs.com)



11ac40MIMO	5510	Type6	16	1	333.3	9	0.3333	300	5260	1
11ac40MIMO	5510	Type6	16	1	333.3	9	0.3333	300	5615	1
11ac40MIMO	5510	Type6	16	1	333.3	9	0.3333	300	5570	1
11ac40MIMO	5510	Type6	16	1	333.3	9	0.3333	300	5422	1
11ac40MIMO	5510	Type6	16	1	333.3	9	0.3333	300	5311	1
11ac40MIMO	5510	Type6	16	1	333.3	9	0.3333	300	5410	1
11ac40MIMO	5510	Type6	16	1	333.3	9	0.3333	300	5348	1
11ac40MIMO	5510	Type6	16	1	333.3	9	0.3333	300	5567	1
11ac40MIMO	5510	Type6	16	1	333.3	9	0.3333	300	5561	1
11ac40MIMO	5510	Type6	16	1	333.3	9	0.3333	300	5273	1
11ac40MIMO	5510	Type6	16	1	333.3	9	0.3333	300	5667	1
11ac40MIMO	5510	Type6	16	1	333.3	9	0.3333	300	5426	1
11ac40MIMO	5510	Type6	16	1	333.3	9	0.3333	300	5449	1
11ac40MIMO	5510	Type6	16	1	333.3	9	0.3333	300	5691	1
11ac40MIMO	5510	Type6	16	1	333.3	9	0.3333	300	5382	1
11ac40MIMO	5510	Type6	16	1	333.3	9	0.3333	300	5703	1
11ac40MIMO	5510	Type6	16	1	333.3	9	0.3333	300	5339	1
11ac40MIMO	5510	Type6	16	1	333.3	9	0.3333	300	5396	1
11ac40MIMO	5510	Type6	16	1	333.3	9	0.3333	300	5279	1
11ac40MIMO	5510	Type6	16	1	333.3	9	0.3333	300	5670	1
11ac40MIMO	5510	Type6	16	1	333.3	9	0.3333	300	5353	1
11ac40MIMO	5510	Type6	16	1	333.3	9	0.3333	300	5479	1
11ac40MIMO	5510	Type6	16	1	333.3	9	0.3333	300	5454	1
11ac40MIMO	5510	Type6	16	1	333.3	9	0.3333	300	5557	1
11ac40MIMO	5510	Type6	16	1	333.3	9	0.3333	300	5492	1
11ac40MIMO	5510	Type6	16	1	333.3	9	0.3333	300	5488	1
11ac40MIMO	5510	Type6	16	1	333.3	9	0.3333	300	5584	1
11ac40MIMO	5510	Type6	16	1	333.3	9	0.3333	300	5313	1
11ac40MIMO	5510	Type6	16	1	333.3	9	0.3333	300	5645	1
11ac40MIMO	5510	Type6	16	1	333.3	9	0.3333	300	5525	1
11ac40MIMO	5510	Type6	16	1	333.3	9	0.3333	300	5283	1
11ac40MIMO	5510	Type6	16	1	333.3	9	0.3333	300	5487	1
11ac40MIMO	5510	Type6	16	1	333.3	9	0.3333	300	5685	1
11ac40MIMO	5510	Type6	16	1	333.3	9	0.3333	300	5534	1
11ac40MIMO	5510	Type6	16	1	333.3	9	0.3333	300	5341	1
11ac40MIMO	5510	Type6	16	1	333.3	9	0.3333	300	5599	1
11ac40MIMO	5510	Type6	16	1	333.3	9	0.3333	300	5377	1
11ac40MIMO	5510	Type6	16	1	333.3	9	0.3333	300	5413	1
11ac40MIMO	5510	Type6	16	1	333.3	9	0.3333	300	5671	1
11ac40MIMO	5510	Type6	16	1	333.3	9	0.3333	300	5335	1
11ac40MIMO	5510	Type6	16	1	333.3	9	0.3333	300	5360	1
11ac40MIMO	5510	Type6	16	1	333.3	9	0.3333	300	5379	1
11ac40MIMO	5510	Type6	16	1	333.3	9	0.3333	300	5591	1
11ac40MIMO	5510	Type6	16	1	333.3	9	0.3333	300	5444	1
11ac40MIMO	5510	Type6	16	1	333.3	9	0.3333	300	5411	1
11ac40MIMO	5510	Type6	16	1	333.3	9	0.3333	300	5705	1
11ac40MIMO	5510	Type6	16	1	333.3	9	0.3333	300	5668	1
11ac40MIMO	5510	Type6	16	1	333.3	9	0.3333	300	5258	1
11ac40MIMO	5510	Type6	16	1	333.3	9	0.3333	300	5457	1
11ac40MIMO	5510	Type6	16	1	333.3	9	0.3333	300	5514	1
11ac40MIMO	5510	Type6	16	1	333.3	9	0.3333	300	5289	1
11ac40MIMO	5510	Type6	16	1	333.3	9	0.3333	300	5334	1
11ac40MIMO	5510	Type6	16	1	333.3	9	0.3333	300	5604	1



Unless otherwise agreed in writing, this document is issued by the Company subject to its General Conditions of Service printed overleaf, available on request or accessible at <http://www.sgs.com/en/Terms-and-Conditions.aspx> and, for electronic format documents, subject to Terms and Conditions for Electronic Documents at <http://www.sgs.com/en/Terms-and-Conditions/Terms-e-Document.aspx>. Attention is drawn to the limitation of liability, indemnification and jurisdiction issues defined therein. Any holder of this document is advised that information contained herein reflects the Company's findings at the time of its intervention only and within the limits of Client's instructions, if any. The Company's sole responsibility is to its Client and this document does not exonerate parties to a transaction from exercising all their rights and obligations under the transaction documents. This document cannot be reproduced except in full, without prior written approval of the Company. Any unauthorized alteration, forgery or falsification of the content or appearance of this document is unlawful and offenders may be prosecuted to the fullest extent of the law. Unless otherwise stated the results shown in this test report refer only to the sample(s) tested and such sample(s) are retained for 30 days only.

Attention: To check the authenticity of testing/inspection report & certificate, please contact us at telephone: (86-755) 8307 1443, or email: [CN.Doccheck@sgs.com](mailto:CN.Doccheck@sgs.com)

SGS-CSTC Standards Technical Services (Xi'an) Co., Ltd. | 1/E Unit D, Building 1, Kanglong Orange Science Park, No.137, Keyuan 3rd Road, Fengyang New Town, Xi'an, Shaanxi, China | 710086 | t (86-29) 6282 7885 | www.sgs.com.cn  
 中国·西安·沣东新城科里三路137号康鸿橙方科技园1号楼D单元1层 | 邮编: 710086 | t (86-29) 6282 7885 | sgs.china@sgs.com



11ac40MIMO	5510	Type6	16	1	333.3	9	0.3333	300	5408	1
11ac40MIMO	5510	Type6	16	1	333.3	9	0.3333	300	5357	1
11ac40MIMO	5510	Type6	16	1	333.3	9	0.3333	300	5603	1
11ac40MIMO	5510	Type6	16	1	333.3	9	0.3333	300	5263	1
11ac40MIMO	5510	Type6	16	1	333.3	9	0.3333	300	5655	1
11ac40MIMO	5510	Type6	16	1	333.3	9	0.3333	300	5548	1
11ac40MIMO	5510	Type6	16	1	333.3	9	0.3333	300	5551	1
11ac40MIMO	5510	Type6	16	1	333.3	9	0.3333	300	5269	1
11ac40MIMO	5510	Type6	16	1	333.3	9	0.3333	300	5383	1
11ac40MIMO	5510	Type6	16	1	333.3	9	0.3333	300	5715	1
11ac40MIMO	5510	Type6	16	1	333.3	9	0.3333	300	5527	1
11ac40MIMO	5510	Type6	16	1	333.3	9	0.3333	300	5466	1
11ac40MIMO	5510	Type6	16	1	333.3	9	0.3333	300	5640	1
11ac40MIMO	5510	Type6	16	1	333.3	9	0.3333	300	5600	1
11ac40MIMO	5510	Type6	16	1	333.3	9	0.3333	300	5508	1
11ac40MIMO	5510	Type6	16	1	333.3	9	0.3333	300	5576	1
11ac40MIMO	5510	Type6	16	1	333.3	9	0.3333	300	5651	1
11ac40MIMO	5510	Type6	16	1	333.3	9	0.3333	300	5450	1
11ac40MIMO	5510	Type6	16	1	333.3	9	0.3333	300	5669	1
11ac40MIMO	5510	Type6	16	1	333.3	9	0.3333	300	5560	1
11ac40MIMO	5510	Type6	16	1	333.3	9	0.3333	300	5321	1
11ac40MIMO	5510	Type6	16	1	333.3	9	0.3333	300	5613	1
11ac40MIMO	5510	Type6	16	1	333.3	9	0.3333	300	5609	1
11ac40MIMO	5510	Type6	16	1	333.3	9	0.3333	300	5642	1
11ac40MIMO	5510	Type6	16	1	333.3	9	0.3333	300	5678	1
11ac40MIMO	5510	Type6	16	1	333.3	9	0.3333	300	5478	1
11ac40MIMO	5510	Type6	16	1	333.3	9	0.3333	300	5486	1
11ac40MIMO	5510	Type6	16	1	333.3	9	0.3333	300	5296	1
11ac40MIMO	5510	Type6	16	1	333.3	9	0.3333	300	5608	1
11ac40MIMO	5510	Type6	16	1	333.3	9	0.3333	300	5624	1
11ac40MIMO	5510	Type6	16	1	333.3	9	0.3333	300	5524	1
11ac40MIMO	5510	Type6	16	1	333.3	9	0.3333	300	5438	1
11ac40MIMO	5510	Type6	16	1	333.3	9	0.3333	300	5364	1
11ac40MIMO	5510	Type6	16	1	333.3	9	0.3333	300	5580	1
11ac40MIMO	5510	Type6	16	1	333.3	9	0.3333	300	5470	1
11ac40MIMO	5510	Type6	16	1	333.3	9	0.3333	300	5606	1
11ac40MIMO	5510	Type6	16	1	333.3	9	0.3333	300	5325	1
11ac40MIMO	5510	Type6	16	1	333.3	9	0.3333	300	5555	1
11ac40MIMO	5510	Type6	16	1	333.3	9	0.3333	300	5489	1
11ac40MIMO	5510	Type6	16	1	333.3	9	0.3333	300	5375	1
11ac40MIMO	5510	Type6	16	1	333.3	9	0.3333	300	5480	1
11ac40MIMO	5510	Type6	16	1	333.3	9	0.3333	300	5674	1
11ac40MIMO	5510	Type6	16	1	333.3	9	0.3333	300	5663	1
11ac40MIMO	5510	Type6	16	1	333.3	9	0.3333	300	5282	1
11ac40MIMO	5510	Type6	16	1	333.3	9	0.3333	300	5573	1
11ac20MIMO	5500	Type6	16	1	333.3	9	0.3333	300	5256	1
11ac20MIMO	5500	Type6	16	1	333.3	9	0.3333	300	5460	1
11ac20MIMO	5500	Type6	16	1	333.3	9	0.3333	300	5260	1
11ac20MIMO	5500	Type6	16	1	333.3	9	0.3333	300	5615	1
11ac20MIMO	5500	Type6	16	1	333.3	9	0.3333	300	5570	1
11ac20MIMO	5500	Type6	16	1	333.3	9	0.3333	300	5422	1
11ac20MIMO	5500	Type6	16	1	333.3	9	0.3333	300	5311	1
11ac20MIMO	5500	Type6	16	1	333.3	9	0.3333	300	5410	1



Unless otherwise agreed in writing, this document is issued by the Company subject to its General Conditions of Service printed overleaf, available on request or accessible at <http://www.sgs.com/en/Terms-and-Conditions.aspx> and, for electronic format documents, subject to Terms and Conditions for Electronic Documents at <http://www.sgs.com/en/Terms-and-Conditions/Terms-e-Documents.aspx>. Attention is drawn to the limitation of liability, indemnification and jurisdiction issues defined therein. Any holder of this document is advised that information contained herein reflects the Company's findings at the time of its intervention only and within the limits of Client's instructions, if any. The Company's sole responsibility is to its Client and this document does not exonerate parties to a transaction from exercising all their rights and obligations under the transaction documents. This document cannot be reproduced except in full, without prior written approval of the Company. Any unauthorized alteration, forgery or falsification of the content or appearance of this document is unlawful and offenders may be prosecuted to the fullest extent of the law. Unless otherwise stated the results shown in this test report refer only to the sample(s) tested and such sample(s) are retained for 30 days only.

Attention: To check the authenticity of testing/inspection report & certificate, please contact us at telephone: (86-755) 8307 1443, or email: [CN.Doccheck@sgs.com](mailto:CN.Doccheck@sgs.com)  
 (E) Unit D, Building 1, Kanglong Orange Science Park, No.157, Keyuan 3rd Road, Fengyang New Town, Xi'an, Shaanxi, China 710086  
 t (86-29) 6282 7885 www.sgs.com.cn  
 中国·西安·沣东新城科里三路157号康隆橙方科技园1号楼D单元1层 邮编: 710086 t (86-29) 6282 7885 sgs.china@sgs.com

11ac20MIMO	5500	Type6	16	1	333.3	9	0.3333	300	5348	1
11ac20MIMO	5500	Type6	16	1	333.3	9	0.3333	300	5567	1
11ac20MIMO	5500	Type6	16	1	333.3	9	0.3333	300	5561	1
11ac20MIMO	5500	Type6	16	1	333.3	9	0.3333	300	5273	1
11ac20MIMO	5500	Type6	16	1	333.3	9	0.3333	300	5667	1
11ac20MIMO	5500	Type6	16	1	333.3	9	0.3333	300	5426	1
11ac20MIMO	5500	Type6	16	1	333.3	9	0.3333	300	5449	1
11ac20MIMO	5500	Type6	16	1	333.3	9	0.3333	300	5691	1
11ac20MIMO	5500	Type6	16	1	333.3	9	0.3333	300	5382	1
11ac20MIMO	5500	Type6	16	1	333.3	9	0.3333	300	5703	1
11ac20MIMO	5500	Type6	16	1	333.3	9	0.3333	300	5339	1
11ac20MIMO	5500	Type6	16	1	333.3	9	0.3333	300	5396	1
11ac20MIMO	5500	Type6	16	1	333.3	9	0.3333	300	5279	1
11ac20MIMO	5500	Type6	16	1	333.3	9	0.3333	300	5670	1
11ac20MIMO	5500	Type6	16	1	333.3	9	0.3333	300	5353	1
11ac20MIMO	5500	Type6	16	1	333.3	9	0.3333	300	5479	1
11ac20MIMO	5500	Type6	16	1	333.3	9	0.3333	300	5454	1
11ac20MIMO	5500	Type6	16	1	333.3	9	0.3333	300	5557	1
11ac20MIMO	5500	Type6	16	1	333.3	9	0.3333	300	5492	1
11ac20MIMO	5500	Type6	16	1	333.3	9	0.3333	300	5488	1
11ac20MIMO	5500	Type6	16	1	333.3	9	0.3333	300	5584	1
11ac20MIMO	5500	Type6	16	1	333.3	9	0.3333	300	5313	1
11ac20MIMO	5500	Type6	16	1	333.3	9	0.3333	300	5645	1
11ac20MIMO	5500	Type6	16	1	333.3	9	0.3333	300	5525	1
11ac20MIMO	5500	Type6	16	1	333.3	9	0.3333	300	5283	1
11ac20MIMO	5500	Type6	16	1	333.3	9	0.3333	300	5487	1
11ac20MIMO	5500	Type6	16	1	333.3	9	0.3333	300	5685	1
11ac20MIMO	5500	Type6	16	1	333.3	9	0.3333	300	5534	1
11ac20MIMO	5500	Type6	16	1	333.3	9	0.3333	300	5341	1
11ac20MIMO	5500	Type6	16	1	333.3	9	0.3333	300	5599	1
11ac20MIMO	5500	Type6	16	1	333.3	9	0.3333	300	5377	1
11ac20MIMO	5500	Type6	16	1	333.3	9	0.3333	300	5413	1
11ac20MIMO	5500	Type6	16	1	333.3	9	0.3333	300	5671	1
11ac20MIMO	5500	Type6	16	1	333.3	9	0.3333	300	5335	1
11ac20MIMO	5500	Type6	16	1	333.3	9	0.3333	300	5360	1
11ac20MIMO	5500	Type6	16	1	333.3	9	0.3333	300	5379	1
11ac20MIMO	5500	Type6	16	1	333.3	9	0.3333	300	5591	1
11ac20MIMO	5500	Type6	16	1	333.3	9	0.3333	300	5444	1
11ac20MIMO	5500	Type6	16	1	333.3	9	0.3333	300	5411	1
11ac20MIMO	5500	Type6	16	1	333.3	9	0.3333	300	5705	1
11ac20MIMO	5500	Type6	16	1	333.3	9	0.3333	300	5668	1
11ac20MIMO	5500	Type6	16	1	333.3	9	0.3333	300	5258	1
11ac20MIMO	5500	Type6	16	1	333.3	9	0.3333	300	5457	1
11ac20MIMO	5500	Type6	16	1	333.3	9	0.3333	300	5514	1
11ac20MIMO	5500	Type6	16	1	333.3	9	0.3333	300	5289	1
11ac20MIMO	5500	Type6	16	1	333.3	9	0.3333	300	5334	1
11ac20MIMO	5500	Type6	16	1	333.3	9	0.3333	300	5604	1
11ac20MIMO	5500	Type6	16	1	333.3	9	0.3333	300	5408	1
11ac20MIMO	5500	Type6	16	1	333.3	9	0.3333	300	5357	1
11ac20MIMO	5500	Type6	16	1	333.3	9	0.3333	300	5603	1
11ac20MIMO	5500	Type6	16	1	333.3	9	0.3333	300	5263	1
11ac20MIMO	5500	Type6	16	1	333.3	9	0.3333	300	5655	1
11ac20MIMO	5500	Type6	16	1	333.3	9	0.3333	300	5548	1



Unless otherwise agreed in writing, this document is issued by the Company subject to its General Conditions of Service printed overleaf, available on request or accessible at <http://www.sgs.com/en/Terms-and-Conditions.aspx> and, for electronic format documents, subject to Terms and Conditions for Electronic Documents at <http://www.sgs.com/en/Terms-and-Conditions/Terms-e-Documents.aspx>. Attention is drawn to the limitation of liability, indemnification and jurisdiction issues defined therein. Any holder of this document is advised that information contained herein reflects the Company's findings at the time of its intervention only and within the limits of Client's instructions, if any. The Company's sole responsibility is to its Client and this document does not exonerate parties to a transaction from exercising all their rights and obligations under the transaction documents. This document cannot be reproduced except in full, without prior written approval of the Company. Any unauthorized alteration, forgery or falsification of the content or appearance of this document is unlawful and offenders may be prosecuted to the fullest extent of the law. Unless otherwise stated the results shown in this test report refer only to the sample(s) tested and such sample(s) are retained for 30 days only.

Attention: To check the authenticity of testing/inspection report & certificate, please contact us at telephone: (86-755) 8307 1443, or email: [CN.Doccheck@sgs.com](mailto:CN.Doccheck@sgs.com)

SGS-CSTC Standards Technical Services (Xi'an) Co., Ltd. | 1/F, Unit D, Building 1, Kanglong Orange Science Park, No.137, Keyuan 3rd Road, Fengyang New Town, Xi'an, Shaanxi, China | 710086 | t: (86-29) 6282 7885 | [www.sgs.com](http://www.sgs.com)  
 中国·西安·沣东新城科里三路137号康隆橙方科技园1号楼D单元1层 | 邮编: 710086 | t: (86-29) 6282 7885 | [sgs.china@sgs.com](mailto:sgs.china@sgs.com)

Report No.: XEWA2310000070RG05

Rev.: 01

Page: 189 of 267

11ac20MIMO	5500	Type6	16	1	333.3	9	0.3333	300	5551	1
11ac20MIMO	5500	Type6	16	1	333.3	9	0.3333	300	5269	1
11ac20MIMO	5500	Type6	16	1	333.3	9	0.3333	300	5383	1
11ac20MIMO	5500	Type6	16	1	333.3	9	0.3333	300	5715	1
11ac20MIMO	5500	Type6	16	1	333.3	9	0.3333	300	5527	1
11ac20MIMO	5500	Type6	16	1	333.3	9	0.3333	300	5466	1
11ac20MIMO	5500	Type6	16	1	333.3	9	0.3333	300	5640	1
11ac20MIMO	5500	Type6	16	1	333.3	9	0.3333	300	5600	1
11ac20MIMO	5500	Type6	16	1	333.3	9	0.3333	300	5508	1
11ac20MIMO	5500	Type6	16	1	333.3	9	0.3333	300	5576	1
11ac20MIMO	5500	Type6	16	1	333.3	9	0.3333	300	5651	1
11ac20MIMO	5500	Type6	16	1	333.3	9	0.3333	300	5450	1
11ac20MIMO	5500	Type6	16	1	333.3	9	0.3333	300	5669	1
11ac20MIMO	5500	Type6	16	1	333.3	9	0.3333	300	5560	1
11ac20MIMO	5500	Type6	16	1	333.3	9	0.3333	300	5321	1
11ac20MIMO	5500	Type6	16	1	333.3	9	0.3333	300	5613	1
11ac20MIMO	5500	Type6	16	1	333.3	9	0.3333	300	5609	1
11ac20MIMO	5500	Type6	16	1	333.3	9	0.3333	300	5642	1
11ac20MIMO	5500	Type6	16	1	333.3	9	0.3333	300	5678	1
11ac20MIMO	5500	Type6	16	1	333.3	9	0.3333	300	5478	1
11ac20MIMO	5500	Type6	16	1	333.3	9	0.3333	300	5486	1
11ac20MIMO	5500	Type6	16	1	333.3	9	0.3333	300	5296	1
11ac20MIMO	5500	Type6	16	1	333.3	9	0.3333	300	5608	1
11ac20MIMO	5500	Type6	16	1	333.3	9	0.3333	300	5624	1
11ac20MIMO	5500	Type6	16	1	333.3	9	0.3333	300	5524	1
11ac20MIMO	5500	Type6	16	1	333.3	9	0.3333	300	5438	1
11ac20MIMO	5500	Type6	16	1	333.3	9	0.3333	300	5364	1
11ac20MIMO	5500	Type6	16	1	333.3	9	0.3333	300	5580	1
11ac20MIMO	5500	Type6	16	1	333.3	9	0.3333	300	5470	1
11ac20MIMO	5500	Type6	16	1	333.3	9	0.3333	300	5606	1
11ac20MIMO	5500	Type6	16	1	333.3	9	0.3333	300	5325	1
11ac20MIMO	5500	Type6	16	1	333.3	9	0.3333	300	5555	1
11ac20MIMO	5500	Type6	16	1	333.3	9	0.3333	300	5489	1
11ac20MIMO	5500	Type6	16	1	333.3	9	0.3333	300	5375	1
11ac20MIMO	5500	Type6	16	1	333.3	9	0.3333	300	5480	1
11ac20MIMO	5500	Type6	16	1	333.3	9	0.3333	300	5674	1
11ac20MIMO	5500	Type6	16	1	333.3	9	0.3333	300	5663	1
11ac20MIMO	5500	Type6	16	1	333.3	9	0.3333	300	5282	1
11ac20MIMO	5500	Type6	16	1	333.3	9	0.3333	300	5573	1



Unless otherwise agreed in writing, this document is issued by the Company subject to its General Conditions of Service printed overleaf, available on request or accessible at <http://www.sgs.com/en/Terms-and-Conditions.aspx> and, for electronic format documents, subject to Terms and Conditions for Electronic Documents at <http://www.sgs.com/en/Terms-and-Conditions/Terms-e-Documents.aspx>. Attention is drawn to the limitation of liability, indemnification and jurisdiction issues defined therein. Any holder of this document is advised that information contained herein reflects the Company's findings at the time of its intervention only and within the limits of Client's instructions, if any. The Company's sole responsibility is to its Client and this document does not exonerate parties to a transaction from exercising all their rights and obligations under the transaction documents. This document cannot be reproduced except in full, without prior written approval of the Company. Any unauthorized alteration, forgery or falsification of the content or appearance of this document is unlawful and offenders may be prosecuted to the fullest extent of the law. Unless otherwise stated the results shown in this test report refer only to the sample(s) tested and such sample(s) are retained for 30 days only.

Attention: To check the authenticity of testing/inspection report & certificate, please contact us at telephone: (86-755) 4307 1443, or email: [CN.Doccheck@sgs.com](mailto:CN.Doccheck@sgs.com)

SGS-CSTC Standards Technical Services (Xi'an) Co., Ltd. | 1/E Unit D, Building 1, Kanghong Orange Source Park, No.137, Kejian 3rd Road, Fengling New Town, Xi'an, Shaanxi, China | 710086 | t (86-29) 6282 7885 | www.sgs.com.cn  
 中国·西安·沣东新城科里三路137号康鸿橙方科技园1号楼D单元1层 | 邮编: 710086 | t (86-29) 6282 7885 | sgs.china@sgs.com

TestMode	Channel	Radar Type	Trial ID	Pulse width (μs)	PRI (μs)	Pulses per Hop	Hop Rate (kHz)	Hop Sequence Length(ms)	Center Frequency (MHz)	Detection (1: Yes; 0: No)
11ac80MIMO	5530	Type6	17	1	333.3	9	0.3333	300	5511	1
11ac80MIMO	5530	Type6	17	1	333.3	9	0.3333	300	5699	1
11ac80MIMO	5530	Type6	17	1	333.3	9	0.3333	300	5671	1
11ac80MIMO	5530	Type6	17	1	333.3	9	0.3333	300	5301	1
11ac80MIMO	5530	Type6	17	1	333.3	9	0.3333	300	5315	1
11ac80MIMO	5530	Type6	17	1	333.3	9	0.3333	300	5464	1
11ac80MIMO	5530	Type6	17	1	333.3	9	0.3333	300	5333	1
11ac80MIMO	5530	Type6	17	1	333.3	9	0.3333	300	5485	1
11ac80MIMO	5530	Type6	17	1	333.3	9	0.3333	300	5396	1
11ac80MIMO	5530	Type6	17	1	333.3	9	0.3333	300	5492	1
11ac80MIMO	5530	Type6	17	1	333.3	9	0.3333	300	5537	1
11ac80MIMO	5530	Type6	17	1	333.3	9	0.3333	300	5708	1
11ac80MIMO	5530	Type6	17	1	333.3	9	0.3333	300	5621	1
11ac80MIMO	5530	Type6	17	1	333.3	9	0.3333	300	5470	1
11ac80MIMO	5530	Type6	17	1	333.3	9	0.3333	300	5304	1
11ac80MIMO	5530	Type6	17	1	333.3	9	0.3333	300	5509	1
11ac80MIMO	5530	Type6	17	1	333.3	9	0.3333	300	5331	1
11ac80MIMO	5530	Type6	17	1	333.3	9	0.3333	300	5287	1
11ac80MIMO	5530	Type6	17	1	333.3	9	0.3333	300	5588	1
11ac80MIMO	5530	Type6	17	1	333.3	9	0.3333	300	5665	1
11ac80MIMO	5530	Type6	17	1	333.3	9	0.3333	300	5264	1
11ac80MIMO	5530	Type6	17	1	333.3	9	0.3333	300	5391	1
11ac80MIMO	5530	Type6	17	1	333.3	9	0.3333	300	5568	1
11ac80MIMO	5530	Type6	17	1	333.3	9	0.3333	300	5427	1
11ac80MIMO	5530	Type6	17	1	333.3	9	0.3333	300	5348	1
11ac80MIMO	5530	Type6	17	1	333.3	9	0.3333	300	5441	1
11ac80MIMO	5530	Type6	17	1	333.3	9	0.3333	300	5691	1
11ac80MIMO	5530	Type6	17	1	333.3	9	0.3333	300	5688	1
11ac80MIMO	5530	Type6	17	1	333.3	9	0.3333	300	5347	1
11ac80MIMO	5530	Type6	17	1	333.3	9	0.3333	300	5687	1
11ac80MIMO	5530	Type6	17	1	333.3	9	0.3333	300	5414	1
11ac80MIMO	5530	Type6	17	1	333.3	9	0.3333	300	5715	1
11ac80MIMO	5530	Type6	17	1	333.3	9	0.3333	300	5605	1
11ac80MIMO	5530	Type6	17	1	333.3	9	0.3333	300	5459	1
11ac80MIMO	5530	Type6	17	1	333.3	9	0.3333	300	5354	1
11ac80MIMO	5530	Type6	17	1	333.3	9	0.3333	300	5480	1
11ac80MIMO	5530	Type6	17	1	333.3	9	0.3333	300	5312	1
11ac80MIMO	5530	Type6	17	1	333.3	9	0.3333	300	5648	1
11ac80MIMO	5530	Type6	17	1	333.3	9	0.3333	300	5663	1
11ac80MIMO	5530	Type6	17	1	333.3	9	0.3333	300	5682	1
11ac80MIMO	5530	Type6	17	1	333.3	9	0.3333	300	5271	1
11ac80MIMO	5530	Type6	17	1	333.3	9	0.3333	300	5540	1
11ac80MIMO	5530	Type6	17	1	333.3	9	0.3333	300	5317	1
11ac80MIMO	5530	Type6	17	1	333.3	9	0.3333	300	5356	1
11ac80MIMO	5530	Type6	17	1	333.3	9	0.3333	300	5718	1
11ac80MIMO	5530	Type6	17	1	333.3	9	0.3333	300	5685	1
11ac80MIMO	5530	Type6	17	1	333.3	9	0.3333	300	5276	1
11ac80MIMO	5530	Type6	17	1	333.3	9	0.3333	300	5316	1
11ac80MIMO	5530	Type6	17	1	333.3	9	0.3333	300	5413	1



Unless otherwise agreed in writing, this document is issued by the Company subject to its General Conditions of Service printed overleaf, available on request or accessible at <http://www.sgs.com/en/Terms-and-Conditions.aspx> and, for electronic format documents, subject to Terms and Conditions for Electronic Documents at <http://www.sgs.com/en/Terms-and-Conditions/Terms-e-Documents.aspx>. Attention is drawn to the limitation of liability, indemnification and jurisdiction issues defined therein. Any holder of this document is advised that information contained herein reflects the Company's findings at the time of its intervention only and within the limits of Client's instructions, if any. The Company's sole responsibility is to its Client and this document does not exonerate parties to a transaction from exercising all their rights and obligations under the transaction documents. This document cannot be reproduced except in full, without prior written approval of the Company. Any unauthorized alteration, forgery or falsification of the content or appearance of this document is unlawful and offenders may be prosecuted to the fullest extent of the law. Unless otherwise stated the results shown in this test report refer only to the sample(s) tested and such sample(s) are retained for 30 days only.

Attention: To check the authenticity of testing/inspection report & certificate, please contact us at telephone: (86-755) 8307 1443, or email: [CN.Doccheck@sgs.com](mailto:CN.Doccheck@sgs.com)

SGS-CSTC Standards Technical Services (Xi'an) Co., Ltd. | 1/E Unit D, Building 1, Kanglong Orange Science Park, No.157, Keyuan3rd Road, Fengjing/Yue Town, Xi'an, Shaanxi, China | 710086 | t (86-29) 6282 7885 | www.sgs.com.cn  
 中国·西安·沣东新城科里三路157号康隆橙方科技园1号楼D单元1层 | 邮编: 710086 | t (86-29) 6282 7885 | sgs.china@sgs.com

11ac80MIMO	5530	Type6	17	1	333.3	9	0.3333	300	5640	1
11ac80MIMO	5530	Type6	17	1	333.3	9	0.3333	300	5510	1
11ac80MIMO	5530	Type6	17	1	333.3	9	0.3333	300	5655	1
11ac80MIMO	5530	Type6	17	1	333.3	9	0.3333	300	5497	1
11ac80MIMO	5530	Type6	17	1	333.3	9	0.3333	300	5558	1
11ac80MIMO	5530	Type6	17	1	333.3	9	0.3333	300	5450	1
11ac80MIMO	5530	Type6	17	1	333.3	9	0.3333	300	5599	1
11ac80MIMO	5530	Type6	17	1	333.3	9	0.3333	300	5692	1
11ac80MIMO	5530	Type6	17	1	333.3	9	0.3333	300	5370	1
11ac80MIMO	5530	Type6	17	1	333.3	9	0.3333	300	5367	1
11ac80MIMO	5530	Type6	17	1	333.3	9	0.3333	300	5522	1
11ac80MIMO	5530	Type6	17	1	333.3	9	0.3333	300	5434	1
11ac80MIMO	5530	Type6	17	1	333.3	9	0.3333	300	5328	1
11ac80MIMO	5530	Type6	17	1	333.3	9	0.3333	300	5547	1
11ac80MIMO	5530	Type6	17	1	333.3	9	0.3333	300	5353	1
11ac80MIMO	5530	Type6	17	1	333.3	9	0.3333	300	5412	1
11ac80MIMO	5530	Type6	17	1	333.3	9	0.3333	300	5366	1
11ac80MIMO	5530	Type6	17	1	333.3	9	0.3333	300	5549	1
11ac80MIMO	5530	Type6	17	1	333.3	9	0.3333	300	5544	1
11ac80MIMO	5530	Type6	17	1	333.3	9	0.3333	300	5408	1
11ac80MIMO	5530	Type6	17	1	333.3	9	0.3333	300	5446	1
11ac80MIMO	5530	Type6	17	1	333.3	9	0.3333	300	5253	1
11ac80MIMO	5530	Type6	17	1	333.3	9	0.3333	300	5266	1
11ac80MIMO	5530	Type6	17	1	333.3	9	0.3333	300	5546	1
11ac80MIMO	5530	Type6	17	1	333.3	9	0.3333	300	5421	1
11ac80MIMO	5530	Type6	17	1	333.3	9	0.3333	300	5462	1
11ac80MIMO	5530	Type6	17	1	333.3	9	0.3333	300	5355	1
11ac80MIMO	5530	Type6	17	1	333.3	9	0.3333	300	5481	1
11ac80MIMO	5530	Type6	17	1	333.3	9	0.3333	300	5719	1
11ac80MIMO	5530	Type6	17	1	333.3	9	0.3333	300	5659	1
11ac80MIMO	5530	Type6	17	1	333.3	9	0.3333	300	5633	1
11ac80MIMO	5530	Type6	17	1	333.3	9	0.3333	300	5499	1
11ac80MIMO	5530	Type6	17	1	333.3	9	0.3333	300	5552	1
11ac80MIMO	5530	Type6	17	1	333.3	9	0.3333	300	5297	1
11ac80MIMO	5530	Type6	17	1	333.3	9	0.3333	300	5521	1
11ac80MIMO	5530	Type6	17	1	333.3	9	0.3333	300	5280	1
11ac80MIMO	5530	Type6	17	1	333.3	9	0.3333	300	5438	1
11ac80MIMO	5530	Type6	17	1	333.3	9	0.3333	300	5681	1
11ac80MIMO	5530	Type6	17	1	333.3	9	0.3333	300	5543	1
11ac80MIMO	5530	Type6	17	1	333.3	9	0.3333	300	5565	1
11ac80MIMO	5530	Type6	17	1	333.3	9	0.3333	300	5474	1
11ac80MIMO	5530	Type6	17	1	333.3	9	0.3333	300	5279	1
11ac80MIMO	5530	Type6	17	1	333.3	9	0.3333	300	5608	1
11ac80MIMO	5530	Type6	17	1	333.3	9	0.3333	300	5375	1
11ac80MIMO	5530	Type6	17	1	333.3	9	0.3333	300	5619	1
11ac80MIMO	5530	Type6	17	1	333.3	9	0.3333	300	5712	1
11ac80MIMO	5530	Type6	17	1	333.3	9	0.3333	300	5523	1
11ac80MIMO	5530	Type6	17	1	333.3	9	0.3333	300	5257	1
11ac80MIMO	5530	Type6	17	1	333.3	9	0.3333	300	5541	1
11ac80MIMO	5530	Type6	17	1	333.3	9	0.3333	300	5507	1
11ac80MIMO	5530	Type6	17	1	333.3	9	0.3333	300	5261	1
11ac40MIMO	5510	Type6	17	1	333.3	9	0.3333	300	5511	1
11ac40MIMO	5510	Type6	17	1	333.3	9	0.3333	300	5699	1



Unless otherwise agreed in writing, this document is issued by the Company subject to its General Conditions of Service printed overleaf, available on request or accessible at <http://www.sgs.com/en/Terms-and-Conditions.aspx> and, for electronic format documents, subject to Terms and Conditions for Electronic Documents at <http://www.sgs.com/en/Terms-and-Conditions/Terms-e-Documents.aspx>. Attention is drawn to the limitation of liability, indemnification and jurisdiction issues defined therein. Any holder of this document is advised that information contained herein reflects the Company's findings at the time of its intervention only and within the limits of Client's instructions, if any. The Company's sole responsibility is to its Client and this document does not exonerate parties to a transaction from exercising all their rights and obligations under the transaction documents. This document cannot be reproduced except in full, without prior written approval of the Company. Any unauthorized alteration, forgery or falsification of the content or appearance of this document is unlawful and offenders may be prosecuted to the fullest extent of the law. Unless otherwise stated the results shown in this test report refer only to the sample(s) tested and such sample(s) are retained for 30 days only.

Attention: To check the authenticity of testing/inspection report & certificate, please contact us at telephone: (86-755) 8307 1443, or email: [CN.Doccheck@sgs.com](mailto:CN.Doccheck@sgs.com)  
 (E) Unit D, Building 1, Kanglong Orange Science Park, No.157, Keyuan 3rd Road, Fengjing/Yue Town, Xian, Shaanxi, China 710086  
 t (86-29) 6282 7885 www.sgs.com.cn  
 中国·西安·沣东新城科里三路157号康隆橙方科技园1号楼D单元1层 邮编: 710086 t (86-29) 6282 7885 sgs.china@sgs.com

11ac40MIMO	5510	Type6	17	1	333.3	9	0.3333	300	5671	1
11ac40MIMO	5510	Type6	17	1	333.3	9	0.3333	300	5301	1
11ac40MIMO	5510	Type6	17	1	333.3	9	0.3333	300	5315	1
11ac40MIMO	5510	Type6	17	1	333.3	9	0.3333	300	5464	1
11ac40MIMO	5510	Type6	17	1	333.3	9	0.3333	300	5333	1
11ac40MIMO	5510	Type6	17	1	333.3	9	0.3333	300	5485	1
11ac40MIMO	5510	Type6	17	1	333.3	9	0.3333	300	5396	1
11ac40MIMO	5510	Type6	17	1	333.3	9	0.3333	300	5492	1
11ac40MIMO	5510	Type6	17	1	333.3	9	0.3333	300	5537	1
11ac40MIMO	5510	Type6	17	1	333.3	9	0.3333	300	5708	1
11ac40MIMO	5510	Type6	17	1	333.3	9	0.3333	300	5621	1
11ac40MIMO	5510	Type6	17	1	333.3	9	0.3333	300	5470	1
11ac40MIMO	5510	Type6	17	1	333.3	9	0.3333	300	5304	1
11ac40MIMO	5510	Type6	17	1	333.3	9	0.3333	300	5509	1
11ac40MIMO	5510	Type6	17	1	333.3	9	0.3333	300	5331	1
11ac40MIMO	5510	Type6	17	1	333.3	9	0.3333	300	5287	1
11ac40MIMO	5510	Type6	17	1	333.3	9	0.3333	300	5588	1
11ac40MIMO	5510	Type6	17	1	333.3	9	0.3333	300	5665	1
11ac40MIMO	5510	Type6	17	1	333.3	9	0.3333	300	5264	1
11ac40MIMO	5510	Type6	17	1	333.3	9	0.3333	300	5391	1
11ac40MIMO	5510	Type6	17	1	333.3	9	0.3333	300	5568	1
11ac40MIMO	5510	Type6	17	1	333.3	9	0.3333	300	5427	1
11ac40MIMO	5510	Type6	17	1	333.3	9	0.3333	300	5348	1
11ac40MIMO	5510	Type6	17	1	333.3	9	0.3333	300	5441	1
11ac40MIMO	5510	Type6	17	1	333.3	9	0.3333	300	5691	1
11ac40MIMO	5510	Type6	17	1	333.3	9	0.3333	300	5688	1
11ac40MIMO	5510	Type6	17	1	333.3	9	0.3333	300	5347	1
11ac40MIMO	5510	Type6	17	1	333.3	9	0.3333	300	5687	1
11ac40MIMO	5510	Type6	17	1	333.3	9	0.3333	300	5414	1
11ac40MIMO	5510	Type6	17	1	333.3	9	0.3333	300	5715	1
11ac40MIMO	5510	Type6	17	1	333.3	9	0.3333	300	5605	1
11ac40MIMO	5510	Type6	17	1	333.3	9	0.3333	300	5459	1
11ac40MIMO	5510	Type6	17	1	333.3	9	0.3333	300	5354	1
11ac40MIMO	5510	Type6	17	1	333.3	9	0.3333	300	5480	1
11ac40MIMO	5510	Type6	17	1	333.3	9	0.3333	300	5312	1
11ac40MIMO	5510	Type6	17	1	333.3	9	0.3333	300	5648	1
11ac40MIMO	5510	Type6	17	1	333.3	9	0.3333	300	5663	1
11ac40MIMO	5510	Type6	17	1	333.3	9	0.3333	300	5682	1
11ac40MIMO	5510	Type6	17	1	333.3	9	0.3333	300	5271	1
11ac40MIMO	5510	Type6	17	1	333.3	9	0.3333	300	5540	1
11ac40MIMO	5510	Type6	17	1	333.3	9	0.3333	300	5317	1
11ac40MIMO	5510	Type6	17	1	333.3	9	0.3333	300	5356	1
11ac40MIMO	5510	Type6	17	1	333.3	9	0.3333	300	5718	1
11ac40MIMO	5510	Type6	17	1	333.3	9	0.3333	300	5685	1
11ac40MIMO	5510	Type6	17	1	333.3	9	0.3333	300	5276	1
11ac40MIMO	5510	Type6	17	1	333.3	9	0.3333	300	5316	1
11ac40MIMO	5510	Type6	17	1	333.3	9	0.3333	300	5413	1
11ac40MIMO	5510	Type6	17	1	333.3	9	0.3333	300	5640	1
11ac40MIMO	5510	Type6	17	1	333.3	9	0.3333	300	5510	1
11ac40MIMO	5510	Type6	17	1	333.3	9	0.3333	300	5655	1
11ac40MIMO	5510	Type6	17	1	333.3	9	0.3333	300	5497	1
11ac40MIMO	5510	Type6	17	1	333.3	9	0.3333	300	5558	1
11ac40MIMO	5510	Type6	17	1	333.3	9	0.3333	300	5450	1



Unless otherwise agreed in writing, this document is issued by the Company subject to its General Conditions of Service printed overleaf, available on request or accessible at <http://www.sgs.com/en/Terms-and-Conditions.aspx> and, for electronic format documents, subject to Terms and Conditions for Electronic Documents at <http://www.sgs.com/en/Terms-and-Conditions/Terms-e-Document.aspx>. Attention is drawn to the limitation of liability, indemnification and jurisdiction issues defined therein. Any holder of this document is advised that information contained herein reflects the Company's findings at the time of its intervention only and within the limits of Client's instructions, if any. The Company's sole responsibility is to its Client and this document does not exonerate parties to a transaction from exercising all their rights and obligations under the transaction documents. This document cannot be reproduced except in full, without prior written approval of the Company. Any unauthorized alteration, forgery or falsification of the content or appearance of this document is unlawful and offenders may be prosecuted to the fullest extent of the law. Unless otherwise stated the results shown in this test report refer only to the sample(s) tested and such sample(s) are retained for 30 days only.

Attention: To check the authenticity of testing/inspection report & certificate, please contact us at telephone: (86-755) 8307 1443, or email: [CN.Doccheck@sgs.com](mailto:CN.Doccheck@sgs.com)

SGS-CSTC Standards Technical Services (Xi'an) Co., Ltd. | 1/E Unit D, Building 1, Kanglong Orange Science Park, No.137, Keyuan 3rd Road, Fengjing/Yue Town, Xian, Shaanxi, China | 710086 | t (86-29) 6282 7885 | [www.sgs.com](http://www.sgs.com)  
 中国·西安·沣东新城科里三路137号康隆橙方科技园1号楼D单元1层 | 邮编: 710086 | t (86-29) 6282 7885 | [sgs.china@sgs.com](mailto:sgs.china@sgs.com)





Table with 11 columns: Item ID, Value, Type, and various numerical parameters. Rows include items like 11ac40MIMO and 11ac20MIMO.



Unless otherwise agreed in writing, this document is issued by the Company subject to its General Conditions of Service printed overleaf, available on request or accessible at http://www.sgs.com/en/Terms-and-Conditions.aspx and, for electronic format documents, subject to Terms and Conditions for Electronic Documents at http://www.sgs.com/en/Terms-and-Conditions/Terms-e-Documents.aspx. Attention is drawn to the limitation of liability, indemnification and jurisdiction issues defined therein. Any holder of this document is advised that information contained herein reflects the Company's findings at the time of its intervention only and within the limits of Client's instructions, if any. The Company's sole responsibility is to its Client and this document does not exonerate parties to a transaction from exercising all their rights and obligations under the transaction documents. This document cannot be reproduced except in full, without prior written approval of the Company. Any unauthorized alteration, forgery or falsification of the content or appearance of this document is unlawful and offenders may be prosecuted to the fullest extent of the law. Unless otherwise stated the results shown in this test report refer only to the sample(s) tested and such sample(s) are retained for 30 days only. Attention: To check the authenticity of testing/inspection report & certificate, please contact us at telephone: (86-755) 8307 1443, or email: CN\_Doccheck@sgs.com

11ac20MIMO	5500	Type6	17	1	333.3	9	0.3333	300	5396	1
11ac20MIMO	5500	Type6	17	1	333.3	9	0.3333	300	5492	1
11ac20MIMO	5500	Type6	17	1	333.3	9	0.3333	300	5537	1
11ac20MIMO	5500	Type6	17	1	333.3	9	0.3333	300	5708	1
11ac20MIMO	5500	Type6	17	1	333.3	9	0.3333	300	5621	1
11ac20MIMO	5500	Type6	17	1	333.3	9	0.3333	300	5470	1
11ac20MIMO	5500	Type6	17	1	333.3	9	0.3333	300	5304	1
11ac20MIMO	5500	Type6	17	1	333.3	9	0.3333	300	5509	1
11ac20MIMO	5500	Type6	17	1	333.3	9	0.3333	300	5331	1
11ac20MIMO	5500	Type6	17	1	333.3	9	0.3333	300	5287	1
11ac20MIMO	5500	Type6	17	1	333.3	9	0.3333	300	5588	1
11ac20MIMO	5500	Type6	17	1	333.3	9	0.3333	300	5665	1
11ac20MIMO	5500	Type6	17	1	333.3	9	0.3333	300	5264	1
11ac20MIMO	5500	Type6	17	1	333.3	9	0.3333	300	5391	1
11ac20MIMO	5500	Type6	17	1	333.3	9	0.3333	300	5568	1
11ac20MIMO	5500	Type6	17	1	333.3	9	0.3333	300	5427	1
11ac20MIMO	5500	Type6	17	1	333.3	9	0.3333	300	5348	1
11ac20MIMO	5500	Type6	17	1	333.3	9	0.3333	300	5441	1
11ac20MIMO	5500	Type6	17	1	333.3	9	0.3333	300	5691	1
11ac20MIMO	5500	Type6	17	1	333.3	9	0.3333	300	5688	1
11ac20MIMO	5500	Type6	17	1	333.3	9	0.3333	300	5347	1
11ac20MIMO	5500	Type6	17	1	333.3	9	0.3333	300	5687	1
11ac20MIMO	5500	Type6	17	1	333.3	9	0.3333	300	5414	1
11ac20MIMO	5500	Type6	17	1	333.3	9	0.3333	300	5715	1
11ac20MIMO	5500	Type6	17	1	333.3	9	0.3333	300	5605	1
11ac20MIMO	5500	Type6	17	1	333.3	9	0.3333	300	5459	1
11ac20MIMO	5500	Type6	17	1	333.3	9	0.3333	300	5354	1
11ac20MIMO	5500	Type6	17	1	333.3	9	0.3333	300	5480	1
11ac20MIMO	5500	Type6	17	1	333.3	9	0.3333	300	5312	1
11ac20MIMO	5500	Type6	17	1	333.3	9	0.3333	300	5648	1
11ac20MIMO	5500	Type6	17	1	333.3	9	0.3333	300	5663	1
11ac20MIMO	5500	Type6	17	1	333.3	9	0.3333	300	5682	1
11ac20MIMO	5500	Type6	17	1	333.3	9	0.3333	300	5271	1
11ac20MIMO	5500	Type6	17	1	333.3	9	0.3333	300	5540	1
11ac20MIMO	5500	Type6	17	1	333.3	9	0.3333	300	5317	1
11ac20MIMO	5500	Type6	17	1	333.3	9	0.3333	300	5356	1
11ac20MIMO	5500	Type6	17	1	333.3	9	0.3333	300	5718	1
11ac20MIMO	5500	Type6	17	1	333.3	9	0.3333	300	5685	1
11ac20MIMO	5500	Type6	17	1	333.3	9	0.3333	300	5276	1
11ac20MIMO	5500	Type6	17	1	333.3	9	0.3333	300	5316	1
11ac20MIMO	5500	Type6	17	1	333.3	9	0.3333	300	5413	1
11ac20MIMO	5500	Type6	17	1	333.3	9	0.3333	300	5640	1
11ac20MIMO	5500	Type6	17	1	333.3	9	0.3333	300	5510	1
11ac20MIMO	5500	Type6	17	1	333.3	9	0.3333	300	5655	1
11ac20MIMO	5500	Type6	17	1	333.3	9	0.3333	300	5497	1
11ac20MIMO	5500	Type6	17	1	333.3	9	0.3333	300	5558	1
11ac20MIMO	5500	Type6	17	1	333.3	9	0.3333	300	5450	1
11ac20MIMO	5500	Type6	17	1	333.3	9	0.3333	300	5599	1
11ac20MIMO	5500	Type6	17	1	333.3	9	0.3333	300	5692	1
11ac20MIMO	5500	Type6	17	1	333.3	9	0.3333	300	5370	1
11ac20MIMO	5500	Type6	17	1	333.3	9	0.3333	300	5367	1
11ac20MIMO	5500	Type6	17	1	333.3	9	0.3333	300	5522	1
11ac20MIMO	5500	Type6	17	1	333.3	9	0.3333	300	5434	1



Unless otherwise agreed in writing, this document is issued by the Company subject to its General Conditions of Service printed overleaf, available on request or accessible at <http://www.sgs.com/en/Terms-and-Conditions.aspx> and, for electronic format documents, subject to Terms and Conditions for Electronic Documents at <http://www.sgs.com/en/Terms-and-Conditions/Terms-e-Documents.aspx>. Attention is drawn to the limitation of liability, indemnification and jurisdiction issues defined therein. Any holder of this document is advised that information contained herein reflects the Company's findings at the time of its intervention only and within the limits of Client's instructions, if any. The Company's sole responsibility is to its Client and this document does not exonerate parties to a transaction from exercising all their rights and obligations under the transaction documents. This document cannot be reproduced except in full, without prior written approval of the Company. Any unauthorized alteration, forgery or falsification of the content or appearance of this document is unlawful and offenders may be prosecuted to the fullest extent of the law. Unless otherwise stated the results shown in this test report refer only to the sample(s) tested and such sample(s) are retained for 30 days only.

Attention: To check the authenticity of testing/inspection report & certificate, please contact us at telephone: (86-755) 8307 1443, or email: [CN.Doccheck@sgs.com](mailto:CN.Doccheck@sgs.com)

SGS-CSTC Standards Technical Services (Xi'an) Co., Ltd. | 1/F, Unit D, Building 1, Kanglong Orange Science Park, No.137, Keyuan 3rd Road, Fengtong/Wei Town, Xi'an, Shaanxi, China | 710086 | t (86-29) 6282 7885 | [www.sgs.com](http://www.sgs.com)  
 中国·西安·沣东新城科里三路137号康隆橙方科技园1号楼D单元1层 | 邮编: 710086 | t (86-29) 6282 7885 | [sgs.china@sgs.com](mailto:sgs.china@sgs.com)

Report No.: XEWA2310000070RG05

Rev.: 01

Page: 195 of 267

11ac20MIMO	5500	Type6	17	1	333.3	9	0.3333	300	5328	1
11ac20MIMO	5500	Type6	17	1	333.3	9	0.3333	300	5547	1
11ac20MIMO	5500	Type6	17	1	333.3	9	0.3333	300	5353	1
11ac20MIMO	5500	Type6	17	1	333.3	9	0.3333	300	5412	1
11ac20MIMO	5500	Type6	17	1	333.3	9	0.3333	300	5366	1
11ac20MIMO	5500	Type6	17	1	333.3	9	0.3333	300	5549	1
11ac20MIMO	5500	Type6	17	1	333.3	9	0.3333	300	5544	1
11ac20MIMO	5500	Type6	17	1	333.3	9	0.3333	300	5408	1
11ac20MIMO	5500	Type6	17	1	333.3	9	0.3333	300	5446	1
11ac20MIMO	5500	Type6	17	1	333.3	9	0.3333	300	5253	1
11ac20MIMO	5500	Type6	17	1	333.3	9	0.3333	300	5266	1
11ac20MIMO	5500	Type6	17	1	333.3	9	0.3333	300	5546	1
11ac20MIMO	5500	Type6	17	1	333.3	9	0.3333	300	5421	1
11ac20MIMO	5500	Type6	17	1	333.3	9	0.3333	300	5462	1
11ac20MIMO	5500	Type6	17	1	333.3	9	0.3333	300	5355	1
11ac20MIMO	5500	Type6	17	1	333.3	9	0.3333	300	5481	1
11ac20MIMO	5500	Type6	17	1	333.3	9	0.3333	300	5719	1
11ac20MIMO	5500	Type6	17	1	333.3	9	0.3333	300	5659	1
11ac20MIMO	5500	Type6	17	1	333.3	9	0.3333	300	5633	1
11ac20MIMO	5500	Type6	17	1	333.3	9	0.3333	300	5499	1
11ac20MIMO	5500	Type6	17	1	333.3	9	0.3333	300	5552	1
11ac20MIMO	5500	Type6	17	1	333.3	9	0.3333	300	5297	1
11ac20MIMO	5500	Type6	17	1	333.3	9	0.3333	300	5521	1
11ac20MIMO	5500	Type6	17	1	333.3	9	0.3333	300	5280	1
11ac20MIMO	5500	Type6	17	1	333.3	9	0.3333	300	5438	1
11ac20MIMO	5500	Type6	17	1	333.3	9	0.3333	300	5681	1
11ac20MIMO	5500	Type6	17	1	333.3	9	0.3333	300	5543	1
11ac20MIMO	5500	Type6	17	1	333.3	9	0.3333	300	5565	1
11ac20MIMO	5500	Type6	17	1	333.3	9	0.3333	300	5474	1
11ac20MIMO	5500	Type6	17	1	333.3	9	0.3333	300	5279	1
11ac20MIMO	5500	Type6	17	1	333.3	9	0.3333	300	5608	1
11ac20MIMO	5500	Type6	17	1	333.3	9	0.3333	300	5375	1
11ac20MIMO	5500	Type6	17	1	333.3	9	0.3333	300	5619	1
11ac20MIMO	5500	Type6	17	1	333.3	9	0.3333	300	5712	1
11ac20MIMO	5500	Type6	17	1	333.3	9	0.3333	300	5523	1
11ac20MIMO	5500	Type6	17	1	333.3	9	0.3333	300	5257	1
11ac20MIMO	5500	Type6	17	1	333.3	9	0.3333	300	5541	1
11ac20MIMO	5500	Type6	17	1	333.3	9	0.3333	300	5507	1
11ac20MIMO	5500	Type6	17	1	333.3	9	0.3333	300	5261	1



Unless otherwise agreed in writing, this document is issued by the Company subject to its General Conditions of Service printed overleaf, available on request or accessible at <http://www.sgs.com/en/Terms-and-Conditions.aspx> and, for electronic format documents, subject to Terms and Conditions for Electronic Documents at <http://www.sgs.com/en/Terms-and-Conditions/Terms-e-Documents.aspx>. Attention is drawn to the limitation of liability, indemnification and jurisdiction issues defined therein. Any holder of this document is advised that information contained herein reflects the Company's findings at the time of its intervention only and within the limits of Client's instructions, if any. The Company's sole responsibility is to its Client and this document does not exonerate parties to a transaction from exercising all their rights and obligations under the transaction documents. This document cannot be reproduced except in full, without prior written approval of the Company. Any unauthorized alteration, forgery or falsification of the content or appearance of this document is unlawful and offenders may be prosecuted to the fullest extent of the law. Unless otherwise stated the results shown in this test report refer only to the sample(s) tested and such sample(s) are retained for 30 days only.

Attention: To check the authenticity of testing/inspection report & certificate, please contact us at telephone: (86-755) 8307 1443, or email: [CN.Doccheck@sgs.com](mailto:CN.Doccheck@sgs.com)  
 (SGS-CSTC) Standards Technical Services (Xi'an) Co., Ltd. | 1 (86-29) 6282 7885 | [www.sgs.com.cn](http://www.sgs.com.cn)  
 中国·西安·沣东新城科星三路137号康鸿楼方科技园1号楼D单元1层 | 邮编: 710086 | 1 (86-29) 6282 7885 | [sgs.china@sgs.com](mailto:sgs.china@sgs.com)

TestMode	Channel	Radar Type	Trial ID	Pulse width (μs)	PRI (μs)	Pulses per Hop	Hop Rate (kHz)	Hop Sequence Length(ms)	Center Frequency (MHz)	Detection (1: Yes; 0: No)
11ac80MIMO	5530	Type6	18	1	333.3	9	0.3333	300	5291	1
11ac80MIMO	5530	Type6	18	1	333.3	9	0.3333	300	5463	1
11ac80MIMO	5530	Type6	18	1	333.3	9	0.3333	300	5607	1
11ac80MIMO	5530	Type6	18	1	333.3	9	0.3333	300	5462	1
11ac80MIMO	5530	Type6	18	1	333.3	9	0.3333	300	5632	1
11ac80MIMO	5530	Type6	18	1	333.3	9	0.3333	300	5603	1
11ac80MIMO	5530	Type6	18	1	333.3	9	0.3333	300	5258	1
11ac80MIMO	5530	Type6	18	1	333.3	9	0.3333	300	5560	1
11ac80MIMO	5530	Type6	18	1	333.3	9	0.3333	300	5674	1
11ac80MIMO	5530	Type6	18	1	333.3	9	0.3333	300	5326	1
11ac80MIMO	5530	Type6	18	1	333.3	9	0.3333	300	5274	1
11ac80MIMO	5530	Type6	18	1	333.3	9	0.3333	300	5341	1
11ac80MIMO	5530	Type6	18	1	333.3	9	0.3333	300	5491	1
11ac80MIMO	5530	Type6	18	1	333.3	9	0.3333	300	5392	1
11ac80MIMO	5530	Type6	18	1	333.3	9	0.3333	300	5636	1
11ac80MIMO	5530	Type6	18	1	333.3	9	0.3333	300	5434	1
11ac80MIMO	5530	Type6	18	1	333.3	9	0.3333	300	5332	1
11ac80MIMO	5530	Type6	18	1	333.3	9	0.3333	300	5305	1
11ac80MIMO	5530	Type6	18	1	333.3	9	0.3333	300	5673	1
11ac80MIMO	5530	Type6	18	1	333.3	9	0.3333	300	5430	1
11ac80MIMO	5530	Type6	18	1	333.3	9	0.3333	300	5400	1
11ac80MIMO	5530	Type6	18	1	333.3	9	0.3333	300	5711	1
11ac80MIMO	5530	Type6	18	1	333.3	9	0.3333	300	5293	1
11ac80MIMO	5530	Type6	18	1	333.3	9	0.3333	300	5419	1
11ac80MIMO	5530	Type6	18	1	333.3	9	0.3333	300	5317	1
11ac80MIMO	5530	Type6	18	1	333.3	9	0.3333	300	5381	1
11ac80MIMO	5530	Type6	18	1	333.3	9	0.3333	300	5254	1
11ac80MIMO	5530	Type6	18	1	333.3	9	0.3333	300	5303	1
11ac80MIMO	5530	Type6	18	1	333.3	9	0.3333	300	5672	1
11ac80MIMO	5530	Type6	18	1	333.3	9	0.3333	300	5345	1
11ac80MIMO	5530	Type6	18	1	333.3	9	0.3333	300	5611	1
11ac80MIMO	5530	Type6	18	1	333.3	9	0.3333	300	5649	1
11ac80MIMO	5530	Type6	18	1	333.3	9	0.3333	300	5619	1
11ac80MIMO	5530	Type6	18	1	333.3	9	0.3333	300	5403	1
11ac80MIMO	5530	Type6	18	1	333.3	9	0.3333	300	5541	1
11ac80MIMO	5530	Type6	18	1	333.3	9	0.3333	300	5596	1
11ac80MIMO	5530	Type6	18	1	333.3	9	0.3333	300	5585	1
11ac80MIMO	5530	Type6	18	1	333.3	9	0.3333	300	5623	1
11ac80MIMO	5530	Type6	18	1	333.3	9	0.3333	300	5633	1
11ac80MIMO	5530	Type6	18	1	333.3	9	0.3333	300	5438	1
11ac80MIMO	5530	Type6	18	1	333.3	9	0.3333	300	5647	1
11ac80MIMO	5530	Type6	18	1	333.3	9	0.3333	300	5665	1
11ac80MIMO	5530	Type6	18	1	333.3	9	0.3333	300	5359	1
11ac80MIMO	5530	Type6	18	1	333.3	9	0.3333	300	5374	1
11ac80MIMO	5530	Type6	18	1	333.3	9	0.3333	300	5466	1
11ac80MIMO	5530	Type6	18	1	333.3	9	0.3333	300	5666	1
11ac80MIMO	5530	Type6	18	1	333.3	9	0.3333	300	5516	1
11ac80MIMO	5530	Type6	18	1	333.3	9	0.3333	300	5589	1
11ac80MIMO	5530	Type6	18	1	333.3	9	0.3333	300	5706	1



Unless otherwise agreed in writing, this document is issued by the Company subject to its General Conditions of Service printed overleaf, available on request or accessible at <http://www.sgs.com/en/Terms-and-Conditions.aspx> and, for electronic format documents, subject to Terms and Conditions for Electronic Documents at <http://www.sgs.com/en/Terms-and-Conditions/Terms-e-Documents.aspx>. Attention is drawn to the limitation of liability, indemnification and jurisdiction issues defined therein. Any holder of this document is advised that information contained herein reflects the Company's findings at the time of its intervention only and within the limits of Client's instructions, if any. The Company's sole responsibility is to its Client and this document does not exonerate parties to a transaction from exercising all their rights and obligations under the transaction documents. This document cannot be reproduced except in full, without prior written approval of the Company. Any unauthorized alteration, forgery or falsification of the content or appearance of this document is unlawful and offenders may be prosecuted to the fullest extent of the law. Unless otherwise stated the results shown in this test report refer only to the sample(s) tested and such sample(s) are retained for 30 days only.

Attention: To check the authenticity of testing/inspection report & certificate, please contact us at telephone: (86-755) 8307 1443, or email: [CN.Doccheck@sgs.com](mailto:CN.Doccheck@sgs.com)

SGS-CSTC Standards Technical Services (Xi'an) Co., Ltd. | 1/E Unit D, Building 1, Kanglong Orange Science Park, No.157, Keyuan 3rd Road, Fengjing/Yue Town, Xi'an, Shaanxi, China | 710086 | t (86-29) 6282 7885 | www.sgs.com.cn  
 中国·西安·沣东新城科里三路157号康隆橙方科技园1号楼D单元1层 | 邮编: 710086 | t (86-29) 6282 7885 | sgs.china@sgs.com



Table with 11 columns: Sample ID, Weight, Type, Diameter, Length, Diameter, Length, Diameter, Length, Weight, and another weight. Rows contain data for various 11ac80MIMO and 11ac40MIMO samples.



Unless otherwise agreed in writing, this document is issued by the Company subject to its General Conditions of Service printed overleaf, available on request or accessible at http://www.sgs.com/en/Terms-and-Conditions.aspx and, for electronic format documents, subject to Terms and Conditions for Electronic Documents at http://www.sgs.com/en/Terms-and-Conditions/Terms-e-Document.aspx. Attention is drawn to the limitation of liability, indemnification and jurisdiction issues defined therein. Any holder of this document is advised that information contained herein reflects the Company's findings at the time of its intervention only and within the limits of Client's instructions, if any. The Company's sole responsibility is to its Client and this document does not exonerate parties to a transaction from exercising all their rights and obligations under the transaction documents. This document cannot be reproduced except in full, without prior written approval of the Company. Any unauthorized alteration, forgery or falsification of the content or appearance of this document is unlawful and offenders may be prosecuted to the fullest extent of the law. Unless otherwise stated the results shown in this test report refer only to the sample(s) tested and such sample(s) are retained for 30 days only. Attention: To check the authenticity of testing/inspection report & certificate, please contact us at telephone: (86-755) 8307 1443, or email: CN.Doccheck@sgs.com.
SGS-CSTC Standards Technical Services (Xi'an) Co., Ltd. | 1/E Unit D, Building 1, Kanglong Orange Science Park, No.137, Keyuan 3rd Road, Fengling/Wei Town, Xian, Shaanxi, China | 710086 | t (86-29) 6282 7885 | www.sgs.com.cn
中国·西安·沣东新城科里三路137号康隆橙方科技园1号楼D单元1层 | 邮编: 710086 | t (86-29) 6282 7885 | sgs.china@sgs.com

Report No.: XEWA2310000070RG05

Rev.: 01

Page: 198 of 267

11ac40MIMO	5510	Type6	18	1	333.3	9	0.3333	300	5607	1
11ac40MIMO	5510	Type6	18	1	333.3	9	0.3333	300	5462	1
11ac40MIMO	5510	Type6	18	1	333.3	9	0.3333	300	5632	1
11ac40MIMO	5510	Type6	18	1	333.3	9	0.3333	300	5603	1
11ac40MIMO	5510	Type6	18	1	333.3	9	0.3333	300	5258	1
11ac40MIMO	5510	Type6	18	1	333.3	9	0.3333	300	5560	1
11ac40MIMO	5510	Type6	18	1	333.3	9	0.3333	300	5674	1
11ac40MIMO	5510	Type6	18	1	333.3	9	0.3333	300	5326	1
11ac40MIMO	5510	Type6	18	1	333.3	9	0.3333	300	5274	1
11ac40MIMO	5510	Type6	18	1	333.3	9	0.3333	300	5341	1
11ac40MIMO	5510	Type6	18	1	333.3	9	0.3333	300	5491	1
11ac40MIMO	5510	Type6	18	1	333.3	9	0.3333	300	5392	1
11ac40MIMO	5510	Type6	18	1	333.3	9	0.3333	300	5636	1
11ac40MIMO	5510	Type6	18	1	333.3	9	0.3333	300	5434	1
11ac40MIMO	5510	Type6	18	1	333.3	9	0.3333	300	5332	1
11ac40MIMO	5510	Type6	18	1	333.3	9	0.3333	300	5305	1
11ac40MIMO	5510	Type6	18	1	333.3	9	0.3333	300	5673	1
11ac40MIMO	5510	Type6	18	1	333.3	9	0.3333	300	5430	1
11ac40MIMO	5510	Type6	18	1	333.3	9	0.3333	300	5400	1
11ac40MIMO	5510	Type6	18	1	333.3	9	0.3333	300	5711	1
11ac40MIMO	5510	Type6	18	1	333.3	9	0.3333	300	5293	1
11ac40MIMO	5510	Type6	18	1	333.3	9	0.3333	300	5419	1
11ac40MIMO	5510	Type6	18	1	333.3	9	0.3333	300	5317	1
11ac40MIMO	5510	Type6	18	1	333.3	9	0.3333	300	5381	1
11ac40MIMO	5510	Type6	18	1	333.3	9	0.3333	300	5254	1
11ac40MIMO	5510	Type6	18	1	333.3	9	0.3333	300	5303	1
11ac40MIMO	5510	Type6	18	1	333.3	9	0.3333	300	5672	1
11ac40MIMO	5510	Type6	18	1	333.3	9	0.3333	300	5345	1
11ac40MIMO	5510	Type6	18	1	333.3	9	0.3333	300	5611	1
11ac40MIMO	5510	Type6	18	1	333.3	9	0.3333	300	5649	1
11ac40MIMO	5510	Type6	18	1	333.3	9	0.3333	300	5619	1
11ac40MIMO	5510	Type6	18	1	333.3	9	0.3333	300	5403	1
11ac40MIMO	5510	Type6	18	1	333.3	9	0.3333	300	5541	1
11ac40MIMO	5510	Type6	18	1	333.3	9	0.3333	300	5596	1
11ac40MIMO	5510	Type6	18	1	333.3	9	0.3333	300	5585	1
11ac40MIMO	5510	Type6	18	1	333.3	9	0.3333	300	5623	1
11ac40MIMO	5510	Type6	18	1	333.3	9	0.3333	300	5633	1
11ac40MIMO	5510	Type6	18	1	333.3	9	0.3333	300	5438	1
11ac40MIMO	5510	Type6	18	1	333.3	9	0.3333	300	5647	1
11ac40MIMO	5510	Type6	18	1	333.3	9	0.3333	300	5665	1
11ac40MIMO	5510	Type6	18	1	333.3	9	0.3333	300	5359	1
11ac40MIMO	5510	Type6	18	1	333.3	9	0.3333	300	5374	1
11ac40MIMO	5510	Type6	18	1	333.3	9	0.3333	300	5466	1
11ac40MIMO	5510	Type6	18	1	333.3	9	0.3333	300	5666	1
11ac40MIMO	5510	Type6	18	1	333.3	9	0.3333	300	5516	1
11ac40MIMO	5510	Type6	18	1	333.3	9	0.3333	300	5589	1
11ac40MIMO	5510	Type6	18	1	333.3	9	0.3333	300	5706	1
11ac40MIMO	5510	Type6	18	1	333.3	9	0.3333	300	5586	1
11ac40MIMO	5510	Type6	18	1	333.3	9	0.3333	300	5394	1
11ac40MIMO	5510	Type6	18	1	333.3	9	0.3333	300	5312	1
11ac40MIMO	5510	Type6	18	1	333.3	9	0.3333	300	5646	1
11ac40MIMO	5510	Type6	18	1	333.3	9	0.3333	300	5661	1
11ac40MIMO	5510	Type6	18	1	333.3	9	0.3333	300	5493	1



Unless otherwise agreed in writing, this document is issued by the Company subject to its General Conditions of Service printed overleaf, available on request or accessible at <http://www.sgs.com/en/Terms-and-Conditions.aspx> and, for electronic format documents, subject to Terms and Conditions for Electronic Documents at <http://www.sgs.com/en/Terms-and-Conditions/Terms-e-Documents.aspx>. Attention is drawn to the limitation of liability, indemnification and jurisdiction issues defined therein. Any holder of this document is advised that information contained herein reflects the Company's findings at the time of its intervention only and within the limits of Client's instructions, if any. The Company's sole responsibility is to its Client and this document does not exonerate parties to a transaction from exercising all their rights and obligations under the transaction documents. This document cannot be reproduced except in full, without prior written approval of the Company. Any unauthorized alteration, forgery or falsification of the content or appearance of this document is unlawful and offenders may be prosecuted to the fullest extent of the law. Unless otherwise stated the results shown in this test report refer only to the sample(s) tested and such sample(s) are retained for 30 days only.

Attention: To check the authenticity of testing/inspection report & certificate, please contact us at telephone: (86-755) 8307 1443, or email: [CN.Doccheck@sgs.com](mailto:CN.Doccheck@sgs.com)  
 (E) Unit D, Building 1, Kanglong Orange Science Park, No.157, Keyuan 3rd Road, Fengyang New Town, Xian, Shaanxi, China 710086  
 t (86-29) 6282 7885 www.sgs.com.cn  
 中国·西安·沣东新城科里三路157号康隆橙方科技园1号楼D单元1层 邮编: 710086 t (86-29) 6282 7885 sgs.china@sgs.com

11ac40MIMO	5510	Type6	18	1	333.3	9	0.3333	300	5543	1
11ac40MIMO	5510	Type6	18	1	333.3	9	0.3333	300	5599	1
11ac40MIMO	5510	Type6	18	1	333.3	9	0.3333	300	5273	1
11ac40MIMO	5510	Type6	18	1	333.3	9	0.3333	300	5476	1
11ac40MIMO	5510	Type6	18	1	333.3	9	0.3333	300	5276	1
11ac40MIMO	5510	Type6	18	1	333.3	9	0.3333	300	5455	1
11ac40MIMO	5510	Type6	18	1	333.3	9	0.3333	300	5664	1
11ac40MIMO	5510	Type6	18	1	333.3	9	0.3333	300	5498	1
11ac40MIMO	5510	Type6	18	1	333.3	9	0.3333	300	5580	1
11ac40MIMO	5510	Type6	18	1	333.3	9	0.3333	300	5618	1
11ac40MIMO	5510	Type6	18	1	333.3	9	0.3333	300	5338	1
11ac40MIMO	5510	Type6	18	1	333.3	9	0.3333	300	5531	1
11ac40MIMO	5510	Type6	18	1	333.3	9	0.3333	300	5435	1
11ac40MIMO	5510	Type6	18	1	333.3	9	0.3333	300	5629	1
11ac40MIMO	5510	Type6	18	1	333.3	9	0.3333	300	5424	1
11ac40MIMO	5510	Type6	18	1	333.3	9	0.3333	300	5311	1
11ac40MIMO	5510	Type6	18	1	333.3	9	0.3333	300	5309	1
11ac40MIMO	5510	Type6	18	1	333.3	9	0.3333	300	5314	1
11ac40MIMO	5510	Type6	18	1	333.3	9	0.3333	300	5450	1
11ac40MIMO	5510	Type6	18	1	333.3	9	0.3333	300	5310	1
11ac40MIMO	5510	Type6	18	1	333.3	9	0.3333	300	5290	1
11ac40MIMO	5510	Type6	18	1	333.3	9	0.3333	300	5640	1
11ac40MIMO	5510	Type6	18	1	333.3	9	0.3333	300	5410	1
11ac40MIMO	5510	Type6	18	1	333.3	9	0.3333	300	5609	1
11ac40MIMO	5510	Type6	18	1	333.3	9	0.3333	300	5333	1
11ac40MIMO	5510	Type6	18	1	333.3	9	0.3333	300	5461	1
11ac40MIMO	5510	Type6	18	1	333.3	9	0.3333	300	5275	1
11ac40MIMO	5510	Type6	18	1	333.3	9	0.3333	300	5518	1
11ac40MIMO	5510	Type6	18	1	333.3	9	0.3333	300	5572	1
11ac40MIMO	5510	Type6	18	1	333.3	9	0.3333	300	5620	1
11ac40MIMO	5510	Type6	18	1	333.3	9	0.3333	300	5506	1
11ac40MIMO	5510	Type6	18	1	333.3	9	0.3333	300	5282	1
11ac40MIMO	5510	Type6	18	1	333.3	9	0.3333	300	5342	1
11ac40MIMO	5510	Type6	18	1	333.3	9	0.3333	300	5330	1
11ac40MIMO	5510	Type6	18	1	333.3	9	0.3333	300	5573	1
11ac40MIMO	5510	Type6	18	1	333.3	9	0.3333	300	5718	1
11ac40MIMO	5510	Type6	18	1	333.3	9	0.3333	300	5557	1
11ac40MIMO	5510	Type6	18	1	333.3	9	0.3333	300	5517	1
11ac40MIMO	5510	Type6	18	1	333.3	9	0.3333	300	5601	1
11ac40MIMO	5510	Type6	18	1	333.3	9	0.3333	300	5708	1
11ac40MIMO	5510	Type6	18	1	333.3	9	0.3333	300	5298	1
11ac40MIMO	5510	Type6	18	1	333.3	9	0.3333	300	5525	1
11ac40MIMO	5510	Type6	18	1	333.3	9	0.3333	300	5405	1
11ac40MIMO	5510	Type6	18	1	333.3	9	0.3333	300	5304	1
11ac40MIMO	5510	Type6	18	1	333.3	9	0.3333	300	5682	1
11ac20MIMO	5500	Type6	18	1	333.3	9	0.3333	300	5291	1
11ac20MIMO	5500	Type6	18	1	333.3	9	0.3333	300	5463	1
11ac20MIMO	5500	Type6	18	1	333.3	9	0.3333	300	5607	1
11ac20MIMO	5500	Type6	18	1	333.3	9	0.3333	300	5462	1
11ac20MIMO	5500	Type6	18	1	333.3	9	0.3333	300	5632	1
11ac20MIMO	5500	Type6	18	1	333.3	9	0.3333	300	5603	1
11ac20MIMO	5500	Type6	18	1	333.3	9	0.3333	300	5258	1
11ac20MIMO	5500	Type6	18	1	333.3	9	0.3333	300	5560	1



Unless otherwise agreed in writing, this document is issued by the Company subject to its General Conditions of Service printed overleaf, available on request or accessible at <http://www.sgs.com/en/Terms-and-Conditions.aspx> and, for electronic format documents, subject to Terms and Conditions for Electronic Documents at <http://www.sgs.com/en/Terms-and-Conditions/Terms-e-Documents.aspx>. Attention is drawn to the limitation of liability, indemnification and jurisdiction issues defined therein. Any holder of this document is advised that information contained herein reflects the Company's findings at the time of its intervention only and within the limits of Client's instructions, if any. The Company's sole responsibility is to its Client and this document does not exonerate parties to a transaction from exercising all their rights and obligations under the transaction documents. This document cannot be reproduced except in full, without prior written approval of the Company. Any unauthorized alteration, forgery or falsification of the content or appearance of this document is unlawful and offenders may be prosecuted to the fullest extent of the law. Unless otherwise stated the results shown in this test report refer only to the sample(s) tested and such sample(s) are retained for 30 days only.

Attention: To check the authenticity of testing/inspection report & certificate, please contact us at telephone: (86-755) 8307 1443, or email: [CN.Doccheck@sgs.com](mailto:CN.Doccheck@sgs.com)  
 (E) Unit D, Building 1, Kanglong Orange Science Park, No.157, Keyuan 3rd Road, Fengyang New Town, Xi'an, Shaanxi, China 710086  
 t (86-29) 6282 7885 www.sgs.com.cn  
 中国·西安·沣东新城科里三路157号康隆橙方科技园1号楼D单元1层 邮编: 710086 t (86-29) 6282 7885 sgs.china@sgs.com

11ac20MIMO	5500	Type6	18	1	333.3	9	0.3333	300	5674	1
11ac20MIMO	5500	Type6	18	1	333.3	9	0.3333	300	5326	1
11ac20MIMO	5500	Type6	18	1	333.3	9	0.3333	300	5274	1
11ac20MIMO	5500	Type6	18	1	333.3	9	0.3333	300	5341	1
11ac20MIMO	5500	Type6	18	1	333.3	9	0.3333	300	5491	1
11ac20MIMO	5500	Type6	18	1	333.3	9	0.3333	300	5392	1
11ac20MIMO	5500	Type6	18	1	333.3	9	0.3333	300	5636	1
11ac20MIMO	5500	Type6	18	1	333.3	9	0.3333	300	5434	1
11ac20MIMO	5500	Type6	18	1	333.3	9	0.3333	300	5332	1
11ac20MIMO	5500	Type6	18	1	333.3	9	0.3333	300	5305	1
11ac20MIMO	5500	Type6	18	1	333.3	9	0.3333	300	5673	1
11ac20MIMO	5500	Type6	18	1	333.3	9	0.3333	300	5430	1
11ac20MIMO	5500	Type6	18	1	333.3	9	0.3333	300	5400	1
11ac20MIMO	5500	Type6	18	1	333.3	9	0.3333	300	5711	1
11ac20MIMO	5500	Type6	18	1	333.3	9	0.3333	300	5293	1
11ac20MIMO	5500	Type6	18	1	333.3	9	0.3333	300	5419	1
11ac20MIMO	5500	Type6	18	1	333.3	9	0.3333	300	5317	1
11ac20MIMO	5500	Type6	18	1	333.3	9	0.3333	300	5381	1
11ac20MIMO	5500	Type6	18	1	333.3	9	0.3333	300	5254	1
11ac20MIMO	5500	Type6	18	1	333.3	9	0.3333	300	5303	1
11ac20MIMO	5500	Type6	18	1	333.3	9	0.3333	300	5672	1
11ac20MIMO	5500	Type6	18	1	333.3	9	0.3333	300	5345	1
11ac20MIMO	5500	Type6	18	1	333.3	9	0.3333	300	5611	1
11ac20MIMO	5500	Type6	18	1	333.3	9	0.3333	300	5649	1
11ac20MIMO	5500	Type6	18	1	333.3	9	0.3333	300	5619	1
11ac20MIMO	5500	Type6	18	1	333.3	9	0.3333	300	5403	1
11ac20MIMO	5500	Type6	18	1	333.3	9	0.3333	300	5541	1
11ac20MIMO	5500	Type6	18	1	333.3	9	0.3333	300	5596	1
11ac20MIMO	5500	Type6	18	1	333.3	9	0.3333	300	5585	1
11ac20MIMO	5500	Type6	18	1	333.3	9	0.3333	300	5623	1
11ac20MIMO	5500	Type6	18	1	333.3	9	0.3333	300	5633	1
11ac20MIMO	5500	Type6	18	1	333.3	9	0.3333	300	5438	1
11ac20MIMO	5500	Type6	18	1	333.3	9	0.3333	300	5647	1
11ac20MIMO	5500	Type6	18	1	333.3	9	0.3333	300	5665	1
11ac20MIMO	5500	Type6	18	1	333.3	9	0.3333	300	5359	1
11ac20MIMO	5500	Type6	18	1	333.3	9	0.3333	300	5374	1
11ac20MIMO	5500	Type6	18	1	333.3	9	0.3333	300	5466	1
11ac20MIMO	5500	Type6	18	1	333.3	9	0.3333	300	5666	1
11ac20MIMO	5500	Type6	18	1	333.3	9	0.3333	300	5516	1
11ac20MIMO	5500	Type6	18	1	333.3	9	0.3333	300	5589	1
11ac20MIMO	5500	Type6	18	1	333.3	9	0.3333	300	5706	1
11ac20MIMO	5500	Type6	18	1	333.3	9	0.3333	300	5586	1
11ac20MIMO	5500	Type6	18	1	333.3	9	0.3333	300	5394	1
11ac20MIMO	5500	Type6	18	1	333.3	9	0.3333	300	5312	1
11ac20MIMO	5500	Type6	18	1	333.3	9	0.3333	300	5646	1
11ac20MIMO	5500	Type6	18	1	333.3	9	0.3333	300	5661	1
11ac20MIMO	5500	Type6	18	1	333.3	9	0.3333	300	5493	1
11ac20MIMO	5500	Type6	18	1	333.3	9	0.3333	300	5543	1
11ac20MIMO	5500	Type6	18	1	333.3	9	0.3333	300	5599	1
11ac20MIMO	5500	Type6	18	1	333.3	9	0.3333	300	5273	1
11ac20MIMO	5500	Type6	18	1	333.3	9	0.3333	300	5476	1
11ac20MIMO	5500	Type6	18	1	333.3	9	0.3333	300	5276	1
11ac20MIMO	5500	Type6	18	1	333.3	9	0.3333	300	5455	1



Unless otherwise agreed in writing, this document is issued by the Company subject to its General Conditions of Service printed overleaf, available on request or accessible at <http://www.sgs.com/en/Terms-and-Conditions.aspx> and, for electronic format documents, subject to Terms and Conditions for Electronic Documents at <http://www.sgs.com/en/Terms-and-Conditions/Terms-e-Documents.aspx>. Attention is drawn to the limitation of liability, indemnification and jurisdiction issues defined therein. Any holder of this document is advised that information contained herein reflects the Company's findings at the time of its intervention only and within the limits of Client's instructions, if any. The Company's sole responsibility is to its Client and this document does not exonerate parties to a transaction from exercising all their rights and obligations under the transaction documents. This document cannot be reproduced except in full, without prior written approval of the Company. Any unauthorized alteration, forgery or falsification of the content or appearance of this document is unlawful and offenders may be prosecuted to the fullest extent of the law. Unless otherwise stated the results shown in this test report refer only to the sample(s) tested and such sample(s) are retained for 30 days only.

Attention: To check the authenticity of testing/inspection report & certificate, please contact us at telephone: (86-755) 8307 1443, or email: [CN.Doccheck@sgs.com](mailto:CN.Doccheck@sgs.com)  
 (U) Ltd D Building 1, Kanglong Orange Science Park, No.157, Keyuan 3rd Road, Fengfeng New Town, Xi'an, Shaanxi, China 710086  
 t (86-29) 6282 7885 www.sgs.com.cn  
 中国·西安·沣东新城科里三路157号康鸿橙方科技园1号楼D单元1层 邮编: 710086 t (86-29) 6282 7885 sgs.china@sgs.com



Report No.: XEWA2310000070RG05

Rev.: 01

Page: 201 of 267

11ac20MIMO	5500	Type6	18	1	333.3	9	0.3333	300	5664	1
11ac20MIMO	5500	Type6	18	1	333.3	9	0.3333	300	5498	1
11ac20MIMO	5500	Type6	18	1	333.3	9	0.3333	300	5580	1
11ac20MIMO	5500	Type6	18	1	333.3	9	0.3333	300	5618	1
11ac20MIMO	5500	Type6	18	1	333.3	9	0.3333	300	5338	1
11ac20MIMO	5500	Type6	18	1	333.3	9	0.3333	300	5531	1
11ac20MIMO	5500	Type6	18	1	333.3	9	0.3333	300	5435	1
11ac20MIMO	5500	Type6	18	1	333.3	9	0.3333	300	5629	1
11ac20MIMO	5500	Type6	18	1	333.3	9	0.3333	300	5424	1
11ac20MIMO	5500	Type6	18	1	333.3	9	0.3333	300	5311	1
11ac20MIMO	5500	Type6	18	1	333.3	9	0.3333	300	5309	1
11ac20MIMO	5500	Type6	18	1	333.3	9	0.3333	300	5314	1
11ac20MIMO	5500	Type6	18	1	333.3	9	0.3333	300	5450	1
11ac20MIMO	5500	Type6	18	1	333.3	9	0.3333	300	5310	1
11ac20MIMO	5500	Type6	18	1	333.3	9	0.3333	300	5290	1
11ac20MIMO	5500	Type6	18	1	333.3	9	0.3333	300	5640	1
11ac20MIMO	5500	Type6	18	1	333.3	9	0.3333	300	5410	1
11ac20MIMO	5500	Type6	18	1	333.3	9	0.3333	300	5609	1
11ac20MIMO	5500	Type6	18	1	333.3	9	0.3333	300	5333	1
11ac20MIMO	5500	Type6	18	1	333.3	9	0.3333	300	5461	1
11ac20MIMO	5500	Type6	18	1	333.3	9	0.3333	300	5275	1
11ac20MIMO	5500	Type6	18	1	333.3	9	0.3333	300	5518	1
11ac20MIMO	5500	Type6	18	1	333.3	9	0.3333	300	5572	1
11ac20MIMO	5500	Type6	18	1	333.3	9	0.3333	300	5620	1
11ac20MIMO	5500	Type6	18	1	333.3	9	0.3333	300	5506	1
11ac20MIMO	5500	Type6	18	1	333.3	9	0.3333	300	5282	1
11ac20MIMO	5500	Type6	18	1	333.3	9	0.3333	300	5342	1
11ac20MIMO	5500	Type6	18	1	333.3	9	0.3333	300	5330	1
11ac20MIMO	5500	Type6	18	1	333.3	9	0.3333	300	5573	1
11ac20MIMO	5500	Type6	18	1	333.3	9	0.3333	300	5718	1
11ac20MIMO	5500	Type6	18	1	333.3	9	0.3333	300	5557	1
11ac20MIMO	5500	Type6	18	1	333.3	9	0.3333	300	5517	1
11ac20MIMO	5500	Type6	18	1	333.3	9	0.3333	300	5601	1
11ac20MIMO	5500	Type6	18	1	333.3	9	0.3333	300	5708	1
11ac20MIMO	5500	Type6	18	1	333.3	9	0.3333	300	5298	1
11ac20MIMO	5500	Type6	18	1	333.3	9	0.3333	300	5525	1
11ac20MIMO	5500	Type6	18	1	333.3	9	0.3333	300	5405	1
11ac20MIMO	5500	Type6	18	1	333.3	9	0.3333	300	5304	1
11ac20MIMO	5500	Type6	18	1	333.3	9	0.3333	300	5682	1



Unless otherwise agreed in writing, this document is issued by the Company subject to its General Conditions of Service printed overleaf, available on request or accessible at <http://www.sgs.com/en/Terms-and-Conditions.aspx> and, for electronic format documents, subject to Terms and Conditions for Electronic Documents at <http://www.sgs.com/en/Terms-and-Conditions/Terms-e-Documents.aspx>. Attention is drawn to the limitation of liability, indemnification and jurisdiction issues defined therein. Any holder of this document is advised that information contained herein reflects the Company's findings at the time of its intervention only and within the limits of Client's instructions, if any. The Company's sole responsibility is to its Client and this document does not exonerate parties to a transaction from exercising all their rights and obligations under the transaction documents. This document cannot be reproduced except in full, without prior written approval of the Company. Any unauthorized alteration, forgery or falsification of the content or appearance of this document is unlawful and offenders may be prosecuted to the fullest extent of the law. Unless otherwise stated the results shown in this test report refer only to the sample(s) tested and such sample(s) are retained for 30 days only.

Attention: To check the authenticity of testing/inspection report & certificate, please contact us at telephone: (86-755) 4307 1443, or email: [CN.Doccheck@sgs.com](mailto:CN.Doccheck@sgs.com)  
 (SGS-CSTC) Standards Technical Services (Xi'an) Co., Ltd. | 1/E Unit D, Building 1, Kanghong Orange Source Park, No.137, Kejian 3rd Road, Fengling New Town, Xi'an, Shaanxi, China | 710086 | t: (86-29) 6282 7885 | www.sgs.com.cn  
 中国·西安·沣东新城科园三路137号康鸿橙方科技园1号楼D单元1层 | 邮编: 710086 | t: (86-29) 6282 7885 | sgs.china@sgs.com

TestMode	Channel	Radar Type	Trial ID	Pulse width (μs)	PRI (μs)	Pulses per Hop	Hop Rate (kHz)	Hop Sequence Length(ms)	Center Frequency (MHz)	Detection (1: Yes; 0: No)
11ac80MIMO	5530	Type6	19	1	333.3	9	0.3333	300	5546	1
11ac80MIMO	5530	Type6	19	1	333.3	9	0.3333	300	5702	1
11ac80MIMO	5530	Type6	19	1	333.3	9	0.3333	300	5543	1
11ac80MIMO	5530	Type6	19	1	333.3	9	0.3333	300	5623	1
11ac80MIMO	5530	Type6	19	1	333.3	9	0.3333	300	5377	1
11ac80MIMO	5530	Type6	19	1	333.3	9	0.3333	300	5645	1
11ac80MIMO	5530	Type6	19	1	333.3	9	0.3333	300	5280	1
11ac80MIMO	5530	Type6	19	1	333.3	9	0.3333	300	5635	1
11ac80MIMO	5530	Type6	19	1	333.3	9	0.3333	300	5265	1
11ac80MIMO	5530	Type6	19	1	333.3	9	0.3333	300	5335	1
11ac80MIMO	5530	Type6	19	1	333.3	9	0.3333	300	5257	1
11ac80MIMO	5530	Type6	19	1	333.3	9	0.3333	300	5590	1
11ac80MIMO	5530	Type6	19	1	333.3	9	0.3333	300	5315	1
11ac80MIMO	5530	Type6	19	1	333.3	9	0.3333	300	5439	1
11ac80MIMO	5530	Type6	19	1	333.3	9	0.3333	300	5512	1
11ac80MIMO	5530	Type6	19	1	333.3	9	0.3333	300	5383	1
11ac80MIMO	5530	Type6	19	1	333.3	9	0.3333	300	5288	1
11ac80MIMO	5530	Type6	19	1	333.3	9	0.3333	300	5440	1
11ac80MIMO	5530	Type6	19	1	333.3	9	0.3333	300	5594	1
11ac80MIMO	5530	Type6	19	1	333.3	9	0.3333	300	5681	1
11ac80MIMO	5530	Type6	19	1	333.3	9	0.3333	300	5596	1
11ac80MIMO	5530	Type6	19	1	333.3	9	0.3333	300	5273	1
11ac80MIMO	5530	Type6	19	1	333.3	9	0.3333	300	5649	1
11ac80MIMO	5530	Type6	19	1	333.3	9	0.3333	300	5373	1
11ac80MIMO	5530	Type6	19	1	333.3	9	0.3333	300	5502	1
11ac80MIMO	5530	Type6	19	1	333.3	9	0.3333	300	5620	1
11ac80MIMO	5530	Type6	19	1	333.3	9	0.3333	300	5622	1
11ac80MIMO	5530	Type6	19	1	333.3	9	0.3333	300	5518	1
11ac80MIMO	5530	Type6	19	1	333.3	9	0.3333	300	5415	1
11ac80MIMO	5530	Type6	19	1	333.3	9	0.3333	300	5393	1
11ac80MIMO	5530	Type6	19	1	333.3	9	0.3333	300	5289	1
11ac80MIMO	5530	Type6	19	1	333.3	9	0.3333	300	5629	1
11ac80MIMO	5530	Type6	19	1	333.3	9	0.3333	300	5560	1
11ac80MIMO	5530	Type6	19	1	333.3	9	0.3333	300	5385	1
11ac80MIMO	5530	Type6	19	1	333.3	9	0.3333	300	5372	1
11ac80MIMO	5530	Type6	19	1	333.3	9	0.3333	300	5283	1
11ac80MIMO	5530	Type6	19	1	333.3	9	0.3333	300	5494	1
11ac80MIMO	5530	Type6	19	1	333.3	9	0.3333	300	5337	1
11ac80MIMO	5530	Type6	19	1	333.3	9	0.3333	300	5510	1
11ac80MIMO	5530	Type6	19	1	333.3	9	0.3333	300	5424	1
11ac80MIMO	5530	Type6	19	1	333.3	9	0.3333	300	5706	1
11ac80MIMO	5530	Type6	19	1	333.3	9	0.3333	300	5571	1
11ac80MIMO	5530	Type6	19	1	333.3	9	0.3333	300	5361	1
11ac80MIMO	5530	Type6	19	1	333.3	9	0.3333	300	5435	1
11ac80MIMO	5530	Type6	19	1	333.3	9	0.3333	300	5479	1
11ac80MIMO	5530	Type6	19	1	333.3	9	0.3333	300	5442	1
11ac80MIMO	5530	Type6	19	1	333.3	9	0.3333	300	5519	1
11ac80MIMO	5530	Type6	19	1	333.3	9	0.3333	300	5456	1
11ac80MIMO	5530	Type6	19	1	333.3	9	0.3333	300	5392	1



Unless otherwise agreed in writing, this document is issued by the Company subject to its General Conditions of Service printed overleaf, available on request or accessible at <http://www.sgs.com/en/Terms-and-Conditions.aspx> and, for electronic format documents, subject to Terms and Conditions for Electronic Documents at <http://www.sgs.com/en/Terms-and-Conditions/Terms-e-Document.aspx>. Attention is drawn to the limitation of liability, indemnification and jurisdiction issues defined therein. Any holder of this document is advised that information contained herein reflects the Company's findings at the time of its intervention only and within the limits of Client's instructions, if any. The Company's sole responsibility is to its Client and this document does not exonerate parties to a transaction from exercising all their rights and obligations under the transaction documents. This document cannot be reproduced except in full, without prior written approval of the Company. Any unauthorized alteration, forgery or falsification of the content or appearance of this document is unlawful and offenders may be prosecuted to the fullest extent of the law. Unless otherwise stated the results shown in this test report refer only to the sample(s) tested and such sample(s) are retained for 30 days only.

Attention: To check the authenticity of testing/inspection report & certificate, please contact us at telephone: (86-755) 8307 1443, or email: [CN.Doccheck@sgs.com](mailto:CN.Doccheck@sgs.com)

SGS-CSTC Standards Technical Services (Xi'an) Co., Ltd. | 1/E Unit D, Building 1, Kanglong Orange Science Park, No.157, Keyuan 3rd Road, Fengjing/Yue Town, Xi'an, Shaanxi, China | 710086 | t (86-29) 6282 7885 | www.sgs.com.cn  
 中国·西安·沣东新城科里三路157号康隆橙方科技园1号楼D单元1层 | 邮编: 710086 | t (86-29) 6282 7885 | sgs.china@sgs.com



11ac80MIMO	5530	Type6	19	1	333.3	9	0.3333	300	5290	1
11ac80MIMO	5530	Type6	19	1	333.3	9	0.3333	300	5282	1
11ac80MIMO	5530	Type6	19	1	333.3	9	0.3333	300	5297	1
11ac80MIMO	5530	Type6	19	1	333.3	9	0.3333	300	5679	1
11ac80MIMO	5530	Type6	19	1	333.3	9	0.3333	300	5716	1
11ac80MIMO	5530	Type6	19	1	333.3	9	0.3333	300	5500	1
11ac80MIMO	5530	Type6	19	1	333.3	9	0.3333	300	5600	1
11ac80MIMO	5530	Type6	19	1	333.3	9	0.3333	300	5275	1
11ac80MIMO	5530	Type6	19	1	333.3	9	0.3333	300	5464	1
11ac80MIMO	5530	Type6	19	1	333.3	9	0.3333	300	5672	1
11ac80MIMO	5530	Type6	19	1	333.3	9	0.3333	300	5308	1
11ac80MIMO	5530	Type6	19	1	333.3	9	0.3333	300	5577	1
11ac80MIMO	5530	Type6	19	1	333.3	9	0.3333	300	5401	1
11ac80MIMO	5530	Type6	19	1	333.3	9	0.3333	300	5390	1
11ac80MIMO	5530	Type6	19	1	333.3	9	0.3333	300	5447	1
11ac80MIMO	5530	Type6	19	1	333.3	9	0.3333	300	5450	1
11ac80MIMO	5530	Type6	19	1	333.3	9	0.3333	300	5608	1
11ac80MIMO	5530	Type6	19	1	333.3	9	0.3333	300	5334	1
11ac80MIMO	5530	Type6	19	1	333.3	9	0.3333	300	5507	1
11ac80MIMO	5530	Type6	19	1	333.3	9	0.3333	300	5615	1
11ac80MIMO	5530	Type6	19	1	333.3	9	0.3333	300	5524	1
11ac80MIMO	5530	Type6	19	1	333.3	9	0.3333	300	5285	1
11ac80MIMO	5530	Type6	19	1	333.3	9	0.3333	300	5322	1
11ac80MIMO	5530	Type6	19	1	333.3	9	0.3333	300	5430	1
11ac80MIMO	5530	Type6	19	1	333.3	9	0.3333	300	5433	1
11ac80MIMO	5530	Type6	19	1	333.3	9	0.3333	300	5433	1
11ac80MIMO	5530	Type6	19	1	333.3	9	0.3333	300	5621	1
11ac80MIMO	5530	Type6	19	1	333.3	9	0.3333	300	5662	1
11ac80MIMO	5530	Type6	19	1	333.3	9	0.3333	300	5719	1
11ac80MIMO	5530	Type6	19	1	333.3	9	0.3333	300	5589	1
11ac80MIMO	5530	Type6	19	1	333.3	9	0.3333	300	5528	1
11ac80MIMO	5530	Type6	19	1	333.3	9	0.3333	300	5515	1
11ac80MIMO	5530	Type6	19	1	333.3	9	0.3333	300	5292	1
11ac80MIMO	5530	Type6	19	1	333.3	9	0.3333	300	5462	1
11ac80MIMO	5530	Type6	19	1	333.3	9	0.3333	300	5566	1
11ac80MIMO	5530	Type6	19	1	333.3	9	0.3333	300	5307	1
11ac80MIMO	5530	Type6	19	1	333.3	9	0.3333	300	5284	1
11ac80MIMO	5530	Type6	19	1	333.3	9	0.3333	300	5296	1
11ac80MIMO	5530	Type6	19	1	333.3	9	0.3333	300	5474	1
11ac80MIMO	5530	Type6	19	1	333.3	9	0.3333	300	5724	1
11ac80MIMO	5530	Type6	19	1	333.3	9	0.3333	300	5399	1
11ac80MIMO	5530	Type6	19	1	333.3	9	0.3333	300	5710	1
11ac80MIMO	5530	Type6	19	1	333.3	9	0.3333	300	5250	1
11ac80MIMO	5530	Type6	19	1	333.3	9	0.3333	300	5353	1
11ac80MIMO	5530	Type6	19	1	333.3	9	0.3333	300	5509	1
11ac80MIMO	5530	Type6	19	1	333.3	9	0.3333	300	5303	1
11ac80MIMO	5530	Type6	19	1	333.3	9	0.3333	300	5597	1
11ac80MIMO	5530	Type6	19	1	333.3	9	0.3333	300	5407	1
11ac80MIMO	5530	Type6	19	1	333.3	9	0.3333	300	5428	1
11ac80MIMO	5530	Type6	19	1	333.3	9	0.3333	300	5562	1
11ac80MIMO	5530	Type6	19	1	333.3	9	0.3333	300	5678	1
11ac80MIMO	5530	Type6	19	1	333.3	9	0.3333	300	5300	1
11ac40MIMO	5510	Type6	19	1	333.3	9	0.3333	300	5546	1
11ac40MIMO	5510	Type6	19	1	333.3	9	0.3333	300	5702	1



Unless otherwise agreed in writing, this document is issued by the Company subject to its General Conditions of Service printed overleaf, available on request or accessible at <http://www.sgs.com/en/Terms-and-Conditions.aspx> and, for electronic format documents, subject to Terms and Conditions for Electronic Documents at <http://www.sgs.com/en/Terms-and-Conditions/Terms-e-Documents.aspx>. Attention is drawn to the limitation of liability, indemnification and jurisdiction issues defined therein. Any holder of this document is advised that information contained herein reflects the Company's findings at the time of its intervention only and within the limits of Client's instructions, if any. The Company's sole responsibility is to its Client and this document does not exonerate parties to a transaction from exercising all their rights and obligations under the transaction documents. This document cannot be reproduced except in full, without prior written approval of the Company. Any unauthorized alteration, forgery or falsification of the content or appearance of this document is unlawful and offenders may be prosecuted to the fullest extent of the law. Unless otherwise stated the results shown in this test report refer only to the sample(s) tested and such sample(s) are retained for 30 days only.

Attention: To check the authenticity of testing/inspection report & certificate, please contact us at telephone: (86-755) 8307 1443, or email: [CN.Doccheck@sgs.com](mailto:CN.Doccheck@sgs.com)  
 (E) Unit D, Building 1, Kanglong Orange Science Park, No.157, Keyuan 3rd Road, Fengyang New Town, Xian, Shaanxi, China 710086 t (86-29) 6282 7885 www.sgs.com.cn  
 中国·西安·沣东新城科里三路157号康鸿橙方科技园1号楼D单元1层 邮编: 710086 t (86-29) 6282 7885 sgs.china@sgs.com

11ac40MIMO	5510	Type6	19	1	333.3	9	0.3333	300	5543	1
11ac40MIMO	5510	Type6	19	1	333.3	9	0.3333	300	5623	1
11ac40MIMO	5510	Type6	19	1	333.3	9	0.3333	300	5377	1
11ac40MIMO	5510	Type6	19	1	333.3	9	0.3333	300	5645	1
11ac40MIMO	5510	Type6	19	1	333.3	9	0.3333	300	5280	1
11ac40MIMO	5510	Type6	19	1	333.3	9	0.3333	300	5635	1
11ac40MIMO	5510	Type6	19	1	333.3	9	0.3333	300	5265	1
11ac40MIMO	5510	Type6	19	1	333.3	9	0.3333	300	5335	1
11ac40MIMO	5510	Type6	19	1	333.3	9	0.3333	300	5257	1
11ac40MIMO	5510	Type6	19	1	333.3	9	0.3333	300	5590	1
11ac40MIMO	5510	Type6	19	1	333.3	9	0.3333	300	5315	1
11ac40MIMO	5510	Type6	19	1	333.3	9	0.3333	300	5439	1
11ac40MIMO	5510	Type6	19	1	333.3	9	0.3333	300	5512	1
11ac40MIMO	5510	Type6	19	1	333.3	9	0.3333	300	5383	1
11ac40MIMO	5510	Type6	19	1	333.3	9	0.3333	300	5288	1
11ac40MIMO	5510	Type6	19	1	333.3	9	0.3333	300	5440	1
11ac40MIMO	5510	Type6	19	1	333.3	9	0.3333	300	5594	1
11ac40MIMO	5510	Type6	19	1	333.3	9	0.3333	300	5681	1
11ac40MIMO	5510	Type6	19	1	333.3	9	0.3333	300	5596	1
11ac40MIMO	5510	Type6	19	1	333.3	9	0.3333	300	5273	1
11ac40MIMO	5510	Type6	19	1	333.3	9	0.3333	300	5649	1
11ac40MIMO	5510	Type6	19	1	333.3	9	0.3333	300	5373	1
11ac40MIMO	5510	Type6	19	1	333.3	9	0.3333	300	5502	1
11ac40MIMO	5510	Type6	19	1	333.3	9	0.3333	300	5620	1
11ac40MIMO	5510	Type6	19	1	333.3	9	0.3333	300	5622	1
11ac40MIMO	5510	Type6	19	1	333.3	9	0.3333	300	5518	1
11ac40MIMO	5510	Type6	19	1	333.3	9	0.3333	300	5415	1
11ac40MIMO	5510	Type6	19	1	333.3	9	0.3333	300	5393	1
11ac40MIMO	5510	Type6	19	1	333.3	9	0.3333	300	5289	1
11ac40MIMO	5510	Type6	19	1	333.3	9	0.3333	300	5629	1
11ac40MIMO	5510	Type6	19	1	333.3	9	0.3333	300	5560	1
11ac40MIMO	5510	Type6	19	1	333.3	9	0.3333	300	5385	1
11ac40MIMO	5510	Type6	19	1	333.3	9	0.3333	300	5372	1
11ac40MIMO	5510	Type6	19	1	333.3	9	0.3333	300	5283	1
11ac40MIMO	5510	Type6	19	1	333.3	9	0.3333	300	5494	1
11ac40MIMO	5510	Type6	19	1	333.3	9	0.3333	300	5337	1
11ac40MIMO	5510	Type6	19	1	333.3	9	0.3333	300	5510	1
11ac40MIMO	5510	Type6	19	1	333.3	9	0.3333	300	5424	1
11ac40MIMO	5510	Type6	19	1	333.3	9	0.3333	300	5706	1
11ac40MIMO	5510	Type6	19	1	333.3	9	0.3333	300	5571	1
11ac40MIMO	5510	Type6	19	1	333.3	9	0.3333	300	5361	1
11ac40MIMO	5510	Type6	19	1	333.3	9	0.3333	300	5435	1
11ac40MIMO	5510	Type6	19	1	333.3	9	0.3333	300	5479	1
11ac40MIMO	5510	Type6	19	1	333.3	9	0.3333	300	5442	1
11ac40MIMO	5510	Type6	19	1	333.3	9	0.3333	300	5519	1
11ac40MIMO	5510	Type6	19	1	333.3	9	0.3333	300	5456	1
11ac40MIMO	5510	Type6	19	1	333.3	9	0.3333	300	5392	1
11ac40MIMO	5510	Type6	19	1	333.3	9	0.3333	300	5290	1
11ac40MIMO	5510	Type6	19	1	333.3	9	0.3333	300	5282	1
11ac40MIMO	5510	Type6	19	1	333.3	9	0.3333	300	5297	1
11ac40MIMO	5510	Type6	19	1	333.3	9	0.3333	300	5679	1
11ac40MIMO	5510	Type6	19	1	333.3	9	0.3333	300	5716	1
11ac40MIMO	5510	Type6	19	1	333.3	9	0.3333	300	5500	1



Unless otherwise agreed in writing, this document is issued by the Company subject to its General Conditions of Service printed overleaf, available on request or accessible at <http://www.sgs.com/en/Terms-and-Conditions.aspx> and, for electronic format documents, subject to Terms and Conditions for Electronic Documents at <http://www.sgs.com/en/Terms-and-Conditions/Terms-e-Document.aspx>. Attention is drawn to the limitation of liability, indemnification and jurisdiction issues defined therein. Any holder of this document is advised that information contained herein reflects the Company's findings at the time of its intervention only and within the limits of Client's instructions, if any. The Company's sole responsibility is to its Client and this document does not exonerate parties to a transaction from exercising all their rights and obligations under the transaction documents. This document cannot be reproduced except in full, without prior written approval of the Company. Any unauthorized alteration, forgery or falsification of the content or appearance of this document is unlawful and offenders may be prosecuted to the fullest extent of the law. Unless otherwise stated the results shown in this test report refer only to the sample(s) tested and such sample(s) are retained for 30 days only.

Attention: To check the authenticity of testing/inspection report & certificate, please contact us at telephone: (86-755) 8307 1443, or email: [CN.Doccheck@sgs.com](mailto:CN.Doccheck@sgs.com)

SGS-CSTC Standards Technical Services (Xi'an) Co., Ltd. | 1/E Unit D, Building 1, Kanglong Orange Science Park, No.137, Keyuan 3rd Road, Fengyang New Town, Xian, Shaanxi, China | 710086 | T (86-29) 6282 7885 | [www.sgs.com](http://www.sgs.com)  
 中国·西安·沣东新城科里三路137号康鸿橙方科技园1号楼D单元1层 | 邮编: 710086 | T (86-29) 6282 7885 | [sgs.china@sgs.com](mailto:sgs.china@sgs.com)



Table with 11 columns: Item ID, Value, Type, and various numerical parameters. Rows include items like 11ac40MIMO and 11ac20MIMO.



Unless otherwise agreed in writing, this document is issued by the Company subject to its General Conditions of Service printed overleaf, available on request or accessible at http://www.sgs.com/en/Terms-and-Conditions.aspx and, for electronic format documents, subject to Terms and Conditions for Electronic Documents at http://www.sgs.com/en/Terms-and-Conditions/Terms-e-Document.aspx. Attention is drawn to the limitation of liability, indemnification and jurisdiction issues defined therein. Any holder of this document is advised that information contained herein reflects the Company's findings at the time of its intervention only and within the limits of Client's instructions, if any. The Company's sole responsibility is to its Client and this document does not exonerate parties to a transaction from exercising all their rights and obligations under the transaction documents. This document cannot be reproduced except in full, without prior written approval of the Company. Any unauthorized alteration, forgery or falsification of the content or appearance of this document is unlawful and offenders may be prosecuted to the fullest extent of the law. Unless otherwise stated the results shown in this test report refer only to the sample(s) tested and such sample(s) are retained for 30 days only. Attention: To check the authenticity of testing/inspection report & certificate, please contact us at telephone: (86-755) 8307 1443, or email: CN.Doccheck@sgs.com.
SGS-CSTC Standards Technical Services (Xi'an) Co., Ltd. | 1/E Unit D, Building 1, Kanglong Orange Science Park, No.137, Keyuan 3rd Road, Fengtong/Yue Town, Xi'an, Shaanxi, China | 710086 | t: (86-29) 6282 7885 | www.sgs.com.cn
中国·西安·沣东新城科里三路137号康鸿橙方科技园1号楼D单元1层 | 邮编: 710086 | t: (86-29) 6282 7885 | sgs.china@sgs.com

11ac20MIMO	5500	Type6	19	1	333.3	9	0.3333	300	5265	1
11ac20MIMO	5500	Type6	19	1	333.3	9	0.3333	300	5335	1
11ac20MIMO	5500	Type6	19	1	333.3	9	0.3333	300	5257	1
11ac20MIMO	5500	Type6	19	1	333.3	9	0.3333	300	5590	1
11ac20MIMO	5500	Type6	19	1	333.3	9	0.3333	300	5315	1
11ac20MIMO	5500	Type6	19	1	333.3	9	0.3333	300	5439	1
11ac20MIMO	5500	Type6	19	1	333.3	9	0.3333	300	5512	1
11ac20MIMO	5500	Type6	19	1	333.3	9	0.3333	300	5383	1
11ac20MIMO	5500	Type6	19	1	333.3	9	0.3333	300	5288	1
11ac20MIMO	5500	Type6	19	1	333.3	9	0.3333	300	5440	1
11ac20MIMO	5500	Type6	19	1	333.3	9	0.3333	300	5594	1
11ac20MIMO	5500	Type6	19	1	333.3	9	0.3333	300	5681	1
11ac20MIMO	5500	Type6	19	1	333.3	9	0.3333	300	5596	1
11ac20MIMO	5500	Type6	19	1	333.3	9	0.3333	300	5273	1
11ac20MIMO	5500	Type6	19	1	333.3	9	0.3333	300	5649	1
11ac20MIMO	5500	Type6	19	1	333.3	9	0.3333	300	5373	1
11ac20MIMO	5500	Type6	19	1	333.3	9	0.3333	300	5502	1
11ac20MIMO	5500	Type6	19	1	333.3	9	0.3333	300	5620	1
11ac20MIMO	5500	Type6	19	1	333.3	9	0.3333	300	5622	1
11ac20MIMO	5500	Type6	19	1	333.3	9	0.3333	300	5518	1
11ac20MIMO	5500	Type6	19	1	333.3	9	0.3333	300	5415	1
11ac20MIMO	5500	Type6	19	1	333.3	9	0.3333	300	5393	1
11ac20MIMO	5500	Type6	19	1	333.3	9	0.3333	300	5289	1
11ac20MIMO	5500	Type6	19	1	333.3	9	0.3333	300	5629	1
11ac20MIMO	5500	Type6	19	1	333.3	9	0.3333	300	5560	1
11ac20MIMO	5500	Type6	19	1	333.3	9	0.3333	300	5385	1
11ac20MIMO	5500	Type6	19	1	333.3	9	0.3333	300	5372	1
11ac20MIMO	5500	Type6	19	1	333.3	9	0.3333	300	5283	1
11ac20MIMO	5500	Type6	19	1	333.3	9	0.3333	300	5494	1
11ac20MIMO	5500	Type6	19	1	333.3	9	0.3333	300	5337	1
11ac20MIMO	5500	Type6	19	1	333.3	9	0.3333	300	5510	1
11ac20MIMO	5500	Type6	19	1	333.3	9	0.3333	300	5424	1
11ac20MIMO	5500	Type6	19	1	333.3	9	0.3333	300	5706	1
11ac20MIMO	5500	Type6	19	1	333.3	9	0.3333	300	5571	1
11ac20MIMO	5500	Type6	19	1	333.3	9	0.3333	300	5361	1
11ac20MIMO	5500	Type6	19	1	333.3	9	0.3333	300	5435	1
11ac20MIMO	5500	Type6	19	1	333.3	9	0.3333	300	5479	1
11ac20MIMO	5500	Type6	19	1	333.3	9	0.3333	300	5442	1
11ac20MIMO	5500	Type6	19	1	333.3	9	0.3333	300	5519	1
11ac20MIMO	5500	Type6	19	1	333.3	9	0.3333	300	5456	1
11ac20MIMO	5500	Type6	19	1	333.3	9	0.3333	300	5392	1
11ac20MIMO	5500	Type6	19	1	333.3	9	0.3333	300	5290	1
11ac20MIMO	5500	Type6	19	1	333.3	9	0.3333	300	5282	1
11ac20MIMO	5500	Type6	19	1	333.3	9	0.3333	300	5297	1
11ac20MIMO	5500	Type6	19	1	333.3	9	0.3333	300	5679	1
11ac20MIMO	5500	Type6	19	1	333.3	9	0.3333	300	5716	1
11ac20MIMO	5500	Type6	19	1	333.3	9	0.3333	300	5500	1
11ac20MIMO	5500	Type6	19	1	333.3	9	0.3333	300	5600	1
11ac20MIMO	5500	Type6	19	1	333.3	9	0.3333	300	5275	1
11ac20MIMO	5500	Type6	19	1	333.3	9	0.3333	300	5464	1
11ac20MIMO	5500	Type6	19	1	333.3	9	0.3333	300	5672	1
11ac20MIMO	5500	Type6	19	1	333.3	9	0.3333	300	5308	1
11ac20MIMO	5500	Type6	19	1	333.3	9	0.3333	300	5577	1



Unless otherwise agreed in writing, this document is issued by the Company subject to its General Conditions of Service printed overleaf, available on request or accessible at <http://www.sgs.com/en/Terms-and-Conditions.aspx> and, for electronic format documents, subject to Terms and Conditions for Electronic Documents at <http://www.sgs.com/en/Terms-and-Conditions/Terms-e-Document.aspx>. Attention is drawn to the limitation of liability, indemnification and jurisdiction issues defined therein. Any holder of this document is advised that information contained herein reflects the Company's findings at the time of its intervention only and within the limits of Client's instructions, if any. The Company's sole responsibility is to its Client and this document does not exonerate parties to a transaction from exercising all their rights and obligations under the transaction documents. This document cannot be reproduced except in full, without prior written approval of the Company. Any unauthorized alteration, forgery or falsification of the content or appearance of this document is unlawful and offenders may be prosecuted to the fullest extent of the law. Unless otherwise stated the results shown in this test report refer only to the sample(s) tested and such sample(s) are retained for 30 days only.

Attention: To check the authenticity of testing/inspection report & certificate, please contact us at telephone: (86-755) 8307 1443, or email: [CN.Doccheck@sgs.com](mailto:CN.Doccheck@sgs.com)  
 1/E Unit D, Building 1, Kanglong Orange Science Park, No.157, Keyuan 3rd Road, Fengyang New Town, Xi'an, Shaanxi, China 710086  
 t (86-29) 6282 7885 www.sgs.com.cn  
 中国·西安·沣东新城科里三路157号康隆橙方科技园1号楼D单元1层 邮编: 710086 t (86-29) 6282 7885 sgs.china@sgs.com



11ac20MIMO	5500	Type6	19	1	333.3	9	0.3333	300	5401	1
11ac20MIMO	5500	Type6	19	1	333.3	9	0.3333	300	5390	1
11ac20MIMO	5500	Type6	19	1	333.3	9	0.3333	300	5447	1
11ac20MIMO	5500	Type6	19	1	333.3	9	0.3333	300	5450	1
11ac20MIMO	5500	Type6	19	1	333.3	9	0.3333	300	5608	1
11ac20MIMO	5500	Type6	19	1	333.3	9	0.3333	300	5334	1
11ac20MIMO	5500	Type6	19	1	333.3	9	0.3333	300	5507	1
11ac20MIMO	5500	Type6	19	1	333.3	9	0.3333	300	5615	1
11ac20MIMO	5500	Type6	19	1	333.3	9	0.3333	300	5524	1
11ac20MIMO	5500	Type6	19	1	333.3	9	0.3333	300	5285	1
11ac20MIMO	5500	Type6	19	1	333.3	9	0.3333	300	5322	1
11ac20MIMO	5500	Type6	19	1	333.3	9	0.3333	300	5430	1
11ac20MIMO	5500	Type6	19	1	333.3	9	0.3333	300	5433	1
11ac20MIMO	5500	Type6	19	1	333.3	9	0.3333	300	5621	1
11ac20MIMO	5500	Type6	19	1	333.3	9	0.3333	300	5662	1
11ac20MIMO	5500	Type6	19	1	333.3	9	0.3333	300	5719	1
11ac20MIMO	5500	Type6	19	1	333.3	9	0.3333	300	5589	1
11ac20MIMO	5500	Type6	19	1	333.3	9	0.3333	300	5528	1
11ac20MIMO	5500	Type6	19	1	333.3	9	0.3333	300	5515	1
11ac20MIMO	5500	Type6	19	1	333.3	9	0.3333	300	5292	1
11ac20MIMO	5500	Type6	19	1	333.3	9	0.3333	300	5462	1
11ac20MIMO	5500	Type6	19	1	333.3	9	0.3333	300	5566	1
11ac20MIMO	5500	Type6	19	1	333.3	9	0.3333	300	5307	1
11ac20MIMO	5500	Type6	19	1	333.3	9	0.3333	300	5284	1
11ac20MIMO	5500	Type6	19	1	333.3	9	0.3333	300	5296	1
11ac20MIMO	5500	Type6	19	1	333.3	9	0.3333	300	5474	1
11ac20MIMO	5500	Type6	19	1	333.3	9	0.3333	300	5724	1
11ac20MIMO	5500	Type6	19	1	333.3	9	0.3333	300	5399	1
11ac20MIMO	5500	Type6	19	1	333.3	9	0.3333	300	5710	1
11ac20MIMO	5500	Type6	19	1	333.3	9	0.3333	300	5250	1
11ac20MIMO	5500	Type6	19	1	333.3	9	0.3333	300	5353	1
11ac20MIMO	5500	Type6	19	1	333.3	9	0.3333	300	5509	1
11ac20MIMO	5500	Type6	19	1	333.3	9	0.3333	300	5303	1
11ac20MIMO	5500	Type6	19	1	333.3	9	0.3333	300	5597	1
11ac20MIMO	5500	Type6	19	1	333.3	9	0.3333	300	5407	1
11ac20MIMO	5500	Type6	19	1	333.3	9	0.3333	300	5428	1
11ac20MIMO	5500	Type6	19	1	333.3	9	0.3333	300	5562	1
11ac20MIMO	5500	Type6	19	1	333.3	9	0.3333	300	5678	1
11ac20MIMO	5500	Type6	19	1	333.3	9	0.3333	300	5300	1



Unless otherwise agreed in writing, this document is issued by the Company subject to its General Conditions of Service printed overleaf, available on request or accessible at <http://www.sgs.com/en/Terms-and-Conditions.aspx> and, for electronic format documents, subject to Terms and Conditions for Electronic Documents at <http://www.sgs.com/en/Terms-and-Conditions/Terms-e-Documents.aspx>. Attention is drawn to the limitation of liability, indemnification and jurisdiction issues defined therein. Any holder of this document is advised that information contained herein reflects the Company's findings at the time of its intervention only and within the limits of Client's instructions, if any. The Company's sole responsibility is to its Client and this document does not exonerate parties to a transaction from exercising all their rights and obligations under the transaction documents. This document cannot be reproduced except in full, without prior written approval of the Company. Any unauthorized alteration, forgery or falsification of the content or appearance of this document is unlawful and offenders may be prosecuted to the fullest extent of the law. Unless otherwise stated the results shown in this test report refer only to the sample(s) tested and such sample(s) are retained for 30 days only.

Attention: To check the authenticity of testing/inspection report & certificate, please contact us at telephone: (86-755) 4307 1443, or email: [CN.Doccheck@sgs.com](mailto:CN.Doccheck@sgs.com)

SGS-CSTC Standards Technical Services (Xi'an) Co., Ltd. | 1/E Unit D, Building 1, Kanghong Orange Source Park, No.137, Kejian 3rd Road, Fengling New Town, Xi'an, Shaanxi, China | 710086 | t (86-29) 6282 7885 | www.sgs.com.cn  
 中国·西安·沣东新城科里三路137号康鸿橙方科技园1号楼D单元1层 | 邮编: 710086 | t (86-29) 6282 7885 | sgs.china@sgs.com

TestMode	Channel	Radar Type	Trial ID	Pulse width (μs)	PRI (μs)	Pulses per Hop	Hop Rate (kHz)	Hop Sequence Length(ms)	Center Frequency (MHz)	Detection (1: Yes; 0: No)
11ac80MIMO	5530	Type6	20	1	333.3	9	0.3333	300	5704	1
11ac80MIMO	5530	Type6	20	1	333.3	9	0.3333	300	5466	1
11ac80MIMO	5530	Type6	20	1	333.3	9	0.3333	300	5479	1
11ac80MIMO	5530	Type6	20	1	333.3	9	0.3333	300	5309	1
11ac80MIMO	5530	Type6	20	1	333.3	9	0.3333	300	5597	1
11ac80MIMO	5530	Type6	20	1	333.3	9	0.3333	300	5687	1
11ac80MIMO	5530	Type6	20	1	333.3	9	0.3333	300	5680	1
11ac80MIMO	5530	Type6	20	1	333.3	9	0.3333	300	5710	1
11ac80MIMO	5530	Type6	20	1	333.3	9	0.3333	300	5428	1
11ac80MIMO	5530	Type6	20	1	333.3	9	0.3333	300	5639	1
11ac80MIMO	5530	Type6	20	1	333.3	9	0.3333	300	5566	1
11ac80MIMO	5530	Type6	20	1	333.3	9	0.3333	300	5379	1
11ac80MIMO	5530	Type6	20	1	333.3	9	0.3333	300	5356	1
11ac80MIMO	5530	Type6	20	1	333.3	9	0.3333	300	5634	1
11ac80MIMO	5530	Type6	20	1	333.3	9	0.3333	300	5533	1
11ac80MIMO	5530	Type6	20	1	333.3	9	0.3333	300	5471	1
11ac80MIMO	5530	Type6	20	1	333.3	9	0.3333	300	5318	1
11ac80MIMO	5530	Type6	20	1	333.3	9	0.3333	300	5543	1
11ac80MIMO	5530	Type6	20	1	333.3	9	0.3333	300	5422	1
11ac80MIMO	5530	Type6	20	1	333.3	9	0.3333	300	5311	1
11ac80MIMO	5530	Type6	20	1	333.3	9	0.3333	300	5592	1
11ac80MIMO	5530	Type6	20	1	333.3	9	0.3333	300	5665	1
11ac80MIMO	5530	Type6	20	1	333.3	9	0.3333	300	5641	1
11ac80MIMO	5530	Type6	20	1	333.3	9	0.3333	300	5443	1
11ac80MIMO	5530	Type6	20	1	333.3	9	0.3333	300	5390	1
11ac80MIMO	5530	Type6	20	1	333.3	9	0.3333	300	5569	1
11ac80MIMO	5530	Type6	20	1	333.3	9	0.3333	300	5350	1
11ac80MIMO	5530	Type6	20	1	333.3	9	0.3333	300	5622	1
11ac80MIMO	5530	Type6	20	1	333.3	9	0.3333	300	5449	1
11ac80MIMO	5530	Type6	20	1	333.3	9	0.3333	300	5435	1
11ac80MIMO	5530	Type6	20	1	333.3	9	0.3333	300	5653	1
11ac80MIMO	5530	Type6	20	1	333.3	9	0.3333	300	5586	1
11ac80MIMO	5530	Type6	20	1	333.3	9	0.3333	300	5300	1
11ac80MIMO	5530	Type6	20	1	333.3	9	0.3333	300	5537	1
11ac80MIMO	5530	Type6	20	1	333.3	9	0.3333	300	5667	1
11ac80MIMO	5530	Type6	20	1	333.3	9	0.3333	300	5325	1
11ac80MIMO	5530	Type6	20	1	333.3	9	0.3333	300	5585	1
11ac80MIMO	5530	Type6	20	1	333.3	9	0.3333	300	5608	1
11ac80MIMO	5530	Type6	20	1	333.3	9	0.3333	300	5269	1
11ac80MIMO	5530	Type6	20	1	333.3	9	0.3333	300	5521	1
11ac80MIMO	5530	Type6	20	1	333.3	9	0.3333	300	5263	1
11ac80MIMO	5530	Type6	20	1	333.3	9	0.3333	300	5314	1
11ac80MIMO	5530	Type6	20	1	333.3	9	0.3333	300	5509	1
11ac80MIMO	5530	Type6	20	1	333.3	9	0.3333	300	5504	1
11ac80MIMO	5530	Type6	20	1	333.3	9	0.3333	300	5529	1
11ac80MIMO	5530	Type6	20	1	333.3	9	0.3333	300	5408	1
11ac80MIMO	5530	Type6	20	1	333.3	9	0.3333	300	5528	1
11ac80MIMO	5530	Type6	20	1	333.3	9	0.3333	300	5525	1
11ac80MIMO	5530	Type6	20	1	333.3	9	0.3333	300	5393	1



Unless otherwise agreed in writing, this document is issued by the Company subject to its General Conditions of Service printed overleaf, available on request or accessible at <http://www.sgs.com/en/Terms-and-Conditions.aspx> and, for electronic format documents, subject to Terms and Conditions for Electronic Documents at <http://www.sgs.com/en/Terms-and-Conditions/Terms-e-Documents.aspx>. Attention is drawn to the limitation of liability, indemnification and jurisdiction issues defined therein. Any holder of this document is advised that information contained herein reflects the Company's findings at the time of its intervention only and within the limits of Client's instructions, if any. The Company's sole responsibility is to its Client and this document does not exonerate parties to a transaction from exercising all their rights and obligations under the transaction documents. This document cannot be reproduced except in full, without prior written approval of the Company. Any unauthorized alteration, forgery or falsification of the content or appearance of this document is unlawful and offenders may be prosecuted to the fullest extent of the law. Unless otherwise stated the results shown in this test report refer only to the sample(s) tested and such sample(s) are retained for 30 days only.

Attention: To check the authenticity of testing/inspection report & certificate, please contact us at telephone: (86-755) 8307 1443, or email: [CN.Doccheck@sgs.com](mailto:CN.Doccheck@sgs.com)

SGS-CSTC Standards Technical Services (Xi'an) Co., Ltd. | 1/E Unit D, Building 1, Kanglong Orange Science Park, No.157, Keyuan 3rd Road, Fengjing/Yue Town, Xi'an, Shaanxi, China | 710086 | t: (86-29) 6282 7885 | www.sgs.com.cn  
 中国·西安·沣东新城科里三路157号康隆橙方科技园1号楼D单元1层 | 邮编: 710086 | t: (86-29) 6282 7885 | sgs.china@sgs.com



11ac80MIMO	5530	Type6	20	1	333.3	9	0.3333	300	5572	1
11ac80MIMO	5530	Type6	20	1	333.3	9	0.3333	300	5343	1
11ac80MIMO	5530	Type6	20	1	333.3	9	0.3333	300	5646	1
11ac80MIMO	5530	Type6	20	1	333.3	9	0.3333	300	5333	1
11ac80MIMO	5530	Type6	20	1	333.3	9	0.3333	300	5386	1
11ac80MIMO	5530	Type6	20	1	333.3	9	0.3333	300	5502	1
11ac80MIMO	5530	Type6	20	1	333.3	9	0.3333	300	5660	1
11ac80MIMO	5530	Type6	20	1	333.3	9	0.3333	300	5688	1
11ac80MIMO	5530	Type6	20	1	333.3	9	0.3333	300	5554	1
11ac80MIMO	5530	Type6	20	1	333.3	9	0.3333	300	5465	1
11ac80MIMO	5530	Type6	20	1	333.3	9	0.3333	300	5677	1
11ac80MIMO	5530	Type6	20	1	333.3	9	0.3333	300	5338	1
11ac80MIMO	5530	Type6	20	1	333.3	9	0.3333	300	5326	1
11ac80MIMO	5530	Type6	20	1	333.3	9	0.3333	300	5454	1
11ac80MIMO	5530	Type6	20	1	333.3	9	0.3333	300	5260	1
11ac80MIMO	5530	Type6	20	1	333.3	9	0.3333	300	5615	1
11ac80MIMO	5530	Type6	20	1	333.3	9	0.3333	300	5403	1
11ac80MIMO	5530	Type6	20	1	333.3	9	0.3333	300	5347	1
11ac80MIMO	5530	Type6	20	1	333.3	9	0.3333	300	5591	1
11ac80MIMO	5530	Type6	20	1	333.3	9	0.3333	300	5396	1
11ac80MIMO	5530	Type6	20	1	333.3	9	0.3333	300	5555	1
11ac80MIMO	5530	Type6	20	1	333.3	9	0.3333	300	5515	1
11ac80MIMO	5530	Type6	20	1	333.3	9	0.3333	300	5579	1
11ac80MIMO	5530	Type6	20	1	333.3	9	0.3333	300	5601	1
11ac80MIMO	5530	Type6	20	1	333.3	9	0.3333	300	5527	1
11ac80MIMO	5530	Type6	20	1	333.3	9	0.3333	300	5387	1
11ac80MIMO	5530	Type6	20	1	333.3	9	0.3333	300	5261	1
11ac80MIMO	5530	Type6	20	1	333.3	9	0.3333	300	5707	1
11ac80MIMO	5530	Type6	20	1	333.3	9	0.3333	300	5291	1
11ac80MIMO	5530	Type6	20	1	333.3	9	0.3333	300	5550	1
11ac80MIMO	5530	Type6	20	1	333.3	9	0.3333	300	5602	1
11ac80MIMO	5530	Type6	20	1	333.3	9	0.3333	300	5439	1
11ac80MIMO	5530	Type6	20	1	333.3	9	0.3333	300	5257	1
11ac80MIMO	5530	Type6	20	1	333.3	9	0.3333	300	5370	1
11ac80MIMO	5530	Type6	20	1	333.3	9	0.3333	300	5692	1
11ac80MIMO	5530	Type6	20	1	333.3	9	0.3333	300	5498	1
11ac80MIMO	5530	Type6	20	1	333.3	9	0.3333	300	5512	1
11ac80MIMO	5530	Type6	20	1	333.3	9	0.3333	300	5487	1
11ac80MIMO	5530	Type6	20	1	333.3	9	0.3333	300	5719	1
11ac80MIMO	5530	Type6	20	1	333.3	9	0.3333	300	5401	1
11ac80MIMO	5530	Type6	20	1	333.3	9	0.3333	300	5650	1
11ac80MIMO	5530	Type6	20	1	333.3	9	0.3333	300	5335	1
11ac80MIMO	5530	Type6	20	1	333.3	9	0.3333	300	5402	1
11ac80MIMO	5530	Type6	20	1	333.3	9	0.3333	300	5255	1
11ac80MIMO	5530	Type6	20	1	333.3	9	0.3333	300	5659	1
11ac80MIMO	5530	Type6	20	1	333.3	9	0.3333	300	5722	1
11ac80MIMO	5530	Type6	20	1	333.3	9	0.3333	300	5364	1
11ac80MIMO	5530	Type6	20	1	333.3	9	0.3333	300	5493	1
11ac80MIMO	5530	Type6	20	1	333.3	9	0.3333	300	5676	1
11ac80MIMO	5530	Type6	20	1	333.3	9	0.3333	300	5510	1
11ac80MIMO	5530	Type6	20	1	333.3	9	0.3333	300	5700	1
11ac40MIMO	5510	Type6	20	1	333.3	9	0.3333	300	5704	1
11ac40MIMO	5510	Type6	20	1	333.3	9	0.3333	300	5466	1



Unless otherwise agreed in writing, this document is issued by the Company subject to its General Conditions of Service printed overleaf, available on request or accessible at <http://www.sgs.com/en/Terms-and-Conditions.aspx> and, for electronic format documents, subject to Terms and Conditions for Electronic Documents at <http://www.sgs.com/en/Terms-and-Conditions/Terms-e-Documents.aspx>. Attention is drawn to the limitation of liability, indemnification and jurisdiction issues defined therein. Any holder of this document is advised that information contained herein reflects the Company's findings at the time of its intervention only and within the limits of Client's instructions, if any. The Company's sole responsibility is to its Client and this document does not exonerate parties to a transaction from exercising all their rights and obligations under the transaction documents. This document cannot be reproduced except in full, without prior written approval of the Company. Any unauthorized alteration, forgery or falsification of the content or appearance of this document is unlawful and offenders may be prosecuted to the fullest extent of the law. Unless otherwise stated the results shown in this test report refer only to the sample(s) tested and such sample(s) are retained for 30 days only.

Attention: To check the authenticity of testing inspection report & certificate, please contact us at telephone: (86-755) 8307 1443, or email: [CN.Doccheck@sgs.com](mailto:CN.Doccheck@sgs.com)  
 (E) Unit D, Building 1, Kanglong Orange Science Park, No.157, Keyuan 3rd Road, Fengyang New Town, Xian, Shaanxi, China 710086  
 t (86-29) 6282 7885 www.sgs.com.cn  
 中国·西安·沣东新城科里三路157号康隆橙方科技园1号楼D单元1层 邮编: 710086 t (86-29) 6282 7885 sgs.china@sgs.com

11ac40MIMO	5510	Type6	20	1	333.3	9	0.3333	300	5479	1
11ac40MIMO	5510	Type6	20	1	333.3	9	0.3333	300	5309	1
11ac40MIMO	5510	Type6	20	1	333.3	9	0.3333	300	5597	1
11ac40MIMO	5510	Type6	20	1	333.3	9	0.3333	300	5687	1
11ac40MIMO	5510	Type6	20	1	333.3	9	0.3333	300	5680	1
11ac40MIMO	5510	Type6	20	1	333.3	9	0.3333	300	5710	1
11ac40MIMO	5510	Type6	20	1	333.3	9	0.3333	300	5428	1
11ac40MIMO	5510	Type6	20	1	333.3	9	0.3333	300	5639	1
11ac40MIMO	5510	Type6	20	1	333.3	9	0.3333	300	5566	1
11ac40MIMO	5510	Type6	20	1	333.3	9	0.3333	300	5379	1
11ac40MIMO	5510	Type6	20	1	333.3	9	0.3333	300	5356	1
11ac40MIMO	5510	Type6	20	1	333.3	9	0.3333	300	5634	1
11ac40MIMO	5510	Type6	20	1	333.3	9	0.3333	300	5533	1
11ac40MIMO	5510	Type6	20	1	333.3	9	0.3333	300	5471	1
11ac40MIMO	5510	Type6	20	1	333.3	9	0.3333	300	5318	1
11ac40MIMO	5510	Type6	20	1	333.3	9	0.3333	300	5543	1
11ac40MIMO	5510	Type6	20	1	333.3	9	0.3333	300	5422	1
11ac40MIMO	5510	Type6	20	1	333.3	9	0.3333	300	5311	1
11ac40MIMO	5510	Type6	20	1	333.3	9	0.3333	300	5592	1
11ac40MIMO	5510	Type6	20	1	333.3	9	0.3333	300	5665	1
11ac40MIMO	5510	Type6	20	1	333.3	9	0.3333	300	5641	1
11ac40MIMO	5510	Type6	20	1	333.3	9	0.3333	300	5443	1
11ac40MIMO	5510	Type6	20	1	333.3	9	0.3333	300	5390	1
11ac40MIMO	5510	Type6	20	1	333.3	9	0.3333	300	5569	1
11ac40MIMO	5510	Type6	20	1	333.3	9	0.3333	300	5350	1
11ac40MIMO	5510	Type6	20	1	333.3	9	0.3333	300	5622	1
11ac40MIMO	5510	Type6	20	1	333.3	9	0.3333	300	5449	1
11ac40MIMO	5510	Type6	20	1	333.3	9	0.3333	300	5435	1
11ac40MIMO	5510	Type6	20	1	333.3	9	0.3333	300	5653	1
11ac40MIMO	5510	Type6	20	1	333.3	9	0.3333	300	5586	1
11ac40MIMO	5510	Type6	20	1	333.3	9	0.3333	300	5300	1
11ac40MIMO	5510	Type6	20	1	333.3	9	0.3333	300	5537	1
11ac40MIMO	5510	Type6	20	1	333.3	9	0.3333	300	5667	1
11ac40MIMO	5510	Type6	20	1	333.3	9	0.3333	300	5325	1
11ac40MIMO	5510	Type6	20	1	333.3	9	0.3333	300	5585	1
11ac40MIMO	5510	Type6	20	1	333.3	9	0.3333	300	5608	1
11ac40MIMO	5510	Type6	20	1	333.3	9	0.3333	300	5269	1
11ac40MIMO	5510	Type6	20	1	333.3	9	0.3333	300	5521	1
11ac40MIMO	5510	Type6	20	1	333.3	9	0.3333	300	5263	1
11ac40MIMO	5510	Type6	20	1	333.3	9	0.3333	300	5314	1
11ac40MIMO	5510	Type6	20	1	333.3	9	0.3333	300	5509	1
11ac40MIMO	5510	Type6	20	1	333.3	9	0.3333	300	5504	1
11ac40MIMO	5510	Type6	20	1	333.3	9	0.3333	300	5529	1
11ac40MIMO	5510	Type6	20	1	333.3	9	0.3333	300	5408	1
11ac40MIMO	5510	Type6	20	1	333.3	9	0.3333	300	5528	1
11ac40MIMO	5510	Type6	20	1	333.3	9	0.3333	300	5525	1
11ac40MIMO	5510	Type6	20	1	333.3	9	0.3333	300	5393	1
11ac40MIMO	5510	Type6	20	1	333.3	9	0.3333	300	5572	1
11ac40MIMO	5510	Type6	20	1	333.3	9	0.3333	300	5343	1
11ac40MIMO	5510	Type6	20	1	333.3	9	0.3333	300	5646	1
11ac40MIMO	5510	Type6	20	1	333.3	9	0.3333	300	5333	1
11ac40MIMO	5510	Type6	20	1	333.3	9	0.3333	300	5386	1
11ac40MIMO	5510	Type6	20	1	333.3	9	0.3333	300	5502	1



Unless otherwise agreed in writing, this document is issued by the Company subject to its General Conditions of Service printed overleaf, available on request or accessible at <http://www.sgs.com/en/Terms-and-Conditions.aspx> and, for electronic format documents, subject to Terms and Conditions for Electronic Documents at <http://www.sgs.com/en/Terms-and-Conditions/Terms-e-Document.aspx>. Attention is drawn to the limitation of liability, indemnification and jurisdiction issues defined therein. Any holder of this document is advised that information contained herein reflects the Company's findings at the time of its intervention only and within the limits of Client's instructions, if any. The Company's sole responsibility is to its Client and this document does not exonerate parties to a transaction from exercising all their rights and obligations under the transaction documents. This document cannot be reproduced except in full, without prior written approval of the Company. Any unauthorized alteration, forgery or falsification of the content or appearance of this document is unlawful and offenders may be prosecuted to the fullest extent of the law. Unless otherwise stated the results shown in this test report refer only to the sample(s) tested and such sample(s) are retained for 30 days only.

Attention: To check the authenticity of testing/inspection report & certificate, please contact us at telephone: (86-755) 8307 1443, or email: [CN.Doccheck@sgs.com](mailto:CN.Doccheck@sgs.com)  
 (E) Unit D, Building 1, Kanglong Orange Science Park, No.157, Keyuan 3rd Road, Fengyang New Town, Xi'an, Shaanxi, China 710086  
 t (86-29) 6282 7885 www.sgs.com.cn  
 中国·西安·沣东新城科里三路157号康隆橙方科技园1号楼D单元1层 邮编: 710086 t (86-29) 6282 7885 sgs.china@sgs.com

Report No.: XEWA2310000070RG05

Rev.: 01

Page: 211 of 267

11ac40MIMO	5510	Type6	20	1	333.3	9	0.3333	300	5660	1
11ac40MIMO	5510	Type6	20	1	333.3	9	0.3333	300	5688	1
11ac40MIMO	5510	Type6	20	1	333.3	9	0.3333	300	5554	1
11ac40MIMO	5510	Type6	20	1	333.3	9	0.3333	300	5465	1
11ac40MIMO	5510	Type6	20	1	333.3	9	0.3333	300	5677	1
11ac40MIMO	5510	Type6	20	1	333.3	9	0.3333	300	5338	1
11ac40MIMO	5510	Type6	20	1	333.3	9	0.3333	300	5326	1
11ac40MIMO	5510	Type6	20	1	333.3	9	0.3333	300	5454	1
11ac40MIMO	5510	Type6	20	1	333.3	9	0.3333	300	5260	1
11ac40MIMO	5510	Type6	20	1	333.3	9	0.3333	300	5615	1
11ac40MIMO	5510	Type6	20	1	333.3	9	0.3333	300	5403	1
11ac40MIMO	5510	Type6	20	1	333.3	9	0.3333	300	5347	1
11ac40MIMO	5510	Type6	20	1	333.3	9	0.3333	300	5591	1
11ac40MIMO	5510	Type6	20	1	333.3	9	0.3333	300	5396	1
11ac40MIMO	5510	Type6	20	1	333.3	9	0.3333	300	5555	1
11ac40MIMO	5510	Type6	20	1	333.3	9	0.3333	300	5515	1
11ac40MIMO	5510	Type6	20	1	333.3	9	0.3333	300	5579	1
11ac40MIMO	5510	Type6	20	1	333.3	9	0.3333	300	5601	1
11ac40MIMO	5510	Type6	20	1	333.3	9	0.3333	300	5527	1
11ac40MIMO	5510	Type6	20	1	333.3	9	0.3333	300	5387	1
11ac40MIMO	5510	Type6	20	1	333.3	9	0.3333	300	5261	1
11ac40MIMO	5510	Type6	20	1	333.3	9	0.3333	300	5707	1
11ac40MIMO	5510	Type6	20	1	333.3	9	0.3333	300	5291	1
11ac40MIMO	5510	Type6	20	1	333.3	9	0.3333	300	5550	1
11ac40MIMO	5510	Type6	20	1	333.3	9	0.3333	300	5602	1
11ac40MIMO	5510	Type6	20	1	333.3	9	0.3333	300	5439	1
11ac40MIMO	5510	Type6	20	1	333.3	9	0.3333	300	5257	1
11ac40MIMO	5510	Type6	20	1	333.3	9	0.3333	300	5370	1
11ac40MIMO	5510	Type6	20	1	333.3	9	0.3333	300	5692	1
11ac40MIMO	5510	Type6	20	1	333.3	9	0.3333	300	5498	1
11ac40MIMO	5510	Type6	20	1	333.3	9	0.3333	300	5512	1
11ac40MIMO	5510	Type6	20	1	333.3	9	0.3333	300	5487	1
11ac40MIMO	5510	Type6	20	1	333.3	9	0.3333	300	5719	1
11ac40MIMO	5510	Type6	20	1	333.3	9	0.3333	300	5401	1
11ac40MIMO	5510	Type6	20	1	333.3	9	0.3333	300	5650	1
11ac40MIMO	5510	Type6	20	1	333.3	9	0.3333	300	5335	1
11ac40MIMO	5510	Type6	20	1	333.3	9	0.3333	300	5402	1
11ac40MIMO	5510	Type6	20	1	333.3	9	0.3333	300	5255	1
11ac40MIMO	5510	Type6	20	1	333.3	9	0.3333	300	5659	1
11ac40MIMO	5510	Type6	20	1	333.3	9	0.3333	300	5722	1
11ac40MIMO	5510	Type6	20	1	333.3	9	0.3333	300	5364	1
11ac40MIMO	5510	Type6	20	1	333.3	9	0.3333	300	5493	1
11ac40MIMO	5510	Type6	20	1	333.3	9	0.3333	300	5676	1
11ac40MIMO	5510	Type6	20	1	333.3	9	0.3333	300	5510	1
11ac40MIMO	5510	Type6	20	1	333.3	9	0.3333	300	5700	1
11ac20MIMO	5500	Type6	20	1	333.3	9	0.3333	300	5704	1
11ac20MIMO	5500	Type6	20	1	333.3	9	0.3333	300	5466	1
11ac20MIMO	5500	Type6	20	1	333.3	9	0.3333	300	5479	1
11ac20MIMO	5500	Type6	20	1	333.3	9	0.3333	300	5309	1
11ac20MIMO	5500	Type6	20	1	333.3	9	0.3333	300	5597	1
11ac20MIMO	5500	Type6	20	1	333.3	9	0.3333	300	5687	1
11ac20MIMO	5500	Type6	20	1	333.3	9	0.3333	300	5680	1
11ac20MIMO	5500	Type6	20	1	333.3	9	0.3333	300	5710	1



Unless otherwise agreed in writing, this document is issued by the Company subject to its General Conditions of Service printed overleaf, available on request or accessible at <http://www.sgs.com/en/Terms-and-Conditions.aspx> and, for electronic format documents, subject to Terms and Conditions for Electronic Documents at <http://www.sgs.com/en/Terms-and-Conditions/Terms-e-Documents.aspx>. Attention is drawn to the limitation of liability, indemnification and jurisdiction issues defined therein. Any holder of this document is advised that information contained herein reflects the Company's findings at the time of its intervention only and within the limits of Client's instructions, if any. The Company's sole responsibility is to its Client and this document does not exonerate parties to a transaction from exercising all their rights and obligations under the transaction documents. This document cannot be reproduced except in full, without prior written approval of the Company. Any unauthorized alteration, forgery or falsification of the content or appearance of this document is unlawful and offenders may be prosecuted to the fullest extent of the law. Unless otherwise stated the results shown in this test report refer only to the sample(s) tested and such sample(s) are retained for 30 days only.

Attention: To check the authenticity of testing/inspection report & certificate, please contact us at telephone: (86-755) 8307 1443, or email: [CN.Doccheck@sgs.com](mailto:CN.Doccheck@sgs.com)  
 (E) Unit D, Building 1, Kanglong Orange Science Park, No.157, Keyuan 3rd Road, Fengjing/Yue Town, Xi'an, Shaanxi, China 710086  
 t (86-29) 6282 7885 www.sgs.com.cn  
 中国·西安·沣东新城科里三路157号康隆橙方科技园1号楼D单元1层 邮编: 710086 t (86-29) 6282 7885 sgs.china@sgs.com

11ac20MIMO	5500	Type6	20	1	333.3	9	0.3333	300	5428	1
11ac20MIMO	5500	Type6	20	1	333.3	9	0.3333	300	5639	1
11ac20MIMO	5500	Type6	20	1	333.3	9	0.3333	300	5566	1
11ac20MIMO	5500	Type6	20	1	333.3	9	0.3333	300	5379	1
11ac20MIMO	5500	Type6	20	1	333.3	9	0.3333	300	5356	1
11ac20MIMO	5500	Type6	20	1	333.3	9	0.3333	300	5634	1
11ac20MIMO	5500	Type6	20	1	333.3	9	0.3333	300	5533	1
11ac20MIMO	5500	Type6	20	1	333.3	9	0.3333	300	5471	1
11ac20MIMO	5500	Type6	20	1	333.3	9	0.3333	300	5318	1
11ac20MIMO	5500	Type6	20	1	333.3	9	0.3333	300	5543	1
11ac20MIMO	5500	Type6	20	1	333.3	9	0.3333	300	5422	1
11ac20MIMO	5500	Type6	20	1	333.3	9	0.3333	300	5311	1
11ac20MIMO	5500	Type6	20	1	333.3	9	0.3333	300	5592	1
11ac20MIMO	5500	Type6	20	1	333.3	9	0.3333	300	5665	1
11ac20MIMO	5500	Type6	20	1	333.3	9	0.3333	300	5641	1
11ac20MIMO	5500	Type6	20	1	333.3	9	0.3333	300	5443	1
11ac20MIMO	5500	Type6	20	1	333.3	9	0.3333	300	5390	1
11ac20MIMO	5500	Type6	20	1	333.3	9	0.3333	300	5569	1
11ac20MIMO	5500	Type6	20	1	333.3	9	0.3333	300	5350	1
11ac20MIMO	5500	Type6	20	1	333.3	9	0.3333	300	5622	1
11ac20MIMO	5500	Type6	20	1	333.3	9	0.3333	300	5449	1
11ac20MIMO	5500	Type6	20	1	333.3	9	0.3333	300	5435	1
11ac20MIMO	5500	Type6	20	1	333.3	9	0.3333	300	5653	1
11ac20MIMO	5500	Type6	20	1	333.3	9	0.3333	300	5586	1
11ac20MIMO	5500	Type6	20	1	333.3	9	0.3333	300	5300	1
11ac20MIMO	5500	Type6	20	1	333.3	9	0.3333	300	5537	1
11ac20MIMO	5500	Type6	20	1	333.3	9	0.3333	300	5667	1
11ac20MIMO	5500	Type6	20	1	333.3	9	0.3333	300	5325	1
11ac20MIMO	5500	Type6	20	1	333.3	9	0.3333	300	5585	1
11ac20MIMO	5500	Type6	20	1	333.3	9	0.3333	300	5608	1
11ac20MIMO	5500	Type6	20	1	333.3	9	0.3333	300	5269	1
11ac20MIMO	5500	Type6	20	1	333.3	9	0.3333	300	5521	1
11ac20MIMO	5500	Type6	20	1	333.3	9	0.3333	300	5263	1
11ac20MIMO	5500	Type6	20	1	333.3	9	0.3333	300	5314	1
11ac20MIMO	5500	Type6	20	1	333.3	9	0.3333	300	5509	1
11ac20MIMO	5500	Type6	20	1	333.3	9	0.3333	300	5504	1
11ac20MIMO	5500	Type6	20	1	333.3	9	0.3333	300	5529	1
11ac20MIMO	5500	Type6	20	1	333.3	9	0.3333	300	5408	1
11ac20MIMO	5500	Type6	20	1	333.3	9	0.3333	300	5528	1
11ac20MIMO	5500	Type6	20	1	333.3	9	0.3333	300	5525	1
11ac20MIMO	5500	Type6	20	1	333.3	9	0.3333	300	5393	1
11ac20MIMO	5500	Type6	20	1	333.3	9	0.3333	300	5572	1
11ac20MIMO	5500	Type6	20	1	333.3	9	0.3333	300	5343	1
11ac20MIMO	5500	Type6	20	1	333.3	9	0.3333	300	5646	1
11ac20MIMO	5500	Type6	20	1	333.3	9	0.3333	300	5333	1
11ac20MIMO	5500	Type6	20	1	333.3	9	0.3333	300	5386	1
11ac20MIMO	5500	Type6	20	1	333.3	9	0.3333	300	5502	1
11ac20MIMO	5500	Type6	20	1	333.3	9	0.3333	300	5660	1
11ac20MIMO	5500	Type6	20	1	333.3	9	0.3333	300	5688	1
11ac20MIMO	5500	Type6	20	1	333.3	9	0.3333	300	5554	1
11ac20MIMO	5500	Type6	20	1	333.3	9	0.3333	300	5465	1
11ac20MIMO	5500	Type6	20	1	333.3	9	0.3333	300	5677	1
11ac20MIMO	5500	Type6	20	1	333.3	9	0.3333	300	5338	1



Unless otherwise agreed in writing, this document is issued by the Company subject to its General Conditions of Service printed overleaf, available on request or accessible at <http://www.sgs.com/en/Terms-and-Conditions.aspx> and, for electronic format documents, subject to Terms and Conditions for Electronic Documents at <http://www.sgs.com/en/Terms-and-Conditions/Terms-e-Document.aspx>. Attention is drawn to the limitation of liability, indemnification and jurisdiction issues defined therein. Any holder of this document is advised that information contained herein reflects the Company's findings at the time of its intervention only and within the limits of Client's instructions, if any. The Company's sole responsibility is to its Client and this document does not exonerate parties to a transaction from exercising all their rights and obligations under the transaction documents. This document cannot be reproduced except in full, without prior written approval of the Company. Any unauthorized alteration, forgery or falsification of the content or appearance of this document is unlawful and offenders may be prosecuted to the fullest extent of the law. Unless otherwise stated the results shown in this test report refer only to the sample(s) tested and such sample(s) are retained for 30 days only.

Attention: To check the authenticity of testing/inspection report & certificate, please contact us at telephone: (86-755) 8307 1443, or email: [CN.Doccheck@sgs.com](mailto:CN.Doccheck@sgs.com)  
 (E) Unit D, Building 1, Kanglong Orange Science Park, No.157, Keyuan 3rd Road, Fengjing New Town, Xian, Shaanxi, China 710086  
 t (86-29) 6282 7885 www.sgs.com.cn  
 中国·西安·沣东新城科里三路157号康隆橙方科技园1号楼D单元1层 邮编: 710086 t (86-29) 6282 7885 sgs.china@sgs.com

Report No.: XEWA2310000070RG05

Rev.: 01

Page: 213 of 267

11ac20MIMO	5500	Type6	20	1	333.3	9	0.3333	300	5326	1
11ac20MIMO	5500	Type6	20	1	333.3	9	0.3333	300	5454	1
11ac20MIMO	5500	Type6	20	1	333.3	9	0.3333	300	5260	1
11ac20MIMO	5500	Type6	20	1	333.3	9	0.3333	300	5615	1
11ac20MIMO	5500	Type6	20	1	333.3	9	0.3333	300	5403	1
11ac20MIMO	5500	Type6	20	1	333.3	9	0.3333	300	5347	1
11ac20MIMO	5500	Type6	20	1	333.3	9	0.3333	300	5591	1
11ac20MIMO	5500	Type6	20	1	333.3	9	0.3333	300	5396	1
11ac20MIMO	5500	Type6	20	1	333.3	9	0.3333	300	5555	1
11ac20MIMO	5500	Type6	20	1	333.3	9	0.3333	300	5515	1
11ac20MIMO	5500	Type6	20	1	333.3	9	0.3333	300	5579	1
11ac20MIMO	5500	Type6	20	1	333.3	9	0.3333	300	5601	1
11ac20MIMO	5500	Type6	20	1	333.3	9	0.3333	300	5527	1
11ac20MIMO	5500	Type6	20	1	333.3	9	0.3333	300	5387	1
11ac20MIMO	5500	Type6	20	1	333.3	9	0.3333	300	5261	1
11ac20MIMO	5500	Type6	20	1	333.3	9	0.3333	300	5707	1
11ac20MIMO	5500	Type6	20	1	333.3	9	0.3333	300	5291	1
11ac20MIMO	5500	Type6	20	1	333.3	9	0.3333	300	5550	1
11ac20MIMO	5500	Type6	20	1	333.3	9	0.3333	300	5602	1
11ac20MIMO	5500	Type6	20	1	333.3	9	0.3333	300	5439	1
11ac20MIMO	5500	Type6	20	1	333.3	9	0.3333	300	5257	1
11ac20MIMO	5500	Type6	20	1	333.3	9	0.3333	300	5370	1
11ac20MIMO	5500	Type6	20	1	333.3	9	0.3333	300	5692	1
11ac20MIMO	5500	Type6	20	1	333.3	9	0.3333	300	5498	1
11ac20MIMO	5500	Type6	20	1	333.3	9	0.3333	300	5512	1
11ac20MIMO	5500	Type6	20	1	333.3	9	0.3333	300	5487	1
11ac20MIMO	5500	Type6	20	1	333.3	9	0.3333	300	5719	1
11ac20MIMO	5500	Type6	20	1	333.3	9	0.3333	300	5401	1
11ac20MIMO	5500	Type6	20	1	333.3	9	0.3333	300	5650	1
11ac20MIMO	5500	Type6	20	1	333.3	9	0.3333	300	5335	1
11ac20MIMO	5500	Type6	20	1	333.3	9	0.3333	300	5402	1
11ac20MIMO	5500	Type6	20	1	333.3	9	0.3333	300	5255	1
11ac20MIMO	5500	Type6	20	1	333.3	9	0.3333	300	5659	1
11ac20MIMO	5500	Type6	20	1	333.3	9	0.3333	300	5722	1
11ac20MIMO	5500	Type6	20	1	333.3	9	0.3333	300	5364	1
11ac20MIMO	5500	Type6	20	1	333.3	9	0.3333	300	5493	1
11ac20MIMO	5500	Type6	20	1	333.3	9	0.3333	300	5676	1
11ac20MIMO	5500	Type6	20	1	333.3	9	0.3333	300	5510	1
11ac20MIMO	5500	Type6	20	1	333.3	9	0.3333	300	5700	1



Unless otherwise agreed in writing, this document is issued by the Company subject to its General Conditions of Service printed overleaf, available on request or accessible at <http://www.sgs.com/en/Terms-and-Conditions.aspx> and, for electronic format documents, subject to Terms and Conditions for Electronic Documents at <http://www.sgs.com/en/Terms-and-Conditions/Terms-e-Documents.aspx>. Attention is drawn to the limitation of liability, indemnification and jurisdiction issues defined therein. Any holder of this document is advised that information contained herein reflects the Company's findings at the time of its intervention only and within the limits of Client's instructions, if any. The Company's sole responsibility is to its Client and this document does not exonerate parties to a transaction from exercising all their rights and obligations under the transaction documents. This document cannot be reproduced except in full, without prior written approval of the Company. Any unauthorized alteration, forgery or falsification of the content or appearance of this document is unlawful and offenders may be prosecuted to the fullest extent of the law. Unless otherwise stated the results shown in this test report refer only to the sample(s) tested and such sample(s) are retained for 30 days only.

Attention: To check the authenticity of testing/inspection report & certificate, please contact us at telephone: (86-755) 4307 1443, or email: [CN.Doccheck@sgs.com](mailto:CN.Doccheck@sgs.com)  
 (SGS-CSTC) Standards Technical Services (Xi'an) Co., Ltd. | 1/E Unit D, Building 1, Kanghong Orange Source Park, No.137, Kejian 3rd Road, Fengling New Town, Xi'an, Shaanxi, China | 710086 | t: (86-29) 6282 7885 | www.sgs.com.cn  
 中国·西安·沣东新城科里三路137号康鸿橙方科技园1号楼D单元1层 | 邮编: 710086 | t: (86-29) 6282 7885 | sgs.china@sgs.com

TestMode	Channel	Radar Type	Trial ID	Pulse width (μs)	PRI (μs)	Pulses per Hop	Hop Rate (kHz)	Hop Sequence Length(ms)	Center Frequency (MHz)	Detection (1: Yes; 0: No)
11ac80MIMO	5530	Type6	21	1	333.3	9	0.3333	300	5484	1
11ac80MIMO	5530	Type6	21	1	333.3	9	0.3333	300	5705	1
11ac80MIMO	5530	Type6	21	1	333.3	9	0.3333	300	5415	1
11ac80MIMO	5530	Type6	21	1	333.3	9	0.3333	300	5470	1
11ac80MIMO	5530	Type6	21	1	333.3	9	0.3333	300	5439	1
11ac80MIMO	5530	Type6	21	1	333.3	9	0.3333	300	5351	1
11ac80MIMO	5530	Type6	21	1	333.3	9	0.3333	300	5702	1
11ac80MIMO	5530	Type6	21	1	333.3	9	0.3333	300	5310	1
11ac80MIMO	5530	Type6	21	1	333.3	9	0.3333	300	5591	1
11ac80MIMO	5530	Type6	21	1	333.3	9	0.3333	300	5371	1
11ac80MIMO	5530	Type6	21	1	333.3	9	0.3333	300	5497	1
11ac80MIMO	5530	Type6	21	1	333.3	9	0.3333	300	5265	1
11ac80MIMO	5530	Type6	21	1	333.3	9	0.3333	300	5494	1
11ac80MIMO	5530	Type6	21	1	333.3	9	0.3333	300	5354	1
11ac80MIMO	5530	Type6	21	1	333.3	9	0.3333	300	5554	1
11ac80MIMO	5530	Type6	21	1	333.3	9	0.3333	300	5559	1
11ac80MIMO	5530	Type6	21	1	333.3	9	0.3333	300	5445	1
11ac80MIMO	5530	Type6	21	1	333.3	9	0.3333	300	5646	1
11ac80MIMO	5530	Type6	21	1	333.3	9	0.3333	300	5370	1
11ac80MIMO	5530	Type6	21	1	333.3	9	0.3333	300	5503	1
11ac80MIMO	5530	Type6	21	1	333.3	9	0.3333	300	5600	1
11ac80MIMO	5530	Type6	21	1	333.3	9	0.3333	300	5356	1
11ac80MIMO	5530	Type6	21	1	333.3	9	0.3333	300	5252	1
11ac80MIMO	5530	Type6	21	1	333.3	9	0.3333	300	5255	1
11ac80MIMO	5530	Type6	21	1	333.3	9	0.3333	300	5416	1
11ac80MIMO	5530	Type6	21	1	333.3	9	0.3333	300	5656	1
11ac80MIMO	5530	Type6	21	1	333.3	9	0.3333	300	5421	1
11ac80MIMO	5530	Type6	21	1	333.3	9	0.3333	300	5456	1
11ac80MIMO	5530	Type6	21	1	333.3	9	0.3333	300	5251	1
11ac80MIMO	5530	Type6	21	1	333.3	9	0.3333	300	5483	1
11ac80MIMO	5530	Type6	21	1	333.3	9	0.3333	300	5477	1
11ac80MIMO	5530	Type6	21	1	333.3	9	0.3333	300	5542	1
11ac80MIMO	5530	Type6	21	1	333.3	9	0.3333	300	5543	1
11ac80MIMO	5530	Type6	21	1	333.3	9	0.3333	300	5418	1
11ac80MIMO	5530	Type6	21	1	333.3	9	0.3333	300	5311	1
11ac80MIMO	5530	Type6	21	1	333.3	9	0.3333	300	5390	1
11ac80MIMO	5530	Type6	21	1	333.3	9	0.3333	300	5464	1
11ac80MIMO	5530	Type6	21	1	333.3	9	0.3333	300	5676	1
11ac80MIMO	5530	Type6	21	1	333.3	9	0.3333	300	5501	1
11ac80MIMO	5530	Type6	21	1	333.3	9	0.3333	300	5422	1
11ac80MIMO	5530	Type6	21	1	333.3	9	0.3333	300	5435	1
11ac80MIMO	5530	Type6	21	1	333.3	9	0.3333	300	5674	1
11ac80MIMO	5530	Type6	21	1	333.3	9	0.3333	300	5447	1
11ac80MIMO	5530	Type6	21	1	333.3	9	0.3333	300	5269	1
11ac80MIMO	5530	Type6	21	1	333.3	9	0.3333	300	5526	1
11ac80MIMO	5530	Type6	21	1	333.3	9	0.3333	300	5337	1
11ac80MIMO	5530	Type6	21	1	333.3	9	0.3333	300	5508	1
11ac80MIMO	5530	Type6	21	1	333.3	9	0.3333	300	5608	1
11ac80MIMO	5530	Type6	21	1	333.3	9	0.3333	300	5451	1



Unless otherwise agreed in writing, this document is issued by the Company subject to its General Conditions of Service printed overleaf, available on request or accessible at <http://www.sgs.com/en/Terms-and-Conditions.aspx> and, for electronic format documents, subject to Terms and Conditions for Electronic Documents at <http://www.sgs.com/en/Terms-and-Conditions/Terms-e-Documents.aspx>. Attention is drawn to the limitation of liability, indemnification and jurisdiction issues defined therein. Any holder of this document is advised that information contained herein reflects the Company's findings at the time of its intervention only and within the limits of Client's instructions, if any. The Company's sole responsibility is to its Client and this document does not exonerate parties to a transaction from exercising all their rights and obligations under the transaction documents. This document cannot be reproduced except in full, without prior written approval of the Company. Any unauthorized alteration, forgery or falsification of the content or appearance of this document is unlawful and offenders may be prosecuted to the fullest extent of the law. Unless otherwise stated the results shown in this test report refer only to the sample(s) tested and such sample(s) are retained for 30 days only.

Attention: To check the authenticity of testing/inspection report & certificate, please contact us at telephone: (86-755) 8307 1443, or email: [CN.Doccheck@sgs.com](mailto:CN.Doccheck@sgs.com)

SGS-CSTC Standards Technical Services (Xi'an) Co., Ltd. | 1/E Unit D, Building 1, Kanglong Orange Science Park, No.157, Keyuan3rd Road, Fengjing/Yue Town, Xi'an, Shaanxi, China | 710086 | t (86-29) 6282 7885 | www.sgs.com.cn  
 中国·西安·沣东新城科里三路157号康鸿橙方科技园1号楼D单元1层 | 邮编: 710086 | t (86-29) 6282 7885 | sgs.china@sgs.com



Table with 11 columns: Item ID, Value, Type, and various test parameters. Rows include items like 11ac80MIMO and 11ac40MIMO with values such as 5530, 5510, and 5533.



Unless otherwise agreed in writing, this document is issued by the Company subject to its General Conditions of Service printed overleaf, available on request or accessible at http://www.sgs.com/en/Terms-and-Conditions.aspx and, for electronic format documents, subject to Terms and Conditions for Electronic Documents at http://www.sgs.com/en/Terms-and-Conditions/Terms-e-Documents.aspx. Attention is drawn to the limitation of liability, indemnification and jurisdiction issues defined therein. Any holder of this document is advised that information contained herein reflects the Company's findings at the time of its intervention only and within the limits of Client's instructions, if any. The Company's sole responsibility is to its Client and this document does not exonerate parties to a transaction from exercising all their rights and obligations under the transaction documents. This document cannot be reproduced except in full, without prior written approval of the Company. Any unauthorized alteration, forgery or falsification of the content or appearance of this document is unlawful and offenders may be prosecuted to the fullest extent of the law. Unless otherwise stated the results shown in this test report refer only to the sample(s) tested and such sample(s) are retained for 30 days only. Attention: To check the authenticity of testing/inspection report & certificate, please contact us at telephone: (86-755) 8307 1443, or email: CN.Doccheck@sgs.com



11ac40MIMO	5510	Type6	21	1	333.3	9	0.3333	300	5415	1
11ac40MIMO	5510	Type6	21	1	333.3	9	0.3333	300	5470	1
11ac40MIMO	5510	Type6	21	1	333.3	9	0.3333	300	5439	1
11ac40MIMO	5510	Type6	21	1	333.3	9	0.3333	300	5351	1
11ac40MIMO	5510	Type6	21	1	333.3	9	0.3333	300	5702	1
11ac40MIMO	5510	Type6	21	1	333.3	9	0.3333	300	5310	1
11ac40MIMO	5510	Type6	21	1	333.3	9	0.3333	300	5591	1
11ac40MIMO	5510	Type6	21	1	333.3	9	0.3333	300	5371	1
11ac40MIMO	5510	Type6	21	1	333.3	9	0.3333	300	5497	1
11ac40MIMO	5510	Type6	21	1	333.3	9	0.3333	300	5265	1
11ac40MIMO	5510	Type6	21	1	333.3	9	0.3333	300	5494	1
11ac40MIMO	5510	Type6	21	1	333.3	9	0.3333	300	5354	1
11ac40MIMO	5510	Type6	21	1	333.3	9	0.3333	300	5554	1
11ac40MIMO	5510	Type6	21	1	333.3	9	0.3333	300	5559	1
11ac40MIMO	5510	Type6	21	1	333.3	9	0.3333	300	5445	1
11ac40MIMO	5510	Type6	21	1	333.3	9	0.3333	300	5646	1
11ac40MIMO	5510	Type6	21	1	333.3	9	0.3333	300	5370	1
11ac40MIMO	5510	Type6	21	1	333.3	9	0.3333	300	5503	1
11ac40MIMO	5510	Type6	21	1	333.3	9	0.3333	300	5600	1
11ac40MIMO	5510	Type6	21	1	333.3	9	0.3333	300	5356	1
11ac40MIMO	5510	Type6	21	1	333.3	9	0.3333	300	5252	1
11ac40MIMO	5510	Type6	21	1	333.3	9	0.3333	300	5255	1
11ac40MIMO	5510	Type6	21	1	333.3	9	0.3333	300	5416	1
11ac40MIMO	5510	Type6	21	1	333.3	9	0.3333	300	5656	1
11ac40MIMO	5510	Type6	21	1	333.3	9	0.3333	300	5421	1
11ac40MIMO	5510	Type6	21	1	333.3	9	0.3333	300	5456	1
11ac40MIMO	5510	Type6	21	1	333.3	9	0.3333	300	5251	1
11ac40MIMO	5510	Type6	21	1	333.3	9	0.3333	300	5483	1
11ac40MIMO	5510	Type6	21	1	333.3	9	0.3333	300	5477	1
11ac40MIMO	5510	Type6	21	1	333.3	9	0.3333	300	5542	1
11ac40MIMO	5510	Type6	21	1	333.3	9	0.3333	300	5543	1
11ac40MIMO	5510	Type6	21	1	333.3	9	0.3333	300	5418	1
11ac40MIMO	5510	Type6	21	1	333.3	9	0.3333	300	5311	1
11ac40MIMO	5510	Type6	21	1	333.3	9	0.3333	300	5390	1
11ac40MIMO	5510	Type6	21	1	333.3	9	0.3333	300	5464	1
11ac40MIMO	5510	Type6	21	1	333.3	9	0.3333	300	5676	1
11ac40MIMO	5510	Type6	21	1	333.3	9	0.3333	300	5501	1
11ac40MIMO	5510	Type6	21	1	333.3	9	0.3333	300	5422	1
11ac40MIMO	5510	Type6	21	1	333.3	9	0.3333	300	5435	1
11ac40MIMO	5510	Type6	21	1	333.3	9	0.3333	300	5674	1
11ac40MIMO	5510	Type6	21	1	333.3	9	0.3333	300	5447	1
11ac40MIMO	5510	Type6	21	1	333.3	9	0.3333	300	5269	1
11ac40MIMO	5510	Type6	21	1	333.3	9	0.3333	300	5526	1
11ac40MIMO	5510	Type6	21	1	333.3	9	0.3333	300	5337	1
11ac40MIMO	5510	Type6	21	1	333.3	9	0.3333	300	5508	1
11ac40MIMO	5510	Type6	21	1	333.3	9	0.3333	300	5608	1
11ac40MIMO	5510	Type6	21	1	333.3	9	0.3333	300	5451	1
11ac40MIMO	5510	Type6	21	1	333.3	9	0.3333	300	5625	1
11ac40MIMO	5510	Type6	21	1	333.3	9	0.3333	300	5522	1
11ac40MIMO	5510	Type6	21	1	333.3	9	0.3333	300	5642	1
11ac40MIMO	5510	Type6	21	1	333.3	9	0.3333	300	5384	1
11ac40MIMO	5510	Type6	21	1	333.3	9	0.3333	300	5475	1
11ac40MIMO	5510	Type6	21	1	333.3	9	0.3333	300	5703	1



Unless otherwise agreed in writing, this document is issued by the Company subject to its General Conditions of Service printed overleaf, available on request or accessible at <http://www.sgs.com/en/Terms-and-Conditions.aspx> and, for electronic format documents, subject to Terms and Conditions for Electronic Documents at <http://www.sgs.com/en/Terms-and-Conditions/Terms-e-Document.aspx>. Attention is drawn to the limitation of liability, indemnification and jurisdiction issues defined therein. Any holder of this document is advised that information contained herein reflects the Company's findings at the time of its intervention only and within the limits of Client's instructions, if any. The Company's sole responsibility is to its Client and this document does not exonerate parties to a transaction from exercising all their rights and obligations under the transaction documents. This document cannot be reproduced except in full, without prior written approval of the Company. Any unauthorized alteration, forgery or falsification of the content or appearance of this document is unlawful and offenders may be prosecuted to the fullest extent of the law. Unless otherwise stated the results shown in this test report refer only to the sample(s) tested and such sample(s) are retained for 30 days only.

Attention: To check the authenticity of testing/inspection report & certificate, please contact us at telephone: (86-755) 8307 1443, or email: [CN.Doccheck@sgs.com](mailto:CN.Doccheck@sgs.com)  
 (E) Unit D, Building 1, Kanglong Orange Science Park, No.157, Keyuan 3rd Road, Fengjing/Yue Town, Xi'an, Shaanxi, China 710086  
 t (86-29) 6282 7885 www.sgs.com.cn  
 中国·西安·沣东新城科里三路157号康隆橙方科技园1号楼D单元1层 邮编: 710086 t (86-29) 6282 7885 sgs.china@sgs.com





11ac40MIMO	5510	Type6	21	1	333.3	9	0.3333	300	5507	1
11ac40MIMO	5510	Type6	21	1	333.3	9	0.3333	300	5401	1
11ac40MIMO	5510	Type6	21	1	333.3	9	0.3333	300	5655	1
11ac40MIMO	5510	Type6	21	1	333.3	9	0.3333	300	5496	1
11ac40MIMO	5510	Type6	21	1	333.3	9	0.3333	300	5309	1
11ac40MIMO	5510	Type6	21	1	333.3	9	0.3333	300	5455	1
11ac40MIMO	5510	Type6	21	1	333.3	9	0.3333	300	5619	1
11ac40MIMO	5510	Type6	21	1	333.3	9	0.3333	300	5680	1
11ac40MIMO	5510	Type6	21	1	333.3	9	0.3333	300	5326	1
11ac40MIMO	5510	Type6	21	1	333.3	9	0.3333	300	5414	1
11ac40MIMO	5510	Type6	21	1	333.3	9	0.3333	300	5345	1
11ac40MIMO	5510	Type6	21	1	333.3	9	0.3333	300	5492	1
11ac40MIMO	5510	Type6	21	1	333.3	9	0.3333	300	5295	1
11ac40MIMO	5510	Type6	21	1	333.3	9	0.3333	300	5318	1
11ac40MIMO	5510	Type6	21	1	333.3	9	0.3333	300	5273	1
11ac40MIMO	5510	Type6	21	1	333.3	9	0.3333	300	5587	1
11ac40MIMO	5510	Type6	21	1	333.3	9	0.3333	300	5530	1
11ac40MIMO	5510	Type6	21	1	333.3	9	0.3333	300	5711	1
11ac40MIMO	5510	Type6	21	1	333.3	9	0.3333	300	5615	1
11ac40MIMO	5510	Type6	21	1	333.3	9	0.3333	300	5666	1
11ac40MIMO	5510	Type6	21	1	333.3	9	0.3333	300	5638	1
11ac40MIMO	5510	Type6	21	1	333.3	9	0.3333	300	5670	1
11ac40MIMO	5510	Type6	21	1	333.3	9	0.3333	300	5622	1
11ac40MIMO	5510	Type6	21	1	333.3	9	0.3333	300	5583	1
11ac40MIMO	5510	Type6	21	1	333.3	9	0.3333	300	5691	1
11ac40MIMO	5510	Type6	21	1	333.3	9	0.3333	300	5367	1
11ac40MIMO	5510	Type6	21	1	333.3	9	0.3333	300	5626	1
11ac40MIMO	5510	Type6	21	1	333.3	9	0.3333	300	5381	1
11ac40MIMO	5510	Type6	21	1	333.3	9	0.3333	300	5561	1
11ac40MIMO	5510	Type6	21	1	333.3	9	0.3333	300	5412	1
11ac40MIMO	5510	Type6	21	1	333.3	9	0.3333	300	5682	1
11ac40MIMO	5510	Type6	21	1	333.3	9	0.3333	300	5718	1
11ac40MIMO	5510	Type6	21	1	333.3	9	0.3333	300	5589	1
11ac40MIMO	5510	Type6	21	1	333.3	9	0.3333	300	5286	1
11ac40MIMO	5510	Type6	21	1	333.3	9	0.3333	300	5289	1
11ac40MIMO	5510	Type6	21	1	333.3	9	0.3333	300	5553	1
11ac40MIMO	5510	Type6	21	1	333.3	9	0.3333	300	5314	1
11ac40MIMO	5510	Type6	21	1	333.3	9	0.3333	300	5329	1
11ac40MIMO	5510	Type6	21	1	333.3	9	0.3333	300	5261	1
11ac40MIMO	5510	Type6	21	1	333.3	9	0.3333	300	5465	1
11ac40MIMO	5510	Type6	21	1	333.3	9	0.3333	300	5541	1
11ac40MIMO	5510	Type6	21	1	333.3	9	0.3333	300	5463	1
11ac40MIMO	5510	Type6	21	1	333.3	9	0.3333	300	5574	1
11ac40MIMO	5510	Type6	21	1	333.3	9	0.3333	300	5671	1
11ac40MIMO	5510	Type6	21	1	333.3	9	0.3333	300	5458	1
11ac20MIMO	5500	Type6	21	1	333.3	9	0.3333	300	5484	1
11ac20MIMO	5500	Type6	21	1	333.3	9	0.3333	300	5705	1
11ac20MIMO	5500	Type6	21	1	333.3	9	0.3333	300	5415	1
11ac20MIMO	5500	Type6	21	1	333.3	9	0.3333	300	5470	1
11ac20MIMO	5500	Type6	21	1	333.3	9	0.3333	300	5439	1
11ac20MIMO	5500	Type6	21	1	333.3	9	0.3333	300	5351	1
11ac20MIMO	5500	Type6	21	1	333.3	9	0.3333	300	5702	1
11ac20MIMO	5500	Type6	21	1	333.3	9	0.3333	300	5310	1



Unless otherwise agreed in writing, this document is issued by the Company subject to its General Conditions of Service printed overleaf, available on request or accessible at <http://www.sgs.com/en/Terms-and-Conditions.aspx> and, for electronic format documents, subject to Terms and Conditions for Electronic Documents at <http://www.sgs.com/en/Terms-and-Conditions/Terms-e-Document.aspx>. Attention is drawn to the limitation of liability, indemnification and jurisdiction issues defined therein. Any holder of this document is advised that information contained herein reflects the Company's findings at the time of its intervention only and within the limits of Client's instructions, if any. The Company's sole responsibility is to its Client and this document does not exonerate parties to a transaction from exercising all their rights and obligations under the transaction documents. This document cannot be reproduced except in full, without prior written approval of the Company. Any unauthorized alteration, forgery or falsification of the content or appearance of this document is unlawful and offenders may be prosecuted to the fullest extent of the law. Unless otherwise stated the results shown in this test report refer only to the sample(s) tested and such sample(s) are retained for 30 days only.

Attention: To check the authenticity of testing/inspection report & certificate, please contact us at telephone: (86-755) 8307 1443, or email: [CN.Doccheck@sgs.com](mailto:CN.Doccheck@sgs.com)  
 (E) Unit D, Building 1, Kanglong Orange Science Park, No.157, Keyuan 3rd Road, Fengjing/Yue Town, Xian, Shaanxi, China 710086  
 t (86-29) 6282 7885 www.sgs.com.cn  
 中国·西安·沣东新城科里三路157号康隆橙方科技园1号楼D单元1层 邮编: 710086 t (86-29) 6282 7885 sgs.china@sgs.com



Report No.: XEWA2310000070RG05
Rev.: 01
Page: 218 of 267

Table with 11 columns: Item ID, Value, Type, and various test parameters. All 'Type' values are 'Type6' and all 'Value' values are '5500'.



Unless otherwise agreed in writing, this document is issued by the Company subject to its General Conditions of Service printed overleaf, available on request or accessible at http://www.sgs.com/en/Terms-and-Conditions.aspx and, for electronic format documents, subject to Terms and Conditions for Electronic Documents at http://www.sgs.com/en/Terms-and-Conditions/Terms-e-Documents.aspx. Attention is drawn to the limitation of liability, indemnification and jurisdiction issues defined therein. Any holder of this document is advised that information contained herein reflects the Company's findings at the time of its intervention only and within the limits of Client's instructions, if any. The Company's sole responsibility is to its Client and this document does not exonerate parties to a transaction from exercising all their rights and obligations under the transaction documents. This document cannot be reproduced except in full, without prior written approval of the Company. Any unauthorized alteration, forgery or falsification of the content or appearance of this document is unlawful and offenders may be prosecuted to the fullest extent of the law. Unless otherwise stated the results shown in this test report refer only to the sample(s) tested and such sample(s) are retained for 30 days only. Attention: To check the authenticity of testing inspection report & certificate, please contact us at telephone: (86-755) 8307 1443, or email: CN.Doccheck@sgs.com.
1/E Unit D, Building 1, Kanglong Orange Science Park, No.157, Keyuan 3rd Road, Fengjing New Town, Xi'an, Shaanxi, China 710086 t (86-29) 6282 7885 www.sgs.com.cn
中国·西安·沣东新城科里三路137号康隆橙方科技园1号楼D单元1层 邮编: 710086 t (86-29) 6282 7885 sgs.china@sgs.com



11ac20MIMO	5500	Type6	21	1	333.3	9	0.3333	300	5619	1
11ac20MIMO	5500	Type6	21	1	333.3	9	0.3333	300	5680	1
11ac20MIMO	5500	Type6	21	1	333.3	9	0.3333	300	5326	1
11ac20MIMO	5500	Type6	21	1	333.3	9	0.3333	300	5414	1
11ac20MIMO	5500	Type6	21	1	333.3	9	0.3333	300	5345	1
11ac20MIMO	5500	Type6	21	1	333.3	9	0.3333	300	5492	1
11ac20MIMO	5500	Type6	21	1	333.3	9	0.3333	300	5295	1
11ac20MIMO	5500	Type6	21	1	333.3	9	0.3333	300	5318	1
11ac20MIMO	5500	Type6	21	1	333.3	9	0.3333	300	5273	1
11ac20MIMO	5500	Type6	21	1	333.3	9	0.3333	300	5587	1
11ac20MIMO	5500	Type6	21	1	333.3	9	0.3333	300	5530	1
11ac20MIMO	5500	Type6	21	1	333.3	9	0.3333	300	5711	1
11ac20MIMO	5500	Type6	21	1	333.3	9	0.3333	300	5615	1
11ac20MIMO	5500	Type6	21	1	333.3	9	0.3333	300	5666	1
11ac20MIMO	5500	Type6	21	1	333.3	9	0.3333	300	5638	1
11ac20MIMO	5500	Type6	21	1	333.3	9	0.3333	300	5670	1
11ac20MIMO	5500	Type6	21	1	333.3	9	0.3333	300	5622	1
11ac20MIMO	5500	Type6	21	1	333.3	9	0.3333	300	5583	1
11ac20MIMO	5500	Type6	21	1	333.3	9	0.3333	300	5691	1
11ac20MIMO	5500	Type6	21	1	333.3	9	0.3333	300	5367	1
11ac20MIMO	5500	Type6	21	1	333.3	9	0.3333	300	5626	1
11ac20MIMO	5500	Type6	21	1	333.3	9	0.3333	300	5381	1
11ac20MIMO	5500	Type6	21	1	333.3	9	0.3333	300	5561	1
11ac20MIMO	5500	Type6	21	1	333.3	9	0.3333	300	5412	1
11ac20MIMO	5500	Type6	21	1	333.3	9	0.3333	300	5682	1
11ac20MIMO	5500	Type6	21	1	333.3	9	0.3333	300	5718	1
11ac20MIMO	5500	Type6	21	1	333.3	9	0.3333	300	5589	1
11ac20MIMO	5500	Type6	21	1	333.3	9	0.3333	300	5286	1
11ac20MIMO	5500	Type6	21	1	333.3	9	0.3333	300	5289	1
11ac20MIMO	5500	Type6	21	1	333.3	9	0.3333	300	5553	1
11ac20MIMO	5500	Type6	21	1	333.3	9	0.3333	300	5314	1
11ac20MIMO	5500	Type6	21	1	333.3	9	0.3333	300	5329	1
11ac20MIMO	5500	Type6	21	1	333.3	9	0.3333	300	5261	1
11ac20MIMO	5500	Type6	21	1	333.3	9	0.3333	300	5465	1
11ac20MIMO	5500	Type6	21	1	333.3	9	0.3333	300	5541	1
11ac20MIMO	5500	Type6	21	1	333.3	9	0.3333	300	5463	1
11ac20MIMO	5500	Type6	21	1	333.3	9	0.3333	300	5574	1
11ac20MIMO	5500	Type6	21	1	333.3	9	0.3333	300	5671	1
11ac20MIMO	5500	Type6	21	1	333.3	9	0.3333	300	5458	1



Unless otherwise agreed in writing, this document is issued by the Company subject to its General Conditions of Service printed overleaf, available on request or accessible at <http://www.sgs.com/en/Terms-and-Conditions.aspx> and, for electronic format documents, subject to Terms and Conditions for Electronic Documents at <http://www.sgs.com/en/Terms-and-Conditions/Terms-e-Documents.aspx>. Attention is drawn to the limitation of liability, indemnification and jurisdiction issues defined therein. Any holder of this document is advised that information contained herein reflects the Company's findings at the time of its intervention only and within the limits of Client's instructions, if any. The Company's sole responsibility is to its Client and this document does not exonerate parties to a transaction from exercising all their rights and obligations under the transaction documents. This document cannot be reproduced except in full, without prior written approval of the Company. Any unauthorized alteration, forgery or falsification of the content or appearance of this document is unlawful and offenders may be prosecuted to the fullest extent of the law. Unless otherwise stated the results shown in this test report refer only to the sample(s) tested and such sample(s) are retained for 30 days only.

Attention: To check the authenticity of testing/inspection report & certificate, please contact us at telephone: (86-755) 4307 1443, or email: CN.Doccheck@sgs.com

SGS-CSTC Standards Technical Services (Xi'an) Co., Ltd. | 1/E Unit D, Building 1, Kanghong Orange Science Park, No.137, Kejian 3rd Road, Fengling New Town, Xi'an, Shaanxi, China | 710086 | t (86-29) 6282 7885 | www.sgs.com.cn  
 中国·西安·沣东新城科里三路137号康鸿橙方科技园1号楼D单元1层 | 邮编: 710086 | t (86-29) 6282 7885 | sgs.china@sgs.com

TestMode	Channel	Radar Type	Trial ID	Pulse width (μs)	PRI (μs)	Pulses per Hop	Hop Rate (kHz)	Hop Sequence Length(ms)	Center Frequency (MHz)	Detection (1: Yes; 0: No)
11ac80MIMO	5530	Type6	22	1	333.3	9	0.3333	300	5264	1
11ac80MIMO	5530	Type6	22	1	333.3	9	0.3333	300	5469	1
11ac80MIMO	5530	Type6	22	1	333.3	9	0.3333	300	5351	1
11ac80MIMO	5530	Type6	22	1	333.3	9	0.3333	300	5631	1
11ac80MIMO	5530	Type6	22	1	333.3	9	0.3333	300	5659	1
11ac80MIMO	5530	Type6	22	1	333.3	9	0.3333	300	5393	1
11ac80MIMO	5530	Type6	22	1	333.3	9	0.3333	300	5627	1
11ac80MIMO	5530	Type6	22	1	333.3	9	0.3333	300	5385	1
11ac80MIMO	5530	Type6	22	1	333.3	9	0.3333	300	5279	1
11ac80MIMO	5530	Type6	22	1	333.3	9	0.3333	300	5578	1
11ac80MIMO	5530	Type6	22	1	333.3	9	0.3333	300	5428	1
11ac80MIMO	5530	Type6	22	1	333.3	9	0.3333	300	5529	1
11ac80MIMO	5530	Type6	22	1	333.3	9	0.3333	300	5535	1
11ac80MIMO	5530	Type6	22	1	333.3	9	0.3333	300	5549	1
11ac80MIMO	5530	Type6	22	1	333.3	9	0.3333	300	5575	1
11ac80MIMO	5530	Type6	22	1	333.3	9	0.3333	300	5647	1
11ac80MIMO	5530	Type6	22	1	333.3	9	0.3333	300	5572	1
11ac80MIMO	5530	Type6	22	1	333.3	9	0.3333	300	5274	1
11ac80MIMO	5530	Type6	22	1	333.3	9	0.3333	300	5415	1
11ac80MIMO	5530	Type6	22	1	333.3	9	0.3333	300	5695	1
11ac80MIMO	5530	Type6	22	1	333.3	9	0.3333	300	5608	1
11ac80MIMO	5530	Type6	22	1	333.3	9	0.3333	300	5425	1
11ac80MIMO	5530	Type6	22	1	333.3	9	0.3333	300	5668	1
11ac80MIMO	5530	Type6	22	1	333.3	9	0.3333	300	5722	1
11ac80MIMO	5530	Type6	22	1	333.3	9	0.3333	300	5389	1
11ac80MIMO	5530	Type6	22	1	333.3	9	0.3333	300	5544	1
11ac80MIMO	5530	Type6	22	1	333.3	9	0.3333	300	5370	1
11ac80MIMO	5530	Type6	22	1	333.3	9	0.3333	300	5355	1
11ac80MIMO	5530	Type6	22	1	333.3	9	0.3333	300	5517	1
11ac80MIMO	5530	Type6	22	1	333.3	9	0.3333	300	5616	1
11ac80MIMO	5530	Type6	22	1	333.3	9	0.3333	300	5528	1
11ac80MIMO	5530	Type6	22	1	333.3	9	0.3333	300	5500	1
11ac80MIMO	5530	Type6	22	1	333.3	9	0.3333	300	5633	1
11ac80MIMO	5530	Type6	22	1	333.3	9	0.3333	300	5463	1
11ac80MIMO	5530	Type6	22	1	333.3	9	0.3333	300	5685	1
11ac80MIMO	5530	Type6	22	1	333.3	9	0.3333	300	5603	1
11ac80MIMO	5530	Type6	22	1	333.3	9	0.3333	300	5292	1
11ac80MIMO	5530	Type6	22	1	333.3	9	0.3333	300	5297	1
11ac80MIMO	5530	Type6	22	1	333.3	9	0.3333	300	5349	1
11ac80MIMO	5530	Type6	22	1	333.3	9	0.3333	300	5513	1
11ac80MIMO	5530	Type6	22	1	333.3	9	0.3333	300	5577	1
11ac80MIMO	5530	Type6	22	1	333.3	9	0.3333	300	5509	1
11ac80MIMO	5530	Type6	22	1	333.3	9	0.3333	300	5523	1
11ac80MIMO	5530	Type6	22	1	333.3	9	0.3333	300	5644	1
11ac80MIMO	5530	Type6	22	1	333.3	9	0.3333	300	5488	1
11ac80MIMO	5530	Type6	22	1	333.3	9	0.3333	300	5691	1
11ac80MIMO	5530	Type6	22	1	333.3	9	0.3333	300	5412	1
11ac80MIMO	5530	Type6	22	1	333.3	9	0.3333	300	5678	1
11ac80MIMO	5530	Type6	22	1	333.3	9	0.3333	300	5495	1



Unless otherwise agreed in writing, this document is issued by the Company subject to its General Conditions of Service printed overleaf, available on request or accessible at <http://www.sgs.com/en/Terms-and-Conditions.aspx> and, for electronic format documents, subject to Terms and Conditions for Electronic Documents at <http://www.sgs.com/en/Terms-and-Conditions/Terms-e-Document.aspx>. Attention is drawn to the limitation of liability, indemnification and jurisdiction issues defined therein. Any holder of this document is advised that information contained herein reflects the Company's findings at the time of its intervention only and within the limits of Client's instructions, if any. The Company's sole responsibility is to its Client and this document does not exonerate parties to a transaction from exercising all their rights and obligations under the transaction documents. This document cannot be reproduced except in full, without prior written approval of the Company. Any unauthorized alteration, forgery or falsification of the content or appearance of this document is unlawful and offenders may be prosecuted to the fullest extent of the law. Unless otherwise stated the results shown in this test report refer only to the sample(s) tested and such sample(s) are retained for 30 days only.

Attention: To check the authenticity of testing/inspection report & certificate, please contact us at telephone: (86-755) 8307 1443, or email: [CN\\_Doccheck@sgs.com](mailto:CN_Doccheck@sgs.com)

SGS-CSTC Standards Technical Services (Xi'an) Co., Ltd. | 1/E Unit D, Building 1, Kanglong Orange Science Park, No.157, Keyuan 3rd Road, Fengjing/Yue Town, Xi'an, Shaanxi, China | 710086 | t (86-29) 6282 7885 | www.sgs.com.cn  
 中国·西安·沣东新城科里三路157号康隆橙方科技园1号楼D单元1层 | 邮编: 710086 | t (86-29) 6282 7885 | sgs.china@sgs.com

11ac80MIMO	5530	Type6	22	1	333.3	9	0.3333	300	5398	1
11ac80MIMO	5530	Type6	22	1	333.3	9	0.3333	300	5343	1
11ac80MIMO	5530	Type6	22	1	333.3	9	0.3333	300	5435	1
11ac80MIMO	5530	Type6	22	1	333.3	9	0.3333	300	5564	1
11ac80MIMO	5530	Type6	22	1	333.3	9	0.3333	300	5526	1
11ac80MIMO	5530	Type6	22	1	333.3	9	0.3333	300	5451	1
11ac80MIMO	5530	Type6	22	1	333.3	9	0.3333	300	5589	1
11ac80MIMO	5530	Type6	22	1	333.3	9	0.3333	300	5462	1
11ac80MIMO	5530	Type6	22	1	333.3	9	0.3333	300	5315	1
11ac80MIMO	5530	Type6	22	1	333.3	9	0.3333	300	5280	1
11ac80MIMO	5530	Type6	22	1	333.3	9	0.3333	300	5584	1
11ac80MIMO	5530	Type6	22	1	333.3	9	0.3333	300	5309	1
11ac80MIMO	5530	Type6	22	1	333.3	9	0.3333	300	5625	1
11ac80MIMO	5530	Type6	22	1	333.3	9	0.3333	300	5336	1
11ac80MIMO	5530	Type6	22	1	333.3	9	0.3333	300	5615	1
11ac80MIMO	5530	Type6	22	1	333.3	9	0.3333	300	5294	1
11ac80MIMO	5530	Type6	22	1	333.3	9	0.3333	300	5530	1
11ac80MIMO	5530	Type6	22	1	333.3	9	0.3333	300	5702	1
11ac80MIMO	5530	Type6	22	1	333.3	9	0.3333	300	5565	1
11ac80MIMO	5530	Type6	22	1	333.3	9	0.3333	300	5596	1
11ac80MIMO	5530	Type6	22	1	333.3	9	0.3333	300	5345	1
11ac80MIMO	5530	Type6	22	1	333.3	9	0.3333	300	5670	1
11ac80MIMO	5530	Type6	22	1	333.3	9	0.3333	300	5630	1
11ac80MIMO	5530	Type6	22	1	333.3	9	0.3333	300	5560	1
11ac80MIMO	5530	Type6	22	1	333.3	9	0.3333	300	5591	1
11ac80MIMO	5530	Type6	22	1	333.3	9	0.3333	300	5607	1
11ac80MIMO	5530	Type6	22	1	333.3	9	0.3333	300	5693	1
11ac80MIMO	5530	Type6	22	1	333.3	9	0.3333	300	5468	1
11ac80MIMO	5530	Type6	22	1	333.3	9	0.3333	300	5477	1
11ac80MIMO	5530	Type6	22	1	333.3	9	0.3333	300	5407	1
11ac80MIMO	5530	Type6	22	1	333.3	9	0.3333	300	5545	1
11ac80MIMO	5530	Type6	22	1	333.3	9	0.3333	300	5721	1
11ac80MIMO	5530	Type6	22	1	333.3	9	0.3333	300	5409	1
11ac80MIMO	5530	Type6	22	1	333.3	9	0.3333	300	5402	1
11ac80MIMO	5530	Type6	22	1	333.3	9	0.3333	300	5525	1
11ac80MIMO	5530	Type6	22	1	333.3	9	0.3333	300	5552	1
11ac80MIMO	5530	Type6	22	1	333.3	9	0.3333	300	5381	1
11ac80MIMO	5530	Type6	22	1	333.3	9	0.3333	300	5483	1
11ac80MIMO	5530	Type6	22	1	333.3	9	0.3333	300	5340	1
11ac80MIMO	5530	Type6	22	1	333.3	9	0.3333	300	5326	1
11ac80MIMO	5530	Type6	22	1	333.3	9	0.3333	300	5609	1
11ac80MIMO	5530	Type6	22	1	333.3	9	0.3333	300	5494	1
11ac80MIMO	5530	Type6	22	1	333.3	9	0.3333	300	5364	1
11ac80MIMO	5530	Type6	22	1	333.3	9	0.3333	300	5499	1
11ac80MIMO	5530	Type6	22	1	333.3	9	0.3333	300	5423	1
11ac80MIMO	5530	Type6	22	1	333.3	9	0.3333	300	5465	1
11ac80MIMO	5530	Type6	22	1	333.3	9	0.3333	300	5518	1
11ac80MIMO	5530	Type6	22	1	333.3	9	0.3333	300	5558	1
11ac80MIMO	5530	Type6	22	1	333.3	9	0.3333	300	5569	1
11ac80MIMO	5530	Type6	22	1	333.3	9	0.3333	300	5716	1
11ac80MIMO	5530	Type6	22	1	333.3	9	0.3333	300	5718	1
11ac40MIMO	5510	Type6	22	1	333.3	9	0.3333	300	5264	1
11ac40MIMO	5510	Type6	22	1	333.3	9	0.3333	300	5469	1



Unless otherwise agreed in writing, this document is issued by the Company subject to its General Conditions of Service printed overleaf, available on request or accessible at <http://www.sgs.com/en/Terms-and-Conditions.aspx> and, for electronic format documents, subject to Terms and Conditions for Electronic Documents at <http://www.sgs.com/en/Terms-and-Conditions/Terms-e-Documents.aspx>. Attention is drawn to the limitation of liability, indemnification and jurisdiction issues defined therein. Any holder of this document is advised that information contained herein reflects the Company's findings at the time of its intervention only and within the limits of Client's instructions, if any. The Company's sole responsibility is to its Client and this document does not exonerate parties to a transaction from exercising all their rights and obligations under the transaction documents. This document cannot be reproduced except in full, without prior written approval of the Company. Any unauthorized alteration, forgery or falsification of the content or appearance of this document is unlawful and offenders may be prosecuted to the fullest extent of the law. Unless otherwise stated the results shown in this test report refer only to the sample(s) tested and such sample(s) are retained for 30 days only.

Attention: To check the authenticity of testing inspection report & certificate, please contact us at telephone: (86-755) 8307 1443, or email: [CN.Doccheck@sgs.com](mailto:CN.Doccheck@sgs.com)  
 (E) Unit D, Building 1, Kanglong Orange Science Park, No.157, Keyuan 3rd Road, Fengyang New Town, Xian, Shaanxi, China 710086  
 t (86-29) 6282 7885 www.sgs.com.cn  
 中国·西安·沣东新城科里三路157号康隆橙方科技园1号楼D单元1层 邮编: 710086 t (86-29) 6282 7885 sgs.china@sgs.com



11ac40MIMO	5510	Type6	22	1	333.3	9	0.3333	300	5351	1
11ac40MIMO	5510	Type6	22	1	333.3	9	0.3333	300	5631	1
11ac40MIMO	5510	Type6	22	1	333.3	9	0.3333	300	5659	1
11ac40MIMO	5510	Type6	22	1	333.3	9	0.3333	300	5393	1
11ac40MIMO	5510	Type6	22	1	333.3	9	0.3333	300	5627	1
11ac40MIMO	5510	Type6	22	1	333.3	9	0.3333	300	5385	1
11ac40MIMO	5510	Type6	22	1	333.3	9	0.3333	300	5279	1
11ac40MIMO	5510	Type6	22	1	333.3	9	0.3333	300	5578	1
11ac40MIMO	5510	Type6	22	1	333.3	9	0.3333	300	5428	1
11ac40MIMO	5510	Type6	22	1	333.3	9	0.3333	300	5529	1
11ac40MIMO	5510	Type6	22	1	333.3	9	0.3333	300	5535	1
11ac40MIMO	5510	Type6	22	1	333.3	9	0.3333	300	5549	1
11ac40MIMO	5510	Type6	22	1	333.3	9	0.3333	300	5575	1
11ac40MIMO	5510	Type6	22	1	333.3	9	0.3333	300	5647	1
11ac40MIMO	5510	Type6	22	1	333.3	9	0.3333	300	5572	1
11ac40MIMO	5510	Type6	22	1	333.3	9	0.3333	300	5274	1
11ac40MIMO	5510	Type6	22	1	333.3	9	0.3333	300	5415	1
11ac40MIMO	5510	Type6	22	1	333.3	9	0.3333	300	5695	1
11ac40MIMO	5510	Type6	22	1	333.3	9	0.3333	300	5608	1
11ac40MIMO	5510	Type6	22	1	333.3	9	0.3333	300	5425	1
11ac40MIMO	5510	Type6	22	1	333.3	9	0.3333	300	5668	1
11ac40MIMO	5510	Type6	22	1	333.3	9	0.3333	300	5722	1
11ac40MIMO	5510	Type6	22	1	333.3	9	0.3333	300	5389	1
11ac40MIMO	5510	Type6	22	1	333.3	9	0.3333	300	5544	1
11ac40MIMO	5510	Type6	22	1	333.3	9	0.3333	300	5370	1
11ac40MIMO	5510	Type6	22	1	333.3	9	0.3333	300	5355	1
11ac40MIMO	5510	Type6	22	1	333.3	9	0.3333	300	5517	1
11ac40MIMO	5510	Type6	22	1	333.3	9	0.3333	300	5616	1
11ac40MIMO	5510	Type6	22	1	333.3	9	0.3333	300	5528	1
11ac40MIMO	5510	Type6	22	1	333.3	9	0.3333	300	5500	1
11ac40MIMO	5510	Type6	22	1	333.3	9	0.3333	300	5633	1
11ac40MIMO	5510	Type6	22	1	333.3	9	0.3333	300	5463	1
11ac40MIMO	5510	Type6	22	1	333.3	9	0.3333	300	5685	1
11ac40MIMO	5510	Type6	22	1	333.3	9	0.3333	300	5603	1
11ac40MIMO	5510	Type6	22	1	333.3	9	0.3333	300	5292	1
11ac40MIMO	5510	Type6	22	1	333.3	9	0.3333	300	5297	1
11ac40MIMO	5510	Type6	22	1	333.3	9	0.3333	300	5349	1
11ac40MIMO	5510	Type6	22	1	333.3	9	0.3333	300	5513	1
11ac40MIMO	5510	Type6	22	1	333.3	9	0.3333	300	5577	1
11ac40MIMO	5510	Type6	22	1	333.3	9	0.3333	300	5509	1
11ac40MIMO	5510	Type6	22	1	333.3	9	0.3333	300	5523	1
11ac40MIMO	5510	Type6	22	1	333.3	9	0.3333	300	5644	1
11ac40MIMO	5510	Type6	22	1	333.3	9	0.3333	300	5488	1
11ac40MIMO	5510	Type6	22	1	333.3	9	0.3333	300	5691	1
11ac40MIMO	5510	Type6	22	1	333.3	9	0.3333	300	5412	1
11ac40MIMO	5510	Type6	22	1	333.3	9	0.3333	300	5678	1
11ac40MIMO	5510	Type6	22	1	333.3	9	0.3333	300	5495	1
11ac40MIMO	5510	Type6	22	1	333.3	9	0.3333	300	5398	1
11ac40MIMO	5510	Type6	22	1	333.3	9	0.3333	300	5343	1
11ac40MIMO	5510	Type6	22	1	333.3	9	0.3333	300	5435	1
11ac40MIMO	5510	Type6	22	1	333.3	9	0.3333	300	5564	1
11ac40MIMO	5510	Type6	22	1	333.3	9	0.3333	300	5526	1
11ac40MIMO	5510	Type6	22	1	333.3	9	0.3333	300	5451	1



Unless otherwise agreed in writing, this document is issued by the Company subject to its General Conditions of Service printed overleaf, available on request or accessible at <http://www.sgs.com/en/Terms-and-Conditions.aspx> and, for electronic format documents, subject to Terms and Conditions for Electronic Documents at <http://www.sgs.com/en/Terms-and-Conditions/Terms-e-Document.aspx>. Attention is drawn to the limitation of liability, indemnification and jurisdiction issues defined therein. Any holder of this document is advised that information contained herein reflects the Company's findings at the time of its intervention only and within the limits of Client's instructions, if any. The Company's sole responsibility is to its Client and this document does not exonerate parties to a transaction from exercising all their rights and obligations under the transaction documents. This document cannot be reproduced except in full, without prior written approval of the Company. Any unauthorized alteration, forgery or falsification of the content or appearance of this document is unlawful and offenders may be prosecuted to the fullest extent of the law. Unless otherwise stated the results shown in this test report refer only to the sample(s) tested and such sample(s) are retained for 30 days only.

Attention: To check the authenticity of testing/inspection report & certificate, please contact us at telephone: (86-755) 8307 1443, or email: [CN.Doccheck@sgs.com](mailto:CN.Doccheck@sgs.com)  
 (E) Unit D, Building 1, Kanglong Orange Science Park, No.157, Keyuan 3rd Road, Fengjing/Yue Town, Xian, Shaanxi, China 710086  
 t (86-29) 6282 7885 www.sgs.com.cn  
 中国·西安·沣东新城科里三路157号康隆橙方科技园1号楼D单元1层 邮编: 710086 t (86-29) 6282 7885 sgs.china@sgs.com

11ac40MIMO	5510	Type6	22	1	333.3	9	0.3333	300	5589	1
11ac40MIMO	5510	Type6	22	1	333.3	9	0.3333	300	5462	1
11ac40MIMO	5510	Type6	22	1	333.3	9	0.3333	300	5315	1
11ac40MIMO	5510	Type6	22	1	333.3	9	0.3333	300	5280	1
11ac40MIMO	5510	Type6	22	1	333.3	9	0.3333	300	5584	1
11ac40MIMO	5510	Type6	22	1	333.3	9	0.3333	300	5309	1
11ac40MIMO	5510	Type6	22	1	333.3	9	0.3333	300	5625	1
11ac40MIMO	5510	Type6	22	1	333.3	9	0.3333	300	5336	1
11ac40MIMO	5510	Type6	22	1	333.3	9	0.3333	300	5615	1
11ac40MIMO	5510	Type6	22	1	333.3	9	0.3333	300	5294	1
11ac40MIMO	5510	Type6	22	1	333.3	9	0.3333	300	5530	1
11ac40MIMO	5510	Type6	22	1	333.3	9	0.3333	300	5702	1
11ac40MIMO	5510	Type6	22	1	333.3	9	0.3333	300	5565	1
11ac40MIMO	5510	Type6	22	1	333.3	9	0.3333	300	5596	1
11ac40MIMO	5510	Type6	22	1	333.3	9	0.3333	300	5345	1
11ac40MIMO	5510	Type6	22	1	333.3	9	0.3333	300	5670	1
11ac40MIMO	5510	Type6	22	1	333.3	9	0.3333	300	5630	1
11ac40MIMO	5510	Type6	22	1	333.3	9	0.3333	300	5560	1
11ac40MIMO	5510	Type6	22	1	333.3	9	0.3333	300	5591	1
11ac40MIMO	5510	Type6	22	1	333.3	9	0.3333	300	5607	1
11ac40MIMO	5510	Type6	22	1	333.3	9	0.3333	300	5693	1
11ac40MIMO	5510	Type6	22	1	333.3	9	0.3333	300	5468	1
11ac40MIMO	5510	Type6	22	1	333.3	9	0.3333	300	5477	1
11ac40MIMO	5510	Type6	22	1	333.3	9	0.3333	300	5407	1
11ac40MIMO	5510	Type6	22	1	333.3	9	0.3333	300	5545	1
11ac40MIMO	5510	Type6	22	1	333.3	9	0.3333	300	5721	1
11ac40MIMO	5510	Type6	22	1	333.3	9	0.3333	300	5409	1
11ac40MIMO	5510	Type6	22	1	333.3	9	0.3333	300	5402	1
11ac40MIMO	5510	Type6	22	1	333.3	9	0.3333	300	5525	1
11ac40MIMO	5510	Type6	22	1	333.3	9	0.3333	300	5552	1
11ac40MIMO	5510	Type6	22	1	333.3	9	0.3333	300	5381	1
11ac40MIMO	5510	Type6	22	1	333.3	9	0.3333	300	5483	1
11ac40MIMO	5510	Type6	22	1	333.3	9	0.3333	300	5340	1
11ac40MIMO	5510	Type6	22	1	333.3	9	0.3333	300	5326	1
11ac40MIMO	5510	Type6	22	1	333.3	9	0.3333	300	5609	1
11ac40MIMO	5510	Type6	22	1	333.3	9	0.3333	300	5494	1
11ac40MIMO	5510	Type6	22	1	333.3	9	0.3333	300	5364	1
11ac40MIMO	5510	Type6	22	1	333.3	9	0.3333	300	5499	1
11ac40MIMO	5510	Type6	22	1	333.3	9	0.3333	300	5423	1
11ac40MIMO	5510	Type6	22	1	333.3	9	0.3333	300	5465	1
11ac40MIMO	5510	Type6	22	1	333.3	9	0.3333	300	5518	1
11ac40MIMO	5510	Type6	22	1	333.3	9	0.3333	300	5558	1
11ac40MIMO	5510	Type6	22	1	333.3	9	0.3333	300	5569	1
11ac40MIMO	5510	Type6	22	1	333.3	9	0.3333	300	5716	1
11ac40MIMO	5510	Type6	22	1	333.3	9	0.3333	300	5718	1
11ac20MIMO	5500	Type6	22	1	333.3	9	0.3333	300	5264	1
11ac20MIMO	5500	Type6	22	1	333.3	9	0.3333	300	5469	1
11ac20MIMO	5500	Type6	22	1	333.3	9	0.3333	300	5351	1
11ac20MIMO	5500	Type6	22	1	333.3	9	0.3333	300	5631	1
11ac20MIMO	5500	Type6	22	1	333.3	9	0.3333	300	5659	1
11ac20MIMO	5500	Type6	22	1	333.3	9	0.3333	300	5393	1
11ac20MIMO	5500	Type6	22	1	333.3	9	0.3333	300	5627	1
11ac20MIMO	5500	Type6	22	1	333.3	9	0.3333	300	5385	1



Unless otherwise agreed in writing, this document is issued by the Company subject to its General Conditions of Service printed overleaf, available on request or accessible at <http://www.sgs.com/en/Terms-and-Conditions.aspx> and, for electronic format documents, subject to Terms and Conditions for Electronic Documents at <http://www.sgs.com/en/Terms-and-Conditions/Terms-e-Documents.aspx>. Attention is drawn to the limitation of liability, indemnification and jurisdiction issues defined therein. Any holder of this document is advised that information contained herein reflects the Company's findings at the time of its intervention only and within the limits of Client's instructions, if any. The Company's sole responsibility is to its Client and this document does not exonerate parties to a transaction from exercising all their rights and obligations under the transaction documents. This document cannot be reproduced except in full, without prior written approval of the Company. Any unauthorized alteration, forgery or falsification of the content or appearance of this document is unlawful and offenders may be prosecuted to the fullest extent of the law. Unless otherwise stated the results shown in this test report refer only to the sample(s) tested and such sample(s) are retained for 30 days only.

Attention: To check the authenticity of testing/inspection report & certificate, please contact us at telephone: (86-755) 8307 1443, or email: [CN.Doccheck@sgs.com](mailto:CN.Doccheck@sgs.com)

SGS-CSTC Standards Technical Services (Xi'an) Co., Ltd. | 1/E Unit D, Building 1, Kanglong Orange Science Park, No.137, Keyuan 3rd Road, Fengyang New Town, Xi'an, Shaanxi, China | 710086 | T (86-29) 6282 7885 | [www.sgs.com](http://www.sgs.com)  
 中国·西安·沣东新城科里三路137号康隆橙方科技园1号楼D单元1层 | 邮编: 710086 | T (86-29) 6282 7885 | [sgs.china@sgs.com](mailto:sgs.china@sgs.com)

11ac20MIMO	5500	Type6	22	1	333.3	9	0.3333	300	5279	1
11ac20MIMO	5500	Type6	22	1	333.3	9	0.3333	300	5578	1
11ac20MIMO	5500	Type6	22	1	333.3	9	0.3333	300	5428	1
11ac20MIMO	5500	Type6	22	1	333.3	9	0.3333	300	5529	1
11ac20MIMO	5500	Type6	22	1	333.3	9	0.3333	300	5535	1
11ac20MIMO	5500	Type6	22	1	333.3	9	0.3333	300	5549	1
11ac20MIMO	5500	Type6	22	1	333.3	9	0.3333	300	5575	1
11ac20MIMO	5500	Type6	22	1	333.3	9	0.3333	300	5647	1
11ac20MIMO	5500	Type6	22	1	333.3	9	0.3333	300	5572	1
11ac20MIMO	5500	Type6	22	1	333.3	9	0.3333	300	5274	1
11ac20MIMO	5500	Type6	22	1	333.3	9	0.3333	300	5415	1
11ac20MIMO	5500	Type6	22	1	333.3	9	0.3333	300	5695	1
11ac20MIMO	5500	Type6	22	1	333.3	9	0.3333	300	5608	1
11ac20MIMO	5500	Type6	22	1	333.3	9	0.3333	300	5425	1
11ac20MIMO	5500	Type6	22	1	333.3	9	0.3333	300	5668	1
11ac20MIMO	5500	Type6	22	1	333.3	9	0.3333	300	5722	1
11ac20MIMO	5500	Type6	22	1	333.3	9	0.3333	300	5389	1
11ac20MIMO	5500	Type6	22	1	333.3	9	0.3333	300	5544	1
11ac20MIMO	5500	Type6	22	1	333.3	9	0.3333	300	5370	1
11ac20MIMO	5500	Type6	22	1	333.3	9	0.3333	300	5355	1
11ac20MIMO	5500	Type6	22	1	333.3	9	0.3333	300	5517	1
11ac20MIMO	5500	Type6	22	1	333.3	9	0.3333	300	5616	1
11ac20MIMO	5500	Type6	22	1	333.3	9	0.3333	300	5528	1
11ac20MIMO	5500	Type6	22	1	333.3	9	0.3333	300	5500	1
11ac20MIMO	5500	Type6	22	1	333.3	9	0.3333	300	5633	1
11ac20MIMO	5500	Type6	22	1	333.3	9	0.3333	300	5463	1
11ac20MIMO	5500	Type6	22	1	333.3	9	0.3333	300	5685	1
11ac20MIMO	5500	Type6	22	1	333.3	9	0.3333	300	5603	1
11ac20MIMO	5500	Type6	22	1	333.3	9	0.3333	300	5292	1
11ac20MIMO	5500	Type6	22	1	333.3	9	0.3333	300	5297	1
11ac20MIMO	5500	Type6	22	1	333.3	9	0.3333	300	5349	1
11ac20MIMO	5500	Type6	22	1	333.3	9	0.3333	300	5513	1
11ac20MIMO	5500	Type6	22	1	333.3	9	0.3333	300	5577	1
11ac20MIMO	5500	Type6	22	1	333.3	9	0.3333	300	5509	1
11ac20MIMO	5500	Type6	22	1	333.3	9	0.3333	300	5523	1
11ac20MIMO	5500	Type6	22	1	333.3	9	0.3333	300	5644	1
11ac20MIMO	5500	Type6	22	1	333.3	9	0.3333	300	5488	1
11ac20MIMO	5500	Type6	22	1	333.3	9	0.3333	300	5691	1
11ac20MIMO	5500	Type6	22	1	333.3	9	0.3333	300	5412	1
11ac20MIMO	5500	Type6	22	1	333.3	9	0.3333	300	5678	1
11ac20MIMO	5500	Type6	22	1	333.3	9	0.3333	300	5495	1
11ac20MIMO	5500	Type6	22	1	333.3	9	0.3333	300	5398	1
11ac20MIMO	5500	Type6	22	1	333.3	9	0.3333	300	5343	1
11ac20MIMO	5500	Type6	22	1	333.3	9	0.3333	300	5435	1
11ac20MIMO	5500	Type6	22	1	333.3	9	0.3333	300	5564	1
11ac20MIMO	5500	Type6	22	1	333.3	9	0.3333	300	5526	1
11ac20MIMO	5500	Type6	22	1	333.3	9	0.3333	300	5451	1
11ac20MIMO	5500	Type6	22	1	333.3	9	0.3333	300	5589	1
11ac20MIMO	5500	Type6	22	1	333.3	9	0.3333	300	5462	1
11ac20MIMO	5500	Type6	22	1	333.3	9	0.3333	300	5315	1
11ac20MIMO	5500	Type6	22	1	333.3	9	0.3333	300	5280	1
11ac20MIMO	5500	Type6	22	1	333.3	9	0.3333	300	5584	1
11ac20MIMO	5500	Type6	22	1	333.3	9	0.3333	300	5309	1



Unless otherwise agreed in writing, this document is issued by the Company subject to its General Conditions of Service printed overleaf, available on request or accessible at <http://www.sgs.com/en/Terms-and-Conditions.aspx> and, for electronic format documents, subject to Terms and Conditions for Electronic Documents at <http://www.sgs.com/en/Terms-and-Conditions/Terms-e-Documents.aspx>. Attention is drawn to the limitation of liability, indemnification and jurisdiction issues defined therein. Any holder of this document is advised that information contained herein reflects the Company's findings at the time of its intervention only and within the limits of Client's instructions, if any. The Company's sole responsibility is to its Client and this document does not exonerate parties to a transaction from exercising all their rights and obligations under the transaction documents. This document cannot be reproduced except in full, without prior written approval of the Company. Any unauthorized alteration, forgery or falsification of the content or appearance of this document is unlawful and offenders may be prosecuted to the fullest extent of the law. Unless otherwise stated the results shown in this test report refer only to the sample(s) tested and such sample(s) are retained for 30 days only.

Attention: To check the authenticity of testing/inspection report & certificate, please contact us at telephone: (86-755) 8307 1443, or email: [CN.Doccheck@sgs.com](mailto:CN.Doccheck@sgs.com)

SGS-CSTC Standards Technical Services (Xi'an) Co., Ltd. | 1/E Unit D, Building 1, Kanglong Orange Science Park, No.137, Keyuan 3rd Road, Fengling/Wei Town, Xi'an, Shaanxi, China | 710086 | t (86-29) 6282 7885 | www.sgs.com.cn  
 中国·西安·沣东新城科里三路137号康隆橙方科技园1号楼D单元1层 | 邮编: 710086 | t (86-29) 6282 7885 | sgs.china@sgs.com



Report No.: XEWA2310000070RG05

Rev.: 01

Page: 225 of 267

11ac20MIMO	5500	Type6	22	1	333.3	9	0.3333	300	5625	1
11ac20MIMO	5500	Type6	22	1	333.3	9	0.3333	300	5336	1
11ac20MIMO	5500	Type6	22	1	333.3	9	0.3333	300	5615	1
11ac20MIMO	5500	Type6	22	1	333.3	9	0.3333	300	5294	1
11ac20MIMO	5500	Type6	22	1	333.3	9	0.3333	300	5530	1
11ac20MIMO	5500	Type6	22	1	333.3	9	0.3333	300	5702	1
11ac20MIMO	5500	Type6	22	1	333.3	9	0.3333	300	5565	1
11ac20MIMO	5500	Type6	22	1	333.3	9	0.3333	300	5596	1
11ac20MIMO	5500	Type6	22	1	333.3	9	0.3333	300	5345	1
11ac20MIMO	5500	Type6	22	1	333.3	9	0.3333	300	5670	1
11ac20MIMO	5500	Type6	22	1	333.3	9	0.3333	300	5630	1
11ac20MIMO	5500	Type6	22	1	333.3	9	0.3333	300	5560	1
11ac20MIMO	5500	Type6	22	1	333.3	9	0.3333	300	5591	1
11ac20MIMO	5500	Type6	22	1	333.3	9	0.3333	300	5607	1
11ac20MIMO	5500	Type6	22	1	333.3	9	0.3333	300	5693	1
11ac20MIMO	5500	Type6	22	1	333.3	9	0.3333	300	5468	1
11ac20MIMO	5500	Type6	22	1	333.3	9	0.3333	300	5477	1
11ac20MIMO	5500	Type6	22	1	333.3	9	0.3333	300	5407	1
11ac20MIMO	5500	Type6	22	1	333.3	9	0.3333	300	5545	1
11ac20MIMO	5500	Type6	22	1	333.3	9	0.3333	300	5721	1
11ac20MIMO	5500	Type6	22	1	333.3	9	0.3333	300	5409	1
11ac20MIMO	5500	Type6	22	1	333.3	9	0.3333	300	5402	1
11ac20MIMO	5500	Type6	22	1	333.3	9	0.3333	300	5525	1
11ac20MIMO	5500	Type6	22	1	333.3	9	0.3333	300	5552	1
11ac20MIMO	5500	Type6	22	1	333.3	9	0.3333	300	5381	1
11ac20MIMO	5500	Type6	22	1	333.3	9	0.3333	300	5483	1
11ac20MIMO	5500	Type6	22	1	333.3	9	0.3333	300	5340	1
11ac20MIMO	5500	Type6	22	1	333.3	9	0.3333	300	5326	1
11ac20MIMO	5500	Type6	22	1	333.3	9	0.3333	300	5609	1
11ac20MIMO	5500	Type6	22	1	333.3	9	0.3333	300	5494	1
11ac20MIMO	5500	Type6	22	1	333.3	9	0.3333	300	5364	1
11ac20MIMO	5500	Type6	22	1	333.3	9	0.3333	300	5499	1
11ac20MIMO	5500	Type6	22	1	333.3	9	0.3333	300	5423	1
11ac20MIMO	5500	Type6	22	1	333.3	9	0.3333	300	5465	1
11ac20MIMO	5500	Type6	22	1	333.3	9	0.3333	300	5518	1
11ac20MIMO	5500	Type6	22	1	333.3	9	0.3333	300	5558	1
11ac20MIMO	5500	Type6	22	1	333.3	9	0.3333	300	5569	1
11ac20MIMO	5500	Type6	22	1	333.3	9	0.3333	300	5716	1
11ac20MIMO	5500	Type6	22	1	333.3	9	0.3333	300	5718	1



Unless otherwise agreed in writing, this document is issued by the Company subject to its General Conditions of Service printed overleaf, available on request or accessible at <http://www.sgs.com/en/Terms-and-Conditions.aspx> and, for electronic format documents, subject to Terms and Conditions for Electronic Documents at <http://www.sgs.com/en/Terms-and-Conditions/Terms-e-Documents.aspx>. Attention is drawn to the limitation of liability, indemnification and jurisdiction issues defined therein. Any holder of this document is advised that information contained herein reflects the Company's findings at the time of its intervention only and within the limits of Client's instructions, if any. The Company's sole responsibility is to its Client and this document does not exonerate parties to a transaction from exercising all their rights and obligations under the transaction documents. This document cannot be reproduced except in full, without prior written approval of the Company. Any unauthorized alteration, forgery or falsification of the content or appearance of this document is unlawful and offenders may be prosecuted to the fullest extent of the law. Unless otherwise stated the results shown in this test report refer only to the sample(s) tested and such sample(s) are retained for 30 days only.

Attention: To check the authenticity of testing/inspection report & certificate, please contact us at telephone: (86-755) 4307 1443, or email: [CN.Doccheck@sgs.com](mailto:CN.Doccheck@sgs.com)  
 (SGS-CSTC) Standards Technical Services (Xi'an) Co., Ltd. | 1/E Unit D, Building 1, Kanghong Orange Source Park, No.137, Kejian 3rd Road, Fengling New Town, Xi'an, Shaanxi, China | 710086 | t: (86-29) 6282 7885 | www.sgs.com.cn  
 中国·西安·沣东新城科里三路137号康鸿橙方科技园1号楼D单元1层 | 邮编: 710086 | t: (86-29) 6282 7885 | sgs.china@sgs.com

TestMode	Channel	Radar Type	Trial ID	Pulse width (μs)	PRI (μs)	Pulses per Hop	Hop Rate (kHz)	Hop Sequence Length(ms)	Center Frequency (MHz)	Detection (1: Yes; 0: No)
11ac80MIMO	5530	Type6	23	1	333.3	9	0.3333	300	5519	1
11ac80MIMO	5530	Type6	23	1	333.3	9	0.3333	300	5708	1
11ac80MIMO	5530	Type6	23	1	333.3	9	0.3333	300	5287	1
11ac80MIMO	5530	Type6	23	1	333.3	9	0.3333	300	5695	1
11ac80MIMO	5530	Type6	23	1	333.3	9	0.3333	300	5501	1
11ac80MIMO	5530	Type6	23	1	333.3	9	0.3333	300	5435	1
11ac80MIMO	5530	Type6	23	1	333.3	9	0.3333	300	5649	1
11ac80MIMO	5530	Type6	23	1	333.3	9	0.3333	300	5460	1
11ac80MIMO	5530	Type6	23	1	333.3	9	0.3333	300	5442	1
11ac80MIMO	5530	Type6	23	1	333.3	9	0.3333	300	5407	1
11ac80MIMO	5530	Type6	23	1	333.3	9	0.3333	300	5262	1
11ac80MIMO	5530	Type6	23	1	333.3	9	0.3333	300	5318	1
11ac80MIMO	5530	Type6	23	1	333.3	9	0.3333	300	5576	1
11ac80MIMO	5530	Type6	23	1	333.3	9	0.3333	300	5269	1
11ac80MIMO	5530	Type6	23	1	333.3	9	0.3333	300	5596	1
11ac80MIMO	5530	Type6	23	1	333.3	9	0.3333	300	5638	1
11ac80MIMO	5530	Type6	23	1	333.3	9	0.3333	300	5699	1
11ac80MIMO	5530	Type6	23	1	333.3	9	0.3333	300	5377	1
11ac80MIMO	5530	Type6	23	1	333.3	9	0.3333	300	5412	1
11ac80MIMO	5530	Type6	23	1	333.3	9	0.3333	300	5591	1
11ac80MIMO	5530	Type6	23	1	333.3	9	0.3333	300	5706	1
11ac80MIMO	5530	Type6	23	1	333.3	9	0.3333	300	5336	1
11ac80MIMO	5530	Type6	23	1	333.3	9	0.3333	300	5362	1
11ac80MIMO	5530	Type6	23	1	333.3	9	0.3333	300	5432	1
11ac80MIMO	5530	Type6	23	1	333.3	9	0.3333	300	5697	1
11ac80MIMO	5530	Type6	23	1	333.3	9	0.3333	300	5387	1
11ac80MIMO	5530	Type6	23	1	333.3	9	0.3333	300	5556	1
11ac80MIMO	5530	Type6	23	1	333.3	9	0.3333	300	5454	1
11ac80MIMO	5530	Type6	23	1	333.3	9	0.3333	300	5658	1
11ac80MIMO	5530	Type6	23	1	333.3	9	0.3333	300	5417	1
11ac80MIMO	5530	Type6	23	1	333.3	9	0.3333	300	5457	1
11ac80MIMO	5530	Type6	23	1	333.3	9	0.3333	300	5373	1
11ac80MIMO	5530	Type6	23	1	333.3	9	0.3333	300	5712	1
11ac80MIMO	5530	Type6	23	1	333.3	9	0.3333	300	5408	1
11ac80MIMO	5530	Type6	23	1	333.3	9	0.3333	300	5645	1
11ac80MIMO	5530	Type6	23	1	333.3	9	0.3333	300	5480	1
11ac80MIMO	5530	Type6	23	1	333.3	9	0.3333	300	5568	1
11ac80MIMO	5530	Type6	23	1	333.3	9	0.3333	300	5350	1
11ac80MIMO	5530	Type6	23	1	333.3	9	0.3333	300	5360	1
11ac80MIMO	5530	Type6	23	1	333.3	9	0.3333	300	5352	1
11ac80MIMO	5530	Type6	23	1	333.3	9	0.3333	300	5660	1
11ac80MIMO	5530	Type6	23	1	333.3	9	0.3333	300	5323	1
11ac80MIMO	5530	Type6	23	1	333.3	9	0.3333	300	5652	1
11ac80MIMO	5530	Type6	23	1	333.3	9	0.3333	300	5520	1
11ac80MIMO	5530	Type6	23	1	333.3	9	0.3333	300	5573	1
11ac80MIMO	5530	Type6	23	1	333.3	9	0.3333	300	5468	1
11ac80MIMO	5530	Type6	23	1	333.3	9	0.3333	300	5299	1
11ac80MIMO	5530	Type6	23	1	333.3	9	0.3333	300	5470	1
11ac80MIMO	5530	Type6	23	1	333.3	9	0.3333	300	5634	1



Unless otherwise agreed in writing, this document is issued by the Company subject to its General Conditions of Service printed overleaf, available on request or accessible at <http://www.sgs.com/en/Terms-and-Conditions.aspx> and, for electronic format documents, subject to Terms and Conditions for Electronic Documents at <http://www.sgs.com/en/Terms-and-Conditions/Terms-e-Documents.aspx>. Attention is drawn to the limitation of liability, indemnification and jurisdiction issues defined therein. Any holder of this document is advised that information contained herein reflects the Company's findings at the time of its intervention only and within the limits of Client's instructions, if any. The Company's sole responsibility is to its Client and this document does not exonerate parties to a transaction from exercising all their rights and obligations under the transaction documents. This document cannot be reproduced except in full, without prior written approval of the Company. Any unauthorized alteration, forgery or falsification of the content or appearance of this document is unlawful and offenders may be prosecuted to the fullest extent of the law. Unless otherwise stated the results shown in this test report refer only to the sample(s) tested and such sample(s) are retained for 30 days only.

Attention: To check the authenticity of testing/inspection report & certificate, please contact us at telephone: (86-755) 8307 1443, or email: [CN.Doccheck@sgs.com](mailto:CN.Doccheck@sgs.com)  
 S/GS-CSTC Standards Technical Services (Xi'an) Co., Ltd. | 1/E Unit D, Building 1, Kanglong Orange Science Park, No.157, Keyuan 3rd Road, Fengjing/Yue Town, Xi'an, Shaanxi, China | 710086 | t (86-29) 6282 7885 | www.sgs.com.cn  
 中国·西安·沣东新城科里三路157号康隆橙方科技园1号楼D单元1层 | 邮编: 710086 | t (86-29) 6282 7885 | sgs.china@sgs.com



11ac80MIMO	5530	Type6	23	1	333.3	9	0.3333	300	5285	1
11ac80MIMO	5530	Type6	23	1	333.3	9	0.3333	300	5274	1
11ac80MIMO	5530	Type6	23	1	333.3	9	0.3333	300	5486	1
11ac80MIMO	5530	Type6	23	1	333.3	9	0.3333	300	5275	1
11ac80MIMO	5530	Type6	23	1	333.3	9	0.3333	300	5349	1
11ac80MIMO	5530	Type6	23	1	333.3	9	0.3333	300	5298	1
11ac80MIMO	5530	Type6	23	1	333.3	9	0.3333	300	5680	1
11ac80MIMO	5530	Type6	23	1	333.3	9	0.3333	300	5416	1
11ac80MIMO	5530	Type6	23	1	333.3	9	0.3333	300	5463	1
11ac80MIMO	5530	Type6	23	1	333.3	9	0.3333	300	5512	1
11ac80MIMO	5530	Type6	23	1	333.3	9	0.3333	300	5251	1
11ac80MIMO	5530	Type6	23	1	333.3	9	0.3333	300	5713	1
11ac80MIMO	5530	Type6	23	1	333.3	9	0.3333	300	5474	1
11ac80MIMO	5530	Type6	23	1	333.3	9	0.3333	300	5667	1
11ac80MIMO	5530	Type6	23	1	333.3	9	0.3333	300	5683	1
11ac80MIMO	5530	Type6	23	1	333.3	9	0.3333	300	5453	1
11ac80MIMO	5530	Type6	23	1	333.3	9	0.3333	300	5282	1
11ac80MIMO	5530	Type6	23	1	333.3	9	0.3333	300	5438	1
11ac80MIMO	5530	Type6	23	1	333.3	9	0.3333	300	5718	1
11ac80MIMO	5530	Type6	23	1	333.3	9	0.3333	300	5566	1
11ac80MIMO	5530	Type6	23	1	333.3	9	0.3333	300	5534	1
11ac80MIMO	5530	Type6	23	1	333.3	9	0.3333	300	5399	1
11ac80MIMO	5530	Type6	23	1	333.3	9	0.3333	300	5514	1
11ac80MIMO	5530	Type6	23	1	333.3	9	0.3333	300	5656	1
11ac80MIMO	5530	Type6	23	1	333.3	9	0.3333	300	5633	1
11ac80MIMO	5530	Type6	23	1	333.3	9	0.3333	300	5409	1
11ac80MIMO	5530	Type6	23	1	333.3	9	0.3333	300	5567	1
11ac80MIMO	5530	Type6	23	1	333.3	9	0.3333	300	5584	1
11ac80MIMO	5530	Type6	23	1	333.3	9	0.3333	300	5338	1
11ac80MIMO	5530	Type6	23	1	333.3	9	0.3333	300	5545	1
11ac80MIMO	5530	Type6	23	1	333.3	9	0.3333	300	5623	1
11ac80MIMO	5530	Type6	23	1	333.3	9	0.3333	300	5490	1
11ac80MIMO	5530	Type6	23	1	333.3	9	0.3333	300	5663	1
11ac80MIMO	5530	Type6	23	1	333.3	9	0.3333	300	5612	1
11ac80MIMO	5530	Type6	23	1	333.3	9	0.3333	300	5309	1
11ac80MIMO	5530	Type6	23	1	333.3	9	0.3333	300	5406	1
11ac80MIMO	5530	Type6	23	1	333.3	9	0.3333	300	5694	1
11ac80MIMO	5530	Type6	23	1	333.3	9	0.3333	300	5525	1
11ac80MIMO	5530	Type6	23	1	333.3	9	0.3333	300	5499	1
11ac80MIMO	5530	Type6	23	1	333.3	9	0.3333	300	5448	1
11ac80MIMO	5530	Type6	23	1	333.3	9	0.3333	300	5294	1
11ac80MIMO	5530	Type6	23	1	333.3	9	0.3333	300	5574	1
11ac80MIMO	5530	Type6	23	1	333.3	9	0.3333	300	5332	1
11ac80MIMO	5530	Type6	23	1	333.3	9	0.3333	300	5659	1
11ac80MIMO	5530	Type6	23	1	333.3	9	0.3333	300	5370	1
11ac80MIMO	5530	Type6	23	1	333.3	9	0.3333	300	5436	1
11ac80MIMO	5530	Type6	23	1	333.3	9	0.3333	300	5477	1
11ac80MIMO	5530	Type6	23	1	333.3	9	0.3333	300	5415	1
11ac80MIMO	5530	Type6	23	1	333.3	9	0.3333	300	5542	1
11ac80MIMO	5530	Type6	23	1	333.3	9	0.3333	300	5467	1
11ac80MIMO	5530	Type6	23	1	333.3	9	0.3333	300	5319	1
11ac40MIMO	5510	Type6	23	1	333.3	9	0.3333	300	5519	1
11ac40MIMO	5510	Type6	23	1	333.3	9	0.3333	300	5708	1



Unless otherwise agreed in writing, this document is issued by the Company subject to its General Conditions of Service printed overleaf, available on request or accessible at <http://www.sgs.com/en/Terms-and-Conditions.aspx> and, for electronic format documents, subject to Terms and Conditions for Electronic Documents at <http://www.sgs.com/en/Terms-and-Conditions/Terms-e-Documents.aspx>. Attention is drawn to the limitation of liability, indemnification and jurisdiction issues defined therein. Any holder of this document is advised that information contained herein reflects the Company's findings at the time of its intervention only and within the limits of Client's instructions, if any. The Company's sole responsibility is to its Client and this document does not exonerate parties to a transaction from exercising all their rights and obligations under the transaction documents. This document cannot be reproduced except in full, without prior written approval of the Company. Any unauthorized alteration, forgery or falsification of the content or appearance of this document is unlawful and offenders may be prosecuted to the fullest extent of the law. Unless otherwise stated the results shown in this test report refer only to the sample(s) tested and such sample(s) are retained for 30 days only.

Attention: To check the authenticity of testing inspection report & certificate, please contact us at telephone: (86-755) 8307 1443, or email: [CN.Doccheck@sgs.com](mailto:CN.Doccheck@sgs.com)  
 (E) Unit D, Building 1, Kanglong Orange Science Park, No.157, Keyuan 3rd Road, Fengjing/Yue Town, Xian, Shaanxi, China 710086 t (86-29) 6282 7885 www.sgs.com.cn  
 中国·西安·沣东新城科里三路157号康隆橙方科技园1号楼D单元1层 邮编: 710086 t (86-29) 6282 7885 sgs.china@sgs.com

11ac40MIMO	5510	Type6	23	1	333.3	9	0.3333	300	5287	1
11ac40MIMO	5510	Type6	23	1	333.3	9	0.3333	300	5695	1
11ac40MIMO	5510	Type6	23	1	333.3	9	0.3333	300	5501	1
11ac40MIMO	5510	Type6	23	1	333.3	9	0.3333	300	5435	1
11ac40MIMO	5510	Type6	23	1	333.3	9	0.3333	300	5649	1
11ac40MIMO	5510	Type6	23	1	333.3	9	0.3333	300	5460	1
11ac40MIMO	5510	Type6	23	1	333.3	9	0.3333	300	5442	1
11ac40MIMO	5510	Type6	23	1	333.3	9	0.3333	300	5407	1
11ac40MIMO	5510	Type6	23	1	333.3	9	0.3333	300	5262	1
11ac40MIMO	5510	Type6	23	1	333.3	9	0.3333	300	5318	1
11ac40MIMO	5510	Type6	23	1	333.3	9	0.3333	300	5576	1
11ac40MIMO	5510	Type6	23	1	333.3	9	0.3333	300	5269	1
11ac40MIMO	5510	Type6	23	1	333.3	9	0.3333	300	5596	1
11ac40MIMO	5510	Type6	23	1	333.3	9	0.3333	300	5638	1
11ac40MIMO	5510	Type6	23	1	333.3	9	0.3333	300	5699	1
11ac40MIMO	5510	Type6	23	1	333.3	9	0.3333	300	5377	1
11ac40MIMO	5510	Type6	23	1	333.3	9	0.3333	300	5412	1
11ac40MIMO	5510	Type6	23	1	333.3	9	0.3333	300	5591	1
11ac40MIMO	5510	Type6	23	1	333.3	9	0.3333	300	5706	1
11ac40MIMO	5510	Type6	23	1	333.3	9	0.3333	300	5336	1
11ac40MIMO	5510	Type6	23	1	333.3	9	0.3333	300	5362	1
11ac40MIMO	5510	Type6	23	1	333.3	9	0.3333	300	5432	1
11ac40MIMO	5510	Type6	23	1	333.3	9	0.3333	300	5697	1
11ac40MIMO	5510	Type6	23	1	333.3	9	0.3333	300	5387	1
11ac40MIMO	5510	Type6	23	1	333.3	9	0.3333	300	5556	1
11ac40MIMO	5510	Type6	23	1	333.3	9	0.3333	300	5454	1
11ac40MIMO	5510	Type6	23	1	333.3	9	0.3333	300	5658	1
11ac40MIMO	5510	Type6	23	1	333.3	9	0.3333	300	5417	1
11ac40MIMO	5510	Type6	23	1	333.3	9	0.3333	300	5457	1
11ac40MIMO	5510	Type6	23	1	333.3	9	0.3333	300	5373	1
11ac40MIMO	5510	Type6	23	1	333.3	9	0.3333	300	5712	1
11ac40MIMO	5510	Type6	23	1	333.3	9	0.3333	300	5408	1
11ac40MIMO	5510	Type6	23	1	333.3	9	0.3333	300	5645	1
11ac40MIMO	5510	Type6	23	1	333.3	9	0.3333	300	5480	1
11ac40MIMO	5510	Type6	23	1	333.3	9	0.3333	300	5568	1
11ac40MIMO	5510	Type6	23	1	333.3	9	0.3333	300	5350	1
11ac40MIMO	5510	Type6	23	1	333.3	9	0.3333	300	5360	1
11ac40MIMO	5510	Type6	23	1	333.3	9	0.3333	300	5352	1
11ac40MIMO	5510	Type6	23	1	333.3	9	0.3333	300	5660	1
11ac40MIMO	5510	Type6	23	1	333.3	9	0.3333	300	5323	1
11ac40MIMO	5510	Type6	23	1	333.3	9	0.3333	300	5652	1
11ac40MIMO	5510	Type6	23	1	333.3	9	0.3333	300	5520	1
11ac40MIMO	5510	Type6	23	1	333.3	9	0.3333	300	5573	1
11ac40MIMO	5510	Type6	23	1	333.3	9	0.3333	300	5468	1
11ac40MIMO	5510	Type6	23	1	333.3	9	0.3333	300	5299	1
11ac40MIMO	5510	Type6	23	1	333.3	9	0.3333	300	5470	1
11ac40MIMO	5510	Type6	23	1	333.3	9	0.3333	300	5634	1
11ac40MIMO	5510	Type6	23	1	333.3	9	0.3333	300	5285	1
11ac40MIMO	5510	Type6	23	1	333.3	9	0.3333	300	5274	1
11ac40MIMO	5510	Type6	23	1	333.3	9	0.3333	300	5486	1
11ac40MIMO	5510	Type6	23	1	333.3	9	0.3333	300	5275	1
11ac40MIMO	5510	Type6	23	1	333.3	9	0.3333	300	5349	1
11ac40MIMO	5510	Type6	23	1	333.3	9	0.3333	300	5298	1



Unless otherwise agreed in writing, this document is issued by the Company subject to its General Conditions of Service printed overleaf, available on request or accessible at <http://www.sgs.com/en/Terms-and-Conditions.aspx> and, for electronic format documents, subject to Terms and Conditions for Electronic Documents at <http://www.sgs.com/en/Terms-and-Conditions/Terms-e-Documents.aspx>. Attention is drawn to the limitation of liability, indemnification and jurisdiction issues defined therein. Any holder of this document is advised that information contained herein reflects the Company's findings at the time of its intervention only and within the limits of Client's instructions, if any. The Company's sole responsibility is to its Client and this document does not exonerate parties to a transaction from exercising all their rights and obligations under the transaction documents. This document cannot be reproduced except in full, without prior written approval of the Company. Any unauthorized alteration, forgery or falsification of the content or appearance of this document is unlawful and offenders may be prosecuted to the fullest extent of the law. Unless otherwise stated the results shown in this test report refer only to the sample(s) tested and such sample(s) are retained for 30 days only.

Attention: To check the authenticity of testing/inspection report & certificate, please contact us at telephone: (86-755) 8307 1443, or email: [CN.Doccheck@sgs.com](mailto:CN.Doccheck@sgs.com)

SGS-CSTC Standards Technical Services (Xi'an) Co., Ltd. | 1/F, Unit D, Building 1, Kanglong Orange Science Park, No.137, Keyuan 3rd Road, Fengyang New Town, Xi'an, Shaanxi, China | 710086 | T (86-29) 6282 7885 | [www.sgs.com.cn](http://www.sgs.com.cn)  
 中国·西安·沣东新城科里三路137号康隆橙方科技园1号楼D单元1层 | 邮编: 710086 | T (86-29) 6282 7885 | [sgs.china@sgs.com](mailto:sgs.china@sgs.com)

11ac40MIMO	5510	Type6	23	1	333.3	9	0.3333	300	5680	1
11ac40MIMO	5510	Type6	23	1	333.3	9	0.3333	300	5416	1
11ac40MIMO	5510	Type6	23	1	333.3	9	0.3333	300	5463	1
11ac40MIMO	5510	Type6	23	1	333.3	9	0.3333	300	5512	1
11ac40MIMO	5510	Type6	23	1	333.3	9	0.3333	300	5251	1
11ac40MIMO	5510	Type6	23	1	333.3	9	0.3333	300	5713	1
11ac40MIMO	5510	Type6	23	1	333.3	9	0.3333	300	5474	1
11ac40MIMO	5510	Type6	23	1	333.3	9	0.3333	300	5667	1
11ac40MIMO	5510	Type6	23	1	333.3	9	0.3333	300	5683	1
11ac40MIMO	5510	Type6	23	1	333.3	9	0.3333	300	5453	1
11ac40MIMO	5510	Type6	23	1	333.3	9	0.3333	300	5282	1
11ac40MIMO	5510	Type6	23	1	333.3	9	0.3333	300	5438	1
11ac40MIMO	5510	Type6	23	1	333.3	9	0.3333	300	5718	1
11ac40MIMO	5510	Type6	23	1	333.3	9	0.3333	300	5566	1
11ac40MIMO	5510	Type6	23	1	333.3	9	0.3333	300	5534	1
11ac40MIMO	5510	Type6	23	1	333.3	9	0.3333	300	5399	1
11ac40MIMO	5510	Type6	23	1	333.3	9	0.3333	300	5514	1
11ac40MIMO	5510	Type6	23	1	333.3	9	0.3333	300	5656	1
11ac40MIMO	5510	Type6	23	1	333.3	9	0.3333	300	5633	1
11ac40MIMO	5510	Type6	23	1	333.3	9	0.3333	300	5409	1
11ac40MIMO	5510	Type6	23	1	333.3	9	0.3333	300	5567	1
11ac40MIMO	5510	Type6	23	1	333.3	9	0.3333	300	5584	1
11ac40MIMO	5510	Type6	23	1	333.3	9	0.3333	300	5338	1
11ac40MIMO	5510	Type6	23	1	333.3	9	0.3333	300	5545	1
11ac40MIMO	5510	Type6	23	1	333.3	9	0.3333	300	5623	1
11ac40MIMO	5510	Type6	23	1	333.3	9	0.3333	300	5490	1
11ac40MIMO	5510	Type6	23	1	333.3	9	0.3333	300	5663	1
11ac40MIMO	5510	Type6	23	1	333.3	9	0.3333	300	5612	1
11ac40MIMO	5510	Type6	23	1	333.3	9	0.3333	300	5309	1
11ac40MIMO	5510	Type6	23	1	333.3	9	0.3333	300	5406	1
11ac40MIMO	5510	Type6	23	1	333.3	9	0.3333	300	5694	1
11ac40MIMO	5510	Type6	23	1	333.3	9	0.3333	300	5525	1
11ac40MIMO	5510	Type6	23	1	333.3	9	0.3333	300	5499	1
11ac40MIMO	5510	Type6	23	1	333.3	9	0.3333	300	5448	1
11ac40MIMO	5510	Type6	23	1	333.3	9	0.3333	300	5294	1
11ac40MIMO	5510	Type6	23	1	333.3	9	0.3333	300	5574	1
11ac40MIMO	5510	Type6	23	1	333.3	9	0.3333	300	5332	1
11ac40MIMO	5510	Type6	23	1	333.3	9	0.3333	300	5659	1
11ac40MIMO	5510	Type6	23	1	333.3	9	0.3333	300	5370	1
11ac40MIMO	5510	Type6	23	1	333.3	9	0.3333	300	5436	1
11ac40MIMO	5510	Type6	23	1	333.3	9	0.3333	300	5477	1
11ac40MIMO	5510	Type6	23	1	333.3	9	0.3333	300	5415	1
11ac40MIMO	5510	Type6	23	1	333.3	9	0.3333	300	5542	1
11ac40MIMO	5510	Type6	23	1	333.3	9	0.3333	300	5467	1
11ac40MIMO	5510	Type6	23	1	333.3	9	0.3333	300	5319	1
11ac20MIMO	5500	Type6	23	1	333.3	9	0.3333	300	5519	1
11ac20MIMO	5500	Type6	23	1	333.3	9	0.3333	300	5708	1
11ac20MIMO	5500	Type6	23	1	333.3	9	0.3333	300	5287	1
11ac20MIMO	5500	Type6	23	1	333.3	9	0.3333	300	5695	1
11ac20MIMO	5500	Type6	23	1	333.3	9	0.3333	300	5501	1
11ac20MIMO	5500	Type6	23	1	333.3	9	0.3333	300	5435	1
11ac20MIMO	5500	Type6	23	1	333.3	9	0.3333	300	5649	1
11ac20MIMO	5500	Type6	23	1	333.3	9	0.3333	300	5460	1



Unless otherwise agreed in writing, this document is issued by the Company subject to its General Conditions of Service printed overleaf, available on request or accessible at <http://www.sgs.com/en/Terms-and-Conditions.aspx> and, for electronic format documents, subject to Terms and Conditions for Electronic Documents at <http://www.sgs.com/en/Terms-and-Conditions/Terms-e-Documents.aspx>. Attention is drawn to the limitation of liability, indemnification and jurisdiction issues defined therein. Any holder of this document is advised that information contained herein reflects the Company's findings at the time of its intervention only and within the limits of Client's instructions, if any. The Company's sole responsibility is to its Client and this document does not exonerate parties to a transaction from exercising all their rights and obligations under the transaction documents. This document cannot be reproduced except in full, without prior written approval of the Company. Any unauthorized alteration, forgery or falsification of the content or appearance of this document is unlawful and offenders may be prosecuted to the fullest extent of the law. Unless otherwise stated the results shown in this test report refer only to the sample(s) tested and such sample(s) are retained for 30 days only.

Attention: To check the authenticity of testing/inspection report & certificate, please contact us at telephone: (86-755) 8307 1443, or email: [CN.Doccheck@sgs.com](mailto:CN.Doccheck@sgs.com)  
 (E) Unit D, Building 1, Kanglong Orange Science Park, No.157, Keyuan 3rd Road, Fengjing/Yue Town, Xi'an, Shaanxi, China 710086  
 t (86-29) 6282 7885 www.sgs.com.cn  
 中国·西安·沣东新城科里三路157号康隆橙方科技园1号楼D单元1层 邮编: 710086 t (86-29) 6282 7885 sgs.china@sgs.com

11ac20MIMO	5500	Type6	23	1	333.3	9	0.3333	300	5442	1
11ac20MIMO	5500	Type6	23	1	333.3	9	0.3333	300	5407	1
11ac20MIMO	5500	Type6	23	1	333.3	9	0.3333	300	5262	1
11ac20MIMO	5500	Type6	23	1	333.3	9	0.3333	300	5318	1
11ac20MIMO	5500	Type6	23	1	333.3	9	0.3333	300	5576	1
11ac20MIMO	5500	Type6	23	1	333.3	9	0.3333	300	5269	1
11ac20MIMO	5500	Type6	23	1	333.3	9	0.3333	300	5596	1
11ac20MIMO	5500	Type6	23	1	333.3	9	0.3333	300	5638	1
11ac20MIMO	5500	Type6	23	1	333.3	9	0.3333	300	5699	1
11ac20MIMO	5500	Type6	23	1	333.3	9	0.3333	300	5377	1
11ac20MIMO	5500	Type6	23	1	333.3	9	0.3333	300	5412	1
11ac20MIMO	5500	Type6	23	1	333.3	9	0.3333	300	5591	1
11ac20MIMO	5500	Type6	23	1	333.3	9	0.3333	300	5706	1
11ac20MIMO	5500	Type6	23	1	333.3	9	0.3333	300	5336	1
11ac20MIMO	5500	Type6	23	1	333.3	9	0.3333	300	5362	1
11ac20MIMO	5500	Type6	23	1	333.3	9	0.3333	300	5432	1
11ac20MIMO	5500	Type6	23	1	333.3	9	0.3333	300	5697	1
11ac20MIMO	5500	Type6	23	1	333.3	9	0.3333	300	5387	1
11ac20MIMO	5500	Type6	23	1	333.3	9	0.3333	300	5556	1
11ac20MIMO	5500	Type6	23	1	333.3	9	0.3333	300	5454	1
11ac20MIMO	5500	Type6	23	1	333.3	9	0.3333	300	5658	1
11ac20MIMO	5500	Type6	23	1	333.3	9	0.3333	300	5417	1
11ac20MIMO	5500	Type6	23	1	333.3	9	0.3333	300	5457	1
11ac20MIMO	5500	Type6	23	1	333.3	9	0.3333	300	5373	1
11ac20MIMO	5500	Type6	23	1	333.3	9	0.3333	300	5712	1
11ac20MIMO	5500	Type6	23	1	333.3	9	0.3333	300	5408	1
11ac20MIMO	5500	Type6	23	1	333.3	9	0.3333	300	5645	1
11ac20MIMO	5500	Type6	23	1	333.3	9	0.3333	300	5480	1
11ac20MIMO	5500	Type6	23	1	333.3	9	0.3333	300	5568	1
11ac20MIMO	5500	Type6	23	1	333.3	9	0.3333	300	5350	1
11ac20MIMO	5500	Type6	23	1	333.3	9	0.3333	300	5360	1
11ac20MIMO	5500	Type6	23	1	333.3	9	0.3333	300	5352	1
11ac20MIMO	5500	Type6	23	1	333.3	9	0.3333	300	5660	1
11ac20MIMO	5500	Type6	23	1	333.3	9	0.3333	300	5323	1
11ac20MIMO	5500	Type6	23	1	333.3	9	0.3333	300	5652	1
11ac20MIMO	5500	Type6	23	1	333.3	9	0.3333	300	5520	1
11ac20MIMO	5500	Type6	23	1	333.3	9	0.3333	300	5573	1
11ac20MIMO	5500	Type6	23	1	333.3	9	0.3333	300	5468	1
11ac20MIMO	5500	Type6	23	1	333.3	9	0.3333	300	5299	1
11ac20MIMO	5500	Type6	23	1	333.3	9	0.3333	300	5470	1
11ac20MIMO	5500	Type6	23	1	333.3	9	0.3333	300	5634	1
11ac20MIMO	5500	Type6	23	1	333.3	9	0.3333	300	5285	1
11ac20MIMO	5500	Type6	23	1	333.3	9	0.3333	300	5274	1
11ac20MIMO	5500	Type6	23	1	333.3	9	0.3333	300	5486	1
11ac20MIMO	5500	Type6	23	1	333.3	9	0.3333	300	5275	1
11ac20MIMO	5500	Type6	23	1	333.3	9	0.3333	300	5349	1
11ac20MIMO	5500	Type6	23	1	333.3	9	0.3333	300	5298	1
11ac20MIMO	5500	Type6	23	1	333.3	9	0.3333	300	5680	1
11ac20MIMO	5500	Type6	23	1	333.3	9	0.3333	300	5416	1
11ac20MIMO	5500	Type6	23	1	333.3	9	0.3333	300	5463	1
11ac20MIMO	5500	Type6	23	1	333.3	9	0.3333	300	5512	1
11ac20MIMO	5500	Type6	23	1	333.3	9	0.3333	300	5251	1
11ac20MIMO	5500	Type6	23	1	333.3	9	0.3333	300	5713	1



Unless otherwise agreed in writing, this document is issued by the Company subject to its General Conditions of Service printed overleaf, available on request or accessible at <http://www.sgs.com/en/Terms-and-Conditions.aspx> and, for electronic format documents, subject to Terms and Conditions for Electronic Documents at <http://www.sgs.com/en/Terms-and-Conditions/Terms-e-Document.aspx>. Attention is drawn to the limitation of liability, indemnification and jurisdiction issues defined therein. Any holder of this document is advised that information contained herein reflects the Company's findings at the time of its intervention only and within the limits of Client's instructions, if any. The Company's sole responsibility is to its Client and this document does not exonerate parties to a transaction from exercising all their rights and obligations under the transaction documents. This document cannot be reproduced except in full, without prior written approval of the Company. Any unauthorized alteration, forgery or falsification of the content or appearance of this document is unlawful and offenders may be prosecuted to the fullest extent of the law. Unless otherwise stated the results shown in this test report refer only to the sample(s) tested and such sample(s) are retained for 30 days only.

Attention: To check the authenticity of testing/inspection report & certificate, please contact us at telephone: (86-755) 8307 1443, or email: [CN.Doccheck@sgs.com](mailto:CN.Doccheck@sgs.com)  
 1/E Unit D, Building 1, Kanglong Orange Science Park, No.157, Keyuan 3rd Road, Fengyang New Town, Xi'an, Shaanxi, China 710086  
 t (86-29) 6282 7885 www.sgs.com.cn  
 中国·西安·沣东新城科里三路157号康隆橙方科技园1号楼D单元1层 邮编: 710086 t (86-29) 6282 7885 sgs.china@sgs.com

Report No.: XEWA2310000070RG05

Rev.: 01

Page: 231 of 267

11ac20MIMO	5500	Type6	23	1	333.3	9	0.3333	300	5474	1
11ac20MIMO	5500	Type6	23	1	333.3	9	0.3333	300	5667	1
11ac20MIMO	5500	Type6	23	1	333.3	9	0.3333	300	5683	1
11ac20MIMO	5500	Type6	23	1	333.3	9	0.3333	300	5453	1
11ac20MIMO	5500	Type6	23	1	333.3	9	0.3333	300	5282	1
11ac20MIMO	5500	Type6	23	1	333.3	9	0.3333	300	5438	1
11ac20MIMO	5500	Type6	23	1	333.3	9	0.3333	300	5718	1
11ac20MIMO	5500	Type6	23	1	333.3	9	0.3333	300	5566	1
11ac20MIMO	5500	Type6	23	1	333.3	9	0.3333	300	5534	1
11ac20MIMO	5500	Type6	23	1	333.3	9	0.3333	300	5399	1
11ac20MIMO	5500	Type6	23	1	333.3	9	0.3333	300	5514	1
11ac20MIMO	5500	Type6	23	1	333.3	9	0.3333	300	5656	1
11ac20MIMO	5500	Type6	23	1	333.3	9	0.3333	300	5633	1
11ac20MIMO	5500	Type6	23	1	333.3	9	0.3333	300	5409	1
11ac20MIMO	5500	Type6	23	1	333.3	9	0.3333	300	5567	1
11ac20MIMO	5500	Type6	23	1	333.3	9	0.3333	300	5584	1
11ac20MIMO	5500	Type6	23	1	333.3	9	0.3333	300	5338	1
11ac20MIMO	5500	Type6	23	1	333.3	9	0.3333	300	5545	1
11ac20MIMO	5500	Type6	23	1	333.3	9	0.3333	300	5623	1
11ac20MIMO	5500	Type6	23	1	333.3	9	0.3333	300	5490	1
11ac20MIMO	5500	Type6	23	1	333.3	9	0.3333	300	5663	1
11ac20MIMO	5500	Type6	23	1	333.3	9	0.3333	300	5612	1
11ac20MIMO	5500	Type6	23	1	333.3	9	0.3333	300	5309	1
11ac20MIMO	5500	Type6	23	1	333.3	9	0.3333	300	5406	1
11ac20MIMO	5500	Type6	23	1	333.3	9	0.3333	300	5694	1
11ac20MIMO	5500	Type6	23	1	333.3	9	0.3333	300	5525	1
11ac20MIMO	5500	Type6	23	1	333.3	9	0.3333	300	5499	1
11ac20MIMO	5500	Type6	23	1	333.3	9	0.3333	300	5448	1
11ac20MIMO	5500	Type6	23	1	333.3	9	0.3333	300	5294	1
11ac20MIMO	5500	Type6	23	1	333.3	9	0.3333	300	5574	1
11ac20MIMO	5500	Type6	23	1	333.3	9	0.3333	300	5332	1
11ac20MIMO	5500	Type6	23	1	333.3	9	0.3333	300	5659	1
11ac20MIMO	5500	Type6	23	1	333.3	9	0.3333	300	5370	1
11ac20MIMO	5500	Type6	23	1	333.3	9	0.3333	300	5436	1
11ac20MIMO	5500	Type6	23	1	333.3	9	0.3333	300	5477	1
11ac20MIMO	5500	Type6	23	1	333.3	9	0.3333	300	5415	1
11ac20MIMO	5500	Type6	23	1	333.3	9	0.3333	300	5542	1
11ac20MIMO	5500	Type6	23	1	333.3	9	0.3333	300	5467	1
11ac20MIMO	5500	Type6	23	1	333.3	9	0.3333	300	5319	1



Unless otherwise agreed in writing, this document is issued by the Company subject to its General Conditions of Service printed overleaf, available on request or accessible at <http://www.sgs.com/en/Terms-and-Conditions.aspx> and, for electronic format documents, subject to Terms and Conditions for Electronic Documents at <http://www.sgs.com/en/Terms-and-Conditions/Terms-e-Documents.aspx>. Attention is drawn to the limitation of liability, indemnification and jurisdiction issues defined therein. Any holder of this document is advised that information contained herein reflects the Company's findings at the time of its intervention only and within the limits of Client's instructions, if any. The Company's sole responsibility is to its Client and this document does not exonerate parties to a transaction from exercising all their rights and obligations under the transaction documents. This document cannot be reproduced except in full, without prior written approval of the Company. Any unauthorized alteration, forgery or falsification of the content or appearance of this document is unlawful and offenders may be prosecuted to the fullest extent of the law. Unless otherwise stated the results shown in this test report refer only to the sample(s) tested and such sample(s) are retained for 30 days only.

Attention: To check the authenticity of testing/inspection report & certificate, please contact us at telephone: (86-755) 4307 1443, or email: [CN.Doccheck@sgs.com](mailto:CN.Doccheck@sgs.com)  
 (SGS-CSTC) Standards Technical Services (Xi'an) Co., Ltd. | 1/E Unit D, Building 1, Kanghong Orange Source Park, No.137, Kejian 3rd Road, Fengling New Town, Xi'an, Shaanxi, China | 710086 | t: (86-29) 6282 7885 | www.sgs.com.cn  
 中国·西安·沣东新城科里三路137号康鸿橙方科技园1号楼D单元1层 | 邮编: 710086 | t: (86-29) 6282 7885 | sgs.china@sgs.com

TestMode	Channel	Radar Type	Trial ID	Pulse width (μs)	PRI (μs)	Pulses per Hop	Hop Rate (kHz)	Hop Sequence Length(ms)	Center Frequency (MHz)	Detection (1: Yes; 0: No)
11ac80MIMO	5530	Type6	24	1	333.3	9	0.3333	300	5299	1
11ac80MIMO	5530	Type6	24	1	333.3	9	0.3333	300	5472	1
11ac80MIMO	5530	Type6	24	1	333.3	9	0.3333	300	5698	1
11ac80MIMO	5530	Type6	24	1	333.3	9	0.3333	300	5381	1
11ac80MIMO	5530	Type6	24	1	333.3	9	0.3333	300	5721	1
11ac80MIMO	5530	Type6	24	1	333.3	9	0.3333	300	5477	1
11ac80MIMO	5530	Type6	24	1	333.3	9	0.3333	300	5574	1
11ac80MIMO	5530	Type6	24	1	333.3	9	0.3333	300	5535	1
11ac80MIMO	5530	Type6	24	1	333.3	9	0.3333	300	5508	1
11ac80MIMO	5530	Type6	24	1	333.3	9	0.3333	300	5614	1
11ac80MIMO	5530	Type6	24	1	333.3	9	0.3333	300	5668	1
11ac80MIMO	5530	Type6	24	1	333.3	9	0.3333	300	5582	1
11ac80MIMO	5530	Type6	24	1	333.3	9	0.3333	300	5617	1
11ac80MIMO	5530	Type6	24	1	333.3	9	0.3333	300	5367	1
11ac80MIMO	5530	Type6	24	1	333.3	9	0.3333	300	5251	1
11ac80MIMO	5530	Type6	24	1	333.3	9	0.3333	300	5351	1
11ac80MIMO	5530	Type6	24	1	333.3	9	0.3333	300	5383	1
11ac80MIMO	5530	Type6	24	1	333.3	9	0.3333	300	5505	1
11ac80MIMO	5530	Type6	24	1	333.3	9	0.3333	300	5604	1
11ac80MIMO	5530	Type6	24	1	333.3	9	0.3333	300	5527	1
11ac80MIMO	5530	Type6	24	1	333.3	9	0.3333	300	5660	1
11ac80MIMO	5530	Type6	24	1	333.3	9	0.3333	300	5647	1
11ac80MIMO	5530	Type6	24	1	333.3	9	0.3333	300	5328	1
11ac80MIMO	5530	Type6	24	1	333.3	9	0.3333	300	5335	1
11ac80MIMO	5530	Type6	24	1	333.3	9	0.3333	300	5549	1
11ac80MIMO	5530	Type6	24	1	333.3	9	0.3333	300	5590	1
11ac80MIMO	5530	Type6	24	1	333.3	9	0.3333	300	5488	1
11ac80MIMO	5530	Type6	24	1	333.3	9	0.3333	300	5700	1
11ac80MIMO	5530	Type6	24	1	333.3	9	0.3333	300	5403	1
11ac80MIMO	5530	Type6	24	1	333.3	9	0.3333	300	5414	1
11ac80MIMO	5530	Type6	24	1	333.3	9	0.3333	300	5588	1
11ac80MIMO	5530	Type6	24	1	333.3	9	0.3333	300	5389	1
11ac80MIMO	5530	Type6	24	1	333.3	9	0.3333	300	5703	1
11ac80MIMO	5530	Type6	24	1	333.3	9	0.3333	300	5309	1
11ac80MIMO	5530	Type6	24	1	333.3	9	0.3333	300	5571	1
11ac80MIMO	5530	Type6	24	1	333.3	9	0.3333	300	5364	1
11ac80MIMO	5530	Type6	24	1	333.3	9	0.3333	300	5503	1
11ac80MIMO	5530	Type6	24	1	333.3	9	0.3333	300	5274	1
11ac80MIMO	5530	Type6	24	1	333.3	9	0.3333	300	5666	1
11ac80MIMO	5530	Type6	24	1	333.3	9	0.3333	300	5365	1
11ac80MIMO	5530	Type6	24	1	333.3	9	0.3333	300	5261	1
11ac80MIMO	5530	Type6	24	1	333.3	9	0.3333	300	5417	1
11ac80MIMO	5530	Type6	24	1	333.3	9	0.3333	300	5517	1
11ac80MIMO	5530	Type6	24	1	333.3	9	0.3333	300	5405	1
11ac80MIMO	5530	Type6	24	1	333.3	9	0.3333	300	5448	1
11ac80MIMO	5530	Type6	24	1	333.3	9	0.3333	300	5382	1
11ac80MIMO	5530	Type6	24	1	333.3	9	0.3333	300	5528	1
11ac80MIMO	5530	Type6	24	1	333.3	9	0.3333	300	5687	1
11ac80MIMO	5530	Type6	24	1	333.3	9	0.3333	300	5695	1



Unless otherwise agreed in writing, this document is issued by the Company subject to its General Conditions of Service printed overleaf, available on request or accessible at <http://www.sgs.com/en/Terms-and-Conditions.aspx> and, for electronic format documents, subject to Terms and Conditions for Electronic Documents at <http://www.sgs.com/en/Terms-and-Conditions/Terms-e-Documents.aspx>. Attention is drawn to the limitation of liability, indemnification and jurisdiction issues defined therein. Any holder of this document is advised that information contained herein reflects the Company's findings at the time of its intervention only and within the limits of Client's instructions, if any. The Company's sole responsibility is to its Client and this document does not exonerate parties to a transaction from exercising all their rights and obligations under the transaction documents. This document cannot be reproduced except in full, without prior written approval of the Company. Any unauthorized alteration, forgery or falsification of the content or appearance of this document is unlawful and offenders may be prosecuted to the fullest extent of the law. Unless otherwise stated the results shown in this test report refer only to the sample(s) tested and such sample(s) are retained for 30 days only.

Attention: To check the authenticity of testing/inspection report & certificate, please contact us at telephone: (86-755) 8307 1443, or email: [CN.Doccheck@sgs.com](mailto:CN.Doccheck@sgs.com)

SGS-CSTC Standards Technical Services (Xi'an) Co., Ltd. | 1/E Unit D, Building 1, Kanglong Orange Science Park, No.157, Keyuan 3rd Road, Fengjing/Yue Town, Xi'an, Shaanxi, China | 710086 | T: (86-29) 6282 7885 | [www.sgs.com](http://www.sgs.com)  
 中国·西安·沣东新城科里三路157号康隆橙方科技园1号楼D单元1层 | 邮编: 710086 | T: (86-29) 6282 7885 | [sgs.china@sgs.com](mailto:sgs.china@sgs.com)





11ac80MIMO	5530	Type6	24	1	333.3	9	0.3333	300	5537	1
11ac80MIMO	5530	Type6	24	1	333.3	9	0.3333	300	5717	1
11ac80MIMO	5530	Type6	24	1	333.3	9	0.3333	300	5393	1
11ac80MIMO	5530	Type6	24	1	333.3	9	0.3333	300	5370	1
11ac80MIMO	5530	Type6	24	1	333.3	9	0.3333	300	5653	1
11ac80MIMO	5530	Type6	24	1	333.3	9	0.3333	300	5331	1
11ac80MIMO	5530	Type6	24	1	333.3	9	0.3333	300	5600	1
11ac80MIMO	5530	Type6	24	1	333.3	9	0.3333	300	5270	1
11ac80MIMO	5530	Type6	24	1	333.3	9	0.3333	300	5639	1
11ac80MIMO	5530	Type6	24	1	333.3	9	0.3333	300	5612	1
11ac80MIMO	5530	Type6	24	1	333.3	9	0.3333	300	5515	1
11ac80MIMO	5530	Type6	24	1	333.3	9	0.3333	300	5376	1
11ac80MIMO	5530	Type6	24	1	333.3	9	0.3333	300	5667	1
11ac80MIMO	5530	Type6	24	1	333.3	9	0.3333	300	5269	1
11ac80MIMO	5530	Type6	24	1	333.3	9	0.3333	300	5252	1
11ac80MIMO	5530	Type6	24	1	333.3	9	0.3333	300	5677	1
11ac80MIMO	5530	Type6	24	1	333.3	9	0.3333	300	5586	1
11ac80MIMO	5530	Type6	24	1	333.3	9	0.3333	300	5642	1
11ac80MIMO	5530	Type6	24	1	333.3	9	0.3333	300	5258	1
11ac80MIMO	5530	Type6	24	1	333.3	9	0.3333	300	5636	1
11ac80MIMO	5530	Type6	24	1	333.3	9	0.3333	300	5543	1
11ac80MIMO	5530	Type6	24	1	333.3	9	0.3333	300	5458	1
11ac80MIMO	5530	Type6	24	1	333.3	9	0.3333	300	5479	1
11ac80MIMO	5530	Type6	24	1	333.3	9	0.3333	300	5623	1
11ac80MIMO	5530	Type6	24	1	333.3	9	0.3333	300	5400	1
11ac80MIMO	5530	Type6	24	1	333.3	9	0.3333	300	5444	1
11ac80MIMO	5530	Type6	24	1	333.3	9	0.3333	300	5301	1
11ac80MIMO	5530	Type6	24	1	333.3	9	0.3333	300	5372	1
11ac80MIMO	5530	Type6	24	1	333.3	9	0.3333	300	5428	1
11ac80MIMO	5530	Type6	24	1	333.3	9	0.3333	300	5341	1
11ac80MIMO	5530	Type6	24	1	333.3	9	0.3333	300	5575	1
11ac80MIMO	5530	Type6	24	1	333.3	9	0.3333	300	5290	1
11ac80MIMO	5530	Type6	24	1	333.3	9	0.3333	300	5316	1
11ac80MIMO	5530	Type6	24	1	333.3	9	0.3333	300	5345	1
11ac80MIMO	5530	Type6	24	1	333.3	9	0.3333	300	5347	1
11ac80MIMO	5530	Type6	24	1	333.3	9	0.3333	300	5627	1
11ac80MIMO	5530	Type6	24	1	333.3	9	0.3333	300	5349	1
11ac80MIMO	5530	Type6	24	1	333.3	9	0.3333	300	5470	1
11ac80MIMO	5530	Type6	24	1	333.3	9	0.3333	300	5565	1
11ac80MIMO	5530	Type6	24	1	333.3	9	0.3333	300	5432	1
11ac80MIMO	5530	Type6	24	1	333.3	9	0.3333	300	5628	1
11ac80MIMO	5530	Type6	24	1	333.3	9	0.3333	300	5676	1
11ac80MIMO	5530	Type6	24	1	333.3	9	0.3333	300	5447	1
11ac80MIMO	5530	Type6	24	1	333.3	9	0.3333	300	5672	1
11ac80MIMO	5530	Type6	24	1	333.3	9	0.3333	300	5552	1
11ac80MIMO	5530	Type6	24	1	333.3	9	0.3333	300	5468	1
11ac80MIMO	5530	Type6	24	1	333.3	9	0.3333	300	5469	1
11ac80MIMO	5530	Type6	24	1	333.3	9	0.3333	300	5359	1
11ac80MIMO	5530	Type6	24	1	333.3	9	0.3333	300	5321	1
11ac80MIMO	5530	Type6	24	1	333.3	9	0.3333	300	5325	1
11ac80MIMO	5530	Type6	24	1	333.3	9	0.3333	300	5678	1
11ac40MIMO	5510	Type6	24	1	333.3	9	0.3333	300	5299	1
11ac40MIMO	5510	Type6	24	1	333.3	9	0.3333	300	5472	1



Unless otherwise agreed in writing, this document is issued by the Company subject to its General Conditions of Service printed overleaf, available on request or accessible at <http://www.sgs.com/en/Terms-and-Conditions.aspx> and, for electronic format documents, subject to Terms and Conditions for Electronic Documents at <http://www.sgs.com/en/Terms-and-Conditions/Terms-e-Documents.aspx>. Attention is drawn to the limitation of liability, indemnification and jurisdiction issues defined therein. Any holder of this document is advised that information contained herein reflects the Company's findings at the time of its intervention only and within the limits of Client's instructions, if any. The Company's sole responsibility is to its Client and this document does not exonerate parties to a transaction from exercising all their rights and obligations under the transaction documents. This document cannot be reproduced except in full, without prior written approval of the Company. Any unauthorized alteration, forgery or falsification of the content or appearance of this document is unlawful and offenders may be prosecuted to the fullest extent of the law. Unless otherwise stated the results shown in this test report refer only to the sample(s) tested and such sample(s) are retained for 30 days only.

Attention: To check the authenticity of testing inspection report & certificate, please contact us at telephone: (86-755) 8307 1443, or email: [CN.Doccheck@sgs.com](mailto:CN.Doccheck@sgs.com)  
 (E) Unit D, Building 1, Kanglong Orange Science Park, No.157, Keyuan 3rd Road, Fengfeng New Town, Xin Shantou, China 710086  
 t (86-29) 6282 7885 www.sgs.com.cn  
 中国·西安·沣东新城科里三路157号康隆橙方科技园1号楼D单元1层 邮编: 710086 t (86-29) 6282 7885 sgs.china@sgs.com

11ac40MIMO	5510	Type6	24	1	333.3	9	0.3333	300	5698	1
11ac40MIMO	5510	Type6	24	1	333.3	9	0.3333	300	5381	1
11ac40MIMO	5510	Type6	24	1	333.3	9	0.3333	300	5721	1
11ac40MIMO	5510	Type6	24	1	333.3	9	0.3333	300	5477	1
11ac40MIMO	5510	Type6	24	1	333.3	9	0.3333	300	5574	1
11ac40MIMO	5510	Type6	24	1	333.3	9	0.3333	300	5535	1
11ac40MIMO	5510	Type6	24	1	333.3	9	0.3333	300	5508	1
11ac40MIMO	5510	Type6	24	1	333.3	9	0.3333	300	5614	1
11ac40MIMO	5510	Type6	24	1	333.3	9	0.3333	300	5668	1
11ac40MIMO	5510	Type6	24	1	333.3	9	0.3333	300	5582	1
11ac40MIMO	5510	Type6	24	1	333.3	9	0.3333	300	5617	1
11ac40MIMO	5510	Type6	24	1	333.3	9	0.3333	300	5367	1
11ac40MIMO	5510	Type6	24	1	333.3	9	0.3333	300	5251	1
11ac40MIMO	5510	Type6	24	1	333.3	9	0.3333	300	5351	1
11ac40MIMO	5510	Type6	24	1	333.3	9	0.3333	300	5383	1
11ac40MIMO	5510	Type6	24	1	333.3	9	0.3333	300	5505	1
11ac40MIMO	5510	Type6	24	1	333.3	9	0.3333	300	5604	1
11ac40MIMO	5510	Type6	24	1	333.3	9	0.3333	300	5527	1
11ac40MIMO	5510	Type6	24	1	333.3	9	0.3333	300	5660	1
11ac40MIMO	5510	Type6	24	1	333.3	9	0.3333	300	5647	1
11ac40MIMO	5510	Type6	24	1	333.3	9	0.3333	300	5328	1
11ac40MIMO	5510	Type6	24	1	333.3	9	0.3333	300	5335	1
11ac40MIMO	5510	Type6	24	1	333.3	9	0.3333	300	5549	1
11ac40MIMO	5510	Type6	24	1	333.3	9	0.3333	300	5590	1
11ac40MIMO	5510	Type6	24	1	333.3	9	0.3333	300	5488	1
11ac40MIMO	5510	Type6	24	1	333.3	9	0.3333	300	5700	1
11ac40MIMO	5510	Type6	24	1	333.3	9	0.3333	300	5403	1
11ac40MIMO	5510	Type6	24	1	333.3	9	0.3333	300	5414	1
11ac40MIMO	5510	Type6	24	1	333.3	9	0.3333	300	5588	1
11ac40MIMO	5510	Type6	24	1	333.3	9	0.3333	300	5389	1
11ac40MIMO	5510	Type6	24	1	333.3	9	0.3333	300	5703	1
11ac40MIMO	5510	Type6	24	1	333.3	9	0.3333	300	5309	1
11ac40MIMO	5510	Type6	24	1	333.3	9	0.3333	300	5571	1
11ac40MIMO	5510	Type6	24	1	333.3	9	0.3333	300	5364	1
11ac40MIMO	5510	Type6	24	1	333.3	9	0.3333	300	5503	1
11ac40MIMO	5510	Type6	24	1	333.3	9	0.3333	300	5274	1
11ac40MIMO	5510	Type6	24	1	333.3	9	0.3333	300	5666	1
11ac40MIMO	5510	Type6	24	1	333.3	9	0.3333	300	5365	1
11ac40MIMO	5510	Type6	24	1	333.3	9	0.3333	300	5261	1
11ac40MIMO	5510	Type6	24	1	333.3	9	0.3333	300	5417	1
11ac40MIMO	5510	Type6	24	1	333.3	9	0.3333	300	5517	1
11ac40MIMO	5510	Type6	24	1	333.3	9	0.3333	300	5405	1
11ac40MIMO	5510	Type6	24	1	333.3	9	0.3333	300	5448	1
11ac40MIMO	5510	Type6	24	1	333.3	9	0.3333	300	5382	1
11ac40MIMO	5510	Type6	24	1	333.3	9	0.3333	300	5528	1
11ac40MIMO	5510	Type6	24	1	333.3	9	0.3333	300	5687	1
11ac40MIMO	5510	Type6	24	1	333.3	9	0.3333	300	5695	1
11ac40MIMO	5510	Type6	24	1	333.3	9	0.3333	300	5537	1
11ac40MIMO	5510	Type6	24	1	333.3	9	0.3333	300	5717	1
11ac40MIMO	5510	Type6	24	1	333.3	9	0.3333	300	5393	1
11ac40MIMO	5510	Type6	24	1	333.3	9	0.3333	300	5370	1
11ac40MIMO	5510	Type6	24	1	333.3	9	0.3333	300	5653	1
11ac40MIMO	5510	Type6	24	1	333.3	9	0.3333	300	5331	1



Unless otherwise agreed in writing, this document is issued by the Company subject to its General Conditions of Service printed overleaf, available on request or accessible at <http://www.sgs.com/en/Terms-and-Conditions.aspx> and, for electronic format documents, subject to Terms and Conditions for Electronic Documents at <http://www.sgs.com/en/Terms-and-Conditions/Terms-e-Document.aspx>. Attention is drawn to the limitation of liability, indemnification and jurisdiction issues defined therein. Any holder of this document is advised that information contained herein reflects the Company's findings at the time of its intervention only and within the limits of Client's instructions, if any. The Company's sole responsibility is to its Client and this document does not exonerate parties to a transaction from exercising all their rights and obligations under the transaction documents. This document cannot be reproduced except in full, without prior written approval of the Company. Any unauthorized alteration, forgery or falsification of the content or appearance of this document is unlawful and offenders may be prosecuted to the fullest extent of the law. Unless otherwise stated the results shown in this test report refer only to the sample(s) tested and such sample(s) are retained for 30 days only.

Attention: To check the authenticity of testing/inspection report & certificate, please contact us at telephone: (86-755) 8307 1443, or email: [CN.Doccheck@sgs.com](mailto:CN.Doccheck@sgs.com)

SGS-CSTC Standards Technical Services (Xi'an) Co., Ltd. | 1/E Unit D, Building 1, Kanglong Orange Science Park, No.137, Keyuan 3rd Road, Fengyang New Town, Xi'an, Shaanxi, China | 710086 | T (86-29) 6282 7885 | [www.sgs.com](http://www.sgs.com)  
 中国·西安·沣东新城科里三路137号康隆橙方科技园1号楼D单元1层 | 邮编: 710086 | T (86-29) 6282 7885 | [sgs.china@sgs.com](mailto:sgs.china@sgs.com)



Report No.: XEWA2310000070RG05

Rev.: 01

Page: 235 of 267

11ac40MIMO	5510	Type6	24	1	333.3	9	0.3333	300	5600	1
11ac40MIMO	5510	Type6	24	1	333.3	9	0.3333	300	5270	1
11ac40MIMO	5510	Type6	24	1	333.3	9	0.3333	300	5639	1
11ac40MIMO	5510	Type6	24	1	333.3	9	0.3333	300	5612	1
11ac40MIMO	5510	Type6	24	1	333.3	9	0.3333	300	5515	1
11ac40MIMO	5510	Type6	24	1	333.3	9	0.3333	300	5376	1
11ac40MIMO	5510	Type6	24	1	333.3	9	0.3333	300	5667	1
11ac40MIMO	5510	Type6	24	1	333.3	9	0.3333	300	5269	1
11ac40MIMO	5510	Type6	24	1	333.3	9	0.3333	300	5252	1
11ac40MIMO	5510	Type6	24	1	333.3	9	0.3333	300	5677	1
11ac40MIMO	5510	Type6	24	1	333.3	9	0.3333	300	5586	1
11ac40MIMO	5510	Type6	24	1	333.3	9	0.3333	300	5642	1
11ac40MIMO	5510	Type6	24	1	333.3	9	0.3333	300	5258	1
11ac40MIMO	5510	Type6	24	1	333.3	9	0.3333	300	5636	1
11ac40MIMO	5510	Type6	24	1	333.3	9	0.3333	300	5543	1
11ac40MIMO	5510	Type6	24	1	333.3	9	0.3333	300	5458	1
11ac40MIMO	5510	Type6	24	1	333.3	9	0.3333	300	5479	1
11ac40MIMO	5510	Type6	24	1	333.3	9	0.3333	300	5623	1
11ac40MIMO	5510	Type6	24	1	333.3	9	0.3333	300	5400	1
11ac40MIMO	5510	Type6	24	1	333.3	9	0.3333	300	5444	1
11ac40MIMO	5510	Type6	24	1	333.3	9	0.3333	300	5301	1
11ac40MIMO	5510	Type6	24	1	333.3	9	0.3333	300	5372	1
11ac40MIMO	5510	Type6	24	1	333.3	9	0.3333	300	5428	1
11ac40MIMO	5510	Type6	24	1	333.3	9	0.3333	300	5341	1
11ac40MIMO	5510	Type6	24	1	333.3	9	0.3333	300	5575	1
11ac40MIMO	5510	Type6	24	1	333.3	9	0.3333	300	5290	1
11ac40MIMO	5510	Type6	24	1	333.3	9	0.3333	300	5316	1
11ac40MIMO	5510	Type6	24	1	333.3	9	0.3333	300	5345	1
11ac40MIMO	5510	Type6	24	1	333.3	9	0.3333	300	5347	1
11ac40MIMO	5510	Type6	24	1	333.3	9	0.3333	300	5627	1
11ac40MIMO	5510	Type6	24	1	333.3	9	0.3333	300	5349	1
11ac40MIMO	5510	Type6	24	1	333.3	9	0.3333	300	5470	1
11ac40MIMO	5510	Type6	24	1	333.3	9	0.3333	300	5565	1
11ac40MIMO	5510	Type6	24	1	333.3	9	0.3333	300	5432	1
11ac40MIMO	5510	Type6	24	1	333.3	9	0.3333	300	5628	1
11ac40MIMO	5510	Type6	24	1	333.3	9	0.3333	300	5676	1
11ac40MIMO	5510	Type6	24	1	333.3	9	0.3333	300	5447	1
11ac40MIMO	5510	Type6	24	1	333.3	9	0.3333	300	5672	1
11ac40MIMO	5510	Type6	24	1	333.3	9	0.3333	300	5552	1
11ac40MIMO	5510	Type6	24	1	333.3	9	0.3333	300	5468	1
11ac40MIMO	5510	Type6	24	1	333.3	9	0.3333	300	5469	1
11ac40MIMO	5510	Type6	24	1	333.3	9	0.3333	300	5359	1
11ac40MIMO	5510	Type6	24	1	333.3	9	0.3333	300	5321	1
11ac40MIMO	5510	Type6	24	1	333.3	9	0.3333	300	5325	1
11ac40MIMO	5510	Type6	24	1	333.3	9	0.3333	300	5678	1
11ac20MIMO	5500	Type6	24	1	333.3	9	0.3333	300	5299	1
11ac20MIMO	5500	Type6	24	1	333.3	9	0.3333	300	5472	1
11ac20MIMO	5500	Type6	24	1	333.3	9	0.3333	300	5698	1
11ac20MIMO	5500	Type6	24	1	333.3	9	0.3333	300	5381	1
11ac20MIMO	5500	Type6	24	1	333.3	9	0.3333	300	5721	1
11ac20MIMO	5500	Type6	24	1	333.3	9	0.3333	300	5477	1
11ac20MIMO	5500	Type6	24	1	333.3	9	0.3333	300	5574	1
11ac20MIMO	5500	Type6	24	1	333.3	9	0.3333	300	5535	1



Unless otherwise agreed in writing, this document is issued by the Company subject to its General Conditions of Service printed overleaf, available on request or accessible at <http://www.sgs.com/en/Terms-and-Conditions.aspx> and, for electronic format documents, subject to Terms and Conditions for Electronic Documents at <http://www.sgs.com/en/Terms-and-Conditions/Terms-e-Documents.aspx>. Attention is drawn to the limitation of liability, indemnification and jurisdiction issues defined therein. Any holder of this document is advised that information contained herein reflects the Company's findings at the time of its intervention only and within the limits of Client's instructions, if any. The Company's sole responsibility is to its Client and this document does not exonerate parties to a transaction from exercising all their rights and obligations under the transaction documents. This document cannot be reproduced except in full, without prior written approval of the Company. Any unauthorized alteration, forgery or falsification of the content or appearance of this document is unlawful and offenders may be prosecuted to the fullest extent of the law. Unless otherwise stated the results shown in this test report refer only to the sample(s) tested and such sample(s) are retained for 30 days only.

Attention: To check the authenticity of testing/inspection report & certificate, please contact us at telephone: (86-755) 8307 1443, or email: [CN.Doccheck@sgs.com](mailto:CN.Doccheck@sgs.com)  
 (E) Unit D, Building 1, Kanglong Orange Science Park, No.157, Keyuan 3rd Road, Fengfeng New Town, Xian, Shaanxi, China 710086  
 t (86-29) 6282 7885 www.sgs.com.cn  
 中国·西安·沣东新城科里三路157号康隆橙方科技园1号楼D单元1层 邮编: 710086 t (86-29) 6282 7885 sgs.china@sgs.com



Report No.: XEWA2310000070RG05

Rev.: 01

Page: 236 of 267

11ac20MIMO	5500	Type6	24	1	333.3	9	0.3333	300	5508	1
11ac20MIMO	5500	Type6	24	1	333.3	9	0.3333	300	5614	1
11ac20MIMO	5500	Type6	24	1	333.3	9	0.3333	300	5668	1
11ac20MIMO	5500	Type6	24	1	333.3	9	0.3333	300	5582	1
11ac20MIMO	5500	Type6	24	1	333.3	9	0.3333	300	5617	1
11ac20MIMO	5500	Type6	24	1	333.3	9	0.3333	300	5367	1
11ac20MIMO	5500	Type6	24	1	333.3	9	0.3333	300	5251	1
11ac20MIMO	5500	Type6	24	1	333.3	9	0.3333	300	5351	1
11ac20MIMO	5500	Type6	24	1	333.3	9	0.3333	300	5383	1
11ac20MIMO	5500	Type6	24	1	333.3	9	0.3333	300	5505	1
11ac20MIMO	5500	Type6	24	1	333.3	9	0.3333	300	5604	1
11ac20MIMO	5500	Type6	24	1	333.3	9	0.3333	300	5527	1
11ac20MIMO	5500	Type6	24	1	333.3	9	0.3333	300	5660	1
11ac20MIMO	5500	Type6	24	1	333.3	9	0.3333	300	5647	1
11ac20MIMO	5500	Type6	24	1	333.3	9	0.3333	300	5328	1
11ac20MIMO	5500	Type6	24	1	333.3	9	0.3333	300	5335	1
11ac20MIMO	5500	Type6	24	1	333.3	9	0.3333	300	5549	1
11ac20MIMO	5500	Type6	24	1	333.3	9	0.3333	300	5590	1
11ac20MIMO	5500	Type6	24	1	333.3	9	0.3333	300	5488	1
11ac20MIMO	5500	Type6	24	1	333.3	9	0.3333	300	5700	1
11ac20MIMO	5500	Type6	24	1	333.3	9	0.3333	300	5403	1
11ac20MIMO	5500	Type6	24	1	333.3	9	0.3333	300	5414	1
11ac20MIMO	5500	Type6	24	1	333.3	9	0.3333	300	5588	1
11ac20MIMO	5500	Type6	24	1	333.3	9	0.3333	300	5389	1
11ac20MIMO	5500	Type6	24	1	333.3	9	0.3333	300	5703	1
11ac20MIMO	5500	Type6	24	1	333.3	9	0.3333	300	5309	1
11ac20MIMO	5500	Type6	24	1	333.3	9	0.3333	300	5571	1
11ac20MIMO	5500	Type6	24	1	333.3	9	0.3333	300	5364	1
11ac20MIMO	5500	Type6	24	1	333.3	9	0.3333	300	5503	1
11ac20MIMO	5500	Type6	24	1	333.3	9	0.3333	300	5274	1
11ac20MIMO	5500	Type6	24	1	333.3	9	0.3333	300	5666	1
11ac20MIMO	5500	Type6	24	1	333.3	9	0.3333	300	5365	1
11ac20MIMO	5500	Type6	24	1	333.3	9	0.3333	300	5261	1
11ac20MIMO	5500	Type6	24	1	333.3	9	0.3333	300	5417	1
11ac20MIMO	5500	Type6	24	1	333.3	9	0.3333	300	5517	1
11ac20MIMO	5500	Type6	24	1	333.3	9	0.3333	300	5405	1
11ac20MIMO	5500	Type6	24	1	333.3	9	0.3333	300	5448	1
11ac20MIMO	5500	Type6	24	1	333.3	9	0.3333	300	5382	1
11ac20MIMO	5500	Type6	24	1	333.3	9	0.3333	300	5528	1
11ac20MIMO	5500	Type6	24	1	333.3	9	0.3333	300	5687	1
11ac20MIMO	5500	Type6	24	1	333.3	9	0.3333	300	5695	1
11ac20MIMO	5500	Type6	24	1	333.3	9	0.3333	300	5537	1
11ac20MIMO	5500	Type6	24	1	333.3	9	0.3333	300	5717	1
11ac20MIMO	5500	Type6	24	1	333.3	9	0.3333	300	5393	1
11ac20MIMO	5500	Type6	24	1	333.3	9	0.3333	300	5370	1
11ac20MIMO	5500	Type6	24	1	333.3	9	0.3333	300	5653	1
11ac20MIMO	5500	Type6	24	1	333.3	9	0.3333	300	5331	1
11ac20MIMO	5500	Type6	24	1	333.3	9	0.3333	300	5600	1
11ac20MIMO	5500	Type6	24	1	333.3	9	0.3333	300	5270	1
11ac20MIMO	5500	Type6	24	1	333.3	9	0.3333	300	5639	1
11ac20MIMO	5500	Type6	24	1	333.3	9	0.3333	300	5612	1
11ac20MIMO	5500	Type6	24	1	333.3	9	0.3333	300	5515	1
11ac20MIMO	5500	Type6	24	1	333.3	9	0.3333	300	5376	1



Unless otherwise agreed in writing, this document is issued by the Company subject to its General Conditions of Service printed overleaf, available on request or accessible at <http://www.sgs.com/en/Terms-and-Conditions.aspx> and, for electronic format documents, subject to Terms and Conditions for Electronic Documents at <http://www.sgs.com/en/Terms-and-Conditions/Terms-e-Document.aspx>. Attention is drawn to the limitation of liability, indemnification and jurisdiction issues defined therein. Any holder of this document is advised that information contained herein reflects the Company's findings at the time of its intervention only and within the limits of Client's instructions, if any. The Company's sole responsibility is to its Client and this document does not exonerate parties to a transaction from exercising all their rights and obligations under the transaction documents. This document cannot be reproduced except in full, without prior written approval of the Company. Any unauthorized alteration, forgery or falsification of the content or appearance of this document is unlawful and offenders may be prosecuted to the fullest extent of the law. Unless otherwise stated the results shown in this test report refer only to the sample(s) tested and such sample(s) are retained for 30 days only.

Attention: To check the authenticity of testing/inspection report & certificate, please contact us at telephone: (86-755) 8307 1443, or email: [CN.Doccheck@sgs.com](mailto:CN.Doccheck@sgs.com)  
 (U) Ltd D Building 1, Kanglong Orange Science Park, No.157, Keyuan 3rd Road, Fengfeng New Town, Xian, Shaanxi, China 710086  
 t (86-29) 6282 7885 www.sgs.com.cn  
 中国·西安·沣东新城科里三路157号康鸿橙方科技园1号楼D单元1层 邮编: 710086 t (86-29) 6282 7885 sgs.china@sgs.com

Report No.: XEWA2310000070RG05

Rev.: 01

Page: 237 of 267

11ac20MIMO	5500	Type6	24	1	333.3	9	0.3333	300	5667	1
11ac20MIMO	5500	Type6	24	1	333.3	9	0.3333	300	5269	1
11ac20MIMO	5500	Type6	24	1	333.3	9	0.3333	300	5252	1
11ac20MIMO	5500	Type6	24	1	333.3	9	0.3333	300	5677	1
11ac20MIMO	5500	Type6	24	1	333.3	9	0.3333	300	5586	1
11ac20MIMO	5500	Type6	24	1	333.3	9	0.3333	300	5642	1
11ac20MIMO	5500	Type6	24	1	333.3	9	0.3333	300	5258	1
11ac20MIMO	5500	Type6	24	1	333.3	9	0.3333	300	5636	1
11ac20MIMO	5500	Type6	24	1	333.3	9	0.3333	300	5543	1
11ac20MIMO	5500	Type6	24	1	333.3	9	0.3333	300	5458	1
11ac20MIMO	5500	Type6	24	1	333.3	9	0.3333	300	5479	1
11ac20MIMO	5500	Type6	24	1	333.3	9	0.3333	300	5623	1
11ac20MIMO	5500	Type6	24	1	333.3	9	0.3333	300	5400	1
11ac20MIMO	5500	Type6	24	1	333.3	9	0.3333	300	5444	1
11ac20MIMO	5500	Type6	24	1	333.3	9	0.3333	300	5301	1
11ac20MIMO	5500	Type6	24	1	333.3	9	0.3333	300	5372	1
11ac20MIMO	5500	Type6	24	1	333.3	9	0.3333	300	5428	1
11ac20MIMO	5500	Type6	24	1	333.3	9	0.3333	300	5341	1
11ac20MIMO	5500	Type6	24	1	333.3	9	0.3333	300	5575	1
11ac20MIMO	5500	Type6	24	1	333.3	9	0.3333	300	5290	1
11ac20MIMO	5500	Type6	24	1	333.3	9	0.3333	300	5316	1
11ac20MIMO	5500	Type6	24	1	333.3	9	0.3333	300	5345	1
11ac20MIMO	5500	Type6	24	1	333.3	9	0.3333	300	5347	1
11ac20MIMO	5500	Type6	24	1	333.3	9	0.3333	300	5627	1
11ac20MIMO	5500	Type6	24	1	333.3	9	0.3333	300	5349	1
11ac20MIMO	5500	Type6	24	1	333.3	9	0.3333	300	5470	1
11ac20MIMO	5500	Type6	24	1	333.3	9	0.3333	300	5565	1
11ac20MIMO	5500	Type6	24	1	333.3	9	0.3333	300	5432	1
11ac20MIMO	5500	Type6	24	1	333.3	9	0.3333	300	5628	1
11ac20MIMO	5500	Type6	24	1	333.3	9	0.3333	300	5676	1
11ac20MIMO	5500	Type6	24	1	333.3	9	0.3333	300	5447	1
11ac20MIMO	5500	Type6	24	1	333.3	9	0.3333	300	5672	1
11ac20MIMO	5500	Type6	24	1	333.3	9	0.3333	300	5552	1
11ac20MIMO	5500	Type6	24	1	333.3	9	0.3333	300	5468	1
11ac20MIMO	5500	Type6	24	1	333.3	9	0.3333	300	5469	1
11ac20MIMO	5500	Type6	24	1	333.3	9	0.3333	300	5359	1
11ac20MIMO	5500	Type6	24	1	333.3	9	0.3333	300	5321	1
11ac20MIMO	5500	Type6	24	1	333.3	9	0.3333	300	5325	1
11ac20MIMO	5500	Type6	24	1	333.3	9	0.3333	300	5678	1



Unless otherwise agreed in writing, this document is issued by the Company subject to its General Conditions of Service printed overleaf, available on request or accessible at <http://www.sgs.com/en/Terms-and-Conditions.aspx> and, for electronic format documents, subject to Terms and Conditions for Electronic Documents at <http://www.sgs.com/en/Terms-and-Conditions/Terms-e-Documents.aspx>. Attention is drawn to the limitation of liability, indemnification and jurisdiction issues defined therein. Any holder of this document is advised that information contained herein reflects the Company's findings at the time of its intervention only and within the limits of Client's instructions, if any. The Company's sole responsibility is to its Client and this document does not exonerate parties to a transaction from exercising all their rights and obligations under the transaction documents. This document cannot be reproduced except in full, without prior written approval of the Company. Any unauthorized alteration, forgery or falsification of the content or appearance of this document is unlawful and offenders may be prosecuted to the fullest extent of the law. Unless otherwise stated the results shown in this test report refer only to the sample(s) tested and such sample(s) are retained for 30 days only.

Attention: To check the authenticity of testing/inspection report & certificate, please contact us at telephone: (86-755) 4307 1443, or email: [CN.Doccheck@sgs.com](mailto:CN.Doccheck@sgs.com)  
 (SGS-CSTC) Standards Technical Services (Xi'an) Co., Ltd. | 1/E Unit D Building 1, Kanghong Orange Source Park, No.137, Kejian 3rd Road, Fengling New Town, Xi'an, Shaanxi, China | 710086 | t (86-29) 6282 7885 | www.sgs.com.cn  
 中国·西安·沣东新城科里三路137号康鸿橙方科技园1号楼D单元1层 | 邮编: 710086 | t (86-29) 6282 7885 | sgs.china@sgs.com

TestMode	Channel	Radar Type	Trial ID	Pulse width (μs)	PRI (μs)	Pulses per Hop	Hop Rate (kHz)	Hop Sequence Length(ms)	Center Frequency (MHz)	Detection (1: Yes; 0: No)
11ac80MIMO	5530	Type6	25	1	333.3	9	0.3333	300	5457	1
11ac80MIMO	5530	Type6	25	1	333.3	9	0.3333	300	5711	1
11ac80MIMO	5530	Type6	25	1	333.3	9	0.3333	300	5634	1
11ac80MIMO	5530	Type6	25	1	333.3	9	0.3333	300	5542	1
11ac80MIMO	5530	Type6	25	1	333.3	9	0.3333	300	5563	1
11ac80MIMO	5530	Type6	25	1	333.3	9	0.3333	300	5616	1
11ac80MIMO	5530	Type6	25	1	333.3	9	0.3333	300	5596	1
11ac80MIMO	5530	Type6	25	1	333.3	9	0.3333	300	5610	1
11ac80MIMO	5530	Type6	25	1	333.3	9	0.3333	300	5671	1
11ac80MIMO	5530	Type6	25	1	333.3	9	0.3333	300	5346	1
11ac80MIMO	5530	Type6	25	1	333.3	9	0.3333	300	5599	1
11ac80MIMO	5530	Type6	25	1	333.3	9	0.3333	300	5371	1
11ac80MIMO	5530	Type6	25	1	333.3	9	0.3333	300	5658	1
11ac80MIMO	5530	Type6	25	1	333.3	9	0.3333	300	5562	1
11ac80MIMO	5530	Type6	25	1	333.3	9	0.3333	300	5638	1
11ac80MIMO	5530	Type6	25	1	333.3	9	0.3333	300	5339	1
11ac80MIMO	5530	Type6	25	1	333.3	9	0.3333	300	5381	1
11ac80MIMO	5530	Type6	25	1	333.3	9	0.3333	300	5486	1
11ac80MIMO	5530	Type6	25	1	333.3	9	0.3333	300	5453	1
11ac80MIMO	5530	Type6	25	1	333.3	9	0.3333	300	5321	1
11ac80MIMO	5530	Type6	25	1	333.3	9	0.3333	300	5535	1
11ac80MIMO	5530	Type6	25	1	333.3	9	0.3333	300	5351	1
11ac80MIMO	5530	Type6	25	1	333.3	9	0.3333	300	5588	1
11ac80MIMO	5530	Type6	25	1	333.3	9	0.3333	300	5417	1
11ac80MIMO	5530	Type6	25	1	333.3	9	0.3333	300	5308	1
11ac80MIMO	5530	Type6	25	1	333.3	9	0.3333	300	5586	1
11ac80MIMO	5530	Type6	25	1	333.3	9	0.3333	300	5498	1
11ac80MIMO	5530	Type6	25	1	333.3	9	0.3333	300	5318	1
11ac80MIMO	5530	Type6	25	1	333.3	9	0.3333	300	5289	1
11ac80MIMO	5530	Type6	25	1	333.3	9	0.3333	300	5522	1
11ac80MIMO	5530	Type6	25	1	333.3	9	0.3333	300	5364	1
11ac80MIMO	5530	Type6	25	1	333.3	9	0.3333	300	5292	1
11ac80MIMO	5530	Type6	25	1	333.3	9	0.3333	300	5706	1
11ac80MIMO	5530	Type6	25	1	333.3	9	0.3333	300	5426	1
11ac80MIMO	5530	Type6	25	1	333.3	9	0.3333	300	5448	1
11ac80MIMO	5530	Type6	25	1	333.3	9	0.3333	300	5662	1
11ac80MIMO	5530	Type6	25	1	333.3	9	0.3333	300	5257	1
11ac80MIMO	5530	Type6	25	1	333.3	9	0.3333	300	5656	1
11ac80MIMO	5530	Type6	25	1	333.3	9	0.3333	300	5663	1
11ac80MIMO	5530	Type6	25	1	333.3	9	0.3333	300	5505	1
11ac80MIMO	5530	Type6	25	1	333.3	9	0.3333	300	5674	1
11ac80MIMO	5530	Type6	25	1	333.3	9	0.3333	300	5657	1
11ac80MIMO	5530	Type6	25	1	333.3	9	0.3333	300	5514	1
11ac80MIMO	5530	Type6	25	1	333.3	9	0.3333	300	5334	1
11ac80MIMO	5530	Type6	25	1	333.3	9	0.3333	300	5428	1
11ac80MIMO	5530	Type6	25	1	333.3	9	0.3333	300	5465	1
11ac80MIMO	5530	Type6	25	1	333.3	9	0.3333	300	5489	1
11ac80MIMO	5530	Type6	25	1	333.3	9	0.3333	300	5265	1



Unless otherwise agreed in writing, this document is issued by the Company subject to its General Conditions of Service printed overleaf, available on request or accessible at <http://www.sgs.com/en/Terms-and-Conditions.aspx> and, for electronic format documents, subject to Terms and Conditions for Electronic Documents at <http://www.sgs.com/en/Terms-and-Conditions/Terms-e-Documents.aspx>. Attention is drawn to the limitation of liability, indemnification and jurisdiction issues defined therein. Any holder of this document is advised that information contained herein reflects the Company's findings at the time of its intervention only and within the limits of Client's instructions, if any. The Company's sole responsibility is to its Client and this document does not exonerate parties to a transaction from exercising all their rights and obligations under the transaction documents. This document cannot be reproduced except in full, without prior written approval of the Company. Any unauthorized alteration, forgery or falsification of the content or appearance of this document is unlawful and offenders may be prosecuted to the fullest extent of the law. Unless otherwise stated the results shown in this test report refer only to the sample(s) tested and such sample(s) are retained for 30 days only.

Attention: To check the authenticity of testing/inspection report & certificate, please contact us at telephone: (86-755) 8307 1443, or email: [CN.Doccheck@sgs.com](mailto:CN.Doccheck@sgs.com)  
 S/E Unit D, Building 1, Kanglong Orange Science Park, No.157, Keyuan 3rd Road, Fengjing/Yue Tian, Xian, Shaanxi, China 710086  
 中国·西安·沣东新城科里三路157号康隆橙方科技园1号楼D单元1层 邮编: 710086  
 t (86-29) 6282 7885 www.sgs.com.cn  
 t (86-29) 6282 7885 sgs.china@sgs.com

11ac80MIMO	5530	Type6	25	1	333.3	9	0.3333	300	5437	1
11ac80MIMO	5530	Type6	25	1	333.3	9	0.3333	300	5404	1
11ac80MIMO	5530	Type6	25	1	333.3	9	0.3333	300	5396	1
11ac80MIMO	5530	Type6	25	1	333.3	9	0.3333	300	5373	1
11ac80MIMO	5530	Type6	25	1	333.3	9	0.3333	300	5564	1
11ac80MIMO	5530	Type6	25	1	333.3	9	0.3333	300	5581	1
11ac80MIMO	5530	Type6	25	1	333.3	9	0.3333	300	5324	1
11ac80MIMO	5530	Type6	25	1	333.3	9	0.3333	300	5368	1
11ac80MIMO	5530	Type6	25	1	333.3	9	0.3333	300	5625	1
11ac80MIMO	5530	Type6	25	1	333.3	9	0.3333	300	5571	1
11ac80MIMO	5530	Type6	25	1	333.3	9	0.3333	300	5399	1
11ac80MIMO	5530	Type6	25	1	333.3	9	0.3333	300	5329	1
11ac80MIMO	5530	Type6	25	1	333.3	9	0.3333	300	5557	1
11ac80MIMO	5530	Type6	25	1	333.3	9	0.3333	300	5347	1
11ac80MIMO	5530	Type6	25	1	333.3	9	0.3333	300	5677	1
11ac80MIMO	5530	Type6	25	1	333.3	9	0.3333	300	5271	1
11ac80MIMO	5530	Type6	25	1	333.3	9	0.3333	300	5462	1
11ac80MIMO	5530	Type6	25	1	333.3	9	0.3333	300	5541	1
11ac80MIMO	5530	Type6	25	1	333.3	9	0.3333	300	5576	1
11ac80MIMO	5530	Type6	25	1	333.3	9	0.3333	300	5383	1
11ac80MIMO	5530	Type6	25	1	333.3	9	0.3333	300	5280	1
11ac80MIMO	5530	Type6	25	1	333.3	9	0.3333	300	5250	1
11ac80MIMO	5530	Type6	25	1	333.3	9	0.3333	300	5261	1
11ac80MIMO	5530	Type6	25	1	333.3	9	0.3333	300	5485	1
11ac80MIMO	5530	Type6	25	1	333.3	9	0.3333	300	5519	1
11ac80MIMO	5530	Type6	25	1	333.3	9	0.3333	300	5502	1
11ac80MIMO	5530	Type6	25	1	333.3	9	0.3333	300	5578	1
11ac80MIMO	5530	Type6	25	1	333.3	9	0.3333	300	5525	1
11ac80MIMO	5530	Type6	25	1	333.3	9	0.3333	300	5604	1
11ac80MIMO	5530	Type6	25	1	333.3	9	0.3333	300	5652	1
11ac80MIMO	5530	Type6	25	1	333.3	9	0.3333	300	5613	1
11ac80MIMO	5530	Type6	25	1	333.3	9	0.3333	300	5700	1
11ac80MIMO	5530	Type6	25	1	333.3	9	0.3333	300	5435	1
11ac80MIMO	5530	Type6	25	1	333.3	9	0.3333	300	5400	1
11ac80MIMO	5530	Type6	25	1	333.3	9	0.3333	300	5609	1
11ac80MIMO	5530	Type6	25	1	333.3	9	0.3333	300	5331	1
11ac80MIMO	5530	Type6	25	1	333.3	9	0.3333	300	5635	1
11ac80MIMO	5530	Type6	25	1	333.3	9	0.3333	300	5385	1
11ac80MIMO	5530	Type6	25	1	333.3	9	0.3333	300	5281	1
11ac80MIMO	5530	Type6	25	1	333.3	9	0.3333	300	5299	1
11ac80MIMO	5530	Type6	25	1	333.3	9	0.3333	300	5595	1
11ac80MIMO	5530	Type6	25	1	333.3	9	0.3333	300	5350	1
11ac80MIMO	5530	Type6	25	1	333.3	9	0.3333	300	5382	1
11ac80MIMO	5530	Type6	25	1	333.3	9	0.3333	300	5407	1
11ac80MIMO	5530	Type6	25	1	333.3	9	0.3333	300	5695	1
11ac80MIMO	5530	Type6	25	1	333.3	9	0.3333	300	5546	1
11ac80MIMO	5530	Type6	25	1	333.3	9	0.3333	300	5683	1
11ac80MIMO	5530	Type6	25	1	333.3	9	0.3333	300	5607	1
11ac80MIMO	5530	Type6	25	1	333.3	9	0.3333	300	5263	1
11ac80MIMO	5530	Type6	25	1	333.3	9	0.3333	300	5655	1
11ac80MIMO	5530	Type6	25	1	333.3	9	0.3333	300	5550	1
11ac80MIMO	5530	Type6	25	1	333.3	9	0.3333	300	5459	1
11ac40MIMO	5510	Type6	25	1	333.3	9	0.3333	300	5457	1



Unless otherwise agreed in writing, this document is issued by the Company subject to its General Conditions of Service printed overleaf, available on request or accessible at <http://www.sgs.com/en/Terms-and-Conditions.aspx> and, for electronic format documents, subject to Terms and Conditions for Electronic Documents at <http://www.sgs.com/en/Terms-and-Conditions/Terms-e-Documents.aspx>. Attention is drawn to the limitation of liability, indemnification and jurisdiction issues defined therein. Any holder of this document is advised that information contained herein reflects the Company's findings at the time of its intervention only and within the limits of Client's instructions, if any. The Company's sole responsibility is to its Client and this document does not exonerate parties to a transaction from exercising all their rights and obligations under the transaction documents. This document cannot be reproduced except in full, without prior written approval of the Company. Any unauthorized alteration, forgery or falsification of the content or appearance of this document is unlawful and offenders may be prosecuted to the fullest extent of the law. Unless otherwise stated the results shown in this test report refer only to the sample(s) tested and such sample(s) are retained for 30 days only.

Attention: To check the authenticity of testing/inspection report & certificate, please contact us at telephone: (86-755) 8307 1443, or email: [CN.Doccheck@sgs.com](mailto:CN.Doccheck@sgs.com)

SGS-CSTC Standards Technical Services (Xi'an) Co., Ltd. | 1/F Unit D, Building 1, Kanglong Orange Science Park, No.157, Keyuan 3rd Road, Fengyang New Town, Xian, Shaanxi, China | 710086 | T (86-29) 6282 7885 | [www.sgs.com](http://www.sgs.com)  
 中国·西安·沣东新城科里三路157号康隆橙方科技园1号楼D单元1层 | 邮编: 710086 | T (86-29) 6282 7885 | [sgs.china@sgs.com](mailto:sgs.china@sgs.com)

11ac40MIMO	5510	Type6	25	1	333.3	9	0.3333	300	5711	1
11ac40MIMO	5510	Type6	25	1	333.3	9	0.3333	300	5634	1
11ac40MIMO	5510	Type6	25	1	333.3	9	0.3333	300	5542	1
11ac40MIMO	5510	Type6	25	1	333.3	9	0.3333	300	5563	1
11ac40MIMO	5510	Type6	25	1	333.3	9	0.3333	300	5616	1
11ac40MIMO	5510	Type6	25	1	333.3	9	0.3333	300	5596	1
11ac40MIMO	5510	Type6	25	1	333.3	9	0.3333	300	5610	1
11ac40MIMO	5510	Type6	25	1	333.3	9	0.3333	300	5671	1
11ac40MIMO	5510	Type6	25	1	333.3	9	0.3333	300	5346	1
11ac40MIMO	5510	Type6	25	1	333.3	9	0.3333	300	5599	1
11ac40MIMO	5510	Type6	25	1	333.3	9	0.3333	300	5371	1
11ac40MIMO	5510	Type6	25	1	333.3	9	0.3333	300	5658	1
11ac40MIMO	5510	Type6	25	1	333.3	9	0.3333	300	5562	1
11ac40MIMO	5510	Type6	25	1	333.3	9	0.3333	300	5638	1
11ac40MIMO	5510	Type6	25	1	333.3	9	0.3333	300	5339	1
11ac40MIMO	5510	Type6	25	1	333.3	9	0.3333	300	5381	1
11ac40MIMO	5510	Type6	25	1	333.3	9	0.3333	300	5486	1
11ac40MIMO	5510	Type6	25	1	333.3	9	0.3333	300	5453	1
11ac40MIMO	5510	Type6	25	1	333.3	9	0.3333	300	5321	1
11ac40MIMO	5510	Type6	25	1	333.3	9	0.3333	300	5535	1
11ac40MIMO	5510	Type6	25	1	333.3	9	0.3333	300	5351	1
11ac40MIMO	5510	Type6	25	1	333.3	9	0.3333	300	5588	1
11ac40MIMO	5510	Type6	25	1	333.3	9	0.3333	300	5417	1
11ac40MIMO	5510	Type6	25	1	333.3	9	0.3333	300	5308	1
11ac40MIMO	5510	Type6	25	1	333.3	9	0.3333	300	5586	1
11ac40MIMO	5510	Type6	25	1	333.3	9	0.3333	300	5498	1
11ac40MIMO	5510	Type6	25	1	333.3	9	0.3333	300	5318	1
11ac40MIMO	5510	Type6	25	1	333.3	9	0.3333	300	5289	1
11ac40MIMO	5510	Type6	25	1	333.3	9	0.3333	300	5522	1
11ac40MIMO	5510	Type6	25	1	333.3	9	0.3333	300	5364	1
11ac40MIMO	5510	Type6	25	1	333.3	9	0.3333	300	5292	1
11ac40MIMO	5510	Type6	25	1	333.3	9	0.3333	300	5706	1
11ac40MIMO	5510	Type6	25	1	333.3	9	0.3333	300	5426	1
11ac40MIMO	5510	Type6	25	1	333.3	9	0.3333	300	5448	1
11ac40MIMO	5510	Type6	25	1	333.3	9	0.3333	300	5662	1
11ac40MIMO	5510	Type6	25	1	333.3	9	0.3333	300	5257	1
11ac40MIMO	5510	Type6	25	1	333.3	9	0.3333	300	5656	1
11ac40MIMO	5510	Type6	25	1	333.3	9	0.3333	300	5663	1
11ac40MIMO	5510	Type6	25	1	333.3	9	0.3333	300	5505	1
11ac40MIMO	5510	Type6	25	1	333.3	9	0.3333	300	5674	1
11ac40MIMO	5510	Type6	25	1	333.3	9	0.3333	300	5657	1
11ac40MIMO	5510	Type6	25	1	333.3	9	0.3333	300	5514	1
11ac40MIMO	5510	Type6	25	1	333.3	9	0.3333	300	5334	1
11ac40MIMO	5510	Type6	25	1	333.3	9	0.3333	300	5428	1
11ac40MIMO	5510	Type6	25	1	333.3	9	0.3333	300	5465	1
11ac40MIMO	5510	Type6	25	1	333.3	9	0.3333	300	5489	1
11ac40MIMO	5510	Type6	25	1	333.3	9	0.3333	300	5265	1
11ac40MIMO	5510	Type6	25	1	333.3	9	0.3333	300	5437	1
11ac40MIMO	5510	Type6	25	1	333.3	9	0.3333	300	5404	1
11ac40MIMO	5510	Type6	25	1	333.3	9	0.3333	300	5396	1
11ac40MIMO	5510	Type6	25	1	333.3	9	0.3333	300	5373	1
11ac40MIMO	5510	Type6	25	1	333.3	9	0.3333	300	5564	1
11ac40MIMO	5510	Type6	25	1	333.3	9	0.3333	300	5581	1



Unless otherwise agreed in writing, this document is issued by the Company subject to its General Conditions of Service printed overleaf, available on request or accessible at <http://www.sgs.com/en/Terms-and-Conditions.aspx> and, for electronic format documents, subject to Terms and Conditions for Electronic Documents at <http://www.sgs.com/en/Terms-and-Conditions/Terms-e-Documents.aspx>. Attention is drawn to the limitation of liability, indemnification and jurisdiction issues defined therein. Any holder of this document is advised that information contained herein reflects the Company's findings at the time of its intervention only and within the limits of Client's instructions, if any. The Company's sole responsibility is to its Client and this document does not exonerate parties to a transaction from exercising all their rights and obligations under the transaction documents. This document cannot be reproduced except in full, without prior written approval of the Company. Any unauthorized alteration, forgery or falsification of the content or appearance of this document is unlawful and offenders may be prosecuted to the fullest extent of the law. Unless otherwise stated the results shown in this test report refer only to the sample(s) tested and such sample(s) are retained for 30 days only.

Attention: To check the authenticity of testing/inspection report & certificate, please contact us at telephone: (86-755) 8307 1443, or email: [CN.Doccheck@sgs.com](mailto:CN.Doccheck@sgs.com)

SGS-CSTC Standards Technical Services (Xi'an) Co., Ltd. | 1/E Unit D, Building 1, Kanglong Orange Science Park, No.137, Keyuan 3rd Road, Fengling New Town, Xi'an, Shaanxi, China | 710086 | t (86-29) 6282 7885 | [www.sgs.com](http://www.sgs.com)  
 中国·西安·沣东新城科里三路137号康隆橙方科技园1号楼D单元1层 | 邮编: 710086 | t (86-29) 6282 7885 | [sgs.china@sgs.com](mailto:sgs.china@sgs.com)



Report No.: XEWA2310000070RG05

Rev.: 01

Page: 241 of 267

11ac40MIMO	5510	Type6	25	1	333.3	9	0.3333	300	5324	1
11ac40MIMO	5510	Type6	25	1	333.3	9	0.3333	300	5368	1
11ac40MIMO	5510	Type6	25	1	333.3	9	0.3333	300	5625	1
11ac40MIMO	5510	Type6	25	1	333.3	9	0.3333	300	5571	1
11ac40MIMO	5510	Type6	25	1	333.3	9	0.3333	300	5399	1
11ac40MIMO	5510	Type6	25	1	333.3	9	0.3333	300	5329	1
11ac40MIMO	5510	Type6	25	1	333.3	9	0.3333	300	5557	1
11ac40MIMO	5510	Type6	25	1	333.3	9	0.3333	300	5347	1
11ac40MIMO	5510	Type6	25	1	333.3	9	0.3333	300	5677	1
11ac40MIMO	5510	Type6	25	1	333.3	9	0.3333	300	5271	1
11ac40MIMO	5510	Type6	25	1	333.3	9	0.3333	300	5462	1
11ac40MIMO	5510	Type6	25	1	333.3	9	0.3333	300	5541	1
11ac40MIMO	5510	Type6	25	1	333.3	9	0.3333	300	5576	1
11ac40MIMO	5510	Type6	25	1	333.3	9	0.3333	300	5383	1
11ac40MIMO	5510	Type6	25	1	333.3	9	0.3333	300	5280	1
11ac40MIMO	5510	Type6	25	1	333.3	9	0.3333	300	5250	1
11ac40MIMO	5510	Type6	25	1	333.3	9	0.3333	300	5261	1
11ac40MIMO	5510	Type6	25	1	333.3	9	0.3333	300	5485	1
11ac40MIMO	5510	Type6	25	1	333.3	9	0.3333	300	5519	1
11ac40MIMO	5510	Type6	25	1	333.3	9	0.3333	300	5502	1
11ac40MIMO	5510	Type6	25	1	333.3	9	0.3333	300	5578	1
11ac40MIMO	5510	Type6	25	1	333.3	9	0.3333	300	5525	1
11ac40MIMO	5510	Type6	25	1	333.3	9	0.3333	300	5604	1
11ac40MIMO	5510	Type6	25	1	333.3	9	0.3333	300	5652	1
11ac40MIMO	5510	Type6	25	1	333.3	9	0.3333	300	5613	1
11ac40MIMO	5510	Type6	25	1	333.3	9	0.3333	300	5700	1
11ac40MIMO	5510	Type6	25	1	333.3	9	0.3333	300	5435	1
11ac40MIMO	5510	Type6	25	1	333.3	9	0.3333	300	5400	1
11ac40MIMO	5510	Type6	25	1	333.3	9	0.3333	300	5609	1
11ac40MIMO	5510	Type6	25	1	333.3	9	0.3333	300	5331	1
11ac40MIMO	5510	Type6	25	1	333.3	9	0.3333	300	5635	1
11ac40MIMO	5510	Type6	25	1	333.3	9	0.3333	300	5385	1
11ac40MIMO	5510	Type6	25	1	333.3	9	0.3333	300	5281	1
11ac40MIMO	5510	Type6	25	1	333.3	9	0.3333	300	5299	1
11ac40MIMO	5510	Type6	25	1	333.3	9	0.3333	300	5595	1
11ac40MIMO	5510	Type6	25	1	333.3	9	0.3333	300	5350	1
11ac40MIMO	5510	Type6	25	1	333.3	9	0.3333	300	5382	1
11ac40MIMO	5510	Type6	25	1	333.3	9	0.3333	300	5407	1
11ac40MIMO	5510	Type6	25	1	333.3	9	0.3333	300	5695	1
11ac40MIMO	5510	Type6	25	1	333.3	9	0.3333	300	5546	1
11ac40MIMO	5510	Type6	25	1	333.3	9	0.3333	300	5683	1
11ac40MIMO	5510	Type6	25	1	333.3	9	0.3333	300	5607	1
11ac40MIMO	5510	Type6	25	1	333.3	9	0.3333	300	5263	1
11ac40MIMO	5510	Type6	25	1	333.3	9	0.3333	300	5655	1
11ac40MIMO	5510	Type6	25	1	333.3	9	0.3333	300	5550	1
11ac40MIMO	5510	Type6	25	1	333.3	9	0.3333	300	5459	1
11ac20MIMO	5500	Type6	25	1	333.3	9	0.3333	300	5457	1
11ac20MIMO	5500	Type6	25	1	333.3	9	0.3333	300	5711	1
11ac20MIMO	5500	Type6	25	1	333.3	9	0.3333	300	5634	1
11ac20MIMO	5500	Type6	25	1	333.3	9	0.3333	300	5542	1
11ac20MIMO	5500	Type6	25	1	333.3	9	0.3333	300	5563	1
11ac20MIMO	5500	Type6	25	1	333.3	9	0.3333	300	5616	1
11ac20MIMO	5500	Type6	25	1	333.3	9	0.3333	300	5596	1



Unless otherwise agreed in writing, this document is issued by the Company subject to its General Conditions of Service printed overleaf, available on request or accessible at <http://www.sgs.com/en/Terms-and-Conditions.aspx> and, for electronic format documents, subject to Terms and Conditions for Electronic Documents at <http://www.sgs.com/en/Terms-and-Conditions/Terms-e-Document.aspx>. Attention is drawn to the limitation of liability, indemnification and jurisdiction issues defined therein. Any holder of this document is advised that information contained herein reflects the Company's findings at the time of its intervention only and within the limits of Client's instructions, if any. The Company's sole responsibility is to its Client and this document does not exonerate parties to a transaction from exercising all their rights and obligations under the transaction documents. This document cannot be reproduced except in full, without prior written approval of the Company. Any unauthorized alteration, forgery or falsification of the content or appearance of this document is unlawful and offenders may be prosecuted to the fullest extent of the law. Unless otherwise stated the results shown in this test report refer only to the sample(s) tested and such sample(s) are retained for 30 days only.

Attention: To check the authenticity of testing/inspection report & certificate, please contact us at telephone: (86-755) 8307 1443, or email: [CN.Doccheck@sgs.com](mailto:CN.Doccheck@sgs.com)  
 (E) Unit D, Building 1, Kanglong Orange Science Park, No.157, Keyuan 3rd Road, Fengyang New Town, Xi'an, Shaanxi, China 710086  
 t (86-29) 6282 7885 www.sgs.com.cn  
 中国·西安·沣东新城科里三路157号康隆橙方科技园1号楼D单元1层 邮编: 710086 t (86-29) 6282 7885 sgs.china@sgs.com

11ac20MIMO	5500	Type6	25	1	333.3	9	0.3333	300	5610	1
11ac20MIMO	5500	Type6	25	1	333.3	9	0.3333	300	5671	1
11ac20MIMO	5500	Type6	25	1	333.3	9	0.3333	300	5346	1
11ac20MIMO	5500	Type6	25	1	333.3	9	0.3333	300	5599	1
11ac20MIMO	5500	Type6	25	1	333.3	9	0.3333	300	5371	1
11ac20MIMO	5500	Type6	25	1	333.3	9	0.3333	300	5658	1
11ac20MIMO	5500	Type6	25	1	333.3	9	0.3333	300	5562	1
11ac20MIMO	5500	Type6	25	1	333.3	9	0.3333	300	5638	1
11ac20MIMO	5500	Type6	25	1	333.3	9	0.3333	300	5339	1
11ac20MIMO	5500	Type6	25	1	333.3	9	0.3333	300	5381	1
11ac20MIMO	5500	Type6	25	1	333.3	9	0.3333	300	5486	1
11ac20MIMO	5500	Type6	25	1	333.3	9	0.3333	300	5453	1
11ac20MIMO	5500	Type6	25	1	333.3	9	0.3333	300	5321	1
11ac20MIMO	5500	Type6	25	1	333.3	9	0.3333	300	5535	1
11ac20MIMO	5500	Type6	25	1	333.3	9	0.3333	300	5351	1
11ac20MIMO	5500	Type6	25	1	333.3	9	0.3333	300	5588	1
11ac20MIMO	5500	Type6	25	1	333.3	9	0.3333	300	5417	1
11ac20MIMO	5500	Type6	25	1	333.3	9	0.3333	300	5308	1
11ac20MIMO	5500	Type6	25	1	333.3	9	0.3333	300	5586	1
11ac20MIMO	5500	Type6	25	1	333.3	9	0.3333	300	5498	1
11ac20MIMO	5500	Type6	25	1	333.3	9	0.3333	300	5318	1
11ac20MIMO	5500	Type6	25	1	333.3	9	0.3333	300	5289	1
11ac20MIMO	5500	Type6	25	1	333.3	9	0.3333	300	5522	1
11ac20MIMO	5500	Type6	25	1	333.3	9	0.3333	300	5364	1
11ac20MIMO	5500	Type6	25	1	333.3	9	0.3333	300	5292	1
11ac20MIMO	5500	Type6	25	1	333.3	9	0.3333	300	5706	1
11ac20MIMO	5500	Type6	25	1	333.3	9	0.3333	300	5426	1
11ac20MIMO	5500	Type6	25	1	333.3	9	0.3333	300	5448	1
11ac20MIMO	5500	Type6	25	1	333.3	9	0.3333	300	5662	1
11ac20MIMO	5500	Type6	25	1	333.3	9	0.3333	300	5257	1
11ac20MIMO	5500	Type6	25	1	333.3	9	0.3333	300	5656	1
11ac20MIMO	5500	Type6	25	1	333.3	9	0.3333	300	5663	1
11ac20MIMO	5500	Type6	25	1	333.3	9	0.3333	300	5505	1
11ac20MIMO	5500	Type6	25	1	333.3	9	0.3333	300	5674	1
11ac20MIMO	5500	Type6	25	1	333.3	9	0.3333	300	5657	1
11ac20MIMO	5500	Type6	25	1	333.3	9	0.3333	300	5514	1
11ac20MIMO	5500	Type6	25	1	333.3	9	0.3333	300	5334	1
11ac20MIMO	5500	Type6	25	1	333.3	9	0.3333	300	5428	1
11ac20MIMO	5500	Type6	25	1	333.3	9	0.3333	300	5465	1
11ac20MIMO	5500	Type6	25	1	333.3	9	0.3333	300	5489	1
11ac20MIMO	5500	Type6	25	1	333.3	9	0.3333	300	5265	1
11ac20MIMO	5500	Type6	25	1	333.3	9	0.3333	300	5437	1
11ac20MIMO	5500	Type6	25	1	333.3	9	0.3333	300	5404	1
11ac20MIMO	5500	Type6	25	1	333.3	9	0.3333	300	5396	1
11ac20MIMO	5500	Type6	25	1	333.3	9	0.3333	300	5373	1
11ac20MIMO	5500	Type6	25	1	333.3	9	0.3333	300	5564	1
11ac20MIMO	5500	Type6	25	1	333.3	9	0.3333	300	5581	1
11ac20MIMO	5500	Type6	25	1	333.3	9	0.3333	300	5324	1
11ac20MIMO	5500	Type6	25	1	333.3	9	0.3333	300	5368	1
11ac20MIMO	5500	Type6	25	1	333.3	9	0.3333	300	5625	1
11ac20MIMO	5500	Type6	25	1	333.3	9	0.3333	300	5571	1
11ac20MIMO	5500	Type6	25	1	333.3	9	0.3333	300	5399	1
11ac20MIMO	5500	Type6	25	1	333.3	9	0.3333	300	5329	1



Unless otherwise agreed in writing, this document is issued by the Company subject to its General Conditions of Service printed overleaf, available on request or accessible at <http://www.sgs.com/en/Terms-and-Conditions.aspx> and, for electronic format documents, subject to Terms and Conditions for Electronic Documents at <http://www.sgs.com/en/Terms-and-Conditions/Terms-e-Documents.aspx>. Attention is drawn to the limitation of liability, indemnification and jurisdiction issues defined therein. Any holder of this document is advised that information contained herein reflects the Company's findings at the time of its intervention only and within the limits of Client's instructions, if any. The Company's sole responsibility is to its Client and this document does not exonerate parties to a transaction from exercising all their rights and obligations under the transaction documents. This document cannot be reproduced except in full, without prior written approval of the Company. Any unauthorized alteration, forgery or falsification of the content or appearance of this document is unlawful and offenders may be prosecuted to the fullest extent of the law. Unless otherwise stated the results shown in this test report refer only to the sample(s) tested and such sample(s) are retained for 30 days only.

Attention: To check the authenticity of testing/inspection report & certificate, please contact us at telephone: (86-755) 8307 1443, or email: [CN.Doccheck@sgs.com](mailto:CN.Doccheck@sgs.com)  
 1/E Unit D, Building 1, Kanglong Orange Science Park, No.157, Keyuan 3rd Road, Fengjing New Town, Xian, Shaanxi, China 710086  
 t (86-29) 6282 7885 www.sgs.com.cn  
 中国·西安·沣东新城科里三路157号康隆橙方科技园1号楼D单元1层 邮编: 710086 t (86-29) 6282 7885 sgs.china@sgs.com



11ac20MIMO	5500	Type6	25	1	333.3	9	0.3333	300	5557	1
11ac20MIMO	5500	Type6	25	1	333.3	9	0.3333	300	5347	1
11ac20MIMO	5500	Type6	25	1	333.3	9	0.3333	300	5677	1
11ac20MIMO	5500	Type6	25	1	333.3	9	0.3333	300	5271	1
11ac20MIMO	5500	Type6	25	1	333.3	9	0.3333	300	5462	1
11ac20MIMO	5500	Type6	25	1	333.3	9	0.3333	300	5541	1
11ac20MIMO	5500	Type6	25	1	333.3	9	0.3333	300	5576	1
11ac20MIMO	5500	Type6	25	1	333.3	9	0.3333	300	5383	1
11ac20MIMO	5500	Type6	25	1	333.3	9	0.3333	300	5280	1
11ac20MIMO	5500	Type6	25	1	333.3	9	0.3333	300	5250	1
11ac20MIMO	5500	Type6	25	1	333.3	9	0.3333	300	5261	1
11ac20MIMO	5500	Type6	25	1	333.3	9	0.3333	300	5485	1
11ac20MIMO	5500	Type6	25	1	333.3	9	0.3333	300	5519	1
11ac20MIMO	5500	Type6	25	1	333.3	9	0.3333	300	5502	1
11ac20MIMO	5500	Type6	25	1	333.3	9	0.3333	300	5578	1
11ac20MIMO	5500	Type6	25	1	333.3	9	0.3333	300	5525	1
11ac20MIMO	5500	Type6	25	1	333.3	9	0.3333	300	5604	1
11ac20MIMO	5500	Type6	25	1	333.3	9	0.3333	300	5652	1
11ac20MIMO	5500	Type6	25	1	333.3	9	0.3333	300	5613	1
11ac20MIMO	5500	Type6	25	1	333.3	9	0.3333	300	5700	1
11ac20MIMO	5500	Type6	25	1	333.3	9	0.3333	300	5435	1
11ac20MIMO	5500	Type6	25	1	333.3	9	0.3333	300	5400	1
11ac20MIMO	5500	Type6	25	1	333.3	9	0.3333	300	5609	1
11ac20MIMO	5500	Type6	25	1	333.3	9	0.3333	300	5331	1
11ac20MIMO	5500	Type6	25	1	333.3	9	0.3333	300	5635	1
11ac20MIMO	5500	Type6	25	1	333.3	9	0.3333	300	5385	1
11ac20MIMO	5500	Type6	25	1	333.3	9	0.3333	300	5281	1
11ac20MIMO	5500	Type6	25	1	333.3	9	0.3333	300	5299	1
11ac20MIMO	5500	Type6	25	1	333.3	9	0.3333	300	5595	1
11ac20MIMO	5500	Type6	25	1	333.3	9	0.3333	300	5350	1
11ac20MIMO	5500	Type6	25	1	333.3	9	0.3333	300	5382	1
11ac20MIMO	5500	Type6	25	1	333.3	9	0.3333	300	5407	1
11ac20MIMO	5500	Type6	25	1	333.3	9	0.3333	300	5695	1
11ac20MIMO	5500	Type6	25	1	333.3	9	0.3333	300	5546	1
11ac20MIMO	5500	Type6	25	1	333.3	9	0.3333	300	5683	1
11ac20MIMO	5500	Type6	25	1	333.3	9	0.3333	300	5607	1
11ac20MIMO	5500	Type6	25	1	333.3	9	0.3333	300	5263	1
11ac20MIMO	5500	Type6	25	1	333.3	9	0.3333	300	5655	1
11ac20MIMO	5500	Type6	25	1	333.3	9	0.3333	300	5550	1
11ac20MIMO	5500	Type6	25	1	333.3	9	0.3333	300	5459	1



Unless otherwise agreed in writing, this document is issued by the Company subject to its General Conditions of Service printed overleaf, available on request or accessible at <http://www.sgs.com/en/Terms-and-Conditions.aspx> and, for electronic format documents, subject to Terms and Conditions for Electronic Documents at <http://www.sgs.com/en/Terms-and-Conditions/Terms-e-Documents.aspx>. Attention is drawn to the limitation of liability, indemnification and jurisdiction issues defined therein. Any holder of this document is advised that information contained herein reflects the Company's findings at the time of its intervention only and within the limits of Client's instructions, if any. The Company's sole responsibility is to its Client and this document does not exonerate parties to a transaction from exercising all their rights and obligations under the transaction documents. This document cannot be reproduced except in full, without prior written approval of the Company. Any unauthorized alteration, forgery or falsification of the content or appearance of this document is unlawful and offenders may be prosecuted to the fullest extent of the law. Unless otherwise stated the results shown in this test report refer only to the sample(s) tested and such sample(s) are retained for 30 days only.

Attention: To check the authenticity of testing/inspection report & certificate, please contact us at telephone: (86-755) 4307 1443, or email: CN.Doccheck@sgs.com

TestMode	Channel	Radar Type	Trial ID	Pulse width (μs)	PRI (μs)	Pulses per Hop	Hop Rate (kHz)	Hop Sequence Length(ms)	Center Frequency (MHz)	Detection (1: Yes; 0: No)
11ac80MIMO	5530	Type6	26	1	333.3	9	0.3333	300	5712	1
11ac80MIMO	5530	Type6	26	1	333.3	9	0.3333	300	5475	1
11ac80MIMO	5530	Type6	26	1	333.3	9	0.3333	300	5570	1
11ac80MIMO	5530	Type6	26	1	333.3	9	0.3333	300	5703	1
11ac80MIMO	5530	Type6	26	1	333.3	9	0.3333	300	5308	1
11ac80MIMO	5530	Type6	26	1	333.3	9	0.3333	300	5658	1
11ac80MIMO	5530	Type6	26	1	333.3	9	0.3333	300	5521	1
11ac80MIMO	5530	Type6	26	1	333.3	9	0.3333	300	5685	1
11ac80MIMO	5530	Type6	26	1	333.3	9	0.3333	300	5359	1
11ac80MIMO	5530	Type6	26	1	333.3	9	0.3333	300	5650	1
11ac80MIMO	5530	Type6	26	1	333.3	9	0.3333	300	5433	1
11ac80MIMO	5530	Type6	26	1	333.3	9	0.3333	300	5257	1
11ac80MIMO	5530	Type6	26	1	333.3	9	0.3333	300	5699	1
11ac80MIMO	5530	Type6	26	1	333.3	9	0.3333	300	5282	1
11ac80MIMO	5530	Type6	26	1	333.3	9	0.3333	300	5659	1
11ac80MIMO	5530	Type6	26	1	333.3	9	0.3333	300	5427	1
11ac80MIMO	5530	Type6	26	1	333.3	9	0.3333	300	5508	1
11ac80MIMO	5530	Type6	26	1	333.3	9	0.3333	300	5589	1
11ac80MIMO	5530	Type6	26	1	333.3	9	0.3333	300	5498	1
11ac80MIMO	5530	Type6	26	1	333.3	9	0.3333	300	5610	1
11ac80MIMO	5530	Type6	26	1	333.3	9	0.3333	300	5446	1
11ac80MIMO	5530	Type6	26	1	333.3	9	0.3333	300	5420	1
11ac80MIMO	5530	Type6	26	1	333.3	9	0.3333	300	5626	1
11ac80MIMO	5530	Type6	26	1	333.3	9	0.3333	300	5409	1
11ac80MIMO	5530	Type6	26	1	333.3	9	0.3333	300	5281	1
11ac80MIMO	5530	Type6	26	1	333.3	9	0.3333	300	5377	1
11ac80MIMO	5530	Type6	26	1	333.3	9	0.3333	300	5350	1
11ac80MIMO	5530	Type6	26	1	333.3	9	0.3333	300	5424	1
11ac80MIMO	5530	Type6	26	1	333.3	9	0.3333	300	5393	1
11ac80MIMO	5530	Type6	26	1	333.3	9	0.3333	300	5556	1
11ac80MIMO	5530	Type6	26	1	333.3	9	0.3333	300	5406	1
11ac80MIMO	5530	Type6	26	1	333.3	9	0.3333	300	5656	1
11ac80MIMO	5530	Type6	26	1	333.3	9	0.3333	300	5328	1
11ac80MIMO	5530	Type6	26	1	333.3	9	0.3333	300	5315	1
11ac80MIMO	5530	Type6	26	1	333.3	9	0.3333	300	5721	1
11ac80MIMO	5530	Type6	26	1	333.3	9	0.3333	300	5587	1
11ac80MIMO	5530	Type6	26	1	333.3	9	0.3333	300	5278	1
11ac80MIMO	5530	Type6	26	1	333.3	9	0.3333	300	5528	1
11ac80MIMO	5530	Type6	26	1	333.3	9	0.3333	300	5431	1
11ac80MIMO	5530	Type6	26	1	333.3	9	0.3333	300	5674	1
11ac80MIMO	5530	Type6	26	1	333.3	9	0.3333	300	5441	1
11ac80MIMO	5530	Type6	26	1	333.3	9	0.3333	300	5531	1
11ac80MIMO	5530	Type6	26	1	333.3	9	0.3333	300	5515	1
11ac80MIMO	5530	Type6	26	1	333.3	9	0.3333	300	5422	1
11ac80MIMO	5530	Type6	26	1	333.3	9	0.3333	300	5608	1
11ac80MIMO	5530	Type6	26	1	333.3	9	0.3333	300	5263	1
11ac80MIMO	5530	Type6	26	1	333.3	9	0.3333	300	5408	1
11ac80MIMO	5530	Type6	26	1	333.3	9	0.3333	300	5548	1
11ac80MIMO	5530	Type6	26	1	333.3	9	0.3333	300	5547	1



Unless otherwise agreed in writing, this document is issued by the Company subject to its General Conditions of Service printed overleaf, available on request or accessible at <http://www.sgs.com/en/Terms-and-Conditions.aspx> and, for electronic format documents, subject to Terms and Conditions for Electronic Documents at <http://www.sgs.com/en/Terms-and-Conditions/Terms-e-Documents.aspx>. Attention is drawn to the limitation of liability, indemnification and jurisdiction issues defined therein. Any holder of this document is advised that information contained herein reflects the Company's findings at the time of its intervention only and within the limits of Client's instructions, if any. The Company's sole responsibility is to its Client and this document does not exonerate parties to a transaction from exercising all their rights and obligations under the transaction documents. This document cannot be reproduced except in full, without prior written approval of the Company. Any unauthorized alteration, forgery or falsification of the content or appearance of this document is unlawful and offenders may be prosecuted to the fullest extent of the law. Unless otherwise stated the results shown in this test report refer only to the sample(s) tested and such sample(s) are retained for 30 days only.

Attention: To check the authenticity of testing/inspection report & certificate, please contact us at telephone: (86-755) 8307 1443, or email: [CN.Doccheck@sgs.com](mailto:CN.Doccheck@sgs.com)

SGS-CSTC Standards Technical Services (Xi'an) Co., Ltd. | 1/E Unit D Building 1, Kanglong Orange Science Park, No.157, Keyuan 3rd Road, Fengjing/Yue Town, Xi'an, Shaanxi, China | 710086 | T (86-29) 6282 7885 | [www.sgs.com.cn](http://www.sgs.com.cn)  
 中国·西安·沣东新城科里三路157号康隆橙方科技园1号楼D单元1层 | 邮编: 710086 | T (86-29) 6282 7885 | [sgs.china@sgs.com](mailto:sgs.china@sgs.com)



11ac80MIMO	5530	Type6	26	1	333.3	9	0.3333	300	5318	1
11ac80MIMO	5530	Type6	26	1	333.3	9	0.3333	300	5324	1
11ac80MIMO	5530	Type6	26	1	333.3	9	0.3333	300	5280	1
11ac80MIMO	5530	Type6	26	1	333.3	9	0.3333	300	5572	1
11ac80MIMO	5530	Type6	26	1	333.3	9	0.3333	300	5639	1
11ac80MIMO	5530	Type6	26	1	333.3	9	0.3333	300	5542	1
11ac80MIMO	5530	Type6	26	1	333.3	9	0.3333	300	5671	1
11ac80MIMO	5530	Type6	26	1	333.3	9	0.3333	300	5294	1
11ac80MIMO	5530	Type6	26	1	333.3	9	0.3333	300	5558	1
11ac80MIMO	5530	Type6	26	1	333.3	9	0.3333	300	5347	1
11ac80MIMO	5530	Type6	26	1	333.3	9	0.3333	300	5494	1
11ac80MIMO	5530	Type6	26	1	333.3	9	0.3333	300	5502	1
11ac80MIMO	5530	Type6	26	1	333.3	9	0.3333	300	5654	1
11ac80MIMO	5530	Type6	26	1	333.3	9	0.3333	300	5600	1
11ac80MIMO	5530	Type6	26	1	333.3	9	0.3333	300	5692	1
11ac80MIMO	5530	Type6	26	1	333.3	9	0.3333	300	5663	1
11ac80MIMO	5530	Type6	26	1	333.3	9	0.3333	300	5662	1
11ac80MIMO	5530	Type6	26	1	333.3	9	0.3333	300	5577	1
11ac80MIMO	5530	Type6	26	1	333.3	9	0.3333	300	5311	1
11ac80MIMO	5530	Type6	26	1	333.3	9	0.3333	300	5414	1
11ac80MIMO	5530	Type6	26	1	333.3	9	0.3333	300	5661	1
11ac80MIMO	5530	Type6	26	1	333.3	9	0.3333	300	5352	1
11ac80MIMO	5530	Type6	26	1	333.3	9	0.3333	300	5711	1
11ac80MIMO	5530	Type6	26	1	333.3	9	0.3333	300	5361	1
11ac80MIMO	5530	Type6	26	1	333.3	9	0.3333	300	5334	1
11ac80MIMO	5530	Type6	26	1	333.3	9	0.3333	300	5398	1
11ac80MIMO	5530	Type6	26	1	333.3	9	0.3333	300	5461	1
11ac80MIMO	5530	Type6	26	1	333.3	9	0.3333	300	5289	1
11ac80MIMO	5530	Type6	26	1	333.3	9	0.3333	300	5698	1
11ac80MIMO	5530	Type6	26	1	333.3	9	0.3333	300	5668	1
11ac80MIMO	5530	Type6	26	1	333.3	9	0.3333	300	5585	1
11ac80MIMO	5530	Type6	26	1	333.3	9	0.3333	300	5429	1
11ac80MIMO	5530	Type6	26	1	333.3	9	0.3333	300	5723	1
11ac80MIMO	5530	Type6	26	1	333.3	9	0.3333	300	5481	1
11ac80MIMO	5530	Type6	26	1	333.3	9	0.3333	300	5629	1
11ac80MIMO	5530	Type6	26	1	333.3	9	0.3333	300	5595	1
11ac80MIMO	5530	Type6	26	1	333.3	9	0.3333	300	5300	1
11ac80MIMO	5530	Type6	26	1	333.3	9	0.3333	300	5329	1
11ac80MIMO	5530	Type6	26	1	333.3	9	0.3333	300	5331	1
11ac80MIMO	5530	Type6	26	1	333.3	9	0.3333	300	5597	1
11ac80MIMO	5530	Type6	26	1	333.3	9	0.3333	300	5598	1
11ac80MIMO	5530	Type6	26	1	333.3	9	0.3333	300	5624	1
11ac80MIMO	5530	Type6	26	1	333.3	9	0.3333	300	5368	1
11ac80MIMO	5530	Type6	26	1	333.3	9	0.3333	300	5645	1
11ac80MIMO	5530	Type6	26	1	333.3	9	0.3333	300	5679	1
11ac80MIMO	5530	Type6	26	1	333.3	9	0.3333	300	5485	1
11ac80MIMO	5530	Type6	26	1	333.3	9	0.3333	300	5707	1
11ac80MIMO	5530	Type6	26	1	333.3	9	0.3333	300	5563	1
11ac80MIMO	5530	Type6	26	1	333.3	9	0.3333	300	5591	1
11ac80MIMO	5530	Type6	26	1	333.3	9	0.3333	300	5636	1
11ac80MIMO	5530	Type6	26	1	333.3	9	0.3333	300	5537	1
11ac40MIMO	5510	Type6	26	1	333.3	9	0.3333	300	5712	1
11ac40MIMO	5510	Type6	26	1	333.3	9	0.3333	300	5475	1



Unless otherwise agreed in writing, this document is issued by the Company subject to its General Conditions of Service printed overleaf, available on request or accessible at <http://www.sgs.com/en/Terms-and-Conditions.aspx> and, for electronic format documents, subject to Terms and Conditions for Electronic Documents at <http://www.sgs.com/en/Terms-and-Conditions/Terms-e-Documents.aspx>. Attention is drawn to the limitation of liability, indemnification and jurisdiction issues defined therein. Any holder of this document is advised that information contained herein reflects the Company's findings at the time of its intervention only and within the limits of Client's instructions, if any. The Company's sole responsibility is to its Client and this document does not exonerate parties to a transaction from exercising all their rights and obligations under the transaction documents. This document cannot be reproduced except in full, without prior written approval of the Company. Any unauthorized alteration, forgery or falsification of the content or appearance of this document is unlawful and offenders may be prosecuted to the fullest extent of the law. Unless otherwise stated the results shown in this test report refer only to the sample(s) tested and such sample(s) are retained for 30 days only.

Attention: To check the authenticity of testing/inspection report & certificate, please contact us at telephone: (86-755) 8307 1443, or email: [CN.Doccheck@sgs.com](mailto:CN.Doccheck@sgs.com)  
 (E) Unit D, Building 1, Kanglong Orange Science Park, No.157, Keyuan 3rd Road, Fengyang New Town, Xi'an, Shaanxi, China 710086  
 t (86-29) 6282 7885 www.sgs.com.cn  
 中国·西安·沣东新城科里三路157号康隆橙方科技园1号楼D单元1层 邮编: 710086 t (86-29) 6282 7885 sgs.china@sgs.com



11ac40MIMO	5510	Type6	26	1	333.3	9	0.3333	300	5570	1
11ac40MIMO	5510	Type6	26	1	333.3	9	0.3333	300	5703	1
11ac40MIMO	5510	Type6	26	1	333.3	9	0.3333	300	5308	1
11ac40MIMO	5510	Type6	26	1	333.3	9	0.3333	300	5658	1
11ac40MIMO	5510	Type6	26	1	333.3	9	0.3333	300	5521	1
11ac40MIMO	5510	Type6	26	1	333.3	9	0.3333	300	5685	1
11ac40MIMO	5510	Type6	26	1	333.3	9	0.3333	300	5359	1
11ac40MIMO	5510	Type6	26	1	333.3	9	0.3333	300	5650	1
11ac40MIMO	5510	Type6	26	1	333.3	9	0.3333	300	5433	1
11ac40MIMO	5510	Type6	26	1	333.3	9	0.3333	300	5257	1
11ac40MIMO	5510	Type6	26	1	333.3	9	0.3333	300	5699	1
11ac40MIMO	5510	Type6	26	1	333.3	9	0.3333	300	5282	1
11ac40MIMO	5510	Type6	26	1	333.3	9	0.3333	300	5659	1
11ac40MIMO	5510	Type6	26	1	333.3	9	0.3333	300	5427	1
11ac40MIMO	5510	Type6	26	1	333.3	9	0.3333	300	5508	1
11ac40MIMO	5510	Type6	26	1	333.3	9	0.3333	300	5589	1
11ac40MIMO	5510	Type6	26	1	333.3	9	0.3333	300	5498	1
11ac40MIMO	5510	Type6	26	1	333.3	9	0.3333	300	5610	1
11ac40MIMO	5510	Type6	26	1	333.3	9	0.3333	300	5446	1
11ac40MIMO	5510	Type6	26	1	333.3	9	0.3333	300	5420	1
11ac40MIMO	5510	Type6	26	1	333.3	9	0.3333	300	5626	1
11ac40MIMO	5510	Type6	26	1	333.3	9	0.3333	300	5409	1
11ac40MIMO	5510	Type6	26	1	333.3	9	0.3333	300	5281	1
11ac40MIMO	5510	Type6	26	1	333.3	9	0.3333	300	5377	1
11ac40MIMO	5510	Type6	26	1	333.3	9	0.3333	300	5350	1
11ac40MIMO	5510	Type6	26	1	333.3	9	0.3333	300	5424	1
11ac40MIMO	5510	Type6	26	1	333.3	9	0.3333	300	5393	1
11ac40MIMO	5510	Type6	26	1	333.3	9	0.3333	300	5556	1
11ac40MIMO	5510	Type6	26	1	333.3	9	0.3333	300	5406	1
11ac40MIMO	5510	Type6	26	1	333.3	9	0.3333	300	5656	1
11ac40MIMO	5510	Type6	26	1	333.3	9	0.3333	300	5328	1
11ac40MIMO	5510	Type6	26	1	333.3	9	0.3333	300	5315	1
11ac40MIMO	5510	Type6	26	1	333.3	9	0.3333	300	5721	1
11ac40MIMO	5510	Type6	26	1	333.3	9	0.3333	300	5587	1
11ac40MIMO	5510	Type6	26	1	333.3	9	0.3333	300	5278	1
11ac40MIMO	5510	Type6	26	1	333.3	9	0.3333	300	5528	1
11ac40MIMO	5510	Type6	26	1	333.3	9	0.3333	300	5431	1
11ac40MIMO	5510	Type6	26	1	333.3	9	0.3333	300	5674	1
11ac40MIMO	5510	Type6	26	1	333.3	9	0.3333	300	5441	1
11ac40MIMO	5510	Type6	26	1	333.3	9	0.3333	300	5531	1
11ac40MIMO	5510	Type6	26	1	333.3	9	0.3333	300	5515	1
11ac40MIMO	5510	Type6	26	1	333.3	9	0.3333	300	5422	1
11ac40MIMO	5510	Type6	26	1	333.3	9	0.3333	300	5608	1
11ac40MIMO	5510	Type6	26	1	333.3	9	0.3333	300	5263	1
11ac40MIMO	5510	Type6	26	1	333.3	9	0.3333	300	5408	1
11ac40MIMO	5510	Type6	26	1	333.3	9	0.3333	300	5548	1
11ac40MIMO	5510	Type6	26	1	333.3	9	0.3333	300	5547	1
11ac40MIMO	5510	Type6	26	1	333.3	9	0.3333	300	5318	1
11ac40MIMO	5510	Type6	26	1	333.3	9	0.3333	300	5324	1
11ac40MIMO	5510	Type6	26	1	333.3	9	0.3333	300	5280	1
11ac40MIMO	5510	Type6	26	1	333.3	9	0.3333	300	5572	1
11ac40MIMO	5510	Type6	26	1	333.3	9	0.3333	300	5639	1
11ac40MIMO	5510	Type6	26	1	333.3	9	0.3333	300	5542	1



Unless otherwise agreed in writing, this document is issued by the Company subject to its General Conditions of Service printed overleaf, available on request or accessible at <http://www.sgs.com/en/Terms-and-Conditions.aspx> and, for electronic format documents, subject to Terms and Conditions for Electronic Documents at <http://www.sgs.com/en/Terms-and-Conditions/Terms-e-Documents.aspx>. Attention is drawn to the limitation of liability, indemnification and jurisdiction issues defined therein. Any holder of this document is advised that information contained herein reflects the Company's findings at the time of its intervention only and within the limits of Client's instructions, if any. The Company's sole responsibility is to its Client and this document does not exonerate parties to a transaction from exercising all their rights and obligations under the transaction documents. This document cannot be reproduced except in full, without prior written approval of the Company. Any unauthorized alteration, forgery or falsification of the content or appearance of this document is unlawful and offenders may be prosecuted to the fullest extent of the law. Unless otherwise stated the results shown in this test report refer only to the sample(s) tested and such sample(s) are retained for 30 days only.

Attention: To check the authenticity of testing inspection report & certificate, please contact us at telephone: (86-755) 8307 1443, or email: [CN.Doccheck@sgs.com](mailto:CN.Doccheck@sgs.com)  
 (E) Unit D, Building 1, Kanglong Orange Science Park, No.157, Keyuan 3rd Road, Fengfeng New Town, Xi'an, Shaanxi, China 710086  
 t (86-29) 6282 7885 www.sgs.com.cn  
 中国·西安·沣东新城科里三路157号康隆橙方科技园1号楼D单元1层 邮编: 710086 t (86-29) 6282 7885 sgs.china@sgs.com



Table with 11 columns: Item ID, Value, Type, Dimensions, and various test results. Rows include items like 11ac40MIMO and 11ac20MIMO.



Unless otherwise agreed in writing, this document is issued by the Company subject to its General Conditions of Service printed overleaf... Attention: To check the authenticity of testing/inspection report & certificate, please contact us at telephone: (86-755) 8307 1443, or email: CN.Doccheck@sgs.com



Table with 11 columns: Sample ID, Weight, Type, Dimensions, etc. The table contains 40 rows of data, all with a weight of 5500 and a Type of Type6.



Unless otherwise agreed in writing, this document is issued by the Company subject to its General Conditions of Service printed overleaf, available on request or accessible at <http://www.sgs.com/en/Terms-and-Conditions.aspx> and, for electronic format documents, subject to Terms and Conditions for Electronic Documents at <http://www.sgs.com/en/Terms-and-Conditions/Terms-e-Document.aspx>. Attention is drawn to the limitation of liability, indemnification and jurisdiction issues defined therein. Any holder of this document is advised that information contained herein reflects the Company's findings at the time of its intervention only and within the limits of Client's instructions, if any. The Company's sole responsibility is to its Client and this document does not exonerate parties to a transaction from exercising all their rights and obligations under the transaction documents. This document cannot be reproduced except in full, without prior written approval of the Company. Any unauthorized alteration, forgery or falsification of the content or appearance of this document is unlawful and offenders may be prosecuted to the fullest extent of the law. Unless otherwise stated the results shown in this test report refer only to the sample(s) tested and such sample(s) are retained for 30 days only. Attention: To check the authenticity of testing/inspection report & certificate, please contact us at telephone: (86-755) 8307 1443, or email: CN\_Doccheck@sgs.com



Report No.: XEWA2310000070RG05

Rev.: 01

Page: 249 of 267

11ac20MIMO	5500	Type6	26	1	333.3	9	0.3333	300	5654	1
11ac20MIMO	5500	Type6	26	1	333.3	9	0.3333	300	5600	1
11ac20MIMO	5500	Type6	26	1	333.3	9	0.3333	300	5692	1
11ac20MIMO	5500	Type6	26	1	333.3	9	0.3333	300	5663	1
11ac20MIMO	5500	Type6	26	1	333.3	9	0.3333	300	5662	1
11ac20MIMO	5500	Type6	26	1	333.3	9	0.3333	300	5577	1
11ac20MIMO	5500	Type6	26	1	333.3	9	0.3333	300	5311	1
11ac20MIMO	5500	Type6	26	1	333.3	9	0.3333	300	5414	1
11ac20MIMO	5500	Type6	26	1	333.3	9	0.3333	300	5661	1
11ac20MIMO	5500	Type6	26	1	333.3	9	0.3333	300	5352	1
11ac20MIMO	5500	Type6	26	1	333.3	9	0.3333	300	5711	1
11ac20MIMO	5500	Type6	26	1	333.3	9	0.3333	300	5361	1
11ac20MIMO	5500	Type6	26	1	333.3	9	0.3333	300	5334	1
11ac20MIMO	5500	Type6	26	1	333.3	9	0.3333	300	5398	1
11ac20MIMO	5500	Type6	26	1	333.3	9	0.3333	300	5461	1
11ac20MIMO	5500	Type6	26	1	333.3	9	0.3333	300	5289	1
11ac20MIMO	5500	Type6	26	1	333.3	9	0.3333	300	5698	1
11ac20MIMO	5500	Type6	26	1	333.3	9	0.3333	300	5668	1
11ac20MIMO	5500	Type6	26	1	333.3	9	0.3333	300	5585	1
11ac20MIMO	5500	Type6	26	1	333.3	9	0.3333	300	5429	1
11ac20MIMO	5500	Type6	26	1	333.3	9	0.3333	300	5723	1
11ac20MIMO	5500	Type6	26	1	333.3	9	0.3333	300	5481	1
11ac20MIMO	5500	Type6	26	1	333.3	9	0.3333	300	5629	1
11ac20MIMO	5500	Type6	26	1	333.3	9	0.3333	300	5595	1
11ac20MIMO	5500	Type6	26	1	333.3	9	0.3333	300	5300	1
11ac20MIMO	5500	Type6	26	1	333.3	9	0.3333	300	5329	1
11ac20MIMO	5500	Type6	26	1	333.3	9	0.3333	300	5331	1
11ac20MIMO	5500	Type6	26	1	333.3	9	0.3333	300	5597	1
11ac20MIMO	5500	Type6	26	1	333.3	9	0.3333	300	5598	1
11ac20MIMO	5500	Type6	26	1	333.3	9	0.3333	300	5624	1
11ac20MIMO	5500	Type6	26	1	333.3	9	0.3333	300	5368	1
11ac20MIMO	5500	Type6	26	1	333.3	9	0.3333	300	5645	1
11ac20MIMO	5500	Type6	26	1	333.3	9	0.3333	300	5679	1
11ac20MIMO	5500	Type6	26	1	333.3	9	0.3333	300	5485	1
11ac20MIMO	5500	Type6	26	1	333.3	9	0.3333	300	5707	1
11ac20MIMO	5500	Type6	26	1	333.3	9	0.3333	300	5563	1
11ac20MIMO	5500	Type6	26	1	333.3	9	0.3333	300	5591	1
11ac20MIMO	5500	Type6	26	1	333.3	9	0.3333	300	5636	1
11ac20MIMO	5500	Type6	26	1	333.3	9	0.3333	300	5537	1



Unless otherwise agreed in writing, this document is issued by the Company subject to its General Conditions of Service printed overleaf, available on request or accessible at <http://www.sgs.com/en/Terms-and-Conditions.aspx> and, for electronic format documents, subject to Terms and Conditions for Electronic Documents at <http://www.sgs.com/en/Terms-and-Conditions/Terms-e-Documents.aspx>. Attention is drawn to the limitation of liability, indemnification and jurisdiction issues defined therein. Any holder of this document is advised that information contained herein reflects the Company's findings at the time of its intervention only and within the limits of Client's instructions, if any. The Company's sole responsibility is to its Client and this document does not exonerate parties to a transaction from exercising all their rights and obligations under the transaction documents. This document cannot be reproduced except in full, without prior written approval of the Company. Any unauthorized alteration, forgery or falsification of the content or appearance of this document is unlawful and offenders may be prosecuted to the fullest extent of the law. Unless otherwise stated the results shown in this test report refer only to the sample(s) tested and such sample(s) are retained for 30 days only.

Attention: To check the authenticity of testing/inspection report & certificate, please contact us at telephone: (86-755) 4307 1443, or email: [CN.Doccheck@sgs.com](mailto:CN.Doccheck@sgs.com)  
 1/E Unit D, Building 1, Kanghong Orange Source Park, No.137, Kejian 3rd Road, Fengling New Town, Xi'an, Shaanxi, China 710086 t (86-29) 6282 7885 www.sgs.com.cn  
 中国·西安·沣东新城科里三路137号康鸿橙方科技园1号楼D单元1层 邮编: 710086 t (86-29) 6282 7885 sgs.china@sgs.com

TestMode	Channel	Radar Type	Trial ID	Pulse width (μs)	PRI (μs)	Pulses per Hop	Hop Rate (kHz)	Hop Sequence Length(ms)	Center Frequency (MHz)	Detection (1: Yes; 0: No)
11ac80MIMO	5530	Type6	27	1	333.3	9	0.3333	300	5492	1
11ac80MIMO	5530	Type6	27	1	333.3	9	0.3333	300	5714	1
11ac80MIMO	5530	Type6	27	1	333.3	9	0.3333	300	5506	1
11ac80MIMO	5530	Type6	27	1	333.3	9	0.3333	300	5389	1
11ac80MIMO	5530	Type6	27	1	333.3	9	0.3333	300	5625	1
11ac80MIMO	5530	Type6	27	1	333.3	9	0.3333	300	5700	1
11ac80MIMO	5530	Type6	27	1	333.3	9	0.3333	300	5543	1
11ac80MIMO	5530	Type6	27	1	333.3	9	0.3333	300	5285	1
11ac80MIMO	5530	Type6	27	1	333.3	9	0.3333	300	5522	1
11ac80MIMO	5530	Type6	27	1	333.3	9	0.3333	300	5382	1
11ac80MIMO	5530	Type6	27	1	333.3	9	0.3333	300	5364	1
11ac80MIMO	5530	Type6	27	1	333.3	9	0.3333	300	5521	1
11ac80MIMO	5530	Type6	27	1	333.3	9	0.3333	300	5265	1
11ac80MIMO	5530	Type6	27	1	333.3	9	0.3333	300	5477	1
11ac80MIMO	5530	Type6	27	1	333.3	9	0.3333	300	5680	1
11ac80MIMO	5530	Type6	27	1	333.3	9	0.3333	300	5418	1
11ac80MIMO	5530	Type6	27	1	333.3	9	0.3333	300	5635	1
11ac80MIMO	5530	Type6	27	1	333.3	9	0.3333	300	5692	1
11ac80MIMO	5530	Type6	27	1	333.3	9	0.3333	300	5327	1
11ac80MIMO	5530	Type6	27	1	333.3	9	0.3333	300	5454	1
11ac80MIMO	5530	Type6	27	1	333.3	9	0.3333	300	5586	1
11ac80MIMO	5530	Type6	27	1	333.3	9	0.3333	300	5567	1
11ac80MIMO	5530	Type6	27	1	333.3	9	0.3333	300	5498	1
11ac80MIMO	5530	Type6	27	1	333.3	9	0.3333	300	5254	1
11ac80MIMO	5530	Type6	27	1	333.3	9	0.3333	300	5299	1
11ac80MIMO	5530	Type6	27	1	333.3	9	0.3333	300	5627	1
11ac80MIMO	5530	Type6	27	1	333.3	9	0.3333	300	5594	1
11ac80MIMO	5530	Type6	27	1	333.3	9	0.3333	300	5590	1
11ac80MIMO	5530	Type6	27	1	333.3	9	0.3333	300	5448	1
11ac80MIMO	5530	Type6	27	1	333.3	9	0.3333	300	5642	1
11ac80MIMO	5530	Type6	27	1	333.3	9	0.3333	300	5661	1
11ac80MIMO	5530	Type6	27	1	333.3	9	0.3333	300	5564	1
11ac80MIMO	5530	Type6	27	1	333.3	9	0.3333	300	5541	1
11ac80MIMO	5530	Type6	27	1	333.3	9	0.3333	300	5629	1
11ac80MIMO	5530	Type6	27	1	333.3	9	0.3333	300	5369	1
11ac80MIMO	5530	Type6	27	1	333.3	9	0.3333	300	5324	1
11ac80MIMO	5530	Type6	27	1	333.3	9	0.3333	300	5584	1
11ac80MIMO	5530	Type6	27	1	333.3	9	0.3333	300	5588	1
11ac80MIMO	5530	Type6	27	1	333.3	9	0.3333	300	5280	1
11ac80MIMO	5530	Type6	27	1	333.3	9	0.3333	300	5614	1
11ac80MIMO	5530	Type6	27	1	333.3	9	0.3333	300	5453	1
11ac80MIMO	5530	Type6	27	1	333.3	9	0.3333	300	5565	1
11ac80MIMO	5530	Type6	27	1	333.3	9	0.3333	300	5605	1
11ac80MIMO	5530	Type6	27	1	333.3	9	0.3333	300	5570	1
11ac80MIMO	5530	Type6	27	1	333.3	9	0.3333	300	5291	1
11ac80MIMO	5530	Type6	27	1	333.3	9	0.3333	300	5631	1
11ac80MIMO	5530	Type6	27	1	333.3	9	0.3333	300	5371	1
11ac80MIMO	5530	Type6	27	1	333.3	9	0.3333	300	5589	1
11ac80MIMO	5530	Type6	27	1	333.3	9	0.3333	300	5534	1



Unless otherwise agreed in writing, this document is issued by the Company subject to its General Conditions of Service printed overleaf, available on request or accessible at <http://www.sgs.com/en/Terms-and-Conditions.aspx> and, for electronic format documents, subject to Terms and Conditions for Electronic Documents at <http://www.sgs.com/en/Terms-and-Conditions/Terms-e-Documents.aspx>. Attention is drawn to the limitation of liability, indemnification and jurisdiction issues defined therein. Any holder of this document is advised that information contained herein reflects the Company's findings at the time of its intervention only and within the limits of Client's instructions, if any. The Company's sole responsibility is to its Client and this document does not exonerate parties to a transaction from exercising all their rights and obligations under the transaction documents. This document cannot be reproduced except in full, without prior written approval of the Company. Any unauthorized alteration, forgery or falsification of the content or appearance of this document is unlawful and offenders may be prosecuted to the fullest extent of the law. Unless otherwise stated the results shown in this test report refer only to the sample(s) tested and such sample(s) are retained for 30 days only.

Attention: To check the authenticity of testing/inspection report & certificate, please contact us at telephone: (86-755) 8307 1443, or email: [CN.Doccheck@sgs.com](mailto:CN.Doccheck@sgs.com)  
 S/GS-CSTC Standards Technical Services (Xi'an) Co., Ltd. | 1/E Unit D, Building 1, Kanglong Orange Science Park, No.157, Keyuan 3rd Road, Fengjing/Yue Town, Xi'an, Shaanxi, China | 710086 | t (86-29) 6282 7885 | www.sgs.com.cn  
 中国·西安·沣东新城科里三路157号康隆橙方科技园1号楼D单元1层 | 邮编: 710086 | t (86-29) 6282 7885 | sgs.china@sgs.com

11ac80MIMO	5530	Type6	27	1	333.3	9	0.3333	300	5273	1
11ac80MIMO	5530	Type6	27	1	333.3	9	0.3333	300	5690	1
11ac80MIMO	5530	Type6	27	1	333.3	9	0.3333	300	5494	1
11ac80MIMO	5530	Type6	27	1	333.3	9	0.3333	300	5355	1
11ac80MIMO	5530	Type6	27	1	333.3	9	0.3333	300	5482	1
11ac80MIMO	5530	Type6	27	1	333.3	9	0.3333	300	5707	1
11ac80MIMO	5530	Type6	27	1	333.3	9	0.3333	300	5641	1
11ac80MIMO	5530	Type6	27	1	333.3	9	0.3333	300	5513	1
11ac80MIMO	5530	Type6	27	1	333.3	9	0.3333	300	5657	1
11ac80MIMO	5530	Type6	27	1	333.3	9	0.3333	300	5659	1
11ac80MIMO	5530	Type6	27	1	333.3	9	0.3333	300	5544	1
11ac80MIMO	5530	Type6	27	1	333.3	9	0.3333	300	5486	1
11ac80MIMO	5530	Type6	27	1	333.3	9	0.3333	300	5426	1
11ac80MIMO	5530	Type6	27	1	333.3	9	0.3333	300	5638	1
11ac80MIMO	5530	Type6	27	1	333.3	9	0.3333	300	5611	1
11ac80MIMO	5530	Type6	27	1	333.3	9	0.3333	300	5516	1
11ac80MIMO	5530	Type6	27	1	333.3	9	0.3333	300	5618	1
11ac80MIMO	5530	Type6	27	1	333.3	9	0.3333	300	5684	1
11ac80MIMO	5530	Type6	27	1	333.3	9	0.3333	300	5464	1
11ac80MIMO	5530	Type6	27	1	333.3	9	0.3333	300	5697	1
11ac80MIMO	5530	Type6	27	1	333.3	9	0.3333	300	5658	1
11ac80MIMO	5530	Type6	27	1	333.3	9	0.3333	300	5374	1
11ac80MIMO	5530	Type6	27	1	333.3	9	0.3333	300	5420	1
11ac80MIMO	5530	Type6	27	1	333.3	9	0.3333	300	5258	1
11ac80MIMO	5530	Type6	27	1	333.3	9	0.3333	300	5721	1
11ac80MIMO	5530	Type6	27	1	333.3	9	0.3333	300	5566	1
11ac80MIMO	5530	Type6	27	1	333.3	9	0.3333	300	5681	1
11ac80MIMO	5530	Type6	27	1	333.3	9	0.3333	300	5358	1
11ac80MIMO	5530	Type6	27	1	333.3	9	0.3333	300	5262	1
11ac80MIMO	5530	Type6	27	1	333.3	9	0.3333	300	5696	1
11ac80MIMO	5530	Type6	27	1	333.3	9	0.3333	300	5297	1
11ac80MIMO	5530	Type6	27	1	333.3	9	0.3333	300	5621	1
11ac80MIMO	5530	Type6	27	1	333.3	9	0.3333	300	5709	1
11ac80MIMO	5530	Type6	27	1	333.3	9	0.3333	300	5439	1
11ac80MIMO	5530	Type6	27	1	333.3	9	0.3333	300	5672	1
11ac80MIMO	5530	Type6	27	1	333.3	9	0.3333	300	5304	1
11ac80MIMO	5530	Type6	27	1	333.3	9	0.3333	300	5616	1
11ac80MIMO	5530	Type6	27	1	333.3	9	0.3333	300	5368	1
11ac80MIMO	5530	Type6	27	1	333.3	9	0.3333	300	5491	1
11ac80MIMO	5530	Type6	27	1	333.3	9	0.3333	300	5475	1
11ac80MIMO	5530	Type6	27	1	333.3	9	0.3333	300	5341	1
11ac80MIMO	5530	Type6	27	1	333.3	9	0.3333	300	5580	1
11ac80MIMO	5530	Type6	27	1	333.3	9	0.3333	300	5318	1
11ac80MIMO	5530	Type6	27	1	333.3	9	0.3333	300	5281	1
11ac80MIMO	5530	Type6	27	1	333.3	9	0.3333	300	5380	1
11ac80MIMO	5530	Type6	27	1	333.3	9	0.3333	300	5519	1
11ac80MIMO	5530	Type6	27	1	333.3	9	0.3333	300	5537	1
11ac80MIMO	5530	Type6	27	1	333.3	9	0.3333	300	5362	1
11ac80MIMO	5530	Type6	27	1	333.3	9	0.3333	300	5645	1
11ac80MIMO	5530	Type6	27	1	333.3	9	0.3333	300	5524	1
11ac80MIMO	5530	Type6	27	1	333.3	9	0.3333	300	5325	1
11ac40MIMO	5510	Type6	27	1	333.3	9	0.3333	300	5492	1
11ac40MIMO	5510	Type6	27	1	333.3	9	0.3333	300	5714	1



Unless otherwise agreed in writing, this document is issued by the Company subject to its General Conditions of Service printed overleaf, available on request or accessible at <http://www.sgs.com/en/Terms-and-Conditions.aspx> and, for electronic format documents, subject to Terms and Conditions for Electronic Documents at <http://www.sgs.com/en/Terms-and-Conditions/Terms-e-Documents.aspx>. Attention is drawn to the limitation of liability, indemnification and jurisdiction issues defined therein. Any holder of this document is advised that information contained herein reflects the Company's findings at the time of its intervention only and within the limits of Client's instructions, if any. The Company's sole responsibility is to its Client and this document does not exonerate parties to a transaction from exercising all their rights and obligations under the transaction documents. This document cannot be reproduced except in full, without prior written approval of the Company. Any unauthorized alteration, forgery or falsification of the content or appearance of this document is unlawful and offenders may be prosecuted to the fullest extent of the law. Unless otherwise stated the results shown in this test report refer only to the sample(s) tested and such sample(s) are retained for 30 days only.

Attention: To check the authenticity of testing inspection report & certificate, please contact us at telephone: (86-755) 8307 1443, or email: CN\_Doccheck@sgs.com

SGS-CSTC Standards Technical Services (Xi'an) Co., Ltd. | 1/F Unit D, Building 1, Kanglong Orange Science Park, No.137, Keyuan 3rd Road, Fengyang New Town, Xian, Shaanxi, China | 710086 | t (86-29) 6282 7885 | www.sgs.com.cn  
 中国·西安·沣东新城科里三路137号康隆橙方科技园1号楼D单元1层 | 邮编: 710086 | t (86-29) 6282 7885 | sgs.china@sgs.com

11ac40MIMO	5510	Type6	27	1	333.3	9	0.3333	300	5506	1
11ac40MIMO	5510	Type6	27	1	333.3	9	0.3333	300	5389	1
11ac40MIMO	5510	Type6	27	1	333.3	9	0.3333	300	5625	1
11ac40MIMO	5510	Type6	27	1	333.3	9	0.3333	300	5700	1
11ac40MIMO	5510	Type6	27	1	333.3	9	0.3333	300	5543	1
11ac40MIMO	5510	Type6	27	1	333.3	9	0.3333	300	5285	1
11ac40MIMO	5510	Type6	27	1	333.3	9	0.3333	300	5522	1
11ac40MIMO	5510	Type6	27	1	333.3	9	0.3333	300	5382	1
11ac40MIMO	5510	Type6	27	1	333.3	9	0.3333	300	5364	1
11ac40MIMO	5510	Type6	27	1	333.3	9	0.3333	300	5521	1
11ac40MIMO	5510	Type6	27	1	333.3	9	0.3333	300	5265	1
11ac40MIMO	5510	Type6	27	1	333.3	9	0.3333	300	5477	1
11ac40MIMO	5510	Type6	27	1	333.3	9	0.3333	300	5680	1
11ac40MIMO	5510	Type6	27	1	333.3	9	0.3333	300	5418	1
11ac40MIMO	5510	Type6	27	1	333.3	9	0.3333	300	5635	1
11ac40MIMO	5510	Type6	27	1	333.3	9	0.3333	300	5692	1
11ac40MIMO	5510	Type6	27	1	333.3	9	0.3333	300	5327	1
11ac40MIMO	5510	Type6	27	1	333.3	9	0.3333	300	5454	1
11ac40MIMO	5510	Type6	27	1	333.3	9	0.3333	300	5586	1
11ac40MIMO	5510	Type6	27	1	333.3	9	0.3333	300	5567	1
11ac40MIMO	5510	Type6	27	1	333.3	9	0.3333	300	5498	1
11ac40MIMO	5510	Type6	27	1	333.3	9	0.3333	300	5254	1
11ac40MIMO	5510	Type6	27	1	333.3	9	0.3333	300	5299	1
11ac40MIMO	5510	Type6	27	1	333.3	9	0.3333	300	5627	1
11ac40MIMO	5510	Type6	27	1	333.3	9	0.3333	300	5594	1
11ac40MIMO	5510	Type6	27	1	333.3	9	0.3333	300	5590	1
11ac40MIMO	5510	Type6	27	1	333.3	9	0.3333	300	5448	1
11ac40MIMO	5510	Type6	27	1	333.3	9	0.3333	300	5642	1
11ac40MIMO	5510	Type6	27	1	333.3	9	0.3333	300	5661	1
11ac40MIMO	5510	Type6	27	1	333.3	9	0.3333	300	5564	1
11ac40MIMO	5510	Type6	27	1	333.3	9	0.3333	300	5541	1
11ac40MIMO	5510	Type6	27	1	333.3	9	0.3333	300	5629	1
11ac40MIMO	5510	Type6	27	1	333.3	9	0.3333	300	5369	1
11ac40MIMO	5510	Type6	27	1	333.3	9	0.3333	300	5324	1
11ac40MIMO	5510	Type6	27	1	333.3	9	0.3333	300	5584	1
11ac40MIMO	5510	Type6	27	1	333.3	9	0.3333	300	5588	1
11ac40MIMO	5510	Type6	27	1	333.3	9	0.3333	300	5280	1
11ac40MIMO	5510	Type6	27	1	333.3	9	0.3333	300	5614	1
11ac40MIMO	5510	Type6	27	1	333.3	9	0.3333	300	5453	1
11ac40MIMO	5510	Type6	27	1	333.3	9	0.3333	300	5565	1
11ac40MIMO	5510	Type6	27	1	333.3	9	0.3333	300	5605	1
11ac40MIMO	5510	Type6	27	1	333.3	9	0.3333	300	5570	1
11ac40MIMO	5510	Type6	27	1	333.3	9	0.3333	300	5291	1
11ac40MIMO	5510	Type6	27	1	333.3	9	0.3333	300	5631	1
11ac40MIMO	5510	Type6	27	1	333.3	9	0.3333	300	5371	1
11ac40MIMO	5510	Type6	27	1	333.3	9	0.3333	300	5589	1
11ac40MIMO	5510	Type6	27	1	333.3	9	0.3333	300	5534	1
11ac40MIMO	5510	Type6	27	1	333.3	9	0.3333	300	5273	1
11ac40MIMO	5510	Type6	27	1	333.3	9	0.3333	300	5690	1
11ac40MIMO	5510	Type6	27	1	333.3	9	0.3333	300	5494	1
11ac40MIMO	5510	Type6	27	1	333.3	9	0.3333	300	5355	1
11ac40MIMO	5510	Type6	27	1	333.3	9	0.3333	300	5482	1
11ac40MIMO	5510	Type6	27	1	333.3	9	0.3333	300	5707	1



Unless otherwise agreed in writing, this document is issued by the Company subject to its General Conditions of Service printed overleaf, available on request or accessible at <http://www.sgs.com/en/Terms-and-Conditions.aspx> and, for electronic format documents, subject to Terms and Conditions for Electronic Documents at <http://www.sgs.com/en/Terms-and-Conditions/Terms-e-Document.aspx>. Attention is drawn to the limitation of liability, indemnification and jurisdiction issues defined therein. Any holder of this document is advised that information contained herein reflects the Company's findings at the time of its intervention only and within the limits of Client's instructions, if any. The Company's sole responsibility is to its Client and this document does not exonerate parties to a transaction from exercising all their rights and obligations under the transaction documents. This document cannot be reproduced except in full, without prior written approval of the Company. Any unauthorized alteration, forgery or falsification of the content or appearance of this document is unlawful and offenders may be prosecuted to the fullest extent of the law. Unless otherwise stated the results shown in this test report refer only to the sample(s) tested and such sample(s) are retained for 30 days only.

Attention: To check the authenticity of testing inspection report & certificate, please contact us at telephone: (86-755) 8307 1443, or email: [CN.Doccheck@sgs.com](mailto:CN.Doccheck@sgs.com)  
 (E) Unit D, Building 1, Kanglong Orange Science Park, No.157, Keyuan 3rd Road, Fengyang New Town, Xi'an, Shaanxi, China 710086  
 t (86-29) 6282 7885 www.sgs.com.cn  
 中国·西安·沣东新城科里三路157号康隆橙方科技园1号楼D单元1层 邮编: 710086 t (86-29) 6282 7885 sgs.china@sgs.com

11ac40MIMO	5510	Type6	27	1	333.3	9	0.3333	300	5641	1
11ac40MIMO	5510	Type6	27	1	333.3	9	0.3333	300	5513	1
11ac40MIMO	5510	Type6	27	1	333.3	9	0.3333	300	5657	1
11ac40MIMO	5510	Type6	27	1	333.3	9	0.3333	300	5659	1
11ac40MIMO	5510	Type6	27	1	333.3	9	0.3333	300	5544	1
11ac40MIMO	5510	Type6	27	1	333.3	9	0.3333	300	5486	1
11ac40MIMO	5510	Type6	27	1	333.3	9	0.3333	300	5426	1
11ac40MIMO	5510	Type6	27	1	333.3	9	0.3333	300	5638	1
11ac40MIMO	5510	Type6	27	1	333.3	9	0.3333	300	5611	1
11ac40MIMO	5510	Type6	27	1	333.3	9	0.3333	300	5516	1
11ac40MIMO	5510	Type6	27	1	333.3	9	0.3333	300	5618	1
11ac40MIMO	5510	Type6	27	1	333.3	9	0.3333	300	5684	1
11ac40MIMO	5510	Type6	27	1	333.3	9	0.3333	300	5464	1
11ac40MIMO	5510	Type6	27	1	333.3	9	0.3333	300	5697	1
11ac40MIMO	5510	Type6	27	1	333.3	9	0.3333	300	5658	1
11ac40MIMO	5510	Type6	27	1	333.3	9	0.3333	300	5374	1
11ac40MIMO	5510	Type6	27	1	333.3	9	0.3333	300	5420	1
11ac40MIMO	5510	Type6	27	1	333.3	9	0.3333	300	5258	1
11ac40MIMO	5510	Type6	27	1	333.3	9	0.3333	300	5721	1
11ac40MIMO	5510	Type6	27	1	333.3	9	0.3333	300	5566	1
11ac40MIMO	5510	Type6	27	1	333.3	9	0.3333	300	5681	1
11ac40MIMO	5510	Type6	27	1	333.3	9	0.3333	300	5358	1
11ac40MIMO	5510	Type6	27	1	333.3	9	0.3333	300	5262	1
11ac40MIMO	5510	Type6	27	1	333.3	9	0.3333	300	5696	1
11ac40MIMO	5510	Type6	27	1	333.3	9	0.3333	300	5297	1
11ac40MIMO	5510	Type6	27	1	333.3	9	0.3333	300	5621	1
11ac40MIMO	5510	Type6	27	1	333.3	9	0.3333	300	5709	1
11ac40MIMO	5510	Type6	27	1	333.3	9	0.3333	300	5439	1
11ac40MIMO	5510	Type6	27	1	333.3	9	0.3333	300	5672	1
11ac40MIMO	5510	Type6	27	1	333.3	9	0.3333	300	5304	1
11ac40MIMO	5510	Type6	27	1	333.3	9	0.3333	300	5616	1
11ac40MIMO	5510	Type6	27	1	333.3	9	0.3333	300	5368	1
11ac40MIMO	5510	Type6	27	1	333.3	9	0.3333	300	5491	1
11ac40MIMO	5510	Type6	27	1	333.3	9	0.3333	300	5475	1
11ac40MIMO	5510	Type6	27	1	333.3	9	0.3333	300	5341	1
11ac40MIMO	5510	Type6	27	1	333.3	9	0.3333	300	5580	1
11ac40MIMO	5510	Type6	27	1	333.3	9	0.3333	300	5318	1
11ac40MIMO	5510	Type6	27	1	333.3	9	0.3333	300	5281	1
11ac40MIMO	5510	Type6	27	1	333.3	9	0.3333	300	5380	1
11ac40MIMO	5510	Type6	27	1	333.3	9	0.3333	300	5519	1
11ac40MIMO	5510	Type6	27	1	333.3	9	0.3333	300	5537	1
11ac40MIMO	5510	Type6	27	1	333.3	9	0.3333	300	5362	1
11ac40MIMO	5510	Type6	27	1	333.3	9	0.3333	300	5645	1
11ac40MIMO	5510	Type6	27	1	333.3	9	0.3333	300	5524	1
11ac40MIMO	5510	Type6	27	1	333.3	9	0.3333	300	5325	1
11ac20MIMO	5500	Type6	27	1	333.3	9	0.3333	300	5492	1
11ac20MIMO	5500	Type6	27	1	333.3	9	0.3333	300	5714	1
11ac20MIMO	5500	Type6	27	1	333.3	9	0.3333	300	5506	1
11ac20MIMO	5500	Type6	27	1	333.3	9	0.3333	300	5389	1
11ac20MIMO	5500	Type6	27	1	333.3	9	0.3333	300	5625	1
11ac20MIMO	5500	Type6	27	1	333.3	9	0.3333	300	5700	1
11ac20MIMO	5500	Type6	27	1	333.3	9	0.3333	300	5543	1
11ac20MIMO	5500	Type6	27	1	333.3	9	0.3333	300	5285	1



Unless otherwise agreed in writing, this document is issued by the Company subject to its General Conditions of Service printed overleaf, available on request or accessible at <http://www.sgs.com/en/Terms-and-Conditions.aspx> and, for electronic format documents, subject to Terms and Conditions for Electronic Documents at <http://www.sgs.com/en/Terms-and-Conditions/Terms-e-Documents.aspx>. Attention is drawn to the limitation of liability, indemnification and jurisdiction issues defined therein. Any holder of this document is advised that information contained herein reflects the Company's findings at the time of its intervention only and within the limits of Client's instructions, if any. The Company's sole responsibility is to its Client and this document does not exonerate parties to a transaction from exercising all their rights and obligations under the transaction documents. This document cannot be reproduced except in full, without prior written approval of the Company. Any unauthorized alteration, forgery or falsification of the content or appearance of this document is unlawful and offenders may be prosecuted to the fullest extent of the law. Unless otherwise stated the results shown in this test report refer only to the sample(s) tested and such sample(s) are retained for 30 days only.

Attention: To check the authenticity of testing/inspection report & certificate, please contact us at telephone: (86-755) 8307 1443, or email: [CN.Doccheck@sgs.com](mailto:CN.Doccheck@sgs.com)

SGS-CSTC Standards Technical Services (Xi'an) Co., Ltd. | 1/F Unit D, Building 1, Kanglong Orange Science Park, No.157, Keyuan 3rd Road, Fengyang New Town, Xian, Shaanxi, China | 710086 | t (86-29) 6282 7885 | [www.sgs.com](http://www.sgs.com)  
 中国·西安·沣东新城科里三路157号康隆橙方科技园1号楼D单元1层 | 邮编: 710086 | t (86-29) 6282 7885 | [sgs.china@sgs.com](mailto:sgs.china@sgs.com)

11ac20MIMO	5500	Type6	27	1	333.3	9	0.3333	300	5522	1
11ac20MIMO	5500	Type6	27	1	333.3	9	0.3333	300	5382	1
11ac20MIMO	5500	Type6	27	1	333.3	9	0.3333	300	5364	1
11ac20MIMO	5500	Type6	27	1	333.3	9	0.3333	300	5521	1
11ac20MIMO	5500	Type6	27	1	333.3	9	0.3333	300	5265	1
11ac20MIMO	5500	Type6	27	1	333.3	9	0.3333	300	5477	1
11ac20MIMO	5500	Type6	27	1	333.3	9	0.3333	300	5680	1
11ac20MIMO	5500	Type6	27	1	333.3	9	0.3333	300	5418	1
11ac20MIMO	5500	Type6	27	1	333.3	9	0.3333	300	5635	1
11ac20MIMO	5500	Type6	27	1	333.3	9	0.3333	300	5692	1
11ac20MIMO	5500	Type6	27	1	333.3	9	0.3333	300	5327	1
11ac20MIMO	5500	Type6	27	1	333.3	9	0.3333	300	5454	1
11ac20MIMO	5500	Type6	27	1	333.3	9	0.3333	300	5586	1
11ac20MIMO	5500	Type6	27	1	333.3	9	0.3333	300	5567	1
11ac20MIMO	5500	Type6	27	1	333.3	9	0.3333	300	5498	1
11ac20MIMO	5500	Type6	27	1	333.3	9	0.3333	300	5254	1
11ac20MIMO	5500	Type6	27	1	333.3	9	0.3333	300	5299	1
11ac20MIMO	5500	Type6	27	1	333.3	9	0.3333	300	5627	1
11ac20MIMO	5500	Type6	27	1	333.3	9	0.3333	300	5594	1
11ac20MIMO	5500	Type6	27	1	333.3	9	0.3333	300	5590	1
11ac20MIMO	5500	Type6	27	1	333.3	9	0.3333	300	5448	1
11ac20MIMO	5500	Type6	27	1	333.3	9	0.3333	300	5642	1
11ac20MIMO	5500	Type6	27	1	333.3	9	0.3333	300	5661	1
11ac20MIMO	5500	Type6	27	1	333.3	9	0.3333	300	5564	1
11ac20MIMO	5500	Type6	27	1	333.3	9	0.3333	300	5541	1
11ac20MIMO	5500	Type6	27	1	333.3	9	0.3333	300	5629	1
11ac20MIMO	5500	Type6	27	1	333.3	9	0.3333	300	5369	1
11ac20MIMO	5500	Type6	27	1	333.3	9	0.3333	300	5324	1
11ac20MIMO	5500	Type6	27	1	333.3	9	0.3333	300	5584	1
11ac20MIMO	5500	Type6	27	1	333.3	9	0.3333	300	5588	1
11ac20MIMO	5500	Type6	27	1	333.3	9	0.3333	300	5280	1
11ac20MIMO	5500	Type6	27	1	333.3	9	0.3333	300	5614	1
11ac20MIMO	5500	Type6	27	1	333.3	9	0.3333	300	5453	1
11ac20MIMO	5500	Type6	27	1	333.3	9	0.3333	300	5565	1
11ac20MIMO	5500	Type6	27	1	333.3	9	0.3333	300	5605	1
11ac20MIMO	5500	Type6	27	1	333.3	9	0.3333	300	5570	1
11ac20MIMO	5500	Type6	27	1	333.3	9	0.3333	300	5291	1
11ac20MIMO	5500	Type6	27	1	333.3	9	0.3333	300	5631	1
11ac20MIMO	5500	Type6	27	1	333.3	9	0.3333	300	5371	1
11ac20MIMO	5500	Type6	27	1	333.3	9	0.3333	300	5589	1
11ac20MIMO	5500	Type6	27	1	333.3	9	0.3333	300	5534	1
11ac20MIMO	5500	Type6	27	1	333.3	9	0.3333	300	5273	1
11ac20MIMO	5500	Type6	27	1	333.3	9	0.3333	300	5690	1
11ac20MIMO	5500	Type6	27	1	333.3	9	0.3333	300	5494	1
11ac20MIMO	5500	Type6	27	1	333.3	9	0.3333	300	5355	1
11ac20MIMO	5500	Type6	27	1	333.3	9	0.3333	300	5482	1
11ac20MIMO	5500	Type6	27	1	333.3	9	0.3333	300	5707	1
11ac20MIMO	5500	Type6	27	1	333.3	9	0.3333	300	5641	1
11ac20MIMO	5500	Type6	27	1	333.3	9	0.3333	300	5513	1
11ac20MIMO	5500	Type6	27	1	333.3	9	0.3333	300	5657	1
11ac20MIMO	5500	Type6	27	1	333.3	9	0.3333	300	5659	1
11ac20MIMO	5500	Type6	27	1	333.3	9	0.3333	300	5544	1
11ac20MIMO	5500	Type6	27	1	333.3	9	0.3333	300	5486	1



Unless otherwise agreed in writing, this document is issued by the Company subject to its General Conditions of Service printed overleaf, available on request or accessible at <http://www.sgs.com/en/Terms-and-Conditions.aspx> and, for electronic format documents, subject to Terms and Conditions for Electronic Documents at <http://www.sgs.com/en/Terms-and-Conditions/Terms-e-Documents.aspx>. Attention is drawn to the limitation of liability, indemnification and jurisdiction issues defined therein. Any holder of this document is advised that information contained herein reflects the Company's findings at the time of its intervention only and within the limits of Client's instructions, if any. The Company's sole responsibility is to its Client and this document does not exonerate parties to a transaction from exercising all their rights and obligations under the transaction documents. This document cannot be reproduced except in full, without prior written approval of the Company. Any unauthorized alteration, forgery or falsification of the content or appearance of this document is unlawful and offenders may be prosecuted to the fullest extent of the law. Unless otherwise stated the results shown in this test report refer only to the sample(s) tested and such sample(s) are retained for 30 days only.

Attention: To check the authenticity of testing/inspection report & certificate, please contact us at telephone: (86-755) 8307 1443, or email: [CN.Doccheck@sgs.com](mailto:CN.Doccheck@sgs.com)

SGS-CSTC Standards Technical Services (Xi'an) Co., Ltd. | 1/F Unit D, Building 1, Kanglong Orange Science Park, No.137, Keyuan 3rd Road, Fengling New Town, Xi'an, Shaanxi, China | 710086 | t (86-29) 6282 7885 | [www.sgs.com](http://www.sgs.com)  
 中国·西安·沣东新城科里三路137号康隆橙方科技园1号楼D单元1层 | 邮编: 710086 | t (86-29) 6282 7885 | [sgs.china@sgs.com](mailto:sgs.china@sgs.com)

Report No.: XEWA2310000070RG05

Rev.: 01

Page: 255 of 267

11ac20MIMO	5500	Type6	27	1	333.3	9	0.3333	300	5426	1
11ac20MIMO	5500	Type6	27	1	333.3	9	0.3333	300	5638	1
11ac20MIMO	5500	Type6	27	1	333.3	9	0.3333	300	5611	1
11ac20MIMO	5500	Type6	27	1	333.3	9	0.3333	300	5516	1
11ac20MIMO	5500	Type6	27	1	333.3	9	0.3333	300	5618	1
11ac20MIMO	5500	Type6	27	1	333.3	9	0.3333	300	5684	1
11ac20MIMO	5500	Type6	27	1	333.3	9	0.3333	300	5464	1
11ac20MIMO	5500	Type6	27	1	333.3	9	0.3333	300	5697	1
11ac20MIMO	5500	Type6	27	1	333.3	9	0.3333	300	5658	1
11ac20MIMO	5500	Type6	27	1	333.3	9	0.3333	300	5374	1
11ac20MIMO	5500	Type6	27	1	333.3	9	0.3333	300	5420	1
11ac20MIMO	5500	Type6	27	1	333.3	9	0.3333	300	5258	1
11ac20MIMO	5500	Type6	27	1	333.3	9	0.3333	300	5721	1
11ac20MIMO	5500	Type6	27	1	333.3	9	0.3333	300	5566	1
11ac20MIMO	5500	Type6	27	1	333.3	9	0.3333	300	5681	1
11ac20MIMO	5500	Type6	27	1	333.3	9	0.3333	300	5358	1
11ac20MIMO	5500	Type6	27	1	333.3	9	0.3333	300	5262	1
11ac20MIMO	5500	Type6	27	1	333.3	9	0.3333	300	5696	1
11ac20MIMO	5500	Type6	27	1	333.3	9	0.3333	300	5297	1
11ac20MIMO	5500	Type6	27	1	333.3	9	0.3333	300	5621	1
11ac20MIMO	5500	Type6	27	1	333.3	9	0.3333	300	5709	1
11ac20MIMO	5500	Type6	27	1	333.3	9	0.3333	300	5439	1
11ac20MIMO	5500	Type6	27	1	333.3	9	0.3333	300	5672	1
11ac20MIMO	5500	Type6	27	1	333.3	9	0.3333	300	5304	1
11ac20MIMO	5500	Type6	27	1	333.3	9	0.3333	300	5616	1
11ac20MIMO	5500	Type6	27	1	333.3	9	0.3333	300	5368	1
11ac20MIMO	5500	Type6	27	1	333.3	9	0.3333	300	5491	1
11ac20MIMO	5500	Type6	27	1	333.3	9	0.3333	300	5475	1
11ac20MIMO	5500	Type6	27	1	333.3	9	0.3333	300	5341	1
11ac20MIMO	5500	Type6	27	1	333.3	9	0.3333	300	5580	1
11ac20MIMO	5500	Type6	27	1	333.3	9	0.3333	300	5318	1
11ac20MIMO	5500	Type6	27	1	333.3	9	0.3333	300	5281	1
11ac20MIMO	5500	Type6	27	1	333.3	9	0.3333	300	5380	1
11ac20MIMO	5500	Type6	27	1	333.3	9	0.3333	300	5519	1
11ac20MIMO	5500	Type6	27	1	333.3	9	0.3333	300	5537	1
11ac20MIMO	5500	Type6	27	1	333.3	9	0.3333	300	5362	1
11ac20MIMO	5500	Type6	27	1	333.3	9	0.3333	300	5645	1
11ac20MIMO	5500	Type6	27	1	333.3	9	0.3333	300	5524	1
11ac20MIMO	5500	Type6	27	1	333.3	9	0.3333	300	5325	1



Unless otherwise agreed in writing, this document is issued by the Company subject to its General Conditions of Service printed overleaf, available on request or accessible at <http://www.sgs.com/en/Terms-and-Conditions.aspx> and, for electronic format documents, subject to Terms and Conditions for Electronic Documents at <http://www.sgs.com/en/Terms-and-Conditions/Terms-e-Documents.aspx>. Attention is drawn to the limitation of liability, indemnification and jurisdiction issues defined therein. Any holder of this document is advised that information contained herein reflects the Company's findings at the time of its intervention only and within the limits of Client's instructions, if any. The Company's sole responsibility is to its Client and this document does not exonerate parties to a transaction from exercising all their rights and obligations under the transaction documents. This document cannot be reproduced except in full, without prior written approval of the Company. Any unauthorized alteration, forgery or falsification of the content or appearance of this document is unlawful and offenders may be prosecuted to the fullest extent of the law. Unless otherwise stated the results shown in this test report refer only to the sample(s) tested and such sample(s) are retained for 30 days only.

Attention: To check the authenticity of testing/inspection report & certificate, please contact us at telephone: (86-755) 4307 1443, or email: [CN.Doccheck@sgs.com](mailto:CN.Doccheck@sgs.com)  
 (SGS-CSTC) Standards Technical Services (Xi'an) Co., Ltd. | 1/E Unit D, Building 1, Kanghong Orange Source Park, No.137, Kejian 3rd Road, Fengling New Town, Xi'an, Shaanxi, China | 710086 | t: (86-29) 6282 7885 | www.sgs.com.cn  
 中国·西安·沣东新城科里三路137号康鸿橙方科技园1号楼D单元1层 | 邮编: 710086 | t: (86-29) 6282 7885 | sgs.china@sgs.com

TestMode	Channel	Radar Type	Trial ID	Pulse width (μs)	PRI (μs)	Pulses per Hop	Hop Rate (kHz)	Hop Sequence Length(ms)	Center Frequency (MHz)	Detection (1: Yes; 0: No)
11ac80MIMO	5530	Type6	28	1	333.3	9	0.3333	300	5272	1
11ac80MIMO	5530	Type6	28	1	333.3	9	0.3333	300	5478	1
11ac80MIMO	5530	Type6	28	1	333.3	9	0.3333	300	5539	1
11ac80MIMO	5530	Type6	28	1	333.3	9	0.3333	300	5550	1
11ac80MIMO	5530	Type6	28	1	333.3	9	0.3333	300	5370	1
11ac80MIMO	5530	Type6	28	1	333.3	9	0.3333	300	5267	1
11ac80MIMO	5530	Type6	28	1	333.3	9	0.3333	300	5565	1
11ac80MIMO	5530	Type6	28	1	333.3	9	0.3333	300	5360	1
11ac80MIMO	5530	Type6	28	1	333.3	9	0.3333	300	5588	1
11ac80MIMO	5530	Type6	28	1	333.3	9	0.3333	300	5589	1
11ac80MIMO	5530	Type6	28	1	333.3	9	0.3333	300	5295	1
11ac80MIMO	5530	Type6	28	1	333.3	9	0.3333	300	5310	1
11ac80MIMO	5530	Type6	28	1	333.3	9	0.3333	300	5306	1
11ac80MIMO	5530	Type6	28	1	333.3	9	0.3333	300	5672	1
11ac80MIMO	5530	Type6	28	1	333.3	9	0.3333	300	5701	1
11ac80MIMO	5530	Type6	28	1	333.3	9	0.3333	300	5506	1
11ac80MIMO	5530	Type6	28	1	333.3	9	0.3333	300	5287	1
11ac80MIMO	5530	Type6	28	1	333.3	9	0.3333	300	5320	1
11ac80MIMO	5530	Type6	28	1	333.3	9	0.3333	300	5491	1
11ac80MIMO	5530	Type6	28	1	333.3	9	0.3333	300	5519	1
11ac80MIMO	5530	Type6	28	1	333.3	9	0.3333	300	5462	1
11ac80MIMO	5530	Type6	28	1	333.3	9	0.3333	300	5655	1
11ac80MIMO	5530	Type6	28	1	333.3	9	0.3333	300	5508	1
11ac80MIMO	5530	Type6	28	1	333.3	9	0.3333	300	5490	1
11ac80MIMO	5530	Type6	28	1	333.3	9	0.3333	300	5702	1
11ac80MIMO	5530	Type6	28	1	333.3	9	0.3333	300	5531	1
11ac80MIMO	5530	Type6	28	1	333.3	9	0.3333	300	5626	1
11ac80MIMO	5530	Type6	28	1	333.3	9	0.3333	300	5355	1
11ac80MIMO	5530	Type6	28	1	333.3	9	0.3333	300	5698	1
11ac80MIMO	5530	Type6	28	1	333.3	9	0.3333	300	5624	1
11ac80MIMO	5530	Type6	28	1	333.3	9	0.3333	300	5717	1
11ac80MIMO	5530	Type6	28	1	333.3	9	0.3333	300	5401	1
11ac80MIMO	5530	Type6	28	1	333.3	9	0.3333	300	5716	1
11ac80MIMO	5530	Type6	28	1	333.3	9	0.3333	300	5264	1
11ac80MIMO	5530	Type6	28	1	333.3	9	0.3333	300	5293	1
11ac80MIMO	5530	Type6	28	1	333.3	9	0.3333	300	5557	1
11ac80MIMO	5530	Type6	28	1	333.3	9	0.3333	300	5692	1
11ac80MIMO	5530	Type6	28	1	333.3	9	0.3333	300	5262	1
11ac80MIMO	5530	Type6	28	1	333.3	9	0.3333	300	5502	1
11ac80MIMO	5530	Type6	28	1	333.3	9	0.3333	300	5594	1
11ac80MIMO	5530	Type6	28	1	333.3	9	0.3333	300	5319	1
11ac80MIMO	5530	Type6	28	1	333.3	9	0.3333	300	5391	1
11ac80MIMO	5530	Type6	28	1	333.3	9	0.3333	300	5330	1
11ac80MIMO	5530	Type6	28	1	333.3	9	0.3333	300	5602	1
11ac80MIMO	5530	Type6	28	1	333.3	9	0.3333	300	5499	1
11ac80MIMO	5530	Type6	28	1	333.3	9	0.3333	300	5271	1
11ac80MIMO	5530	Type6	28	1	333.3	9	0.3333	300	5336	1
11ac80MIMO	5530	Type6	28	1	333.3	9	0.3333	300	5663	1
11ac80MIMO	5530	Type6	28	1	333.3	9	0.3333	300	5424	1



Unless otherwise agreed in writing, this document is issued by the Company subject to its General Conditions of Service printed overleaf, available on request or accessible at <http://www.sgs.com/en/Terms-and-Conditions.aspx> and, for electronic format documents, subject to Terms and Conditions for Electronic Documents at <http://www.sgs.com/en/Terms-and-Conditions/Terms-e-Documents.aspx>. Attention is drawn to the limitation of liability, indemnification and jurisdiction issues defined therein. Any holder of this document is advised that information contained herein reflects the Company's findings at the time of its intervention only and within the limits of Client's instructions, if any. The Company's sole responsibility is to its Client and this document does not exonerate parties to a transaction from exercising all their rights and obligations under the transaction documents. This document cannot be reproduced except in full, without prior written approval of the Company. Any unauthorized alteration, forgery or falsification of the content or appearance of this document is unlawful and offenders may be prosecuted to the fullest extent of the law. Unless otherwise stated the results shown in this test report refer only to the sample(s) tested and such sample(s) are retained for 30 days only.

Attention: To check the authenticity of testing/inspection report & certificate, please contact us at telephone: (86-755) 8307 1443, or email: [CN.Doccheck@sgs.com](mailto:CN.Doccheck@sgs.com)

SGS-CSTC Standards Technical Services (Xi'an) Co., Ltd. | 1/E Unit D Building 1, Kanglong Orange Science Park, No.157, Keyuan 3rd Road, Fengjing/Yue Town, Xi'an, Shaanxi, China | 710086 | t (86-29) 6282 7885 | www.sgs.com.cn  
 中国·西安·沣东新城科里三路157号康鸿橙方科技园1号楼D单元1层 | 邮编: 710086 | t (86-29) 6282 7885 | sgs.china@sgs.com





11ac80MIMO	5530	Type6	28	1	333.3	9	0.3333	300	5476	1
11ac80MIMO	5530	Type6	28	1	333.3	9	0.3333	300	5410	1
11ac80MIMO	5530	Type6	28	1	333.3	9	0.3333	300	5449	1
11ac80MIMO	5530	Type6	28	1	333.3	9	0.3333	300	5266	1
11ac80MIMO	5530	Type6	28	1	333.3	9	0.3333	300	5342	1
11ac80MIMO	5530	Type6	28	1	333.3	9	0.3333	300	5317	1
11ac80MIMO	5530	Type6	28	1	333.3	9	0.3333	300	5299	1
11ac80MIMO	5530	Type6	28	1	333.3	9	0.3333	300	5670	1
11ac80MIMO	5530	Type6	28	1	333.3	9	0.3333	300	5564	1
11ac80MIMO	5530	Type6	28	1	333.3	9	0.3333	300	5463	1
11ac80MIMO	5530	Type6	28	1	333.3	9	0.3333	300	5460	1
11ac80MIMO	5530	Type6	28	1	333.3	9	0.3333	300	5387	1
11ac80MIMO	5530	Type6	28	1	333.3	9	0.3333	300	5311	1
11ac80MIMO	5530	Type6	28	1	333.3	9	0.3333	300	5349	1
11ac80MIMO	5530	Type6	28	1	333.3	9	0.3333	300	5489	1
11ac80MIMO	5530	Type6	28	1	333.3	9	0.3333	300	5415	1
11ac80MIMO	5530	Type6	28	1	333.3	9	0.3333	300	5252	1
11ac80MIMO	5530	Type6	28	1	333.3	9	0.3333	300	5681	1
11ac80MIMO	5530	Type6	28	1	333.3	9	0.3333	300	5687	1
11ac80MIMO	5530	Type6	28	1	333.3	9	0.3333	300	5560	1
11ac80MIMO	5530	Type6	28	1	333.3	9	0.3333	300	5552	1
11ac80MIMO	5530	Type6	28	1	333.3	9	0.3333	300	5353	1
11ac80MIMO	5530	Type6	28	1	333.3	9	0.3333	300	5576	1
11ac80MIMO	5530	Type6	28	1	333.3	9	0.3333	300	5593	1
11ac80MIMO	5530	Type6	28	1	333.3	9	0.3333	300	5683	1
11ac80MIMO	5530	Type6	28	1	333.3	9	0.3333	300	5464	1
11ac80MIMO	5530	Type6	28	1	333.3	9	0.3333	300	5507	1
11ac80MIMO	5530	Type6	28	1	333.3	9	0.3333	300	5350	1
11ac80MIMO	5530	Type6	28	1	333.3	9	0.3333	300	5379	1
11ac80MIMO	5530	Type6	28	1	333.3	9	0.3333	300	5605	1
11ac80MIMO	5530	Type6	28	1	333.3	9	0.3333	300	5366	1
11ac80MIMO	5530	Type6	28	1	333.3	9	0.3333	300	5382	1
11ac80MIMO	5530	Type6	28	1	333.3	9	0.3333	300	5547	1
11ac80MIMO	5530	Type6	28	1	333.3	9	0.3333	300	5361	1
11ac80MIMO	5530	Type6	28	1	333.3	9	0.3333	300	5371	1
11ac80MIMO	5530	Type6	28	1	333.3	9	0.3333	300	5518	1
11ac80MIMO	5530	Type6	28	1	333.3	9	0.3333	300	5385	1
11ac80MIMO	5530	Type6	28	1	333.3	9	0.3333	300	5721	1
11ac80MIMO	5530	Type6	28	1	333.3	9	0.3333	300	5294	1
11ac80MIMO	5530	Type6	28	1	333.3	9	0.3333	300	5341	1
11ac80MIMO	5530	Type6	28	1	333.3	9	0.3333	300	5612	1
11ac80MIMO	5530	Type6	28	1	333.3	9	0.3333	300	5378	1
11ac80MIMO	5530	Type6	28	1	333.3	9	0.3333	300	5621	1
11ac80MIMO	5530	Type6	28	1	333.3	9	0.3333	300	5389	1
11ac80MIMO	5530	Type6	28	1	333.3	9	0.3333	300	5457	1
11ac80MIMO	5530	Type6	28	1	333.3	9	0.3333	300	5292	1
11ac80MIMO	5530	Type6	28	1	333.3	9	0.3333	300	5534	1
11ac80MIMO	5530	Type6	28	1	333.3	9	0.3333	300	5497	1
11ac80MIMO	5530	Type6	28	1	333.3	9	0.3333	300	5412	1
11ac80MIMO	5530	Type6	28	1	333.3	9	0.3333	300	5374	1
11ac80MIMO	5530	Type6	28	1	333.3	9	0.3333	300	5597	1
11ac40MIMO	5510	Type6	28	1	333.3	9	0.3333	300	5272	1
11ac40MIMO	5510	Type6	28	1	333.3	9	0.3333	300	5478	1



Unless otherwise agreed in writing, this document is issued by the Company subject to its General Conditions of Service printed overleaf, available on request or accessible at <http://www.sgs.com/en/Terms-and-Conditions.aspx> and, for electronic format documents, subject to Terms and Conditions for Electronic Documents at <http://www.sgs.com/en/Terms-and-Conditions/Terms-e-Documents.aspx>. Attention is drawn to the limitation of liability, indemnification and jurisdiction issues defined therein. Any holder of this document is advised that information contained herein reflects the Company's findings at the time of its intervention only and within the limits of Client's instructions, if any. The Company's sole responsibility is to its Client and this document does not exonerate parties to a transaction from exercising all their rights and obligations under the transaction documents. This document cannot be reproduced except in full, without prior written approval of the Company. Any unauthorized alteration, forgery or falsification of the content or appearance of this document is unlawful and offenders may be prosecuted to the fullest extent of the law. Unless otherwise stated the results shown in this test report refer only to the sample(s) tested and such sample(s) are retained for 30 days only.

Attention: To check the authenticity of testing/inspection report & certificate, please contact us at telephone: (86-755) 8307 1443, or email: [CN.Doccheck@sgs.com](mailto:CN.Doccheck@sgs.com)  
 (E) Unit D, Building 1, Kanglong Orange Science Park, No.157, Keyuan 3rd Road, Fengjing/Yue Town, Xian, Shaanxi, China 710086 t (86-29) 6282 7885 www.sgs.com.cn  
 中国·西安·沣东新城科里三路157号康隆橙方科技园1号楼D单元1层 邮编: 710086 t (86-29) 6282 7885 sgs.china@sgs.com

11ac40MIMO	5510	Type6	28	1	333.3	9	0.3333	300	5539	1
11ac40MIMO	5510	Type6	28	1	333.3	9	0.3333	300	5550	1
11ac40MIMO	5510	Type6	28	1	333.3	9	0.3333	300	5370	1
11ac40MIMO	5510	Type6	28	1	333.3	9	0.3333	300	5267	1
11ac40MIMO	5510	Type6	28	1	333.3	9	0.3333	300	5565	1
11ac40MIMO	5510	Type6	28	1	333.3	9	0.3333	300	5360	1
11ac40MIMO	5510	Type6	28	1	333.3	9	0.3333	300	5588	1
11ac40MIMO	5510	Type6	28	1	333.3	9	0.3333	300	5589	1
11ac40MIMO	5510	Type6	28	1	333.3	9	0.3333	300	5295	1
11ac40MIMO	5510	Type6	28	1	333.3	9	0.3333	300	5310	1
11ac40MIMO	5510	Type6	28	1	333.3	9	0.3333	300	5306	1
11ac40MIMO	5510	Type6	28	1	333.3	9	0.3333	300	5672	1
11ac40MIMO	5510	Type6	28	1	333.3	9	0.3333	300	5701	1
11ac40MIMO	5510	Type6	28	1	333.3	9	0.3333	300	5506	1
11ac40MIMO	5510	Type6	28	1	333.3	9	0.3333	300	5287	1
11ac40MIMO	5510	Type6	28	1	333.3	9	0.3333	300	5320	1
11ac40MIMO	5510	Type6	28	1	333.3	9	0.3333	300	5491	1
11ac40MIMO	5510	Type6	28	1	333.3	9	0.3333	300	5519	1
11ac40MIMO	5510	Type6	28	1	333.3	9	0.3333	300	5462	1
11ac40MIMO	5510	Type6	28	1	333.3	9	0.3333	300	5655	1
11ac40MIMO	5510	Type6	28	1	333.3	9	0.3333	300	5508	1
11ac40MIMO	5510	Type6	28	1	333.3	9	0.3333	300	5490	1
11ac40MIMO	5510	Type6	28	1	333.3	9	0.3333	300	5702	1
11ac40MIMO	5510	Type6	28	1	333.3	9	0.3333	300	5531	1
11ac40MIMO	5510	Type6	28	1	333.3	9	0.3333	300	5626	1
11ac40MIMO	5510	Type6	28	1	333.3	9	0.3333	300	5355	1
11ac40MIMO	5510	Type6	28	1	333.3	9	0.3333	300	5698	1
11ac40MIMO	5510	Type6	28	1	333.3	9	0.3333	300	5624	1
11ac40MIMO	5510	Type6	28	1	333.3	9	0.3333	300	5717	1
11ac40MIMO	5510	Type6	28	1	333.3	9	0.3333	300	5401	1
11ac40MIMO	5510	Type6	28	1	333.3	9	0.3333	300	5716	1
11ac40MIMO	5510	Type6	28	1	333.3	9	0.3333	300	5264	1
11ac40MIMO	5510	Type6	28	1	333.3	9	0.3333	300	5293	1
11ac40MIMO	5510	Type6	28	1	333.3	9	0.3333	300	5557	1
11ac40MIMO	5510	Type6	28	1	333.3	9	0.3333	300	5692	1
11ac40MIMO	5510	Type6	28	1	333.3	9	0.3333	300	5262	1
11ac40MIMO	5510	Type6	28	1	333.3	9	0.3333	300	5502	1
11ac40MIMO	5510	Type6	28	1	333.3	9	0.3333	300	5594	1
11ac40MIMO	5510	Type6	28	1	333.3	9	0.3333	300	5319	1
11ac40MIMO	5510	Type6	28	1	333.3	9	0.3333	300	5391	1
11ac40MIMO	5510	Type6	28	1	333.3	9	0.3333	300	5330	1
11ac40MIMO	5510	Type6	28	1	333.3	9	0.3333	300	5602	1
11ac40MIMO	5510	Type6	28	1	333.3	9	0.3333	300	5499	1
11ac40MIMO	5510	Type6	28	1	333.3	9	0.3333	300	5271	1
11ac40MIMO	5510	Type6	28	1	333.3	9	0.3333	300	5336	1
11ac40MIMO	5510	Type6	28	1	333.3	9	0.3333	300	5663	1
11ac40MIMO	5510	Type6	28	1	333.3	9	0.3333	300	5424	1
11ac40MIMO	5510	Type6	28	1	333.3	9	0.3333	300	5476	1
11ac40MIMO	5510	Type6	28	1	333.3	9	0.3333	300	5410	1
11ac40MIMO	5510	Type6	28	1	333.3	9	0.3333	300	5449	1
11ac40MIMO	5510	Type6	28	1	333.3	9	0.3333	300	5266	1
11ac40MIMO	5510	Type6	28	1	333.3	9	0.3333	300	5342	1
11ac40MIMO	5510	Type6	28	1	333.3	9	0.3333	300	5317	1



Unless otherwise agreed in writing, this document is issued by the Company subject to its General Conditions of Service printed overleaf, available on request or accessible at <http://www.sgs.com/en/Terms-and-Conditions.aspx> and, for electronic format documents, subject to Terms and Conditions for Electronic Documents at <http://www.sgs.com/en/Terms-and-Conditions/Terms-e-Documents.aspx>. Attention is drawn to the limitation of liability, indemnification and jurisdiction issues defined therein. Any holder of this document is advised that information contained herein reflects the Company's findings at the time of its intervention only and within the limits of Client's instructions, if any. The Company's sole responsibility is to its Client and this document does not exonerate parties to a transaction from exercising all their rights and obligations under the transaction documents. This document cannot be reproduced except in full, without prior written approval of the Company. Any unauthorized alteration, forgery or falsification of the content or appearance of this document is unlawful and offenders may be prosecuted to the fullest extent of the law. Unless otherwise stated the results shown in this test report refer only to the sample(s) tested and such sample(s) are retained for 30 days only.

Attention: To check the authenticity of testing/inspection report & certificate, please contact us at telephone: (86-755) 8307 1443, or email: [CN.Doccheck@sgs.com](mailto:CN.Doccheck@sgs.com)

SGS-CSTC Standards Technical Services (Xi'an) Co., Ltd. | 1/F Unit D, Building 1, Kanglong Orange Science Park, No.157, Keyuan 3rd Road, Fengling New Town, Xian, Shaanxi, China | 710086 | t (86-29) 6282 7885 | [www.sgs.com.cn](http://www.sgs.com.cn)  
 中国·西安·沣东新城科里三路157号康隆橙方科技园1号楼D单元1层 | 邮编: 710086 | t (86-29) 6282 7885 | [sgs.china@sgs.com](mailto:sgs.china@sgs.com)

11ac40MIMO	5510	Type6	28	1	333.3	9	0.3333	300	5299	1
11ac40MIMO	5510	Type6	28	1	333.3	9	0.3333	300	5670	1
11ac40MIMO	5510	Type6	28	1	333.3	9	0.3333	300	5564	1
11ac40MIMO	5510	Type6	28	1	333.3	9	0.3333	300	5463	1
11ac40MIMO	5510	Type6	28	1	333.3	9	0.3333	300	5460	1
11ac40MIMO	5510	Type6	28	1	333.3	9	0.3333	300	5387	1
11ac40MIMO	5510	Type6	28	1	333.3	9	0.3333	300	5311	1
11ac40MIMO	5510	Type6	28	1	333.3	9	0.3333	300	5349	1
11ac40MIMO	5510	Type6	28	1	333.3	9	0.3333	300	5489	1
11ac40MIMO	5510	Type6	28	1	333.3	9	0.3333	300	5415	1
11ac40MIMO	5510	Type6	28	1	333.3	9	0.3333	300	5252	1
11ac40MIMO	5510	Type6	28	1	333.3	9	0.3333	300	5681	1
11ac40MIMO	5510	Type6	28	1	333.3	9	0.3333	300	5687	1
11ac40MIMO	5510	Type6	28	1	333.3	9	0.3333	300	5560	1
11ac40MIMO	5510	Type6	28	1	333.3	9	0.3333	300	5552	1
11ac40MIMO	5510	Type6	28	1	333.3	9	0.3333	300	5353	1
11ac40MIMO	5510	Type6	28	1	333.3	9	0.3333	300	5576	1
11ac40MIMO	5510	Type6	28	1	333.3	9	0.3333	300	5593	1
11ac40MIMO	5510	Type6	28	1	333.3	9	0.3333	300	5683	1
11ac40MIMO	5510	Type6	28	1	333.3	9	0.3333	300	5464	1
11ac40MIMO	5510	Type6	28	1	333.3	9	0.3333	300	5507	1
11ac40MIMO	5510	Type6	28	1	333.3	9	0.3333	300	5350	1
11ac40MIMO	5510	Type6	28	1	333.3	9	0.3333	300	5379	1
11ac40MIMO	5510	Type6	28	1	333.3	9	0.3333	300	5605	1
11ac40MIMO	5510	Type6	28	1	333.3	9	0.3333	300	5366	1
11ac40MIMO	5510	Type6	28	1	333.3	9	0.3333	300	5382	1
11ac40MIMO	5510	Type6	28	1	333.3	9	0.3333	300	5547	1
11ac40MIMO	5510	Type6	28	1	333.3	9	0.3333	300	5361	1
11ac40MIMO	5510	Type6	28	1	333.3	9	0.3333	300	5371	1
11ac40MIMO	5510	Type6	28	1	333.3	9	0.3333	300	5518	1
11ac40MIMO	5510	Type6	28	1	333.3	9	0.3333	300	5385	1
11ac40MIMO	5510	Type6	28	1	333.3	9	0.3333	300	5721	1
11ac40MIMO	5510	Type6	28	1	333.3	9	0.3333	300	5294	1
11ac40MIMO	5510	Type6	28	1	333.3	9	0.3333	300	5341	1
11ac40MIMO	5510	Type6	28	1	333.3	9	0.3333	300	5612	1
11ac40MIMO	5510	Type6	28	1	333.3	9	0.3333	300	5378	1
11ac40MIMO	5510	Type6	28	1	333.3	9	0.3333	300	5621	1
11ac40MIMO	5510	Type6	28	1	333.3	9	0.3333	300	5389	1
11ac40MIMO	5510	Type6	28	1	333.3	9	0.3333	300	5457	1
11ac40MIMO	5510	Type6	28	1	333.3	9	0.3333	300	5292	1
11ac40MIMO	5510	Type6	28	1	333.3	9	0.3333	300	5534	1
11ac40MIMO	5510	Type6	28	1	333.3	9	0.3333	300	5497	1
11ac40MIMO	5510	Type6	28	1	333.3	9	0.3333	300	5412	1
11ac40MIMO	5510	Type6	28	1	333.3	9	0.3333	300	5374	1
11ac40MIMO	5510	Type6	28	1	333.3	9	0.3333	300	5597	1
11ac20MIMO	5500	Type6	28	1	333.3	9	0.3333	300	5272	1
11ac20MIMO	5500	Type6	28	1	333.3	9	0.3333	300	5478	1
11ac20MIMO	5500	Type6	28	1	333.3	9	0.3333	300	5539	1
11ac20MIMO	5500	Type6	28	1	333.3	9	0.3333	300	5550	1
11ac20MIMO	5500	Type6	28	1	333.3	9	0.3333	300	5370	1
11ac20MIMO	5500	Type6	28	1	333.3	9	0.3333	300	5267	1
11ac20MIMO	5500	Type6	28	1	333.3	9	0.3333	300	5565	1
11ac20MIMO	5500	Type6	28	1	333.3	9	0.3333	300	5360	1



Unless otherwise agreed in writing, this document is issued by the Company subject to its General Conditions of Service printed overleaf, available on request or accessible at <http://www.sgs.com/en/Terms-and-Conditions.aspx> and, for electronic format documents, subject to Terms and Conditions for Electronic Documents at <http://www.sgs.com/en/Terms-and-Conditions/Terms-e-Documents.aspx>. Attention is drawn to the limitation of liability, indemnification and jurisdiction issues defined therein. Any holder of this document is advised that information contained herein reflects the Company's findings at the time of its intervention only and within the limits of Client's instructions, if any. The Company's sole responsibility is to its Client and this document does not exonerate parties to a transaction from exercising all their rights and obligations under the transaction documents. This document cannot be reproduced except in full, without prior written approval of the Company. Any unauthorized alteration, forgery or falsification of the content or appearance of this document is unlawful and offenders may be prosecuted to the fullest extent of the law. Unless otherwise stated the results shown in this test report refer only to the sample(s) tested and such sample(s) are retained for 30 days only.

Attention: To check the authenticity of testing/inspection report & certificate, please contact us at telephone: (86-755) 8307 1443, or email: [CN.Doccheck@sgs.com](mailto:CN.Doccheck@sgs.com)

SGS-CSTC Standards Technical Services (Xi'an) Co., Ltd. | 1F, Unit D, Building 1, Kanglong Orange Science Park, No.157, Keyuan 3rd Road, Fengyang New Town, Xian, Shaanxi, China | 710086 | t: (86-29) 6282 7885 | [www.sgs.com](http://www.sgs.com)  
 中国·西安·沣东新城科里三路157号康隆橙方科技园1号楼D单元1层 | 邮编: 710086 | t: (86-29) 6282 7885 | [sgs.china@sgs.com](mailto:sgs.china@sgs.com)

11ac20MIMO	5500	Type6	28	1	333.3	9	0.3333	300	5588	1
11ac20MIMO	5500	Type6	28	1	333.3	9	0.3333	300	5589	1
11ac20MIMO	5500	Type6	28	1	333.3	9	0.3333	300	5295	1
11ac20MIMO	5500	Type6	28	1	333.3	9	0.3333	300	5310	1
11ac20MIMO	5500	Type6	28	1	333.3	9	0.3333	300	5306	1
11ac20MIMO	5500	Type6	28	1	333.3	9	0.3333	300	5672	1
11ac20MIMO	5500	Type6	28	1	333.3	9	0.3333	300	5701	1
11ac20MIMO	5500	Type6	28	1	333.3	9	0.3333	300	5506	1
11ac20MIMO	5500	Type6	28	1	333.3	9	0.3333	300	5287	1
11ac20MIMO	5500	Type6	28	1	333.3	9	0.3333	300	5320	1
11ac20MIMO	5500	Type6	28	1	333.3	9	0.3333	300	5491	1
11ac20MIMO	5500	Type6	28	1	333.3	9	0.3333	300	5519	1
11ac20MIMO	5500	Type6	28	1	333.3	9	0.3333	300	5462	1
11ac20MIMO	5500	Type6	28	1	333.3	9	0.3333	300	5655	1
11ac20MIMO	5500	Type6	28	1	333.3	9	0.3333	300	5508	1
11ac20MIMO	5500	Type6	28	1	333.3	9	0.3333	300	5490	1
11ac20MIMO	5500	Type6	28	1	333.3	9	0.3333	300	5702	1
11ac20MIMO	5500	Type6	28	1	333.3	9	0.3333	300	5531	1
11ac20MIMO	5500	Type6	28	1	333.3	9	0.3333	300	5626	1
11ac20MIMO	5500	Type6	28	1	333.3	9	0.3333	300	5355	1
11ac20MIMO	5500	Type6	28	1	333.3	9	0.3333	300	5698	1
11ac20MIMO	5500	Type6	28	1	333.3	9	0.3333	300	5624	1
11ac20MIMO	5500	Type6	28	1	333.3	9	0.3333	300	5717	1
11ac20MIMO	5500	Type6	28	1	333.3	9	0.3333	300	5401	1
11ac20MIMO	5500	Type6	28	1	333.3	9	0.3333	300	5716	1
11ac20MIMO	5500	Type6	28	1	333.3	9	0.3333	300	5264	1
11ac20MIMO	5500	Type6	28	1	333.3	9	0.3333	300	5293	1
11ac20MIMO	5500	Type6	28	1	333.3	9	0.3333	300	5557	1
11ac20MIMO	5500	Type6	28	1	333.3	9	0.3333	300	5692	1
11ac20MIMO	5500	Type6	28	1	333.3	9	0.3333	300	5262	1
11ac20MIMO	5500	Type6	28	1	333.3	9	0.3333	300	5502	1
11ac20MIMO	5500	Type6	28	1	333.3	9	0.3333	300	5594	1
11ac20MIMO	5500	Type6	28	1	333.3	9	0.3333	300	5319	1
11ac20MIMO	5500	Type6	28	1	333.3	9	0.3333	300	5391	1
11ac20MIMO	5500	Type6	28	1	333.3	9	0.3333	300	5330	1
11ac20MIMO	5500	Type6	28	1	333.3	9	0.3333	300	5602	1
11ac20MIMO	5500	Type6	28	1	333.3	9	0.3333	300	5499	1
11ac20MIMO	5500	Type6	28	1	333.3	9	0.3333	300	5271	1
11ac20MIMO	5500	Type6	28	1	333.3	9	0.3333	300	5336	1
11ac20MIMO	5500	Type6	28	1	333.3	9	0.3333	300	5663	1
11ac20MIMO	5500	Type6	28	1	333.3	9	0.3333	300	5424	1
11ac20MIMO	5500	Type6	28	1	333.3	9	0.3333	300	5476	1
11ac20MIMO	5500	Type6	28	1	333.3	9	0.3333	300	5410	1
11ac20MIMO	5500	Type6	28	1	333.3	9	0.3333	300	5449	1
11ac20MIMO	5500	Type6	28	1	333.3	9	0.3333	300	5266	1
11ac20MIMO	5500	Type6	28	1	333.3	9	0.3333	300	5342	1
11ac20MIMO	5500	Type6	28	1	333.3	9	0.3333	300	5317	1
11ac20MIMO	5500	Type6	28	1	333.3	9	0.3333	300	5299	1
11ac20MIMO	5500	Type6	28	1	333.3	9	0.3333	300	5670	1
11ac20MIMO	5500	Type6	28	1	333.3	9	0.3333	300	5564	1
11ac20MIMO	5500	Type6	28	1	333.3	9	0.3333	300	5463	1
11ac20MIMO	5500	Type6	28	1	333.3	9	0.3333	300	5460	1
11ac20MIMO	5500	Type6	28	1	333.3	9	0.3333	300	5387	1



Unless otherwise agreed in writing, this document is issued by the Company subject to its General Conditions of Service printed overleaf, available on request or accessible at <http://www.sgs.com/en/Terms-and-Conditions.aspx> and, for electronic format documents, subject to Terms and Conditions for Electronic Documents at <http://www.sgs.com/en/Terms-and-Conditions/Terms-e-Documents.aspx>. Attention is drawn to the limitation of liability, indemnification and jurisdiction issues defined therein. Any holder of this document is advised that information contained herein reflects the Company's findings at the time of its intervention only and within the limits of Client's instructions, if any. The Company's sole responsibility is to its Client and this document does not exonerate parties to a transaction from exercising all their rights and obligations under the transaction documents. This document cannot be reproduced except in full, without prior written approval of the Company. Any unauthorized alteration, forgery or falsification of the content or appearance of this document is unlawful and offenders may be prosecuted to the fullest extent of the law. Unless otherwise stated the results shown in this test report refer only to the sample(s) tested and such sample(s) are retained for 30 days only.

Attention: To check the authenticity of testing/inspection report & certificate, please contact us at telephone: (86-755) 8307 1443, or email: [CN.Doccheck@sgs.com](mailto:CN.Doccheck@sgs.com)  
 (U) Ltd D Building 1, Kanglong Orange Science Park, No.157, Keyuan 3rd Road, Fengyang New Town, Xian, Shaanxi, China 710086  
 t (86-29) 6282 7885 www.sgs.com.cn  
 中国·西安·沣东新城科里三路157号康鸿橙方科技园1号楼D单元1层 邮编: 710086 t (86-29) 6282 7885 sgs.china@sgs.com

Report No.: XEWA2310000070RG05

Rev.: 01

Page: 261 of 267

11ac20MIMO	5500	Type6	28	1	333.3	9	0.3333	300	5311	1
11ac20MIMO	5500	Type6	28	1	333.3	9	0.3333	300	5349	1
11ac20MIMO	5500	Type6	28	1	333.3	9	0.3333	300	5489	1
11ac20MIMO	5500	Type6	28	1	333.3	9	0.3333	300	5415	1
11ac20MIMO	5500	Type6	28	1	333.3	9	0.3333	300	5252	1
11ac20MIMO	5500	Type6	28	1	333.3	9	0.3333	300	5681	1
11ac20MIMO	5500	Type6	28	1	333.3	9	0.3333	300	5687	1
11ac20MIMO	5500	Type6	28	1	333.3	9	0.3333	300	5560	1
11ac20MIMO	5500	Type6	28	1	333.3	9	0.3333	300	5552	1
11ac20MIMO	5500	Type6	28	1	333.3	9	0.3333	300	5353	1
11ac20MIMO	5500	Type6	28	1	333.3	9	0.3333	300	5576	1
11ac20MIMO	5500	Type6	28	1	333.3	9	0.3333	300	5593	1
11ac20MIMO	5500	Type6	28	1	333.3	9	0.3333	300	5683	1
11ac20MIMO	5500	Type6	28	1	333.3	9	0.3333	300	5464	1
11ac20MIMO	5500	Type6	28	1	333.3	9	0.3333	300	5507	1
11ac20MIMO	5500	Type6	28	1	333.3	9	0.3333	300	5350	1
11ac20MIMO	5500	Type6	28	1	333.3	9	0.3333	300	5379	1
11ac20MIMO	5500	Type6	28	1	333.3	9	0.3333	300	5605	1
11ac20MIMO	5500	Type6	28	1	333.3	9	0.3333	300	5366	1
11ac20MIMO	5500	Type6	28	1	333.3	9	0.3333	300	5382	1
11ac20MIMO	5500	Type6	28	1	333.3	9	0.3333	300	5547	1
11ac20MIMO	5500	Type6	28	1	333.3	9	0.3333	300	5361	1
11ac20MIMO	5500	Type6	28	1	333.3	9	0.3333	300	5371	1
11ac20MIMO	5500	Type6	28	1	333.3	9	0.3333	300	5518	1
11ac20MIMO	5500	Type6	28	1	333.3	9	0.3333	300	5385	1
11ac20MIMO	5500	Type6	28	1	333.3	9	0.3333	300	5721	1
11ac20MIMO	5500	Type6	28	1	333.3	9	0.3333	300	5294	1
11ac20MIMO	5500	Type6	28	1	333.3	9	0.3333	300	5341	1
11ac20MIMO	5500	Type6	28	1	333.3	9	0.3333	300	5612	1
11ac20MIMO	5500	Type6	28	1	333.3	9	0.3333	300	5378	1
11ac20MIMO	5500	Type6	28	1	333.3	9	0.3333	300	5621	1
11ac20MIMO	5500	Type6	28	1	333.3	9	0.3333	300	5389	1
11ac20MIMO	5500	Type6	28	1	333.3	9	0.3333	300	5457	1
11ac20MIMO	5500	Type6	28	1	333.3	9	0.3333	300	5292	1
11ac20MIMO	5500	Type6	28	1	333.3	9	0.3333	300	5534	1
11ac20MIMO	5500	Type6	28	1	333.3	9	0.3333	300	5497	1
11ac20MIMO	5500	Type6	28	1	333.3	9	0.3333	300	5412	1
11ac20MIMO	5500	Type6	28	1	333.3	9	0.3333	300	5374	1
11ac20MIMO	5500	Type6	28	1	333.3	9	0.3333	300	5597	1



Unless otherwise agreed in writing, this document is issued by the Company subject to its General Conditions of Service printed overleaf, available on request or accessible at <http://www.sgs.com/en/Terms-and-Conditions.aspx> and, for electronic format documents, subject to Terms and Conditions for Electronic Documents at <http://www.sgs.com/en/Terms-and-Conditions/Terms-e-Documents.aspx>. Attention is drawn to the limitation of liability, indemnification and jurisdiction issues defined therein. Any holder of this document is advised that information contained herein reflects the Company's findings at the time of its intervention only and within the limits of Client's instructions, if any. The Company's sole responsibility is to its Client and this document does not exonerate parties to a transaction from exercising all their rights and obligations under the transaction documents. This document cannot be reproduced except in full, without prior written approval of the Company. Any unauthorized alteration, forgery or falsification of the content or appearance of this document is unlawful and offenders may be prosecuted to the fullest extent of the law. Unless otherwise stated the results shown in this test report refer only to the sample(s) tested and such sample(s) are retained for 30 days only.

Attention: To check the authenticity of testing/inspection report & certificate, please contact us at telephone: (86-755) 4307 1443, or email: [CN.Doccheck@sgs.com](mailto:CN.Doccheck@sgs.com)  
 1/E Unit D, Building 1, Kanghong Orange Source Park, No.137, Keyuan 3rd Road, Fengyong New Town, Xi'an, Shaanxi, China 710086 t (86-29) 6282 7885 www.sgs.com.cn  
 中国·西安·沣东新城科源三路137号康鸿橙方科技园1号楼D单元1层 邮编: 710086 t (86-29) 6282 7885 sgs.china@sgs.com

TestMode	Channel	Radar Type	Trial ID	Pulse width (μs)	PRI (μs)	Pulses per Hop	Hop Rate (kHz)	Hop Sequence Length(ms)	Center Frequency (MHz)	Detection (1: Yes; 0: No)
11ac80MIMO	5530	Type6	29	1	333.3	9	0.3333	300	5430	1
11ac80MIMO	5530	Type6	29	1	333.3	9	0.3333	300	5717	1
11ac80MIMO	5530	Type6	29	1	333.3	9	0.3333	300	5475	1
11ac80MIMO	5530	Type6	29	1	333.3	9	0.3333	300	5711	1
11ac80MIMO	5530	Type6	29	1	333.3	9	0.3333	300	5687	1
11ac80MIMO	5530	Type6	29	1	333.3	9	0.3333	300	5406	1
11ac80MIMO	5530	Type6	29	1	333.3	9	0.3333	300	5490	1
11ac80MIMO	5530	Type6	29	1	333.3	9	0.3333	300	5435	1
11ac80MIMO	5530	Type6	29	1	333.3	9	0.3333	300	5276	1
11ac80MIMO	5530	Type6	29	1	333.3	9	0.3333	300	5321	1
11ac80MIMO	5530	Type6	29	1	333.3	9	0.3333	300	5604	1
11ac80MIMO	5530	Type6	29	1	333.3	9	0.3333	300	5574	1
11ac80MIMO	5530	Type6	29	1	333.3	9	0.3333	300	5444	1
11ac80MIMO	5530	Type6	29	1	333.3	9	0.3333	300	5295	1
11ac80MIMO	5530	Type6	29	1	333.3	9	0.3333	300	5722	1
11ac80MIMO	5530	Type6	29	1	333.3	9	0.3333	300	5594	1
11ac80MIMO	5530	Type6	29	1	333.3	9	0.3333	300	5414	1
11ac80MIMO	5530	Type6	29	1	333.3	9	0.3333	300	5326	1
11ac80MIMO	5530	Type6	29	1	333.3	9	0.3333	300	5536	1
11ac80MIMO	5530	Type6	29	1	333.3	9	0.3333	300	5373	1
11ac80MIMO	5530	Type6	29	1	333.3	9	0.3333	300	5346	1
11ac80MIMO	5530	Type6	29	1	333.3	9	0.3333	300	5546	1
11ac80MIMO	5530	Type6	29	1	333.3	9	0.3333	300	5579	1
11ac80MIMO	5530	Type6	29	1	333.3	9	0.3333	300	5675	1
11ac80MIMO	5530	Type6	29	1	333.3	9	0.3333	300	5419	1
11ac80MIMO	5530	Type6	29	1	333.3	9	0.3333	300	5478	1
11ac80MIMO	5530	Type6	29	1	333.3	9	0.3333	300	5558	1
11ac80MIMO	5530	Type6	29	1	333.3	9	0.3333	300	5327	1
11ac80MIMO	5530	Type6	29	1	333.3	9	0.3333	300	5658	1
11ac80MIMO	5530	Type6	29	1	333.3	9	0.3333	300	5629	1
11ac80MIMO	5530	Type6	29	1	333.3	9	0.3333	300	5420	1
11ac80MIMO	5530	Type6	29	1	333.3	9	0.3333	300	5674	1
11ac80MIMO	5530	Type6	29	1	333.3	9	0.3333	300	5519	1
11ac80MIMO	5530	Type6	29	1	333.3	9	0.3333	300	5559	1
11ac80MIMO	5530	Type6	29	1	333.3	9	0.3333	300	5432	1
11ac80MIMO	5530	Type6	29	1	333.3	9	0.3333	300	5648	1
11ac80MIMO	5530	Type6	29	1	333.3	9	0.3333	300	5488	1
11ac80MIMO	5530	Type6	29	1	333.3	9	0.3333	300	5512	1
11ac80MIMO	5530	Type6	29	1	333.3	9	0.3333	300	5513	1
11ac80MIMO	5530	Type6	29	1	333.3	9	0.3333	300	5433	1
11ac80MIMO	5530	Type6	29	1	333.3	9	0.3333	300	5402	1
11ac80MIMO	5530	Type6	29	1	333.3	9	0.3333	300	5329	1
11ac80MIMO	5530	Type6	29	1	333.3	9	0.3333	300	5570	1
11ac80MIMO	5530	Type6	29	1	333.3	9	0.3333	300	5599	1
11ac80MIMO	5530	Type6	29	1	333.3	9	0.3333	300	5331	1
11ac80MIMO	5530	Type6	29	1	333.3	9	0.3333	300	5251	1
11ac80MIMO	5530	Type6	29	1	333.3	9	0.3333	300	5624	1
11ac80MIMO	5530	Type6	29	1	333.3	9	0.3333	300	5477	1
11ac80MIMO	5530	Type6	29	1	333.3	9	0.3333	300	5266	1



Unless otherwise agreed in writing, this document is issued by the Company subject to its General Conditions of Service printed overleaf, available on request or accessible at <http://www.sgs.com/en/Terms-and-Conditions.aspx> and, for electronic format documents, subject to Terms and Conditions for Electronic Documents at <http://www.sgs.com/en/Terms-and-Conditions/Terms-e-Documents.aspx>. Attention is drawn to the limitation of liability, indemnification and jurisdiction issues defined therein. Any holder of this document is advised that information contained herein reflects the Company's findings at the time of its intervention only and within the limits of Client's instructions, if any. The Company's sole responsibility is to its Client and this document does not exonerate parties to a transaction from exercising all their rights and obligations under the transaction documents. This document cannot be reproduced except in full, without prior written approval of the Company. Any unauthorized alteration, forgery or falsification of the content or appearance of this document is unlawful and offenders may be prosecuted to the fullest extent of the law. Unless otherwise stated the results shown in this test report refer only to the sample(s) tested and such sample(s) are retained for 30 days only.

Attention: To check the authenticity of testing/inspection report & certificate, please contact us at telephone: (86-755) 8307 1443, or email: [CN.Doccheck@sgs.com](mailto:CN.Doccheck@sgs.com)  
 (SGS-CSTC) Standards Technical Services (Xi'an) Co., Ltd. | 1/E Unit D Building 1, Kanglong Orange Science Park, No.157, Keyuan3rd Road, Fengjing/Yue Town, Xi'an, Shaanxi, China | 710086 | t: (86-29) 6282 7885 | www.sgs.com.cn  
 中国·西安·沣东新城科里三路157号康隆橙方科技园1号楼D单元1层 | 邮编: 710086 | t: (86-29) 6282 7885 | sgs.china@sgs.com



Report No.: XEWA2310000070RG05

Rev.: 01

Page: 263 of 267

11ac80MIMO	5530	Type6	29	1	333.3	9	0.3333	300	5286	1
11ac80MIMO	5530	Type6	29	1	333.3	9	0.3333	300	5625	1
11ac80MIMO	5530	Type6	29	1	333.3	9	0.3333	300	5317	1
11ac80MIMO	5530	Type6	29	1	333.3	9	0.3333	300	5431	1
11ac80MIMO	5530	Type6	29	1	333.3	9	0.3333	300	5518	1
11ac80MIMO	5530	Type6	29	1	333.3	9	0.3333	300	5621	1
11ac80MIMO	5530	Type6	29	1	333.3	9	0.3333	300	5653	1
11ac80MIMO	5530	Type6	29	1	333.3	9	0.3333	300	5279	1
11ac80MIMO	5530	Type6	29	1	333.3	9	0.3333	300	5358	1
11ac80MIMO	5530	Type6	29	1	333.3	9	0.3333	300	5343	1
11ac80MIMO	5530	Type6	29	1	333.3	9	0.3333	300	5514	1
11ac80MIMO	5530	Type6	29	1	333.3	9	0.3333	300	5434	1
11ac80MIMO	5530	Type6	29	1	333.3	9	0.3333	300	5650	1
11ac80MIMO	5530	Type6	29	1	333.3	9	0.3333	300	5627	1
11ac80MIMO	5530	Type6	29	1	333.3	9	0.3333	300	5413	1
11ac80MIMO	5530	Type6	29	1	333.3	9	0.3333	300	5509	1
11ac80MIMO	5530	Type6	29	1	333.3	9	0.3333	300	5491	1
11ac80MIMO	5530	Type6	29	1	333.3	9	0.3333	300	5660	1
11ac80MIMO	5530	Type6	29	1	333.3	9	0.3333	300	5371	1
11ac80MIMO	5530	Type6	29	1	333.3	9	0.3333	300	5545	1
11ac80MIMO	5530	Type6	29	1	333.3	9	0.3333	300	5665	1
11ac80MIMO	5530	Type6	29	1	333.3	9	0.3333	300	5291	1
11ac80MIMO	5530	Type6	29	1	333.3	9	0.3333	300	5467	1
11ac80MIMO	5530	Type6	29	1	333.3	9	0.3333	300	5259	1
11ac80MIMO	5530	Type6	29	1	333.3	9	0.3333	300	5338	1
11ac80MIMO	5530	Type6	29	1	333.3	9	0.3333	300	5486	1
11ac80MIMO	5530	Type6	29	1	333.3	9	0.3333	300	5428	1
11ac80MIMO	5530	Type6	29	1	333.3	9	0.3333	300	5528	1
11ac80MIMO	5530	Type6	29	1	333.3	9	0.3333	300	5613	1
11ac80MIMO	5530	Type6	29	1	333.3	9	0.3333	300	5481	1
11ac80MIMO	5530	Type6	29	1	333.3	9	0.3333	300	5299	1
11ac80MIMO	5530	Type6	29	1	333.3	9	0.3333	300	5549	1
11ac80MIMO	5530	Type6	29	1	333.3	9	0.3333	300	5309	1
11ac80MIMO	5530	Type6	29	1	333.3	9	0.3333	300	5612	1
11ac80MIMO	5530	Type6	29	1	333.3	9	0.3333	300	5695	1
11ac80MIMO	5530	Type6	29	1	333.3	9	0.3333	300	5681	1
11ac80MIMO	5530	Type6	29	1	333.3	9	0.3333	300	5581	1
11ac80MIMO	5530	Type6	29	1	333.3	9	0.3333	300	5422	1
11ac80MIMO	5530	Type6	29	1	333.3	9	0.3333	300	5540	1
11ac80MIMO	5530	Type6	29	1	333.3	9	0.3333	300	5386	1
11ac80MIMO	5530	Type6	29	1	333.3	9	0.3333	300	5699	1
11ac80MIMO	5530	Type6	29	1	333.3	9	0.3333	300	5503	1
11ac80MIMO	5530	Type6	29	1	333.3	9	0.3333	300	5446	1
11ac80MIMO	5530	Type6	29	1	333.3	9	0.3333	300	5256	1
11ac80MIMO	5530	Type6	29	1	333.3	9	0.3333	300	5462	1
11ac80MIMO	5530	Type6	29	1	333.3	9	0.3333	300	5640	1
11ac80MIMO	5530	Type6	29	1	333.3	9	0.3333	300	5427	1
11ac80MIMO	5530	Type6	29	1	333.3	9	0.3333	300	5377	1
11ac80MIMO	5530	Type6	29	1	333.3	9	0.3333	300	5487	1
11ac80MIMO	5530	Type6	29	1	333.3	9	0.3333	300	5398	1
11ac80MIMO	5530	Type6	29	1	333.3	9	0.3333	300	5307	1
11ac40MIMO	5510	Type6	29	1	333.3	9	0.3333	300	5430	1
11ac40MIMO	5510	Type6	29	1	333.3	9	0.3333	300	5717	1



Unless otherwise agreed in writing, this document is issued by the Company subject to its General Conditions of Service printed overleaf, available on request or accessible at <http://www.sgs.com/en/Terms-and-Conditions.aspx> and, for electronic format documents, subject to Terms and Conditions for Electronic Documents at <http://www.sgs.com/en/Terms-and-Conditions/Terms-e-Documents.aspx>. Attention is drawn to the limitation of liability, indemnification and jurisdiction issues defined therein. Any holder of this document is advised that information contained herein reflects the Company's findings at the time of its intervention only and within the limits of Client's instructions, if any. The Company's sole responsibility is to its Client and this document does not exonerate parties to a transaction from exercising all their rights and obligations under the transaction documents. This document cannot be reproduced except in full, without prior written approval of the Company. Any unauthorized alteration, forgery or falsification of the content or appearance of this document is unlawful and offenders may be prosecuted to the fullest extent of the law. Unless otherwise stated the results shown in this test report refer only to the sample(s) tested and such sample(s) are retained for 30 days only.

Attention: To check the authenticity of testing inspection report & certificate, please contact us at telephone: (86-755) 8307 1443, or email: [CN.Doccheck@sgs.com](mailto:CN.Doccheck@sgs.com)  
 (E) Unit D, Building 1, Kanglong Orange Science Park, No.157, Keyuan 3rd Road, Fengyang New Town, Xi'an, Shaanxi, China 710086  
 t (86-29) 6282 7885 www.sgs.com.cn  
 中国·西安·沣东新城科里三路157号康隆橙方科技园1号楼D单元1层 邮编: 710086 t (86-29) 6282 7885 sgs.china@sgs.com

Report No.: XEWA2310000070RG05

Rev.: 01

Page: 264 of 267

11ac40MIMO	5510	Type6	29	1	333.3	9	0.3333	300	5475	1
11ac40MIMO	5510	Type6	29	1	333.3	9	0.3333	300	5711	1
11ac40MIMO	5510	Type6	29	1	333.3	9	0.3333	300	5687	1
11ac40MIMO	5510	Type6	29	1	333.3	9	0.3333	300	5406	1
11ac40MIMO	5510	Type6	29	1	333.3	9	0.3333	300	5490	1
11ac40MIMO	5510	Type6	29	1	333.3	9	0.3333	300	5435	1
11ac40MIMO	5510	Type6	29	1	333.3	9	0.3333	300	5276	1
11ac40MIMO	5510	Type6	29	1	333.3	9	0.3333	300	5321	1
11ac40MIMO	5510	Type6	29	1	333.3	9	0.3333	300	5604	1
11ac40MIMO	5510	Type6	29	1	333.3	9	0.3333	300	5574	1
11ac40MIMO	5510	Type6	29	1	333.3	9	0.3333	300	5444	1
11ac40MIMO	5510	Type6	29	1	333.3	9	0.3333	300	5295	1
11ac40MIMO	5510	Type6	29	1	333.3	9	0.3333	300	5722	1
11ac40MIMO	5510	Type6	29	1	333.3	9	0.3333	300	5594	1
11ac40MIMO	5510	Type6	29	1	333.3	9	0.3333	300	5414	1
11ac40MIMO	5510	Type6	29	1	333.3	9	0.3333	300	5326	1
11ac40MIMO	5510	Type6	29	1	333.3	9	0.3333	300	5536	1
11ac40MIMO	5510	Type6	29	1	333.3	9	0.3333	300	5373	1
11ac40MIMO	5510	Type6	29	1	333.3	9	0.3333	300	5346	1
11ac40MIMO	5510	Type6	29	1	333.3	9	0.3333	300	5546	1
11ac40MIMO	5510	Type6	29	1	333.3	9	0.3333	300	5579	1
11ac40MIMO	5510	Type6	29	1	333.3	9	0.3333	300	5675	1
11ac40MIMO	5510	Type6	29	1	333.3	9	0.3333	300	5419	1
11ac40MIMO	5510	Type6	29	1	333.3	9	0.3333	300	5478	1
11ac40MIMO	5510	Type6	29	1	333.3	9	0.3333	300	5558	1
11ac40MIMO	5510	Type6	29	1	333.3	9	0.3333	300	5327	1
11ac40MIMO	5510	Type6	29	1	333.3	9	0.3333	300	5658	1
11ac40MIMO	5510	Type6	29	1	333.3	9	0.3333	300	5629	1
11ac40MIMO	5510	Type6	29	1	333.3	9	0.3333	300	5420	1
11ac40MIMO	5510	Type6	29	1	333.3	9	0.3333	300	5674	1
11ac40MIMO	5510	Type6	29	1	333.3	9	0.3333	300	5519	1
11ac40MIMO	5510	Type6	29	1	333.3	9	0.3333	300	5559	1
11ac40MIMO	5510	Type6	29	1	333.3	9	0.3333	300	5432	1
11ac40MIMO	5510	Type6	29	1	333.3	9	0.3333	300	5648	1
11ac40MIMO	5510	Type6	29	1	333.3	9	0.3333	300	5488	1
11ac40MIMO	5510	Type6	29	1	333.3	9	0.3333	300	5512	1
11ac40MIMO	5510	Type6	29	1	333.3	9	0.3333	300	5513	1
11ac40MIMO	5510	Type6	29	1	333.3	9	0.3333	300	5433	1
11ac40MIMO	5510	Type6	29	1	333.3	9	0.3333	300	5402	1
11ac40MIMO	5510	Type6	29	1	333.3	9	0.3333	300	5329	1
11ac40MIMO	5510	Type6	29	1	333.3	9	0.3333	300	5570	1
11ac40MIMO	5510	Type6	29	1	333.3	9	0.3333	300	5599	1
11ac40MIMO	5510	Type6	29	1	333.3	9	0.3333	300	5331	1
11ac40MIMO	5510	Type6	29	1	333.3	9	0.3333	300	5251	1
11ac40MIMO	5510	Type6	29	1	333.3	9	0.3333	300	5624	1
11ac40MIMO	5510	Type6	29	1	333.3	9	0.3333	300	5477	1
11ac40MIMO	5510	Type6	29	1	333.3	9	0.3333	300	5266	1
11ac40MIMO	5510	Type6	29	1	333.3	9	0.3333	300	5286	1
11ac40MIMO	5510	Type6	29	1	333.3	9	0.3333	300	5625	1
11ac40MIMO	5510	Type6	29	1	333.3	9	0.3333	300	5317	1
11ac40MIMO	5510	Type6	29	1	333.3	9	0.3333	300	5431	1
11ac40MIMO	5510	Type6	29	1	333.3	9	0.3333	300	5518	1
11ac40MIMO	5510	Type6	29	1	333.3	9	0.3333	300	5621	1



Unless otherwise agreed in writing, this document is issued by the Company subject to its General Conditions of Service printed overleaf, available on request or accessible at <http://www.sgs.com/en/Terms-and-Conditions.aspx> and, for electronic format documents, subject to Terms and Conditions for Electronic Documents at <http://www.sgs.com/en/Terms-and-Conditions/Terms-e-Documents.aspx>. Attention is drawn to the limitation of liability, indemnification and jurisdiction issues defined therein. Any holder of this document is advised that information contained herein reflects the Company's findings at the time of its intervention only and within the limits of Client's instructions, if any. The Company's sole responsibility is to its Client and this document does not exonerate parties to a transaction from exercising all their rights and obligations under the transaction documents. This document cannot be reproduced except in full, without prior written approval of the Company. Any unauthorized alteration, forgery or falsification of the content or appearance of this document is unlawful and offenders may be prosecuted to the fullest extent of the law. Unless otherwise stated the results shown in this test report refer only to the sample(s) tested and such sample(s) are retained for 30 days only.

Attention: To check the authenticity of testing inspection report & certificate, please contact us at telephone: (86-755) 8307 1443, or email: [CN.Doccheck@sgs.com](mailto:CN.Doccheck@sgs.com)  
 (E) Unit D, Building 1, Kanglong Orange Science Park, No.157, Keyuan 3rd Road, Fengyang New Town, Xi'an, Shaanxi, China 710086  
 t (86-29) 6282 7885 www.sgs.com.cn  
 中国·西安·沣东新城科里三路157号康隆橙方科技园1号楼D单元1层 邮编: 710086 t (86-29) 6282 7885 sgs.china@sgs.com



11ac40MIMO	5510	Type6	29	1	333.3	9	0.3333	300	5653	1
11ac40MIMO	5510	Type6	29	1	333.3	9	0.3333	300	5279	1
11ac40MIMO	5510	Type6	29	1	333.3	9	0.3333	300	5358	1
11ac40MIMO	5510	Type6	29	1	333.3	9	0.3333	300	5343	1
11ac40MIMO	5510	Type6	29	1	333.3	9	0.3333	300	5514	1
11ac40MIMO	5510	Type6	29	1	333.3	9	0.3333	300	5434	1
11ac40MIMO	5510	Type6	29	1	333.3	9	0.3333	300	5650	1
11ac40MIMO	5510	Type6	29	1	333.3	9	0.3333	300	5627	1
11ac40MIMO	5510	Type6	29	1	333.3	9	0.3333	300	5413	1
11ac40MIMO	5510	Type6	29	1	333.3	9	0.3333	300	5509	1
11ac40MIMO	5510	Type6	29	1	333.3	9	0.3333	300	5491	1
11ac40MIMO	5510	Type6	29	1	333.3	9	0.3333	300	5660	1
11ac40MIMO	5510	Type6	29	1	333.3	9	0.3333	300	5371	1
11ac40MIMO	5510	Type6	29	1	333.3	9	0.3333	300	5545	1
11ac40MIMO	5510	Type6	29	1	333.3	9	0.3333	300	5665	1
11ac40MIMO	5510	Type6	29	1	333.3	9	0.3333	300	5291	1
11ac40MIMO	5510	Type6	29	1	333.3	9	0.3333	300	5467	1
11ac40MIMO	5510	Type6	29	1	333.3	9	0.3333	300	5259	1
11ac40MIMO	5510	Type6	29	1	333.3	9	0.3333	300	5338	1
11ac40MIMO	5510	Type6	29	1	333.3	9	0.3333	300	5486	1
11ac40MIMO	5510	Type6	29	1	333.3	9	0.3333	300	5428	1
11ac40MIMO	5510	Type6	29	1	333.3	9	0.3333	300	5528	1
11ac40MIMO	5510	Type6	29	1	333.3	9	0.3333	300	5613	1
11ac40MIMO	5510	Type6	29	1	333.3	9	0.3333	300	5481	1
11ac40MIMO	5510	Type6	29	1	333.3	9	0.3333	300	5299	1
11ac40MIMO	5510	Type6	29	1	333.3	9	0.3333	300	5549	1
11ac40MIMO	5510	Type6	29	1	333.3	9	0.3333	300	5309	1
11ac40MIMO	5510	Type6	29	1	333.3	9	0.3333	300	5612	1
11ac40MIMO	5510	Type6	29	1	333.3	9	0.3333	300	5695	1
11ac40MIMO	5510	Type6	29	1	333.3	9	0.3333	300	5681	1
11ac40MIMO	5510	Type6	29	1	333.3	9	0.3333	300	5581	1
11ac40MIMO	5510	Type6	29	1	333.3	9	0.3333	300	5422	1
11ac40MIMO	5510	Type6	29	1	333.3	9	0.3333	300	5540	1
11ac40MIMO	5510	Type6	29	1	333.3	9	0.3333	300	5386	1
11ac40MIMO	5510	Type6	29	1	333.3	9	0.3333	300	5699	1
11ac40MIMO	5510	Type6	29	1	333.3	9	0.3333	300	5503	1
11ac40MIMO	5510	Type6	29	1	333.3	9	0.3333	300	5446	1
11ac40MIMO	5510	Type6	29	1	333.3	9	0.3333	300	5256	1
11ac40MIMO	5510	Type6	29	1	333.3	9	0.3333	300	5462	1
11ac40MIMO	5510	Type6	29	1	333.3	9	0.3333	300	5640	1
11ac40MIMO	5510	Type6	29	1	333.3	9	0.3333	300	5427	1
11ac40MIMO	5510	Type6	29	1	333.3	9	0.3333	300	5377	1
11ac40MIMO	5510	Type6	29	1	333.3	9	0.3333	300	5487	1
11ac40MIMO	5510	Type6	29	1	333.3	9	0.3333	300	5398	1
11ac40MIMO	5510	Type6	29	1	333.3	9	0.3333	300	5307	1
11ac20MIMO	5500	Type6	29	1	333.3	9	0.3333	300	5430	1
11ac20MIMO	5500	Type6	29	1	333.3	9	0.3333	300	5717	1
11ac20MIMO	5500	Type6	29	1	333.3	9	0.3333	300	5475	1
11ac20MIMO	5500	Type6	29	1	333.3	9	0.3333	300	5711	1
11ac20MIMO	5500	Type6	29	1	333.3	9	0.3333	300	5687	1
11ac20MIMO	5500	Type6	29	1	333.3	9	0.3333	300	5406	1
11ac20MIMO	5500	Type6	29	1	333.3	9	0.3333	300	5490	1
11ac20MIMO	5500	Type6	29	1	333.3	9	0.3333	300	5435	1



Unless otherwise agreed in writing, this document is issued by the Company subject to its General Conditions of Service printed overleaf, available on request or accessible at <http://www.sgs.com/en/Terms-and-Conditions.aspx> and, for electronic format documents, subject to Terms and Conditions for Electronic Documents at <http://www.sgs.com/en/Terms-and-Conditions/Terms-e-Documents.aspx>. Attention is drawn to the limitation of liability, indemnification and jurisdiction issues defined therein. Any holder of this document is advised that information contained herein reflects the Company's findings at the time of its intervention only and within the limits of Client's instructions, if any. The Company's sole responsibility is to its Client and this document does not exonerate parties to a transaction from exercising all their rights and obligations under the transaction documents. This document cannot be reproduced except in full, without prior written approval of the Company. Any unauthorized alteration, forgery or falsification of the content or appearance of this document is unlawful and offenders may be prosecuted to the fullest extent of the law. Unless otherwise stated the results shown in this test report refer only to the sample(s) tested and such sample(s) are retained for 30 days only.

Attention: To check the authenticity of testing/inspection report & certificate, please contact us at telephone: (86-755) 8307 1443, or email: [CN.Doccheck@sgs.com](mailto:CN.Doccheck@sgs.com)

SGS-CSTC Standards Technical Services (Xi'an) Co., Ltd. | 1/E Unit D, Building 1, Kanglong Orange Science Park, No.137, Keyuan 3rd Road, Fengyang New Town, Xi'an, Shaanxi, China | 710086 | T (86-29) 6282 7885 | [www.sgs.com](http://www.sgs.com)  
 中国·西安·沣东新城科里三路137号康隆橙方科技园1号楼D单元1层 | 邮编: 710086 | T (86-29) 6282 7885 | [sgs.china@sgs.com](mailto:sgs.china@sgs.com)



Report No.: XEWA2310000070RG05

Rev.: 01

Page: 266 of 267

11ac20MIMO	5500	Type6	29	1	333.3	9	0.3333	300	5276	1
11ac20MIMO	5500	Type6	29	1	333.3	9	0.3333	300	5321	1
11ac20MIMO	5500	Type6	29	1	333.3	9	0.3333	300	5604	1
11ac20MIMO	5500	Type6	29	1	333.3	9	0.3333	300	5574	1
11ac20MIMO	5500	Type6	29	1	333.3	9	0.3333	300	5444	1
11ac20MIMO	5500	Type6	29	1	333.3	9	0.3333	300	5295	1
11ac20MIMO	5500	Type6	29	1	333.3	9	0.3333	300	5722	1
11ac20MIMO	5500	Type6	29	1	333.3	9	0.3333	300	5594	1
11ac20MIMO	5500	Type6	29	1	333.3	9	0.3333	300	5414	1
11ac20MIMO	5500	Type6	29	1	333.3	9	0.3333	300	5326	1
11ac20MIMO	5500	Type6	29	1	333.3	9	0.3333	300	5536	1
11ac20MIMO	5500	Type6	29	1	333.3	9	0.3333	300	5373	1
11ac20MIMO	5500	Type6	29	1	333.3	9	0.3333	300	5346	1
11ac20MIMO	5500	Type6	29	1	333.3	9	0.3333	300	5546	1
11ac20MIMO	5500	Type6	29	1	333.3	9	0.3333	300	5579	1
11ac20MIMO	5500	Type6	29	1	333.3	9	0.3333	300	5675	1
11ac20MIMO	5500	Type6	29	1	333.3	9	0.3333	300	5419	1
11ac20MIMO	5500	Type6	29	1	333.3	9	0.3333	300	5478	1
11ac20MIMO	5500	Type6	29	1	333.3	9	0.3333	300	5558	1
11ac20MIMO	5500	Type6	29	1	333.3	9	0.3333	300	5327	1
11ac20MIMO	5500	Type6	29	1	333.3	9	0.3333	300	5658	1
11ac20MIMO	5500	Type6	29	1	333.3	9	0.3333	300	5629	1
11ac20MIMO	5500	Type6	29	1	333.3	9	0.3333	300	5420	1
11ac20MIMO	5500	Type6	29	1	333.3	9	0.3333	300	5674	1
11ac20MIMO	5500	Type6	29	1	333.3	9	0.3333	300	5519	1
11ac20MIMO	5500	Type6	29	1	333.3	9	0.3333	300	5559	1
11ac20MIMO	5500	Type6	29	1	333.3	9	0.3333	300	5432	1
11ac20MIMO	5500	Type6	29	1	333.3	9	0.3333	300	5648	1
11ac20MIMO	5500	Type6	29	1	333.3	9	0.3333	300	5488	1
11ac20MIMO	5500	Type6	29	1	333.3	9	0.3333	300	5512	1
11ac20MIMO	5500	Type6	29	1	333.3	9	0.3333	300	5513	1
11ac20MIMO	5500	Type6	29	1	333.3	9	0.3333	300	5433	1
11ac20MIMO	5500	Type6	29	1	333.3	9	0.3333	300	5402	1
11ac20MIMO	5500	Type6	29	1	333.3	9	0.3333	300	5329	1
11ac20MIMO	5500	Type6	29	1	333.3	9	0.3333	300	5570	1
11ac20MIMO	5500	Type6	29	1	333.3	9	0.3333	300	5599	1
11ac20MIMO	5500	Type6	29	1	333.3	9	0.3333	300	5331	1
11ac20MIMO	5500	Type6	29	1	333.3	9	0.3333	300	5251	1
11ac20MIMO	5500	Type6	29	1	333.3	9	0.3333	300	5624	1
11ac20MIMO	5500	Type6	29	1	333.3	9	0.3333	300	5477	1
11ac20MIMO	5500	Type6	29	1	333.3	9	0.3333	300	5266	1
11ac20MIMO	5500	Type6	29	1	333.3	9	0.3333	300	5286	1
11ac20MIMO	5500	Type6	29	1	333.3	9	0.3333	300	5625	1
11ac20MIMO	5500	Type6	29	1	333.3	9	0.3333	300	5317	1
11ac20MIMO	5500	Type6	29	1	333.3	9	0.3333	300	5431	1
11ac20MIMO	5500	Type6	29	1	333.3	9	0.3333	300	5518	1
11ac20MIMO	5500	Type6	29	1	333.3	9	0.3333	300	5621	1
11ac20MIMO	5500	Type6	29	1	333.3	9	0.3333	300	5653	1
11ac20MIMO	5500	Type6	29	1	333.3	9	0.3333	300	5279	1
11ac20MIMO	5500	Type6	29	1	333.3	9	0.3333	300	5358	1
11ac20MIMO	5500	Type6	29	1	333.3	9	0.3333	300	5343	1
11ac20MIMO	5500	Type6	29	1	333.3	9	0.3333	300	5514	1
11ac20MIMO	5500	Type6	29	1	333.3	9	0.3333	300	5434	1



Unless otherwise agreed in writing, this document is issued by the Company subject to its General Conditions of Service printed overleaf, available on request or accessible at <http://www.sgs.com/en/Terms-and-Conditions.aspx> and, for electronic format documents, subject to Terms and Conditions for Electronic Documents at <http://www.sgs.com/en/Terms-and-Conditions/Terms-e-Documents.aspx>. Attention is drawn to the limitation of liability, indemnification and jurisdiction issues defined therein. Any holder of this document is advised that information contained herein reflects the Company's findings at the time of its intervention only and within the limits of Client's instructions, if any. The Company's sole responsibility is to its Client and this document does not exonerate parties to a transaction from exercising all their rights and obligations under the transaction documents. This document cannot be reproduced except in full, without prior written approval of the Company. Any unauthorized alteration, forgery or falsification of the content or appearance of this document is unlawful and offenders may be prosecuted to the fullest extent of the law. Unless otherwise stated the results shown in this test report refer only to the sample(s) tested and such sample(s) are retained for 30 days only.

Attention: To check the authenticity of testing/inspection report & certificate, please contact us at telephone: (86-755) 8307 1443, or email: [CN.Doccheck@sgs.com](mailto:CN.Doccheck@sgs.com)  
 (E) Unit D, Building 1, Kanglong Orange Science Park, No.157, Keyuan 3rd Road, Fengyang New Town, Xian, Shaanxi, China 710086  
 t (86-29) 6282 7885 www.sgs.com.cn  
 中国·西安·沣东新城科里三路157号康隆橙方科技园1号楼D单元1层 邮编: 710086 t (86-29) 6282 7885 sgs.china@sgs.com

Report No.: XEWA2310000070RG05

Rev.: 01

Page: 267 of 267

11ac20MIMO	5500	Type6	29	1	333.3	9	0.3333	300	5650	1
11ac20MIMO	5500	Type6	29	1	333.3	9	0.3333	300	5627	1
11ac20MIMO	5500	Type6	29	1	333.3	9	0.3333	300	5413	1
11ac20MIMO	5500	Type6	29	1	333.3	9	0.3333	300	5509	1
11ac20MIMO	5500	Type6	29	1	333.3	9	0.3333	300	5491	1
11ac20MIMO	5500	Type6	29	1	333.3	9	0.3333	300	5660	1
11ac20MIMO	5500	Type6	29	1	333.3	9	0.3333	300	5371	1
11ac20MIMO	5500	Type6	29	1	333.3	9	0.3333	300	5545	1
11ac20MIMO	5500	Type6	29	1	333.3	9	0.3333	300	5665	1
11ac20MIMO	5500	Type6	29	1	333.3	9	0.3333	300	5291	1
11ac20MIMO	5500	Type6	29	1	333.3	9	0.3333	300	5467	1
11ac20MIMO	5500	Type6	29	1	333.3	9	0.3333	300	5259	1
11ac20MIMO	5500	Type6	29	1	333.3	9	0.3333	300	5338	1
11ac20MIMO	5500	Type6	29	1	333.3	9	0.3333	300	5486	1
11ac20MIMO	5500	Type6	29	1	333.3	9	0.3333	300	5428	1
11ac20MIMO	5500	Type6	29	1	333.3	9	0.3333	300	5528	1
11ac20MIMO	5500	Type6	29	1	333.3	9	0.3333	300	5613	1
11ac20MIMO	5500	Type6	29	1	333.3	9	0.3333	300	5481	1
11ac20MIMO	5500	Type6	29	1	333.3	9	0.3333	300	5299	1
11ac20MIMO	5500	Type6	29	1	333.3	9	0.3333	300	5549	1
11ac20MIMO	5500	Type6	29	1	333.3	9	0.3333	300	5309	1
11ac20MIMO	5500	Type6	29	1	333.3	9	0.3333	300	5612	1
11ac20MIMO	5500	Type6	29	1	333.3	9	0.3333	300	5695	1
11ac20MIMO	5500	Type6	29	1	333.3	9	0.3333	300	5681	1
11ac20MIMO	5500	Type6	29	1	333.3	9	0.3333	300	5581	1
11ac20MIMO	5500	Type6	29	1	333.3	9	0.3333	300	5422	1
11ac20MIMO	5500	Type6	29	1	333.3	9	0.3333	300	5540	1
11ac20MIMO	5500	Type6	29	1	333.3	9	0.3333	300	5386	1
11ac20MIMO	5500	Type6	29	1	333.3	9	0.3333	300	5699	1
11ac20MIMO	5500	Type6	29	1	333.3	9	0.3333	300	5503	1
11ac20MIMO	5500	Type6	29	1	333.3	9	0.3333	300	5446	1
11ac20MIMO	5500	Type6	29	1	333.3	9	0.3333	300	5256	1
11ac20MIMO	5500	Type6	29	1	333.3	9	0.3333	300	5462	1
11ac20MIMO	5500	Type6	29	1	333.3	9	0.3333	300	5640	1
11ac20MIMO	5500	Type6	29	1	333.3	9	0.3333	300	5427	1
11ac20MIMO	5500	Type6	29	1	333.3	9	0.3333	300	5377	1
11ac20MIMO	5500	Type6	29	1	333.3	9	0.3333	300	5487	1
11ac20MIMO	5500	Type6	29	1	333.3	9	0.3333	300	5398	1
11ac20MIMO	5500	Type6	29	1	333.3	9	0.3333	300	5307	1

---End of Report---



Unless otherwise agreed in writing, this document is issued by the Company subject to its General Conditions of Service printed overleaf, available on request or accessible at <http://www.sgs.com/en/Terms-and-Conditions.aspx> and, for electronic format documents, subject to Terms and Conditions for Electronic Documents at <http://www.sgs.com/en/Terms-and-Conditions/Terms-e-Documents.aspx>. Attention is drawn to the limitation of liability, indemnification and jurisdiction issues defined therein. Any holder of this document is advised that information contained herein reflects the Company's findings at the time of its intervention only and within the limits of Client's instructions, if any. The Company's sole responsibility is to its Client and this document does not exonerate parties to a transaction from exercising all their rights and obligations under the transaction documents. This document cannot be reproduced except in full, without prior written approval of the Company. Any unauthorized alteration, forgery or falsification of the content or appearance of this document is unlawful and offenders may be prosecuted to the fullest extent of the law. Unless otherwise stated the results shown in this test report refer only to the sample(s) tested and such sample(s) are retained for 30 days only.

Attention: To check the authenticity of testing/inspection report & certificate, please contact us at telephone: (86-755) 4307 1443, or email: CN.Doccheck@sgs.com

SGS-CSTC Standards Technical Services (Xi'an) Co., Ltd.  
 检验检测专用章  
 Inspection & Testing Services

1/E Unit D, Building 1, Kanglong Orange Source Park, No.137, Kejian 3rd Road, Fengling New Town, Xi'an, Shaanxi, China 710086  
 中国·西安·沣东新城科园三路137号康隆橙源科技园1号楼D单元1层 邮编: 710086

t (86-29) 6282 7885 www.sgs.com.cn  
 t (86-29) 6282 7885 sgs.china@sgs.com