

PSD 802.11ac(VHT40) 5795MHz

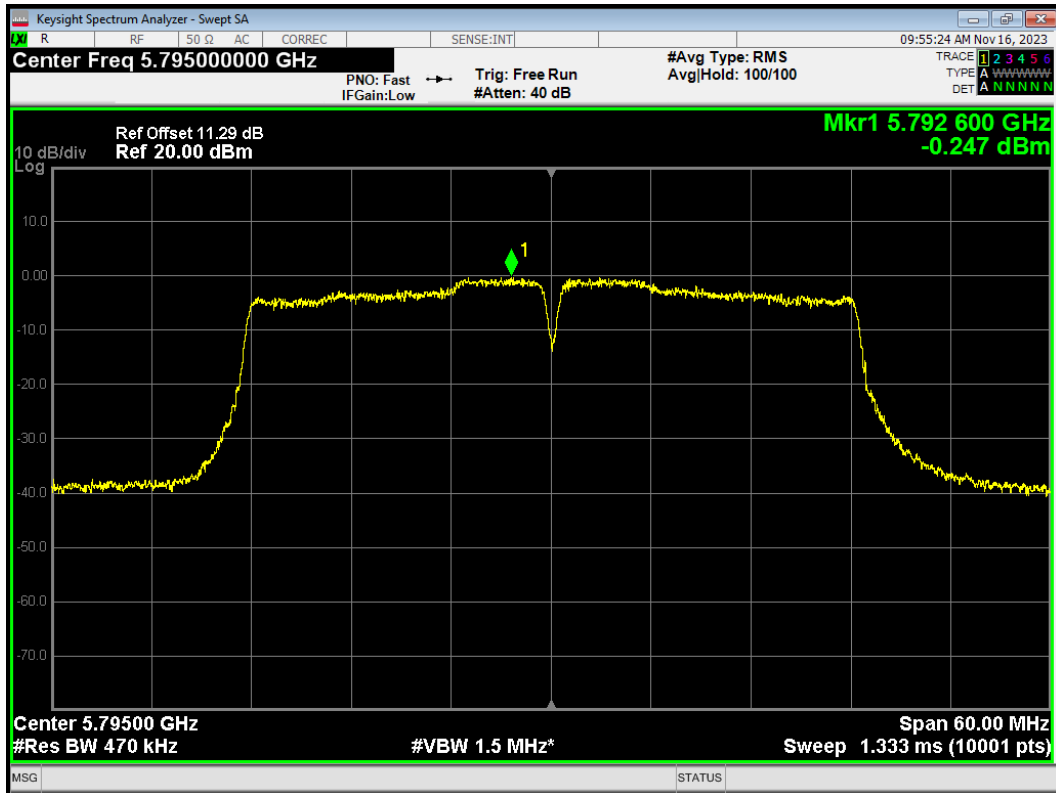

PSD 802.11ac(VHT80) 5690MHz

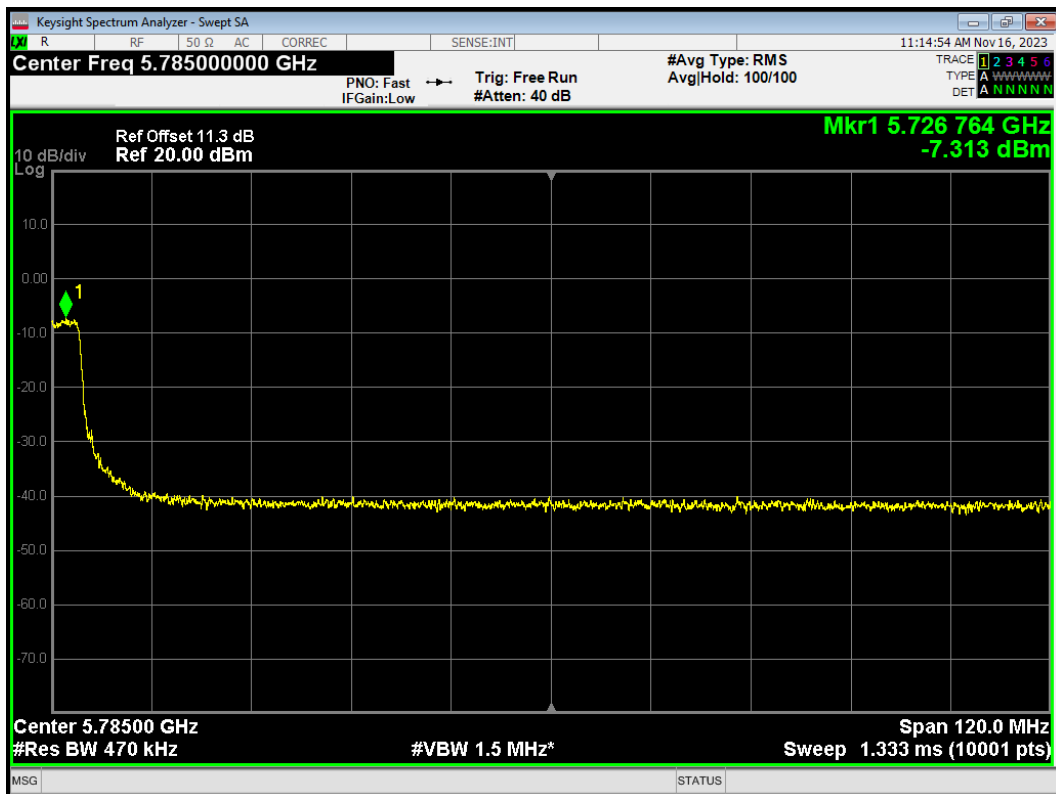

PSD 802.11ac(VHT80) 5775MHz

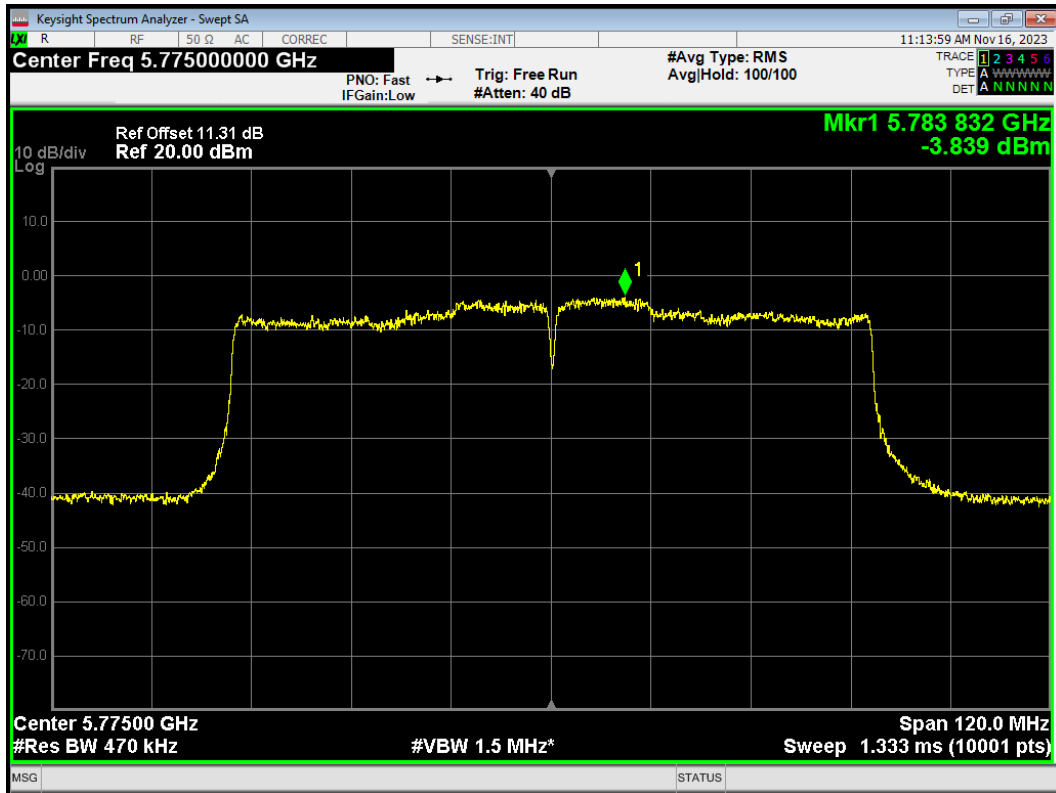

PSD 802.11ax(HE20) 5720MHz

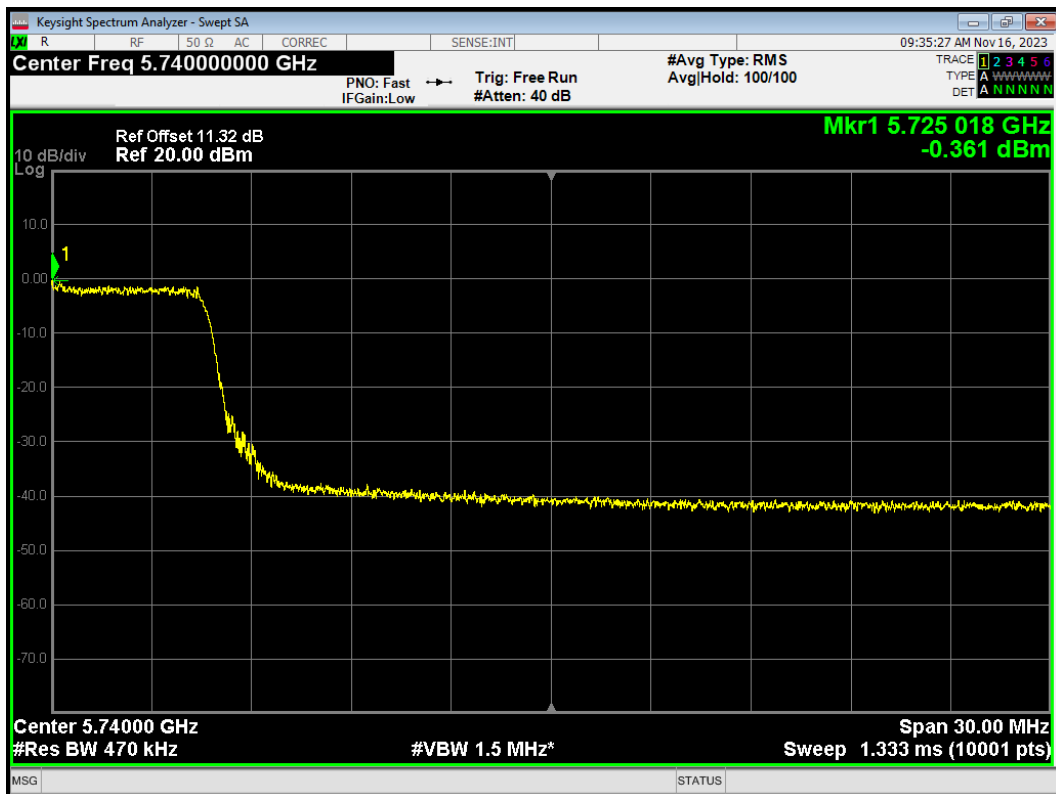

PSD 802.11ax(HE20) 5745MHz

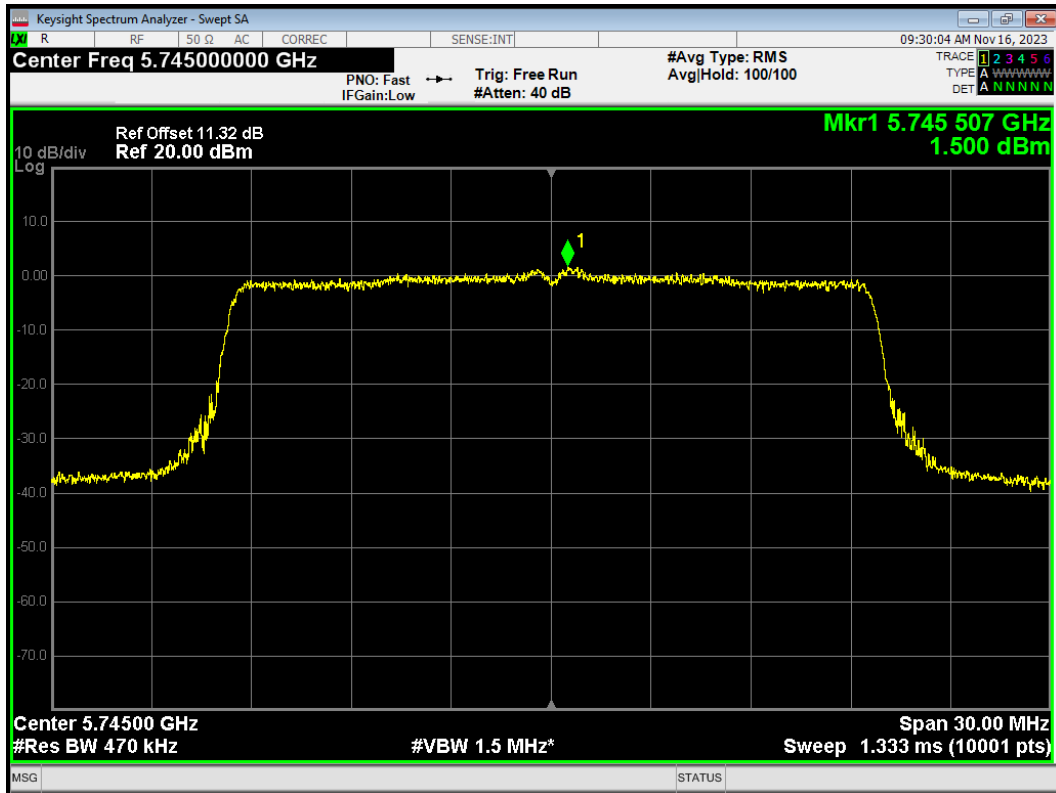

PSD 802.11ax(HE20) 5785MHz

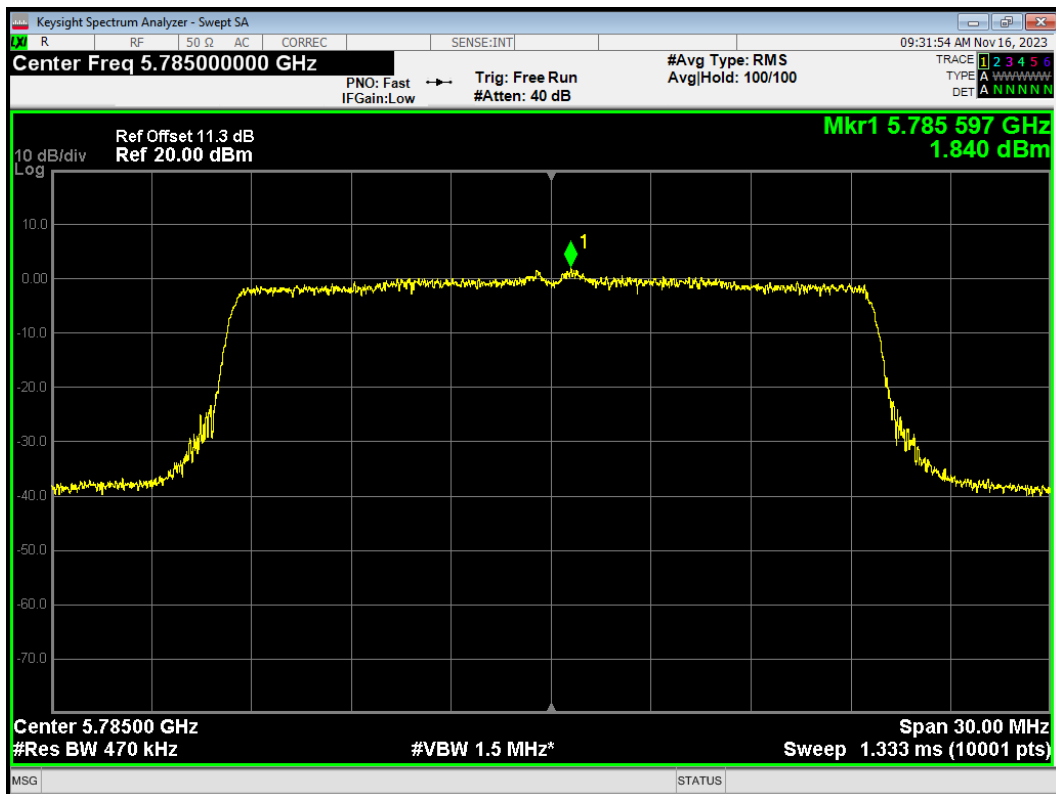

PSD 802.11ax(HE20) 5825MHz

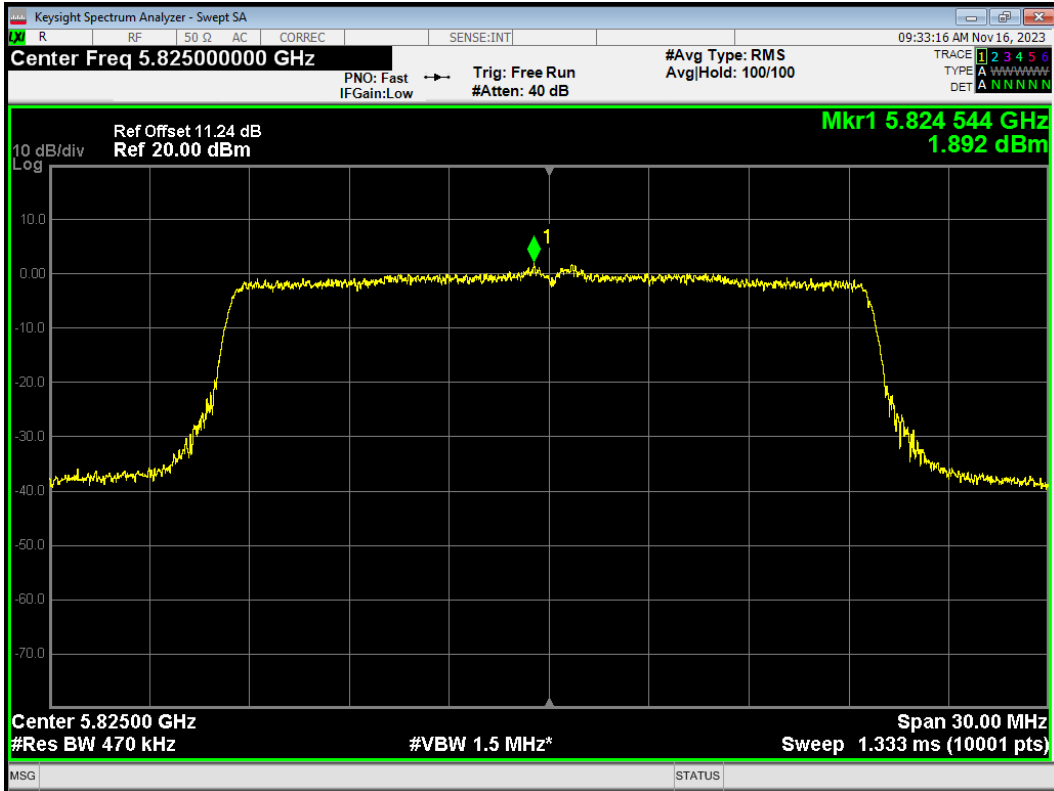

PSD 802.11ax(HE40) 5710MHz

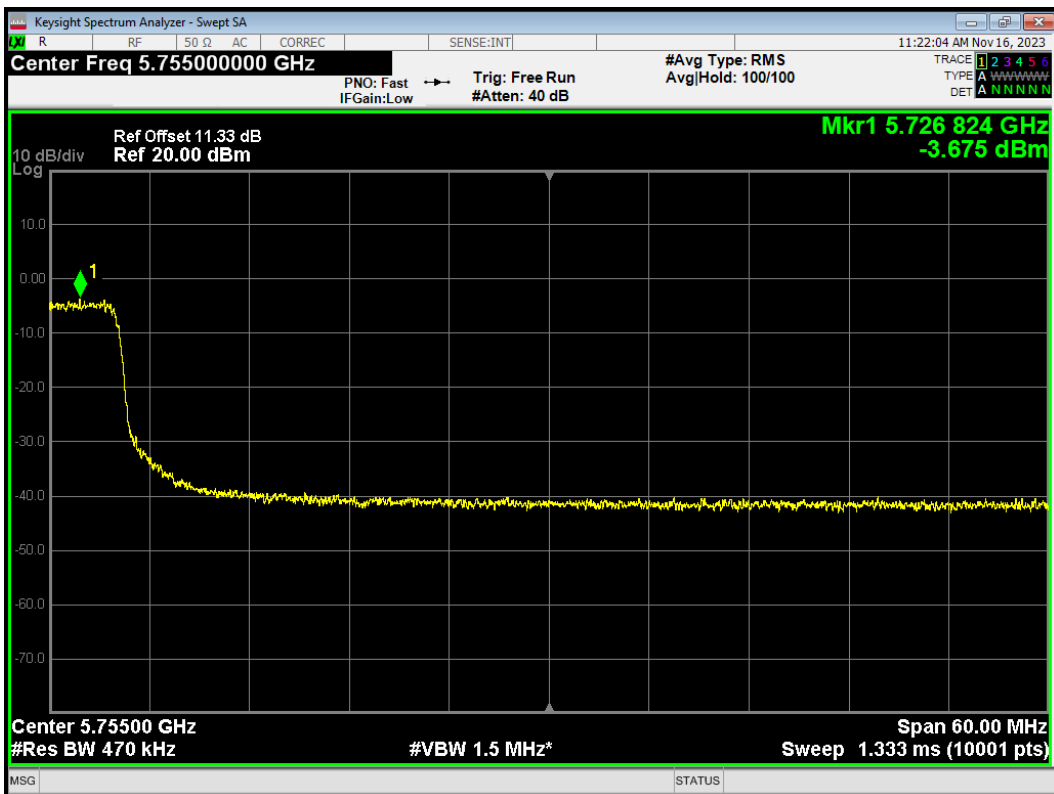

PSD 802.11ax(HE40) 5755MHz

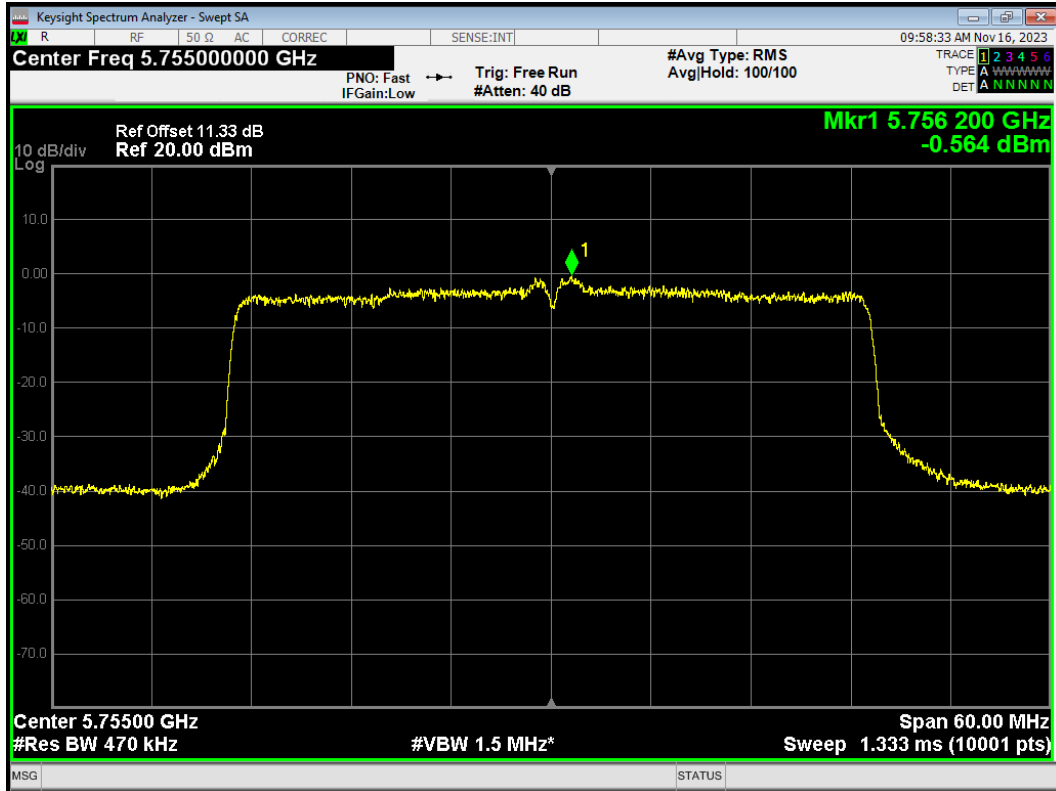

PSD 802.11ax(HE40) 5795MHz

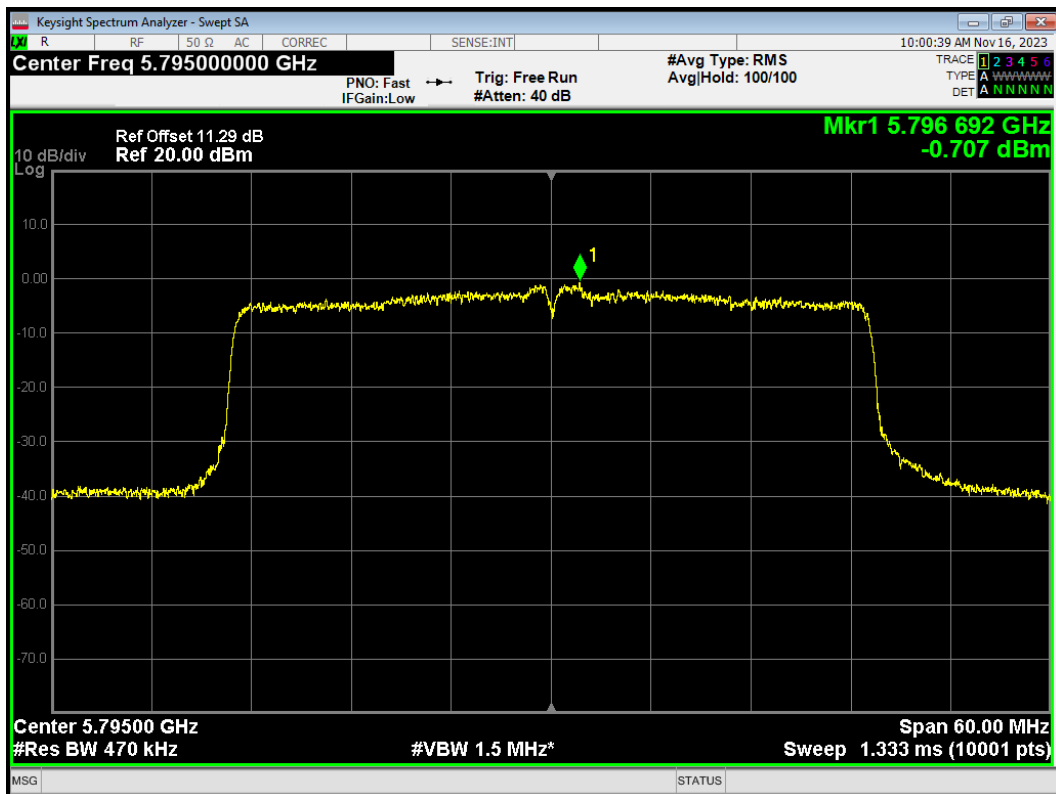

PSD 802.11ax(HE80) 5690MHz

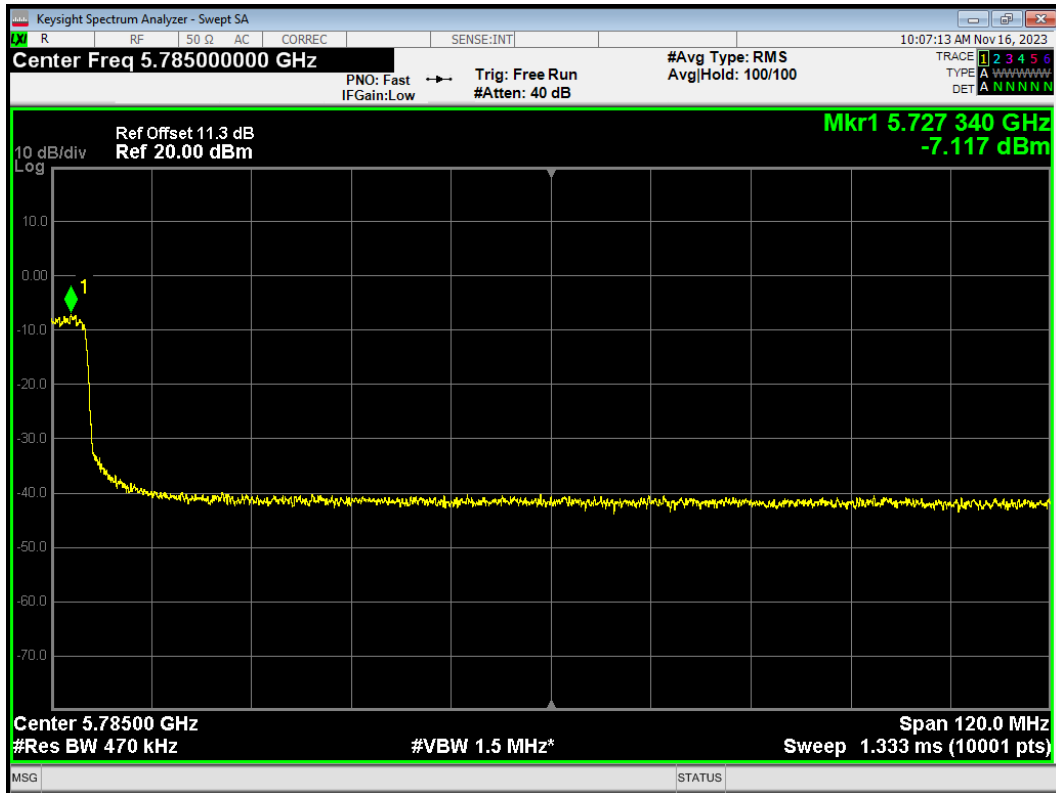

PSD 802.11ax(HE80) 5775MHz

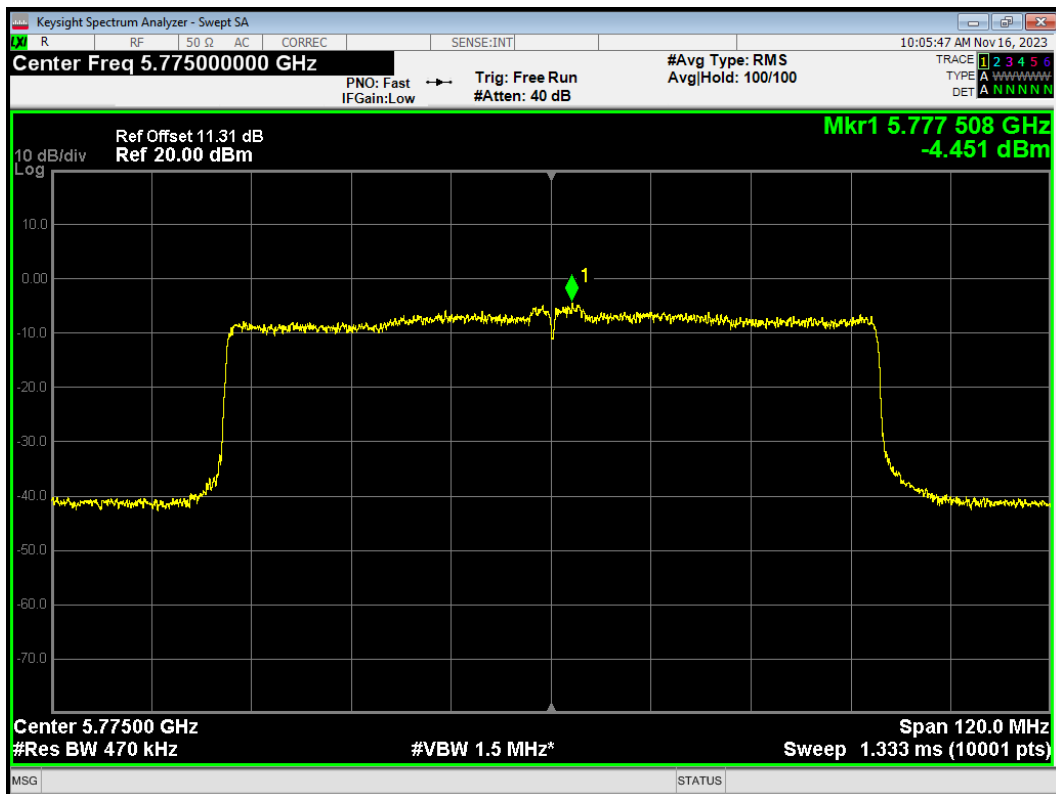

PSD 802.11n(HT20) 5720MHz

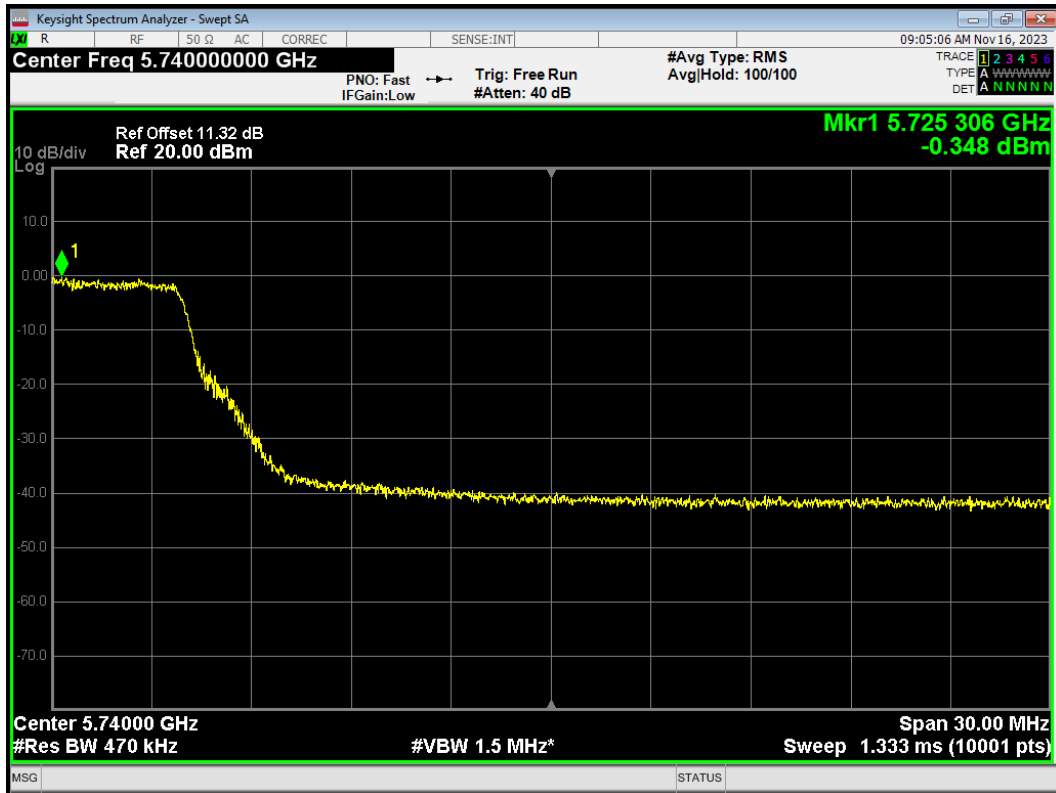

PSD 802.11n(HT20) 5745MHz

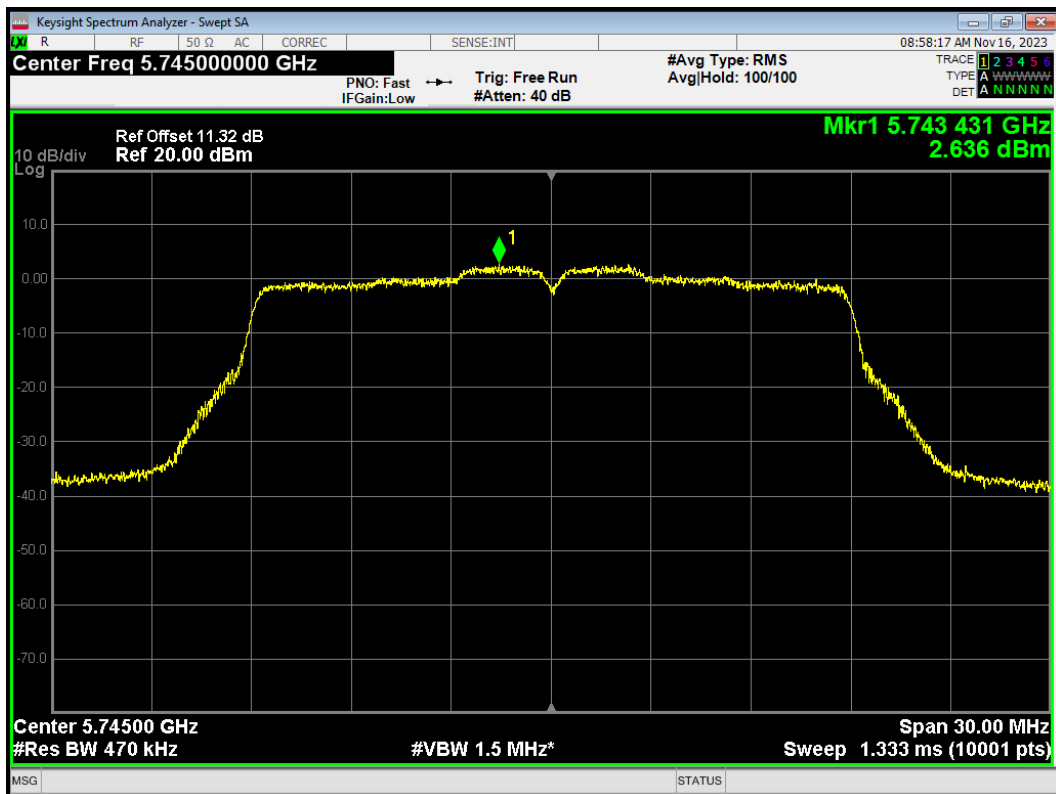

PSD 802.11n(HT20) 5785MHz

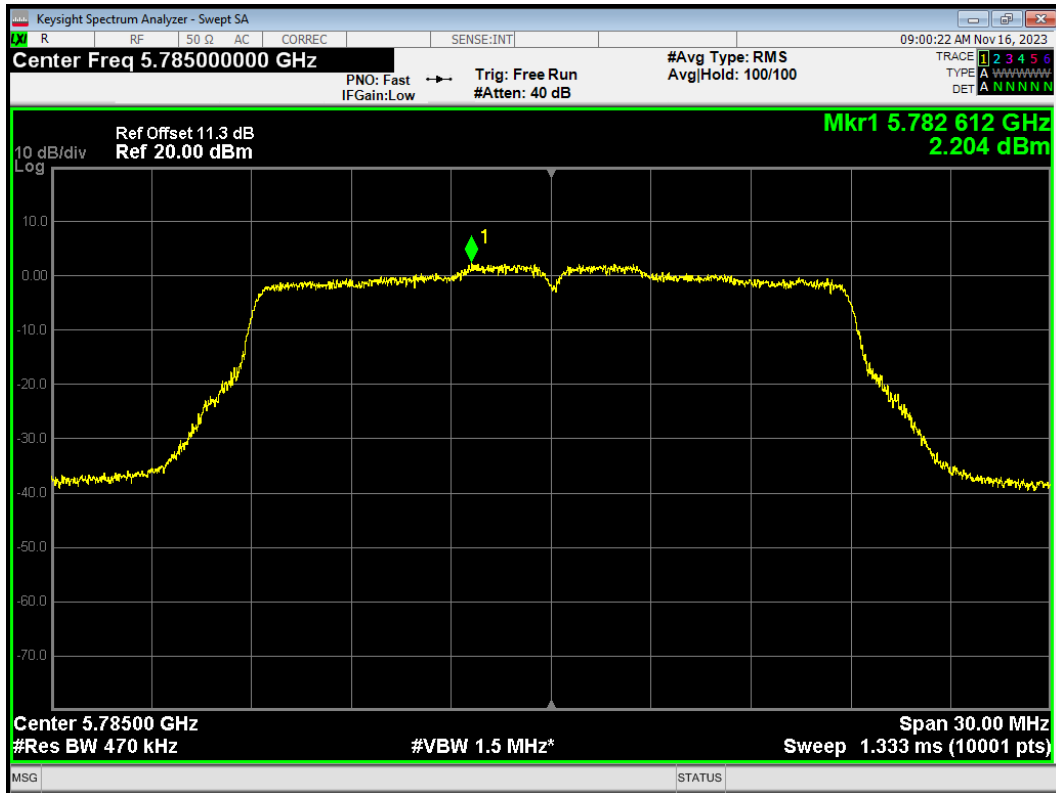

PSD 802.11n(HT20) 5825MHz

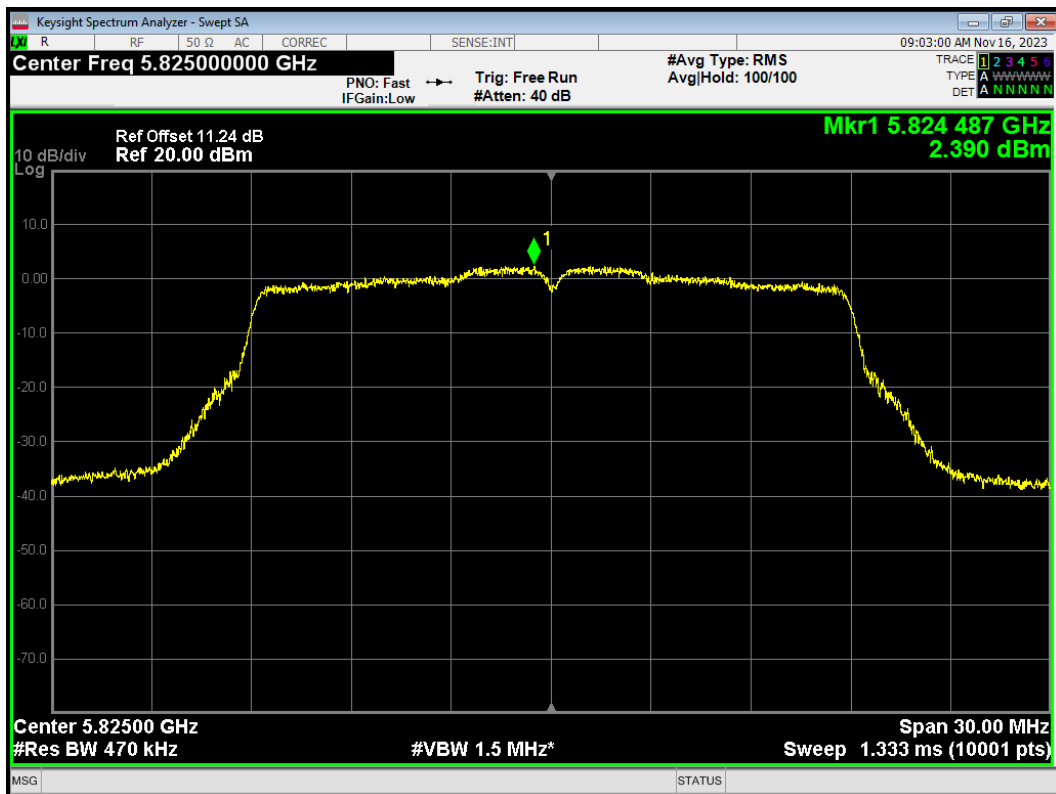

PSD 802.11n(HT40) 5710MHz

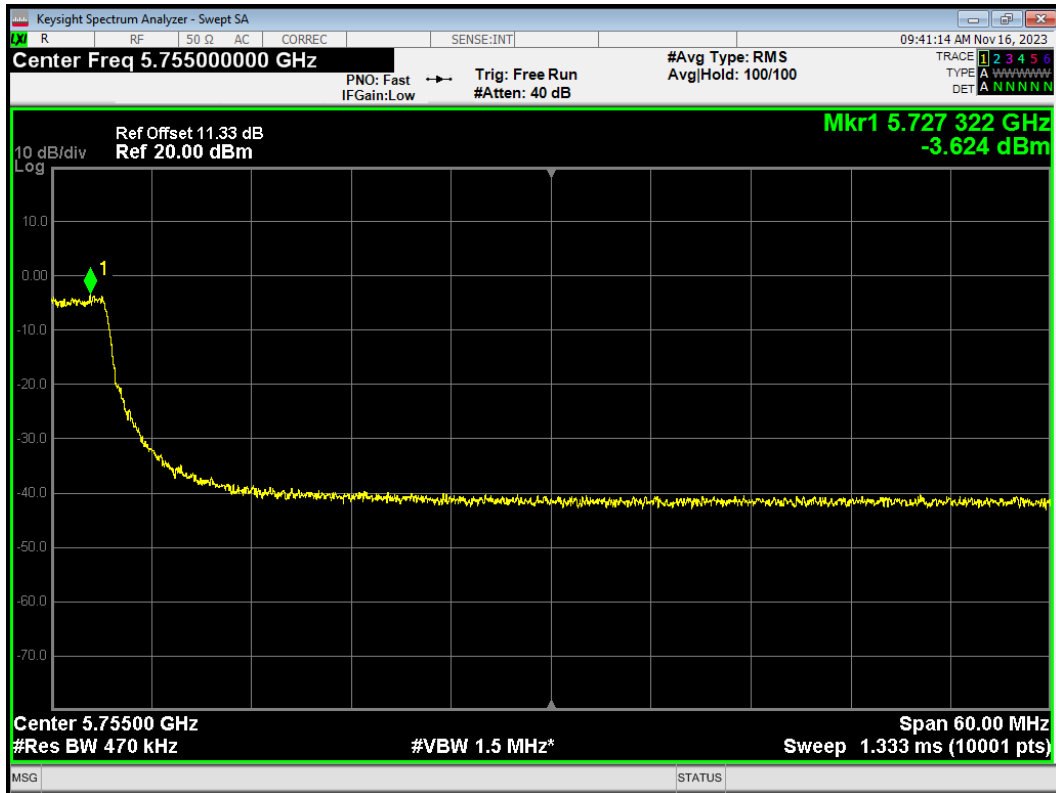

PSD 802.11n(HT40) 5755MHz

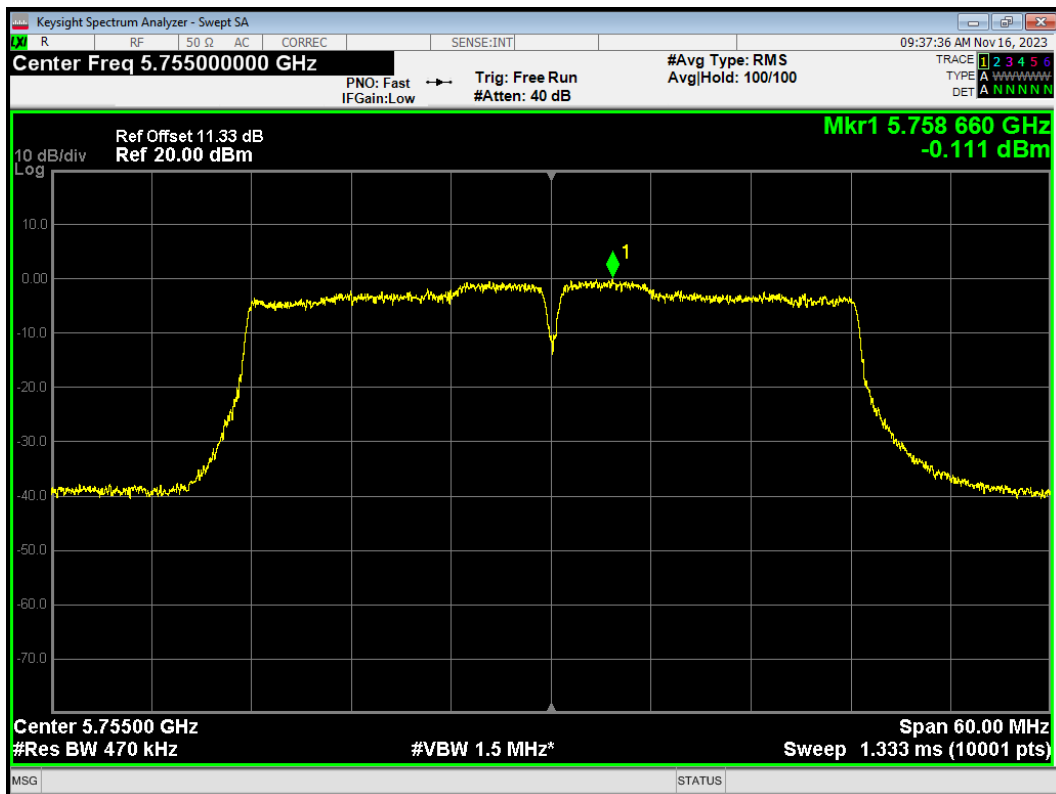

PSD 802.11n(HT40) 5795MHz

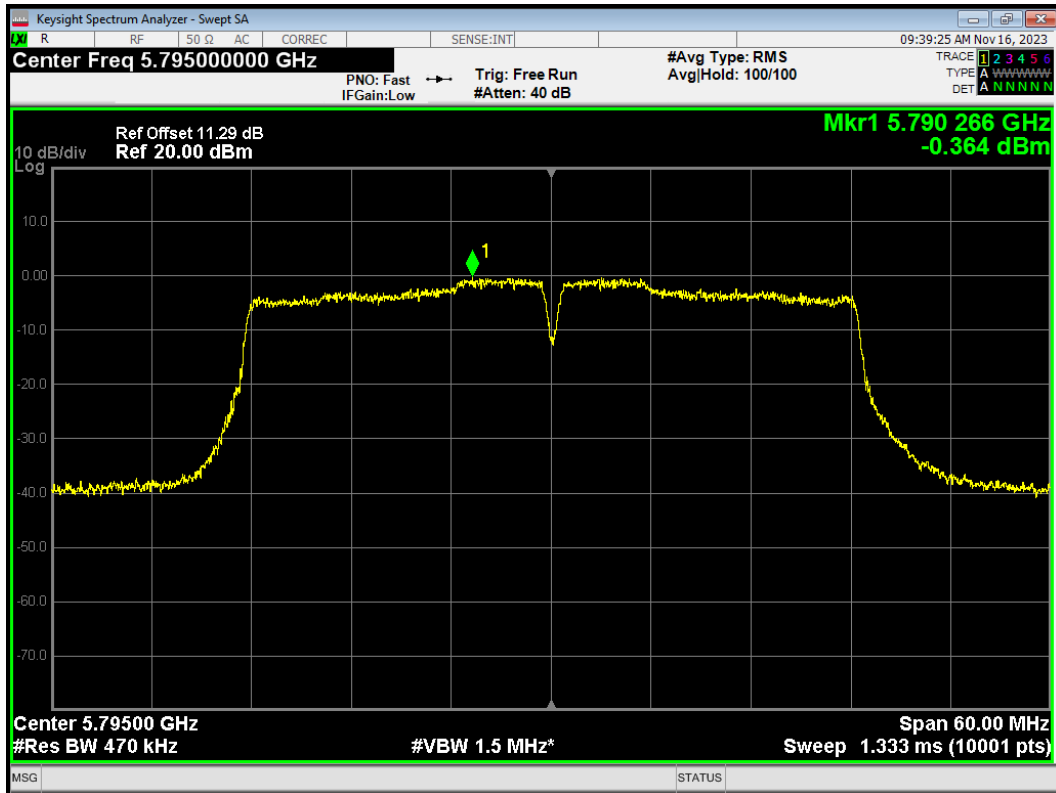

MIMO
U-NII-1

PSD 802.11ac(VHT20) 5180MHz Ant1

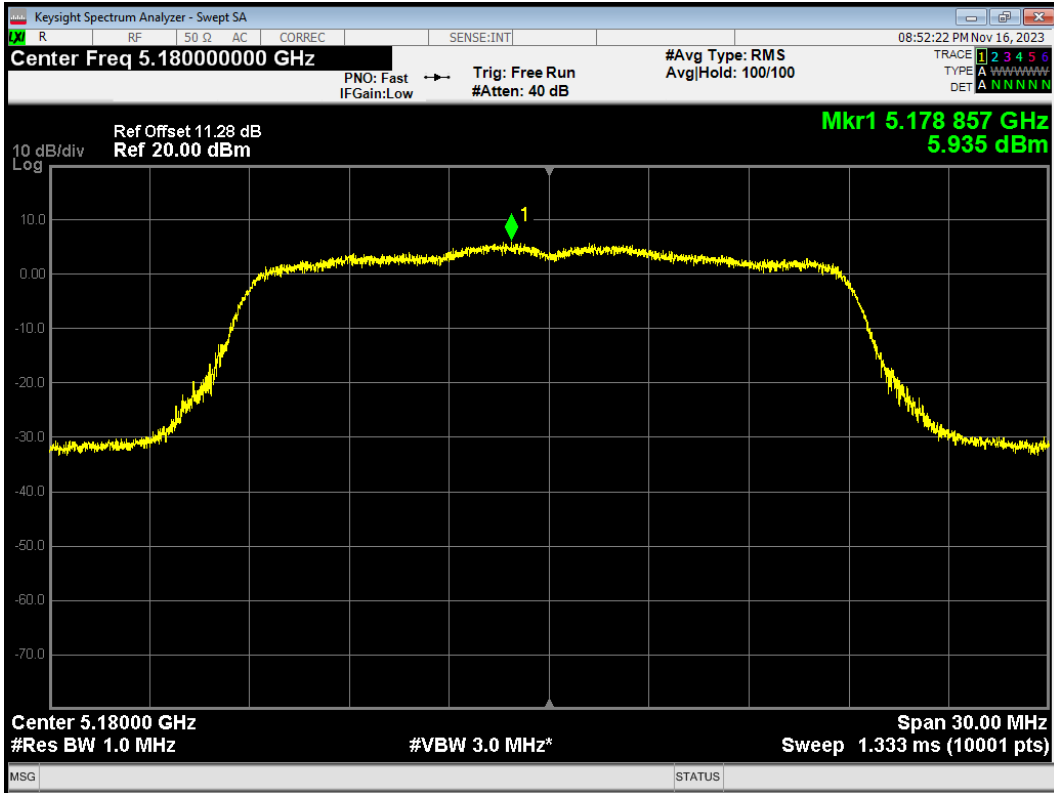

PSD 802.11ac(VHT20) 5180MHz Ant2

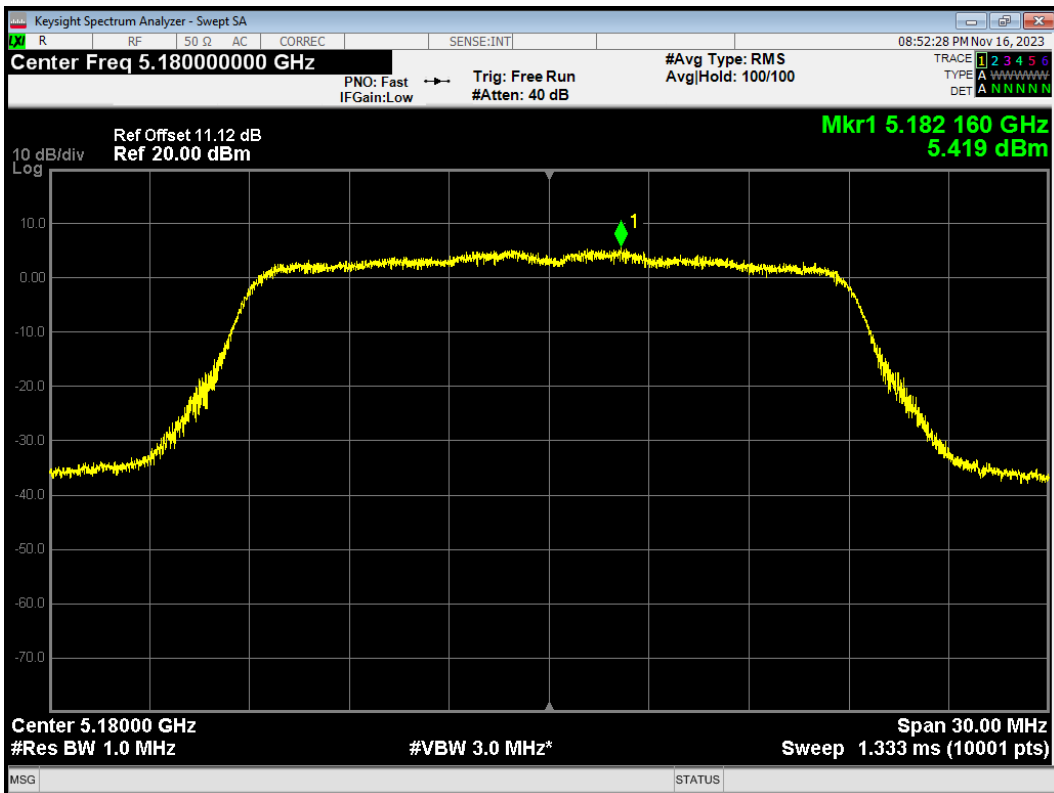

PSD 802.11ac(VHT20) 5200MHz Ant1

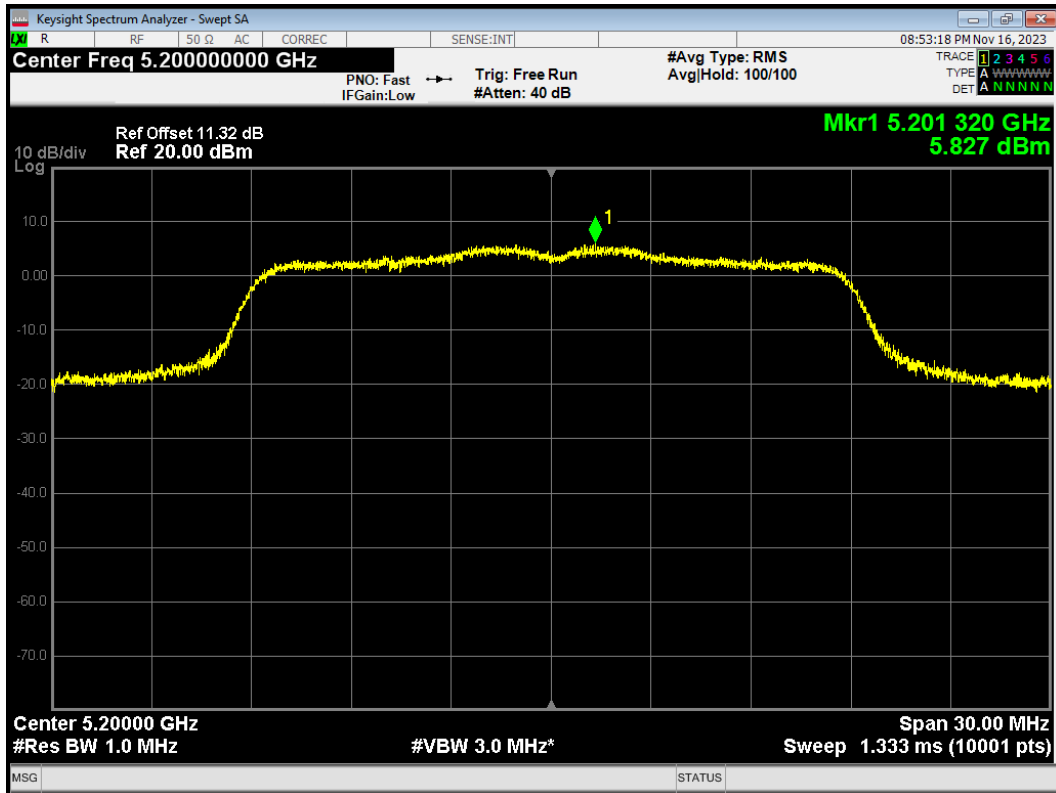

PSD 802.11ac(VHT20) 5200MHz Ant2

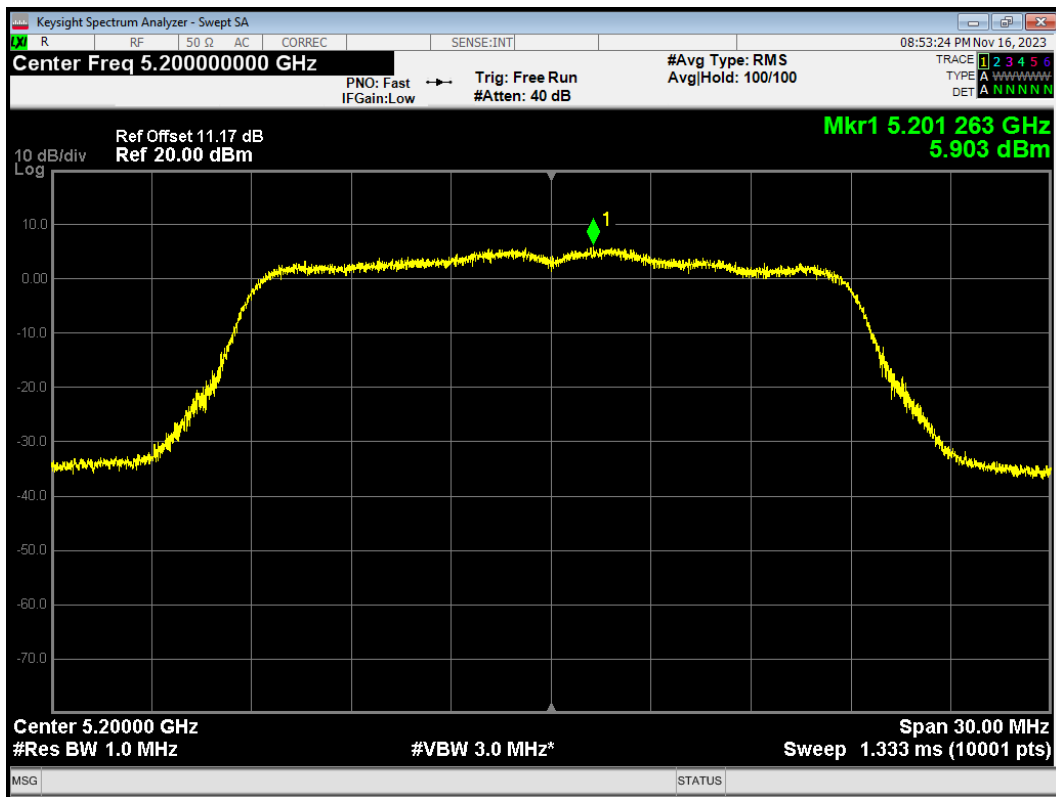

PSD 802.11ac(VHT20) 5240MHz Ant1

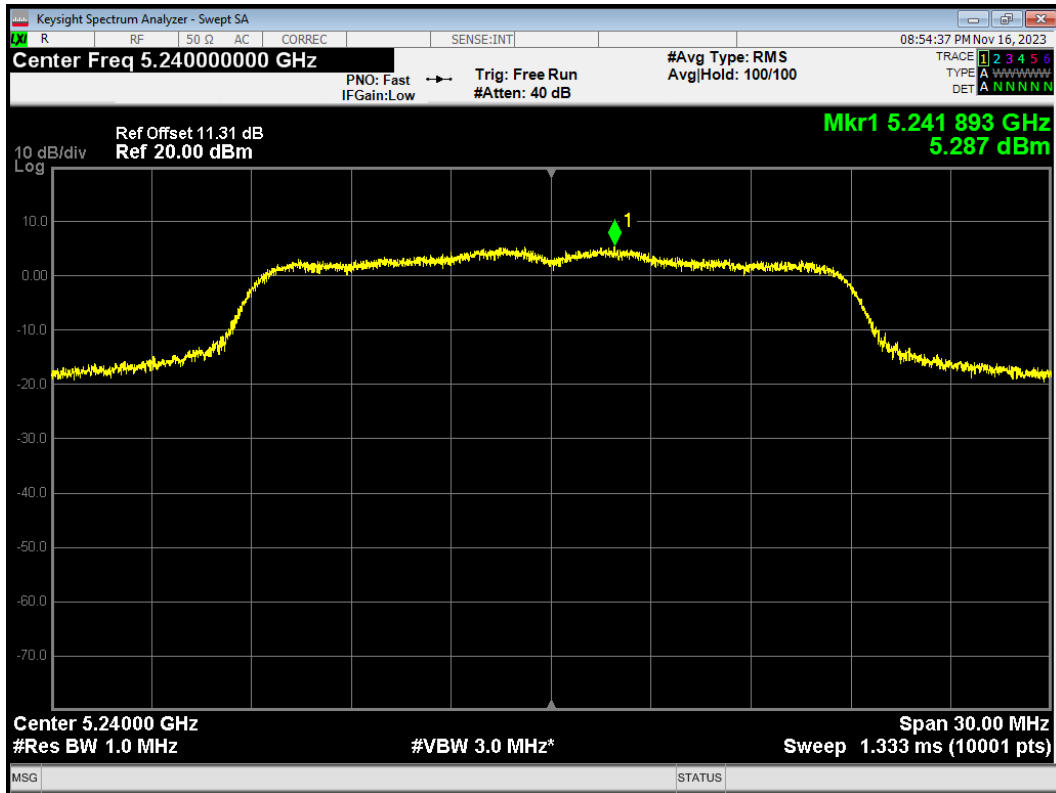

PSD 802.11ac(VHT20) 5240MHz Ant2

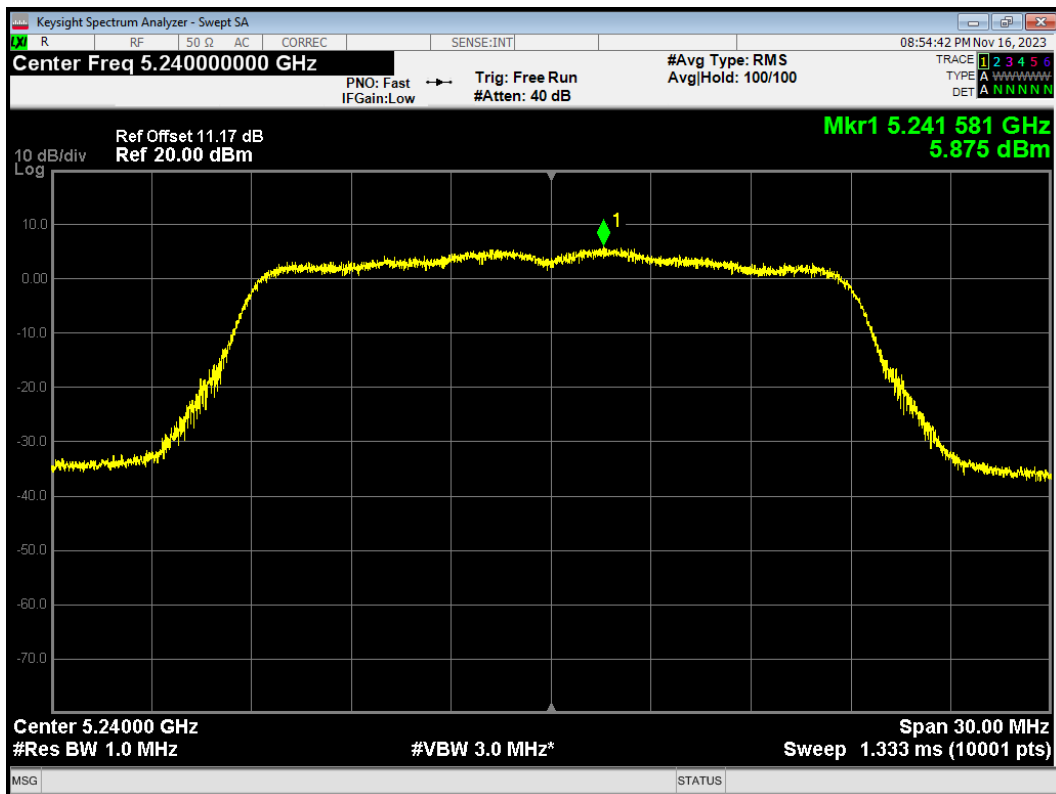

PSD 802.11ac(VHT40) 5190MHz Ant1

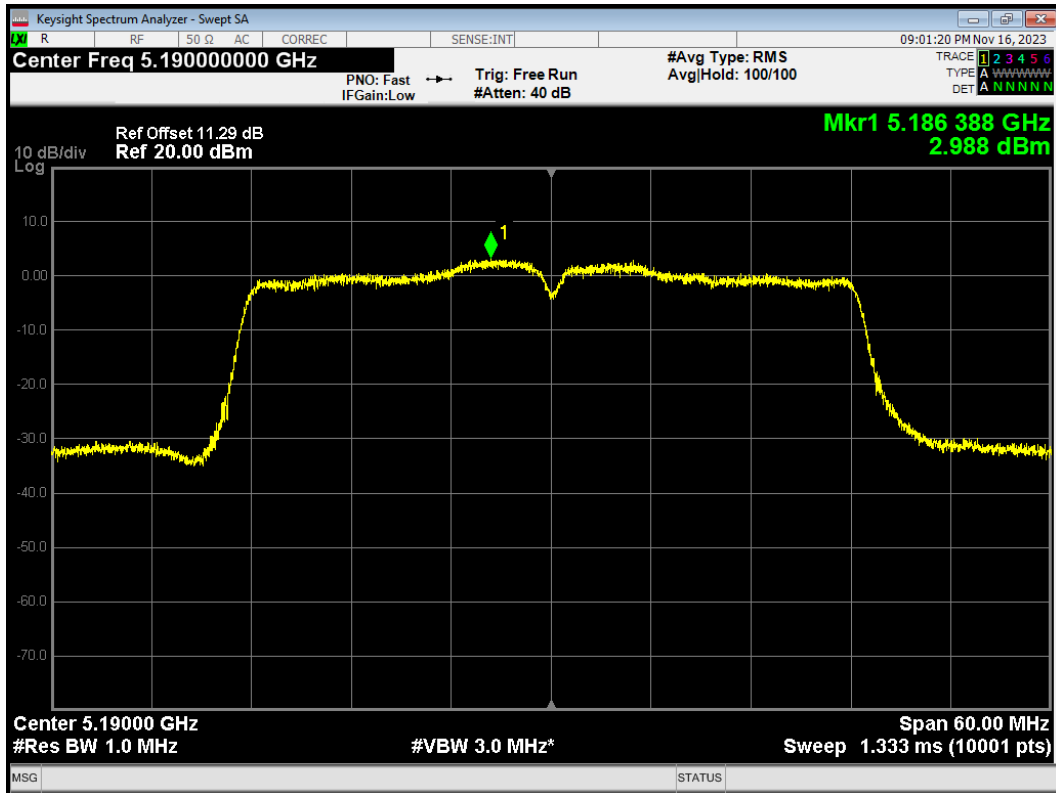

PSD 802.11ac(VHT40) 5190MHz Ant2

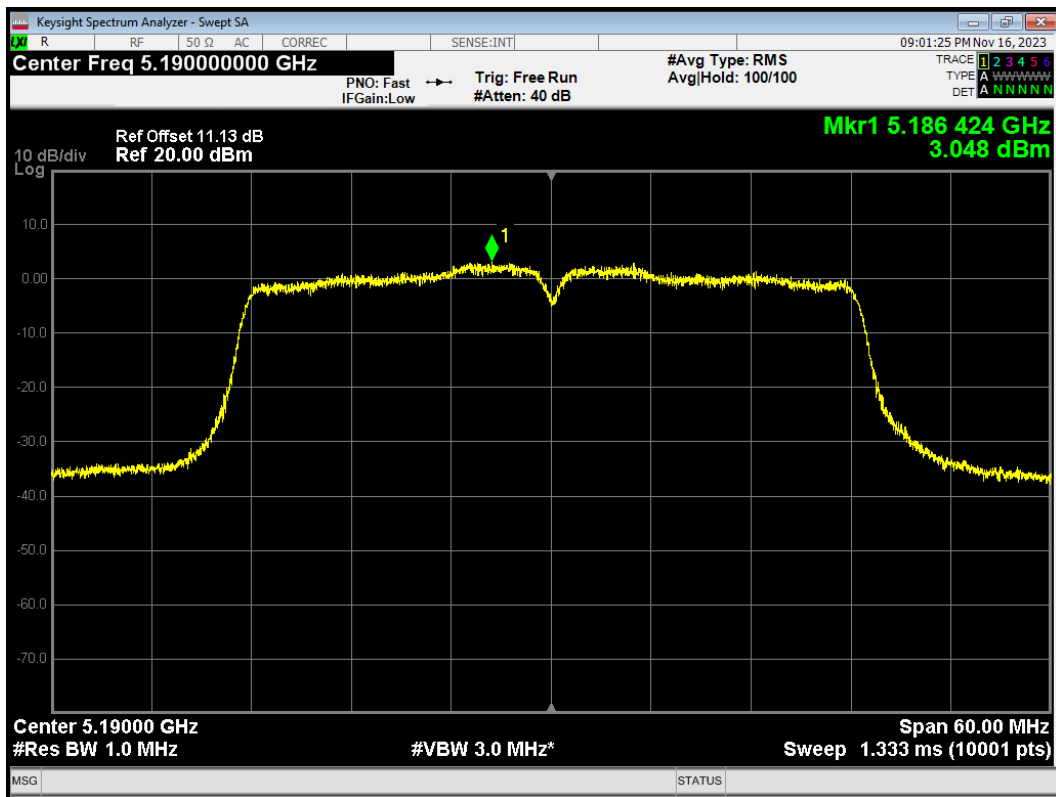

PSD 802.11ac(VHT40) 5230MHz Ant1

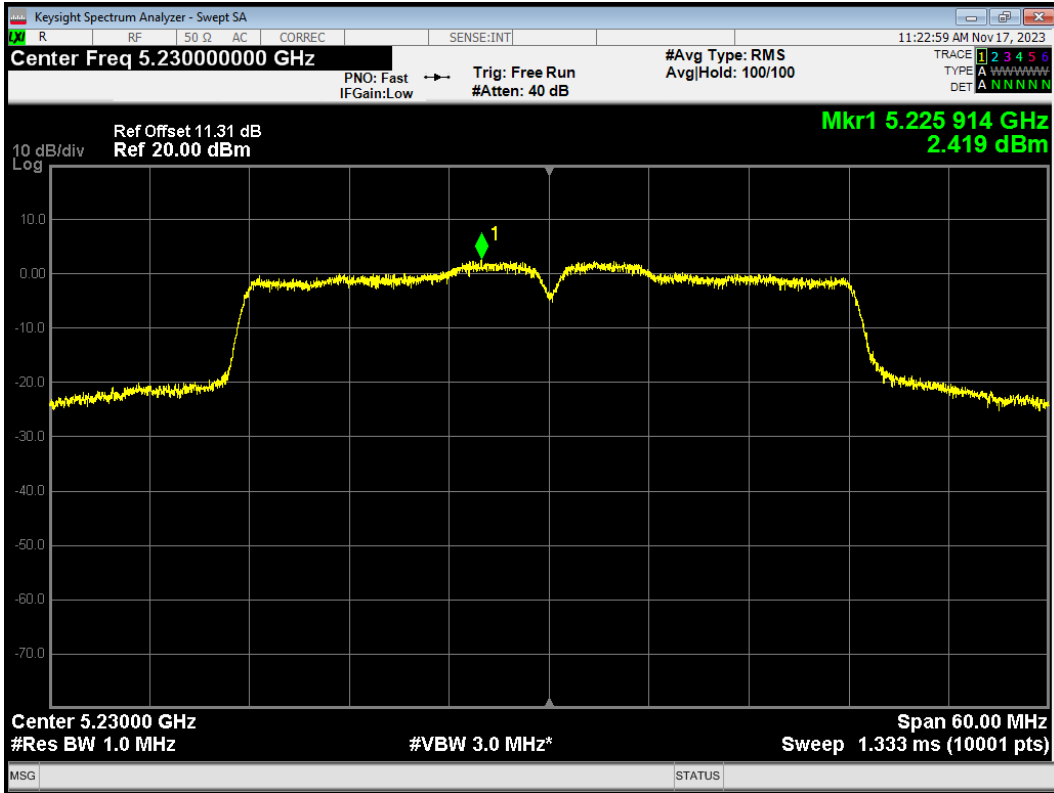

PSD 802.11ac(VHT40) 5230MHz Ant2

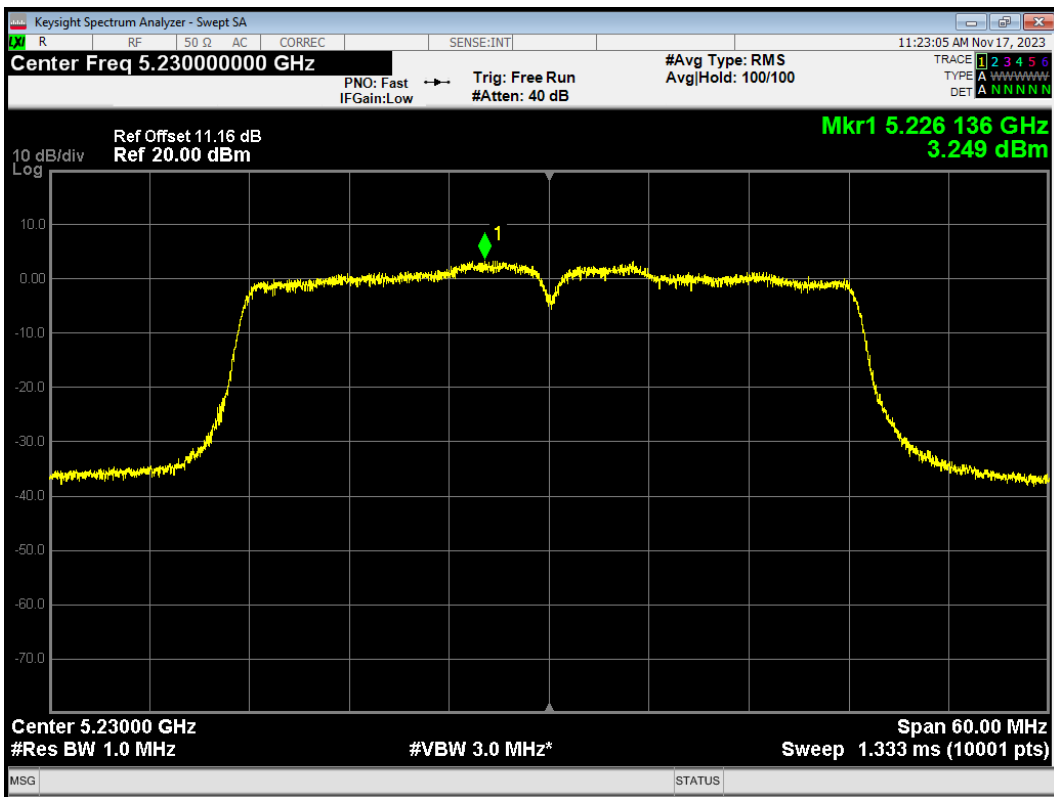

PSD 802.11ac(VHT80) 5210MHz Ant1

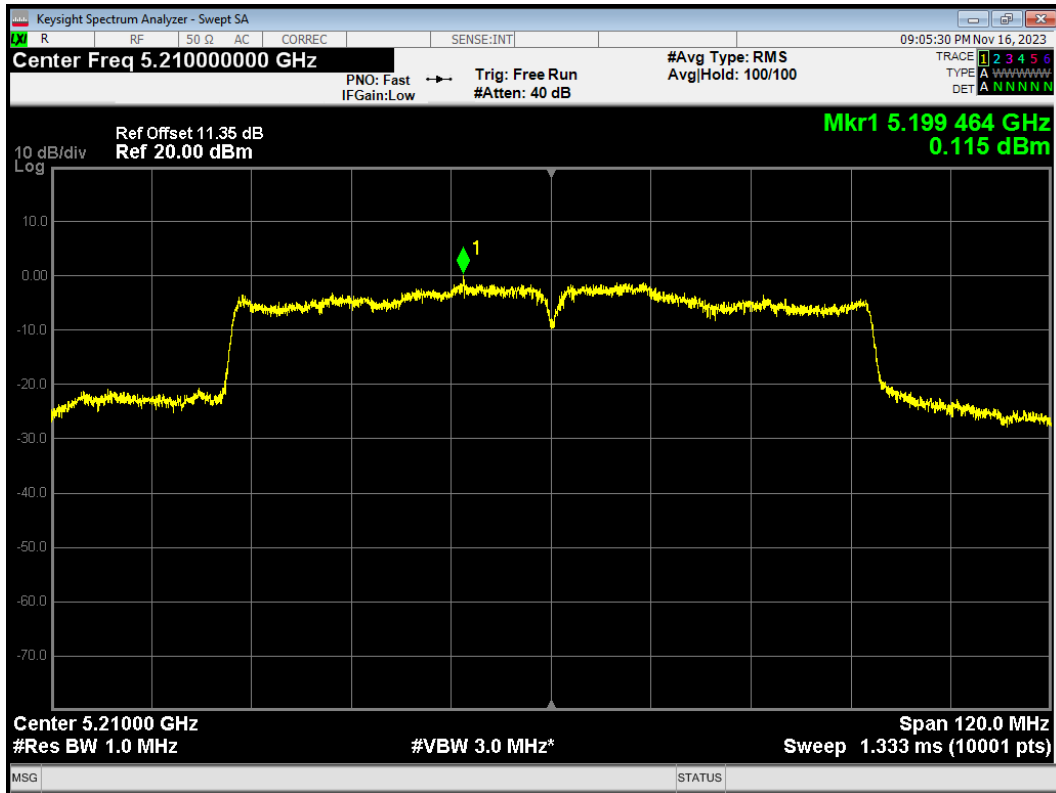

PSD 802.11ac(VHT80) 5210MHz Ant2

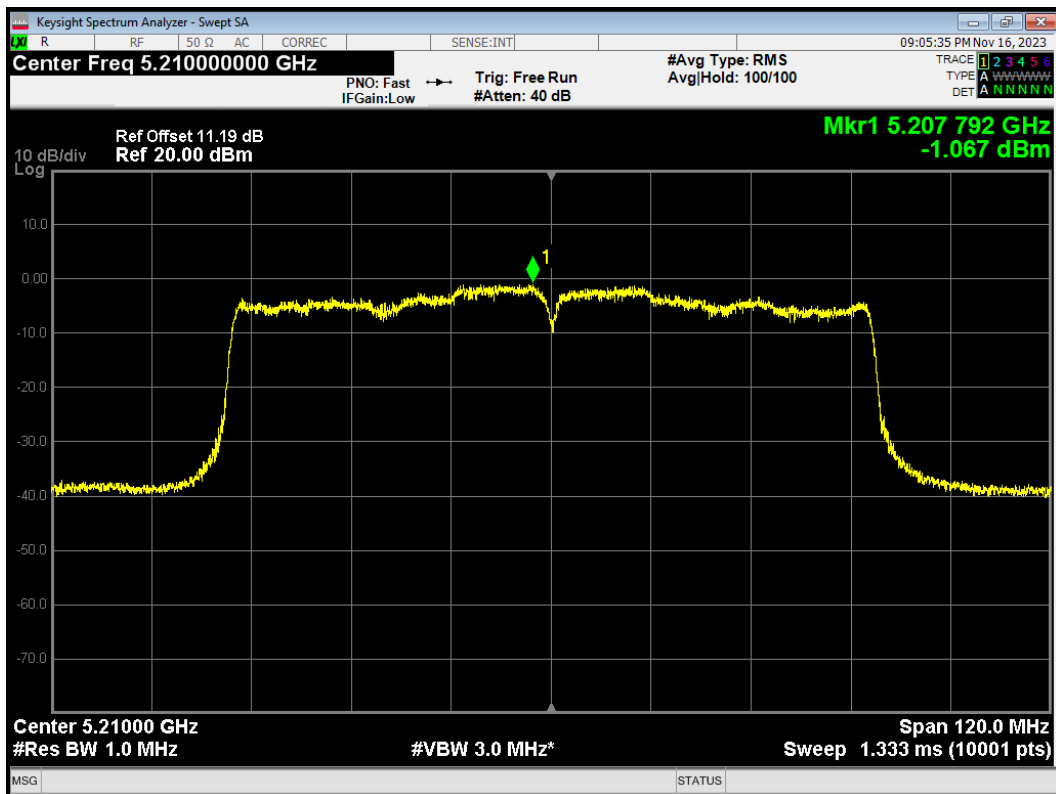

PSD 802.11ax(HE20) 5180MHz Ant1

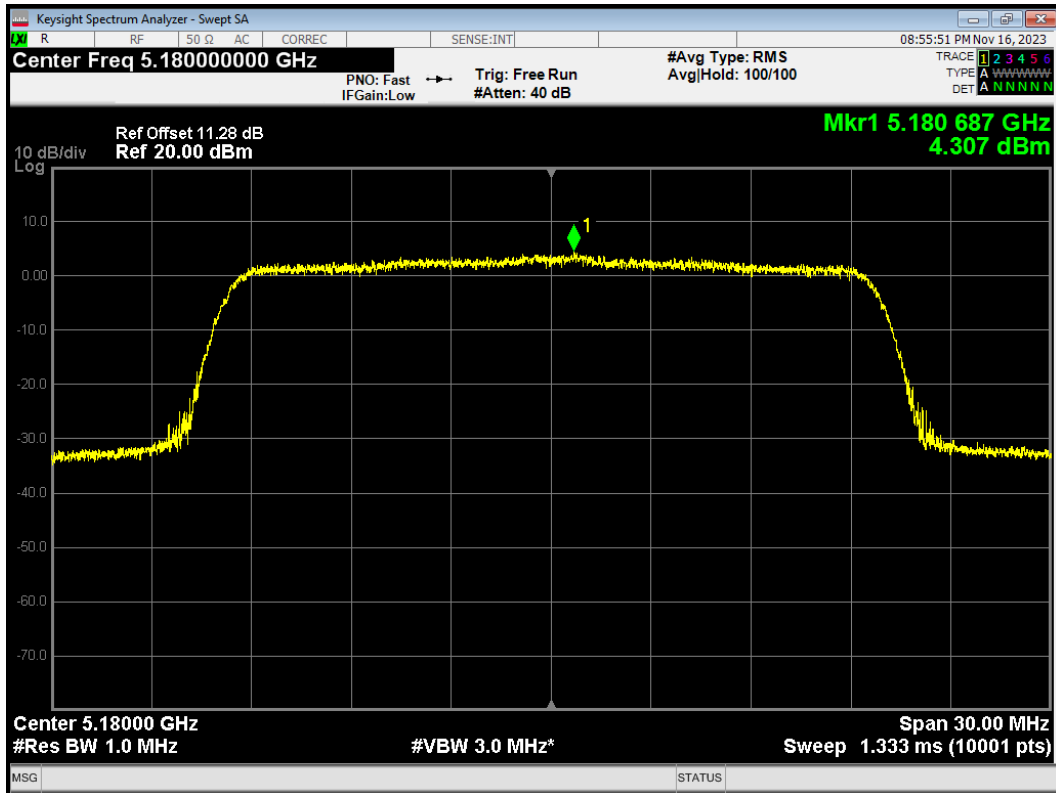

PSD 802.11ax(HE20) 5180MHz Ant2

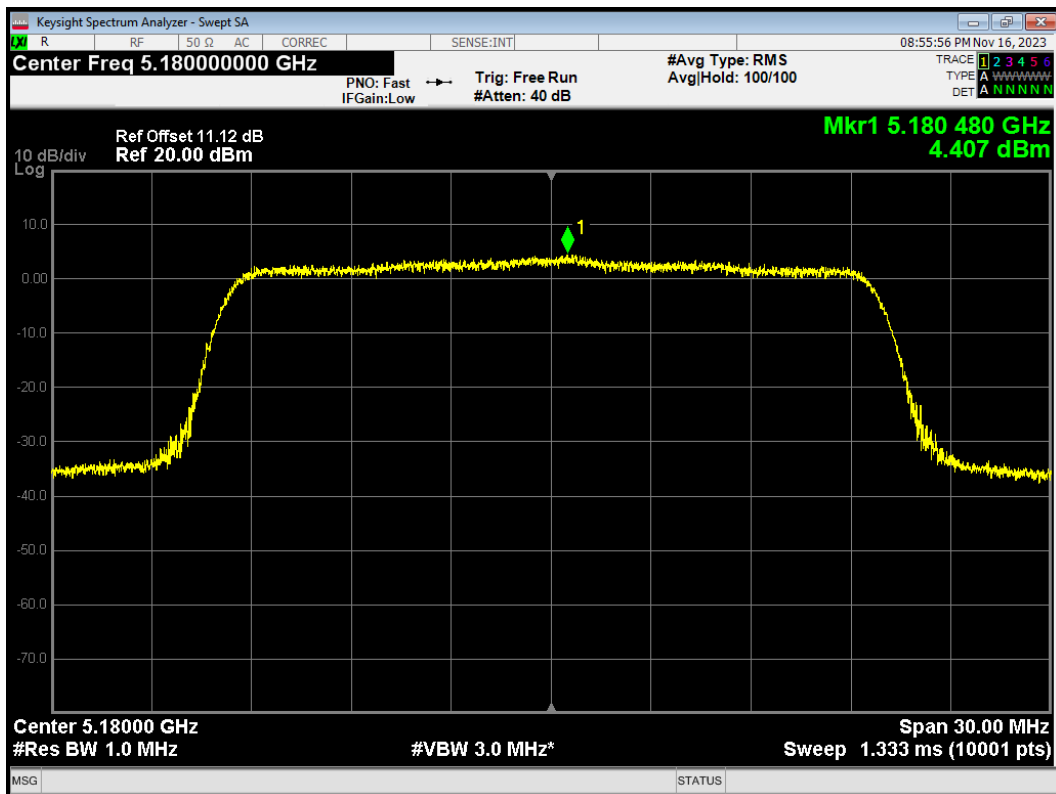

PSD 802.11ax(HE20) 5200MHz Ant1

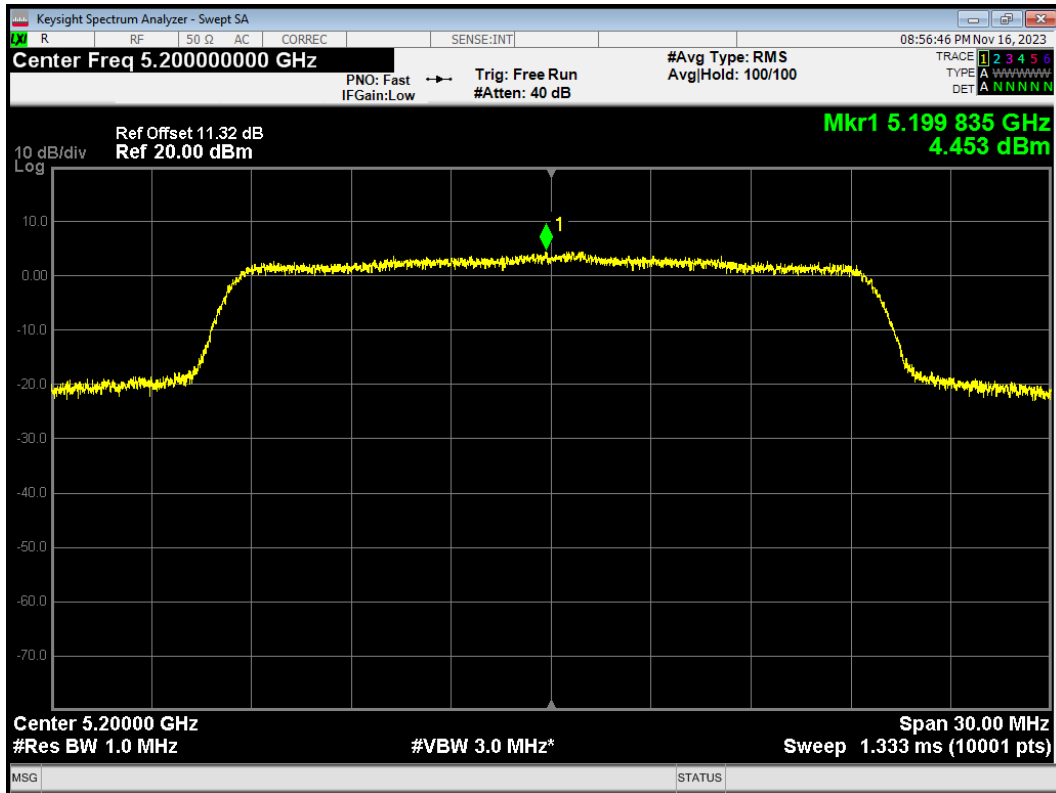

PSD 802.11ax(HE20) 5200MHz Ant2

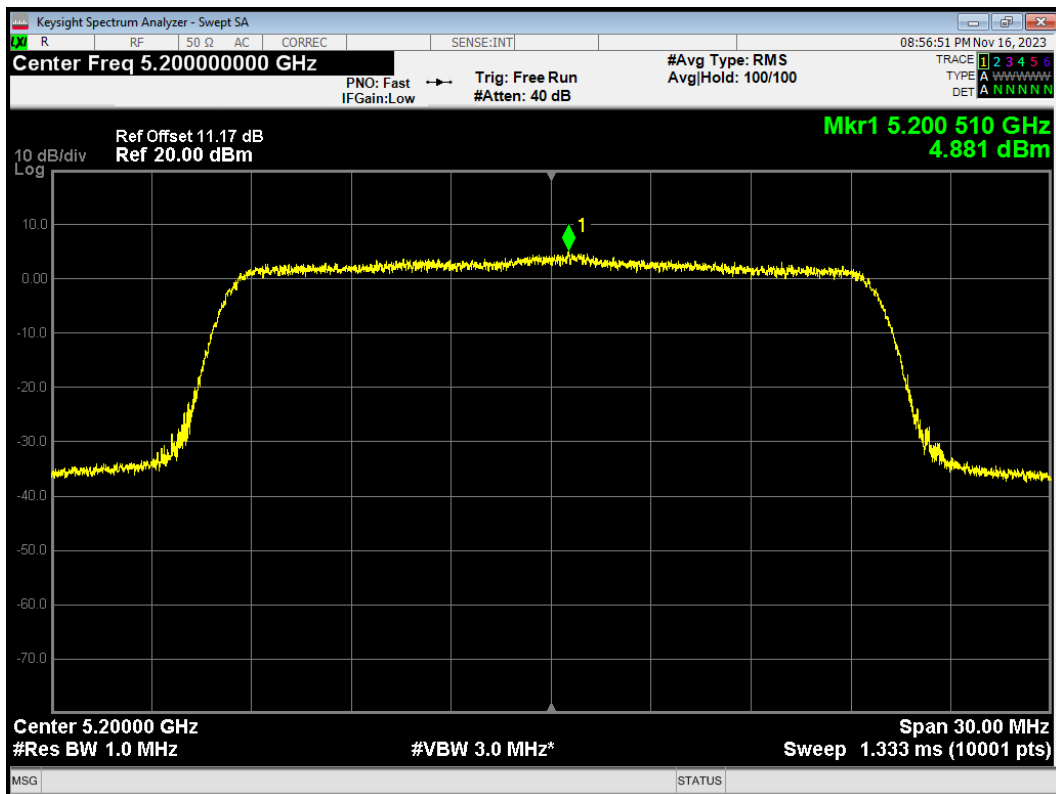

PSD 802.11ax(HE20) 5240MHz Ant1

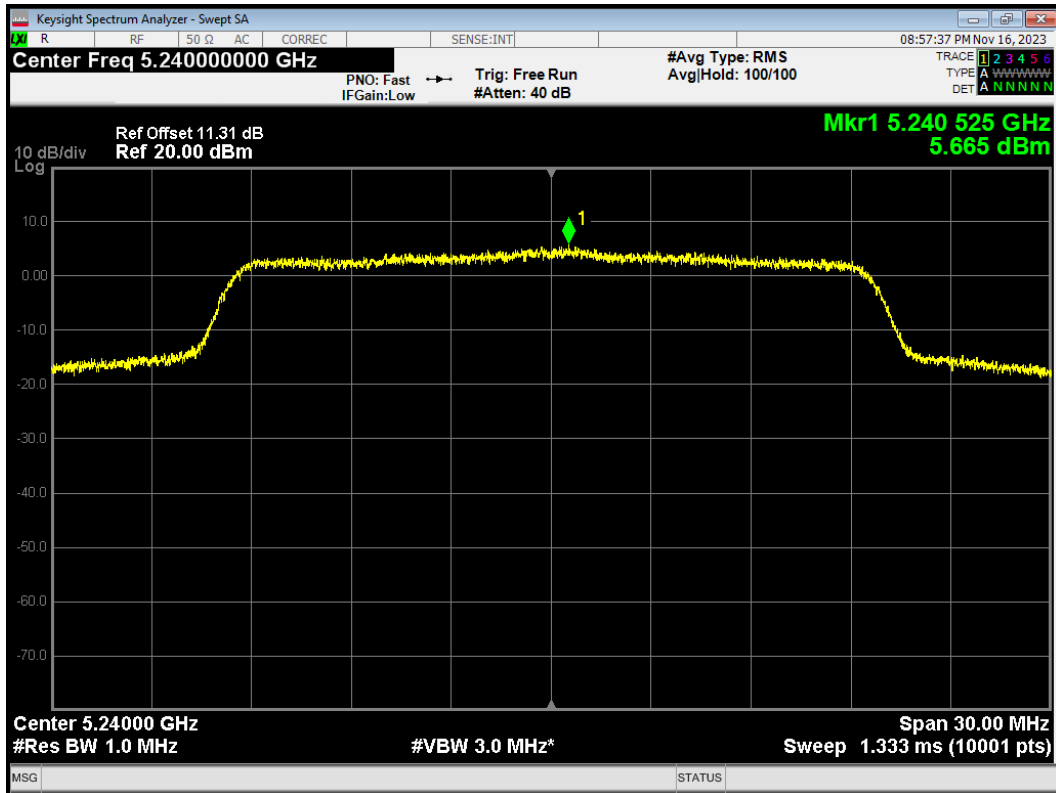

PSD 802.11ax(HE20) 5240MHz Ant2

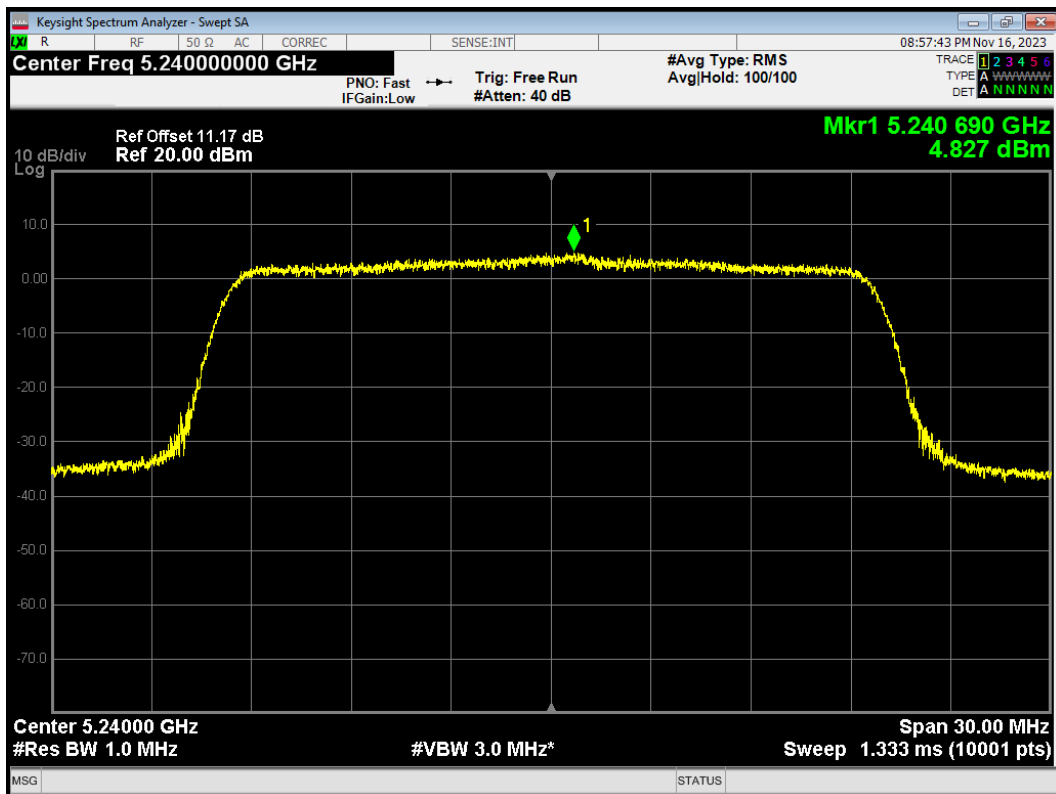

PSD 802.11ax(HE40) 5190MHz Ant1

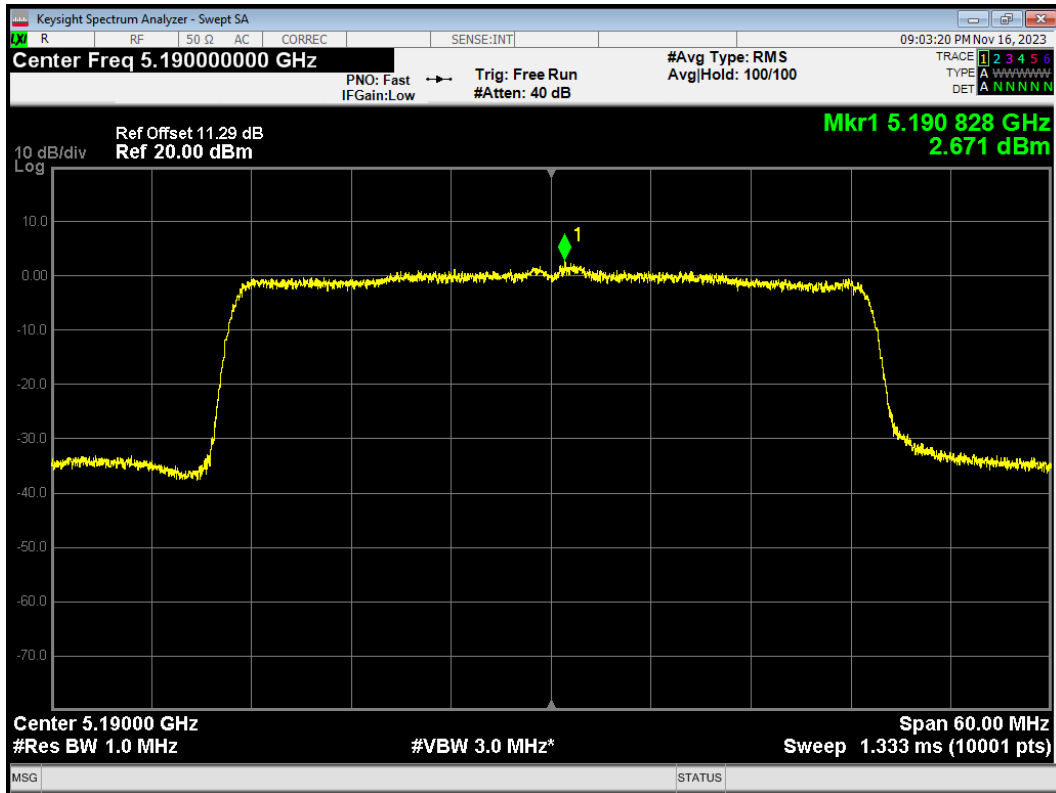

PSD 802.11ax(HE40) 5190MHz Ant2

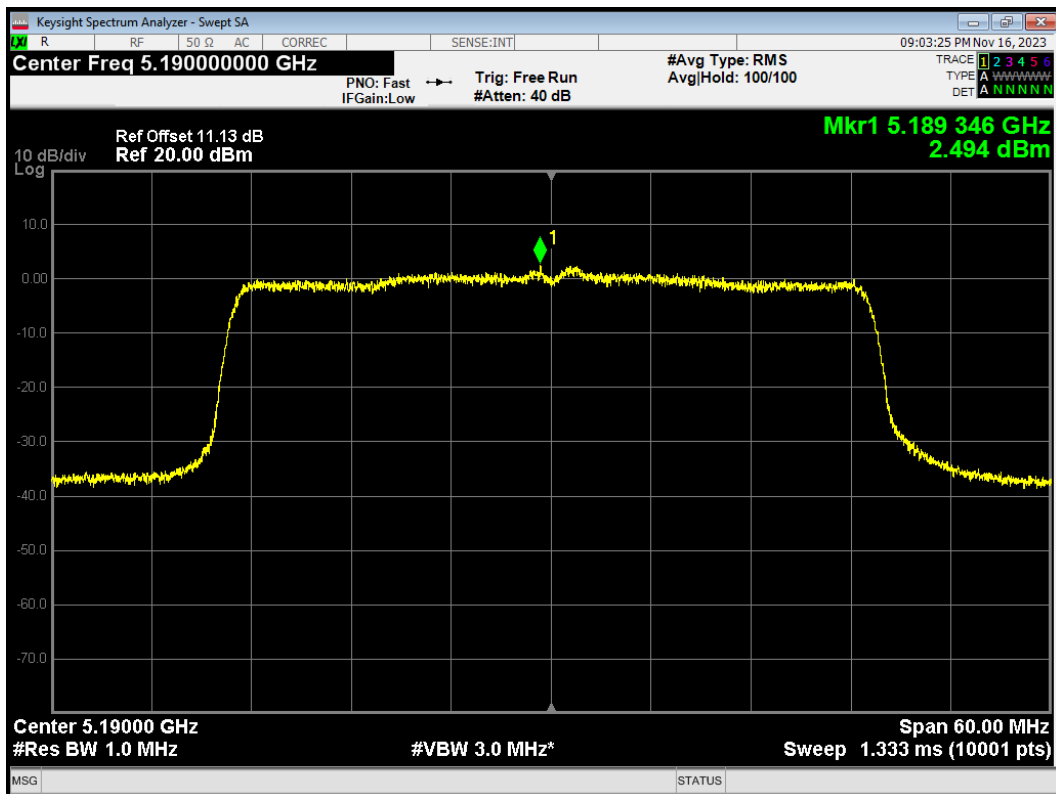

PSD 802.11ax(HE40) 5230MHz Ant1

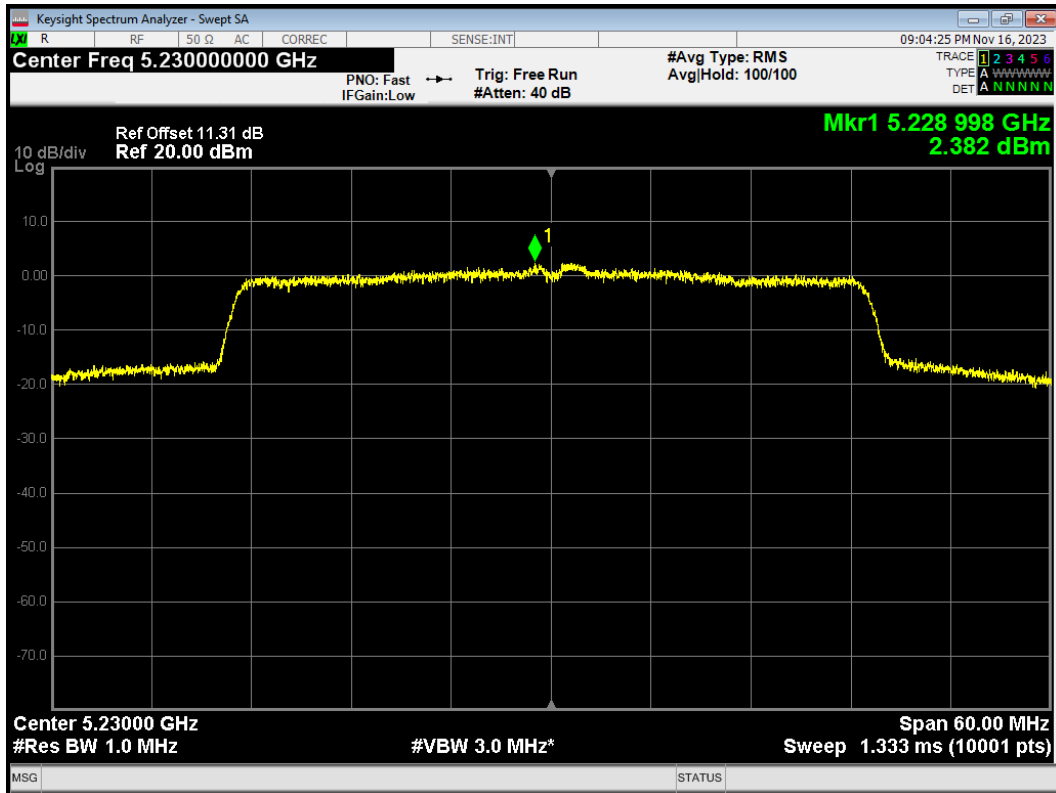

PSD 802.11ax(HE40) 5230MHz Ant2

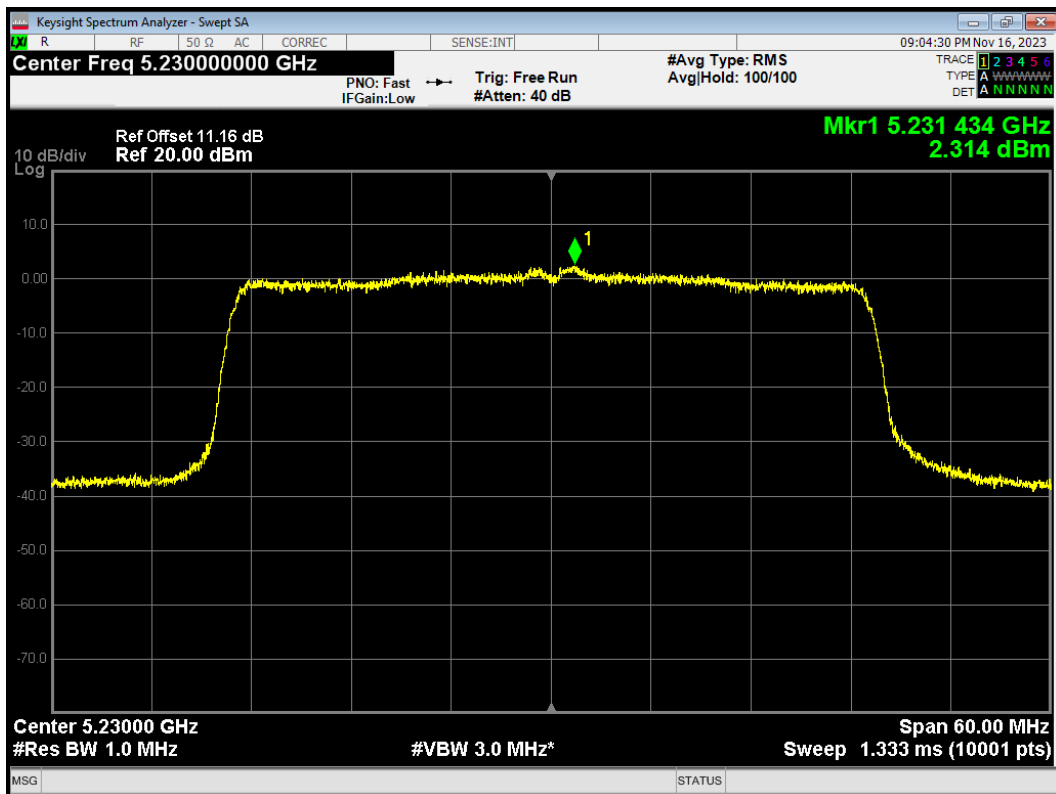

PSD 802.11ax(HE80) 5210MHz Ant1

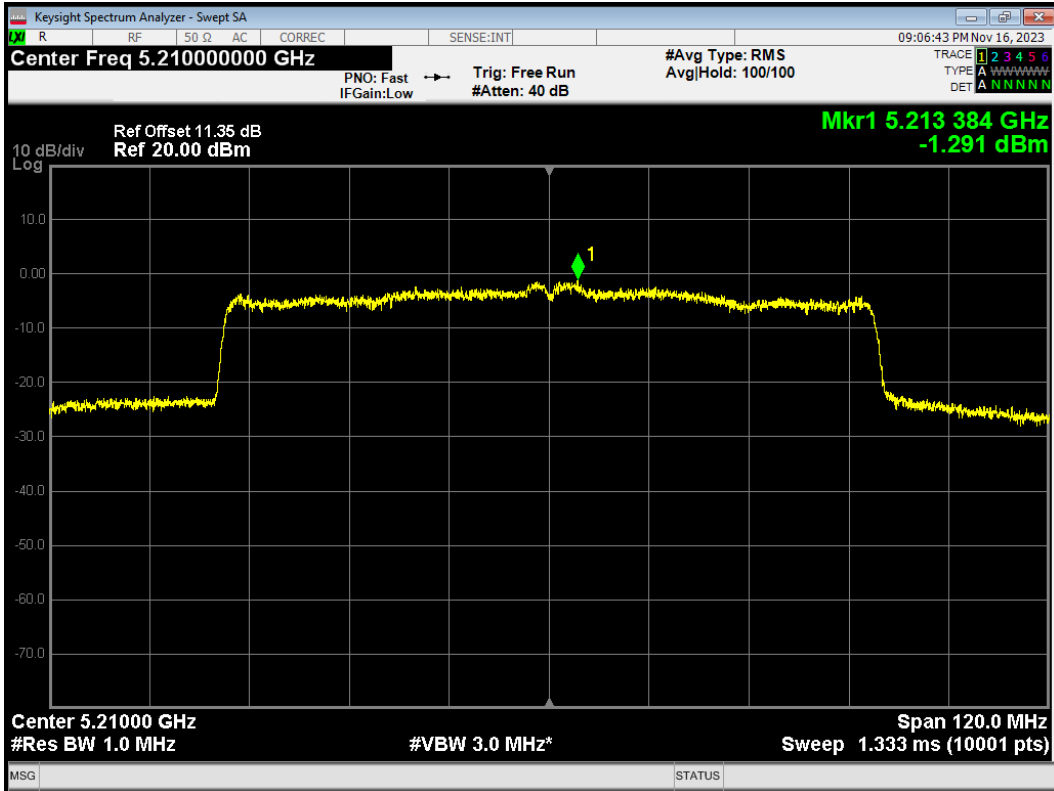

PSD 802.11ax(HE80) 5210MHz Ant2

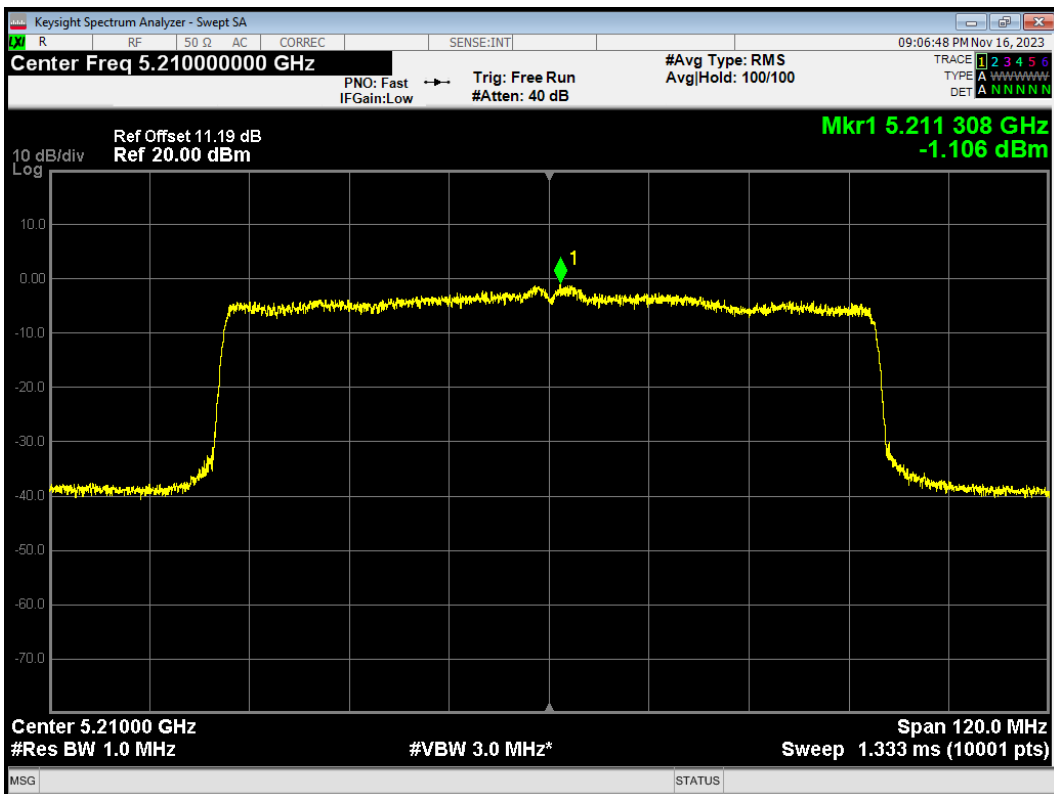

PSD 802.11n(HT20) 5180MHz Ant1

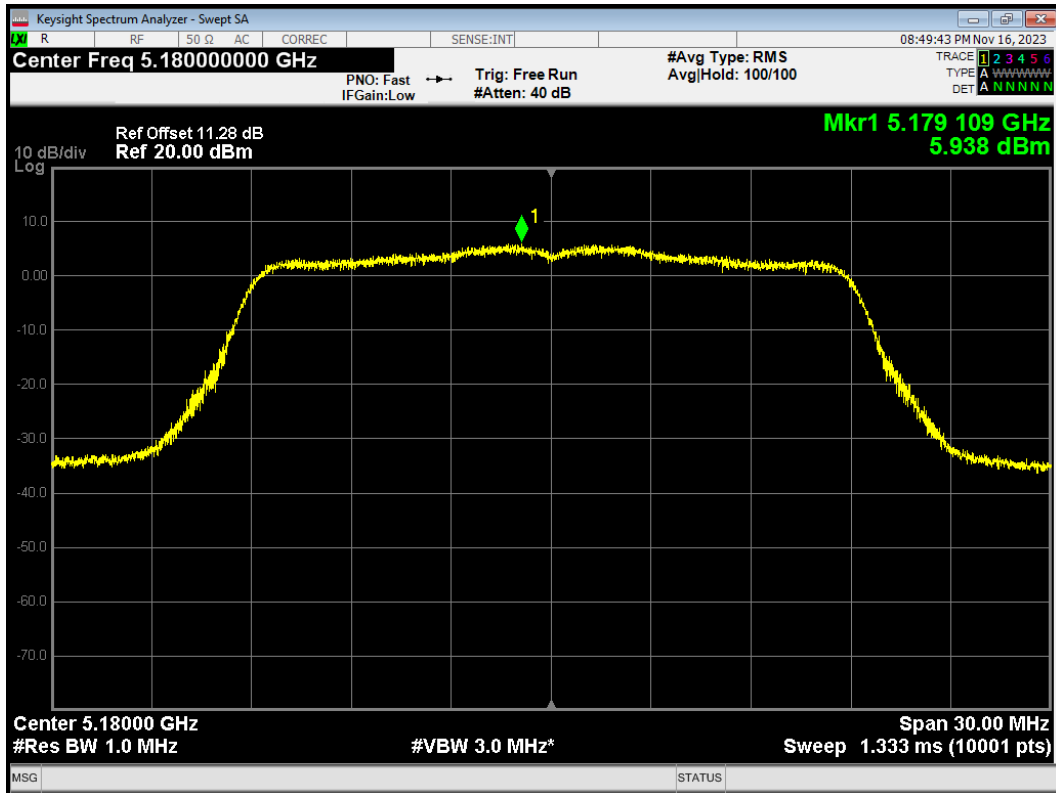

PSD 802.11n(HT20) 5180MHz Ant2

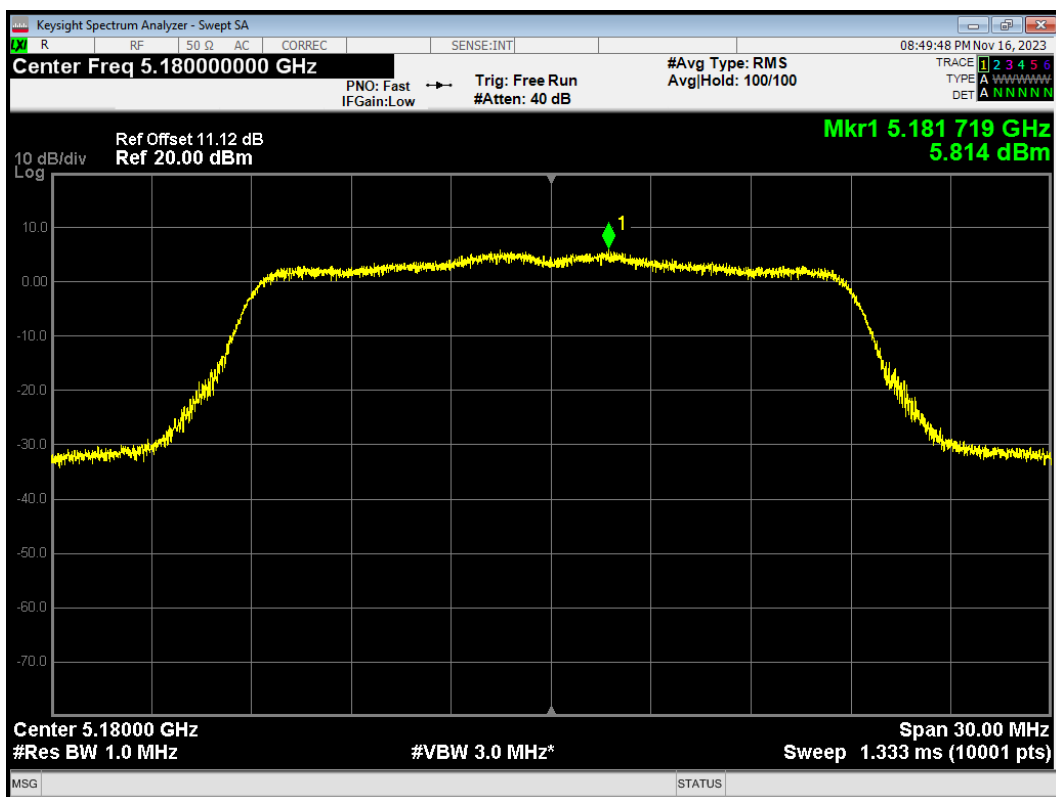

PSD 802.11n(HT20) 5200MHz Ant1

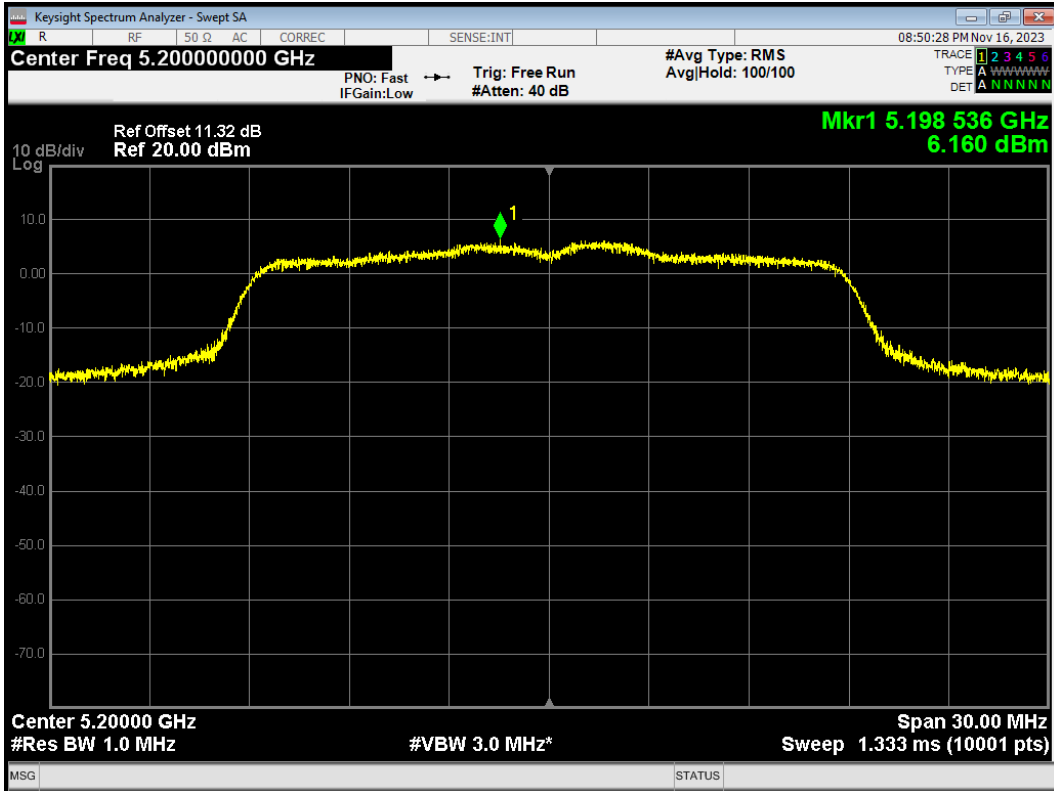

PSD 802.11n(HT20) 5200MHz Ant2

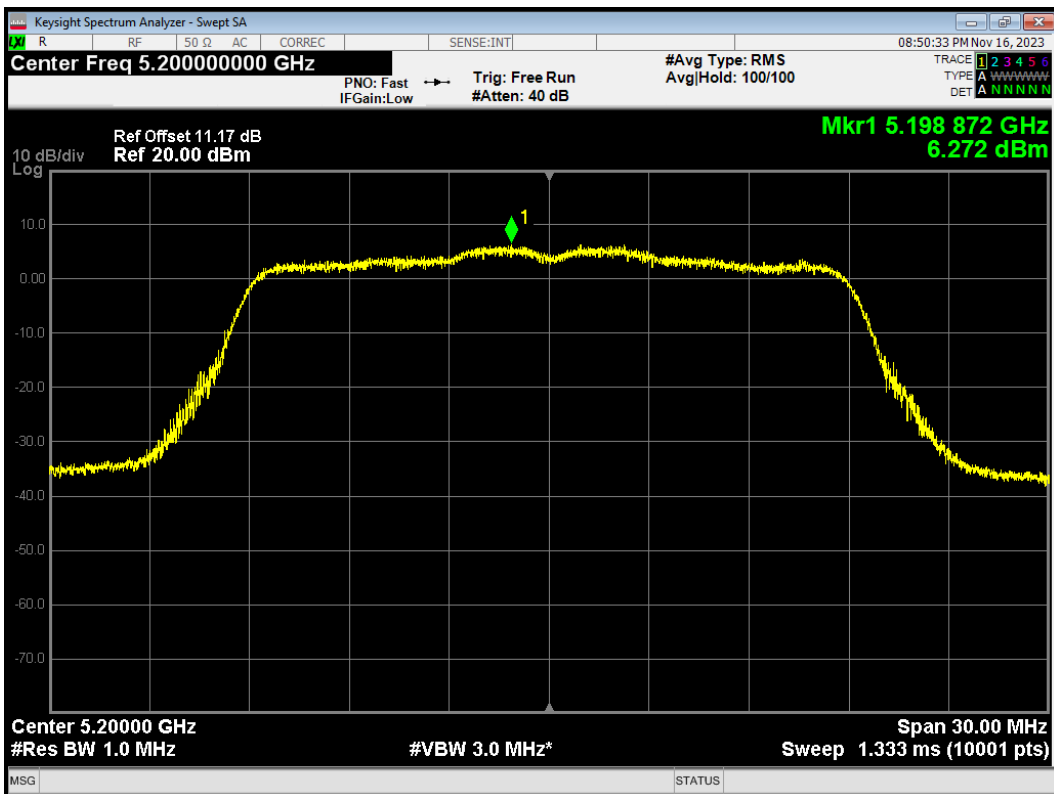

PSD 802.11n(HT20) 5240MHz Ant1

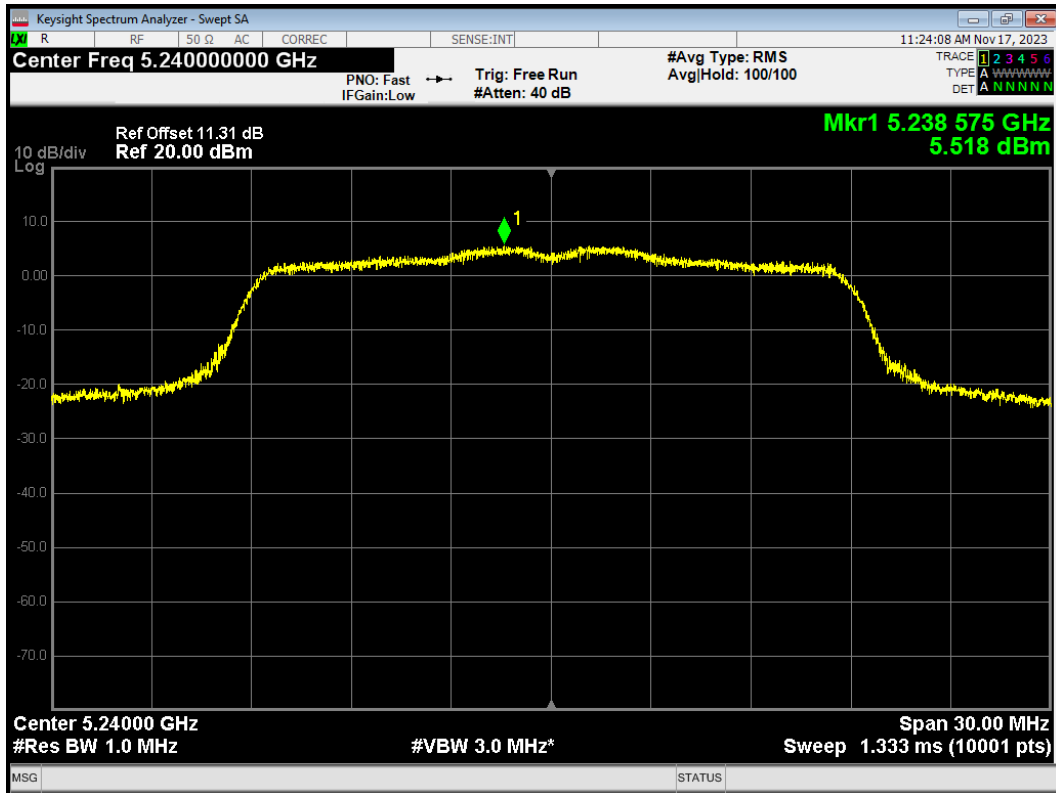

PSD 802.11n(HT20) 5240MHz Ant2

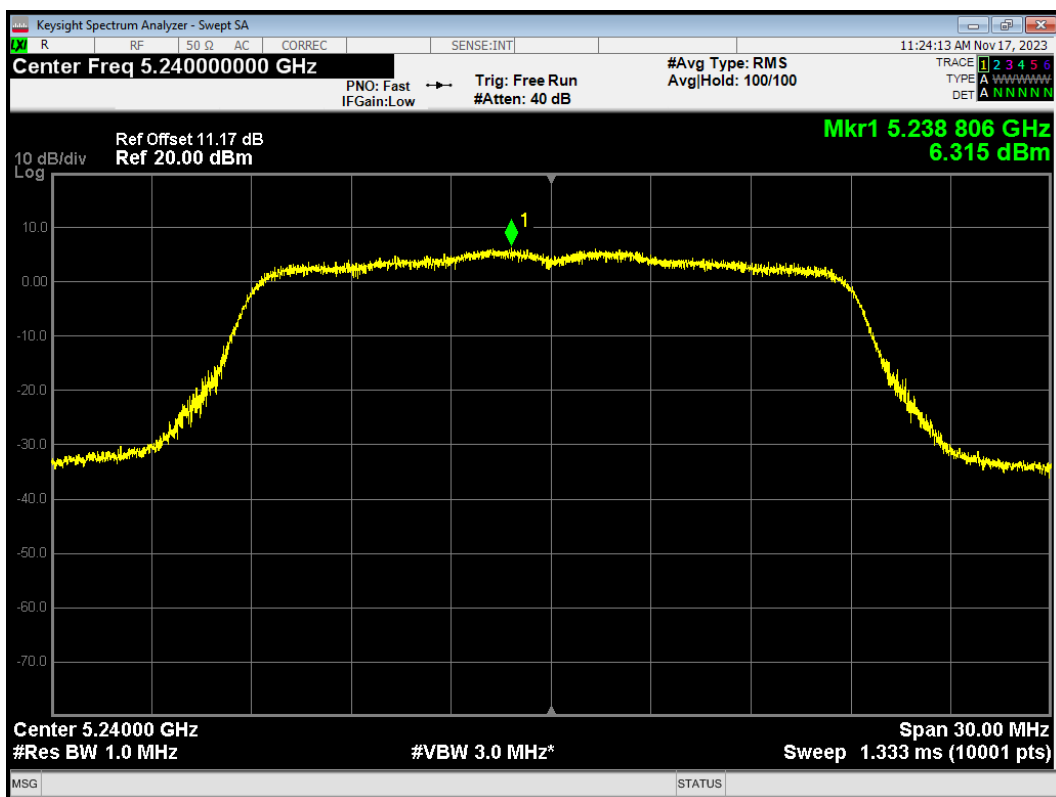

PSD 802.11n(HT40) 5190MHz Ant1

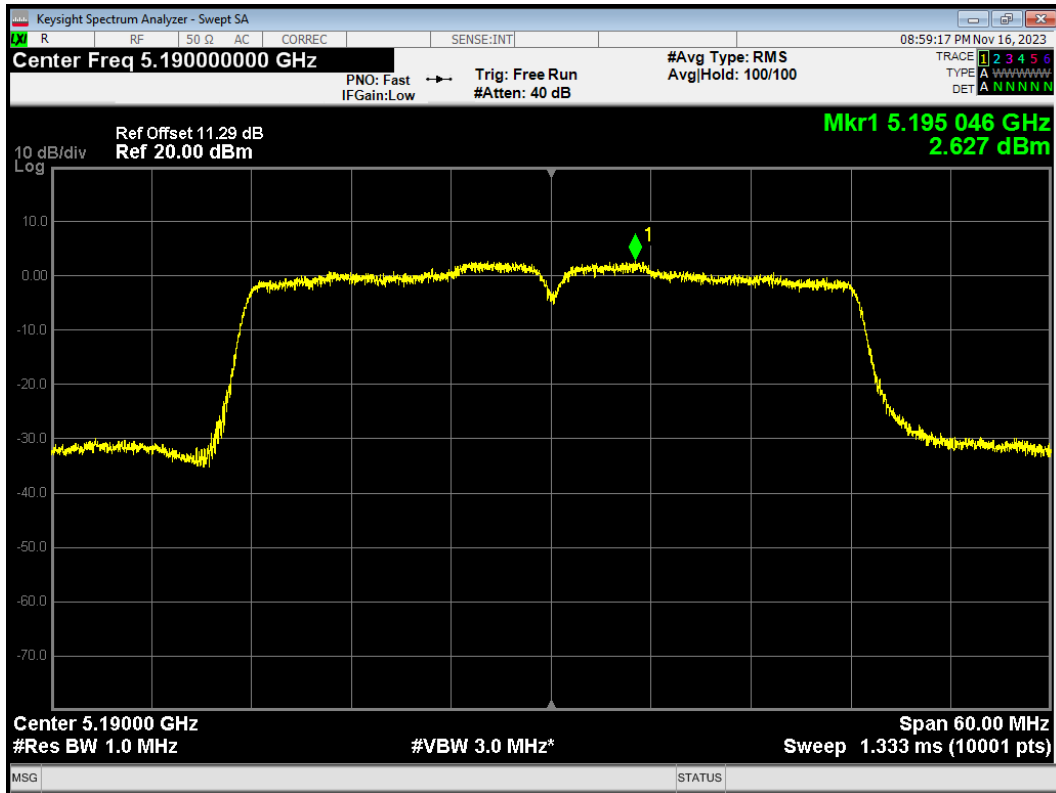

PSD 802.11n(HT40) 5190MHz Ant2

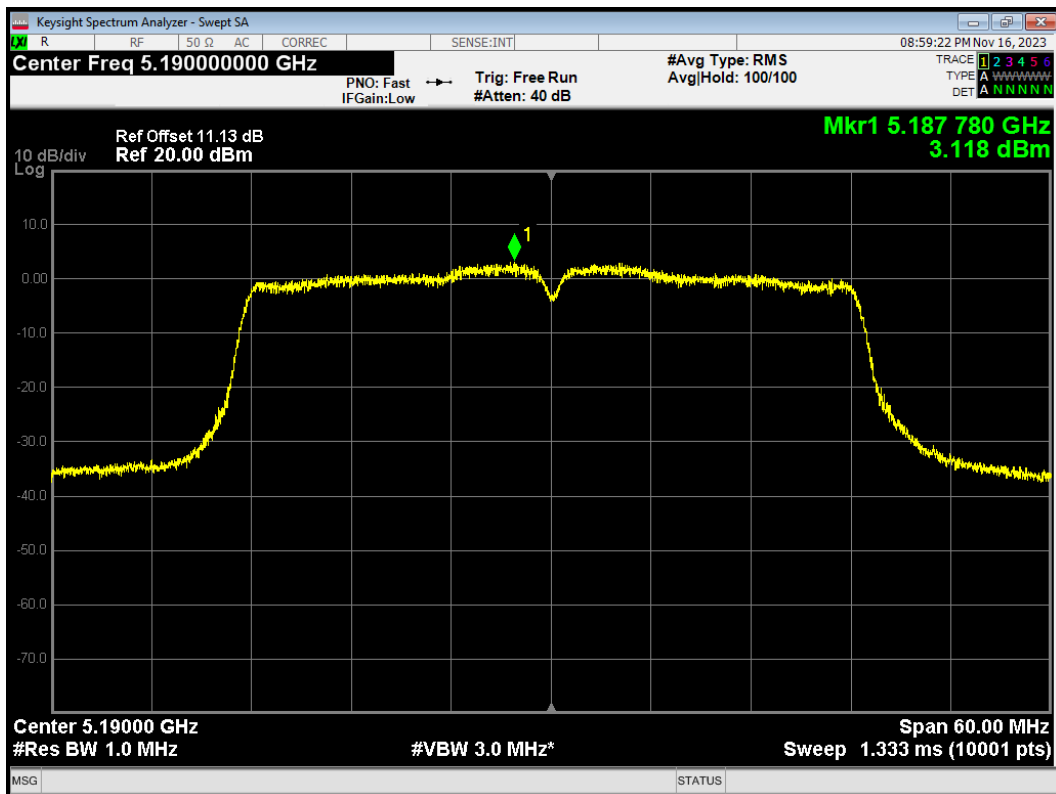

PSD 802.11n(HT40) 5230MHz Ant1

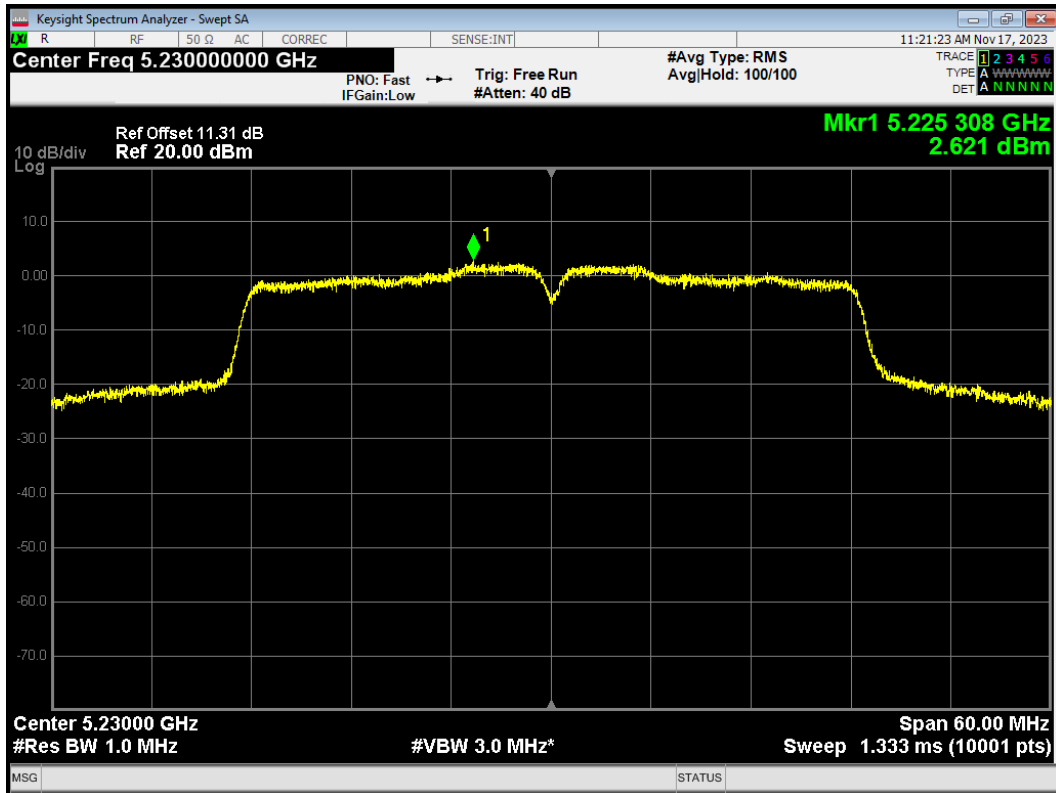

PSD 802.11n(HT40) 5230MHz Ant2

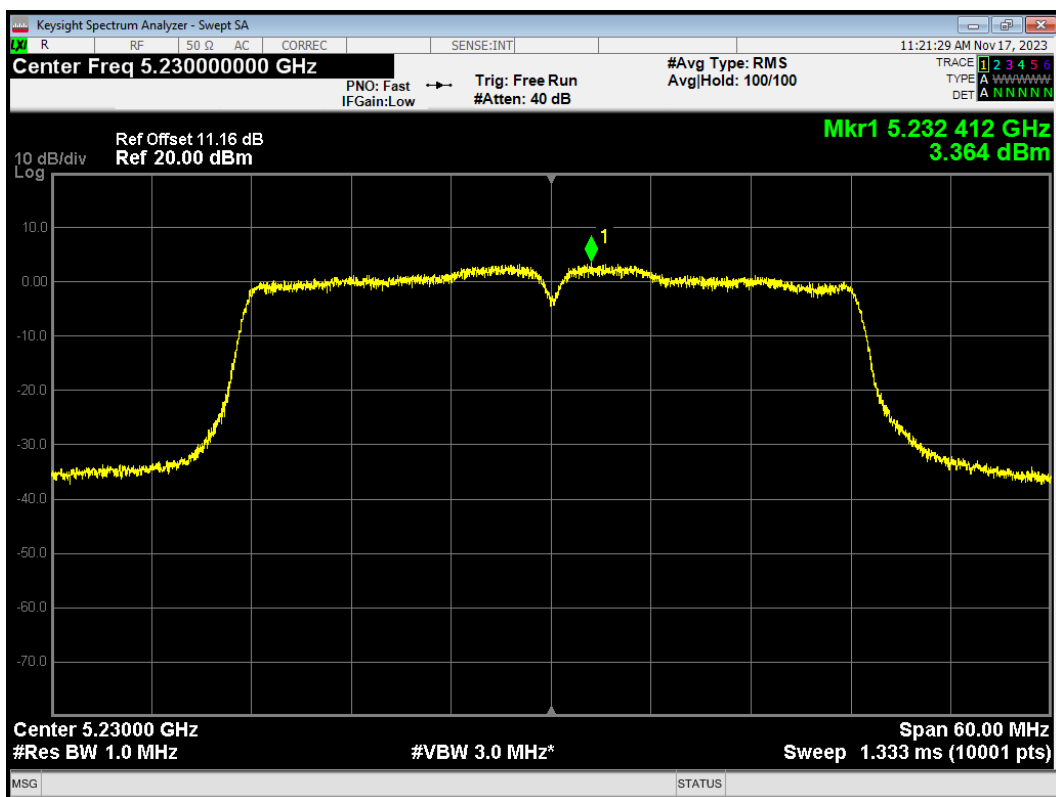

U-NII-2A

PSD 802.11ac(VHT20) 5260MHz Ant1

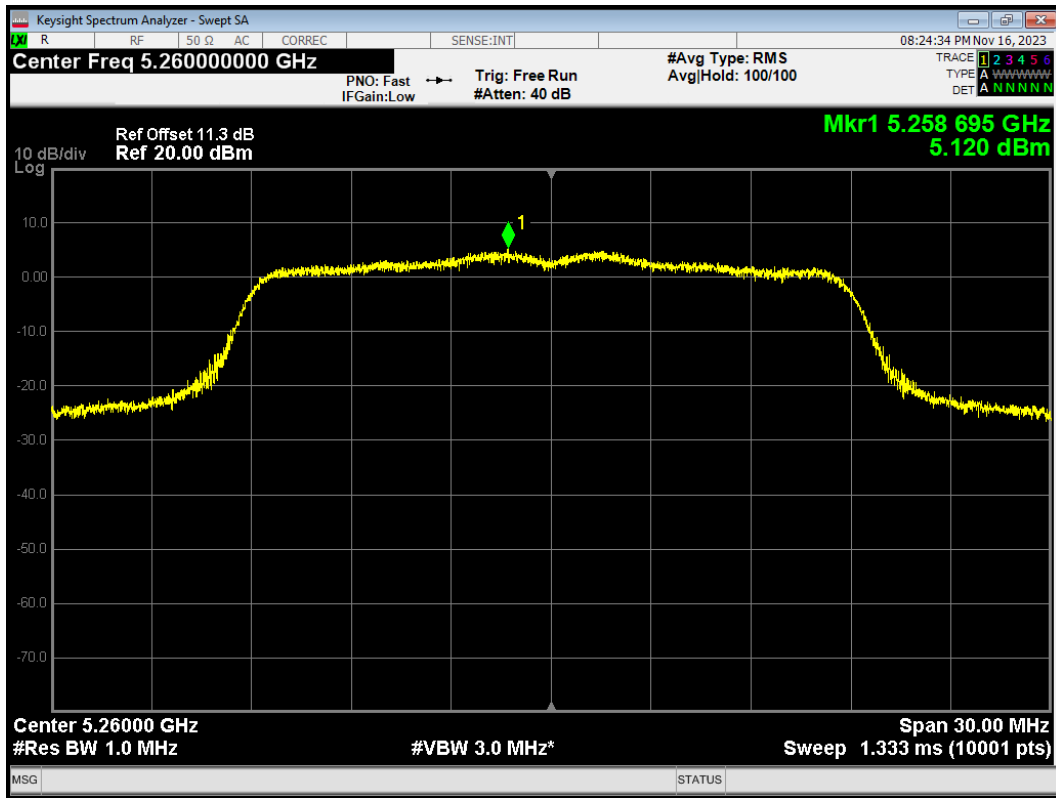

PSD 802.11ac(VHT20) 5260MHz Ant2

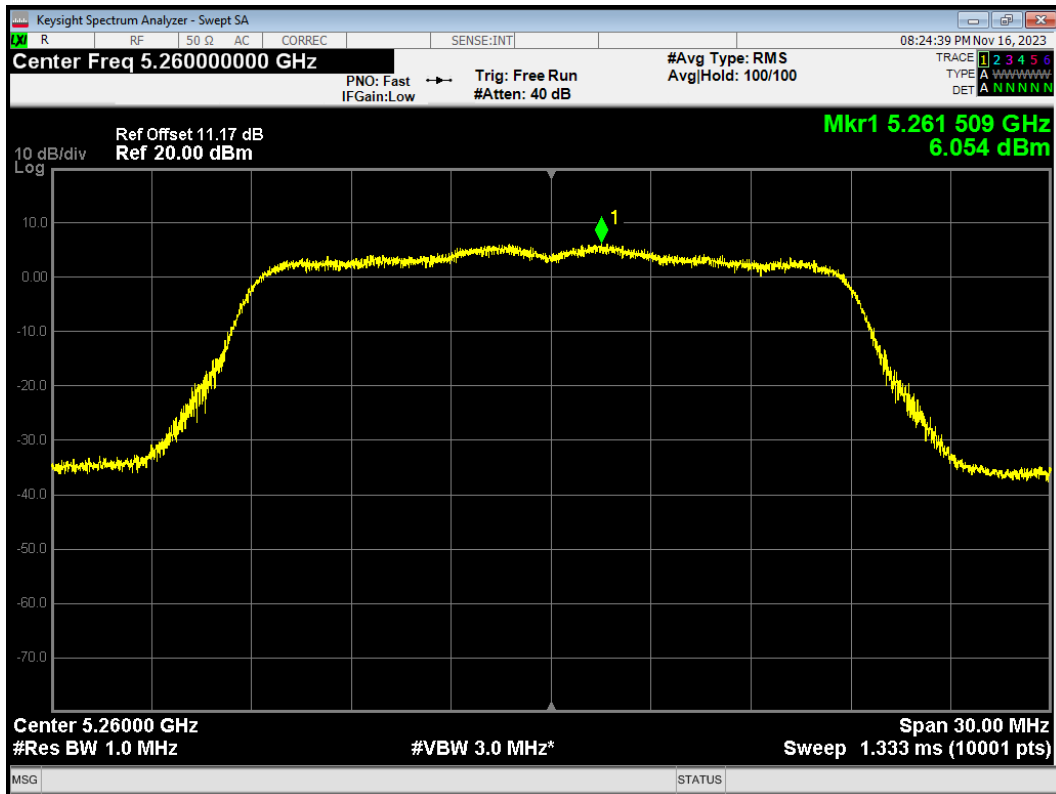

PSD 802.11ac(VHT20) 5300MHz Ant1

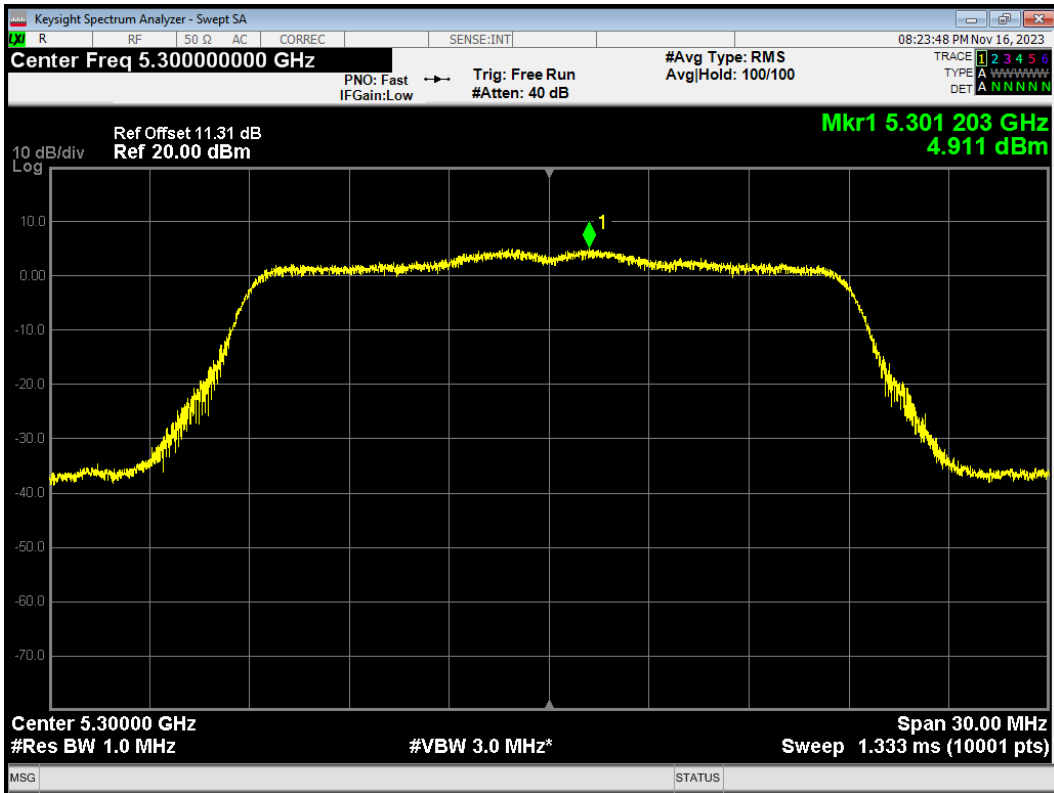

PSD 802.11ac(VHT20) 5300MHz Ant2

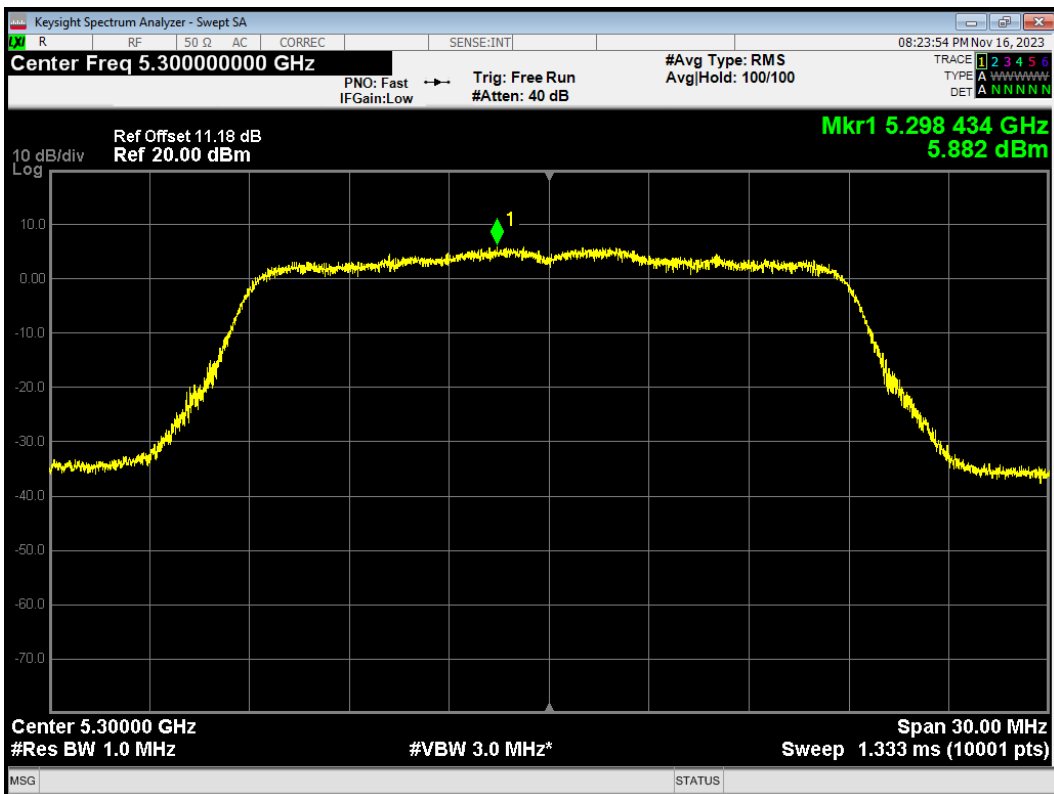

PSD 802.11ac(VHT20) 5320MHz Ant1

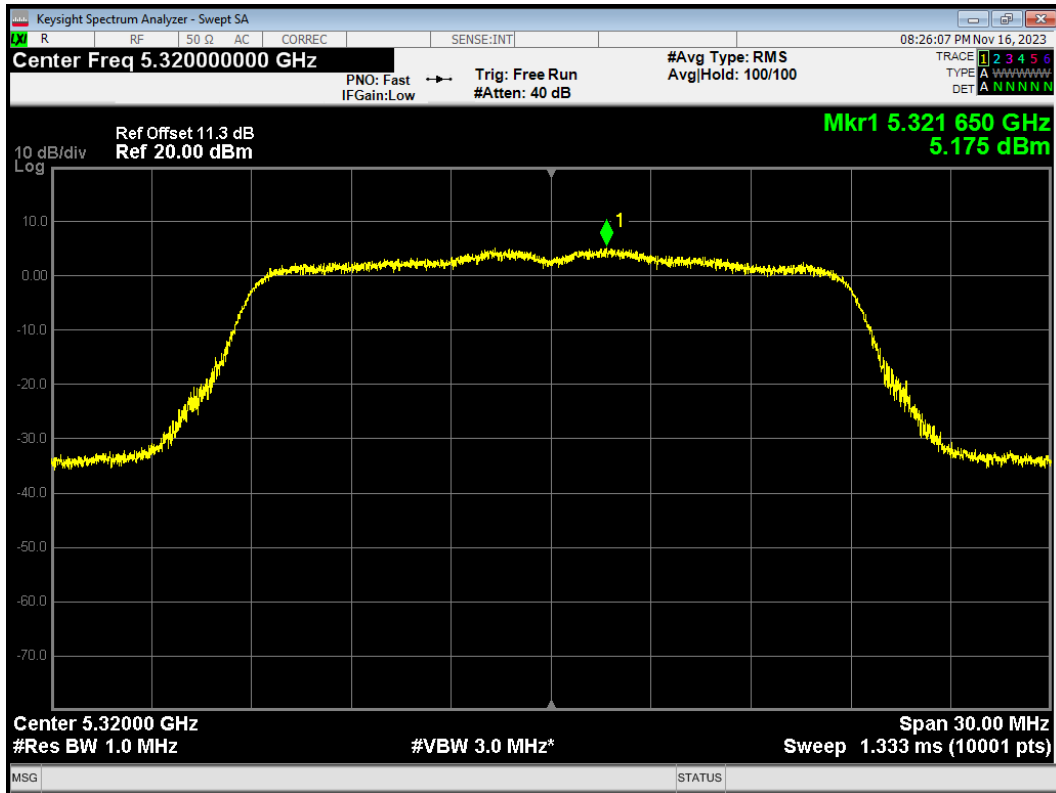

PSD 802.11ac(VHT20) 5320MHz Ant2

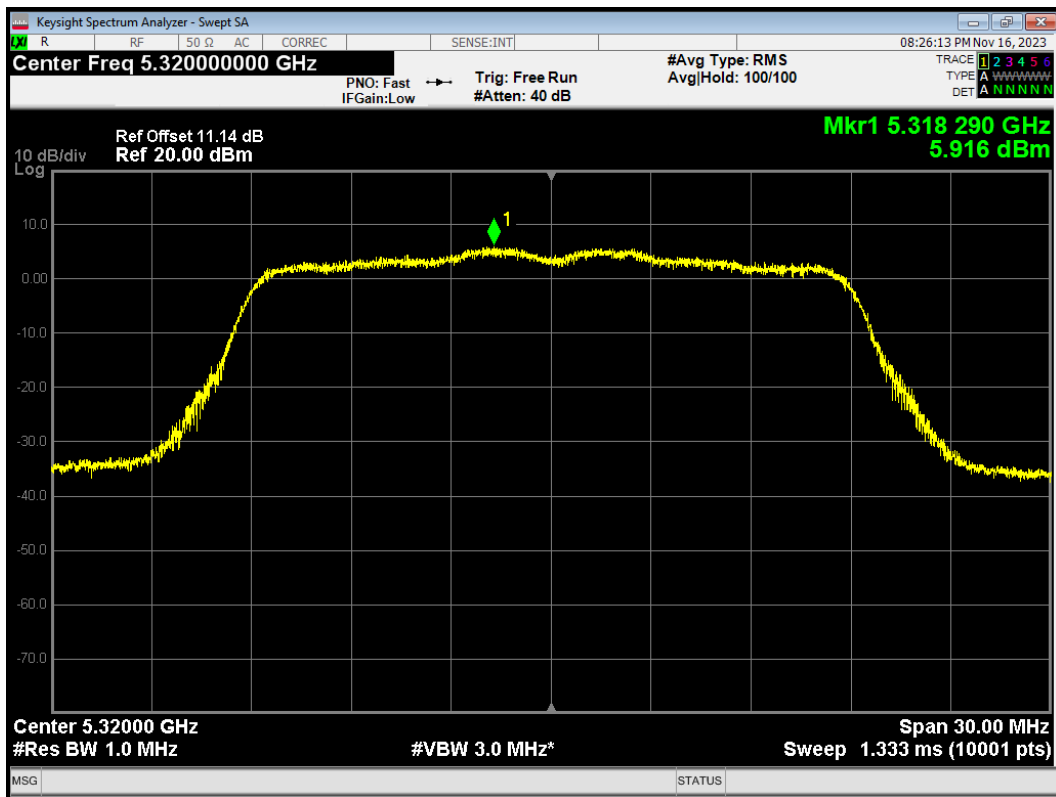

PSD 802.11ac(VHT40) 5270MHz Ant1

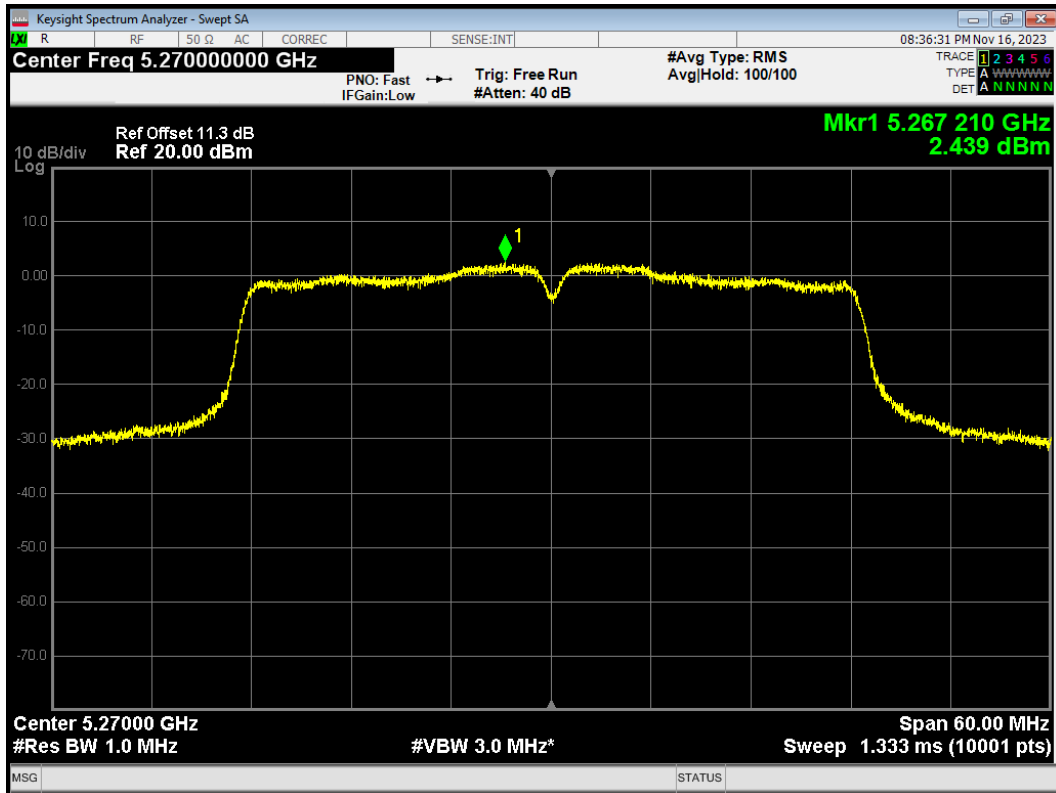

PSD 802.11ac(VHT40) 5270MHz Ant2

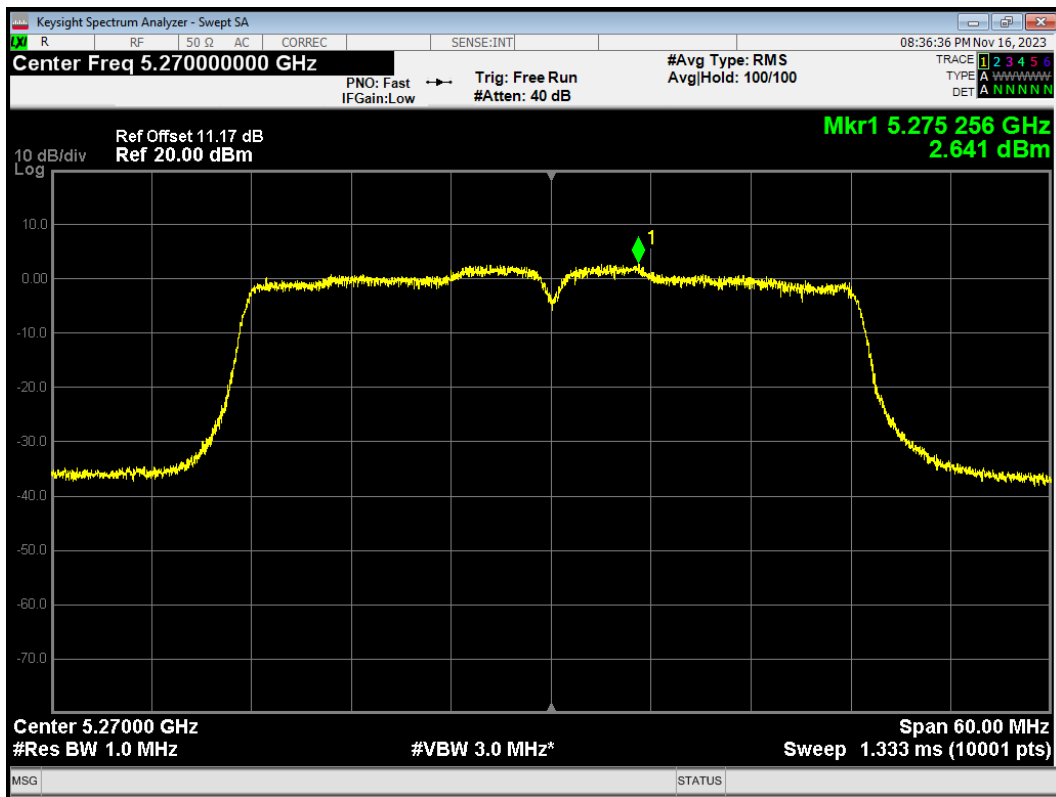

PSD 802.11ac(VHT40) 5310MHz Ant1

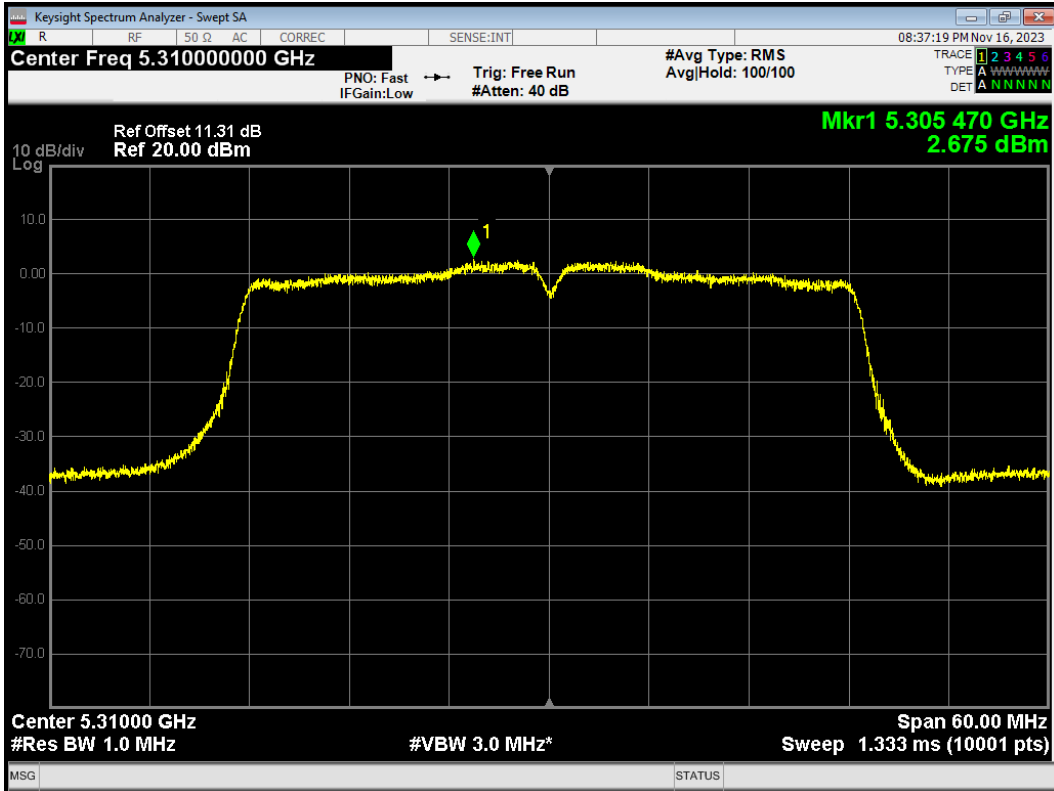

PSD 802.11ac(VHT40) 5310MHz Ant2

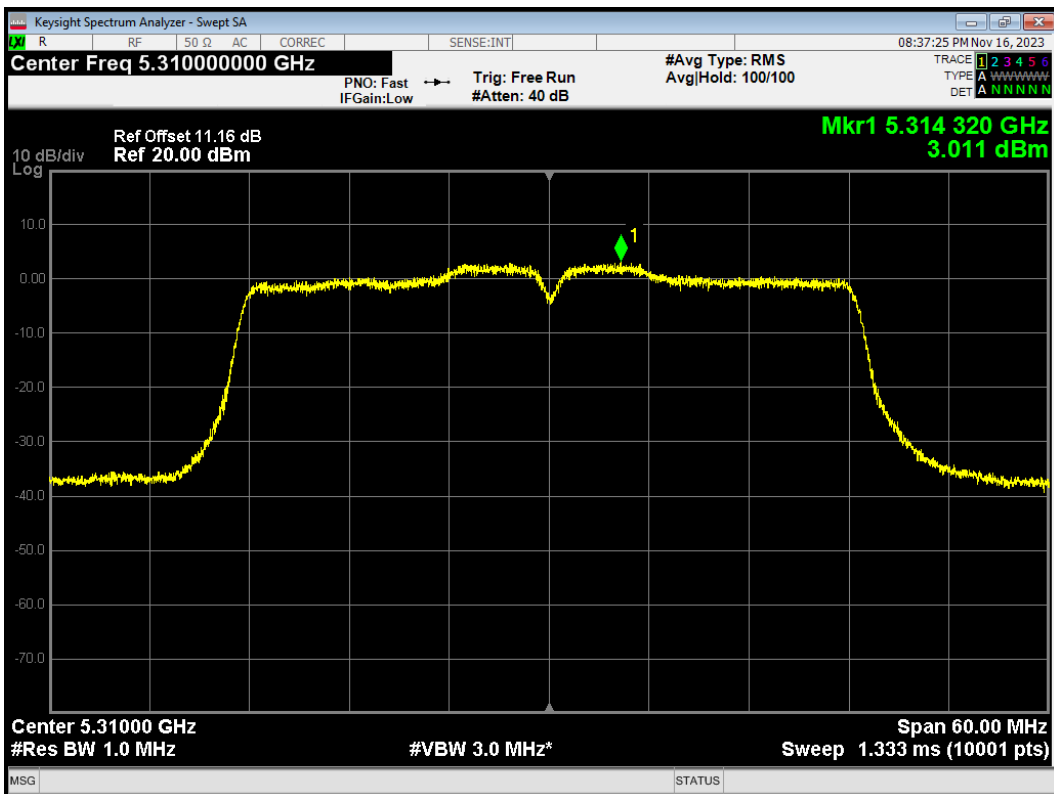

PSD 802.11ac(VHT80) 5290MHz Ant1

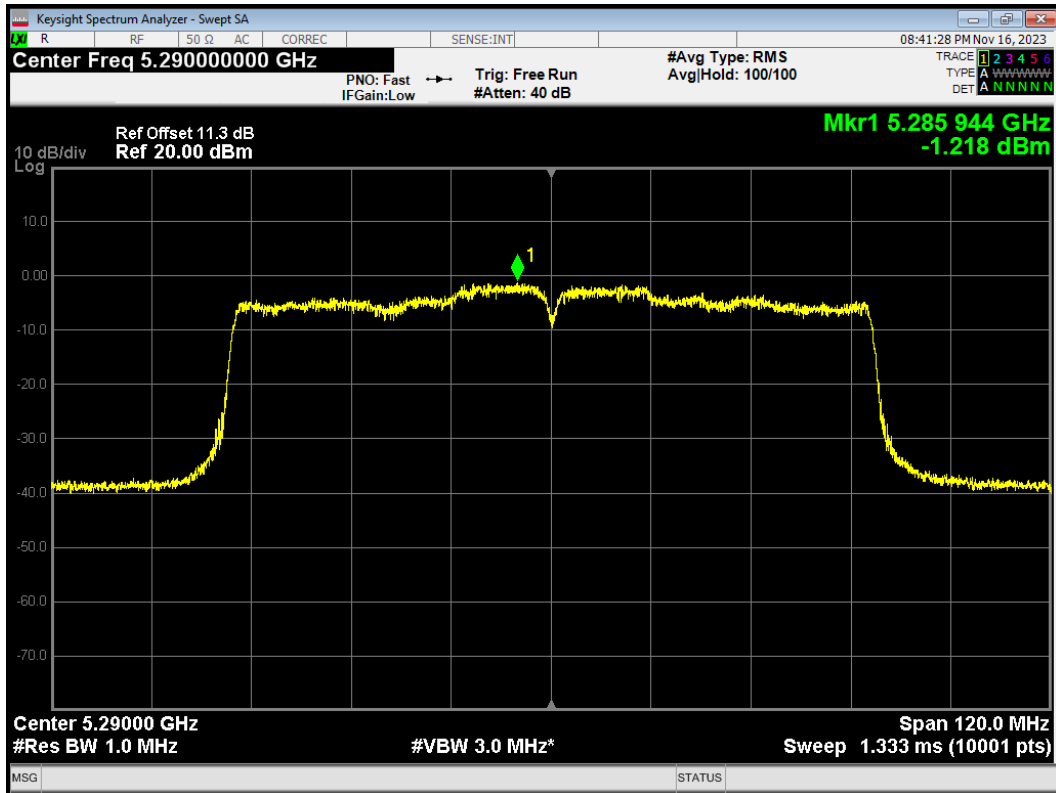

PSD 802.11ac(VHT80) 5290MHz Ant2

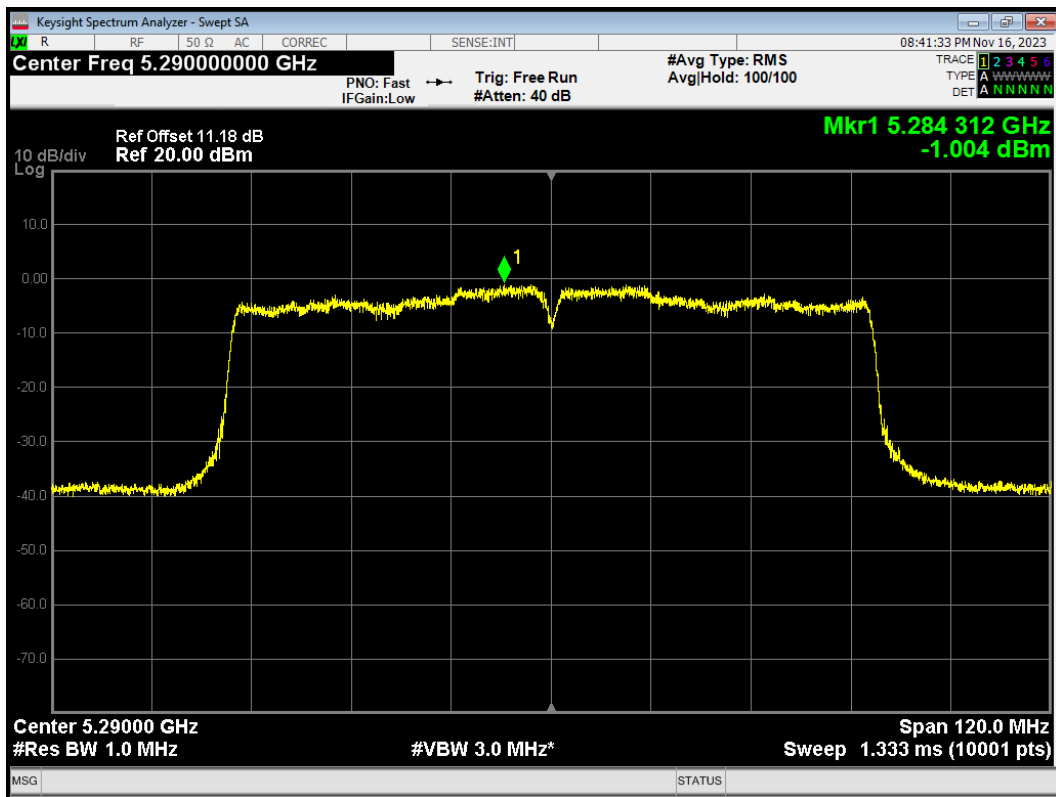

PSD 802.11ax(HE20) 5260MHz Ant1

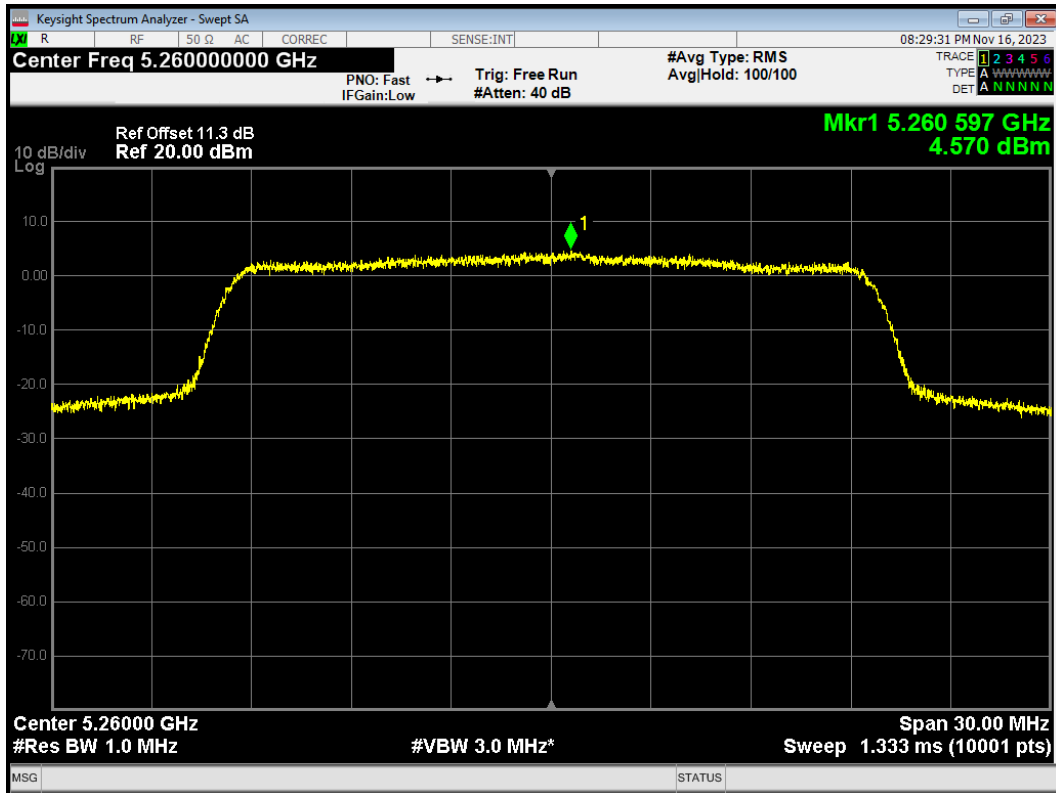

PSD 802.11ax(HE20) 5260MHz Ant2

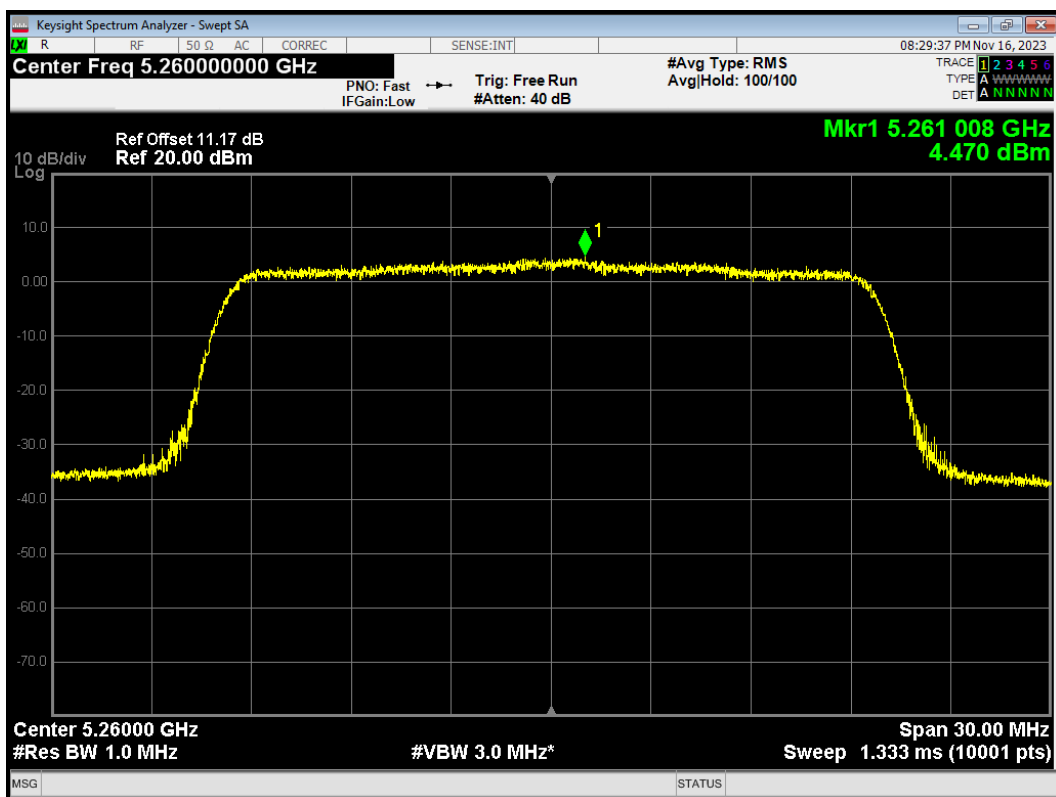

PSD 802.11ax(HE20) 5300MHz Ant1

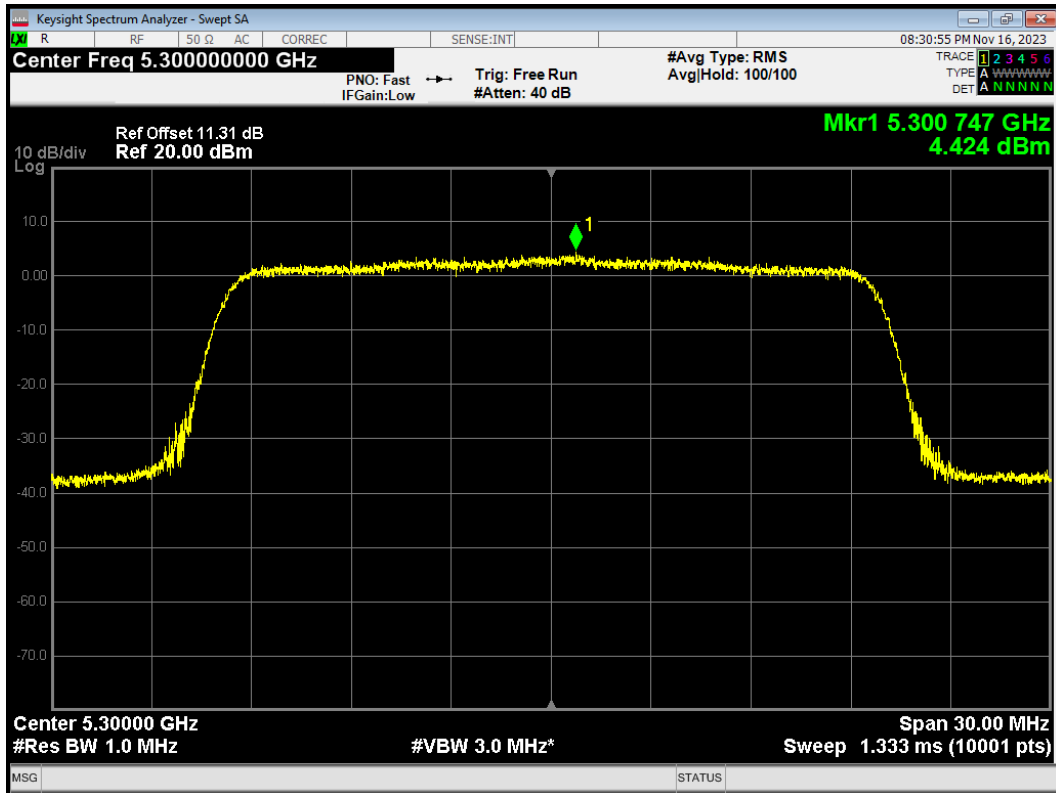

PSD 802.11ax(HE20) 5300MHz Ant2

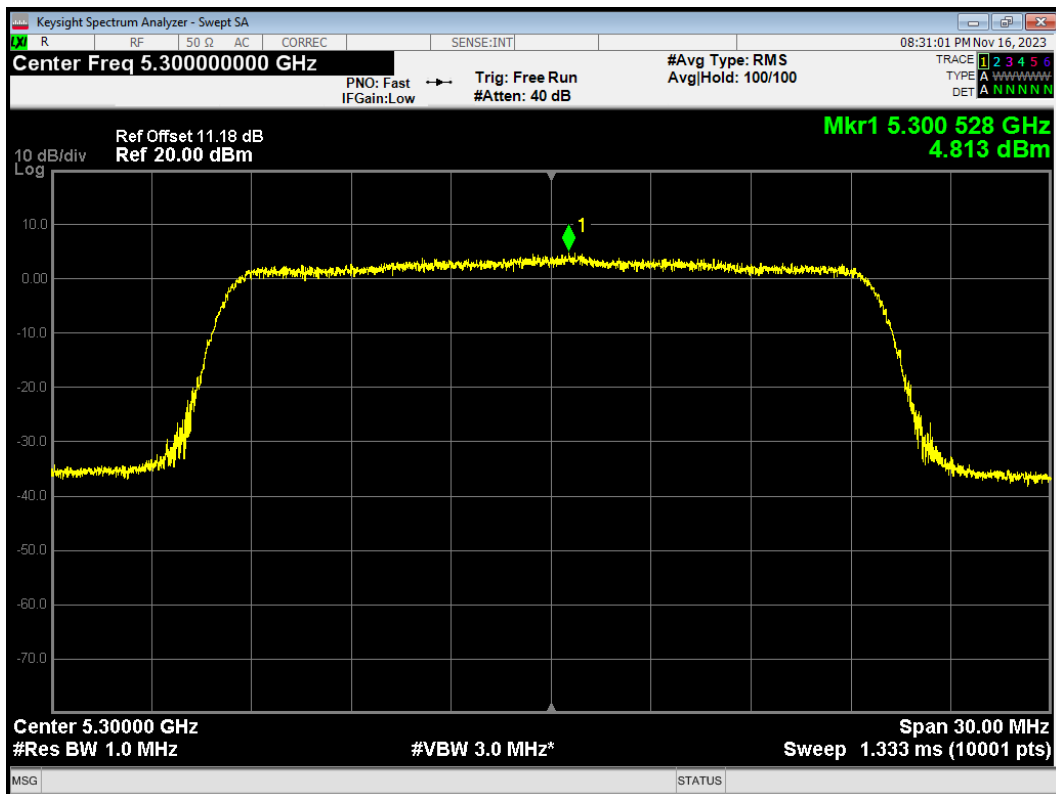

PSD 802.11ax(HE20) 5320MHz Ant1

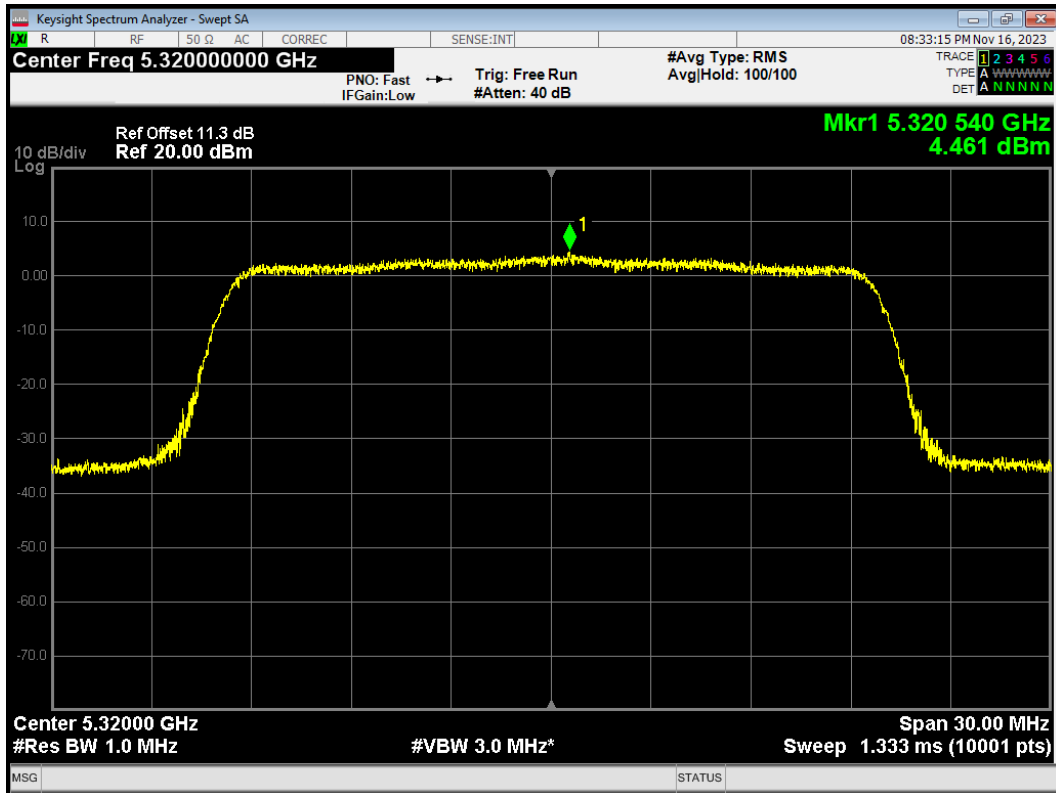

PSD 802.11ax(HE20) 5320MHz Ant2

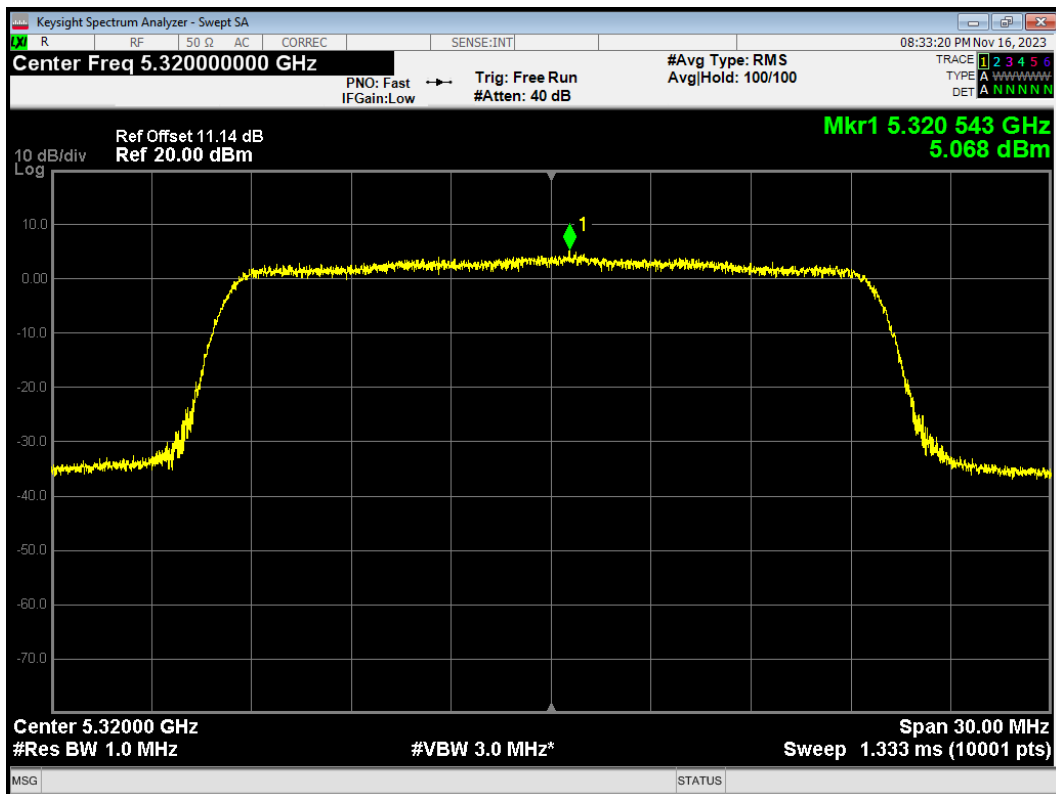

PSD 802.11ax(HE40) 5270MHz Ant1

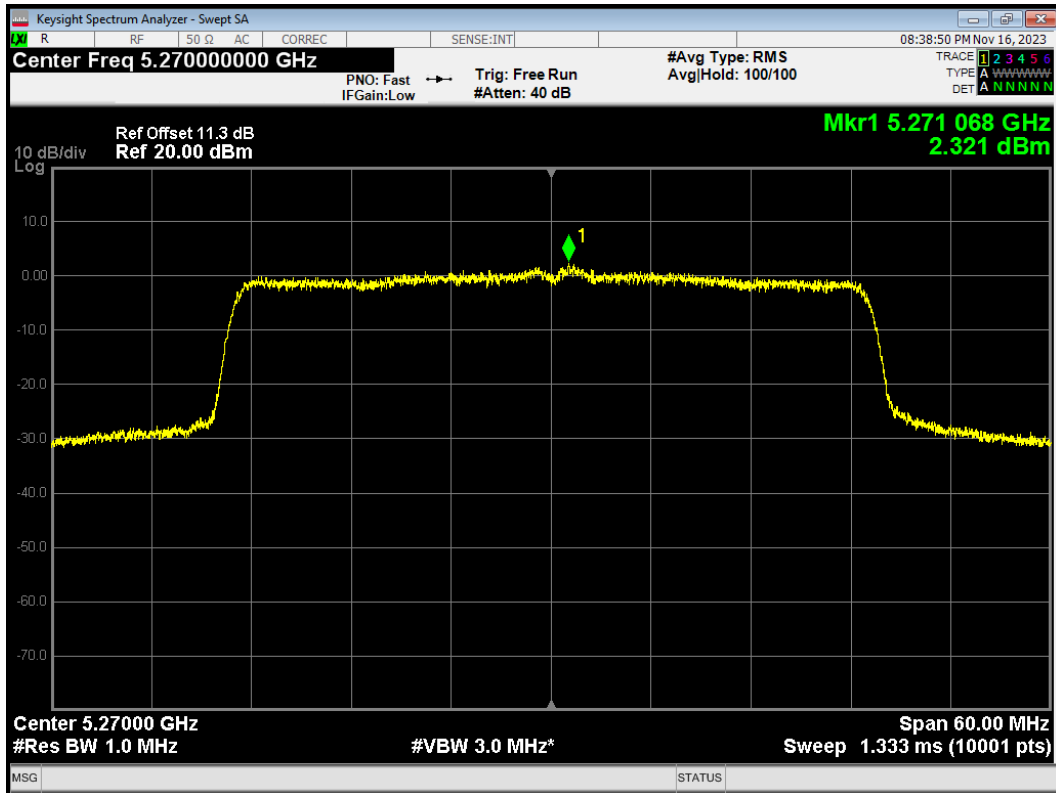

PSD 802.11ax(HE40) 5270MHz Ant2

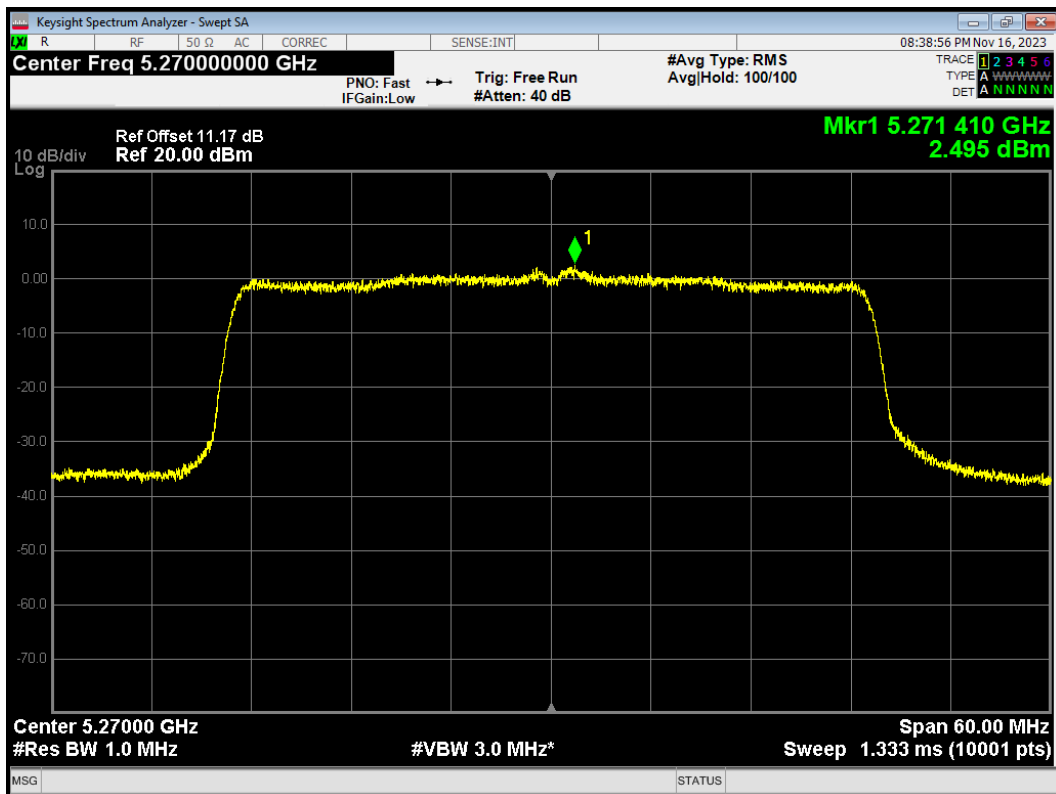

PSD 802.11ax(HE40) 5310MHz Ant1

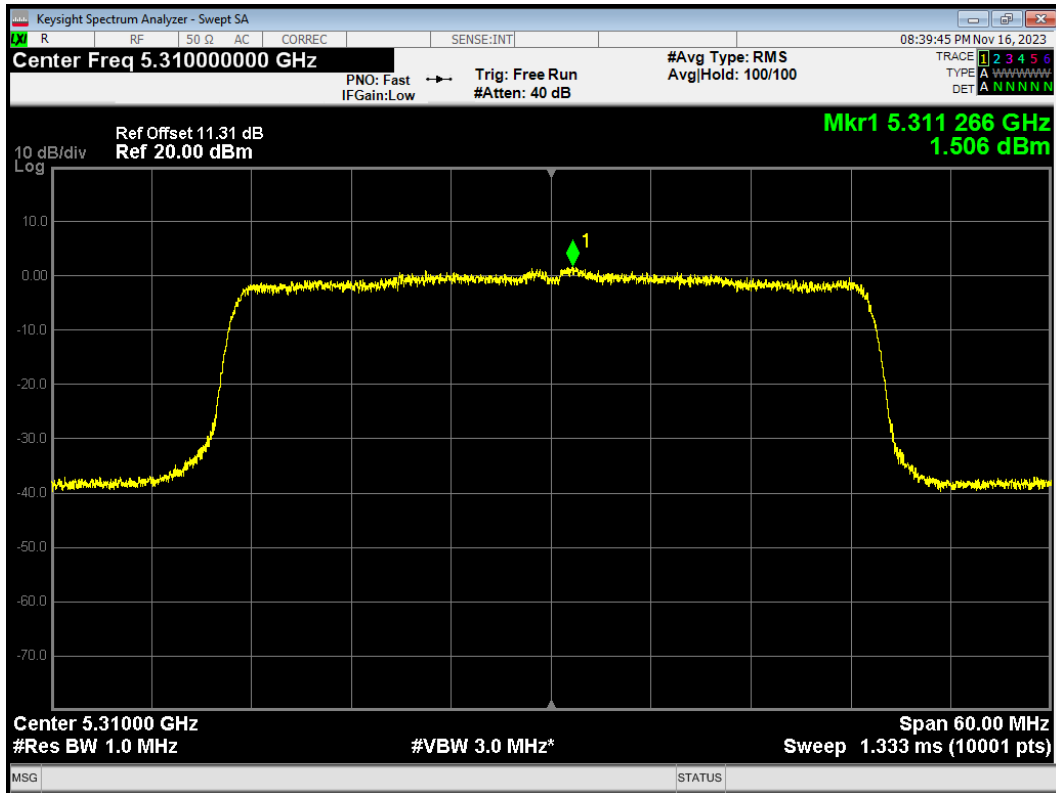

PSD 802.11ax(HE40) 5310MHz Ant2

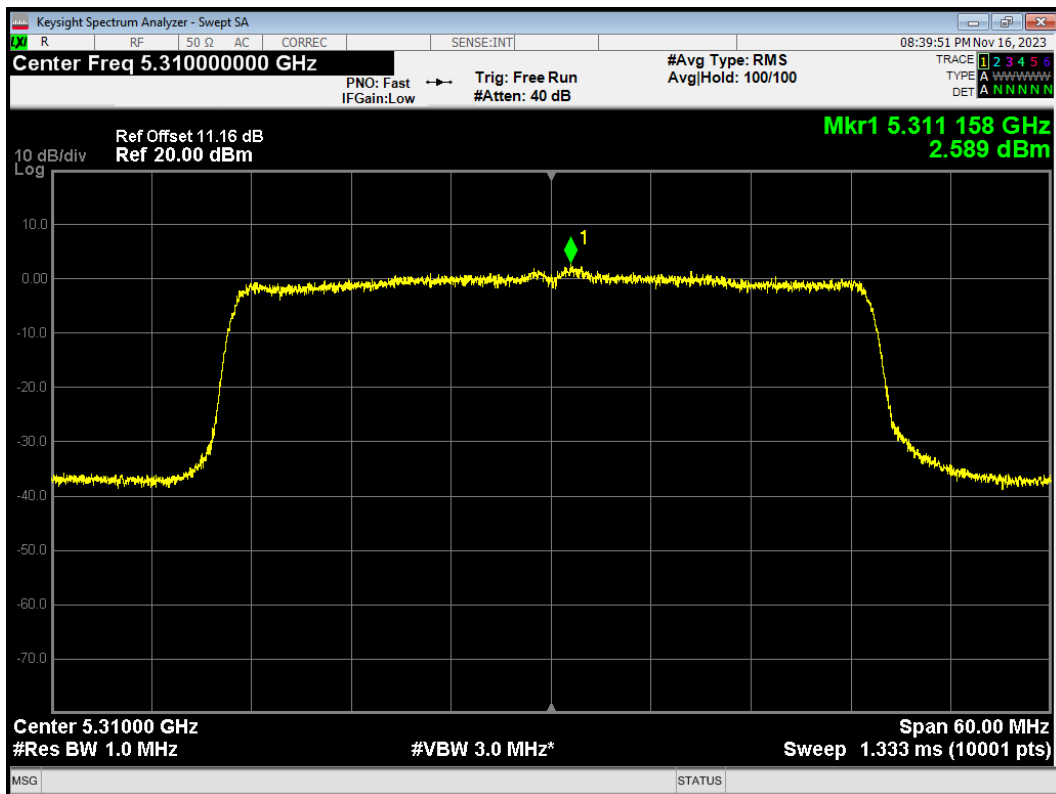

PSD 802.11ax(HE80) 5290MHz Ant1

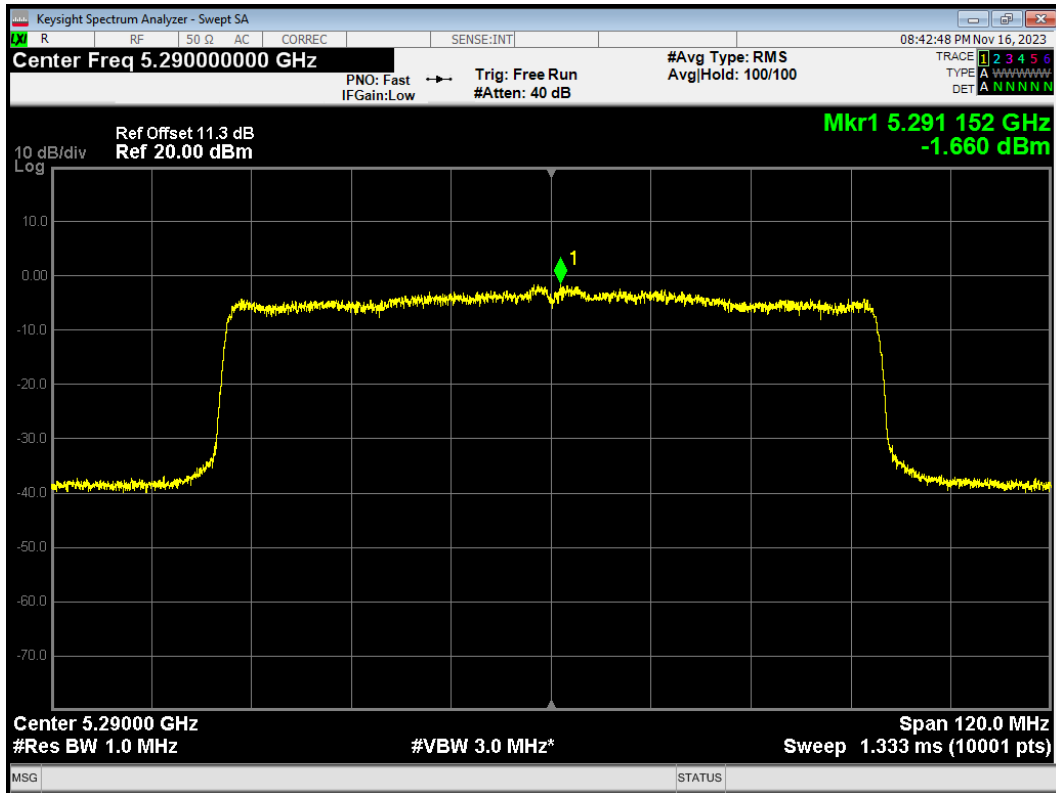

PSD 802.11ax(HE80) 5290MHz Ant2

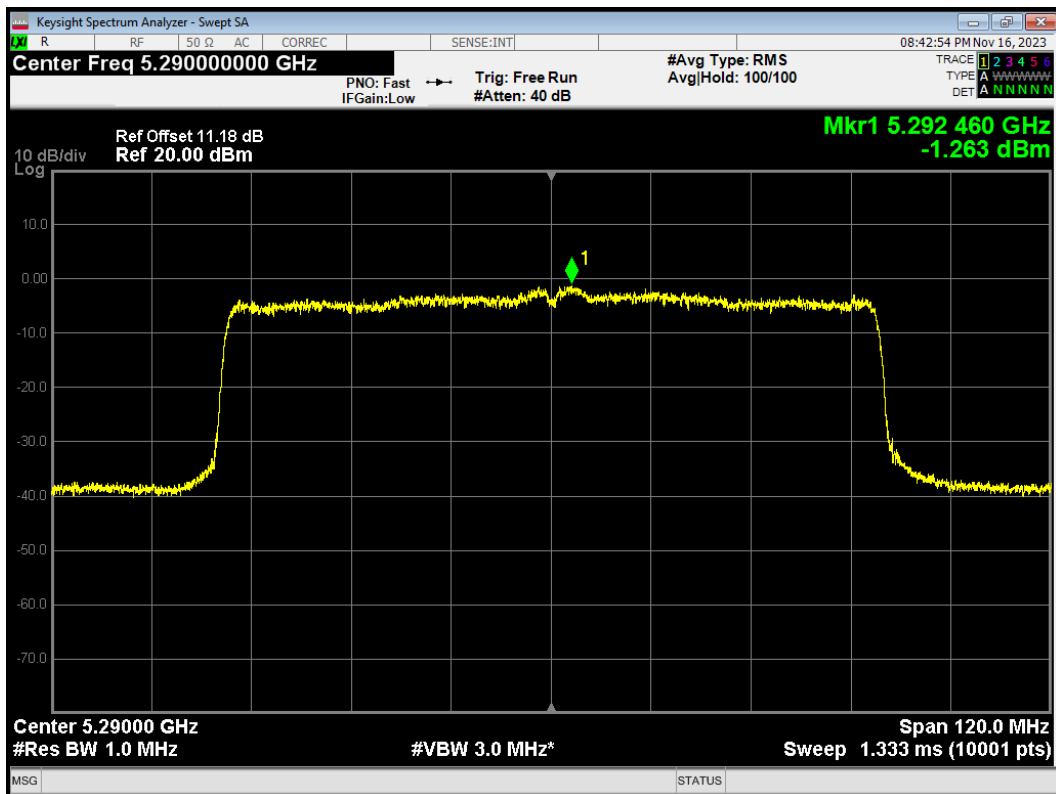

PSD 802.11n(HT20) 5260MHz Ant1

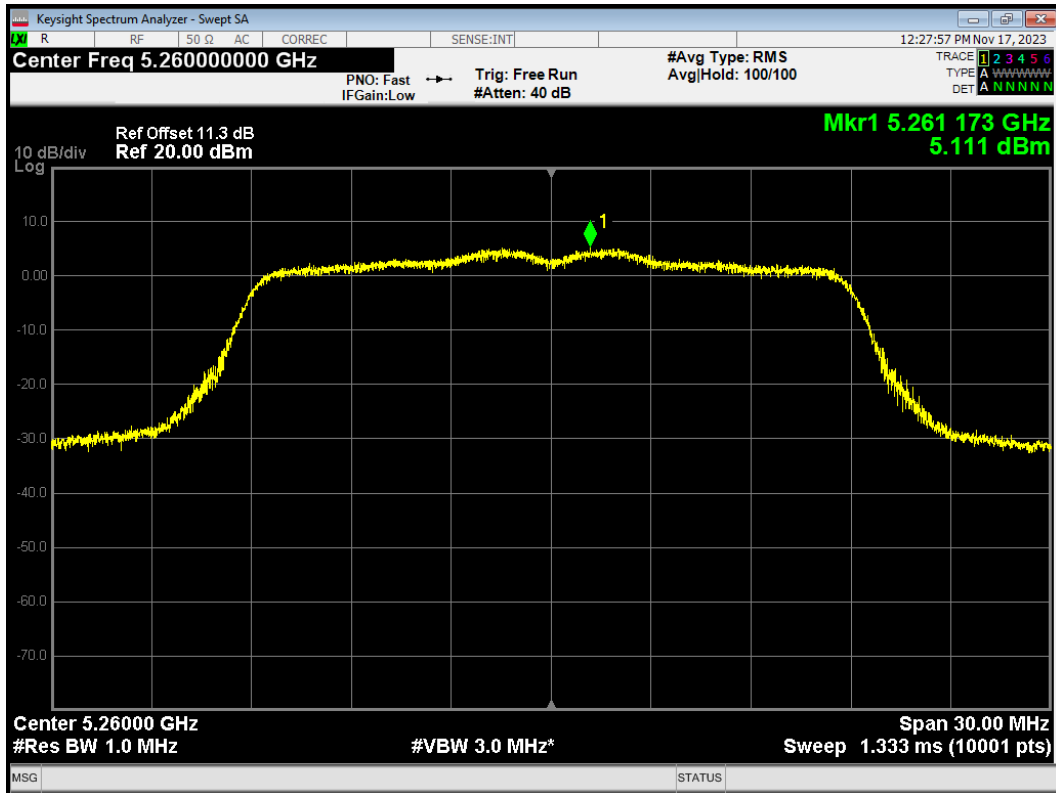

PSD 802.11n(HT20) 5260MHz Ant2

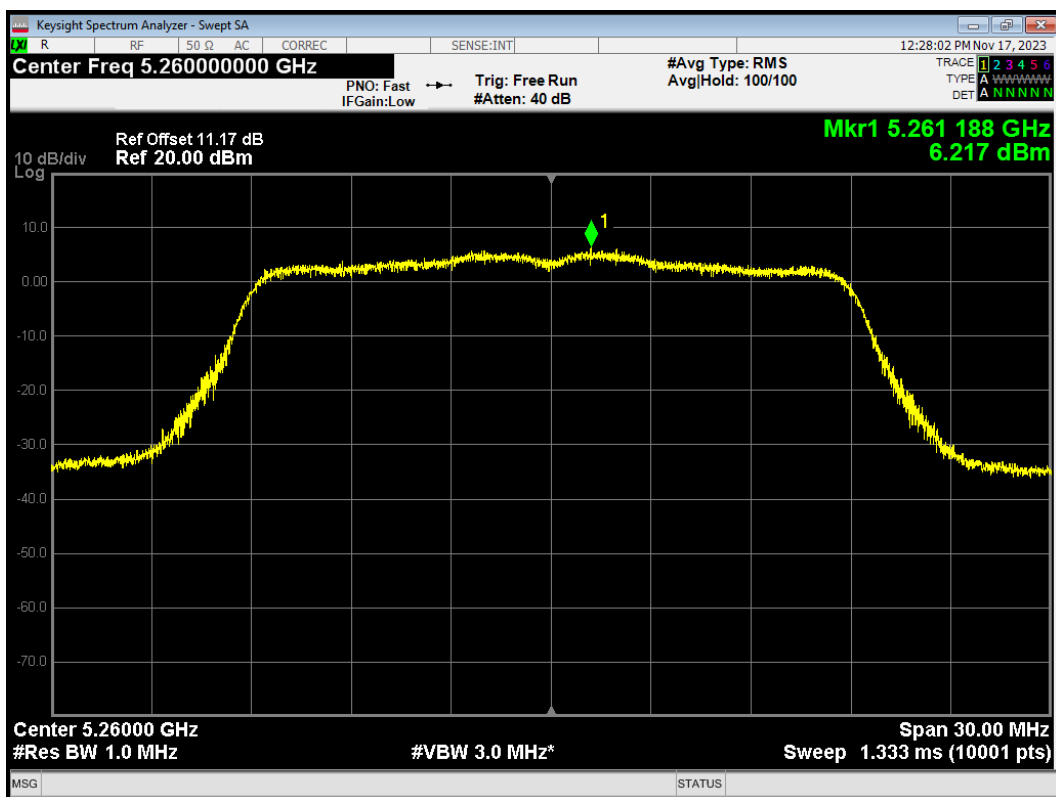

PSD 802.11n(HT20) 5300MHz Ant1

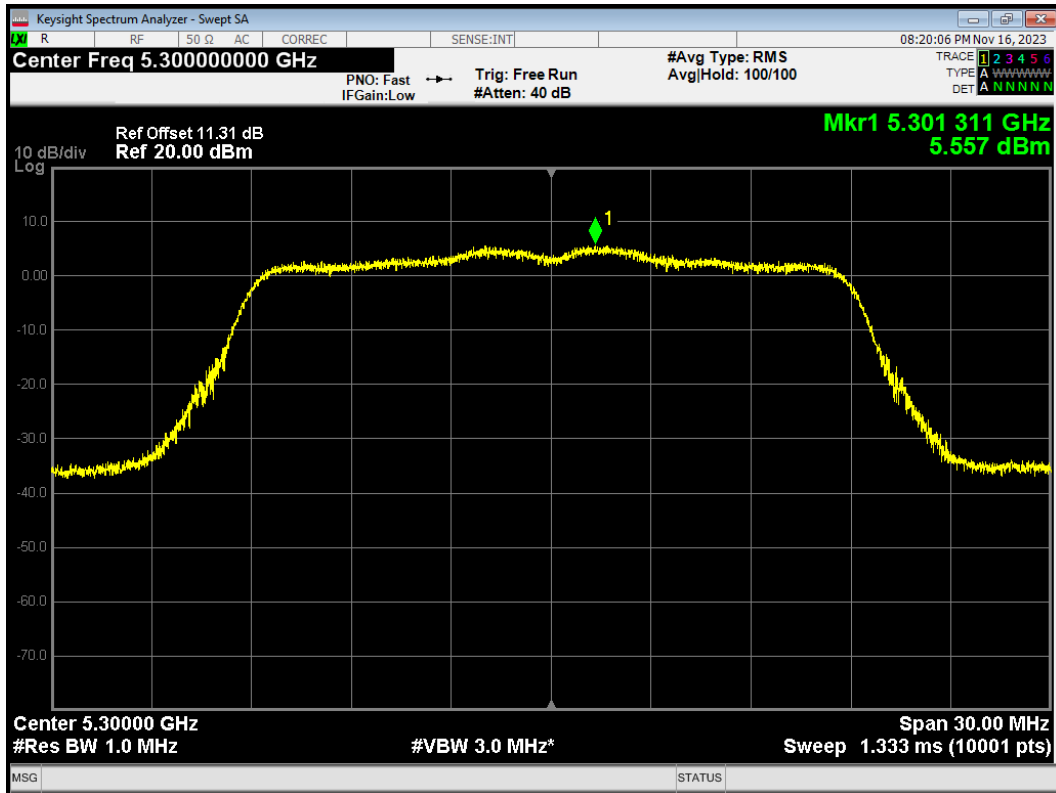

PSD 802.11n(HT20) 5300MHz Ant2

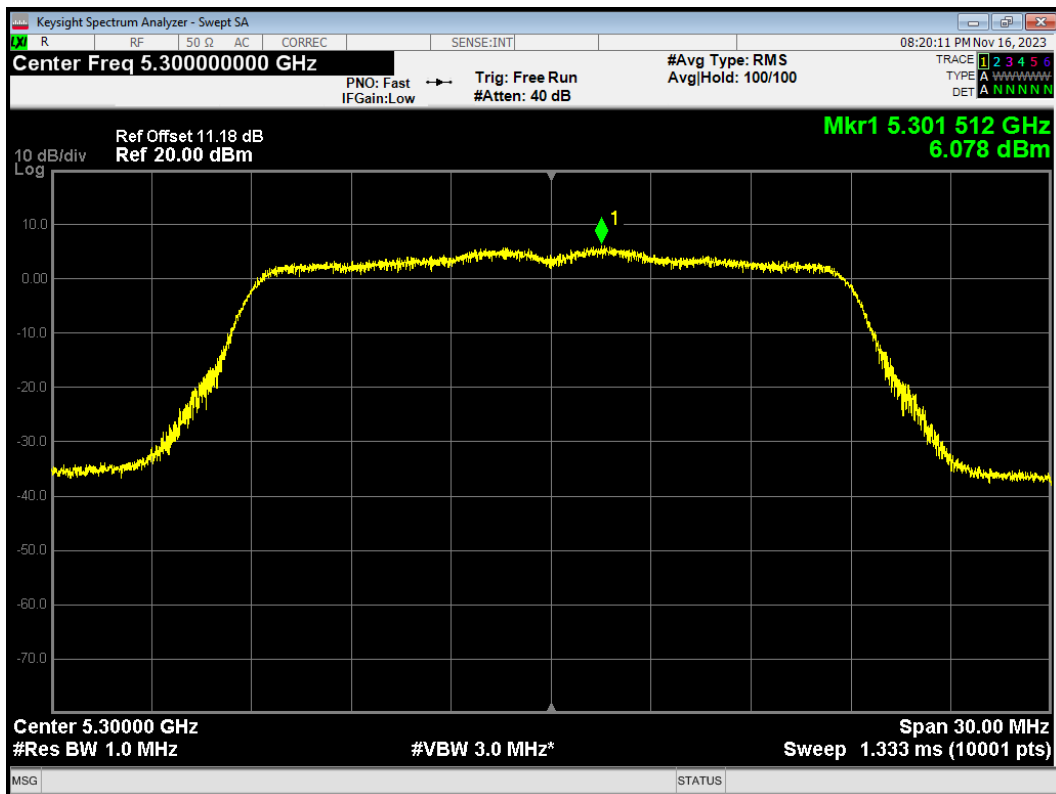

PSD 802.11n(HT20) 5320MHz Ant1

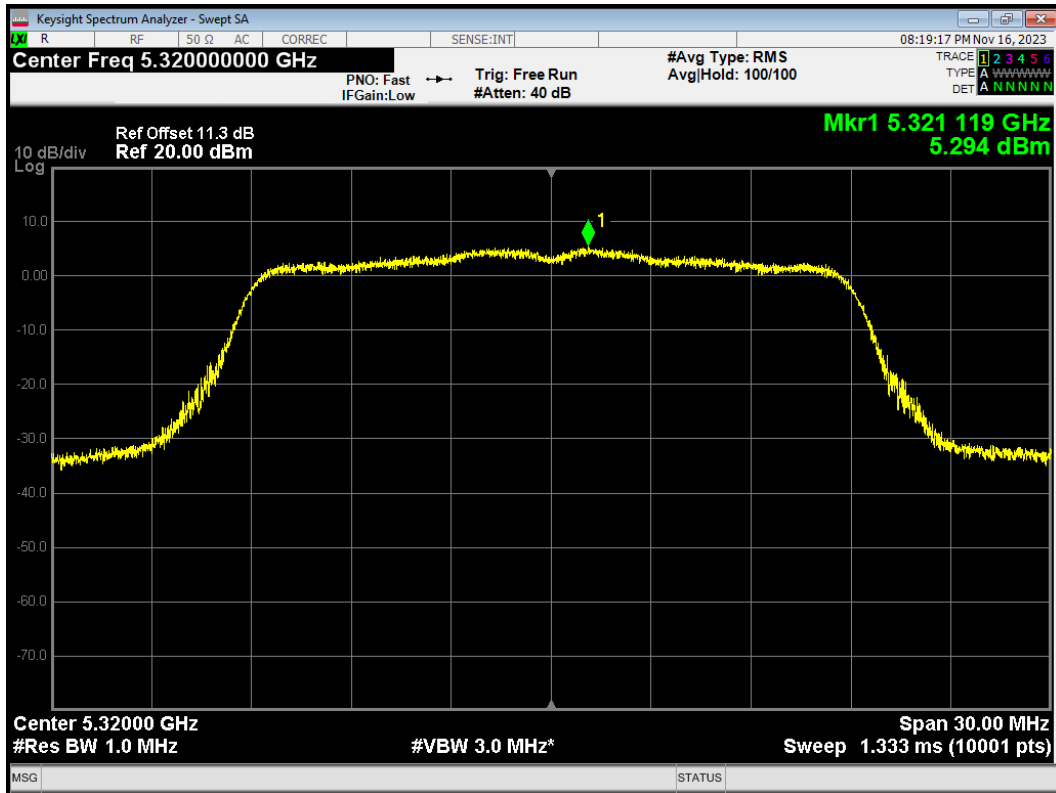

PSD 802.11n(HT20) 5320MHz Ant2

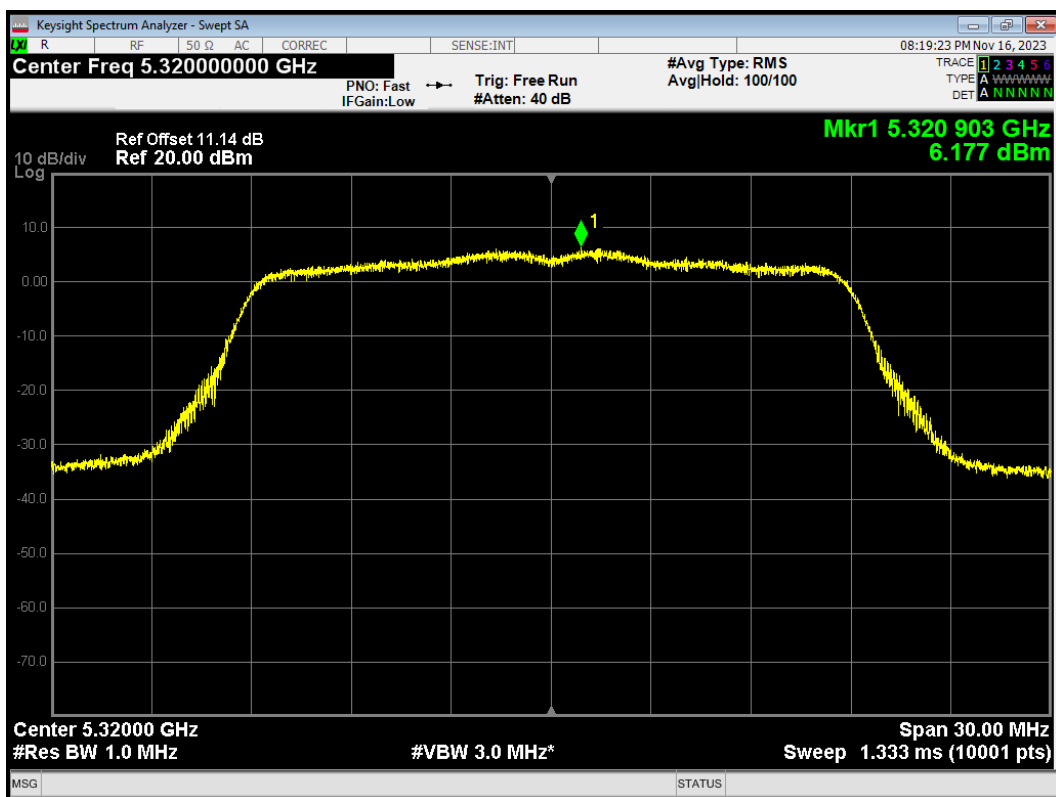

PSD 802.11n(HT40) 5270MHz Ant1

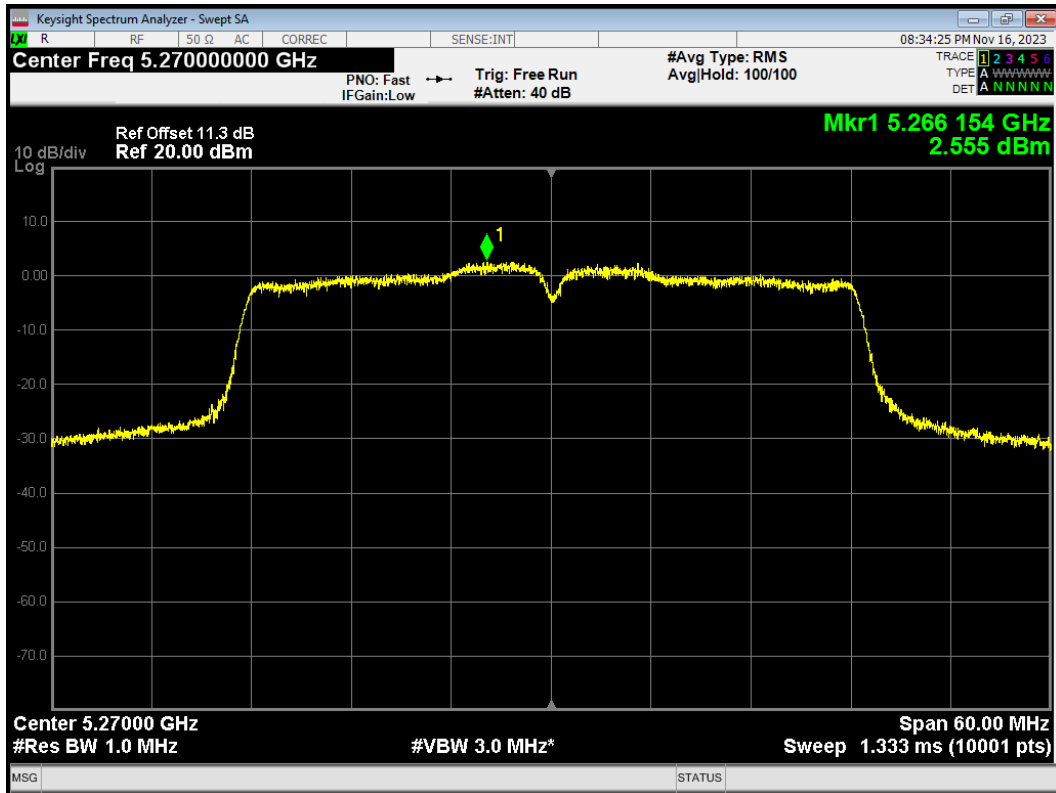

PSD 802.11n(HT40) 5270MHz Ant2

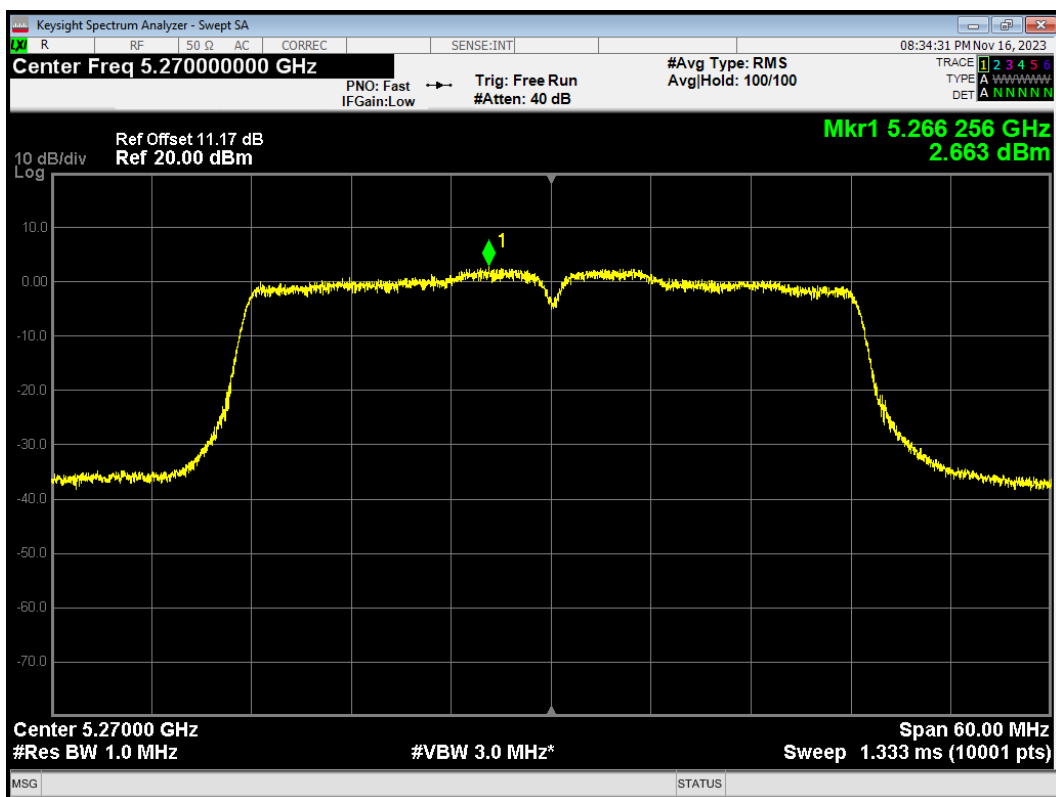

PSD 802.11n(HT40) 5310MHz Ant1

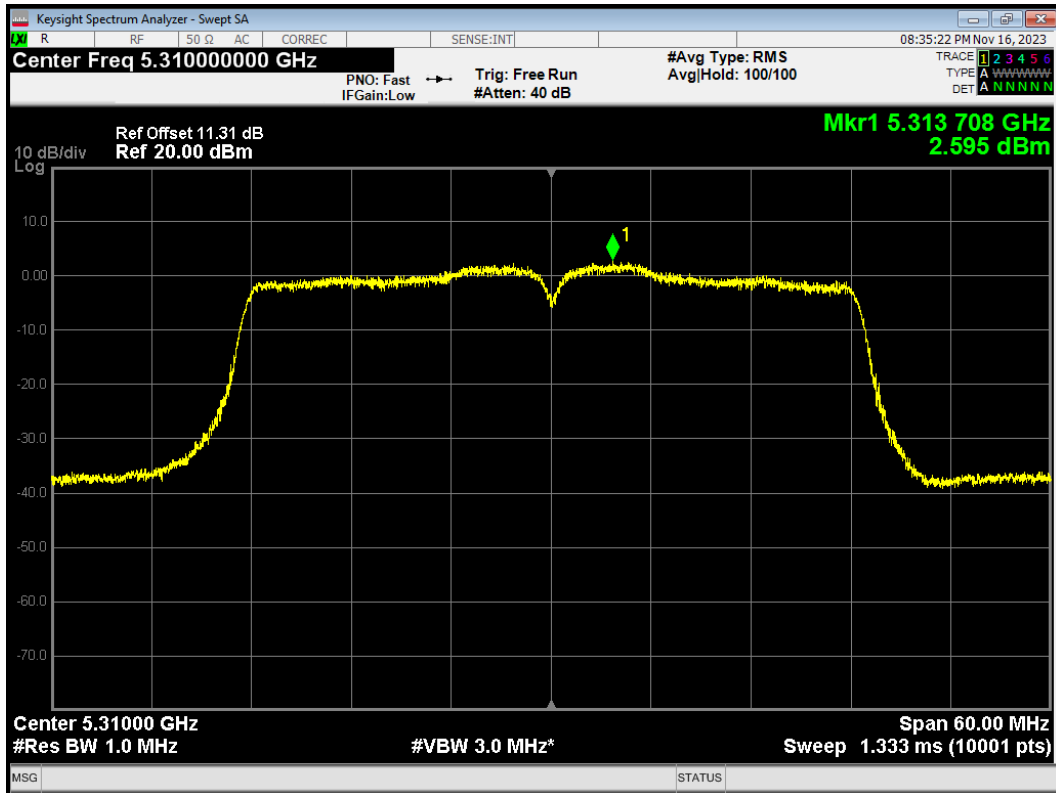

PSD 802.11n(HT40) 5310MHz Ant2

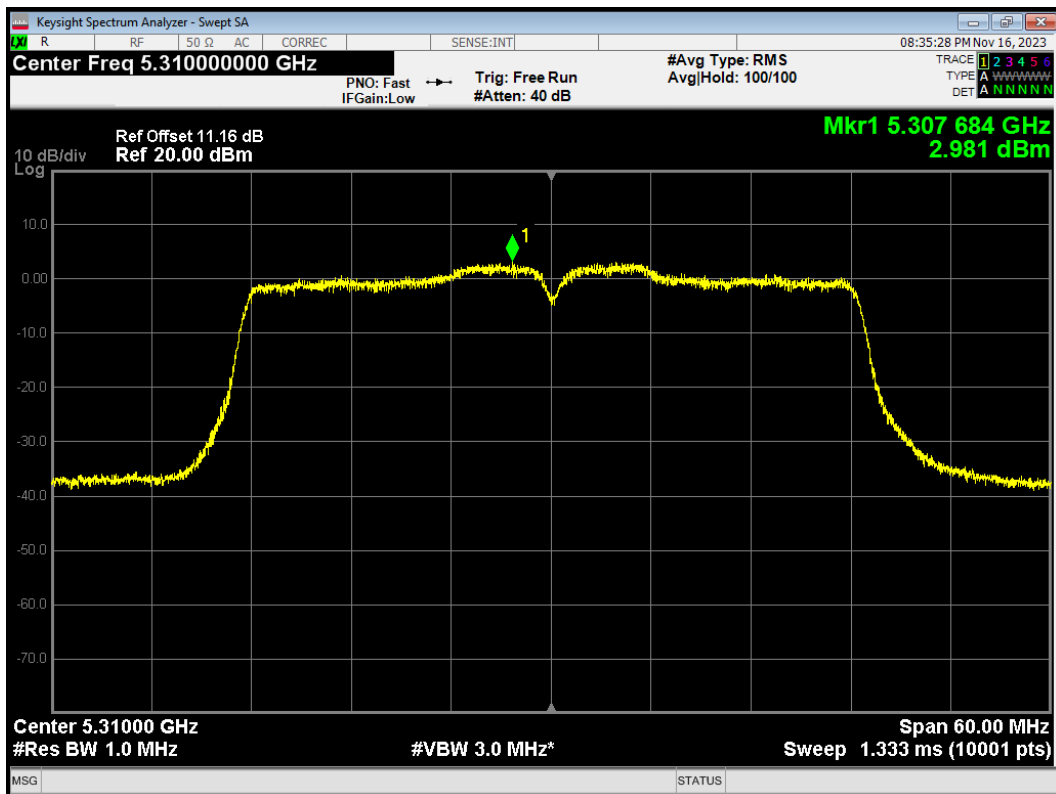

U-NII-2C

PSD 802.11ac(VHT20) 5500MHz Ant1

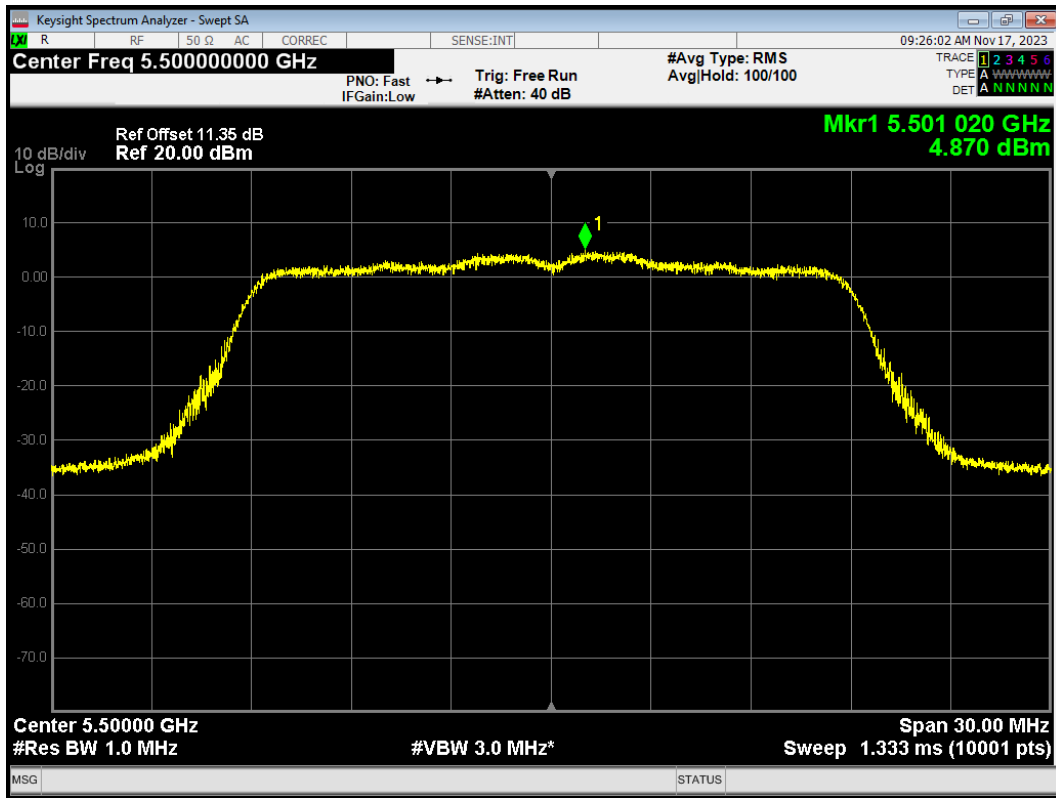

PSD 802.11ac(VHT20) 5500MHz Ant2

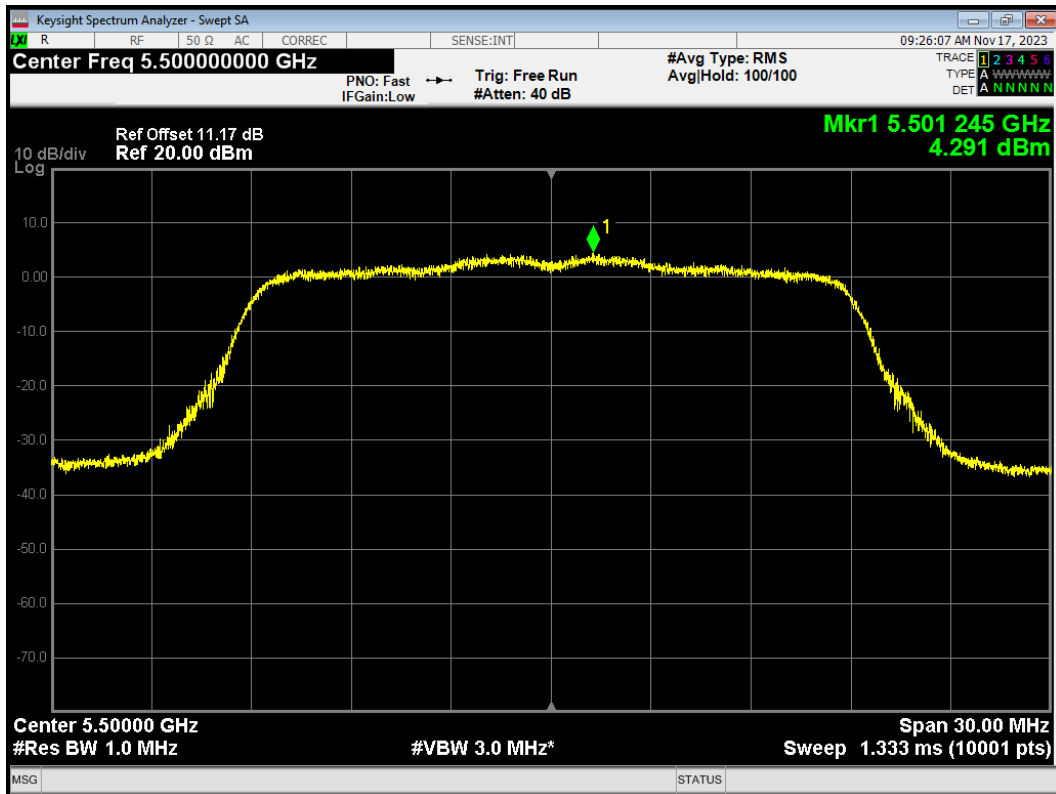

PSD 802.11ac(VHT20) 5580MHz Ant1

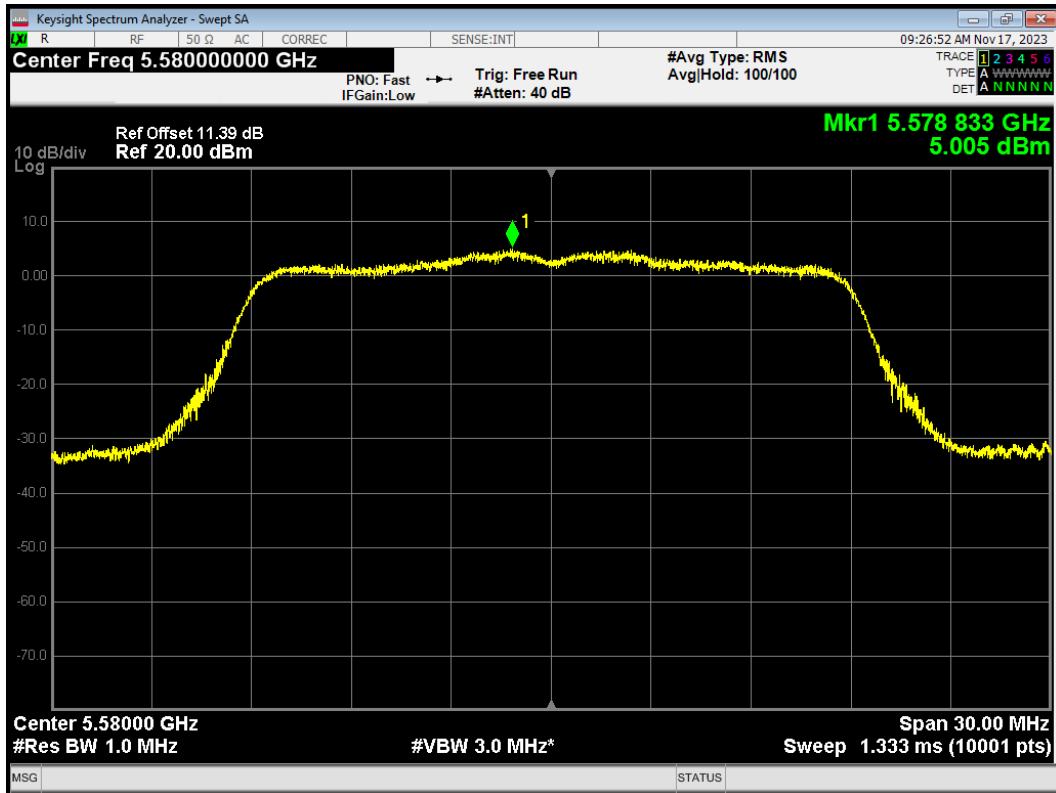

PSD 802.11ac(VHT20) 5580MHz Ant2

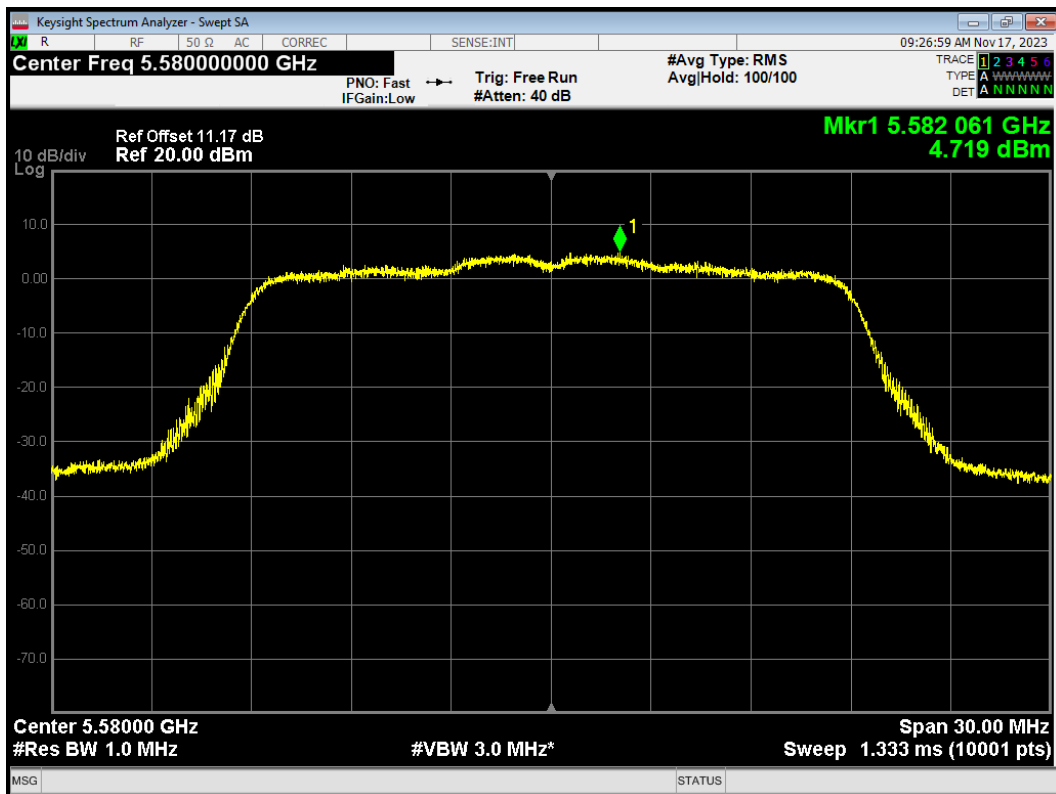

PSD 802.11ac(VHT20) 5700MHz Ant1

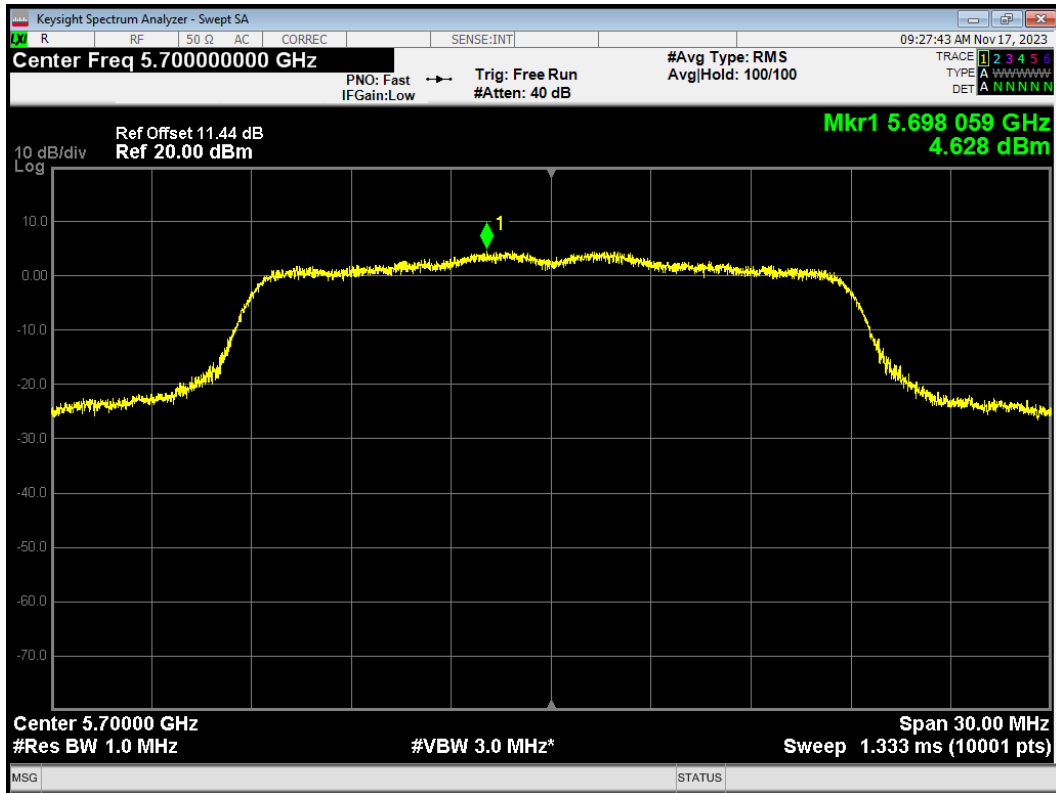

PSD 802.11ac(VHT20) 5700MHz Ant2

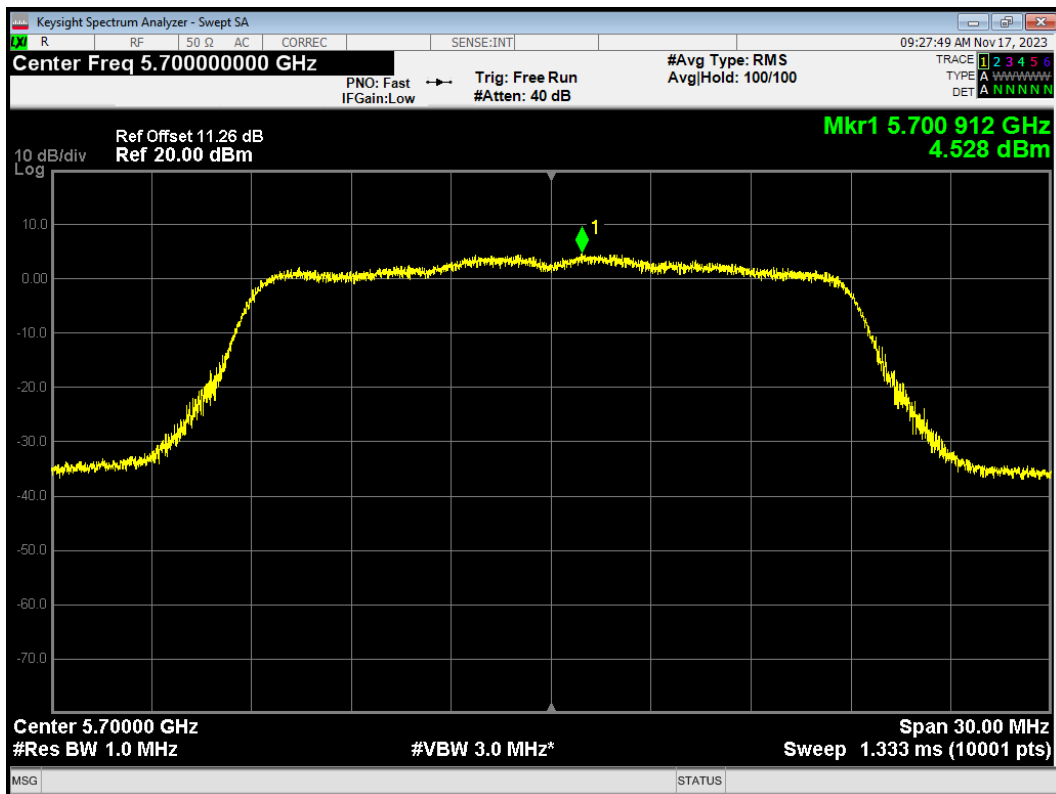

PSD 802.11ac(VHT20) 5720MHz Ant1

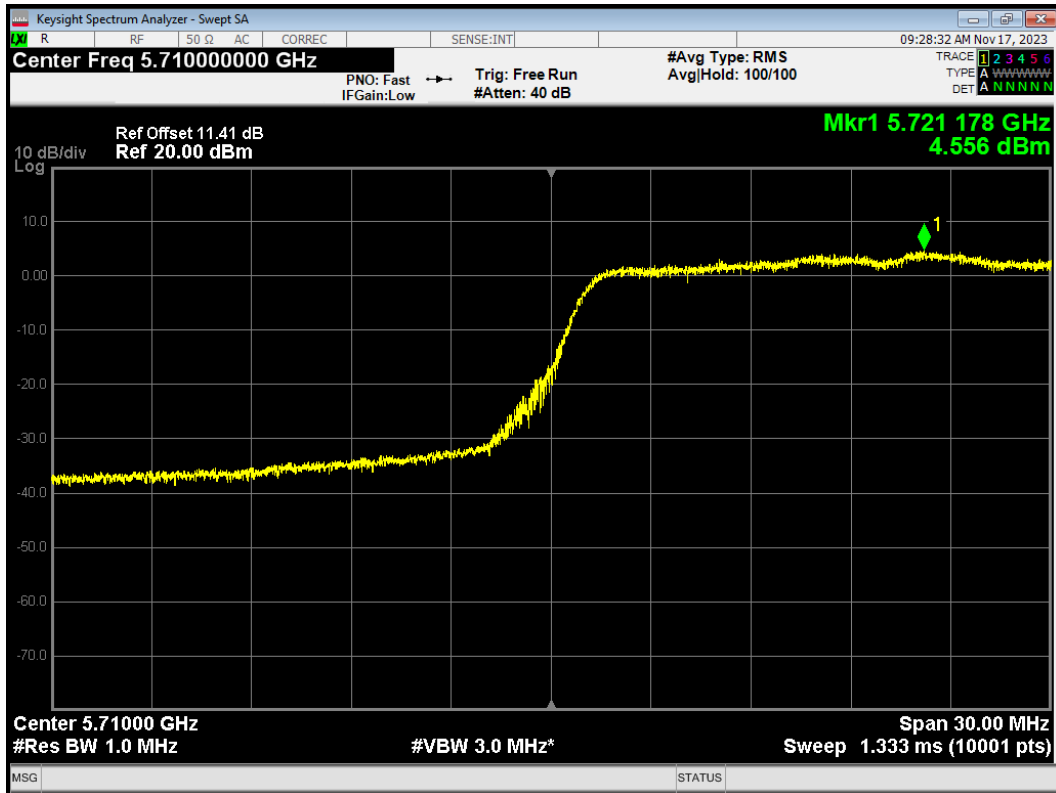

PSD 802.11ac(VHT20) 5720MHz Ant2

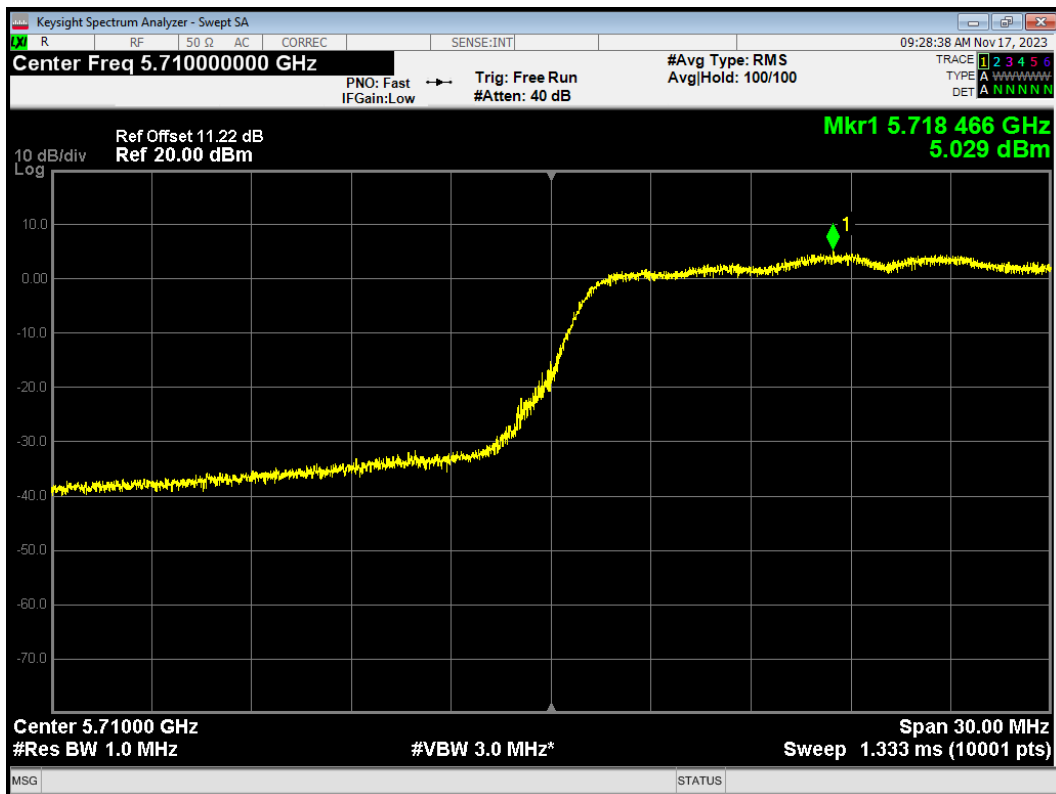

PSD 802.11ac(VHT40) 5510MHz Ant1

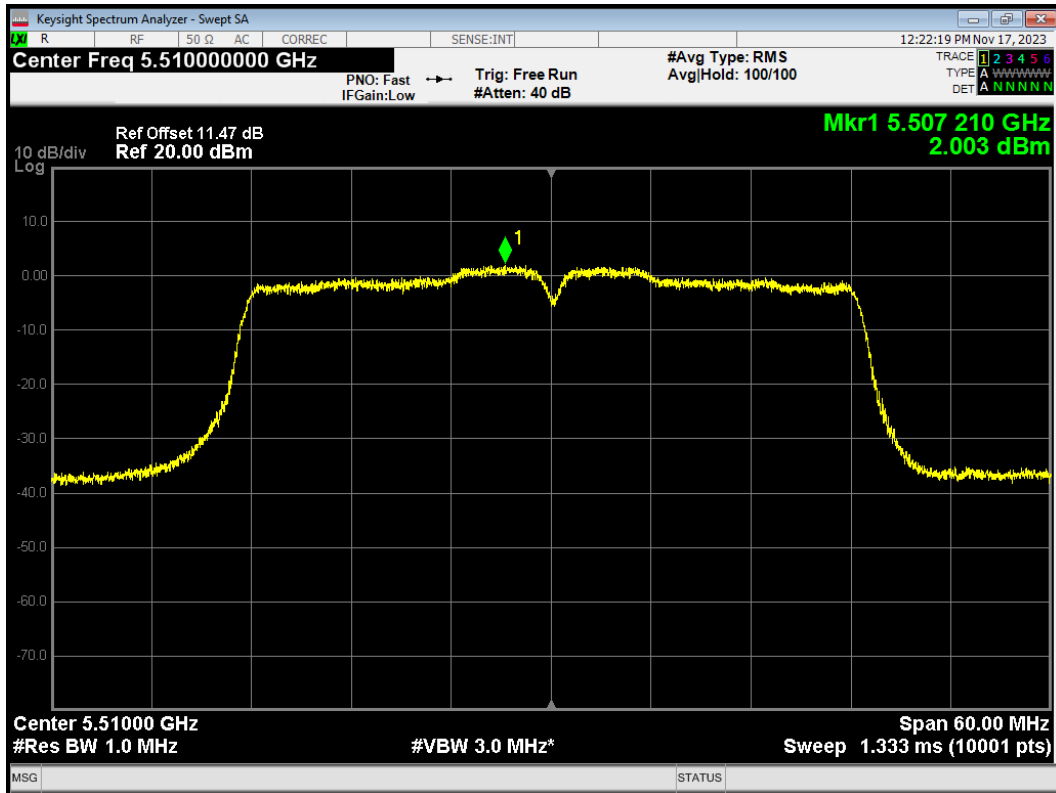

PSD 802.11ac(VHT40) 5510MHz Ant2

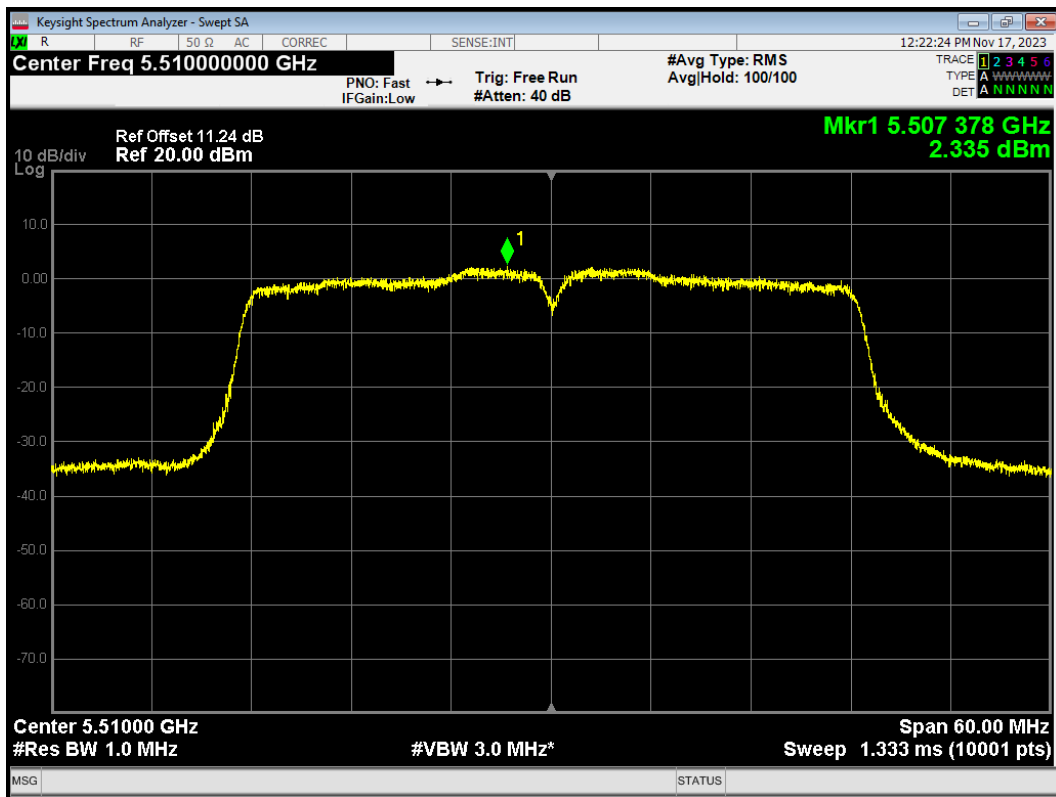

PSD 802.11ac(VHT40) 5550MHz Ant1

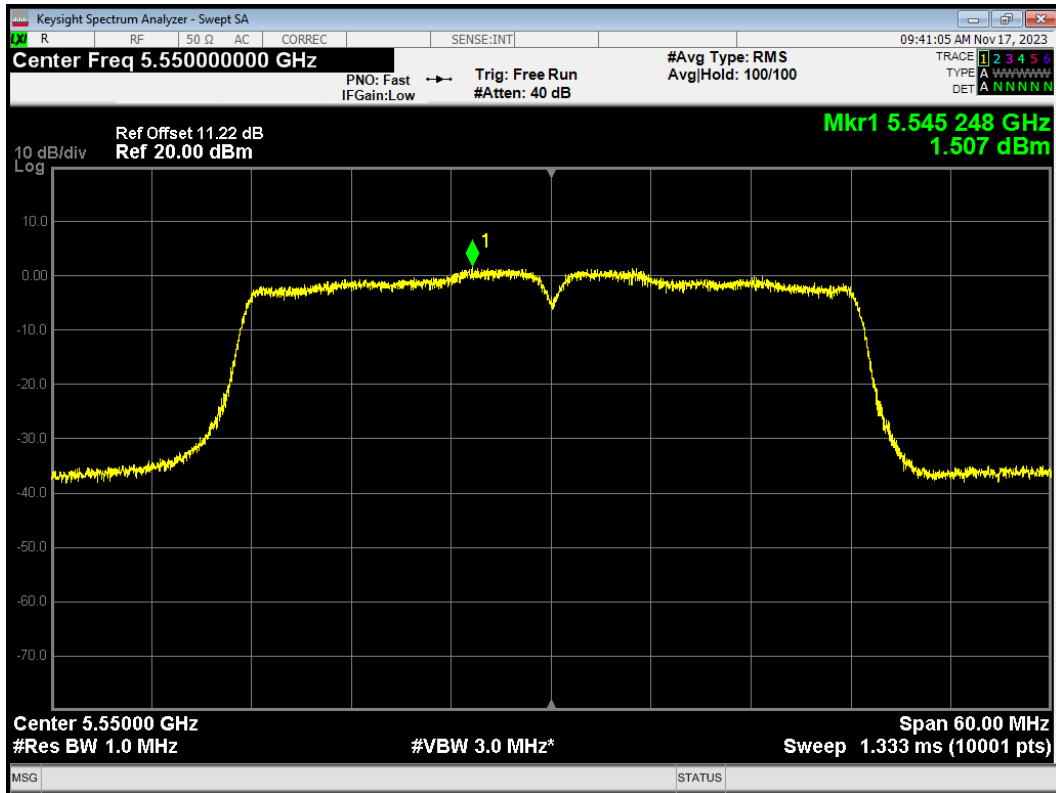

PSD 802.11ac(VHT40) 5550MHz Ant2

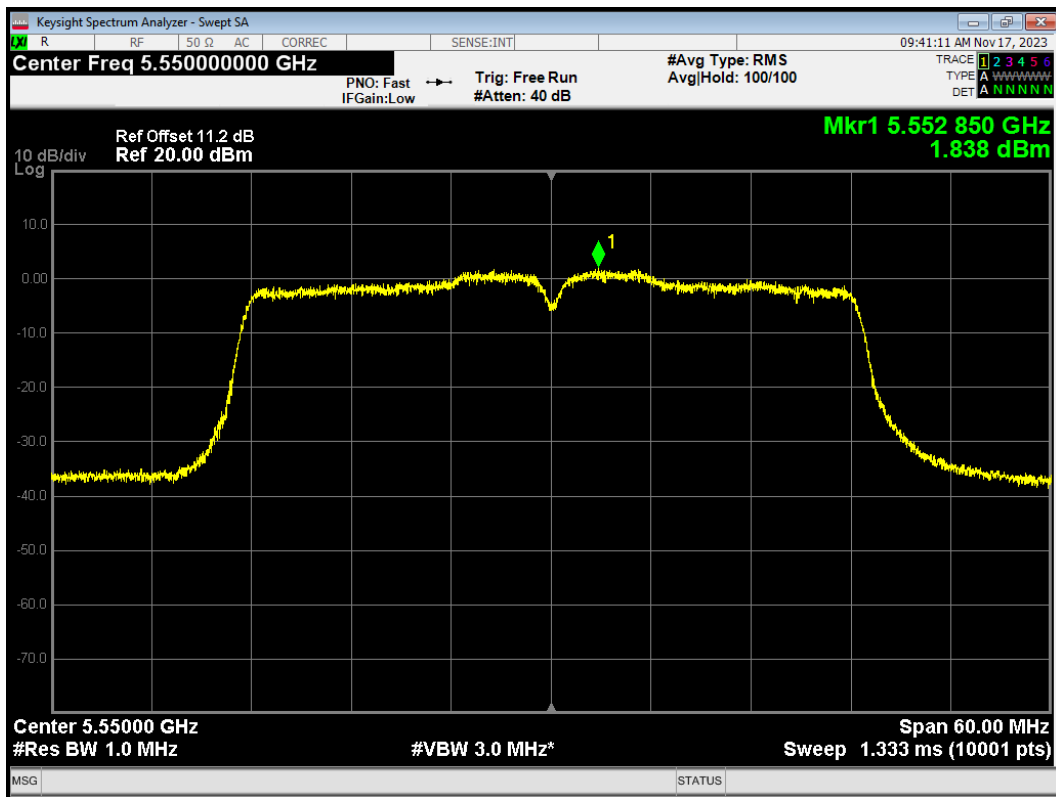

PSD 802.11ac(VHT40) 5670MHz Ant1

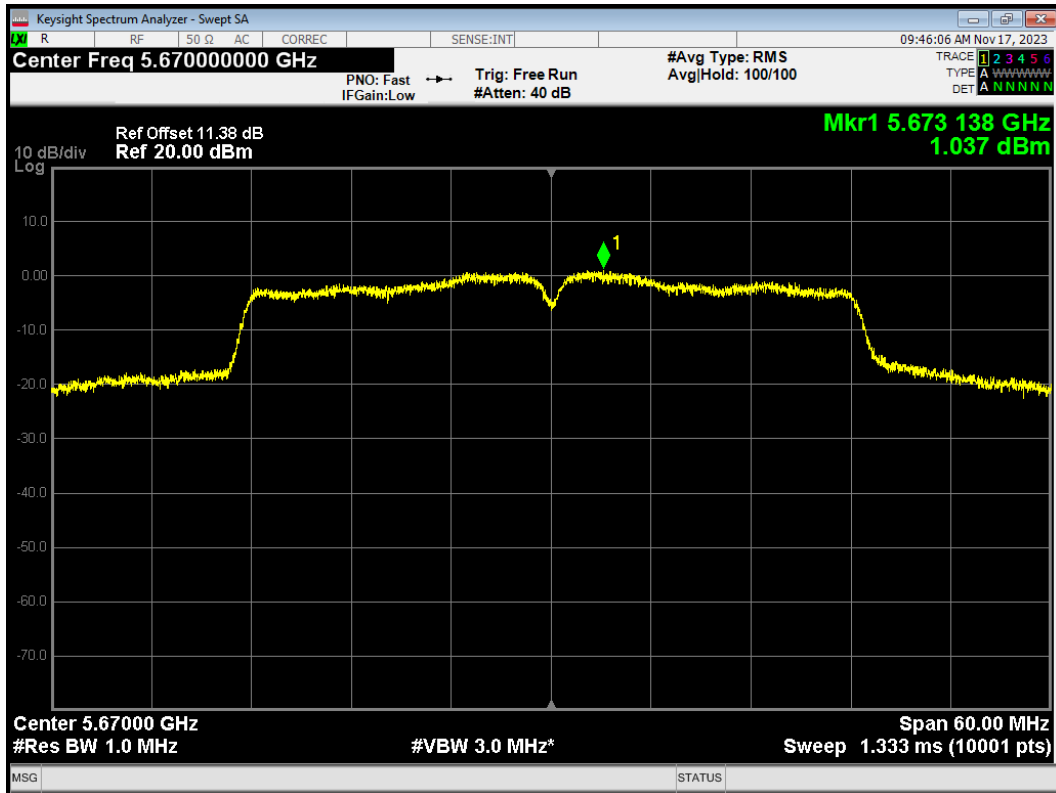

PSD 802.11ac(VHT40) 5670MHz Ant2

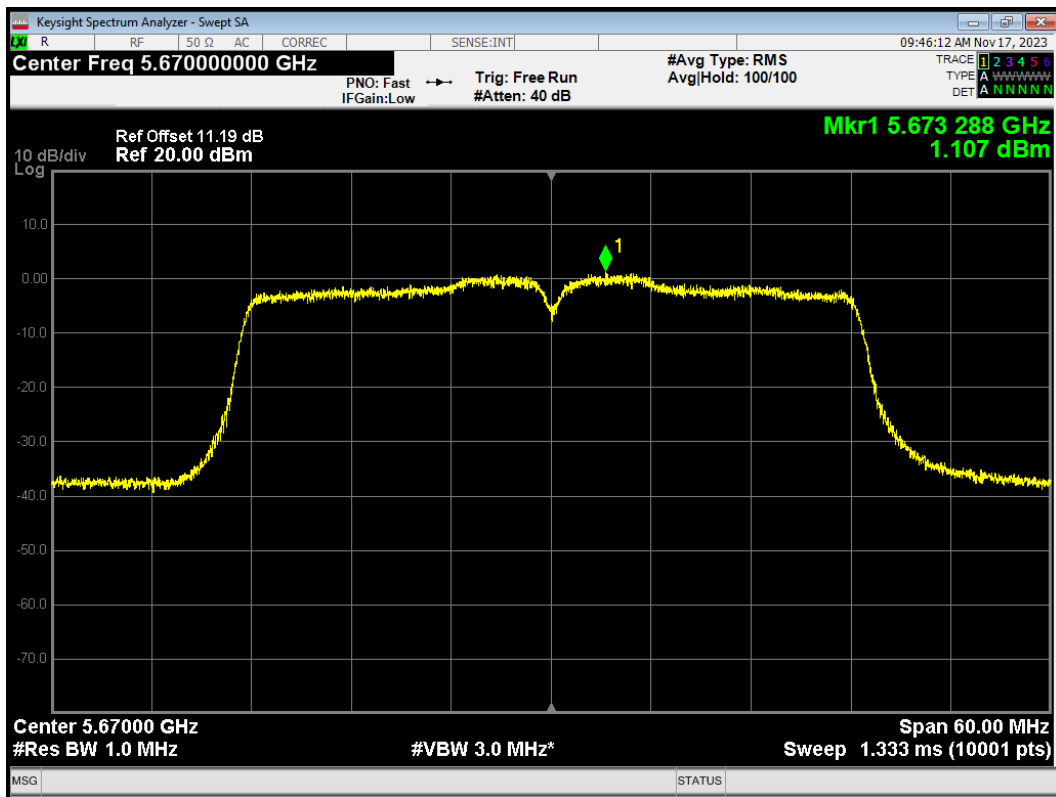

PSD 802.11ac(VHT40) 5710MHz Ant1

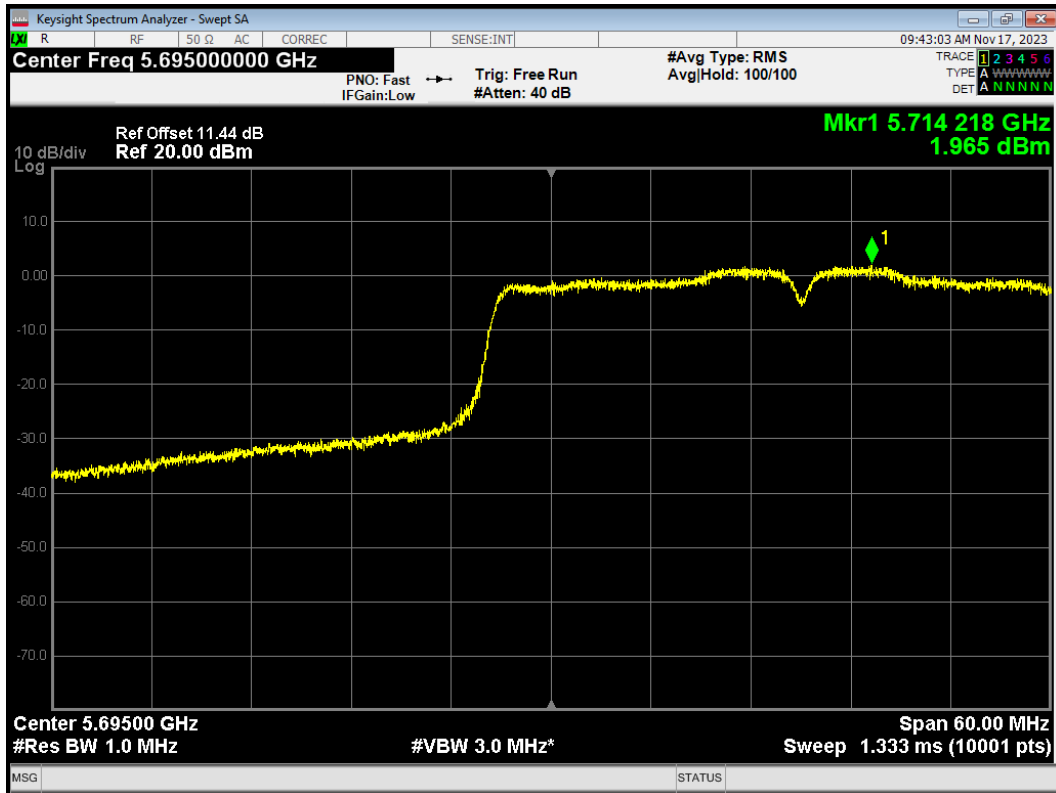

PSD 802.11ac(VHT40) 5710MHz Ant2

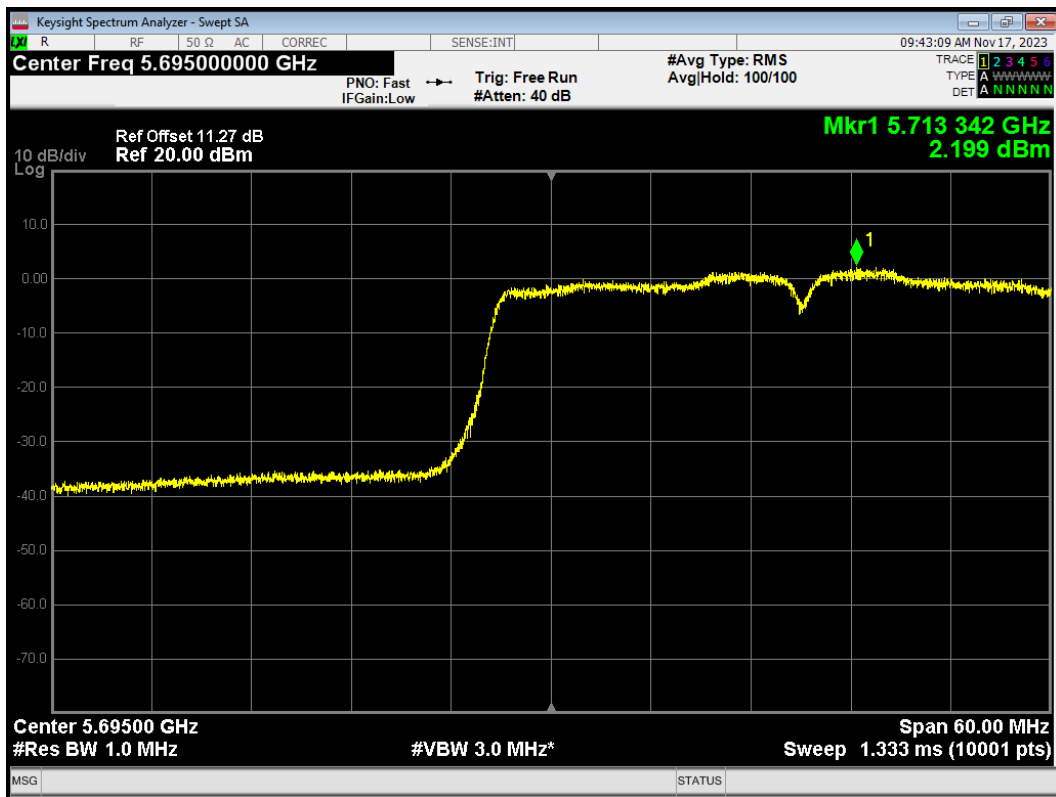

PSD 802.11ac(VHT80) 5530MHz Ant1

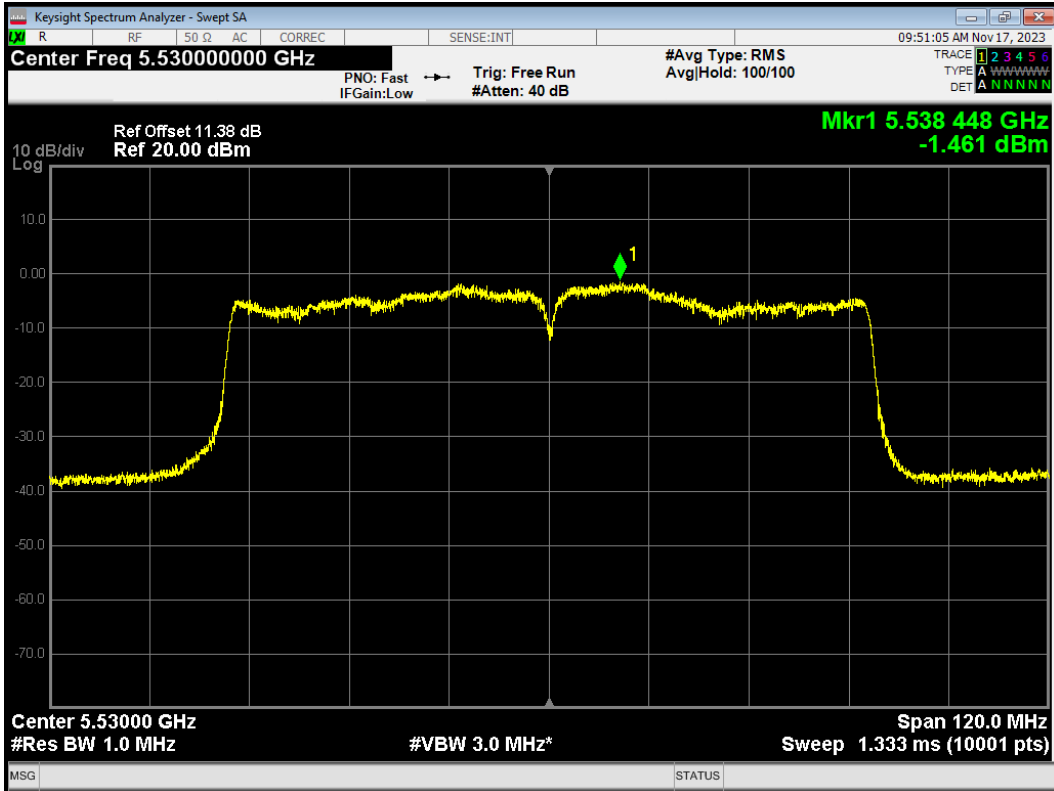

PSD 802.11ac(VHT80) 5530MHz Ant2

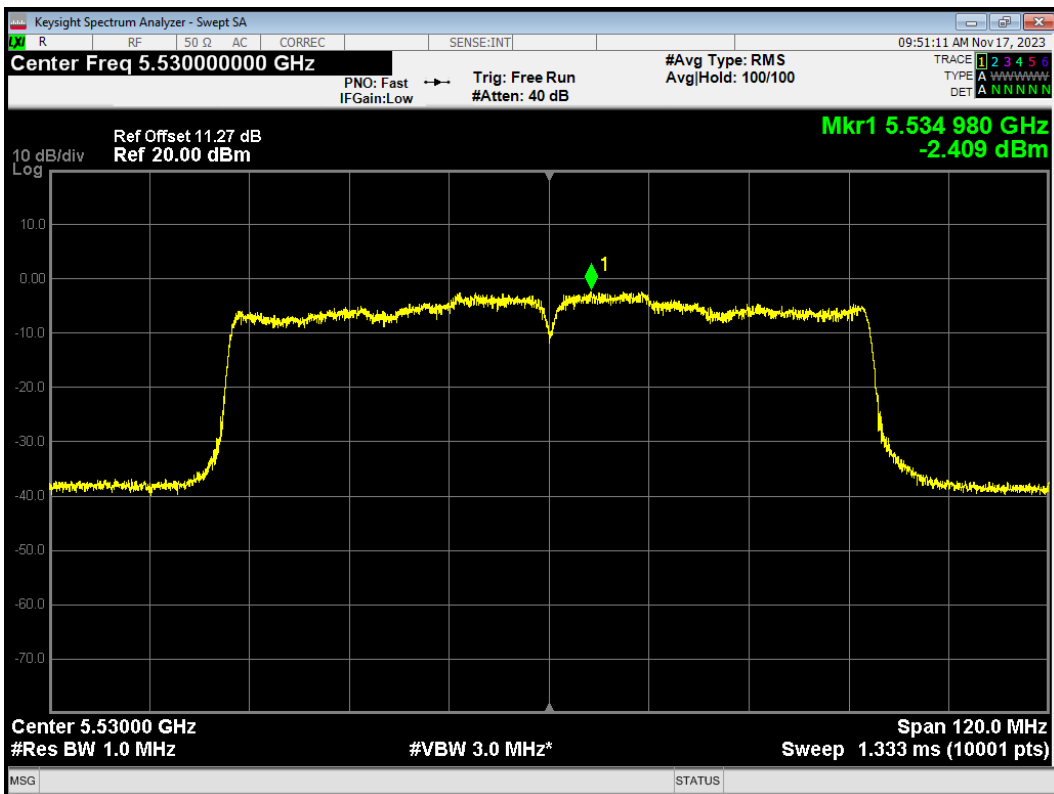

PSD 802.11ac(VHT80) 5690MHz Ant1

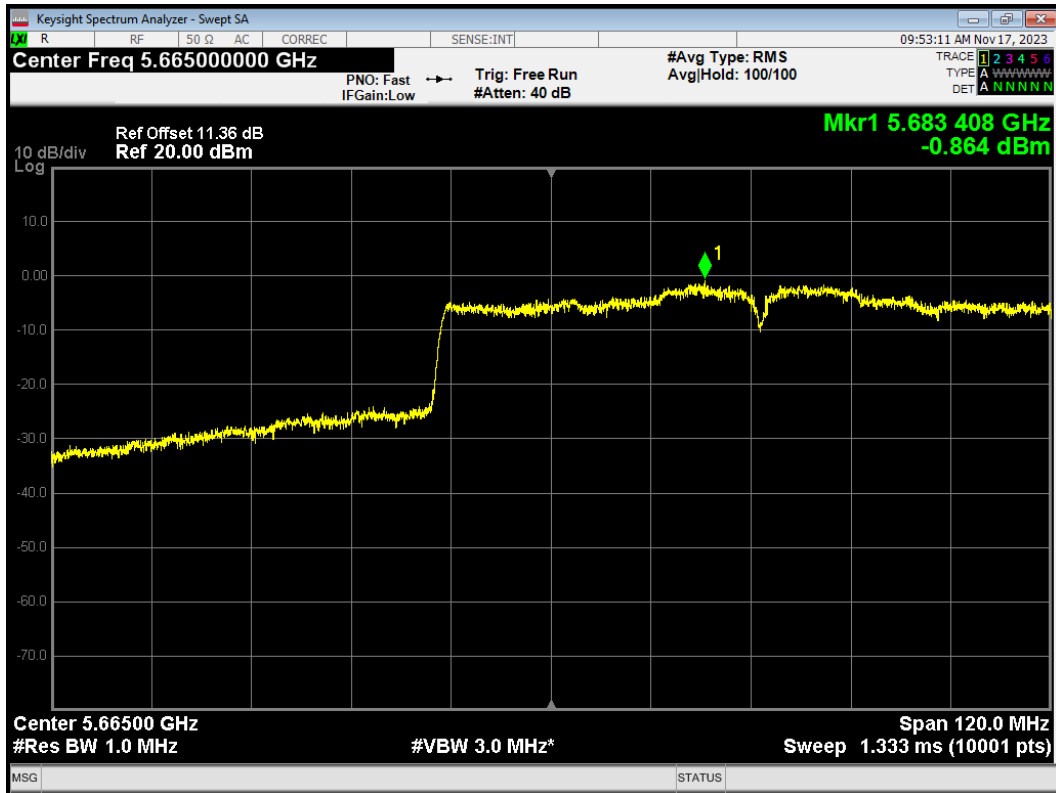

PSD 802.11ac(VHT80) 5690MHz Ant2

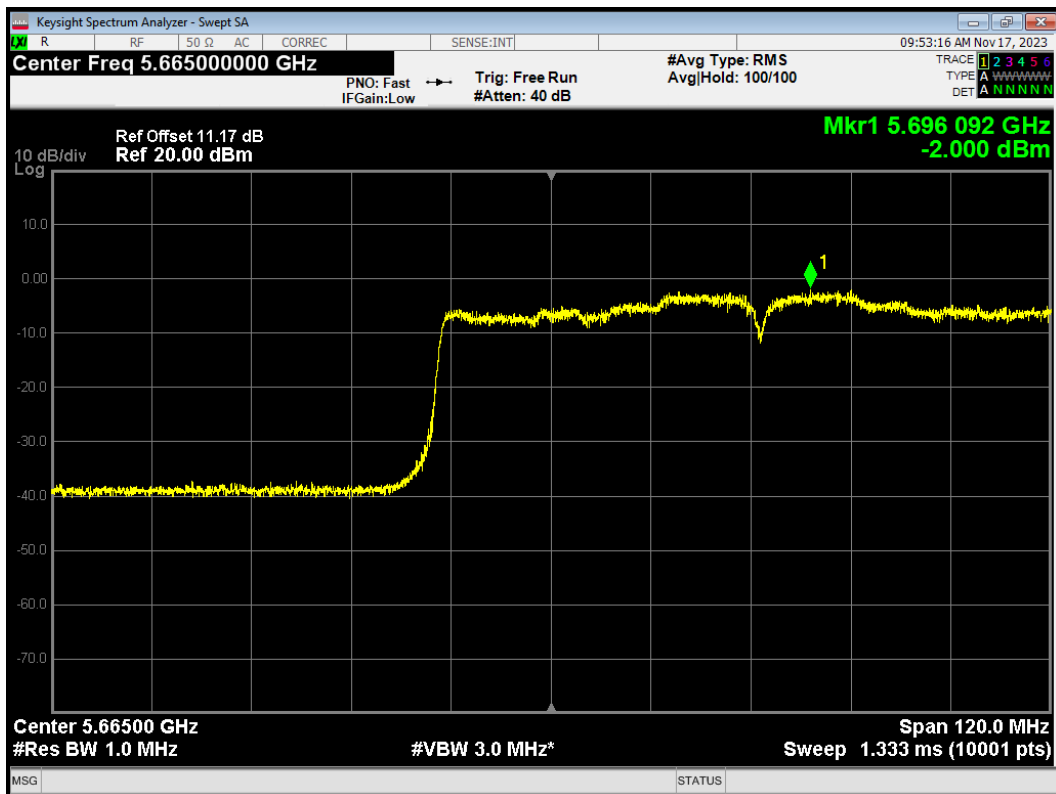

PSD 802.11ax(HE20) 5500MHz Ant1

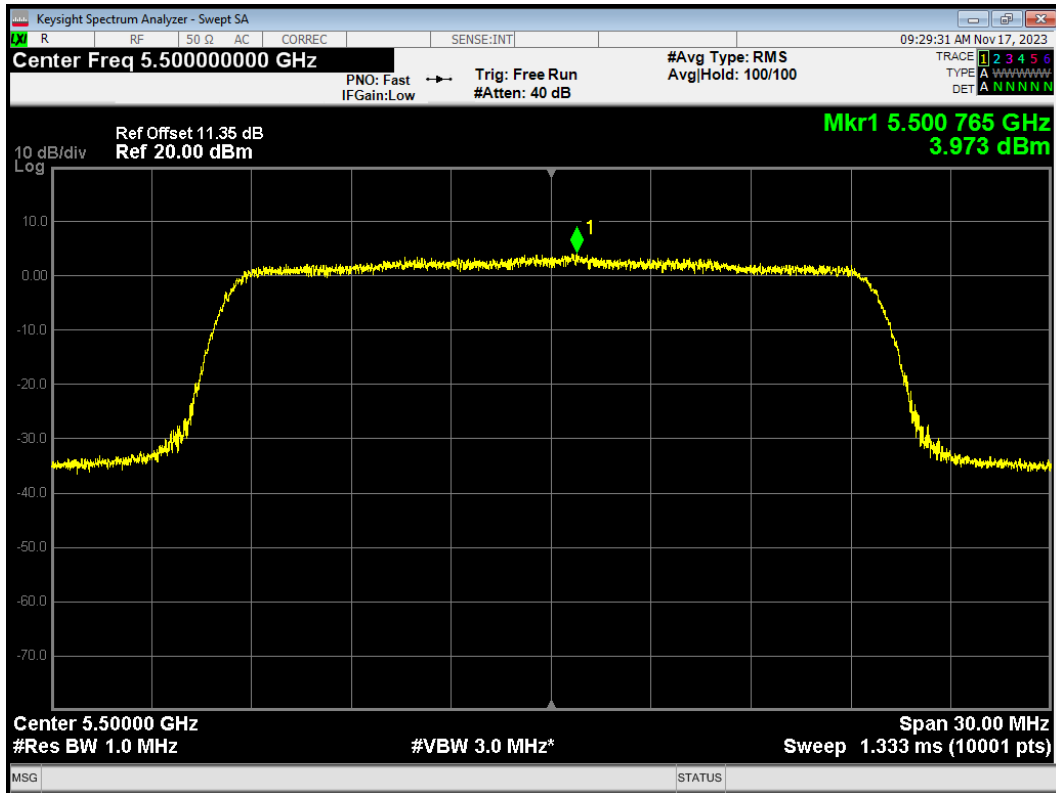

PSD 802.11ax(HE20) 5500MHz Ant2

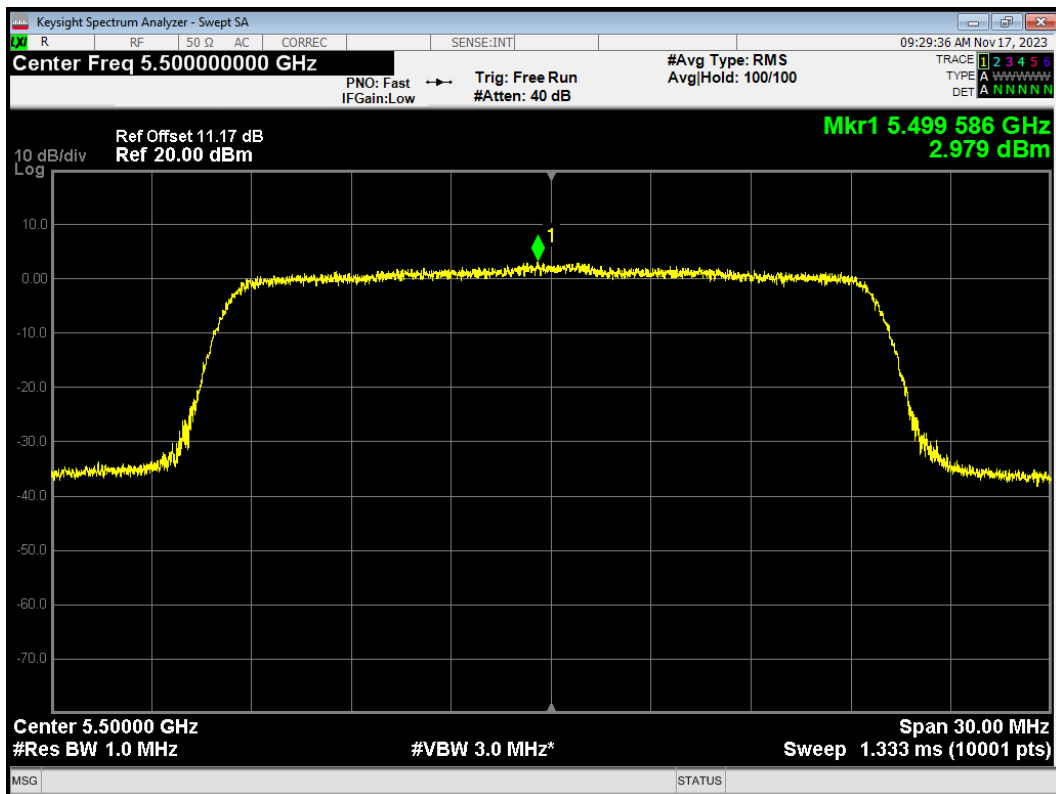

PSD 802.11ax(HE20) 5580MHz Ant1

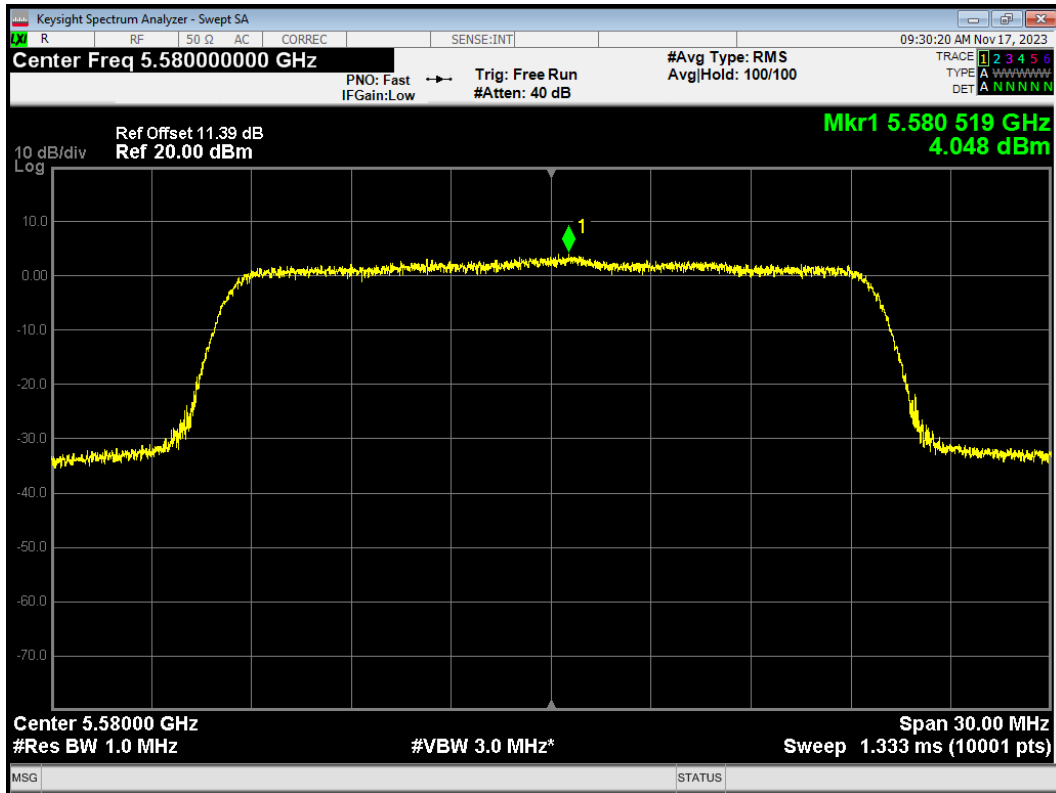

PSD 802.11ax(HE20) 5580MHz Ant2

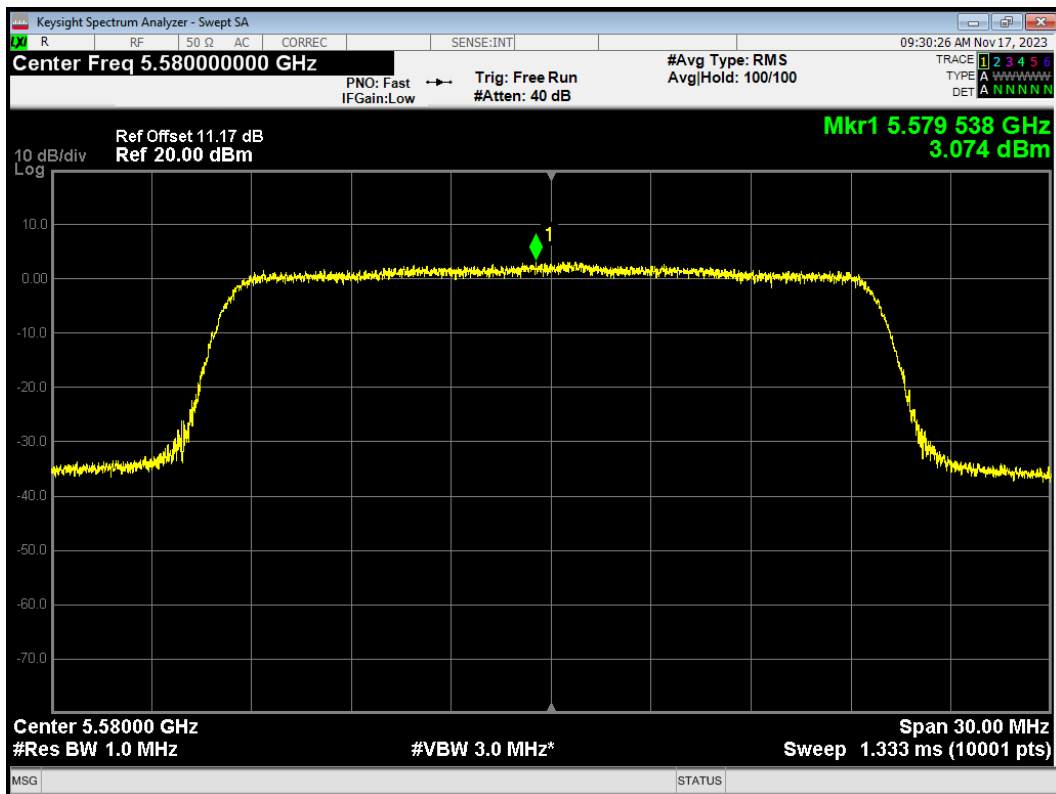

PSD 802.11ax(HE20) 5700MHz Ant1

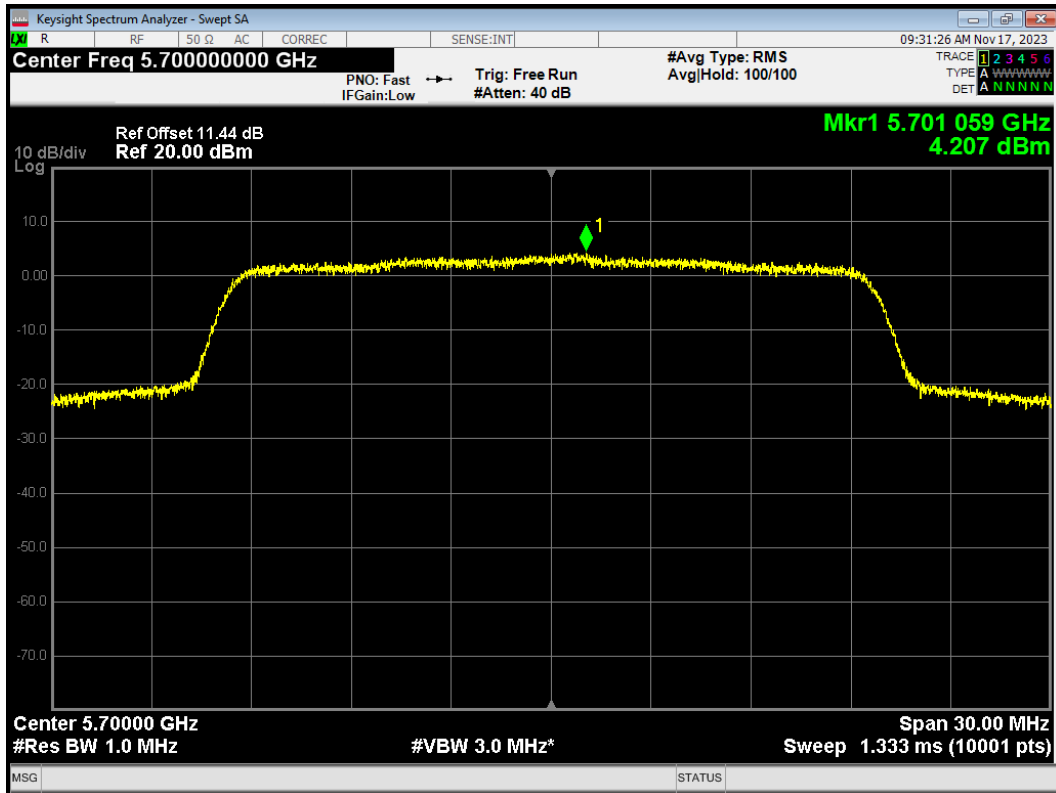

PSD 802.11ax(HE20) 5700MHz Ant2

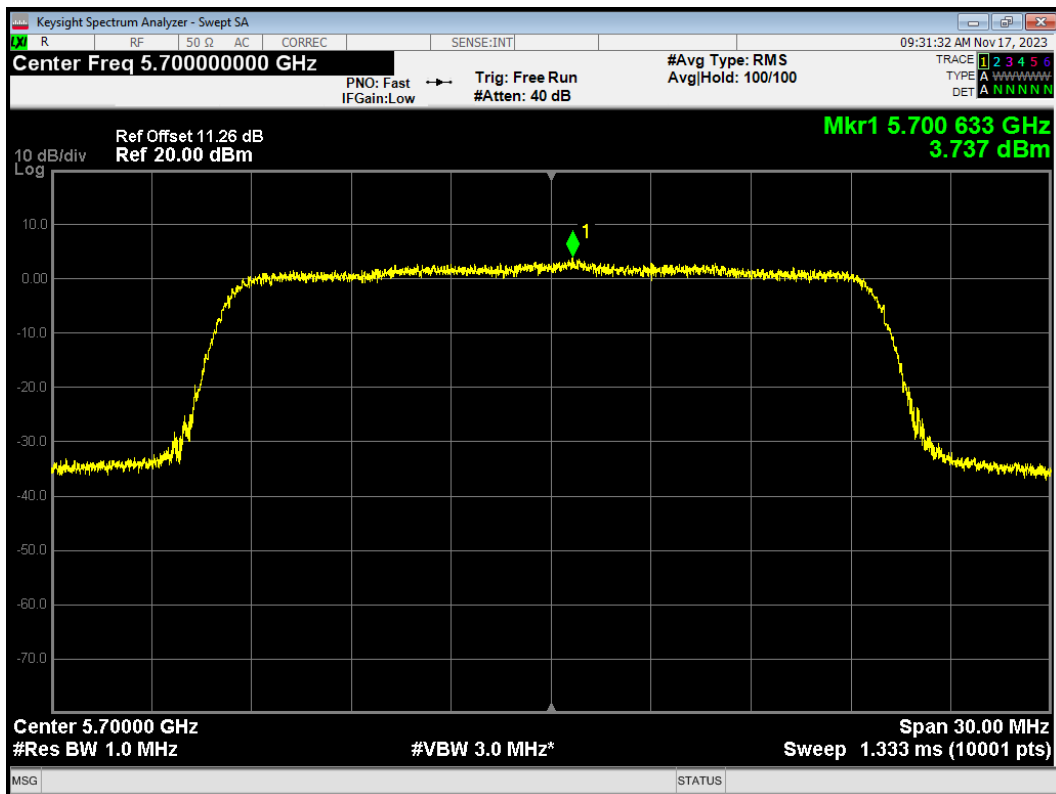

PSD 802.11ax(HE20) 5720MHz Ant1

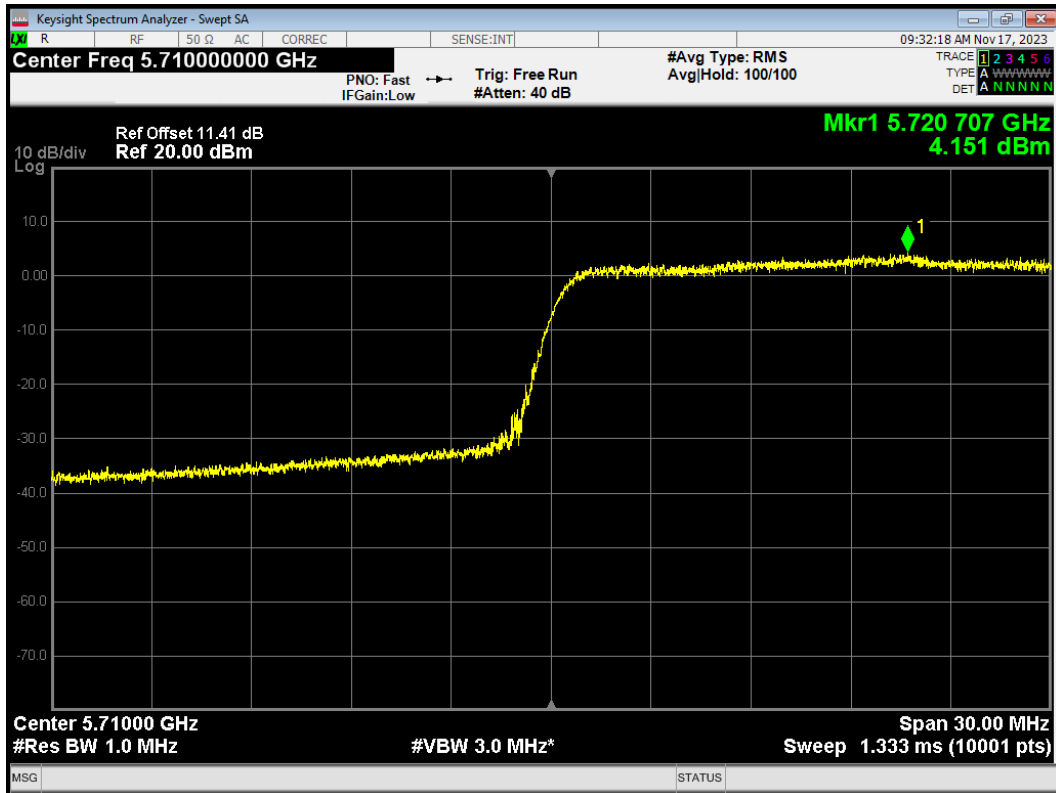

PSD 802.11ax(HE20) 5720MHz Ant2

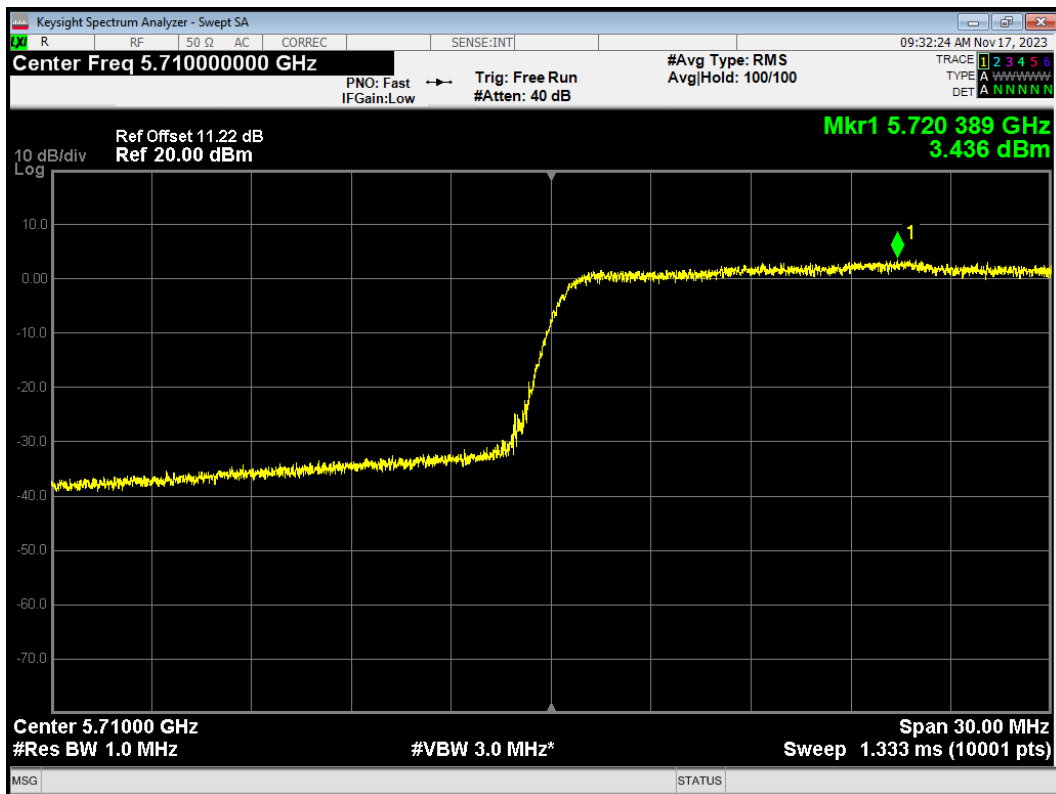

PSD 802.11ax(HE40) 5510MHz Ant1

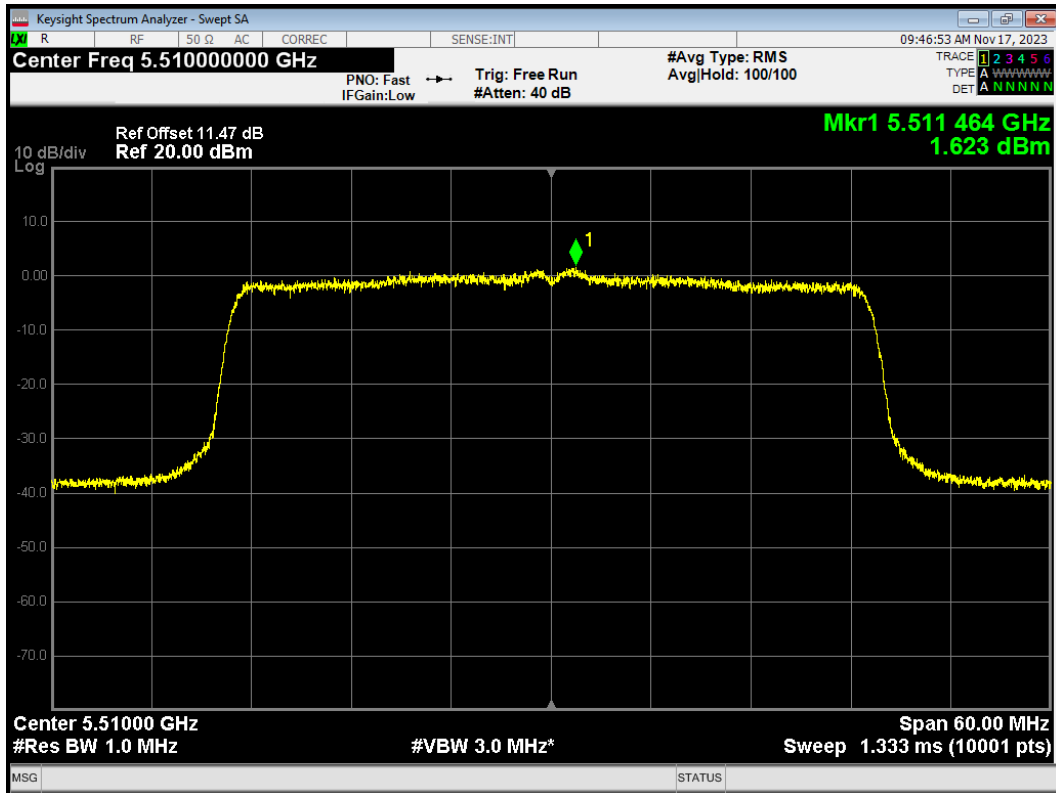

PSD 802.11ax(HE40) 5510MHz Ant2

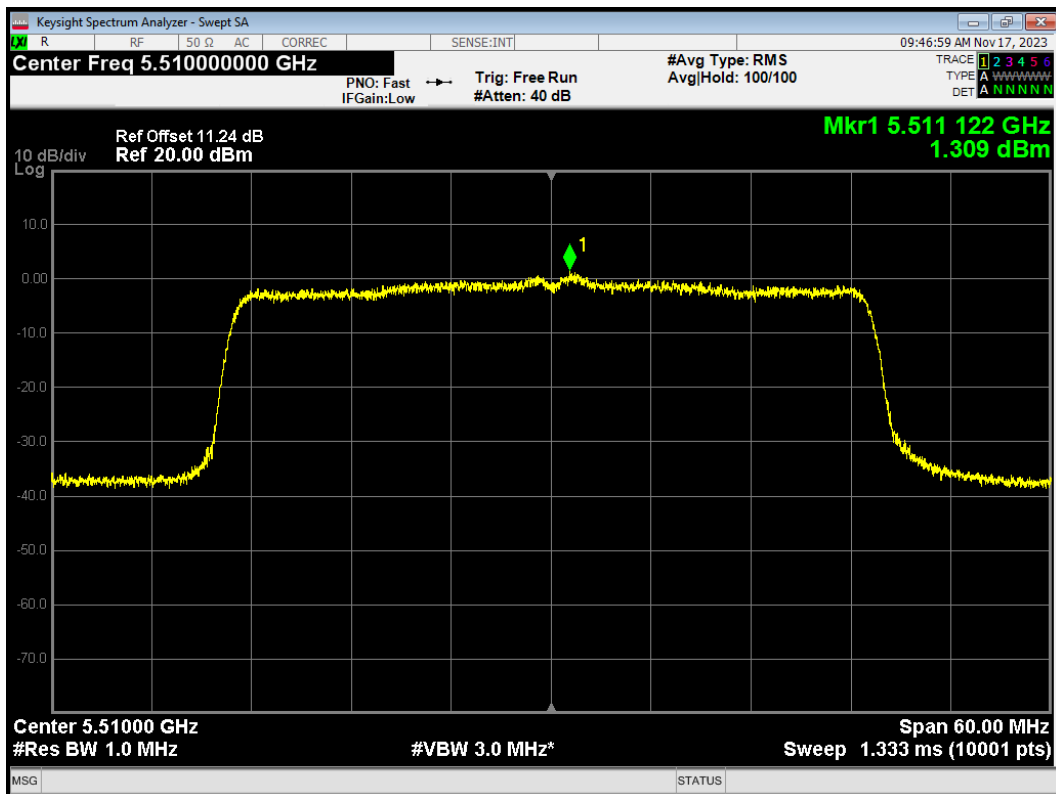

PSD 802.11ax(HE40) 5550MHz Ant1

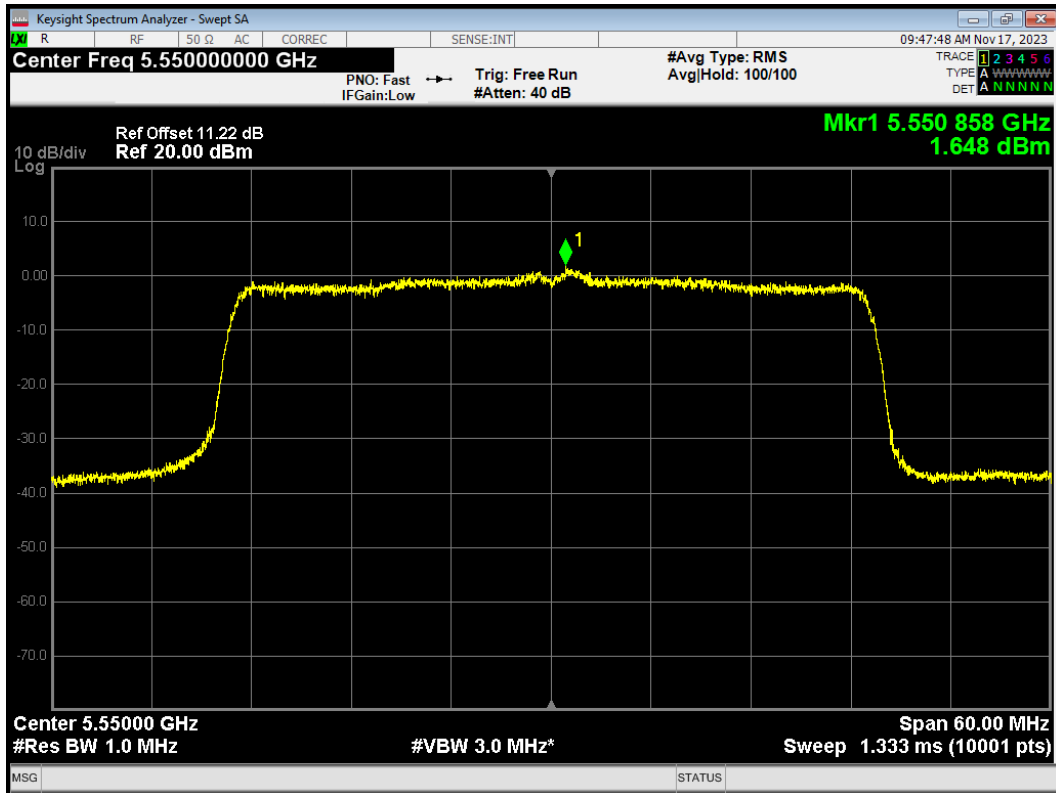

PSD 802.11ax(HE40) 5550MHz Ant2

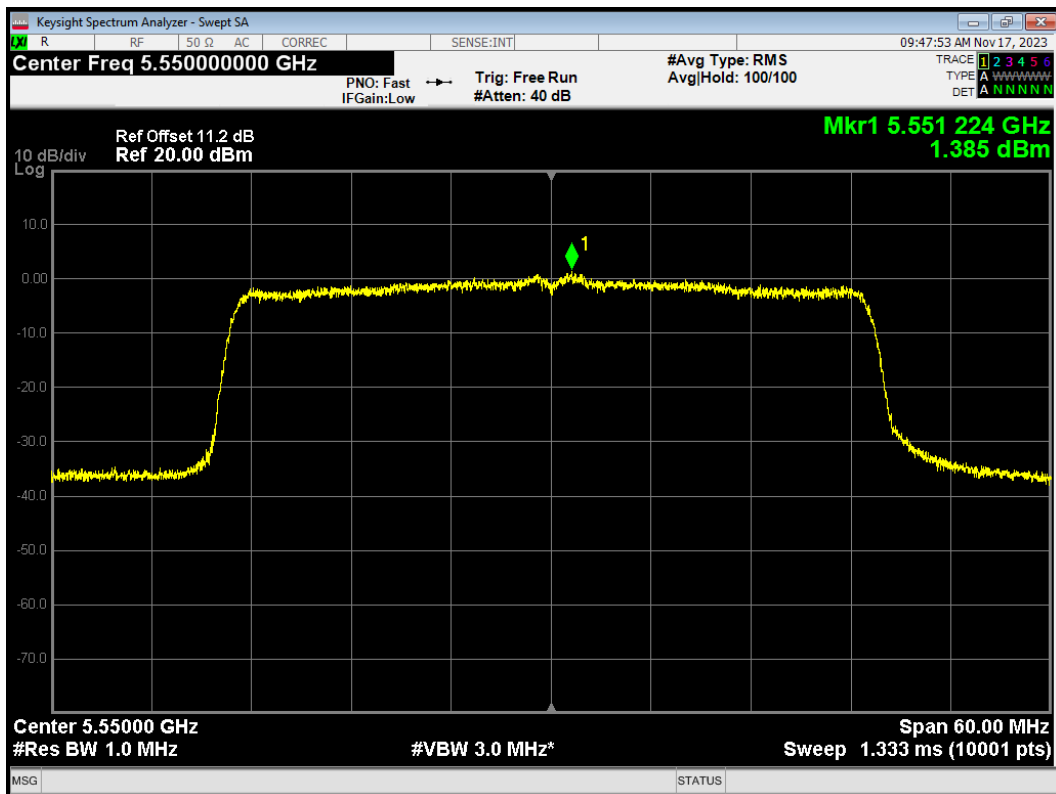

PSD 802.11ax(HE40) 5670MHz Ant1

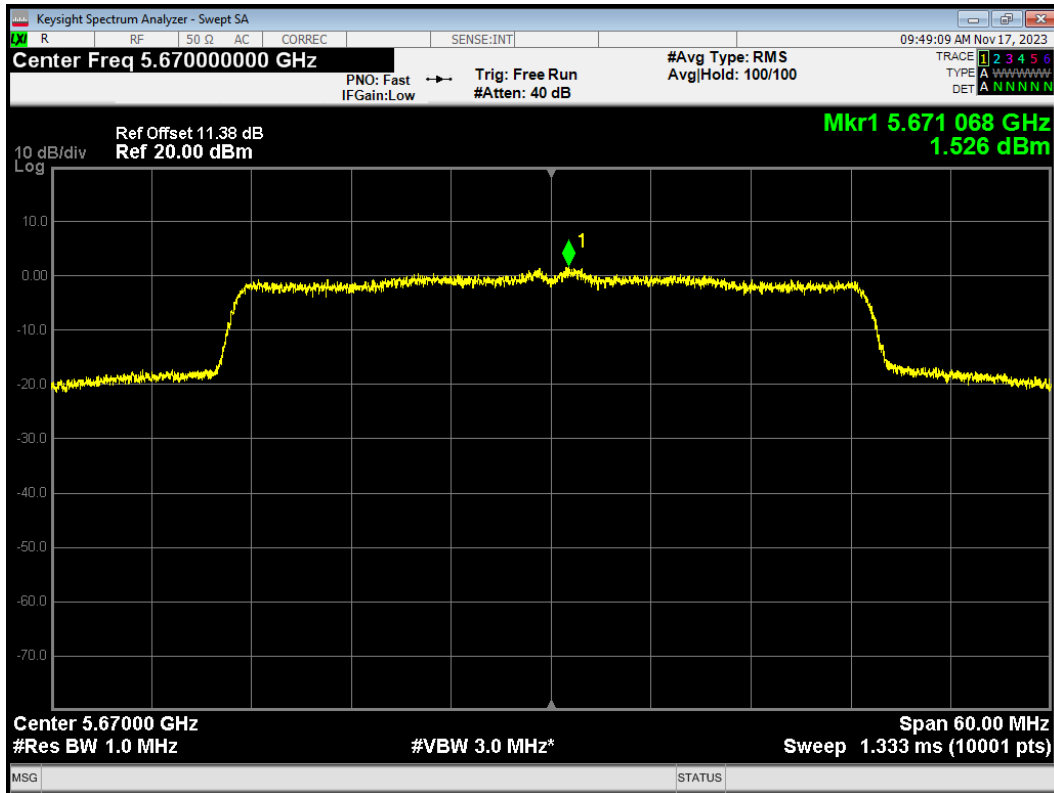

PSD 802.11ax(HE40) 5670MHz Ant2

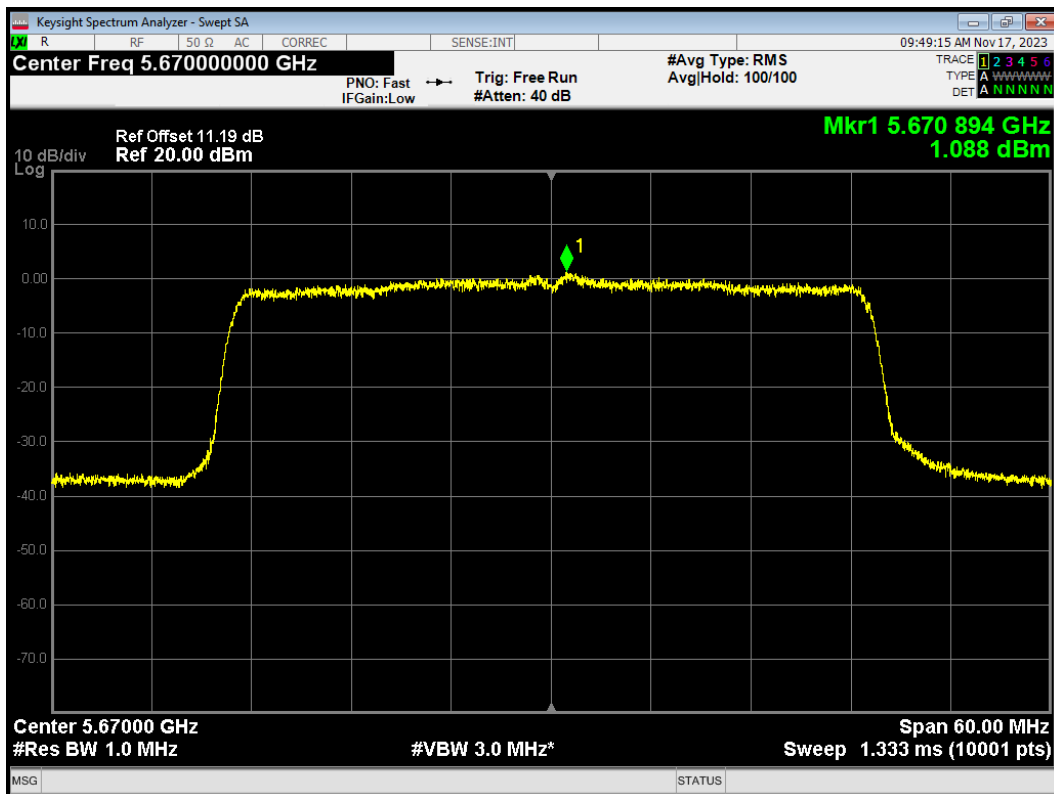

PSD 802.11ax(HE40) 5710MHz Ant1

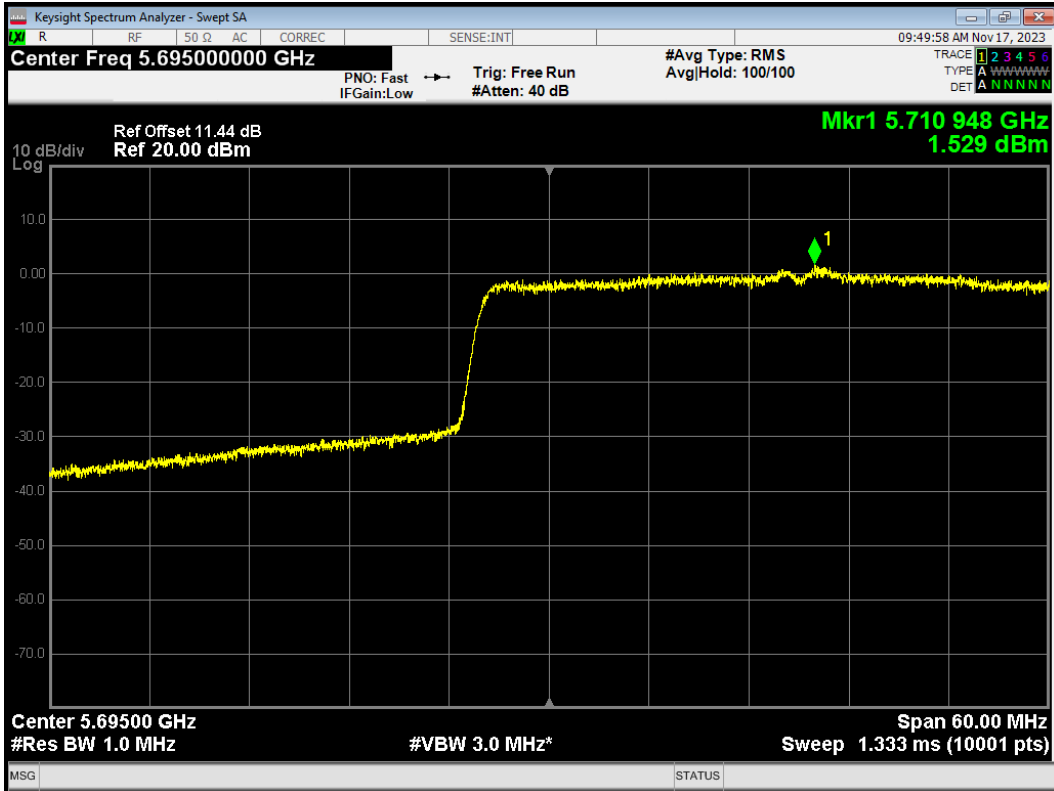

PSD 802.11ax(HE40) 5710MHz Ant2

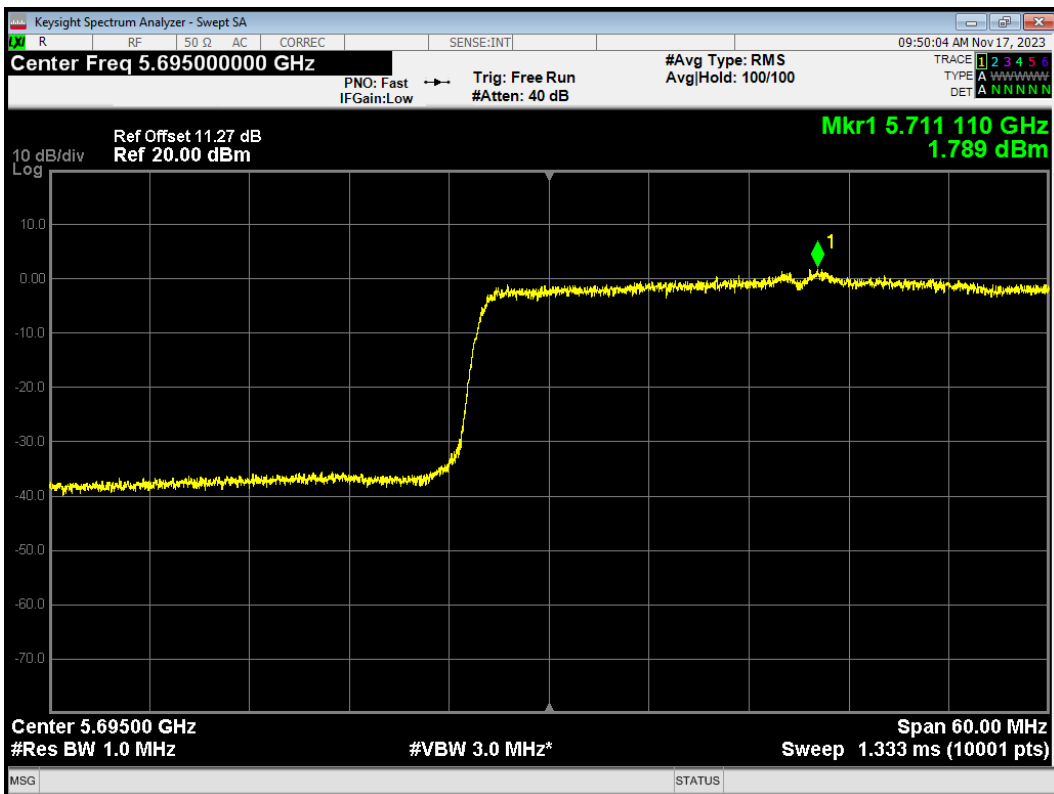

PSD 802.11ax(HE80) 5530MHz Ant1

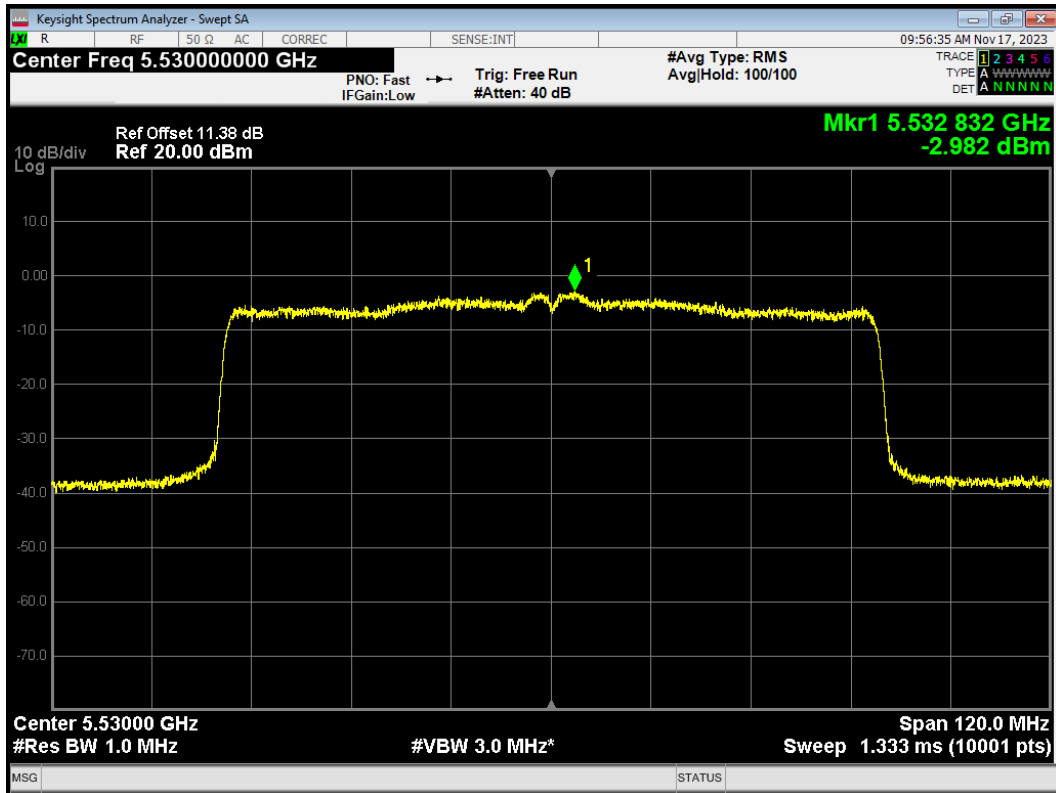

PSD 802.11ax(HE80) 5530MHz Ant2

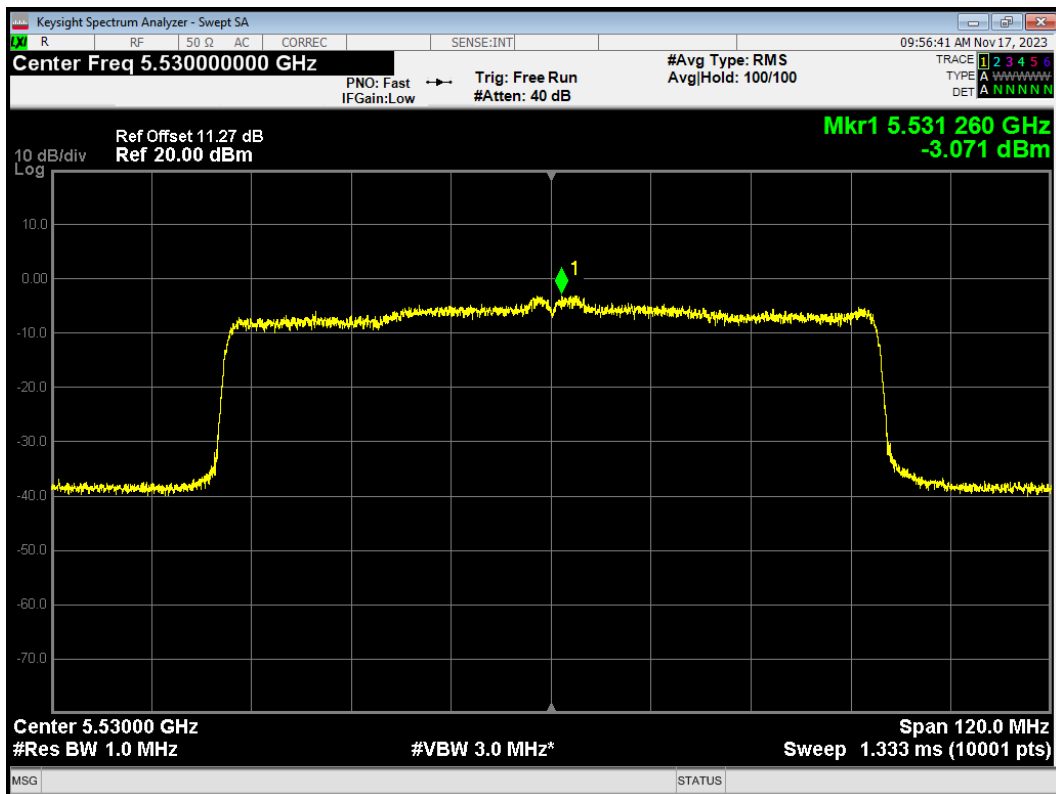

PSD 802.11ax(HE80) 5690MHz Ant1

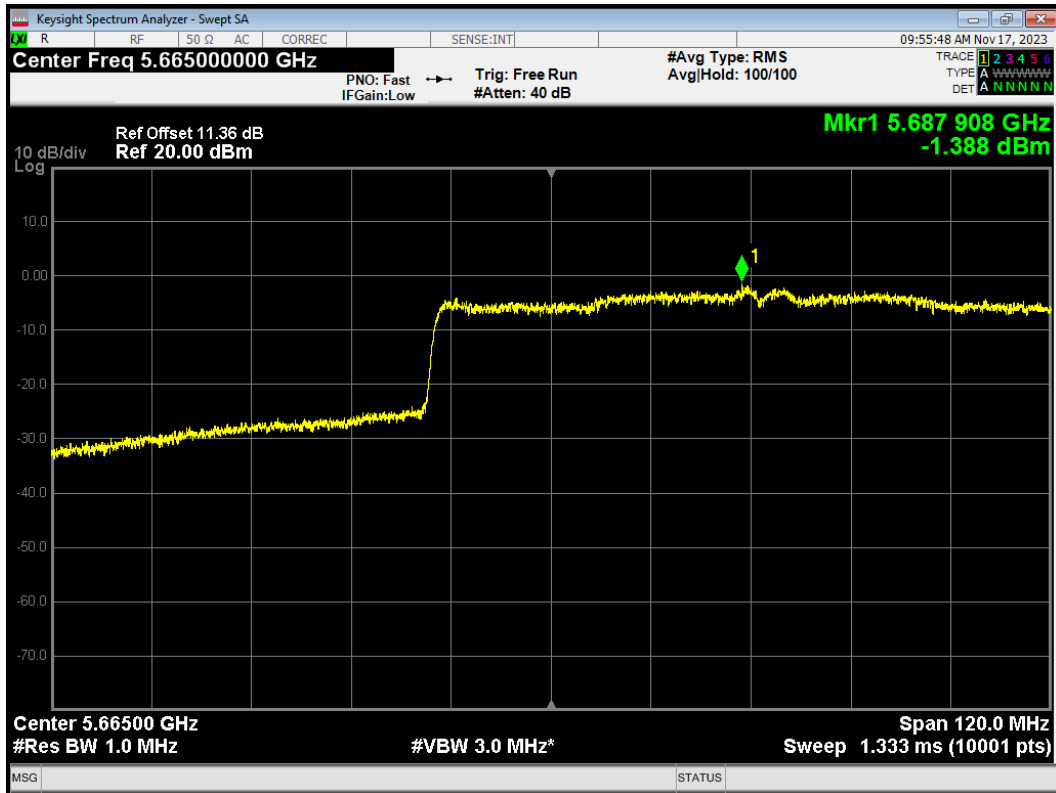

PSD 802.11ax(HE80) 5690MHz Ant2

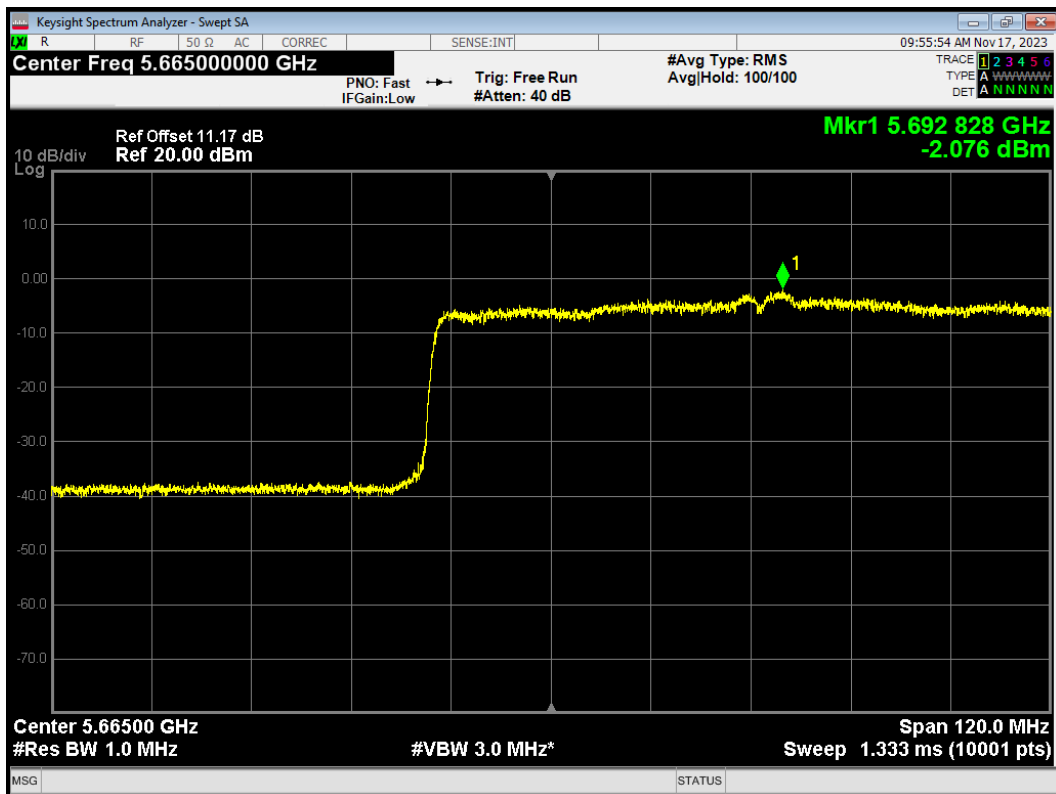

PSD 802.11n(HT20) 5500MHz Ant1

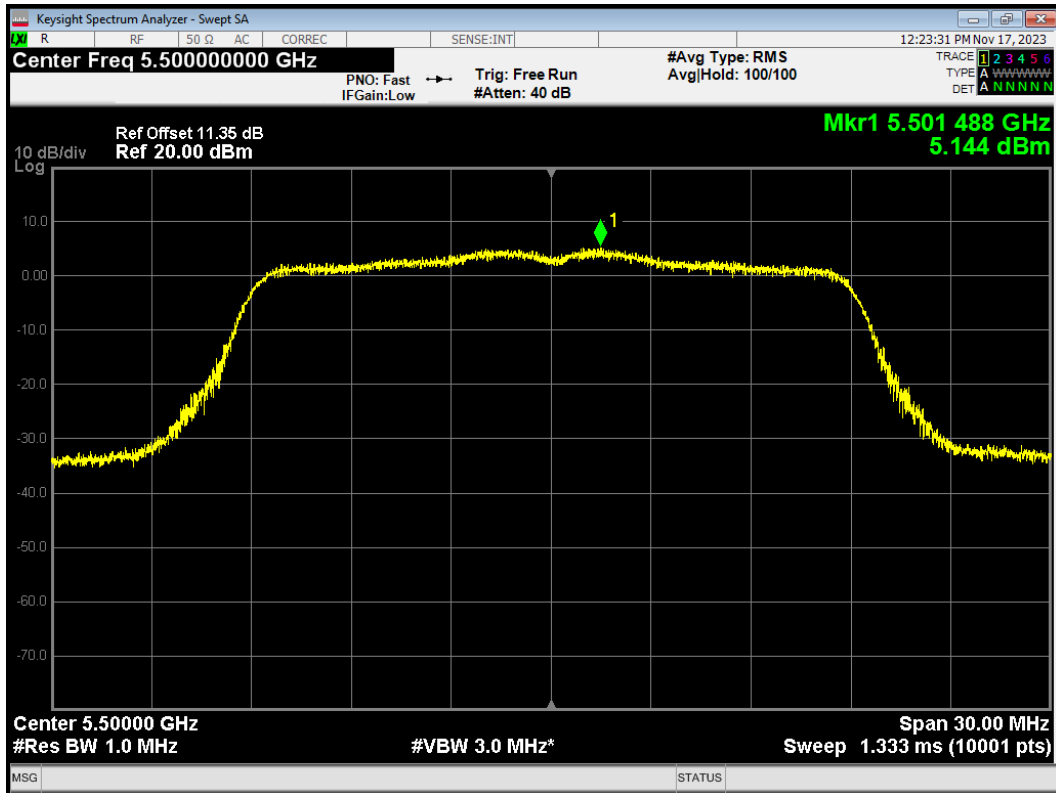

PSD 802.11n(HT20) 5500MHz Ant2

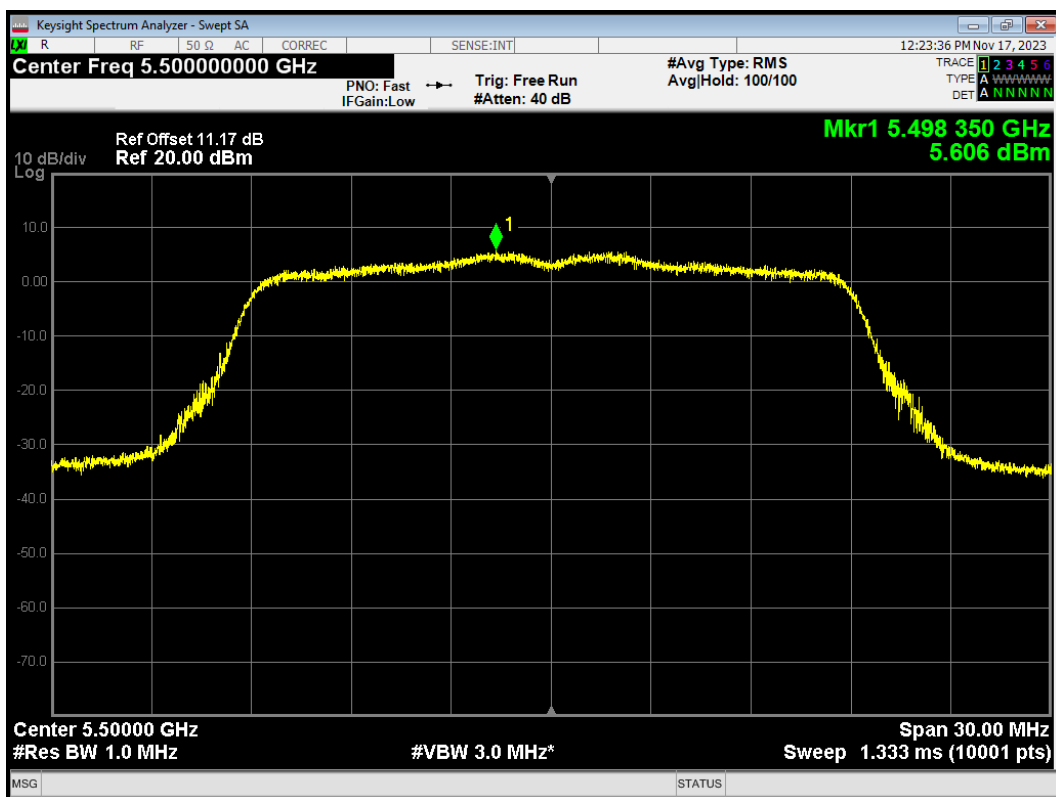

PSD 802.11n(HT20) 5580MHz Ant1

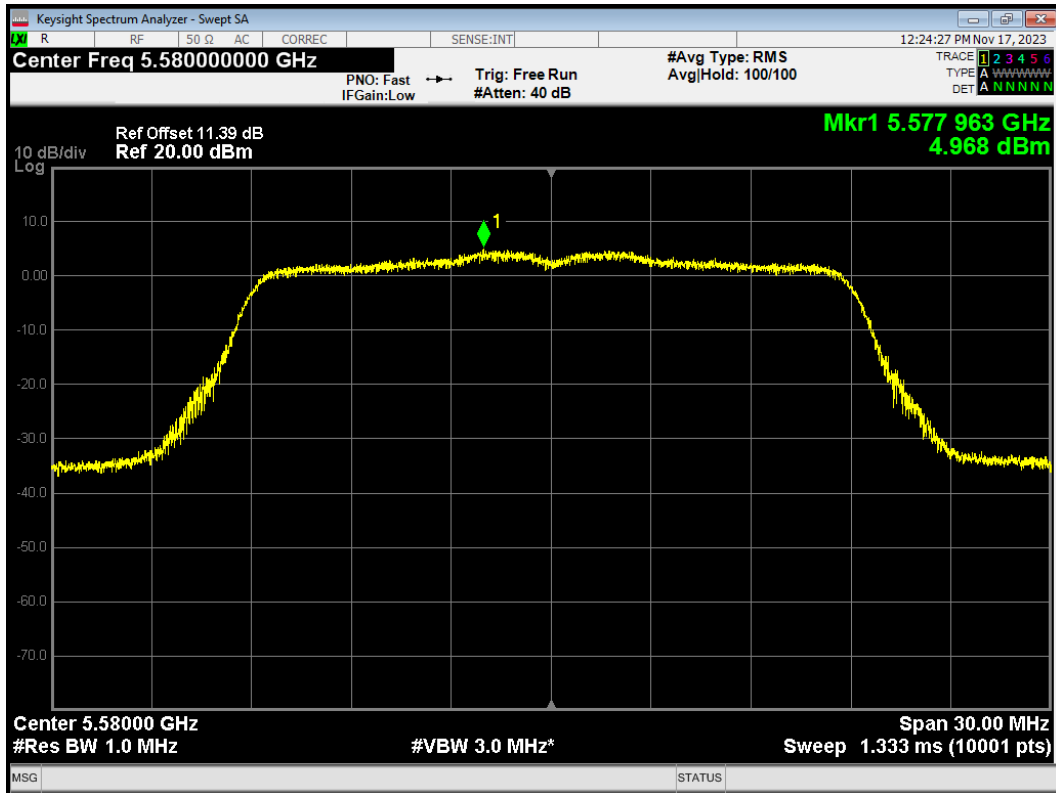

PSD 802.11n(HT20) 5580MHz Ant2

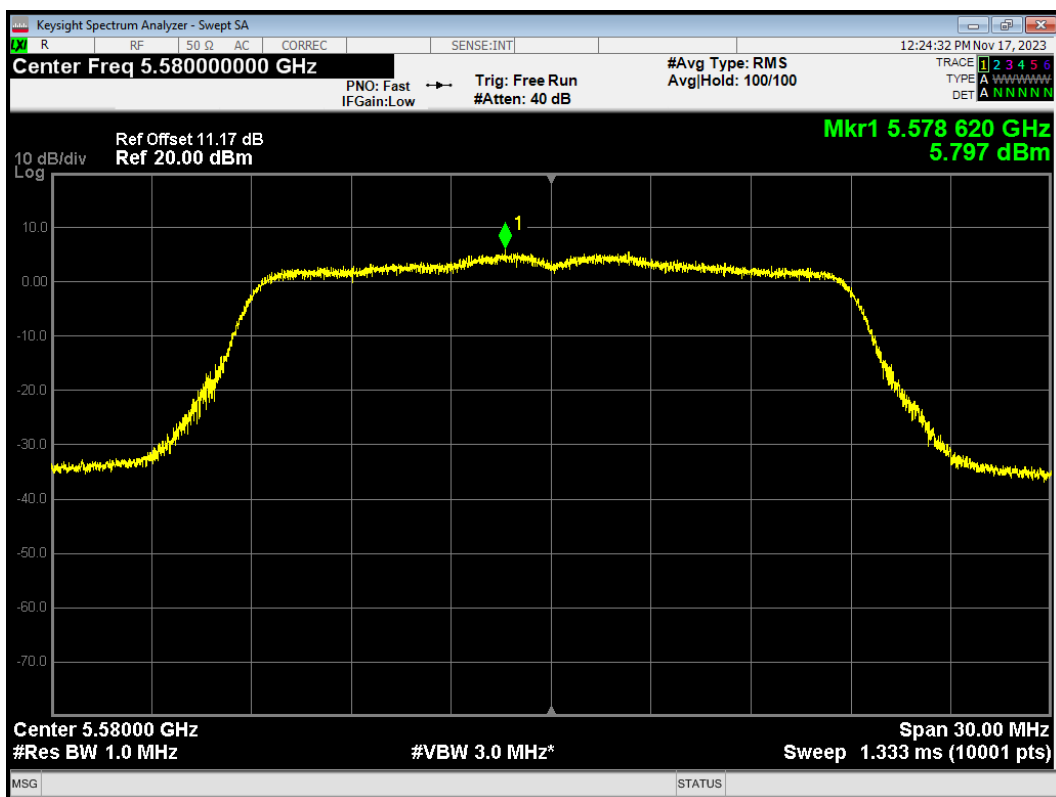

PSD 802.11n(HT20) 5700MHz Ant1

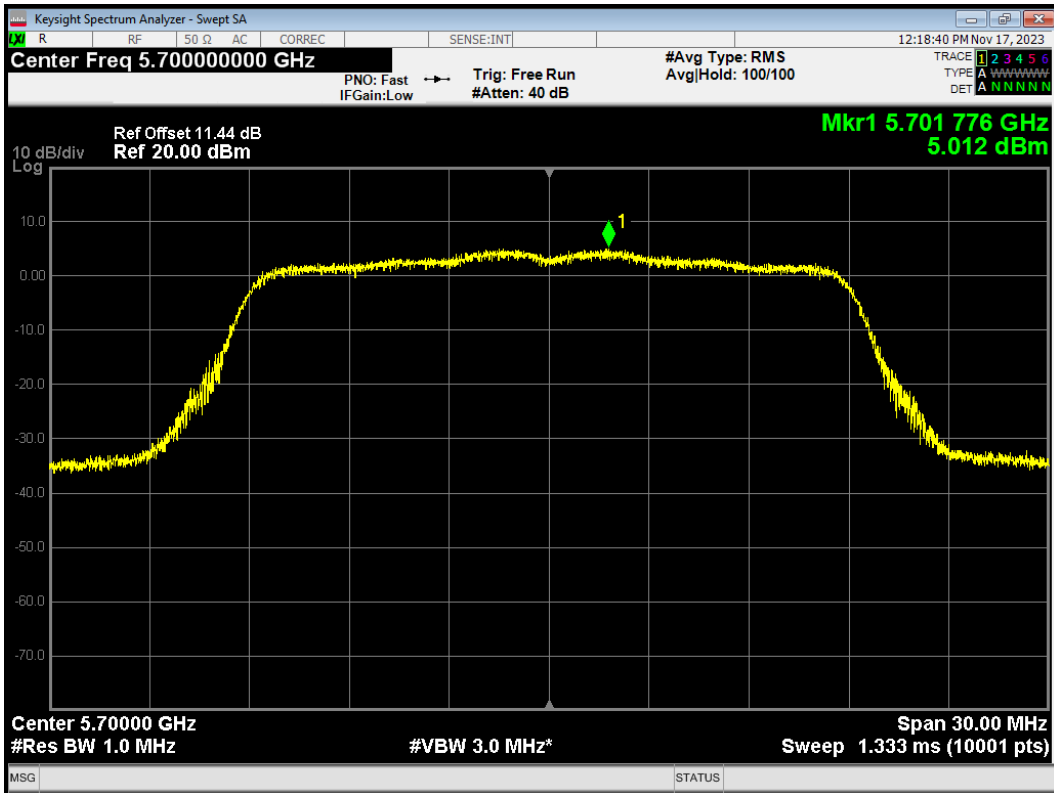

PSD 802.11n(HT20) 5700MHz Ant2

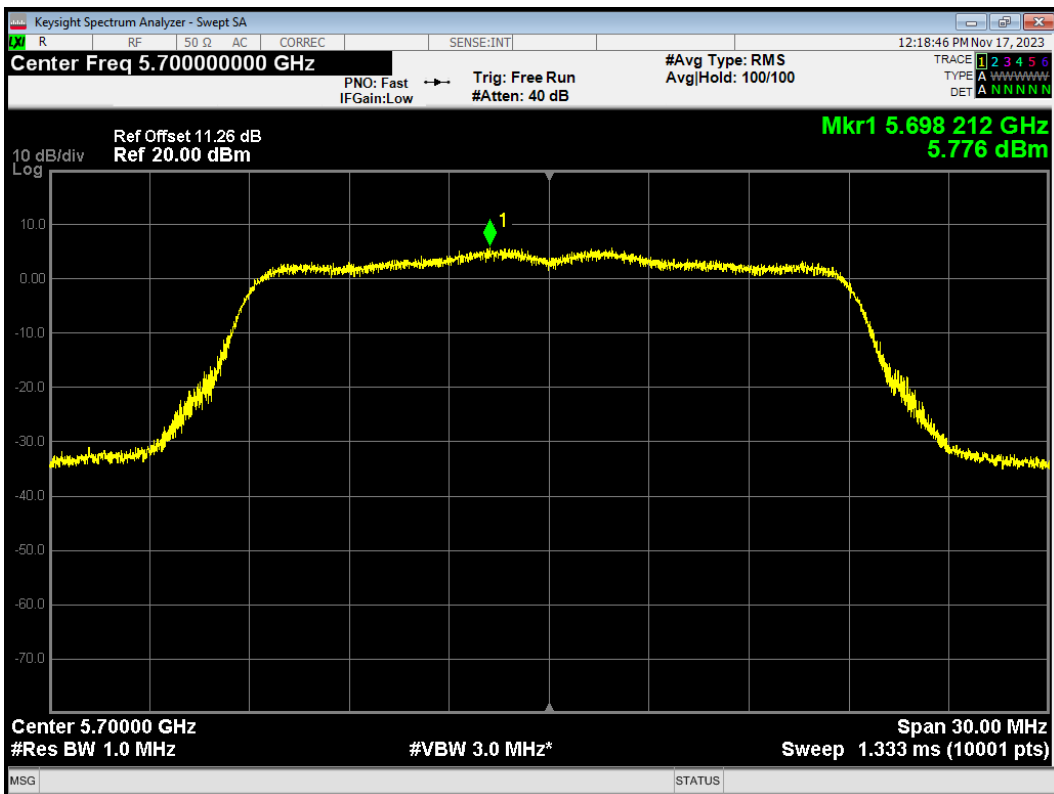

PSD 802.11n(HT20) 5720MHz Ant1

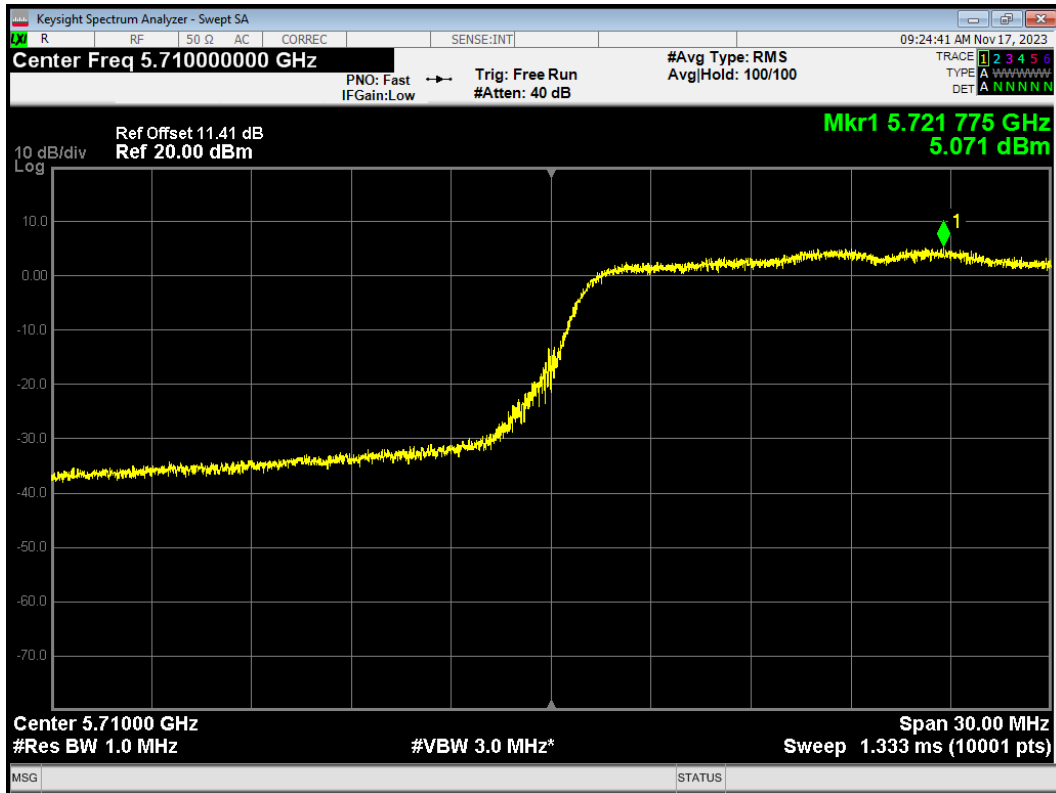

PSD 802.11n(HT20) 5720MHz Ant2

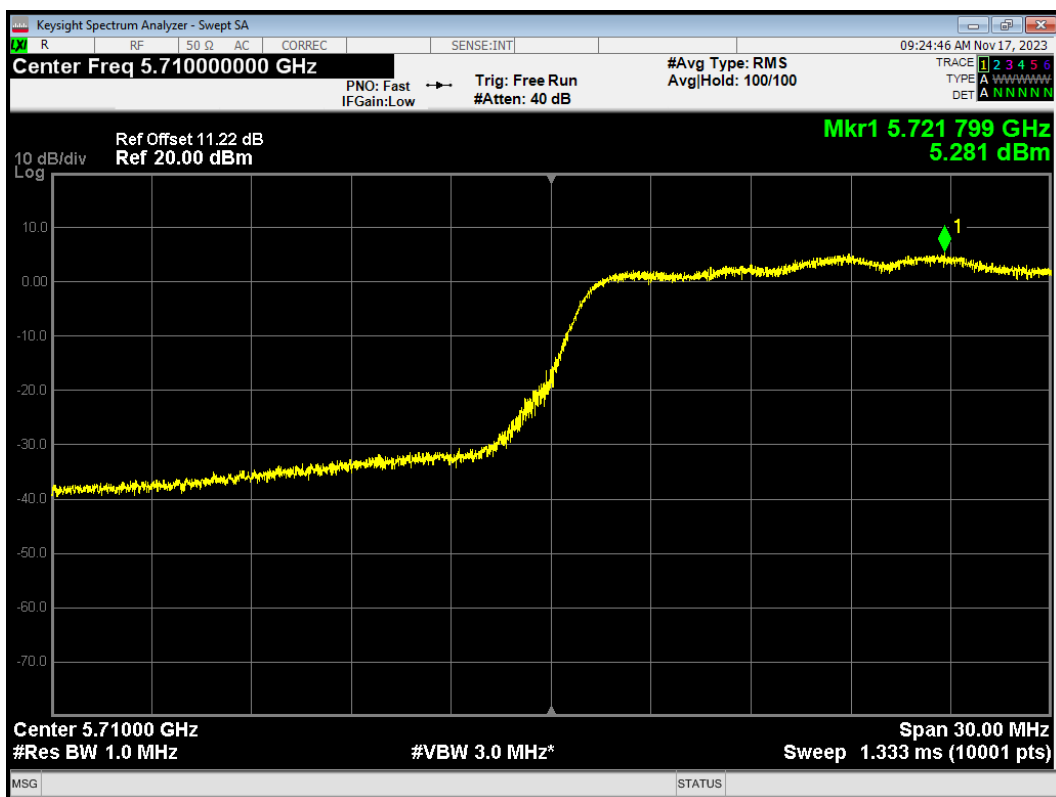

PSD 802.11n(HT40) 5510MHz Ant1

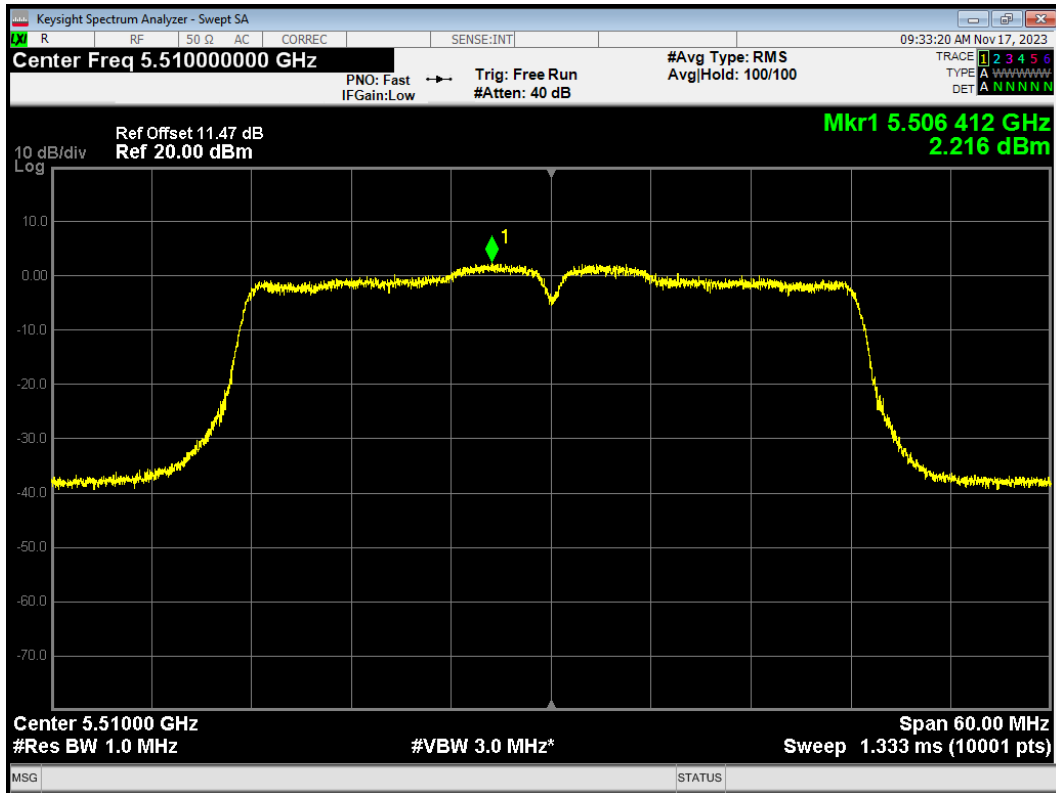

PSD 802.11n(HT40) 5510MHz Ant2

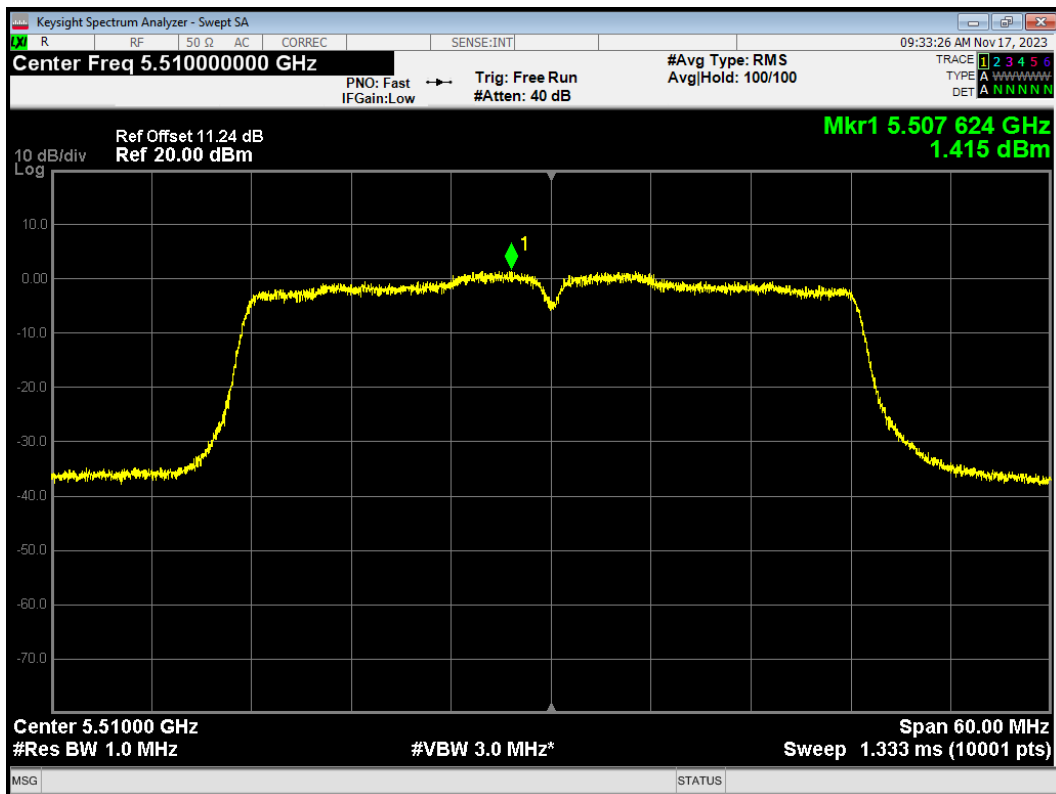

PSD 802.11n(HT40) 5550MHz Ant1

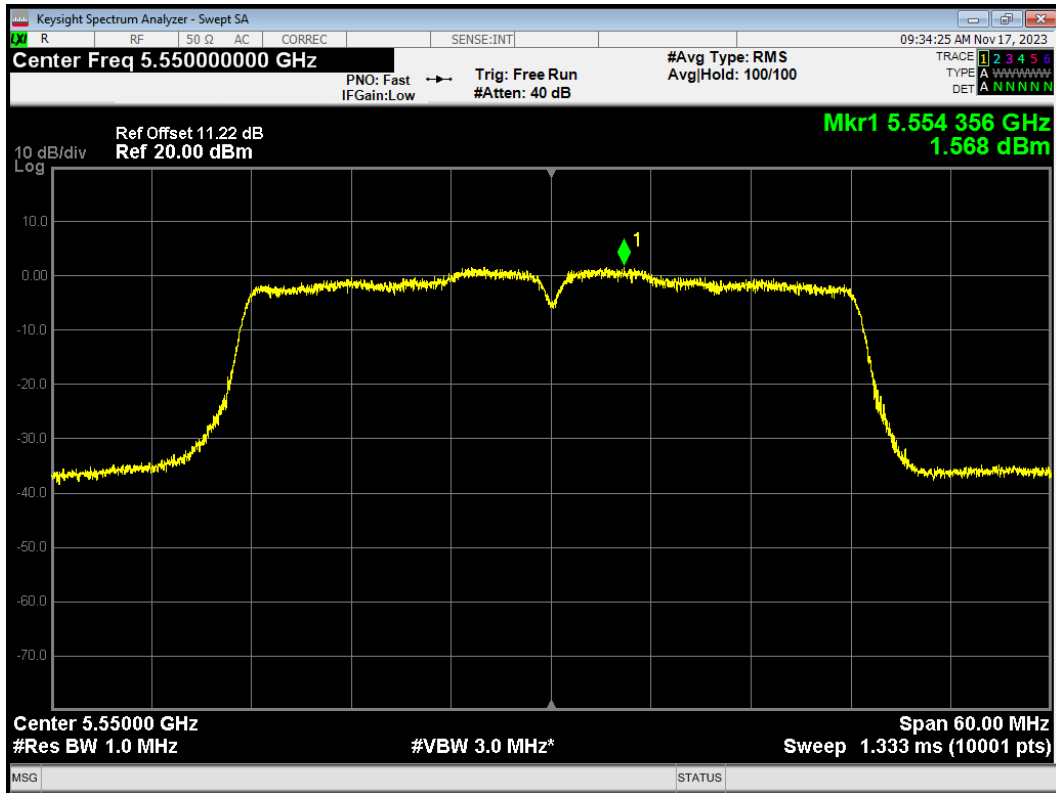

PSD 802.11n(HT40) 5550MHz Ant2

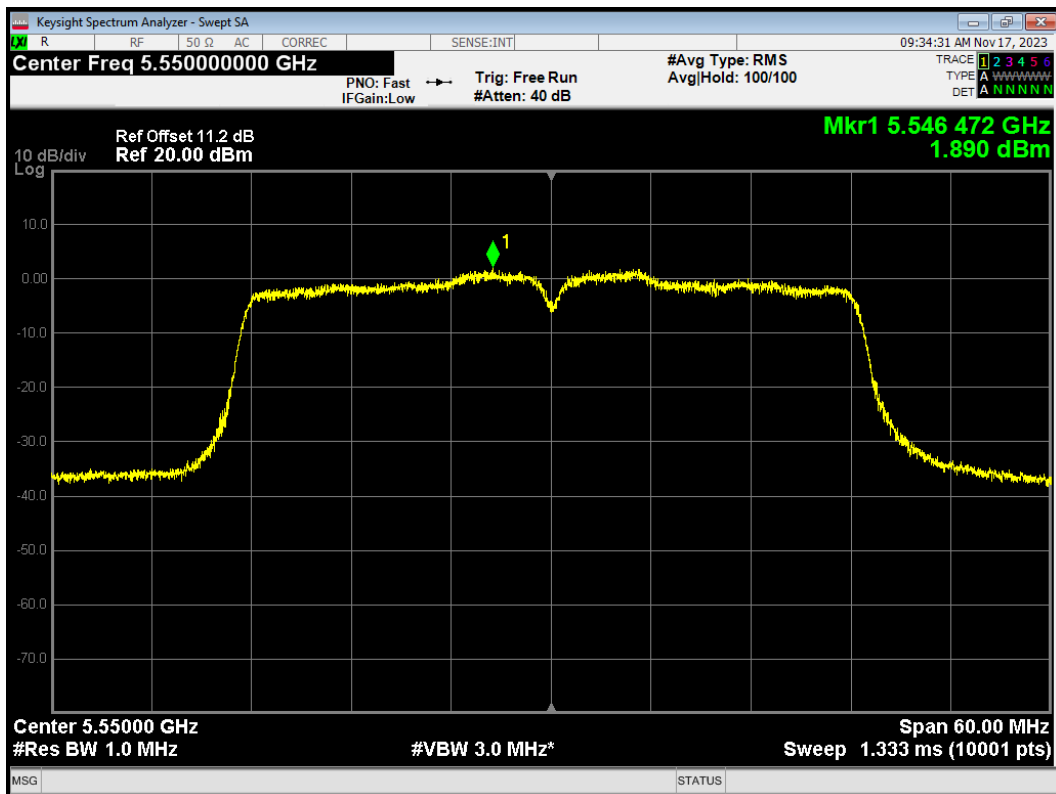

PSD 802.11n(HT40) 5670MHz Ant1

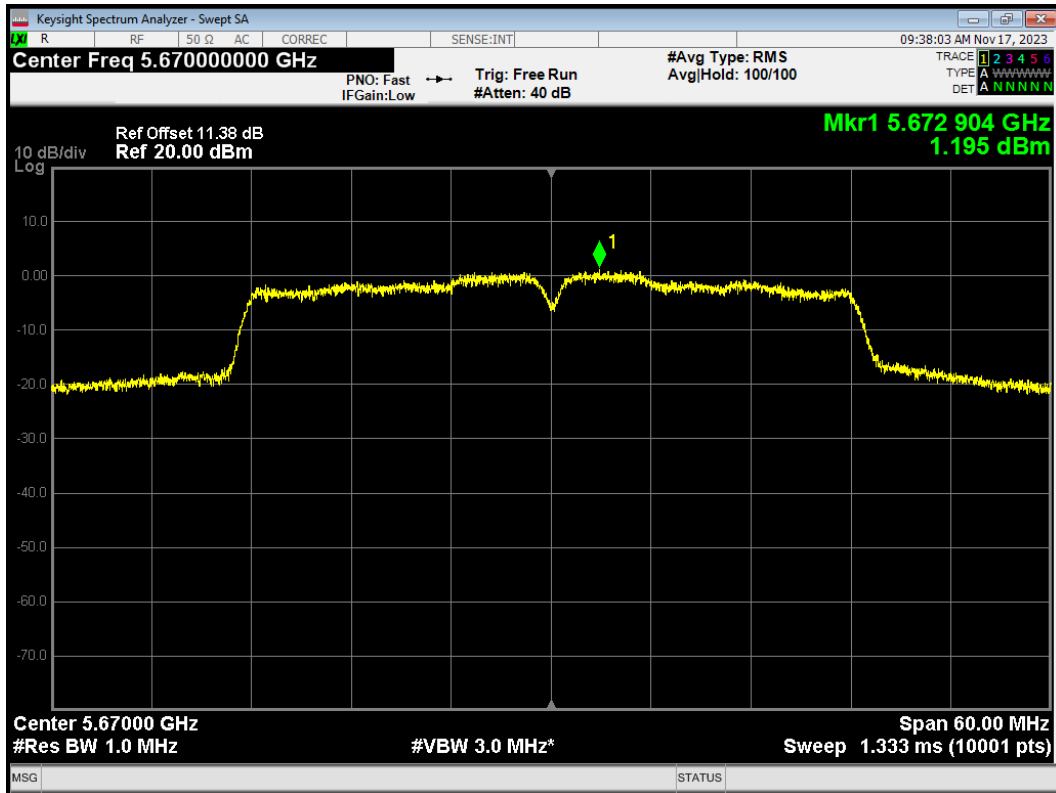

PSD 802.11n(HT40) 5670MHz Ant2

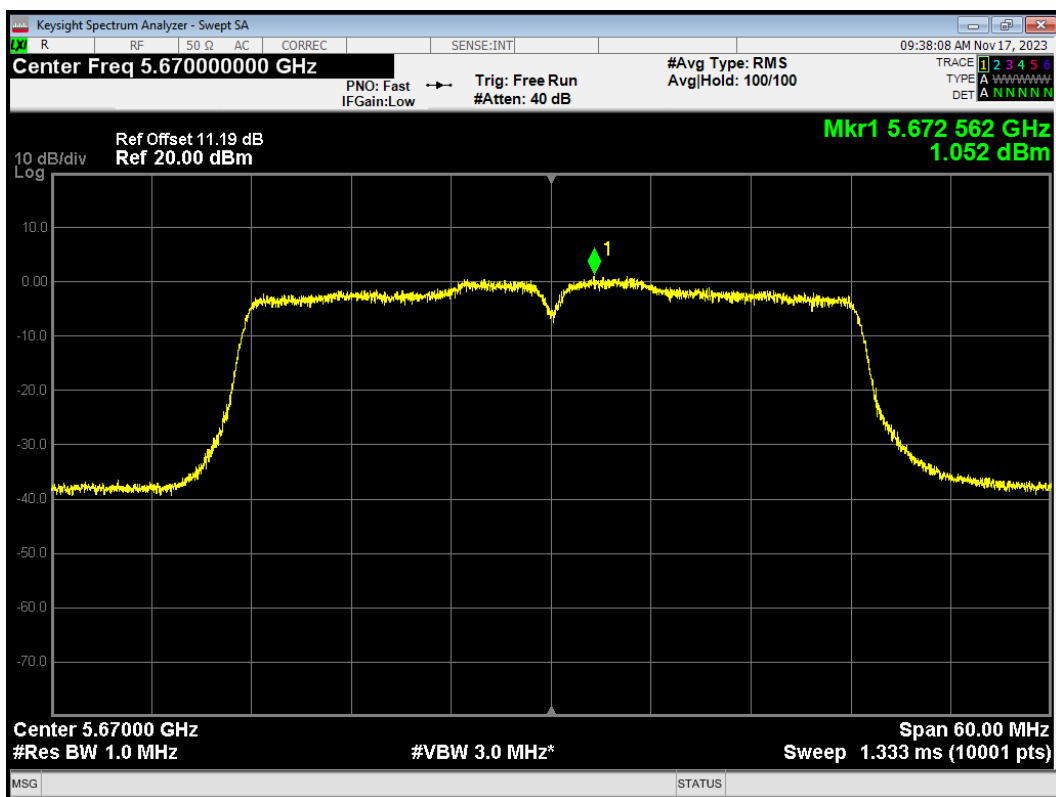

PSD 802.11n(HT40) 5710MHz Ant1

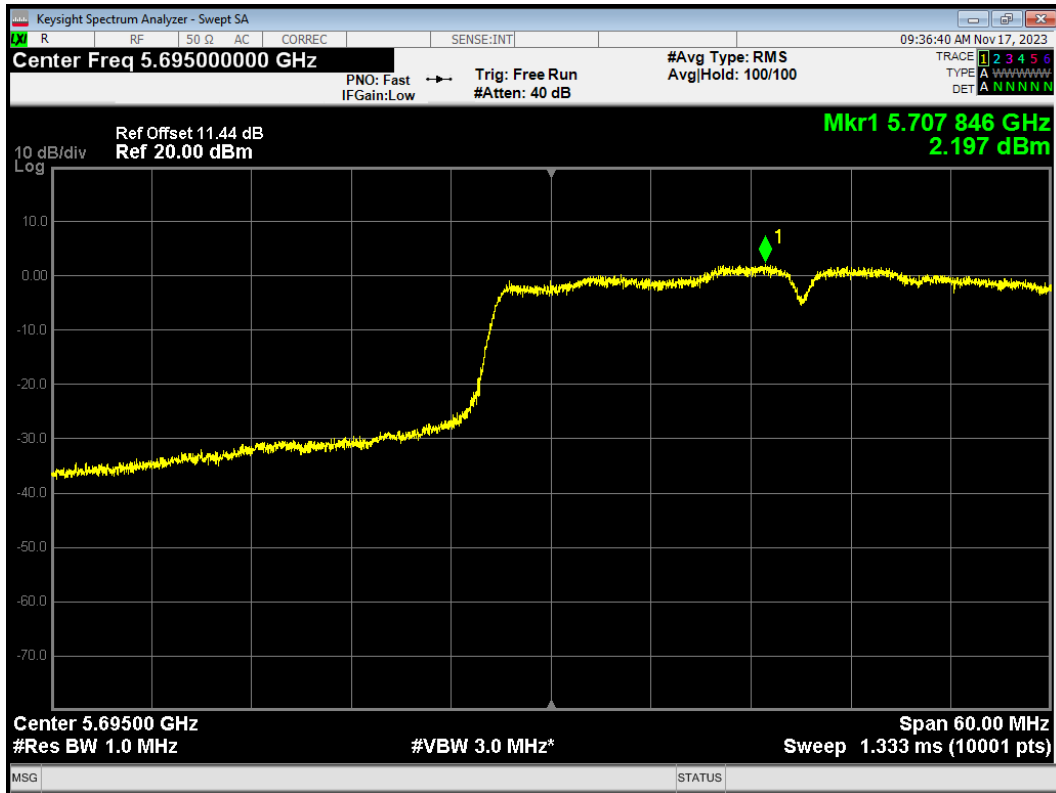

PSD 802.11n(HT40) 5710MHz Ant2

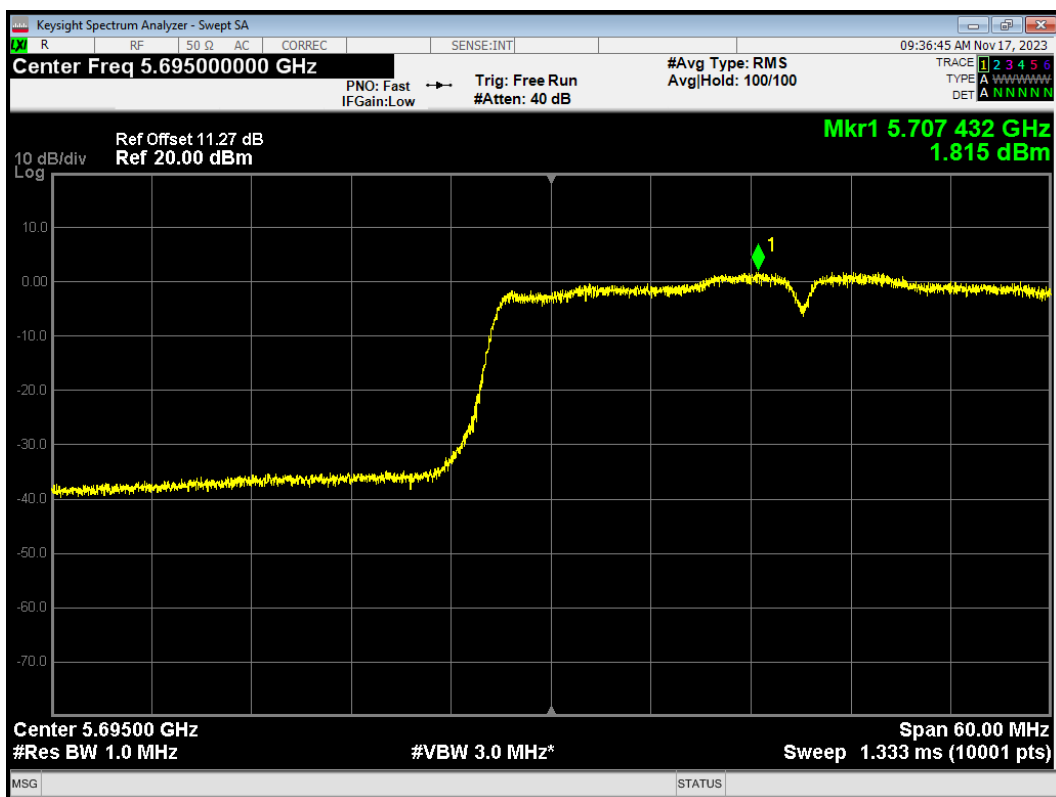

U-NII-3

PSD 802.11ac(VHT20) 5720MHz Ant1

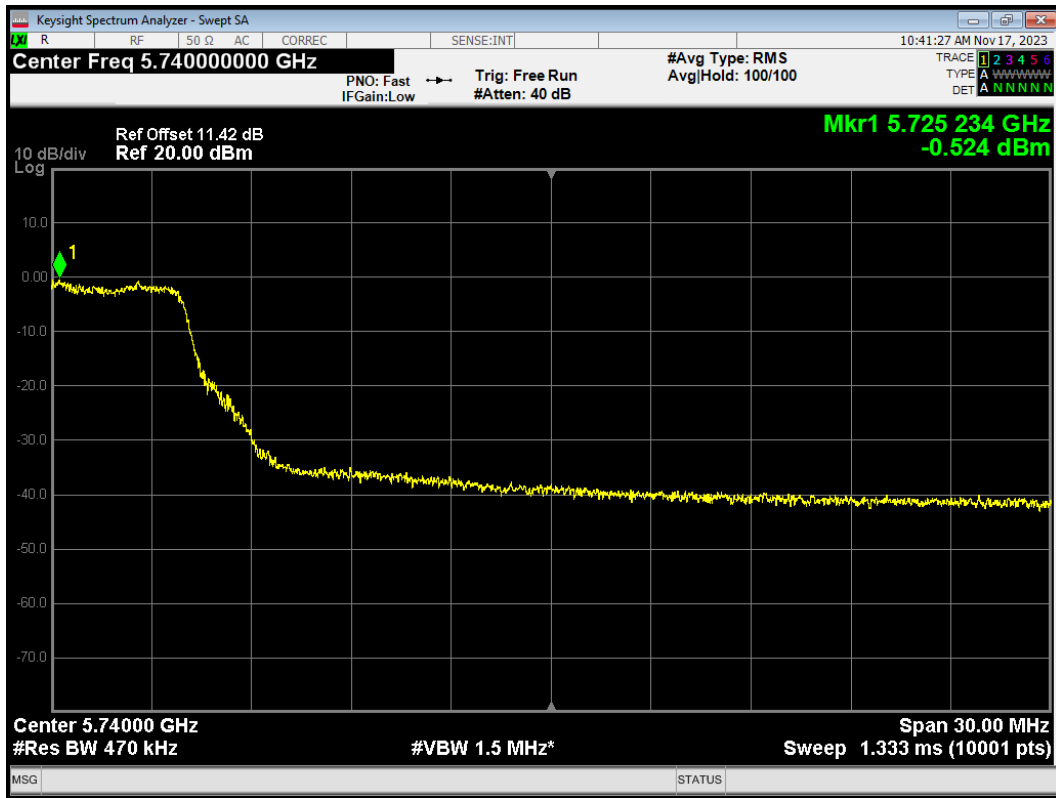

PSD 802.11ac(VHT20) 5720MHz Ant2

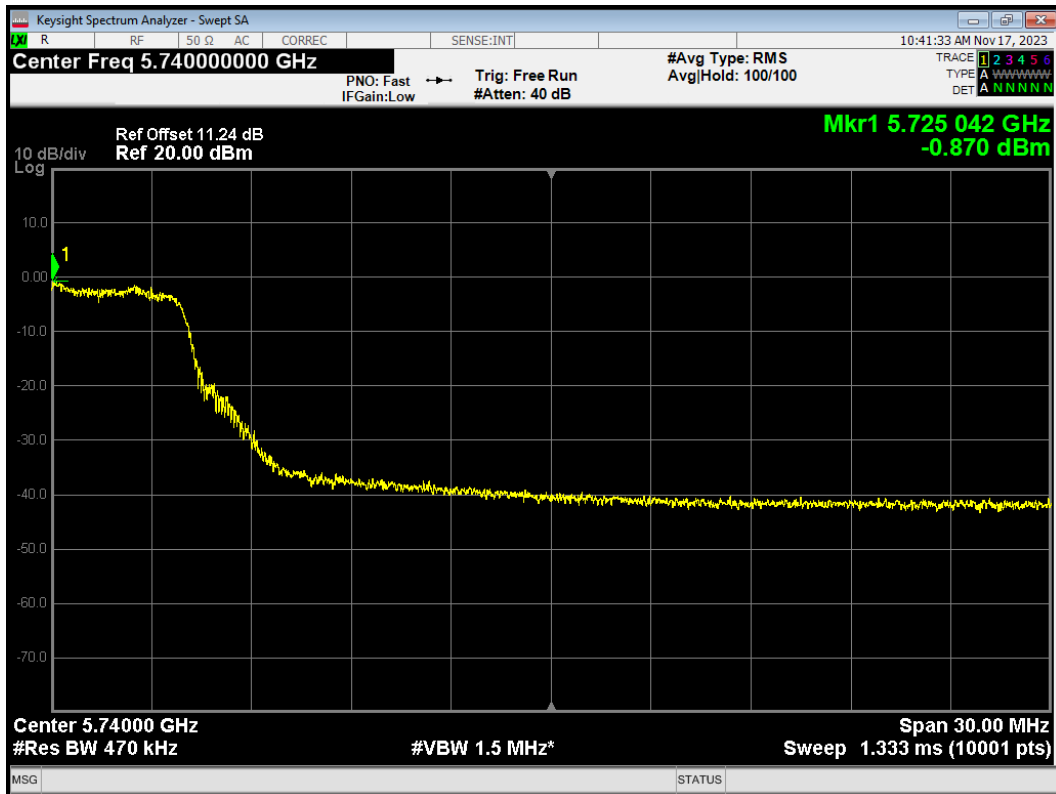

PSD 802.11ac(VHT20) 5745MHz Ant1

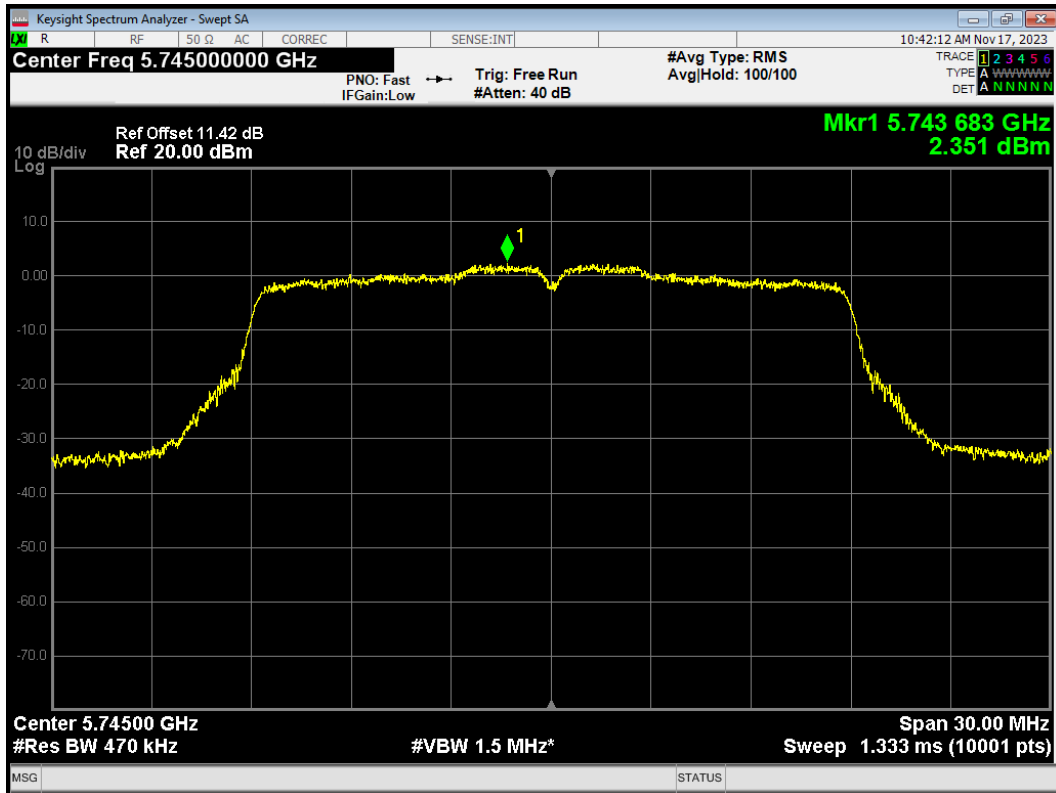

PSD 802.11ac(VHT20) 5745MHz Ant2

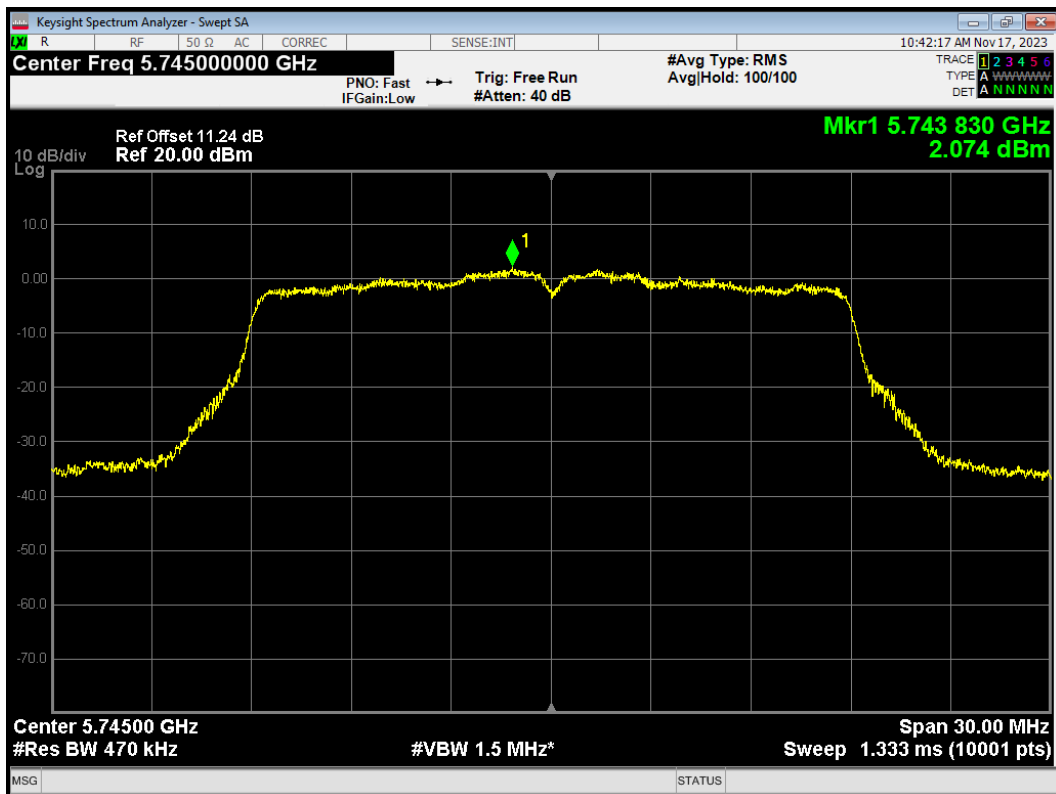

PSD 802.11ac(VHT20) 5785MHz Ant1

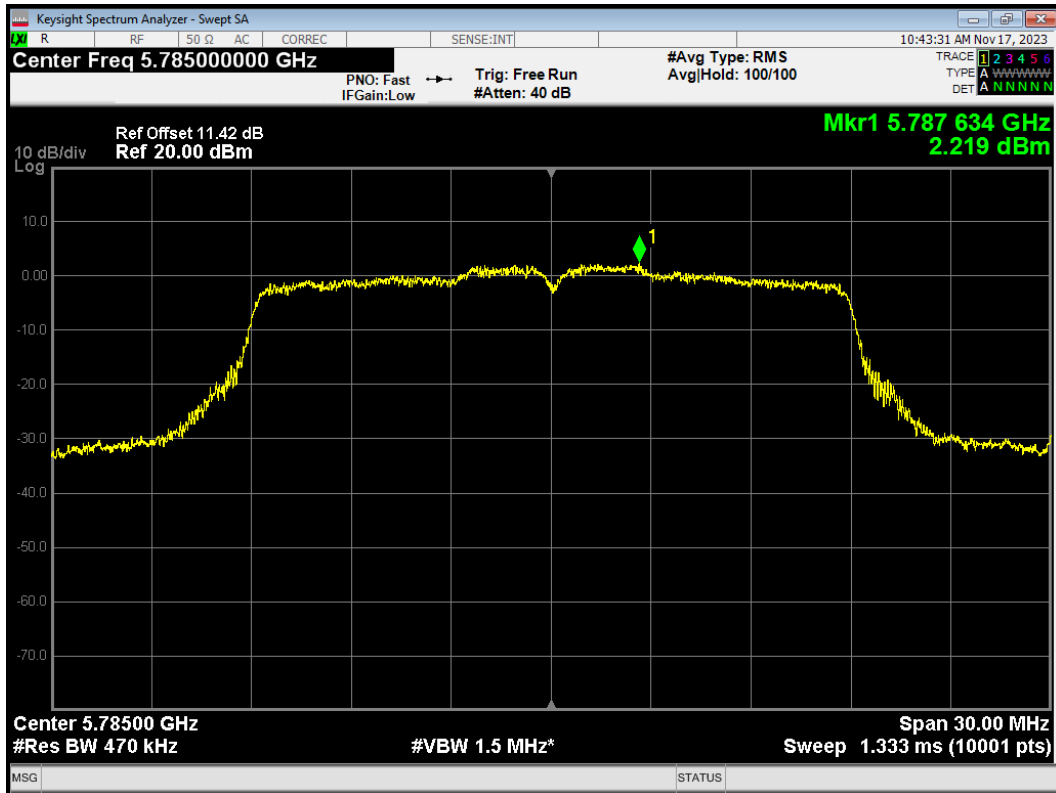

PSD 802.11ac(VHT20) 5785MHz Ant2

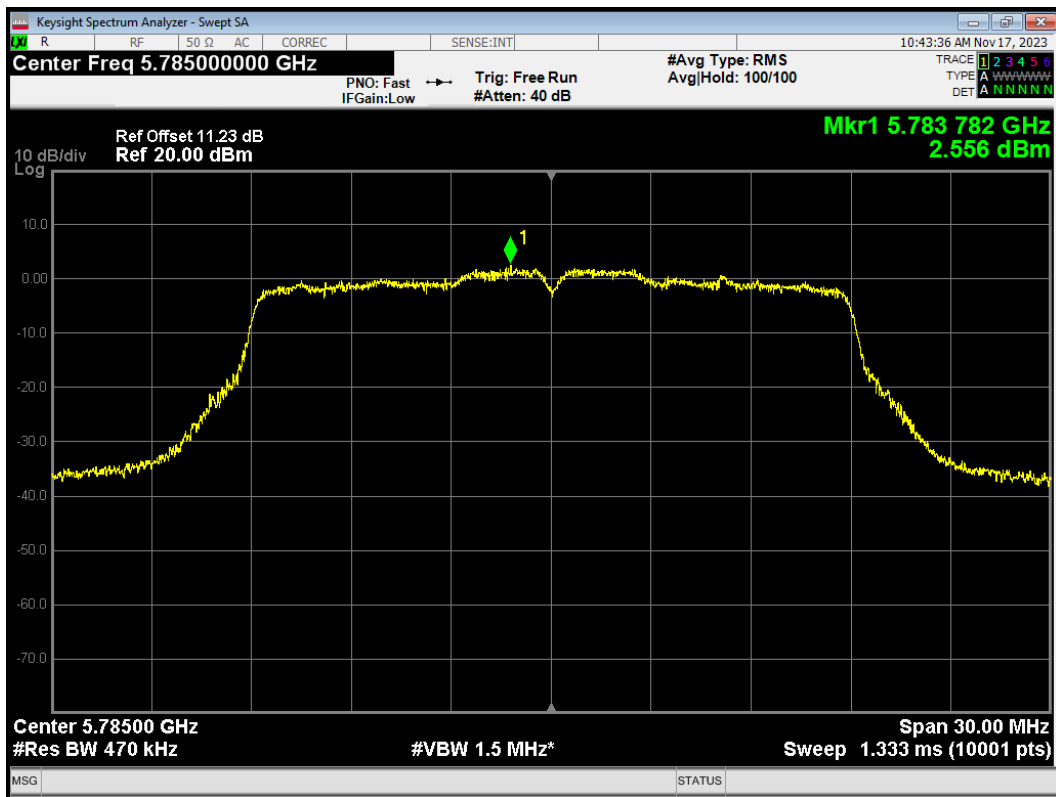

PSD 802.11ac(VHT20) 5825MHz Ant1

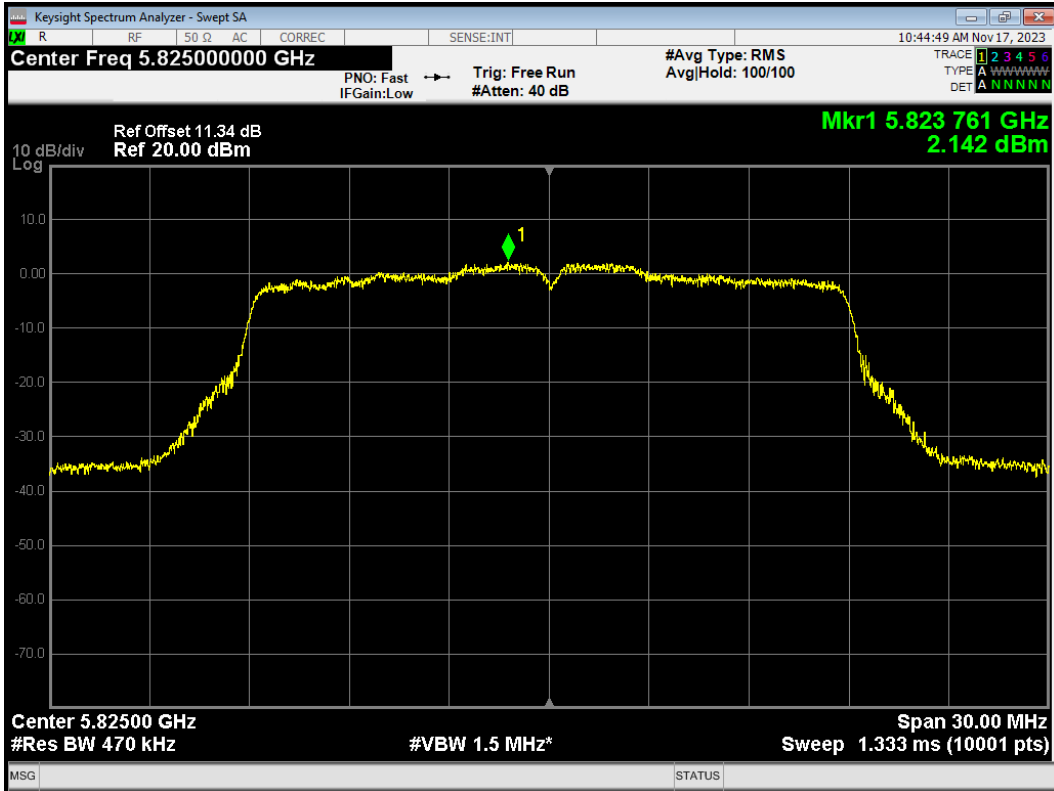

PSD 802.11ac(VHT20) 5825MHz Ant2

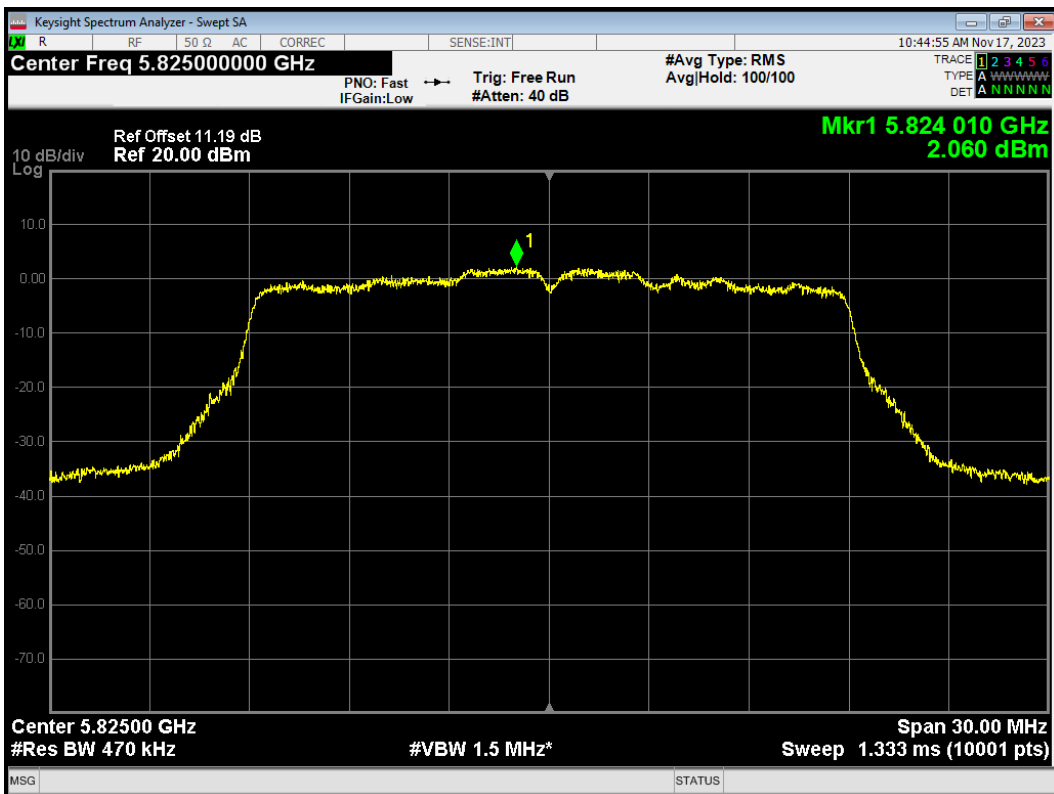

PSD 802.11ac(VHT40) 5710MHz Ant1

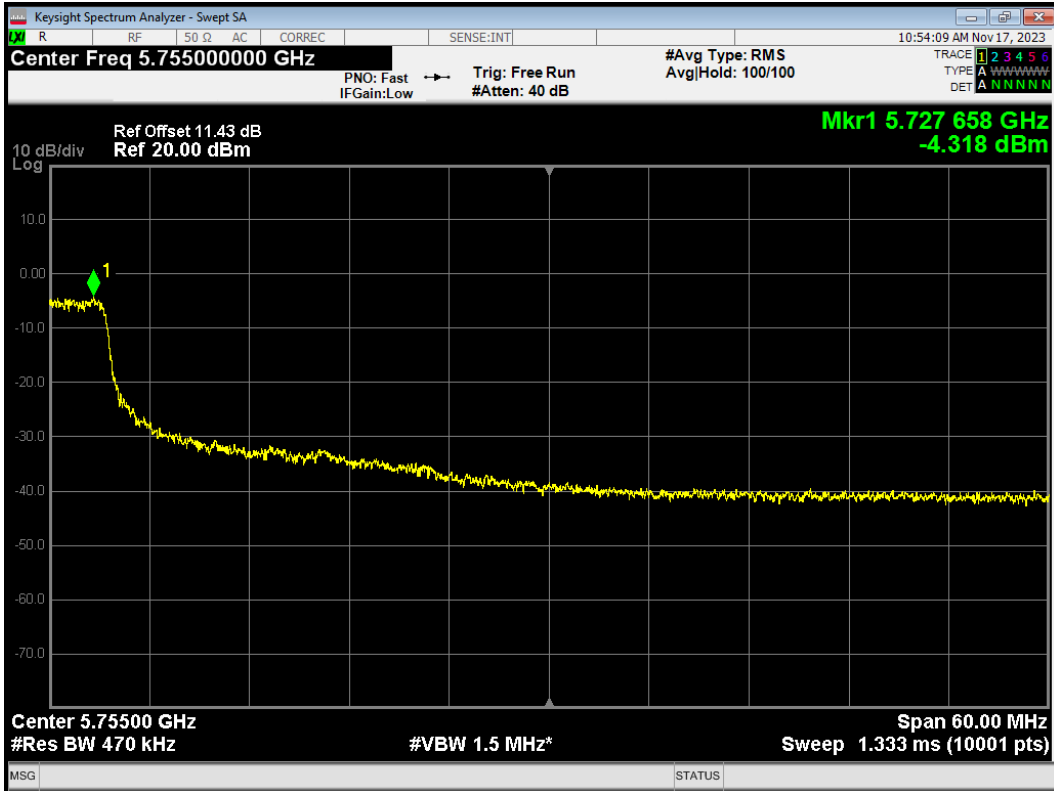

PSD 802.11ac(VHT40) 5710MHz Ant2

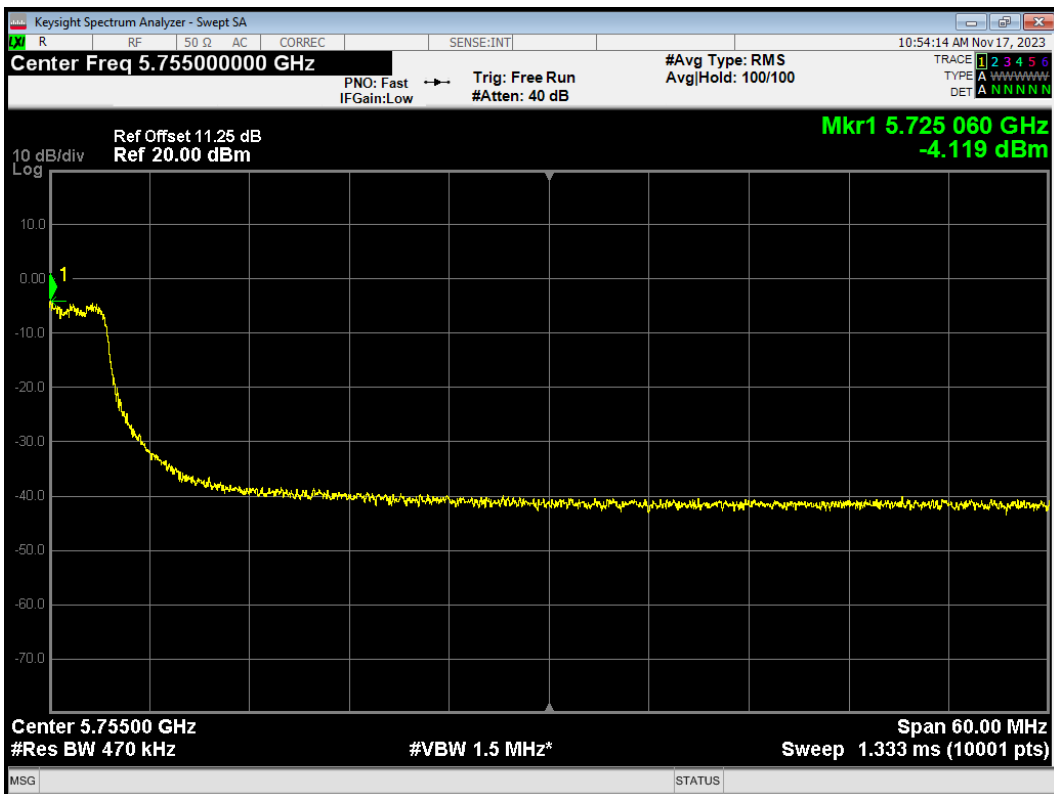

PSD 802.11ac(VHT40) 5755MHz Ant1

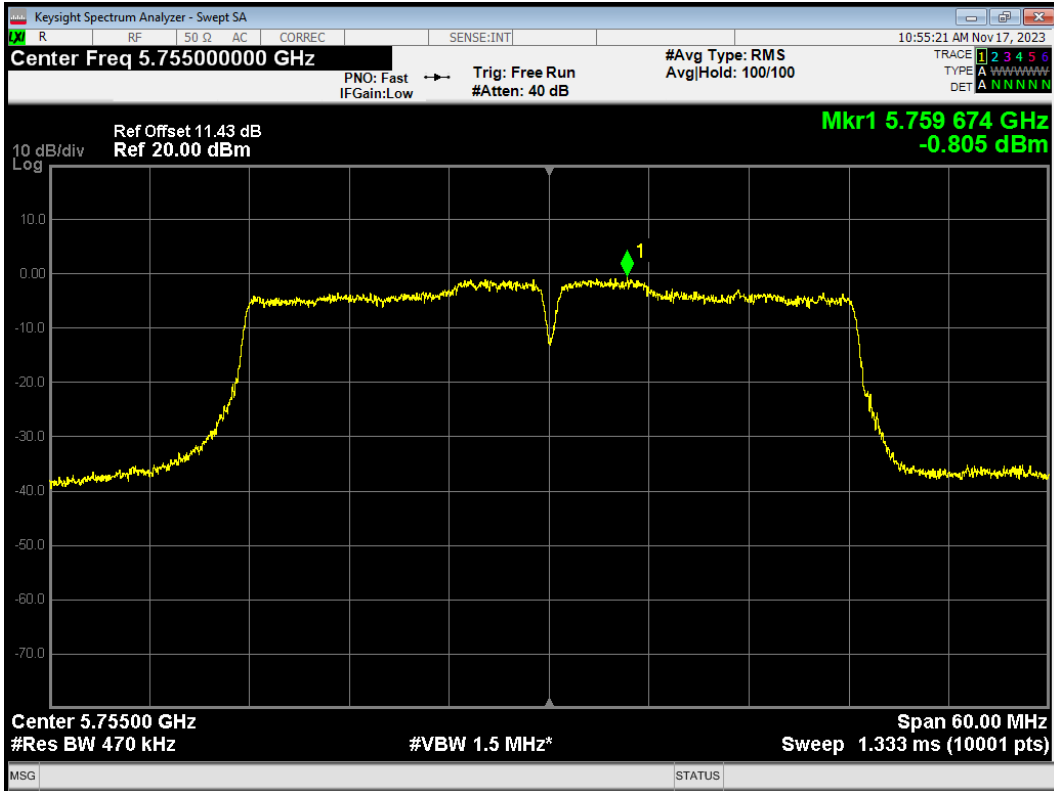

PSD 802.11ac(VHT40) 5755MHz Ant2

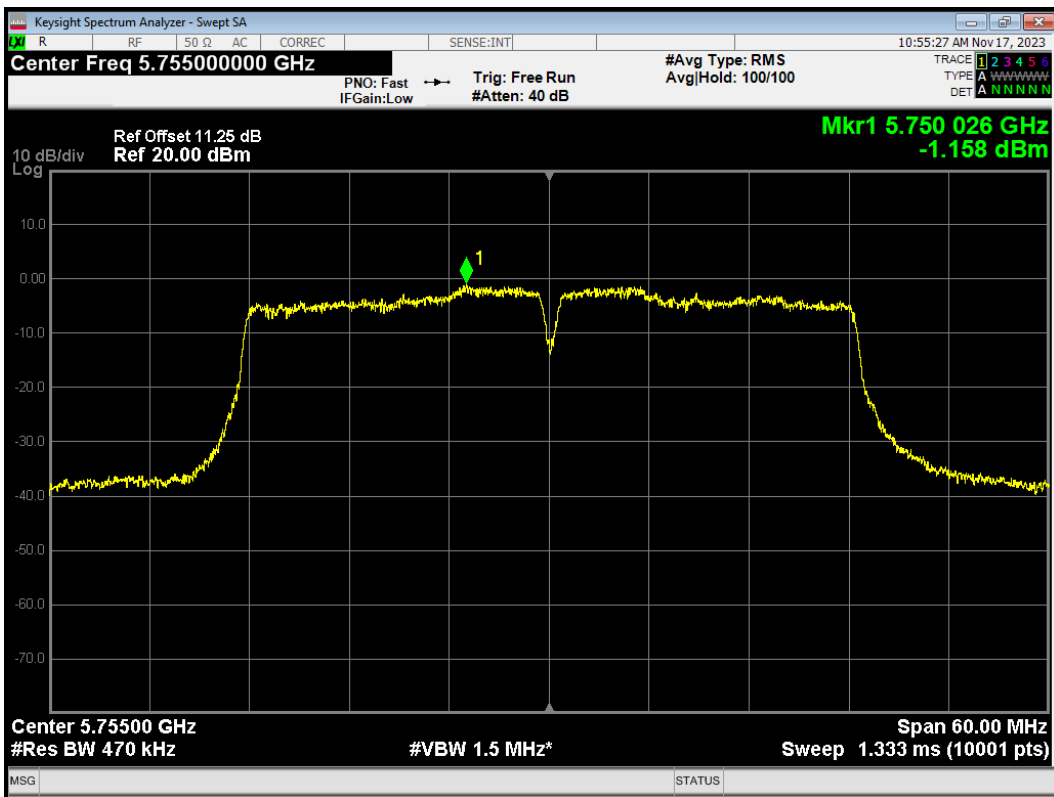

PSD 802.11ac(VHT40) 5795MHz Ant1

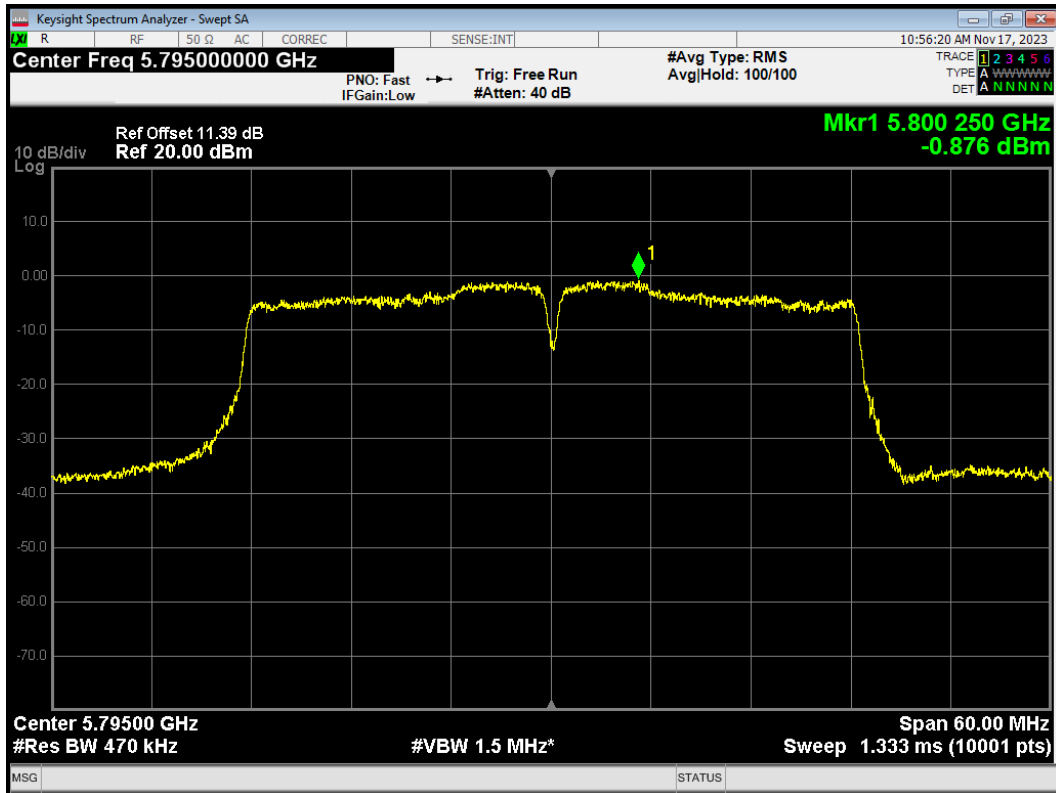

PSD 802.11ac(VHT40) 5795MHz Ant2

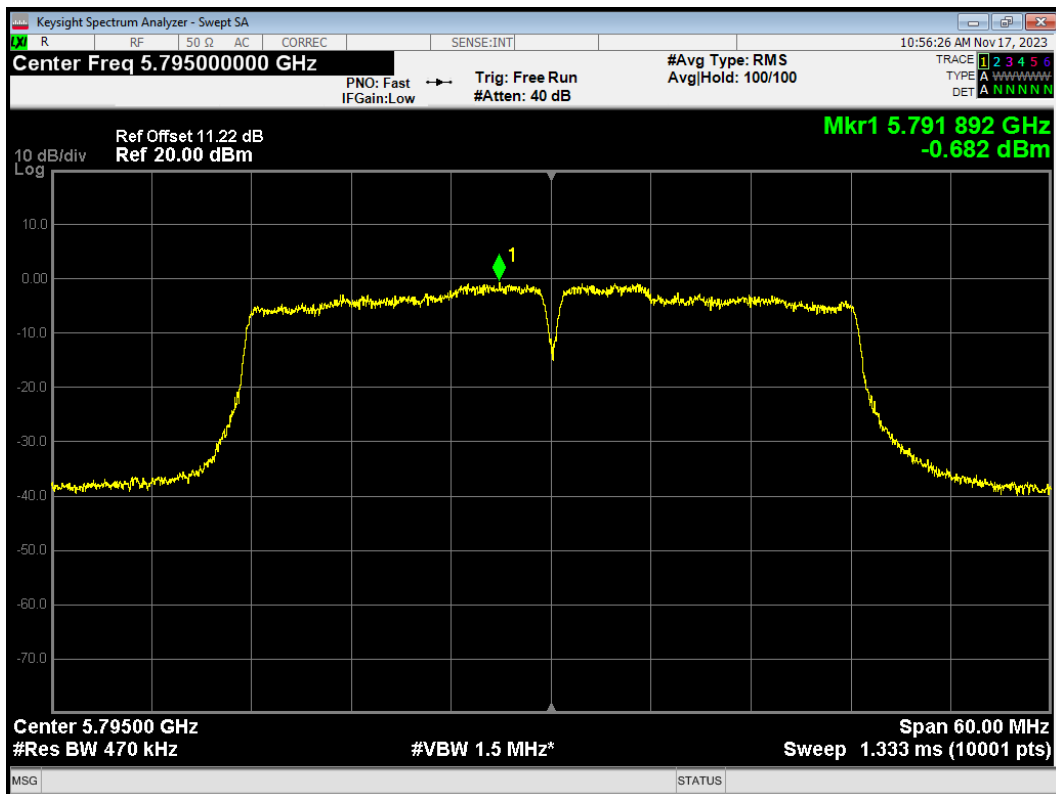

PSD 802.11ac(VHT80) 5690MHz Ant1

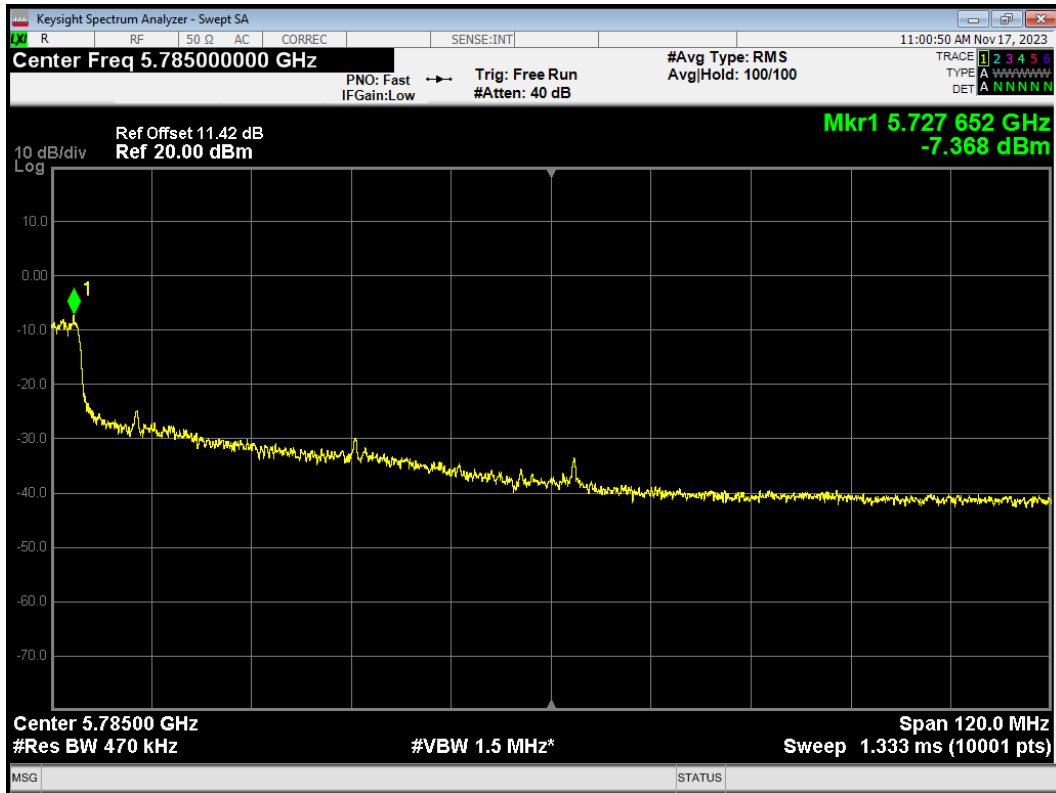

PSD 802.11ac(VHT80) 5690MHz Ant2

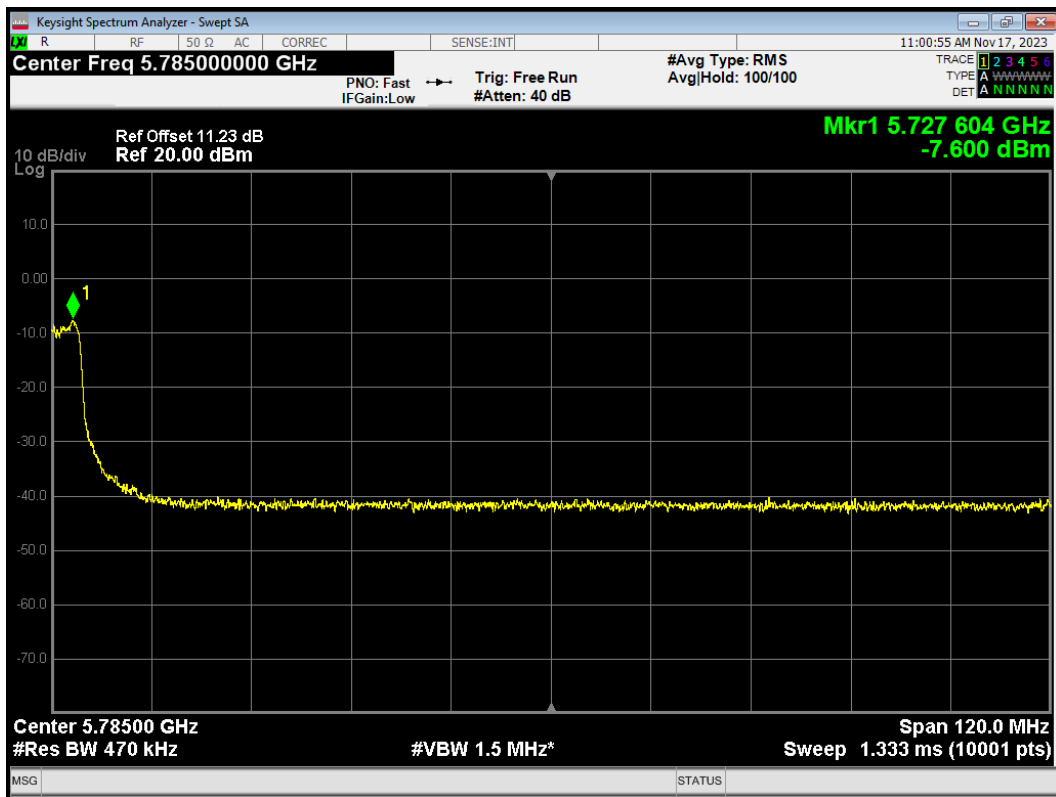

PSD 802.11ac(VHT80) 5775MHz Ant1

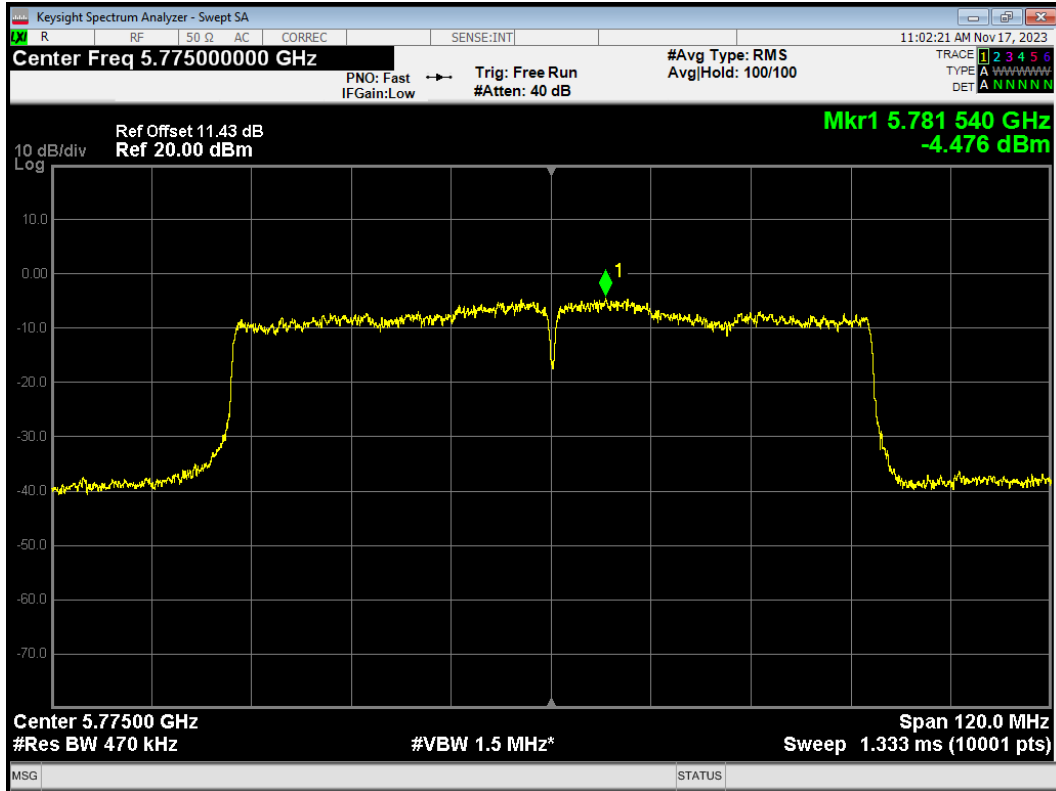

PSD 802.11ac(VHT80) 5775MHz Ant2

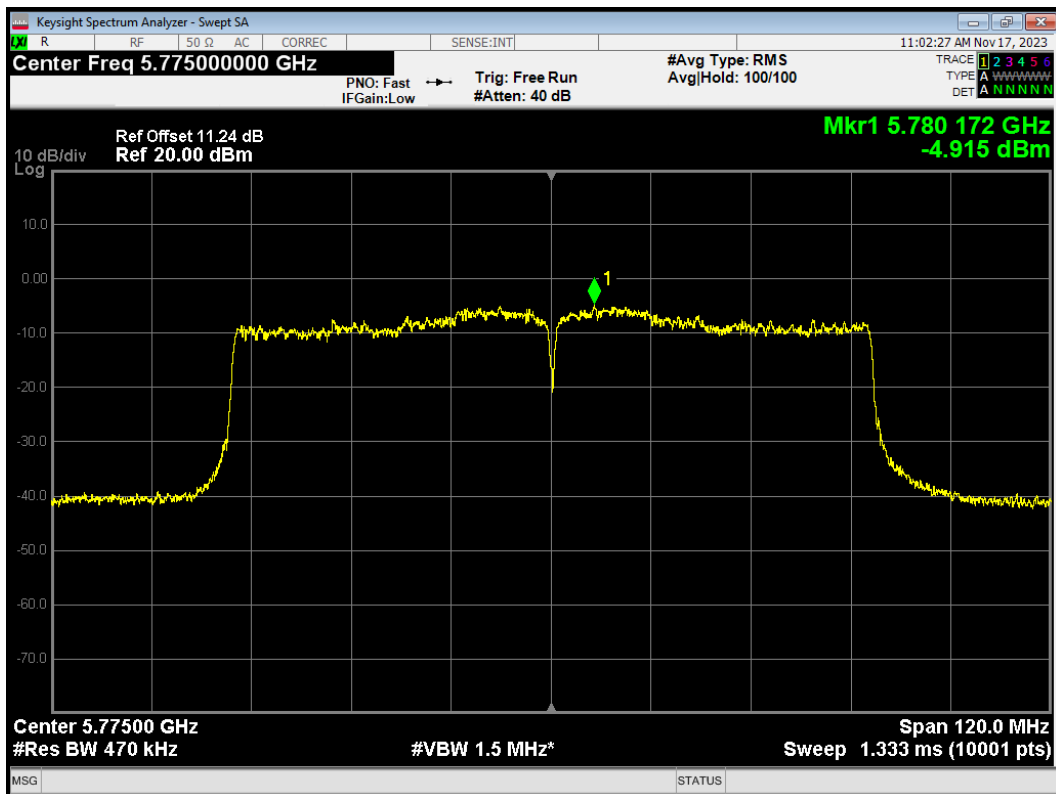

PSD 802.11ax(HE20) 5720MHz Ant1

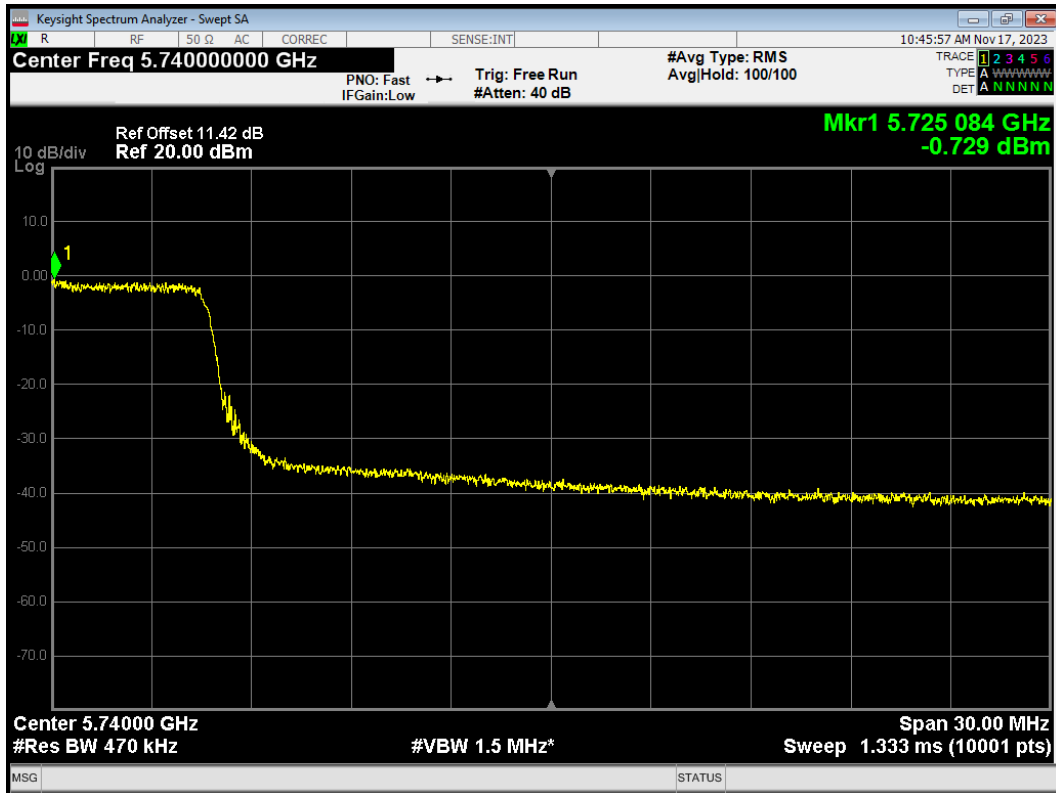

PSD 802.11ax(HE20) 5720MHz Ant2

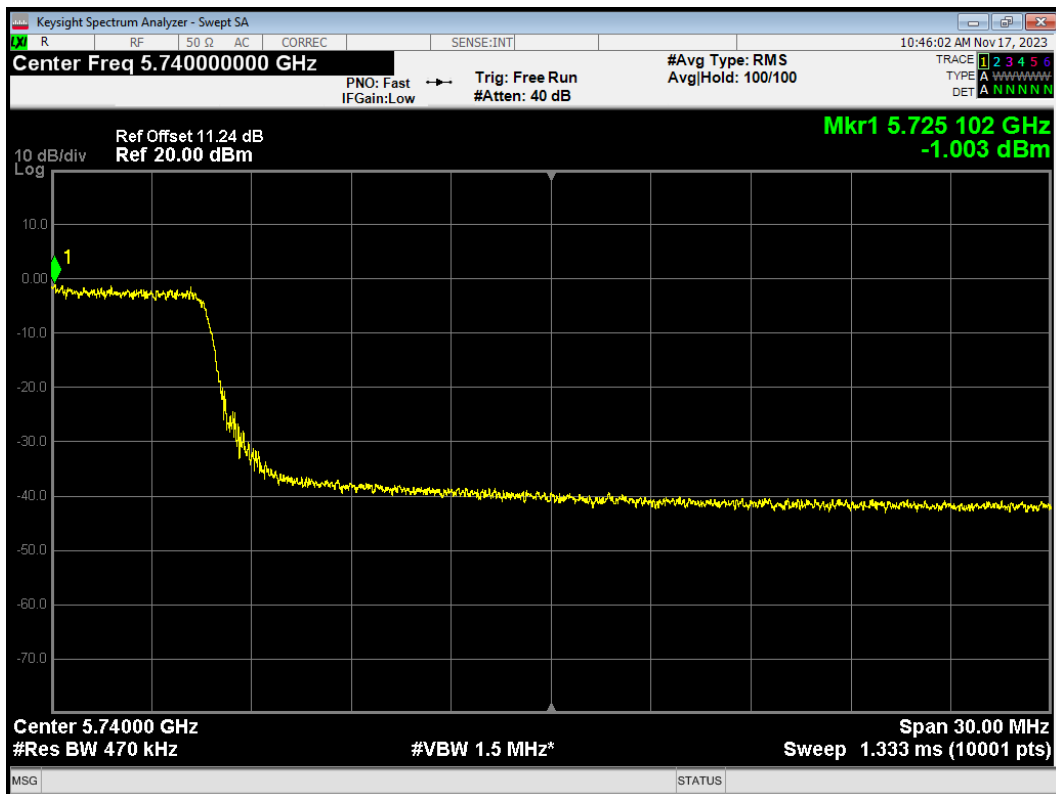

PSD 802.11ax(HE20) 5745MHz Ant1

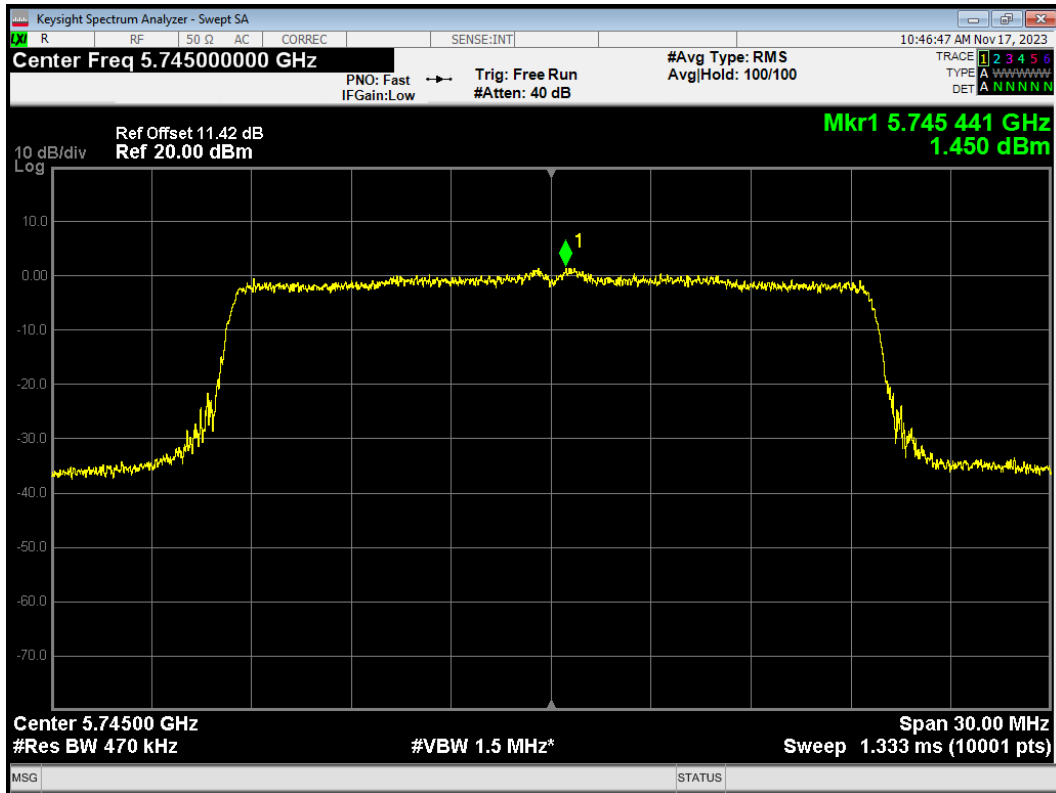

PSD 802.11ax(HE20) 5745MHz Ant2

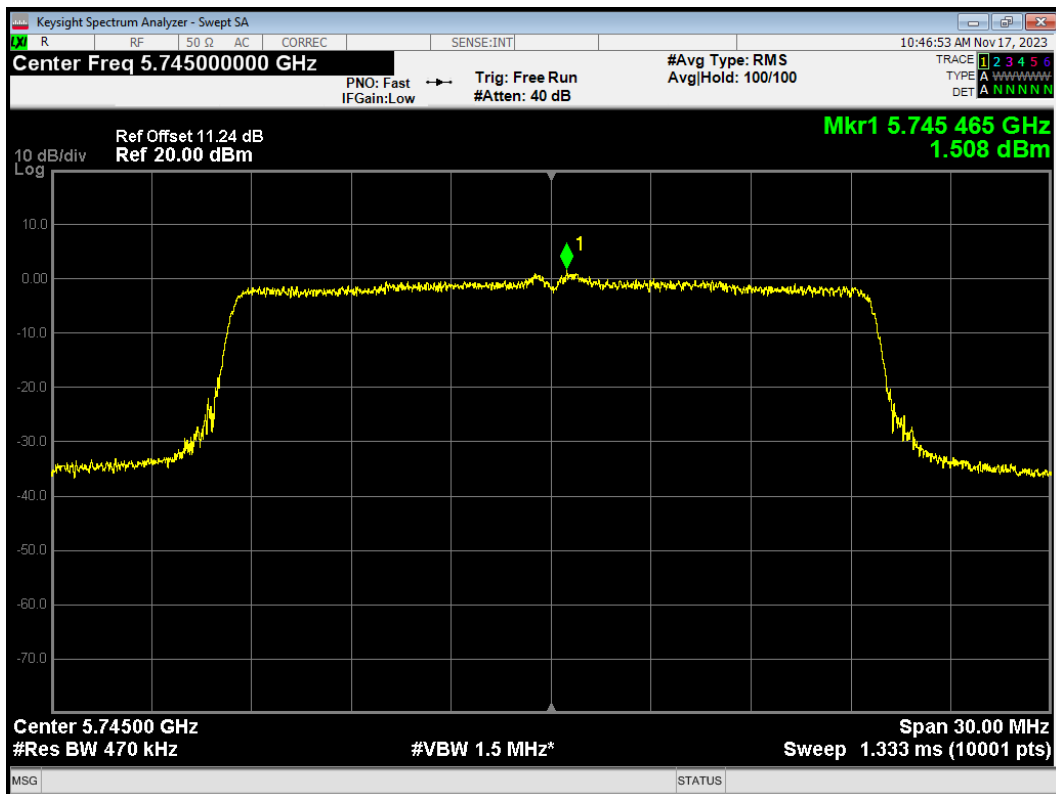

PSD 802.11ax(HE20) 5785MHz Ant1

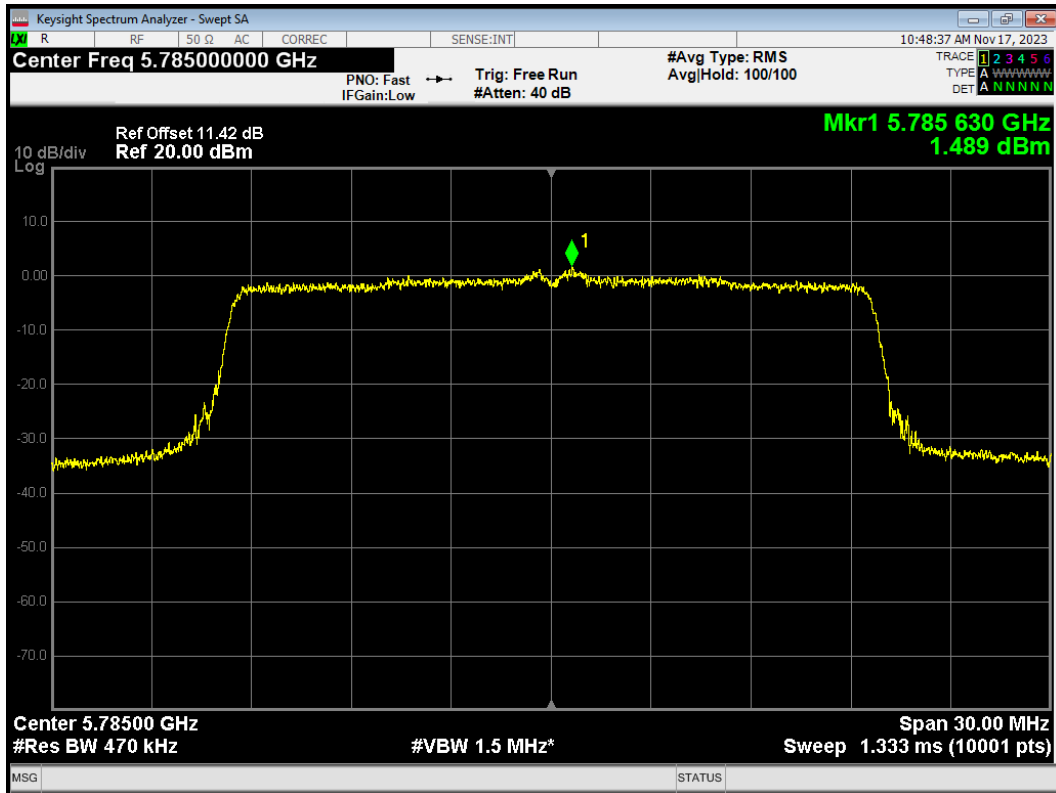

PSD 802.11ax(HE20) 5785MHz Ant2

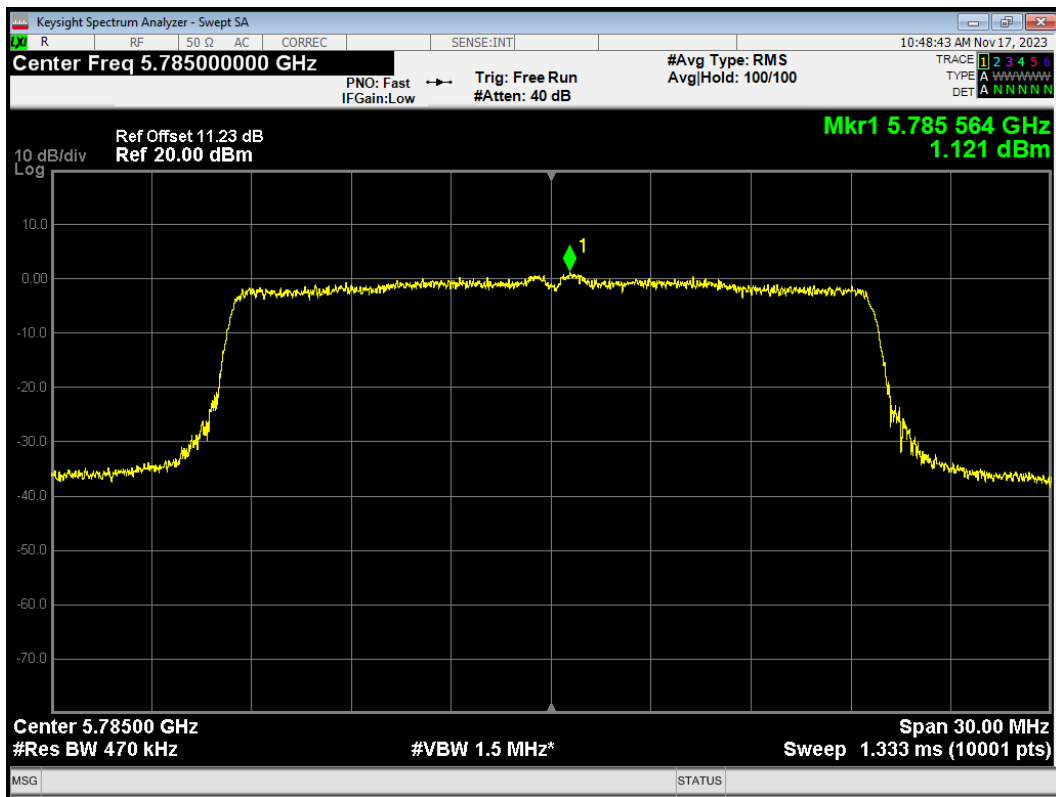

PSD 802.11ax(HE20) 5825MHz Ant1

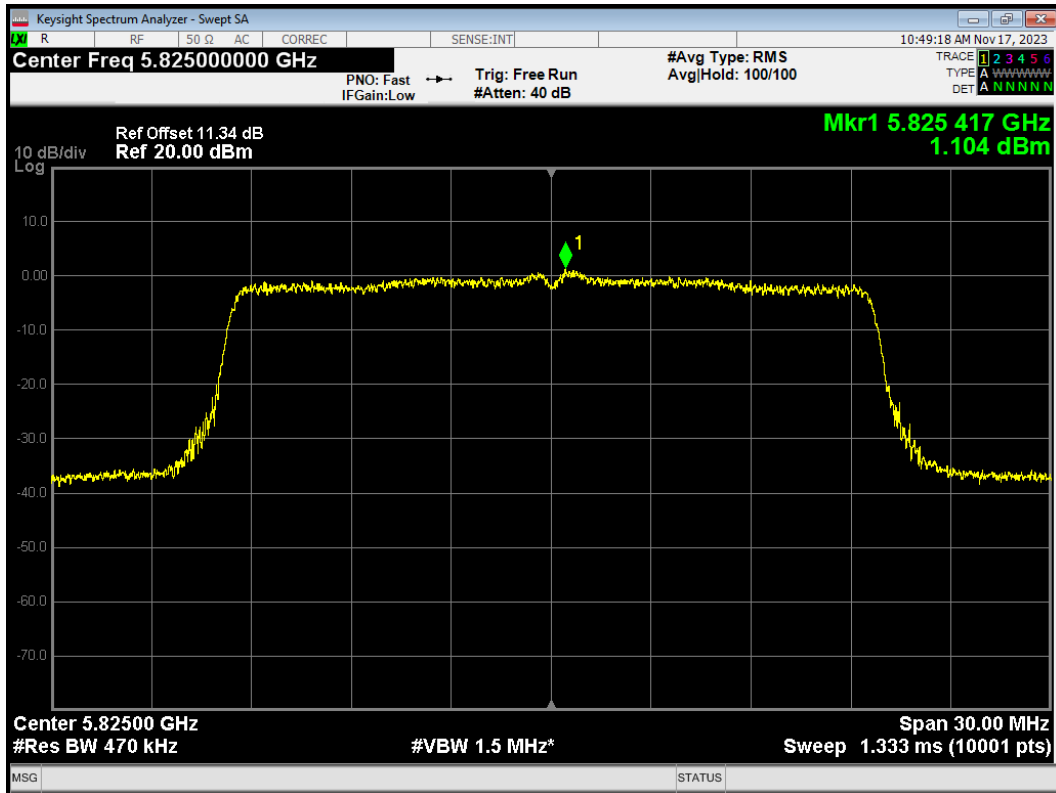

PSD 802.11ax(HE20) 5825MHz Ant2

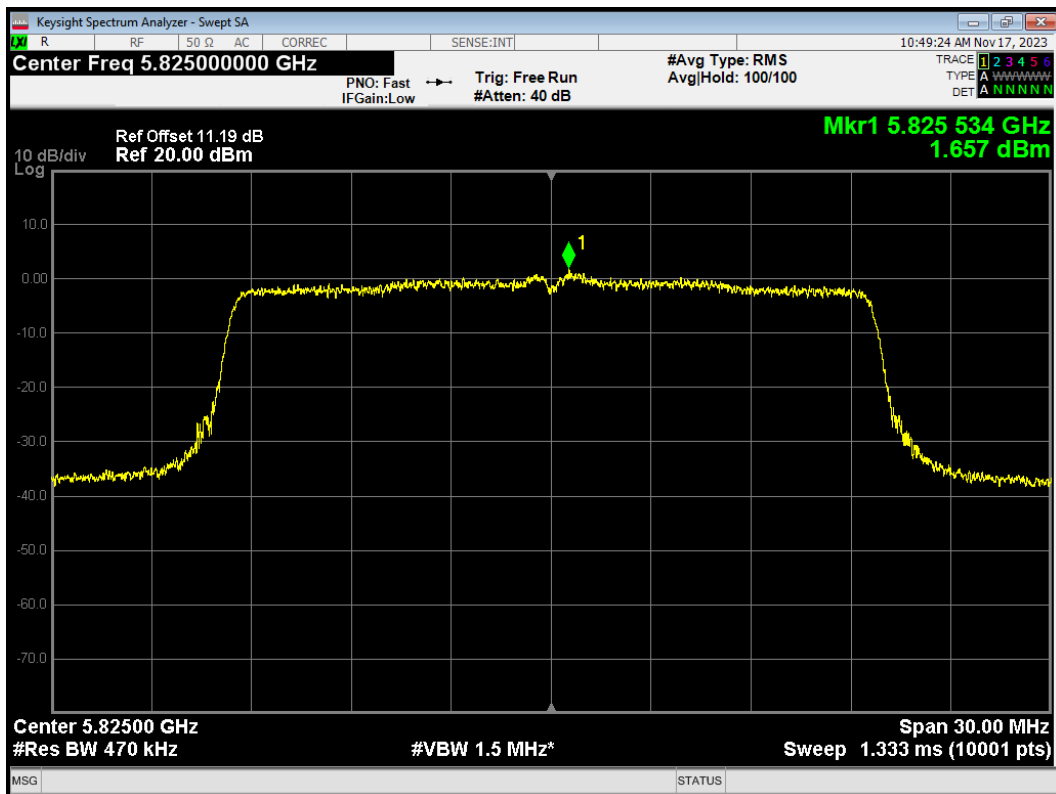

PSD 802.11ax(HE40) 5710MHz Ant1

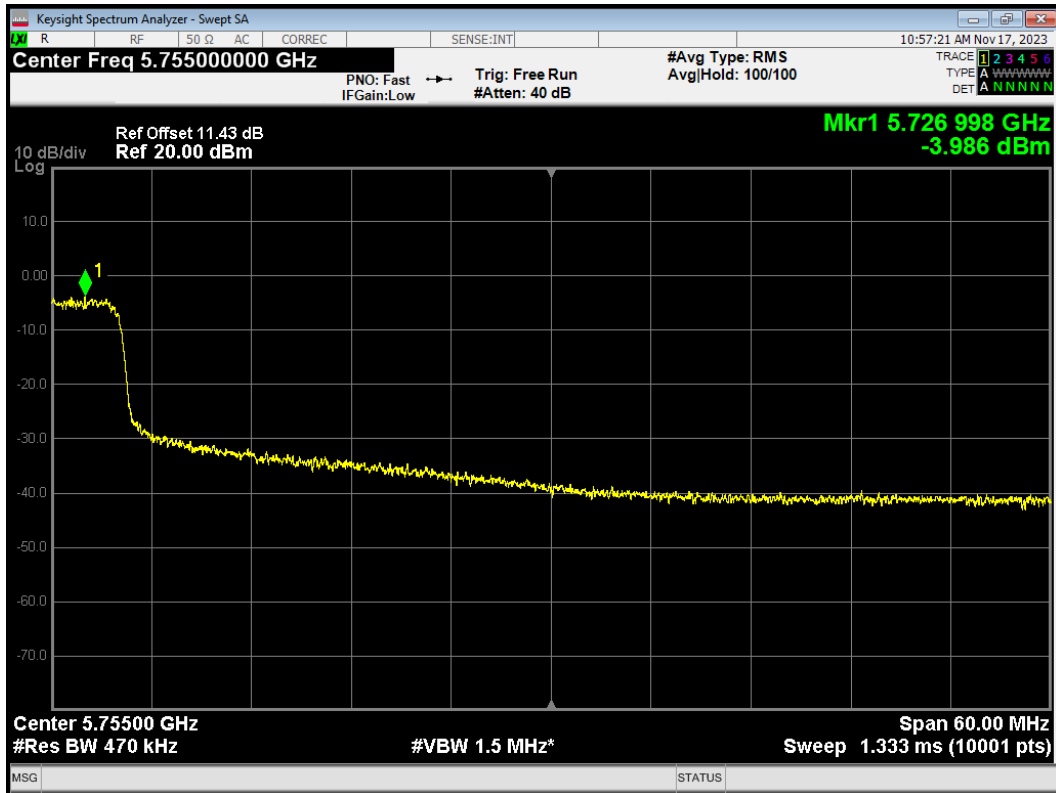

PSD 802.11ax(HE40) 5710MHz Ant2

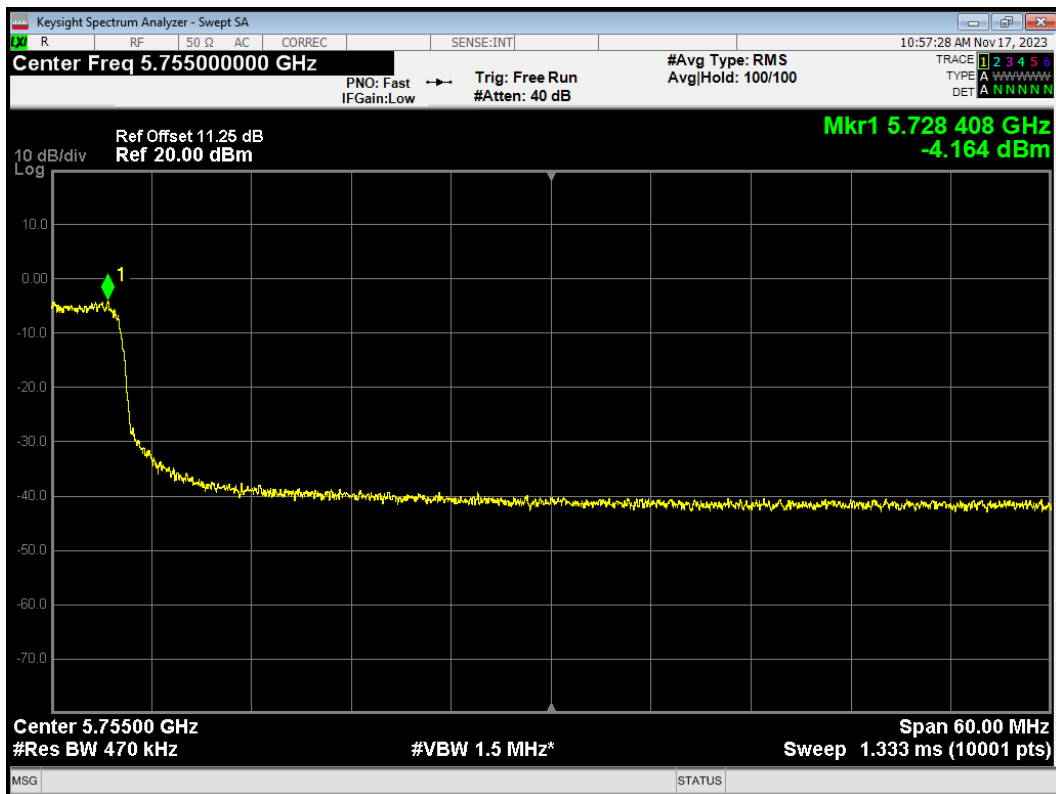

PSD 802.11ax(HE40) 5755MHz Ant1

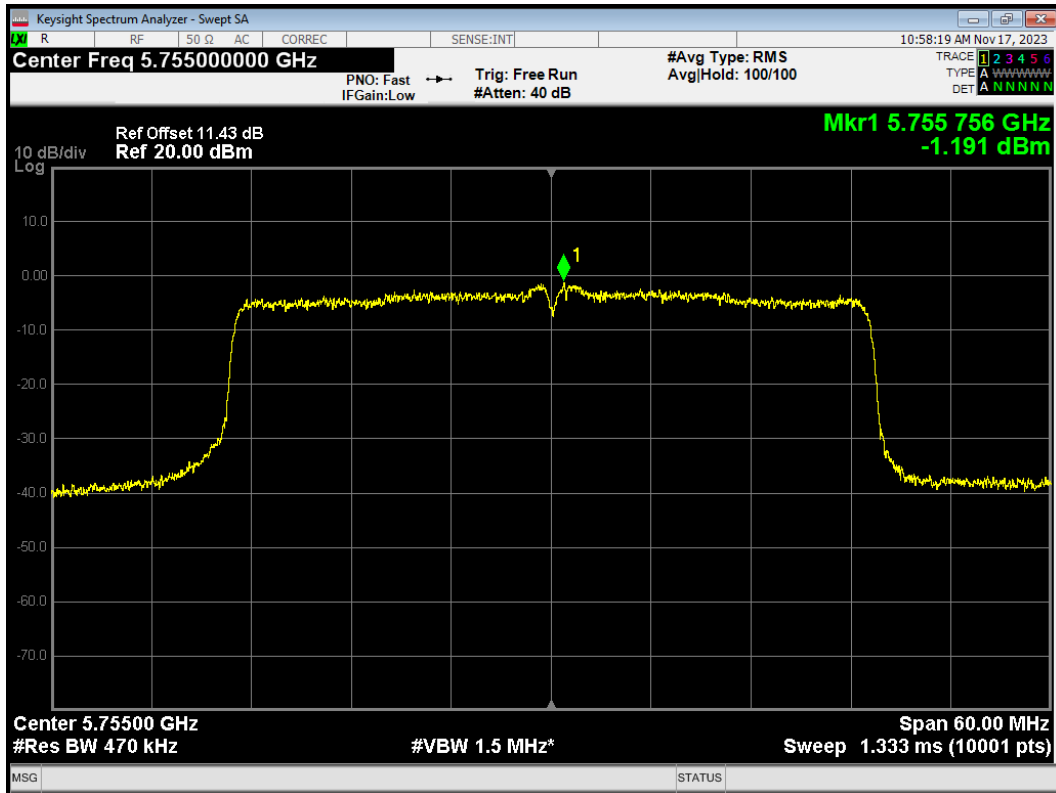

PSD 802.11ax(HE40) 5755MHz Ant2

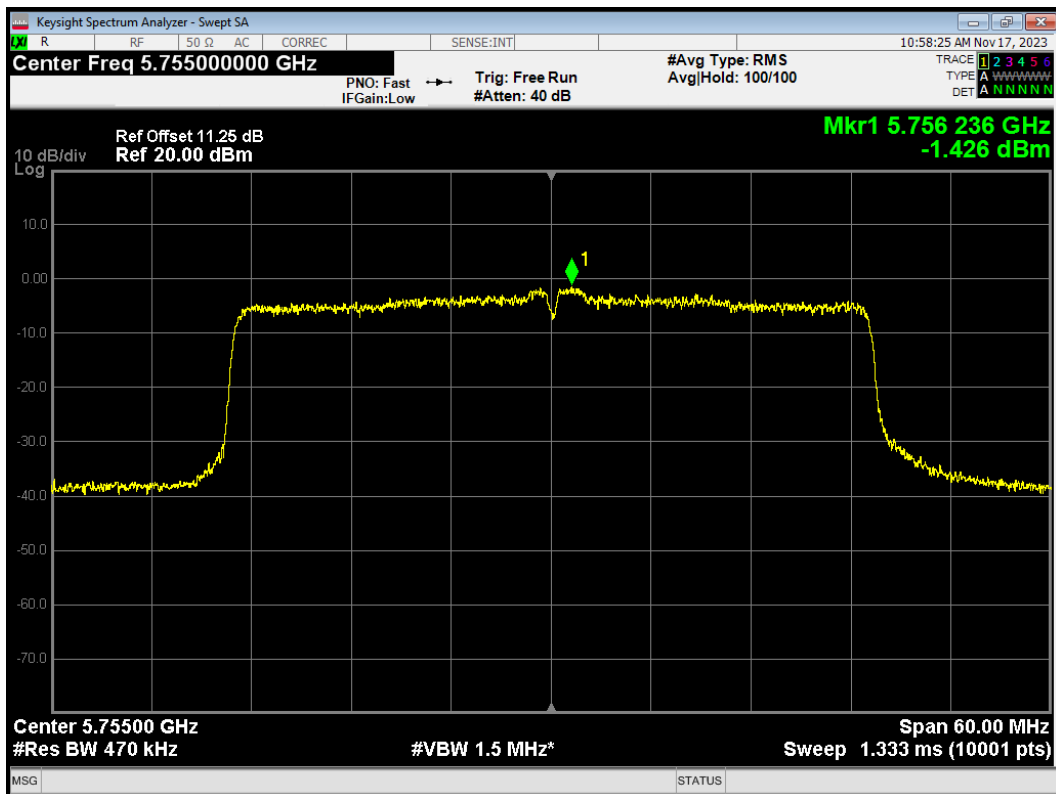

PSD 802.11ax(HE40) 5795MHz Ant1

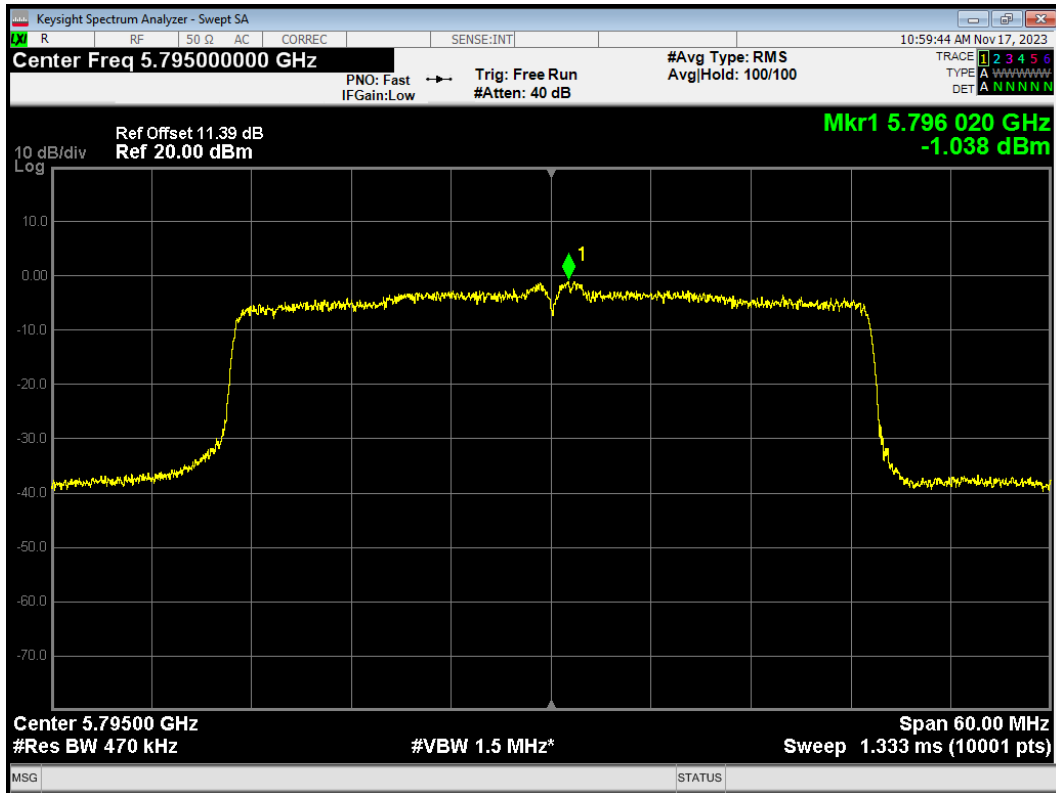

PSD 802.11ax(HE40) 5795MHz Ant2

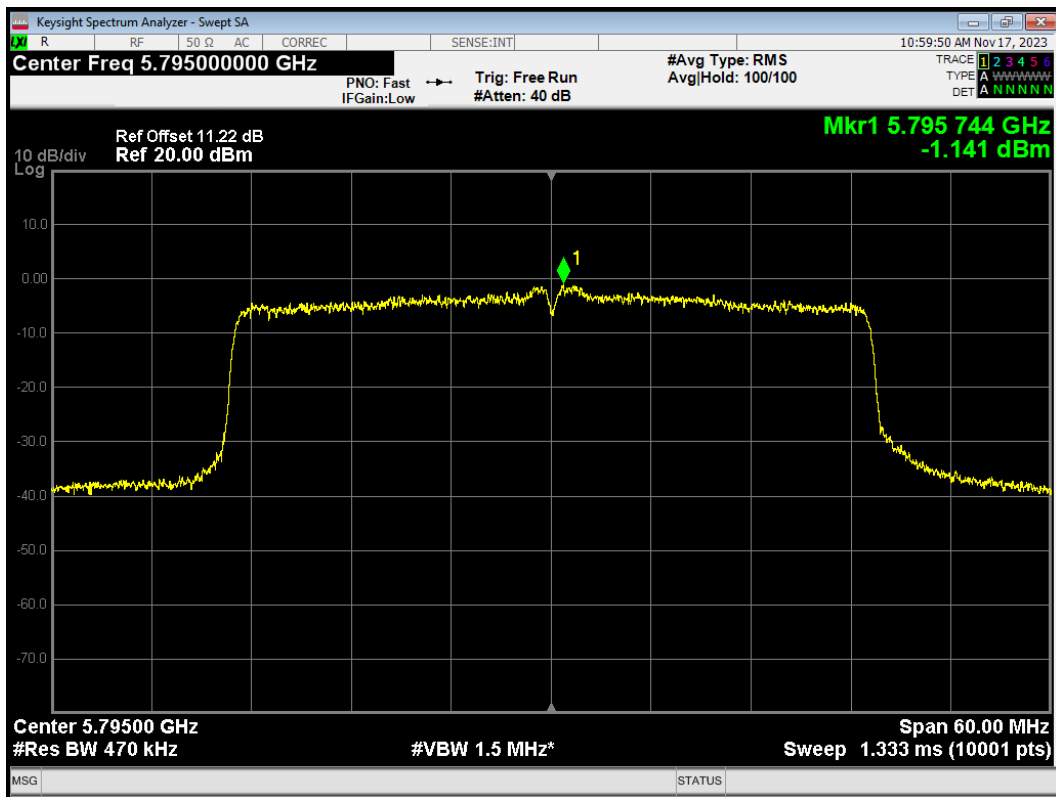

PSD 802.11ax(HE80) 5690MHz Ant1

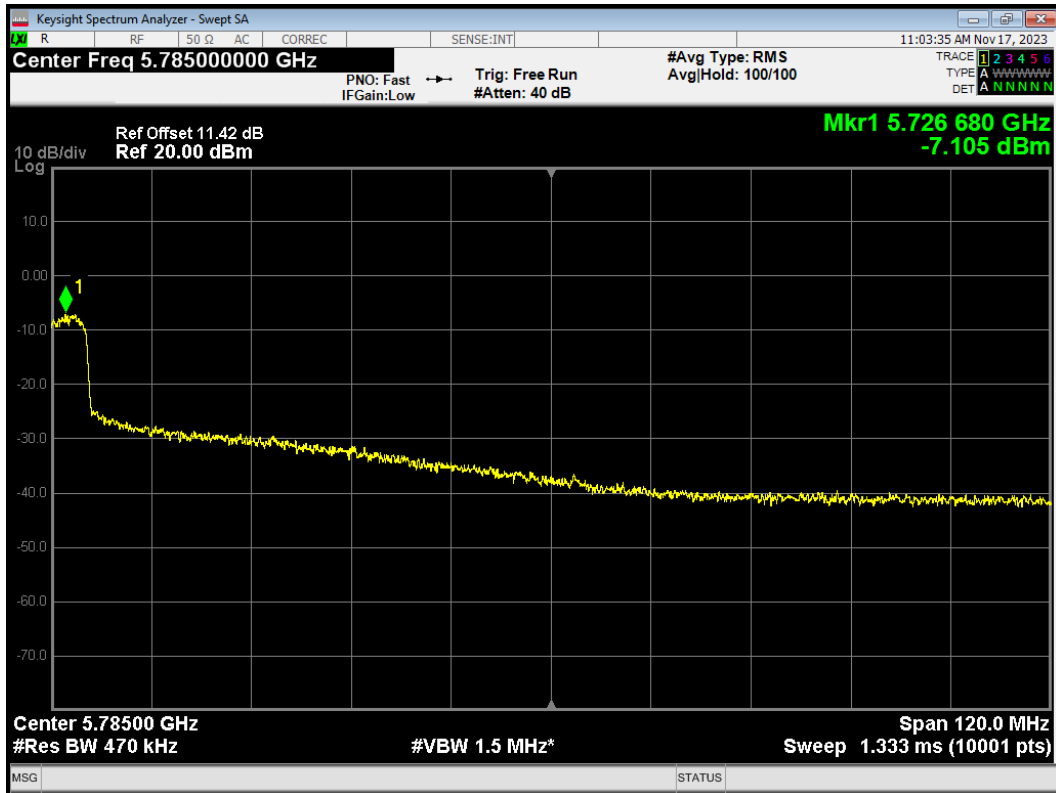

PSD 802.11ax(HE80) 5690MHz Ant2

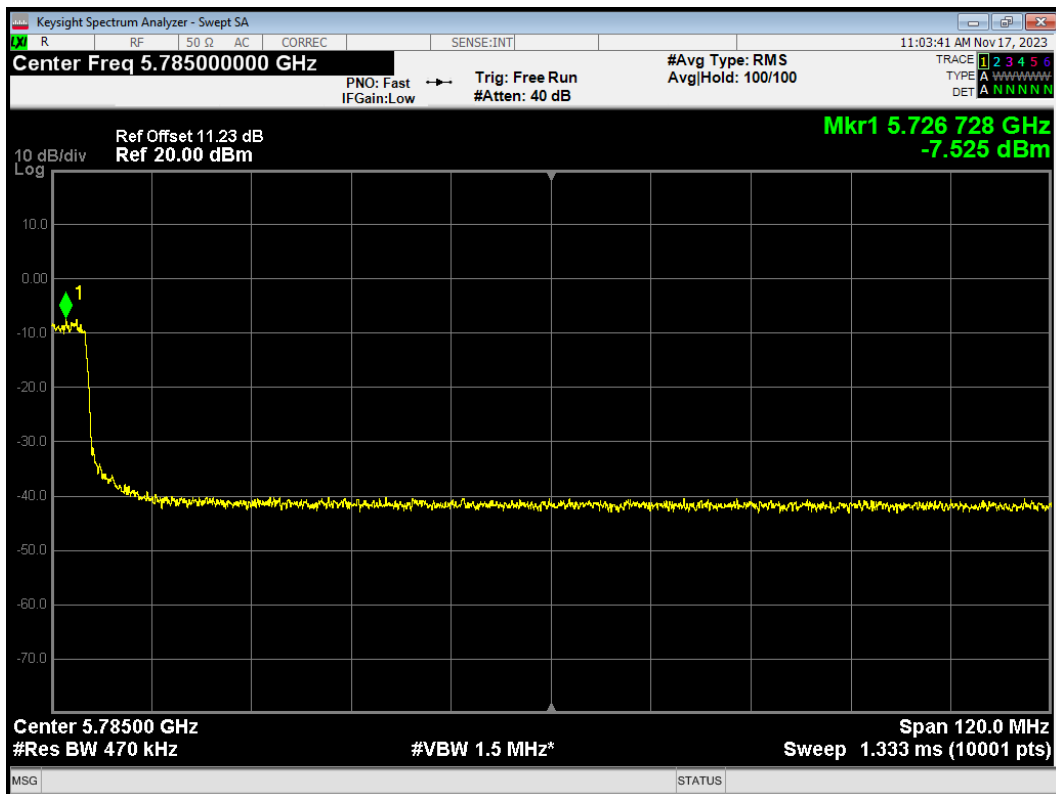

PSD 802.11ax(HE80) 5775MHz Ant1

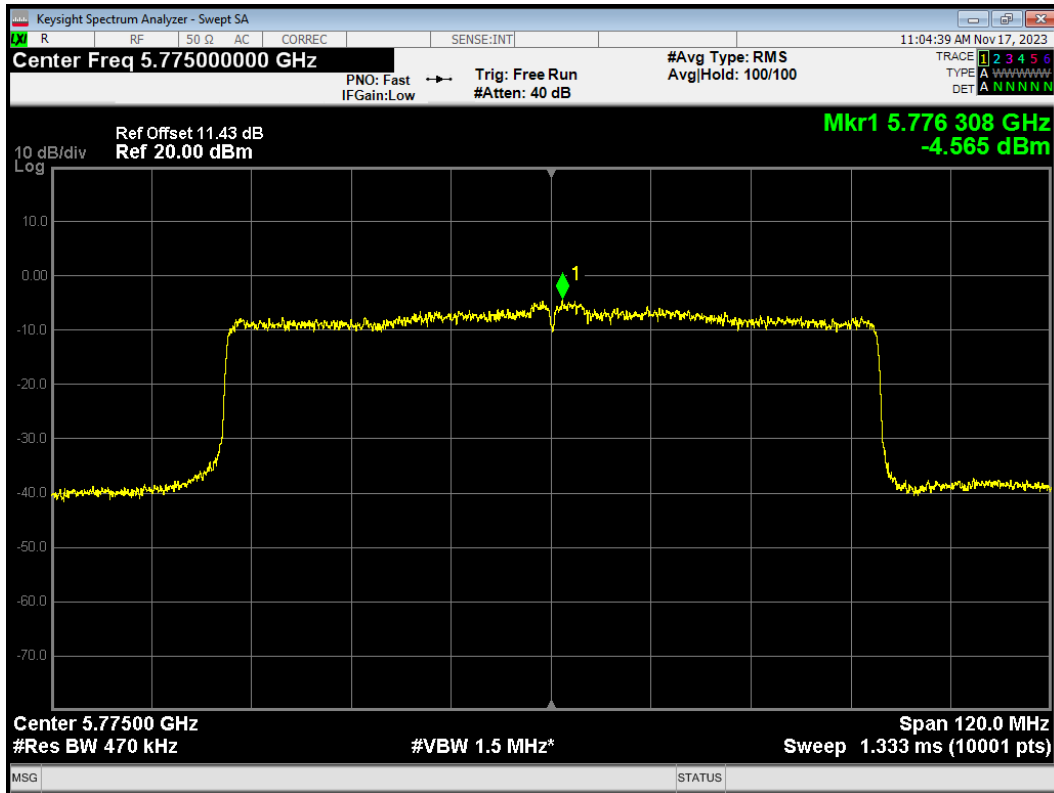

PSD 802.11ax(HE80) 5775MHz Ant2

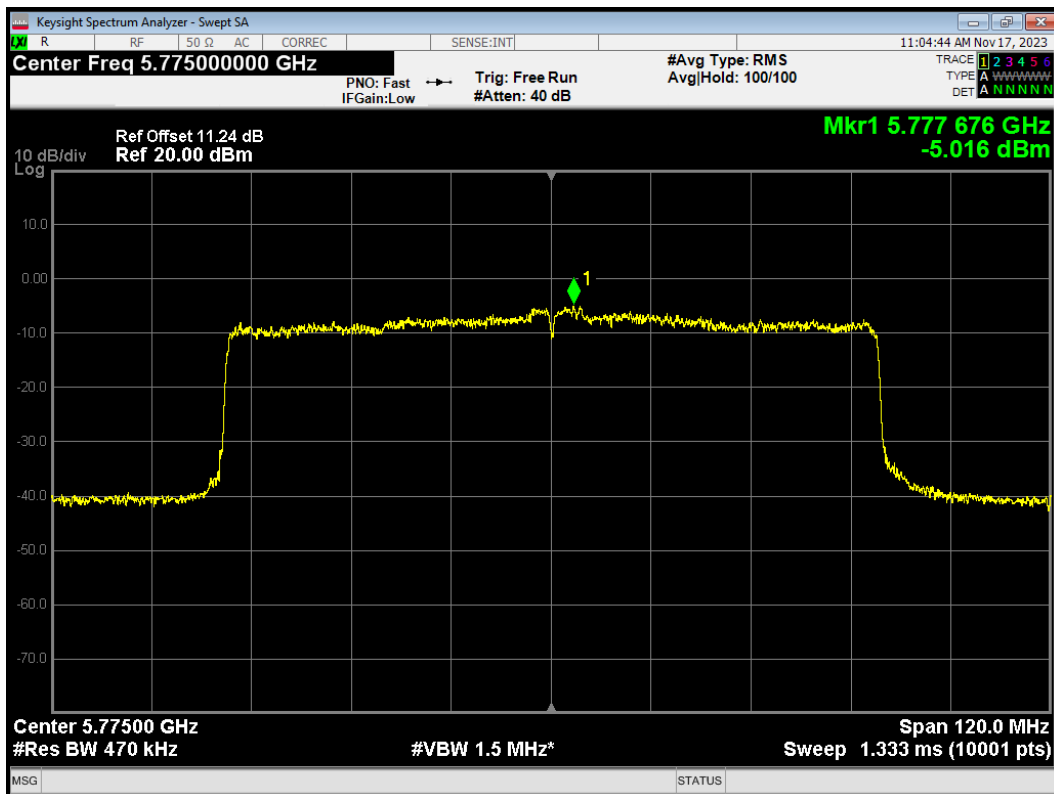

PSD 802.11n(HT20) 5720MHz Ant1

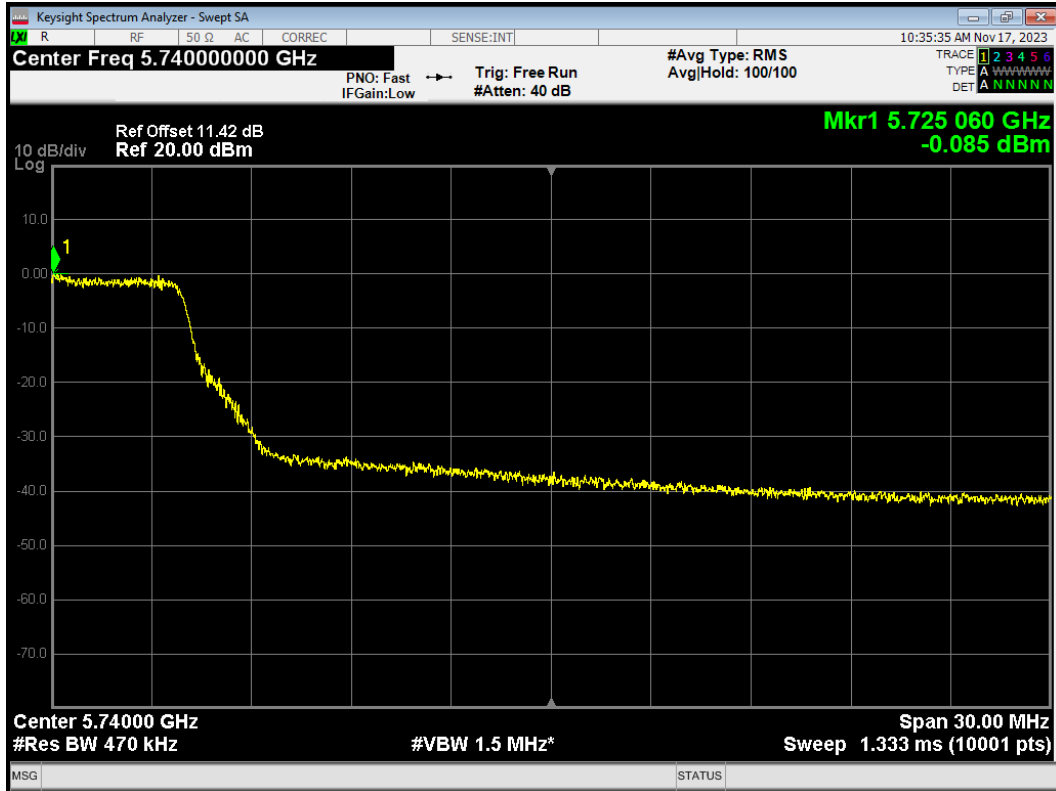

PSD 802.11n(HT20) 5720MHz Ant2

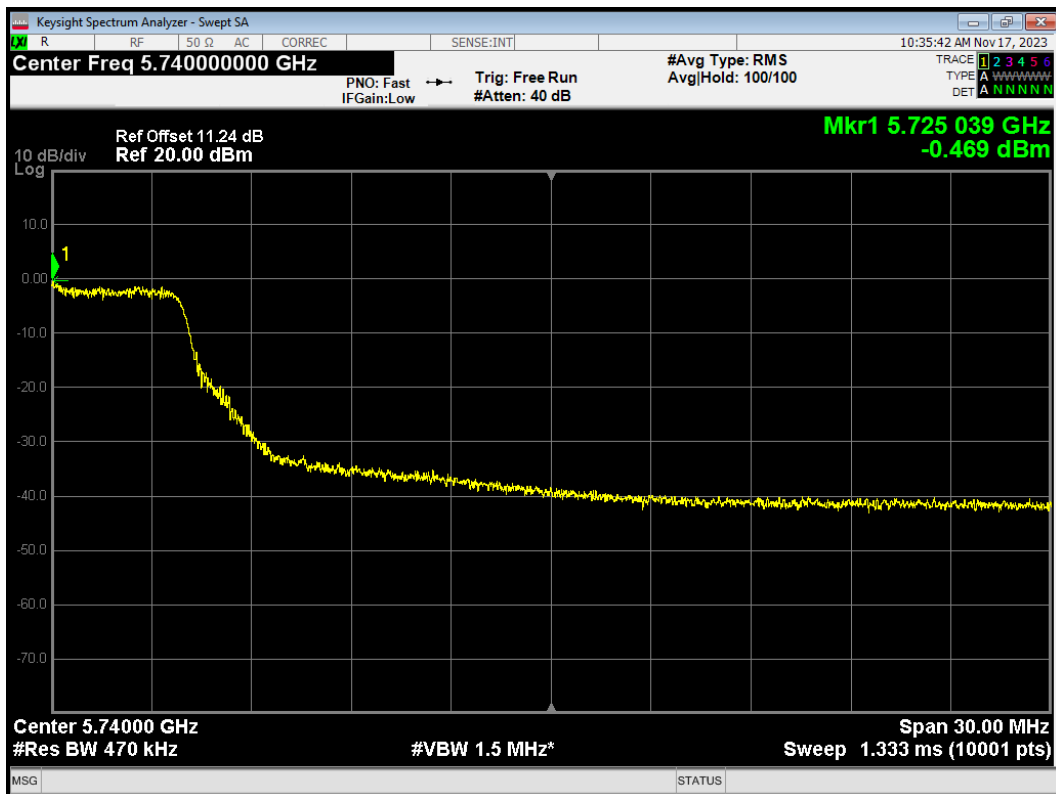

PSD 802.11n(HT20) 5745MHz Ant1

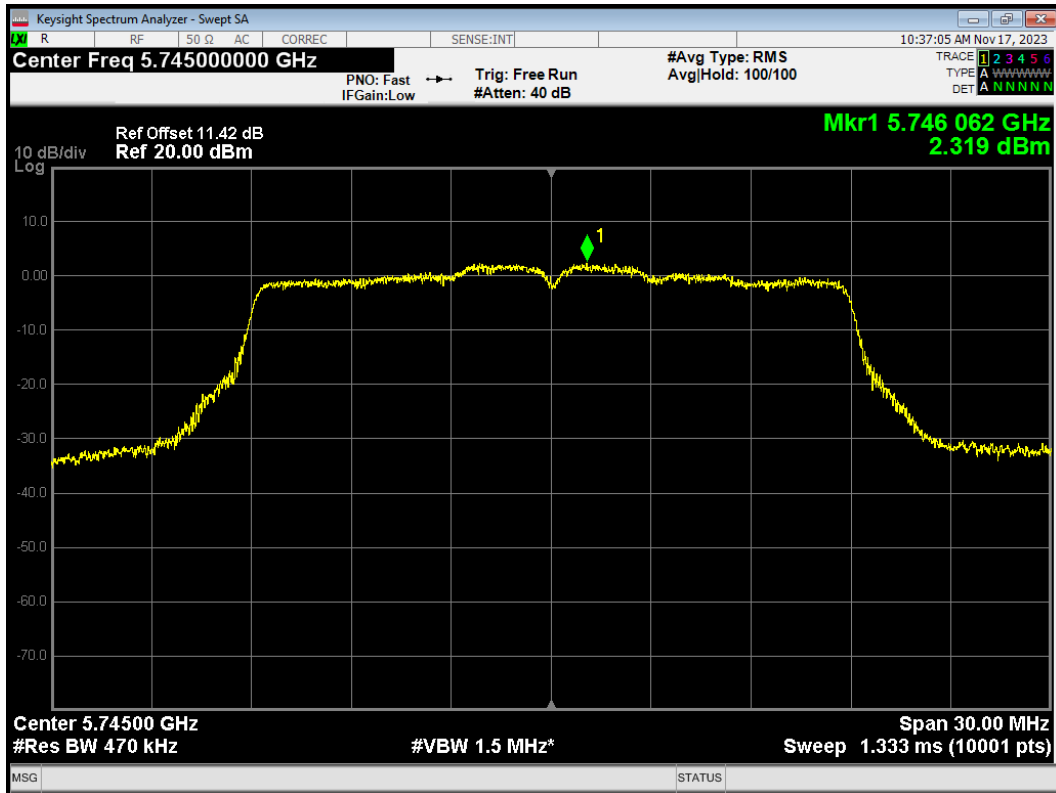

PSD 802.11n(HT20) 5745MHz Ant2

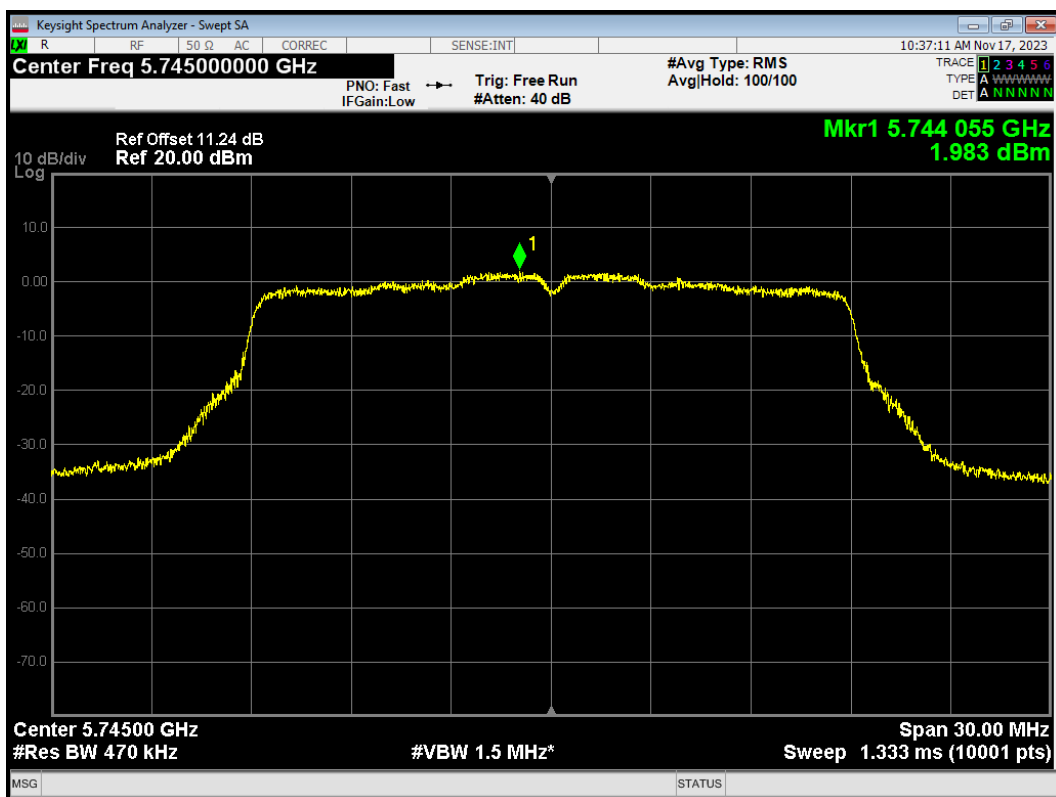

PSD 802.11n(HT20) 5785MHz Ant1

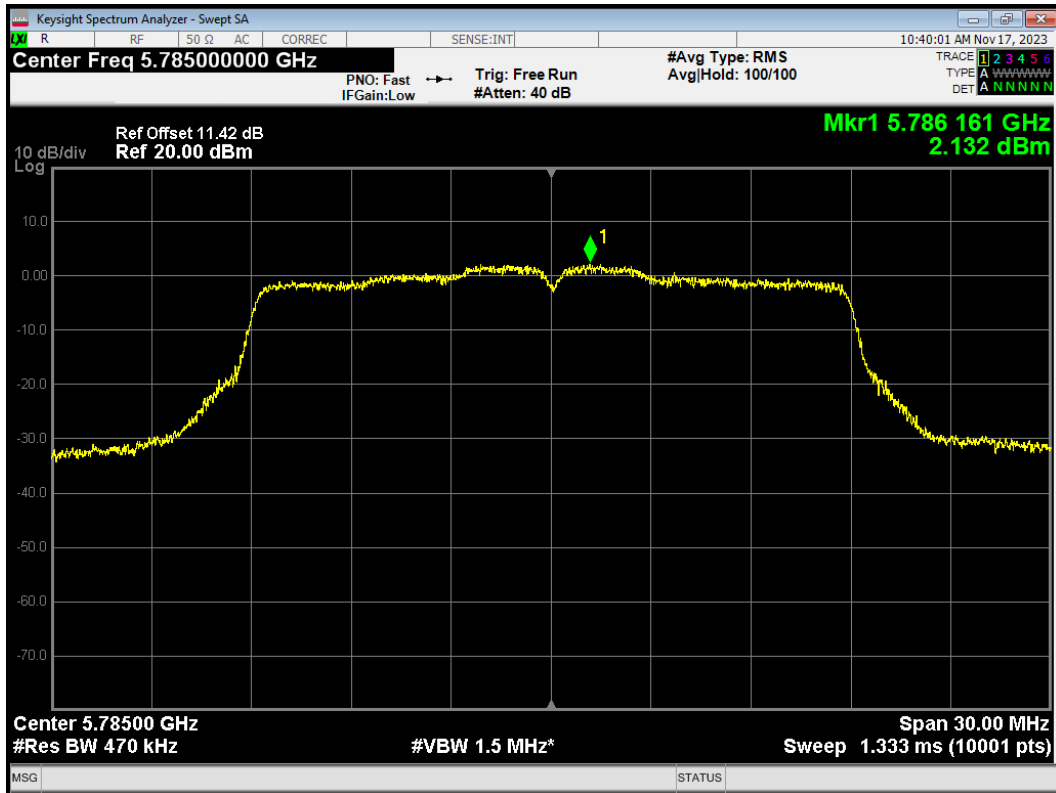

PSD 802.11n(HT20) 5785MHz Ant2

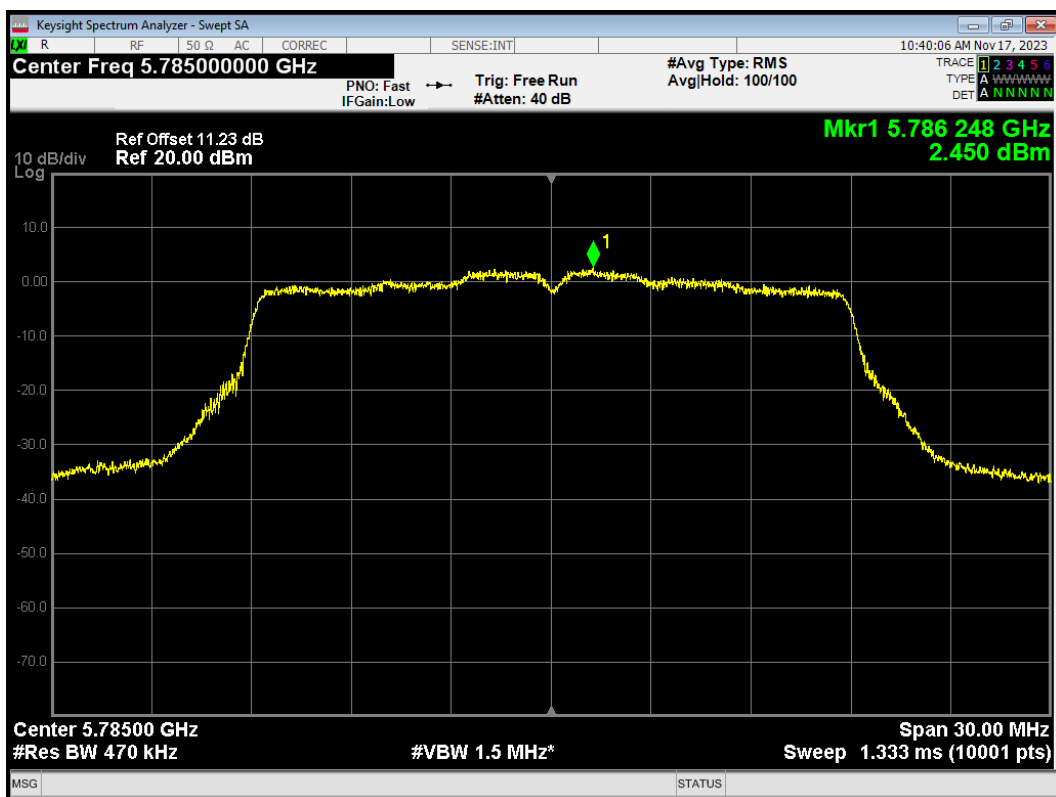

PSD 802.11n(HT20) 5825MHz Ant1

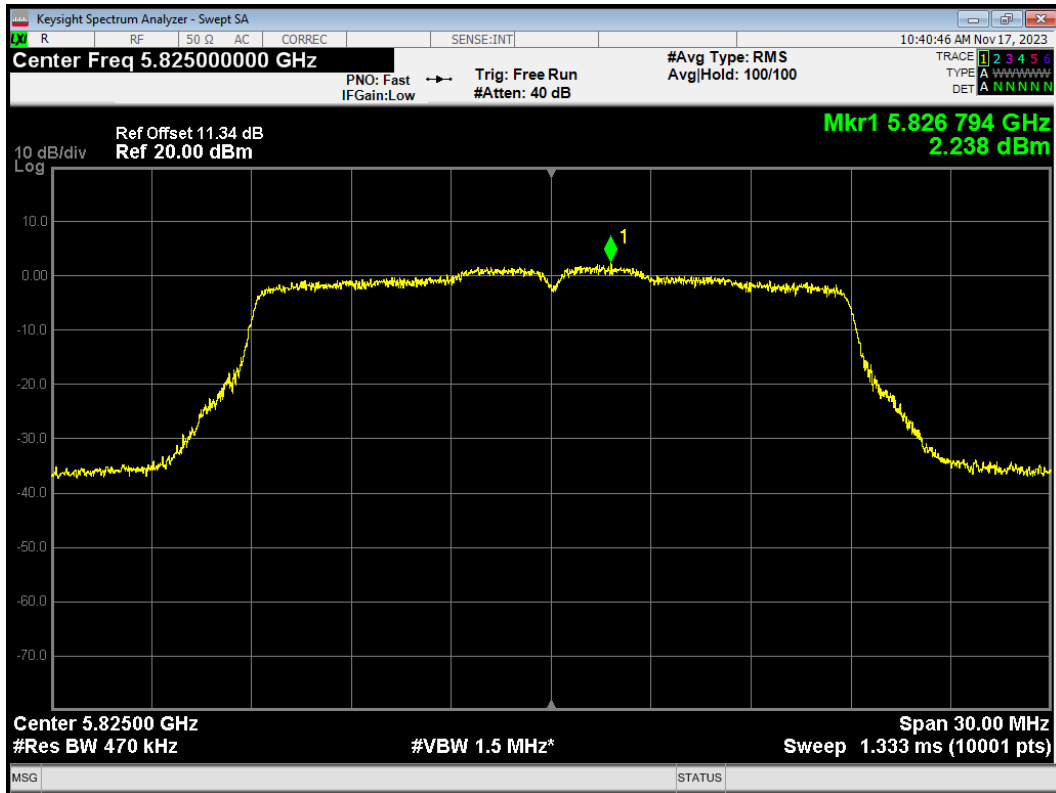

PSD 802.11n(HT20) 5825MHz Ant2

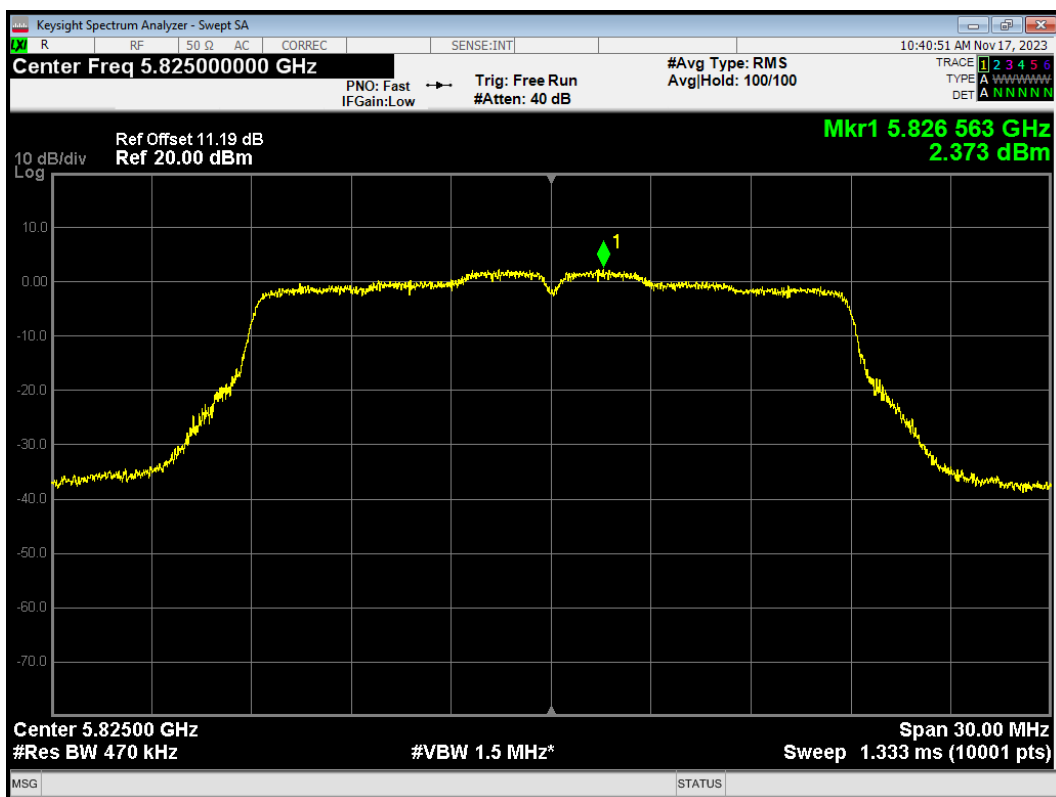

PSD 802.11n(HT40) 5710MHz Ant1

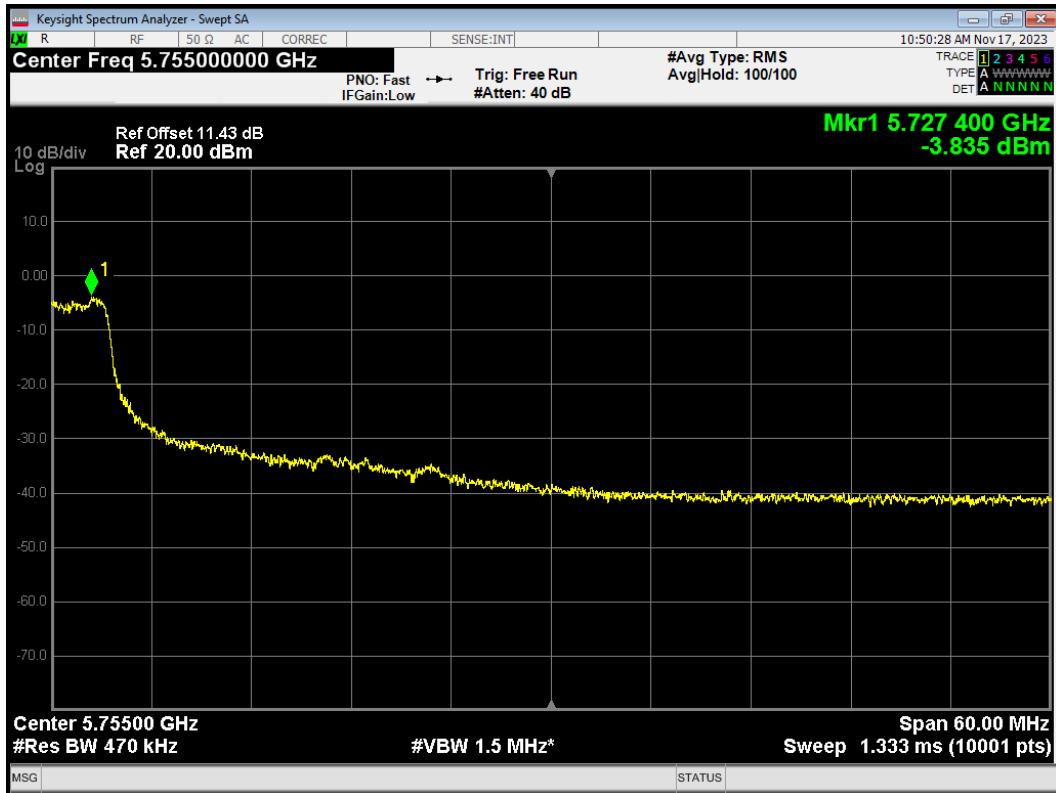

PSD 802.11n(HT40) 5710MHz Ant2

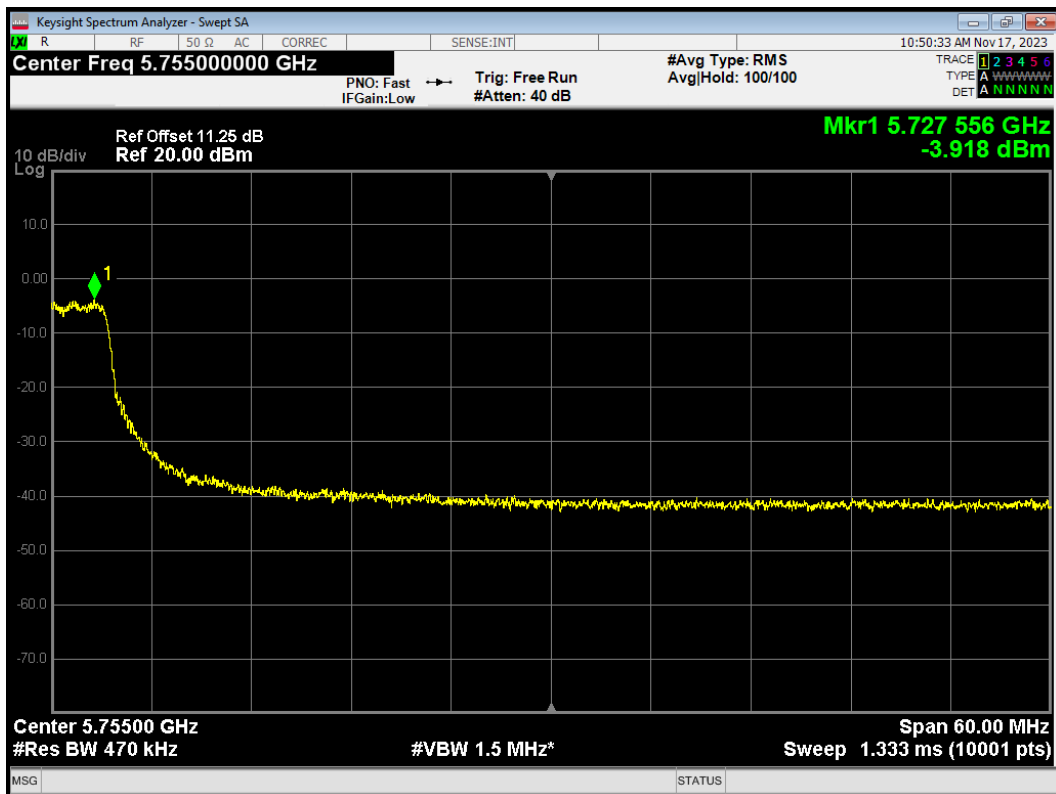

PSD 802.11n(HT40) 5755MHz Ant1

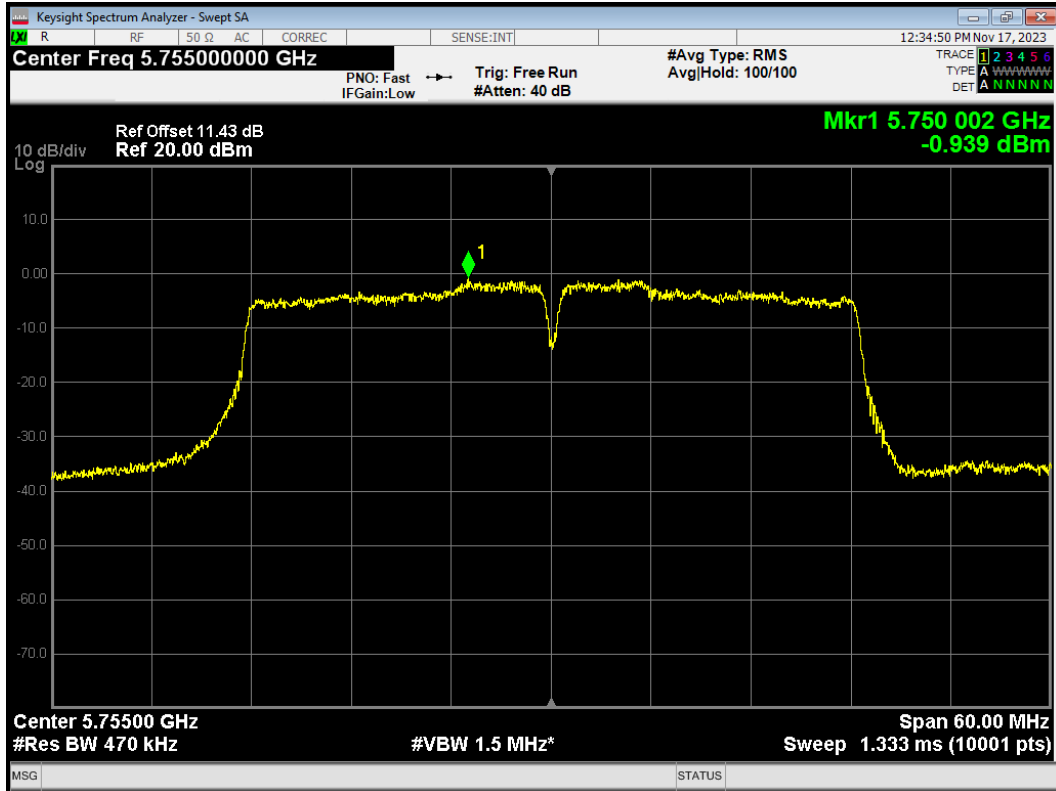

PSD 802.11n(HT40) 5755MHz Ant2

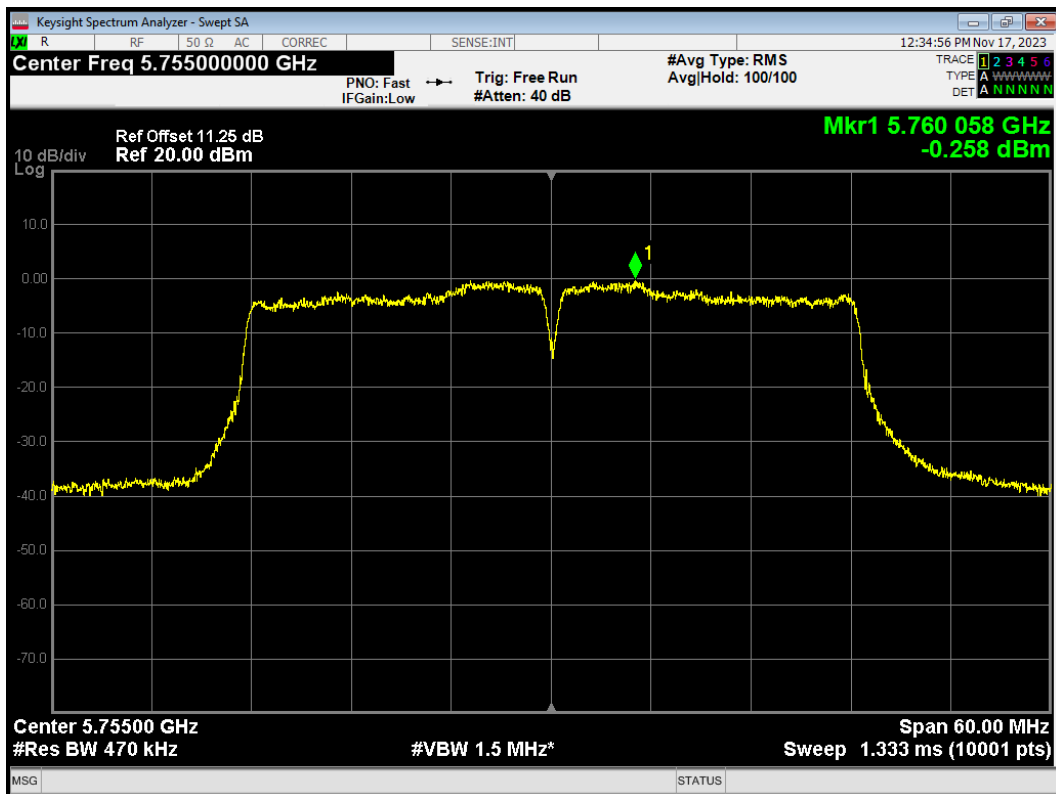

PSD 802.11n(HT40) 5795MHz Ant1

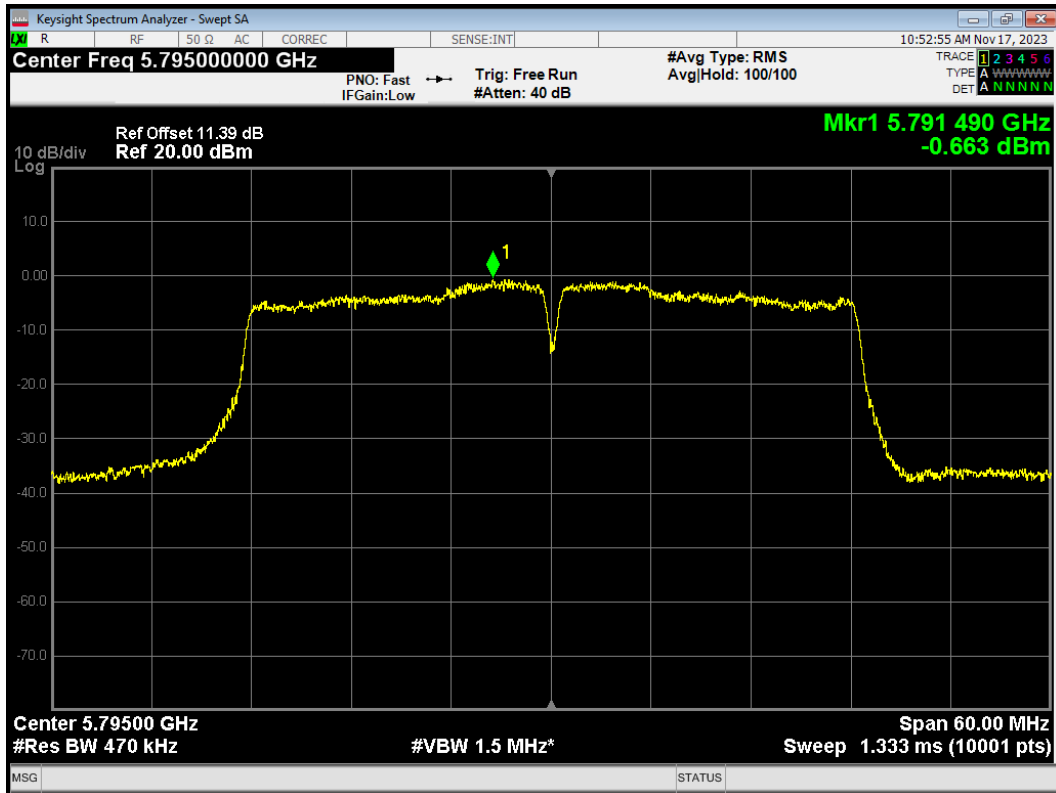

PSD 802.11n(HT40) 5795MHz Ant2

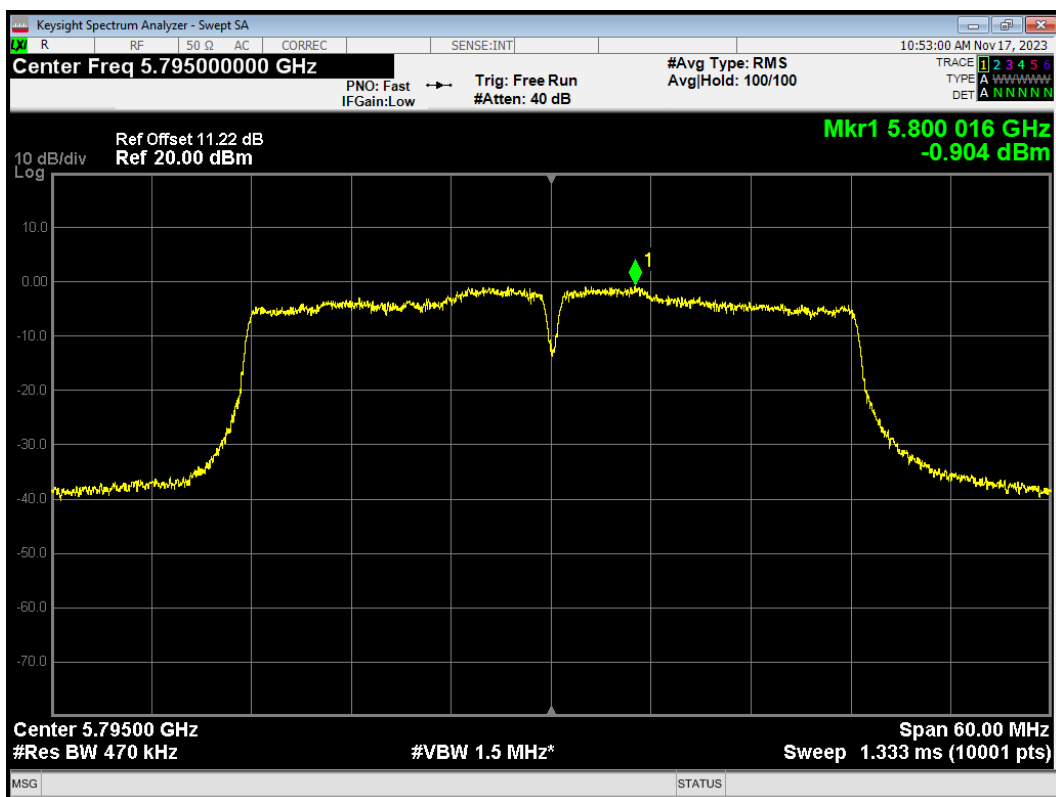

5.5. Unwanted Emission

Ambient condition

Temperature	Relative humidity	Pressure
23°C ~25°C	45%~50%	101.5kPa

Method of Measurement

The test set-up was made in accordance to the general provisions of ANSI C63.10. The Equipment Under Test (EUT) was set up on a non-conductive table in the semi-anechoic chamber. The test was performed at the distance of 3 m between the EUT and the receiving antenna. The radiated emissions measurements were made in a typical installation configuration.

Sweep the whole frequency band range from 9kHz to the 10th harmonic of the carrier, and the emissions less than 20 dB below the permissible value are reported.

During the test, the height of receive antenna shall be moved from 1 to 4 meters, and the antenna shall be performed under horizontal and vertical polarization. The turntable shall be rotated from 0 to 360 degrees for detecting the maximum of radiated spurious signal level. The measurements shall be repeated with orthogonal polarization of the test antenna. The data of cable loss and antenna factor has been calibrated in full testing frequency range before the testing.

Set the spectrum analyzer in the following:

9kHz~150 kHz

RBW=200Hz, VBW=1kHz/ Sweep=AUTO

150 kHz~30MHz

RBW=9KHz, VBW=30KHz,/ Sweep=AUTO

Below 1GHz

RBW=100kHz / VBW=300kHz / Sweep=AUTO

a) Peak emission levels are measured by setting the instrument as follows:

Above 1GHz

PEAK: RBW=1MHz VBW=3MHz/ Sweep=AUTO

b) Average emission levels are measured by setting the instrument as follows:

Above 1GHz

AVERAGE: RBW=1MHz / VBW=3MHz / Sweep=AUTO

c) Detector: The measurements employing a CISPR quasi-peak detector except for the frequency bands 9-90 kHz, 110-490 kHz and above 1000 MHz. Radiated emission limits in these three bands are based on measurements employing an average detector.

d) Averaging type = power (i.e., rms) (As an alternative, the detector and averaging type may be set for linear voltage averaging. Some instruments require linear display mode to use linear voltage averaging. Log or dB averaging shall not be used.)

e) Sweep time = auto.

f) Perform a trace average of at least 100 traces if the transmission is continuous. If the transmission is not continuous, then the number of traces shall be increased by a factor of 1 / D, where D is the duty cycle. For example, with 50% duty cycle, at least 200 traces shall be averaged. (If a specific emission is demonstrated to be continuous—i.e., 100% duty cycle—then rather than turning ON and

OFF with the transmit cycle, at least 100 traces shall be averaged.)

g) If tests are performed with the EUT transmitting at a duty cycle less than 98%, then a correction factor shall be added to the measurement results prior to comparing with the emission limit, to compute the emission level that would have been measured had the test been performed at 100% duty cycle. The correction factor is computed as follows:

1) If power averaging (rms) mode was used in the preceding step e), then the correction factor is $[10 \log (1 / D)]$, where D is the duty cycle. For example, if the transmit duty cycle was 50%, then 3 dB shall be added to the measured emission levels.

2) If linear voltage averaging mode was used in the preceding step e), then the correction factor is $[20 \log (1 / D)]$, where D is the duty cycle. For example, if the transmit duty cycle was 50%, then 6 dB shall be added to the measured emission levels.

3) If a specific emission is demonstrated to be continuous (100% duty cycle) rather than turning ON and OFF with the transmit cycle, then no duty cycle correction is required for that emission.

Reduce the video bandwidth until no significant variations in the displayed signal are observed in subsequent traces, provided the video bandwidth is no less than 1 Hz. For regulatory requirements that specify averaging only over the transmit duration (e.g., digital transmission system [DTS] and Unlicensed National Information Infrastructure [U-NII]), the video bandwidth shall be greater than $[1 / (\text{minimum transmitter on time})]$ and no less than 1 Hz.

The field strength of spurious emission was measured in the following position: EUT stand-up position (Z axis), lie-down position (X, Y axis). The worst emission was found in stand-up position (Z axis) and the loop antenna is vertical, others antenna are vertical and horizontal.

The test is in transmitting mode.

Test setup

9KHz~ 30MHz

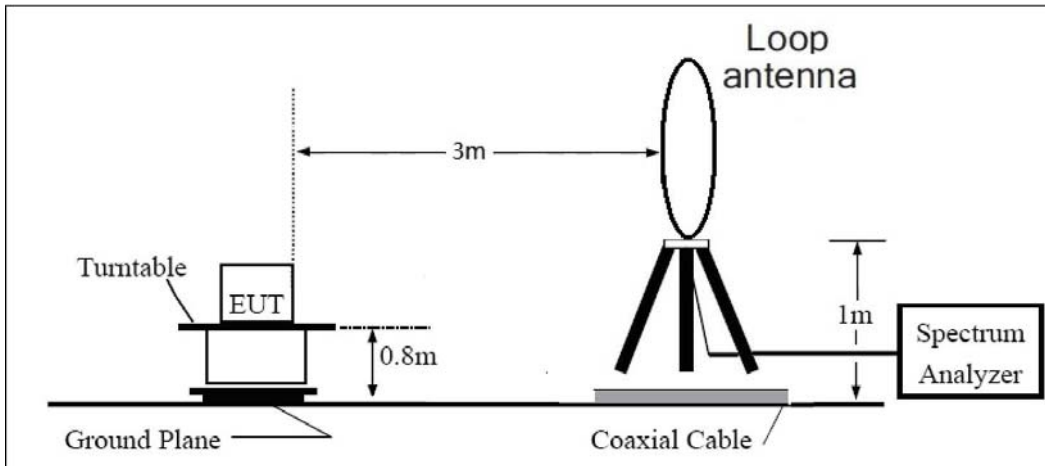

30MHz~ 1GHz

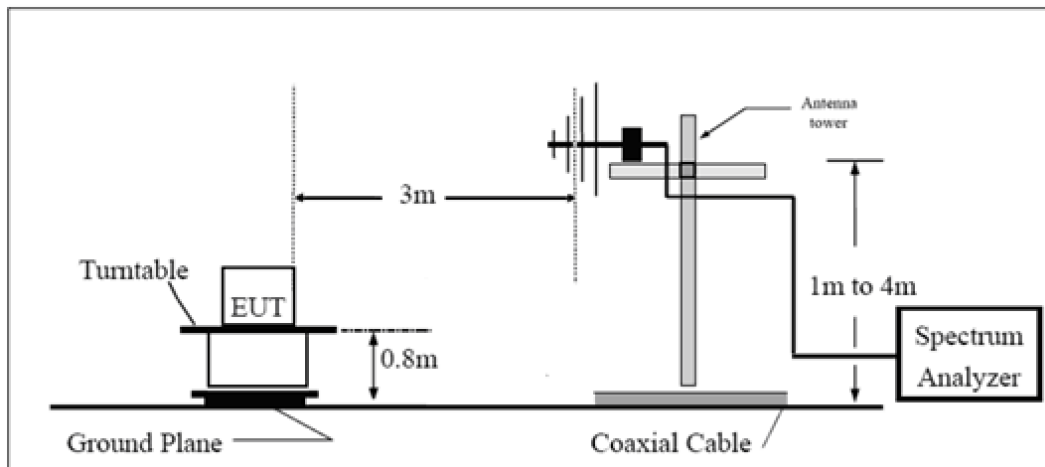

Above 1GHz

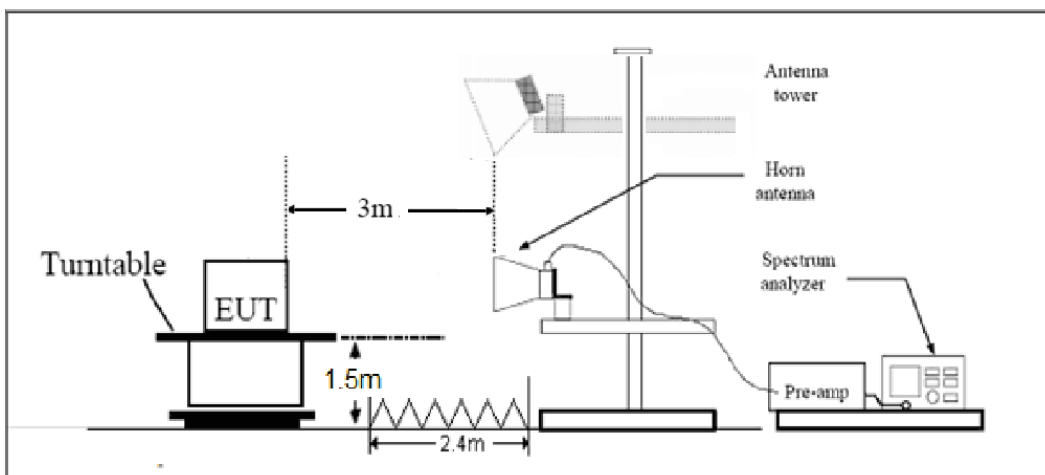

Note: Area side:2.4mX3.6m