

RF TEST REPORT

Applicant	Quectel Wireless Solutions Co., Ltd.
FCC ID	XMR202303AF20
Product	Wi-Fi & Bluetooth Module
Brand	Quectel
Model	AF20
Report No.	R2212A1318-R3V1
Issue Date	June 6, 2023

TA Technology (Shanghai) Co., Ltd. tested the above equipment in accordance with the requirements in **FCC CFR47 Part 15E (2022)**. The test results show that the equipment tested is capable of demonstrating compliance with the requirements as documented in this report.

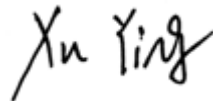

Prepared by: Xu Ying



Approved by: Xu Kai

TA Technology (Shanghai) Co., Ltd.

Building 3, No.145, Jintang Rd, Pudong Shanghai, P.R.China

TEL: +86-021-50791141/2/3

FAX: +86-021-50791141/2/3-8000

TABLE OF CONTENT

1.	Test Laboratory	5
1.1.	Notes of the test report.....	5
1.2.	Test facility	5
1.3.	Testing Location.....	5
2.	General Description of Equipment under Test.....	6
2.1.	Applicant and Manufacturer Information.....	6
2.2.	General information.....	6
3.	Applied Standards	8
4.	Test Configuration	9
5.	Test Case Results	12
5.1.	Occupied Bandwidth	12
5.2.	Average Power Output	55
5.3.	Frequency Stability.....	63
5.4.	Power Spectral Density.....	67
5.5.	Unwanted Emission	104
5.6.	Conducted Emission	203
6.	Main Test Instruments.....	206
	ANNEX A: The EUT Appearance	207
	ANNEX B: Test Setup Photos	208

Version	Revision description	Issue Date
Rev.0	Initial issue of report.	June 1, 2023
Rev.1	Update information in page 6.	June 6, 2023
Note: This revised report (Report No.: R2212A1318-R3V1) supersedes and replaces the previously issued report (Report No.: R2212A1318-R3). Please discard or destroy the previously issued report and dispose of it accordingly.		

Summary of measurement results

Number	Test Case	Clause in FCC rules	Verdict
1	Average output power	15.407(a)	PASS
2	Occupied bandwidth	15.407(e)	PASS
3	Frequency stability	15.407(g)	PASS
4	Power spectral density	15.407(a)	PASS
5	Unwanted Emissions	15.407(b)	PASS
6	Conducted Emissions	15.207	PASS
Date of Testing: March 16, 2023 ~ May 8, 2023 Date of Sample Received: March 15, 2023			
Note: PASS: The EUT complies with the essential requirements in the standard. FAIL: The EUT does not comply with the essential requirements in the standard. All indications of Pass/Fail in this report are opinions expressed by TA Technology (Shanghai) Co., Ltd. based on interpretations and/or observations of test results. Measurement Uncertainties were not taken into account and are published for informational purposes only.			

1. Test Laboratory

1.1. Notes of the test report

This report shall not be reproduced in full or partial, without the written approval of **TA Technology (Shanghai) Co., Ltd.** The results documented in this report apply only to the tested sample, under the conditions and modes of operation as described herein. Measurement Uncertainties were not taken into account and are published for informational purposes only. This report is written to support regulatory compliance of the applicable standards stated above.

1.2. Test facility

FCC (Designation number: CN1179, Test Firm Registration Number: 446626)

TA Technology (Shanghai) Co., Ltd. has been listed on the US Federal Communications Commission list of test facilities recognized to perform electromagnetic emissions measurements.

A2LA (Certificate Number: 3857.01)

TA Technology (Shanghai) Co., Ltd. has been listed by American Association for Laboratory Accreditation to perform electromagnetic emission measurement.

1.3. Testing Location

Company: TA Technology (Shanghai) Co., Ltd.

Address: Building 3, No.145, Jintang Rd, Pudong Shanghai, P.R.China

City: Shanghai

Post code: 201201

Country: P. R. China

Contact: Xu Kai

Telephone: +86-021-50791141/2/3

Fax: +86-021-50791141/2/3-8000

Website: <http://www.ta-shanghai.com>

E-mail: xukai@ta-shanghai.com

2. General Description of Equipment under Test

2.1. Applicant and Manufacturer Information

Applicant	Quectel Wireless Solutions Co., Ltd.
Applicant address	Building 5, Shanghai Business Park Phase III (Area B), No.1016 Tianlin Road, Minhang District, Shanghai, China, 200233
Manufacturer	Quectel Wireless Solutions Co., Ltd.
Manufacturer address	Building 5, Shanghai Business Park Phase III (Area B), No.1016 Tianlin Road, Minhang District, Shanghai, China, 200233

2.2. General information

EUT Description	
Model	AF20
SN	D1A20JK20000024
Hardware Version	R1.0
Software Version	NA
Power Supply	External power supply
Antenna Type	External Antenna
Antenna Connector	SMA Male (Center Pin) (module use unique antenna connector meet with the standard FCC Part 15.203 unique antenna connector requirement)
Directional Gain	NA
Operating Frequency Range(s)	U-NII-1: 5150MHz-5250MHz U-NII-2A:5250MHz -5350MHz U-NII-2C:5470MHz-5725MHz U-NII-3: 5725MHz -5850MHz
Modulation Type	802.11a/n (HT20/HT40): OFDM 802.11ac (VHT20/VHT40/VHT80): OFDM
Max. Output Power	11.8 dBm
Testing temperature range:	-20 ° C to 50° C
Operating temperature range:	-35 ° C to 75° C
Operating voltage range:	3.14 V to 3.46 V
State DC voltage:	3.3 V
Auxiliary test equipment	
Antenna	Manufacturer: Quectel Wireless Solutions Co., Ltd. Brand: Quectel Model: YE0038AA . Antenna Gain: 1.14 dBi for Wi-Fi 5G

Note:

1. The EUT is sent from the applicant to TA and the information of the EUT is declared by the applicant.
2. This device support automatically discontinue transmission, while the device is not transmitting any information, the device can automatically discontinue transmission and become standby mode for power saving. The device can detect the controlling signal of ACK message transmitting from remote device and verify whether it shall resend or discontinue transmission.
3. (a) Manufacturers implements security features in any digitally modulated devices capable of operating in any of the U-NII bands, so that third parties are not able to reprogram the device to operate outside the parameters for which the device was certified. The software prevents the user from operating the transmitter with operating frequencies, output power, modulation types or other radio frequency parameters outside those that were approved for the device. Manufacturers uses means including, but not limited to the use of a private network that allows only authenticated users to download software, electronic signatures in software or coding in hardware that is decoded by software to verify that new software can be legally loaded into a device to meet these requirements and must describe the methods in their application for equipment authorization.
- (b) Manufacturers take steps to ensure that DFS functionality cannot be disabled by the operator of the U-NII device.

3. Applied Standards

According to the specifications of the manufacturer, it must comply with the requirements of the following standards:

Test standards:

FCC CFR47 Part 15E (2022) Unlicensed National Information Infrastructure Devices

ANSI C63.10-2013

Reference standard:

KDB 789033 D02 General UNII Test Procedures New Rules v02r01

4. Test Configuration

Test Mode

The EUT has been associated with peripherals and configuration operated in a manner tended to maximize its emission characteristics in a typical application.

The radiated emission was measured in the following position: EUT stand-up position (Z axis), lie-down position (X, Y axis). The worst emission was found in lie-down position (X axis) and the worst case was recorded.

In order to find the worst case condition, Pre-tests are needed at the presence of different data rate. Preliminary tests have been done on all the configuration for confirming worst case. Data rate below means worst-case rate of each test item.

Worst-case data rates are shown as following table.

Mode	Data Rate
802.11a	6 Mbps
802.11n HT20	MCS0
802.11n HT40	MCS0
802.11ac VHT20	MCS0
802.11ac VHT40	MCS0
802.11ac VHT80	MCS0

Wireless Technology and Frequency Range

Wireless Technology		Bandwidth	Channel	Frequency
Wi-Fi	U-NII-1	20 MHz	36	5180MHz
			40	5200MHz
			44	5220MHz
			48	5240MHz
		40 MHz	38	5190MHz
			46	5230MHz
	80 MHz	42	5210MHz	
	U-NII-2A	20 MHz	52	5260MHz
			56	5280MHz
			60	5300MHz
			64	5320MHz
		40 MHz	54	5270MHz
			62	5310MHz
	80 MHz	58	5290MHz	
	U-NII-2C	20 MHz	100	5500MHz
			104	5520MHz
			108	5540MHz
			112	5560MHz
			116	5580MHz
			120	5600MHz
			124	5620MHz
			128	5640MHz
			132	5660MHz
			136	5680MHz
		40 MHz	140	5700MHz
			102	5510MHz
			110	5550MHz
			118	5590MHz
			126	5630MHz
		80 MHz	134	5670MHz
106			5530MHz	
122			5610MHz	
U-NII-3	20 MHz	149	5745MHz	
		153	5765MHz	
		157	5785MHz	
		161	5805MHz	
		165	5825MHz	
	40 MHz	151	5755MHz	

			159	5795MHz
		80 MHz	155	5775MHz
Does this device support TPC Function? <input checked="" type="checkbox"/> Yes <input type="checkbox"/> No				
Does this device support TDWR Band? <input checked="" type="checkbox"/> Yes <input type="checkbox"/> No				

5. Test Case Results

5.1. Occupied Bandwidth

Ambient condition

Temperature	Relative humidity
20°C ~ 25°C	45% ~ 50%

Method of Measurement

The EUT was connected to the spectrum analyzer through an external attenuator (20dB) and a known loss cable.

For U-NII-1/U-NII-2A/U-NII-2C, set RBW \approx 1% OCB kHz, VBW \geq 3 \times RBW, measure the maximum width of the emission that is constrained by the frequencies associated with the two outermost amplitude points (upper and lower frequencies) that are attenuated by 26 dB relative to the maximum level measured in the fundamental emission.

For U-NII-3, Set RBW = 100 kHz, VBW \geq 3 \times RBW, measure the maximum width of the emission that is constrained by the frequencies associated with the two outermost amplitude points (upper and lower frequencies) that are attenuated by 6 dB relative to the maximum level measured in the fundamental emission.

Note: The automatic bandwidth measurement capability of a spectrum analyzer or EMI receiver may be employed if it implements the functionality described above.

Use the 99 % power bandwidth function of the instrument

Test Setup

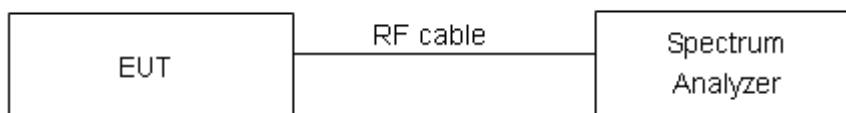

Limits

Rule FCC Part §15.407(e)

Within the 5.725-5.85 GHz band, the minimum 6 dB bandwidth of U-NII devices shall be at least 500 kHz.

Measurement Uncertainty

The assessed measurement uncertainty to ensure 95% confidence level for the normal distribution is with the coverage factor $k = 2$, $U = 936$ Hz.

Test Results:
U-NII-1

Mode	Carrier frequency (MHz)	99% bandwidth (MHz)	Minimum 26 dB bandwidth (MHz)	Conclusion
802.11a	5180	16.316	19.19	PASS
	5200	16.315	19.40	PASS
	5240	16.311	19.26	PASS
802.11n HT20	5180	17.449	20.18	PASS
	5200	17.470	20.56	PASS
	5240	17.446	20.25	PASS
802.11n HT40	5190	35.887	40.59	PASS
	5230	35.923	41.58	PASS
802.11ac VHT20	5180	17.450	20.37	PASS
	5200	17.444	19.96	PASS
	5240	17.449	20.17	PASS
802.11ac VHT40	5190	35.890	44.45	PASS
	5230	35.902	42.30	PASS
802.11ac VHT80	5210	75.001	81.77	PASS

U-NII-2A

Mode	Carrier frequency (MHz)	99% bandwidth (MHz)	Minimum 26 dB bandwidth (MHz)	Conclusion
802.11a	5260	16.307	19.09	PASS
	5300	16.304	19.10	PASS
	5320	16.325	19.27	PASS
802.11n HT20	5260	17.451	20.05	PASS
	5300	17.450	20.23	PASS
	5320	17.451	20.36	PASS
802.11n HT40	5270	35.896	42.28	PASS
	5310	35.899	40.70	PASS
802.11ac VHT20	5260	17.414	20.13	PASS
	5300	17.444	20.28	PASS
	5320	17.463	19.89	PASS
802.11ac VHT40	5270	35.899	40.78	PASS
	5310	35.908	41.00	PASS
802.11ac VHT80	5290	75.061	82.23	PASS

U-NII-2C

Mode	Carrier frequency (MHz)	99% bandwidth (MHz)	Minimum 26 dB bandwidth (MHz)	Conclusion
802.11a	5500	16.326	19.48	PASS
	5520	16.313	19.39	PASS
	5600	16.320	19.36	PASS
	5680	16.305	19.22	PASS
	5700	16.370	19.45	PASS
802.11n HT20	5500	17.467	20.40	PASS
	5520	17.432	20.02	PASS
	5600	17.474	20.12	PASS
	5680	17.440	20.11	PASS
	5700	17.463	19.83	PASS
802.11n HT40	5510	35.892	41.27	PASS
	5550	35.941	41.03	PASS
	5590	35.867	41.31	PASS
	5670	35.872	41.93	PASS
802.11ac VHT20	5500	17.456	20.15	PASS
	5600	17.460	20.20	PASS
	5700	17.461	20.11	PASS
802.11ac VHT40	5510	35.897	42.13	PASS
	5590	35.926	40.76	PASS
	5670	35.887	42.20	PASS
802.11ac VHT80	5530	75.108	81.10	PASS
	5610	74.895	84.94	PASS

U-NII-3

Mode	Carrier frequency (MHz)	99% bandwidth (MHz)	Minimum 6 dB bandwidth (MHz)	Limit (kHz)	Conclusion
802.11a	5745	16.314	15.21	500	PASS
	5785	16.302	16.34	500	PASS
	5825	16.327	15.16	500	PASS
802.11n HT20	5745	17.450	14.81	500	PASS
	5785	17.465	14.78	500	PASS
	5825	17.455	16.92	500	PASS
802.11n HT40	5755	35.909	35.13	500	PASS
	5795	35.858	35.12	500	PASS
802.11ac VHT20	5745	17.483	15.02	500	PASS
	5785	17.461	14.06	500	PASS
	5825	17.447	15.64	500	PASS
802.11ac VHT40	5755	35.913	34.92	500	PASS
	5795	35.919	33.89	500	PASS
802.11ac VHT80	5775	75.014	70.02	500	PASS

99% bandwidth

U-NII-1

OBW 802.11a 5180MHz

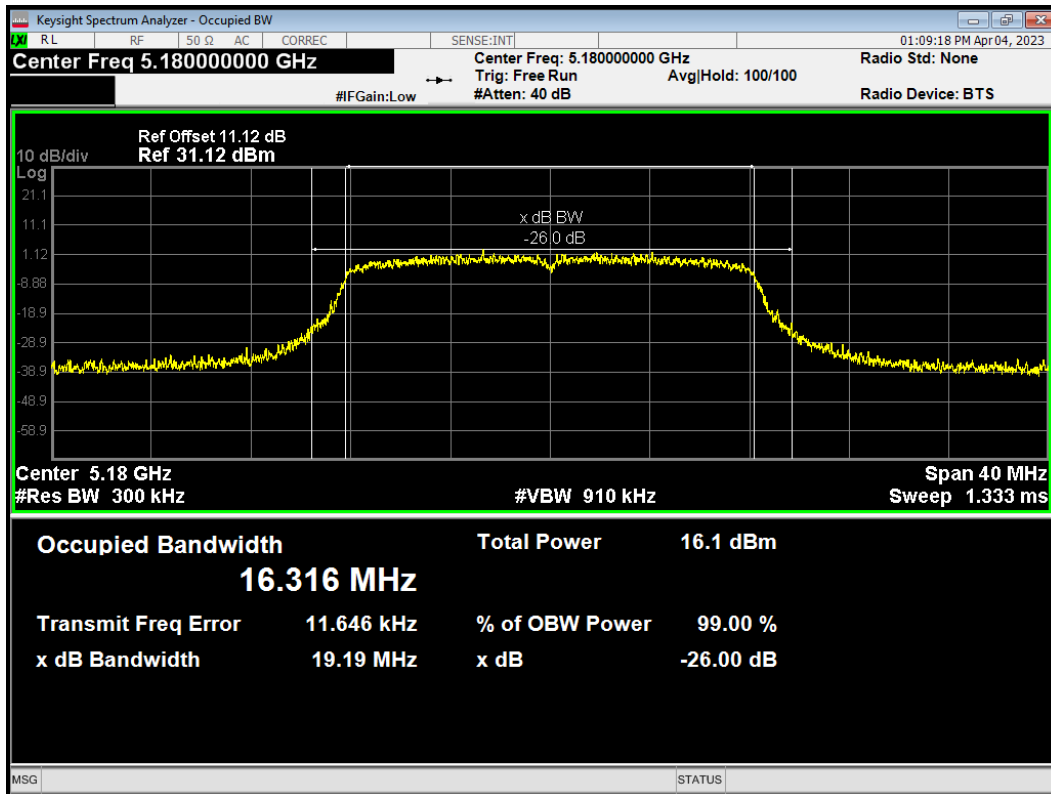

OBW 802.11a 5200MHz

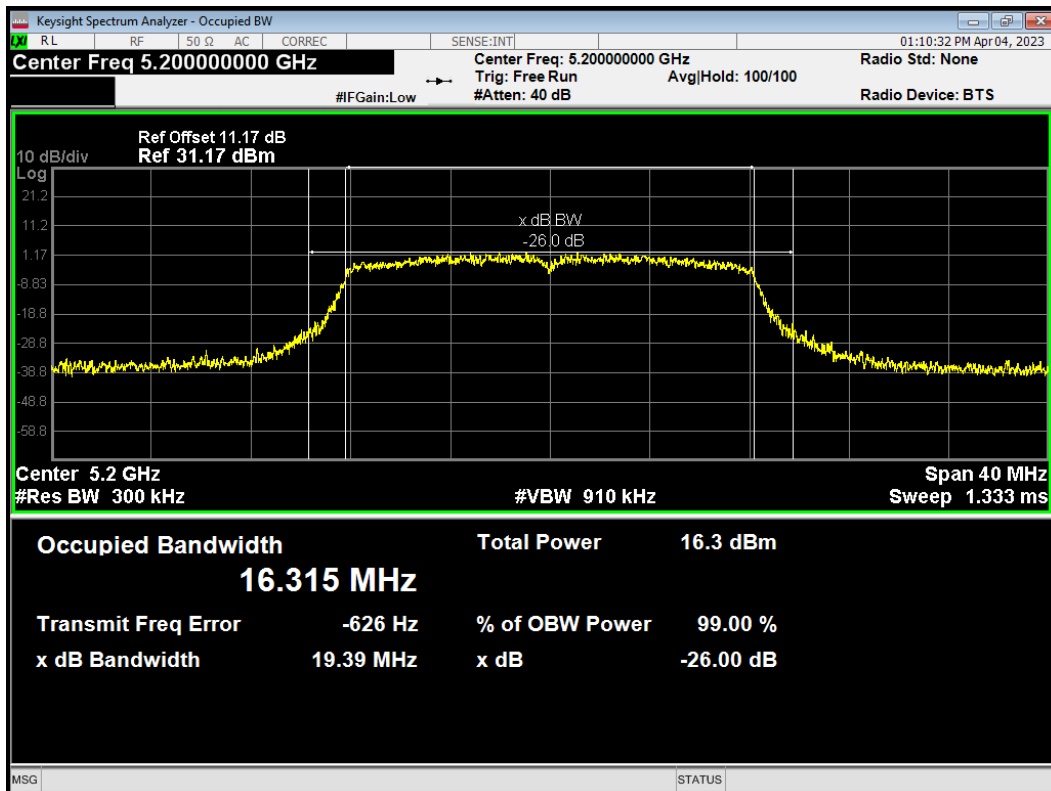

OBW 802.11a 5240MHz

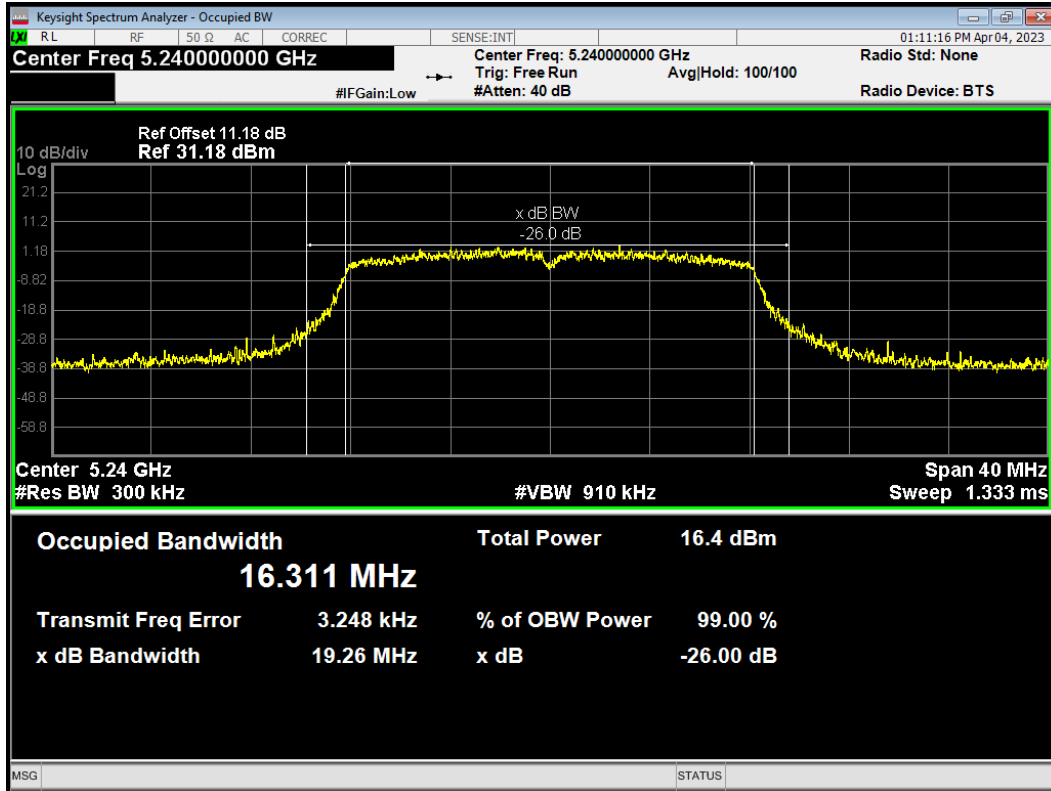

OBW 802.11ac(VHT20) 5180MHz

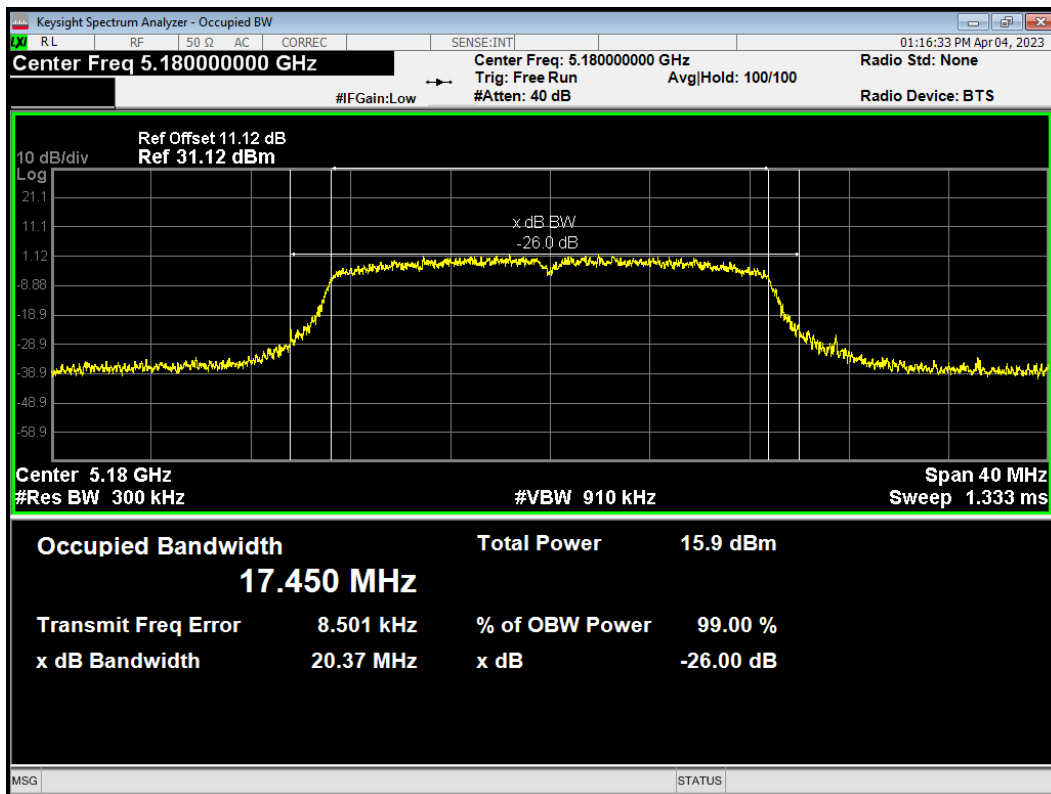

OBW 802.11ac(VHT20) 5200MHz

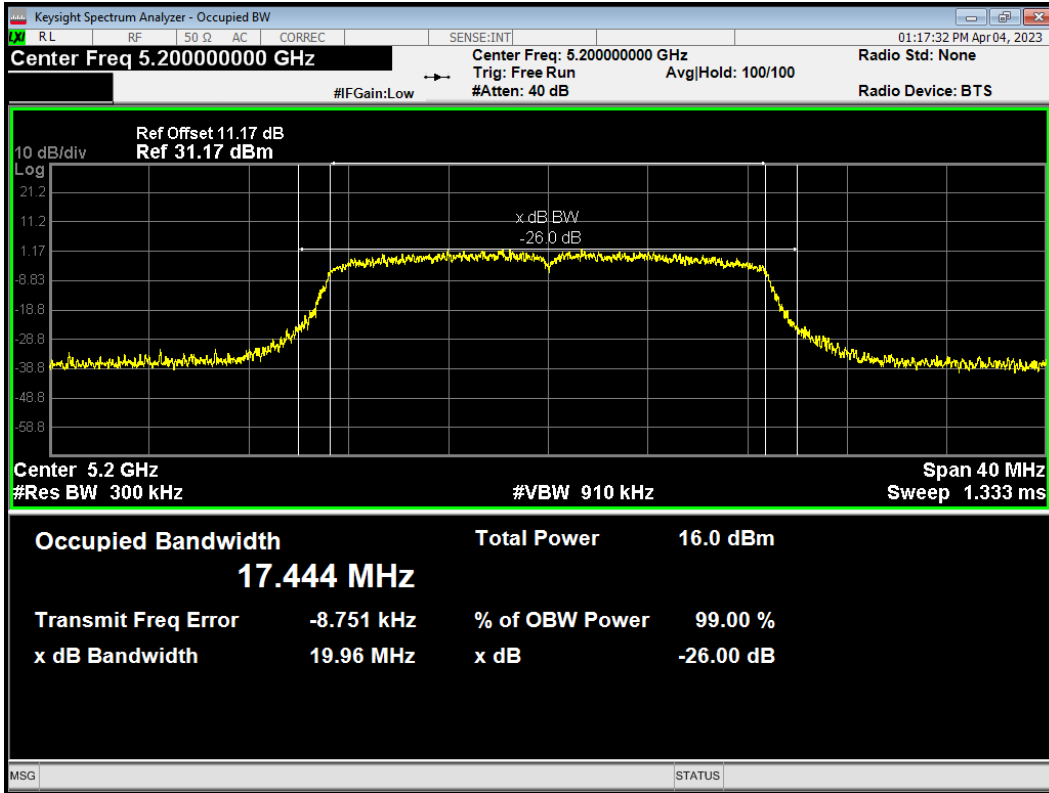

OBW 802.11ac(VHT20) 5240MHz

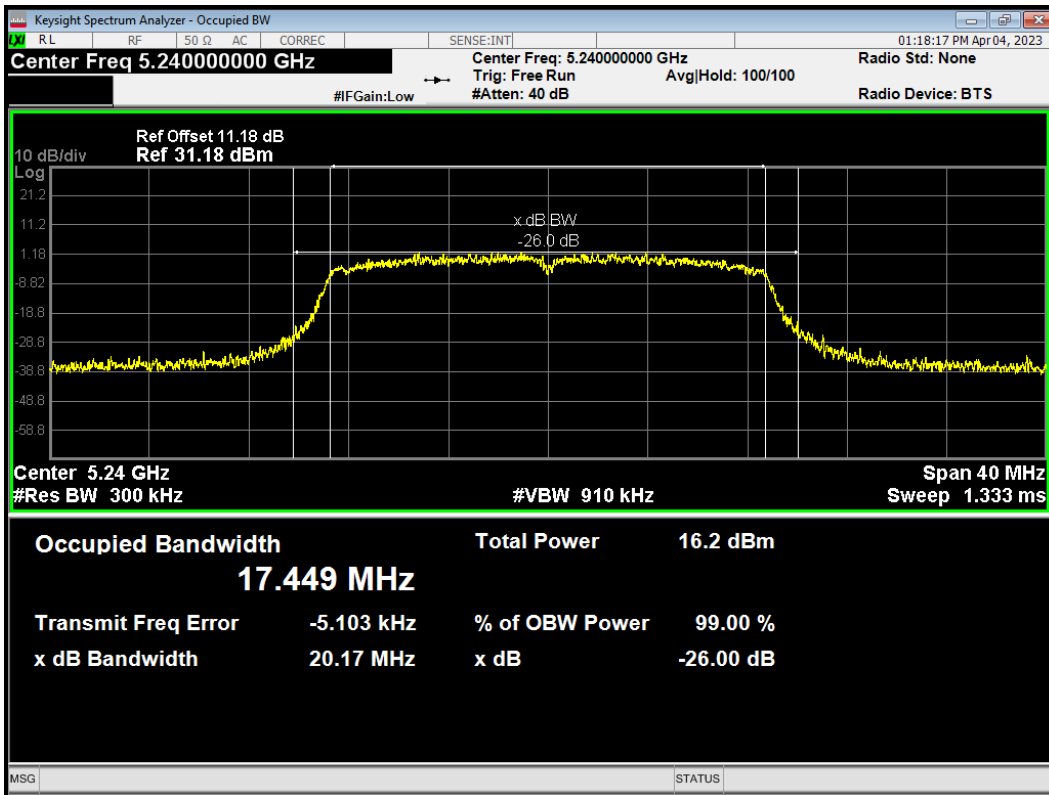

OBW 802.11ac(VHT40) 5190MHz

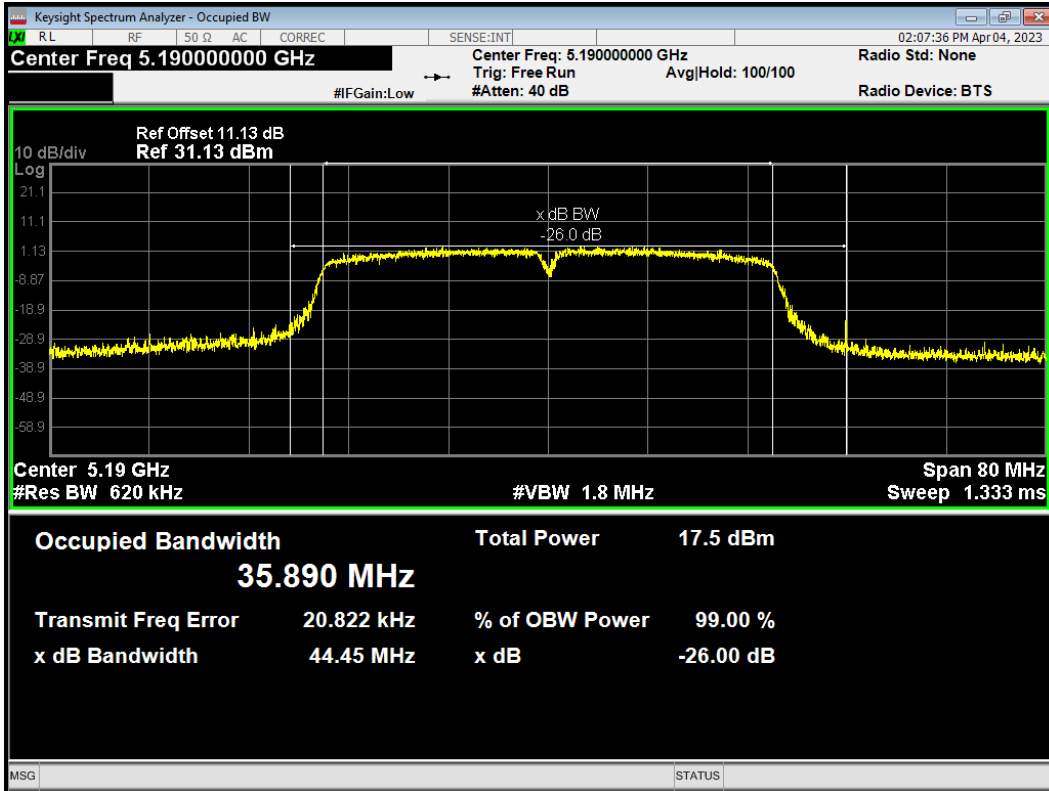

OBW 802.11ac(VHT40) 5230MHz

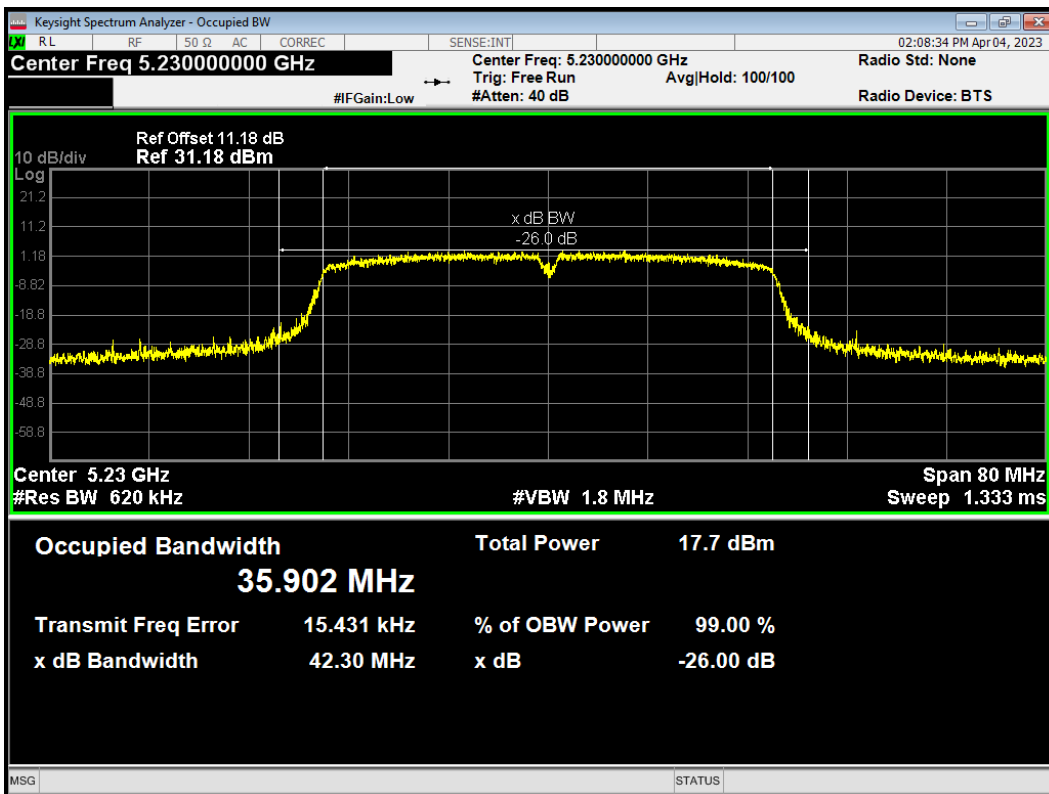

OBW 802.11ac(VHT80) 5210MHz

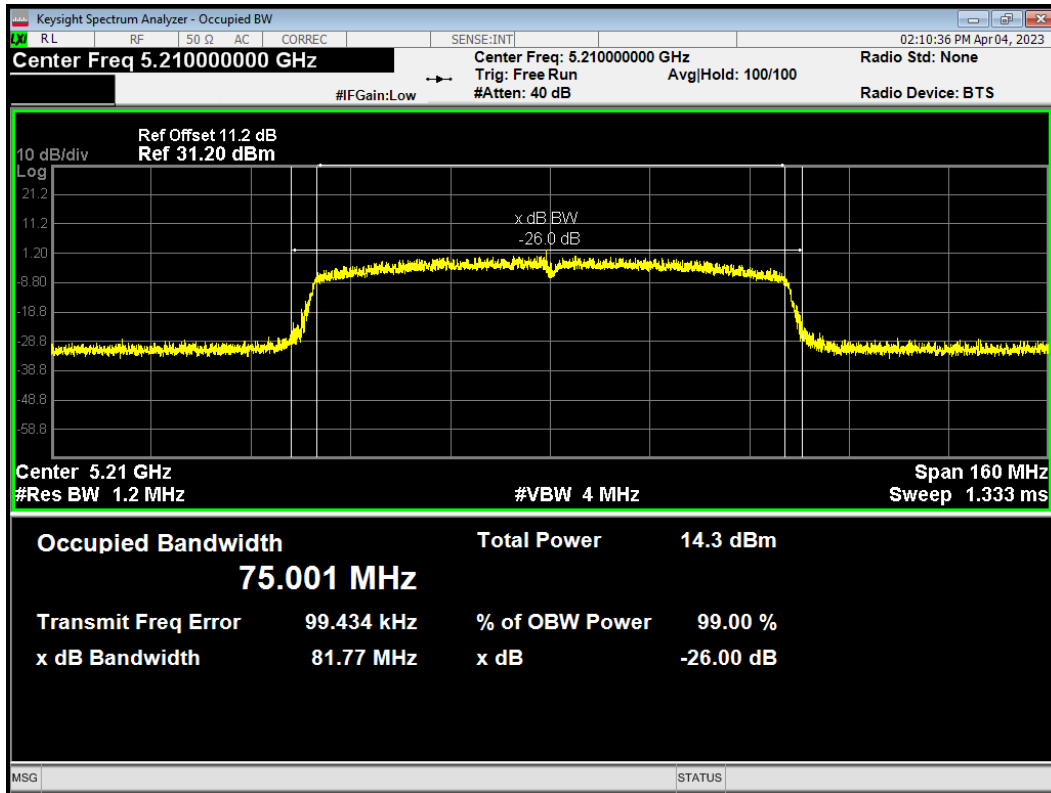

OBW 802.11n(HT20) 5180MHz

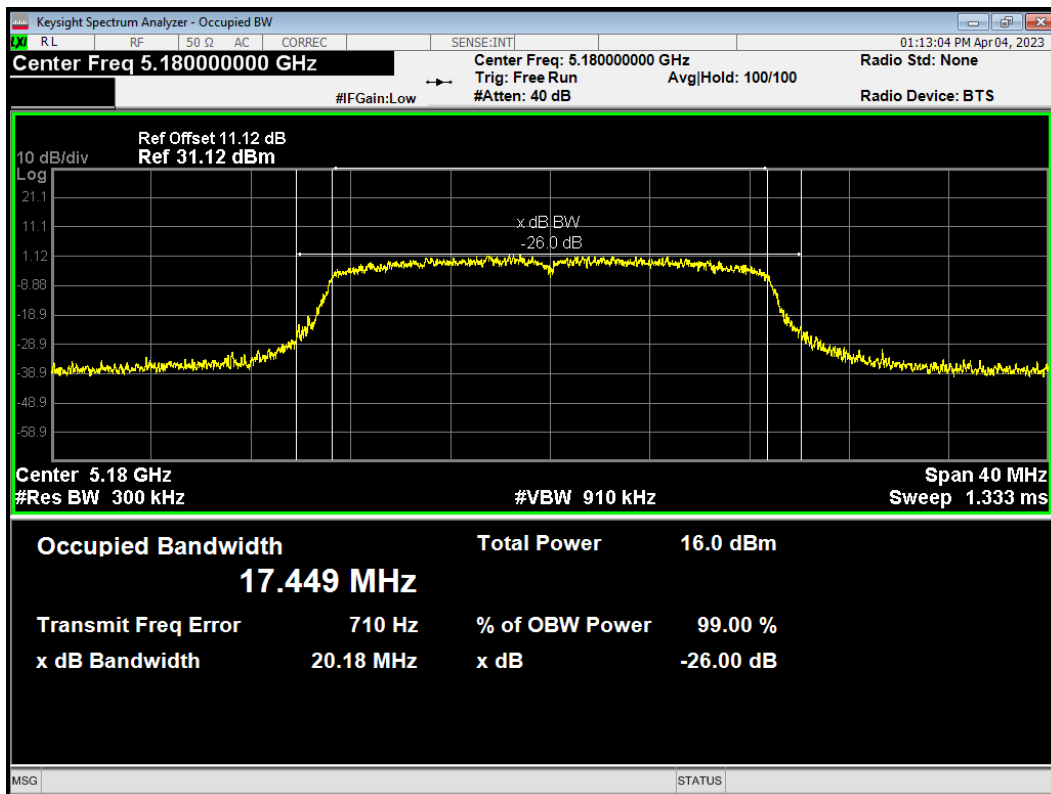

OBW 802.11n(HT20) 5200MHz

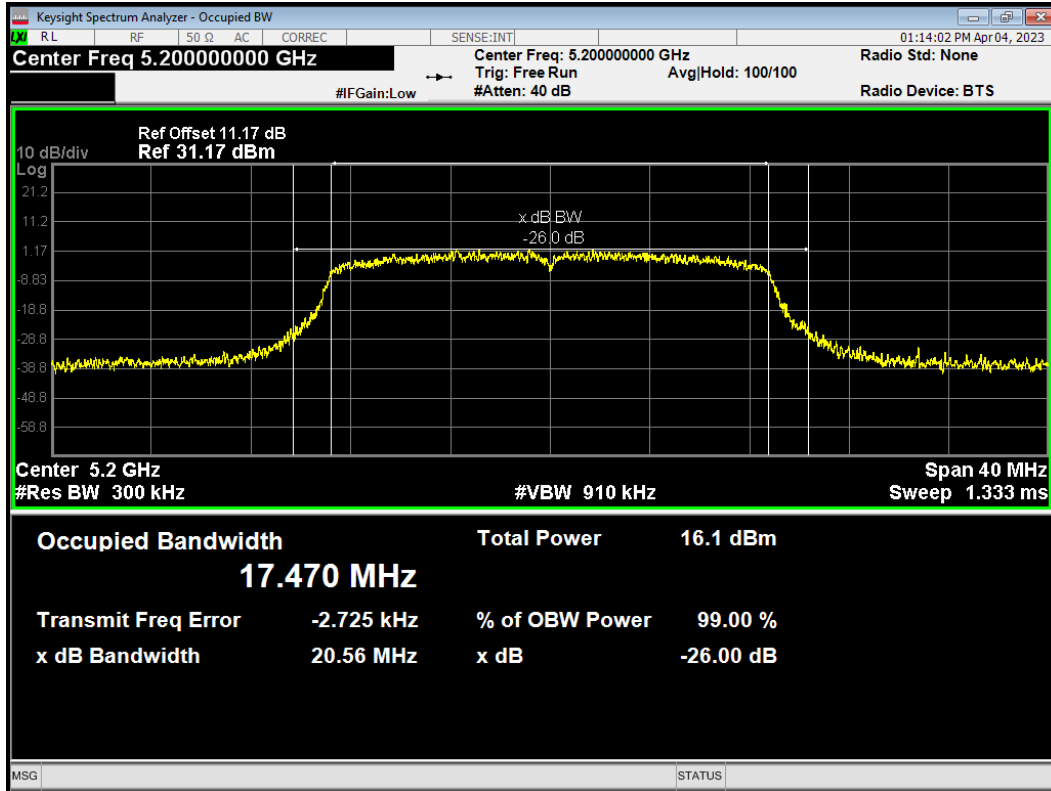

OBW 802.11n(HT20) 5240MHz

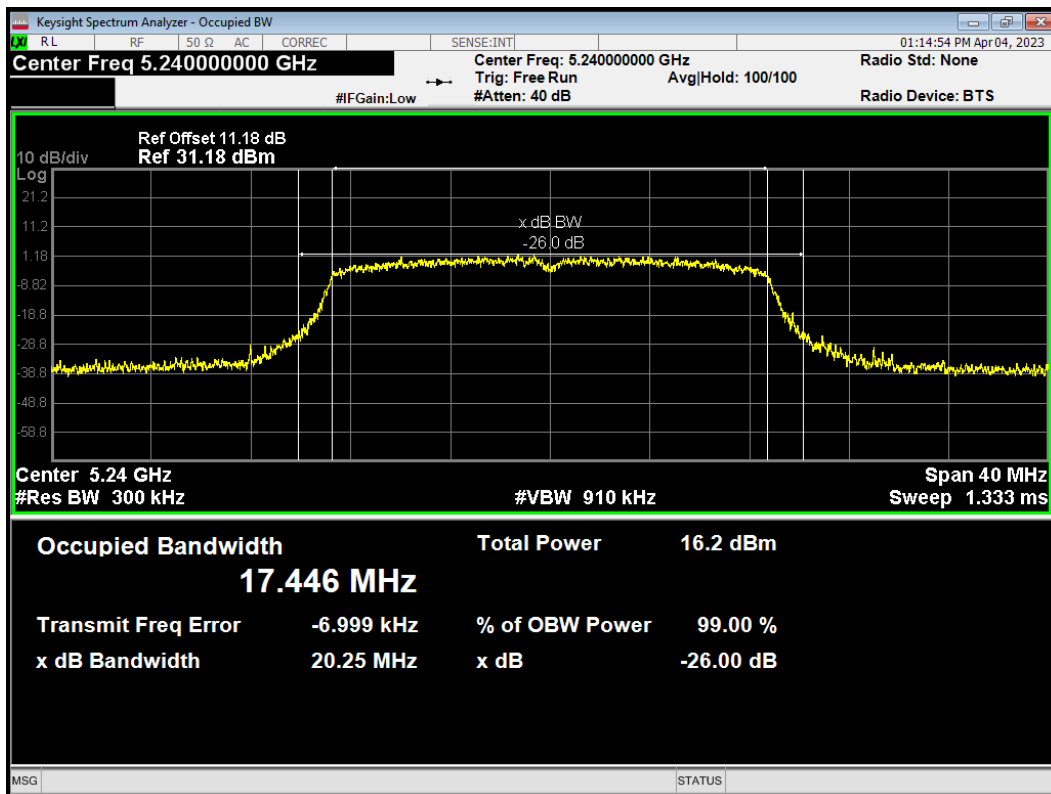

OBW 802.11n(HT40) 5190MHz

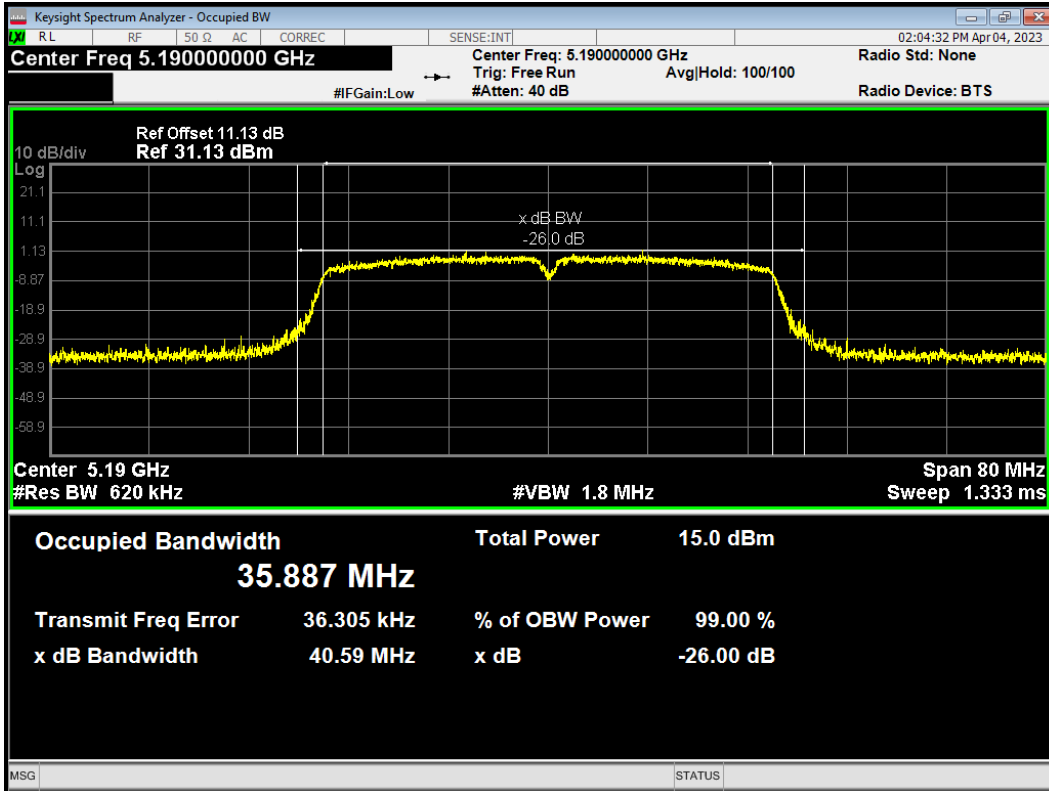

OBW 802.11n(HT40) 5230MHz

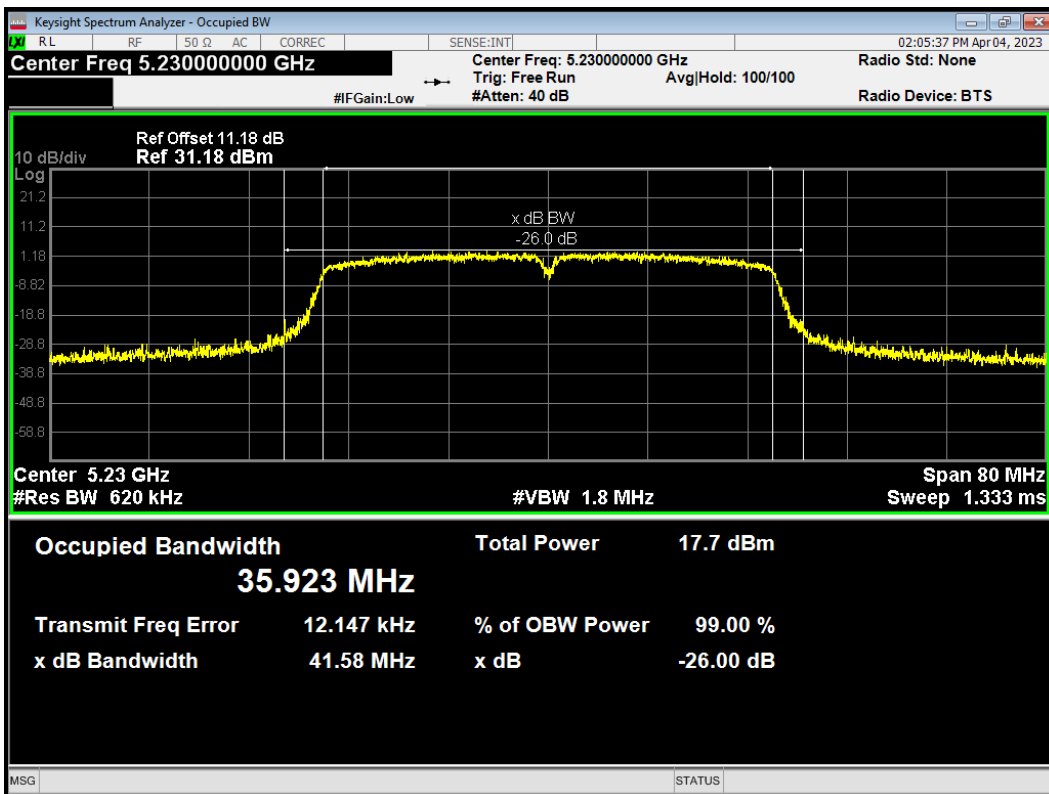

U-NII-2A

OBW 802.11a 5260MHz

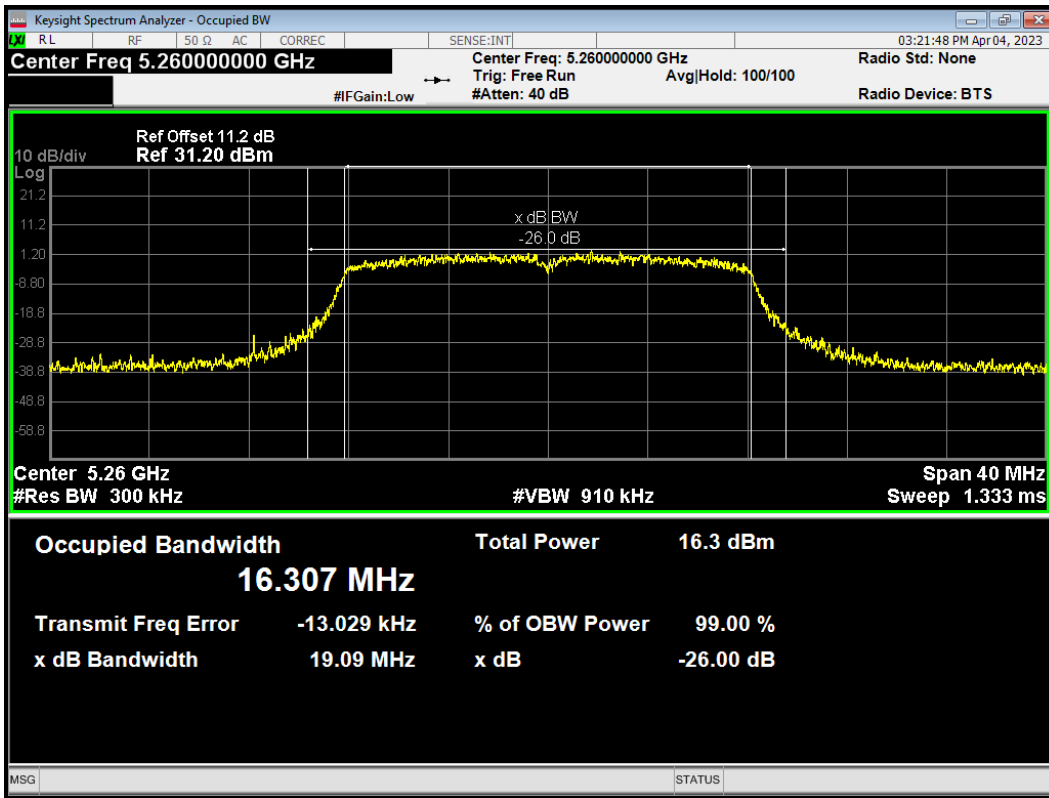

OBW 802.11a 5300MHz

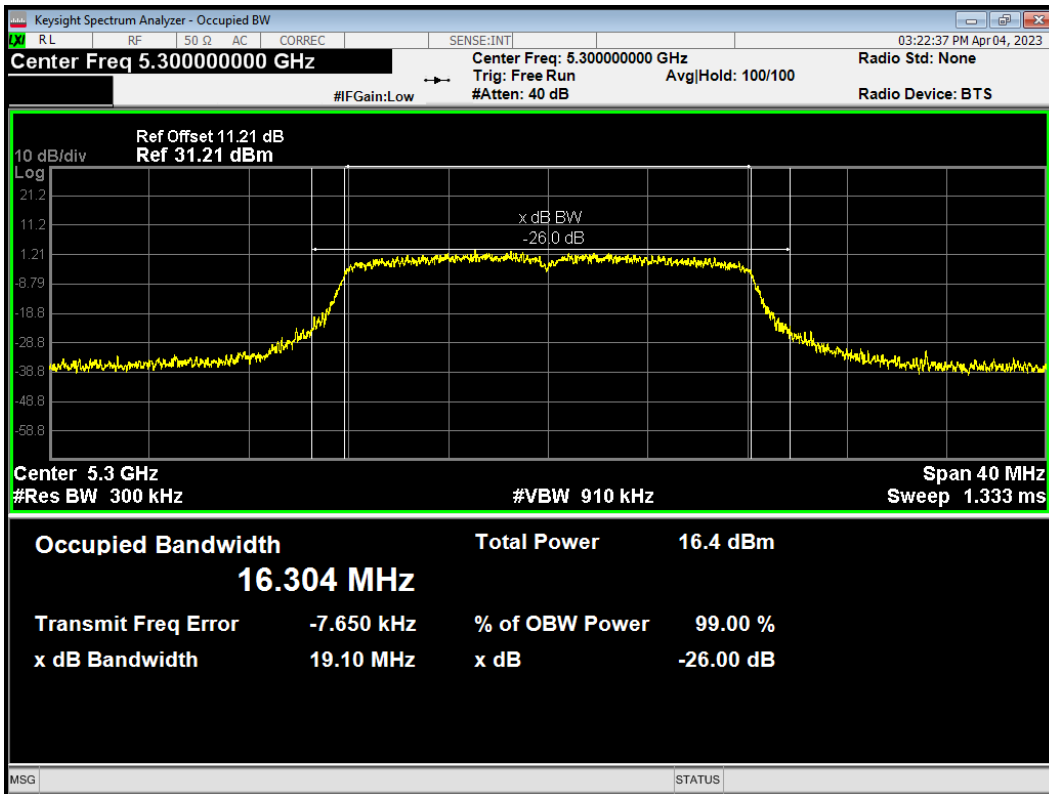

OBW 802.11a 5320MHz

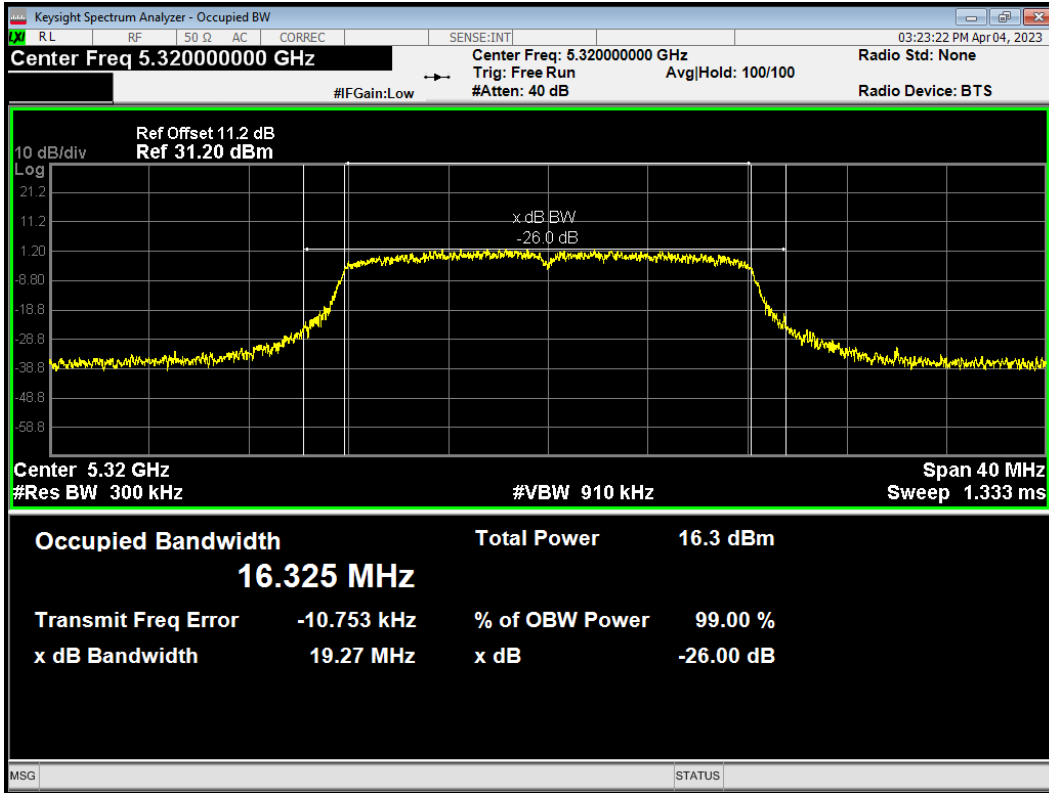

OBW 802.11ac(VHT20) 5260MHz

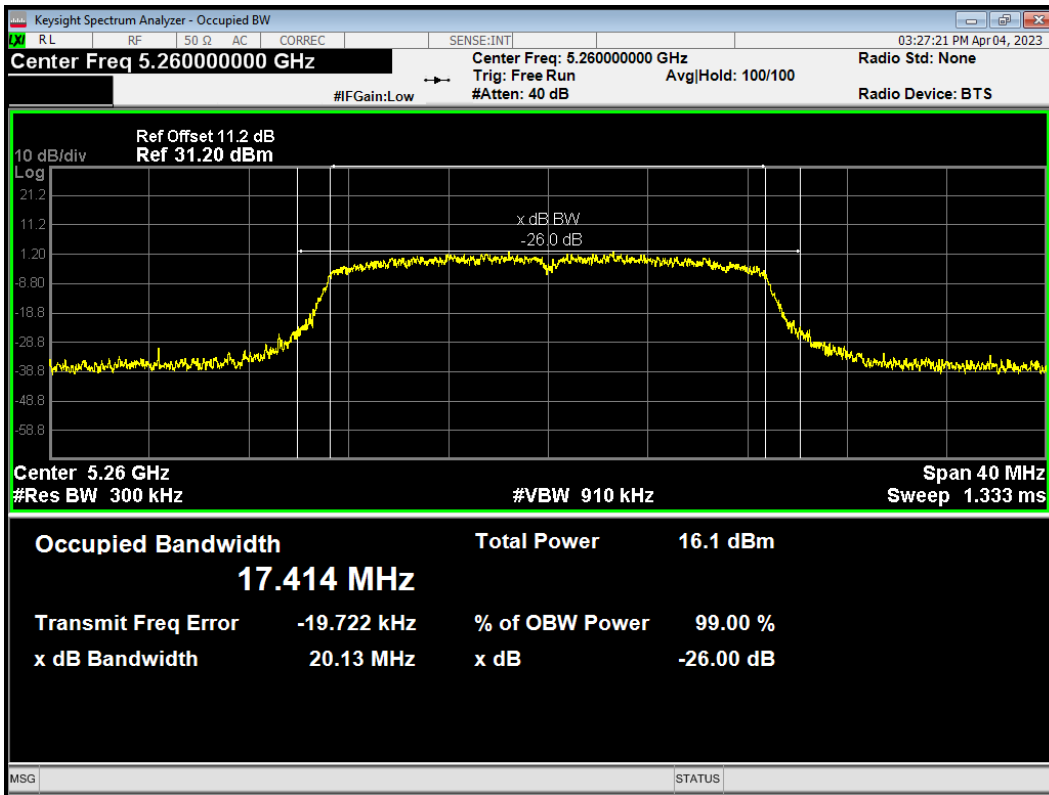

OBW 802.11ac(VHT20) 5300MHz

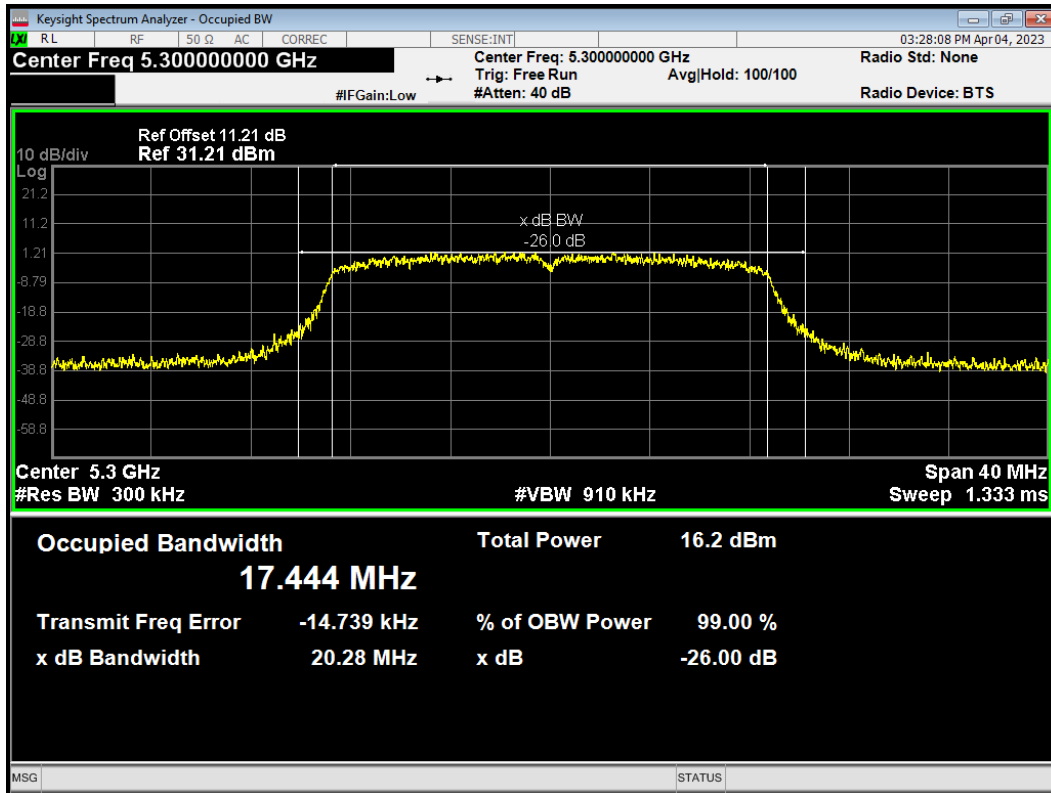

OBW 802.11ac(VHT20) 5320MHz

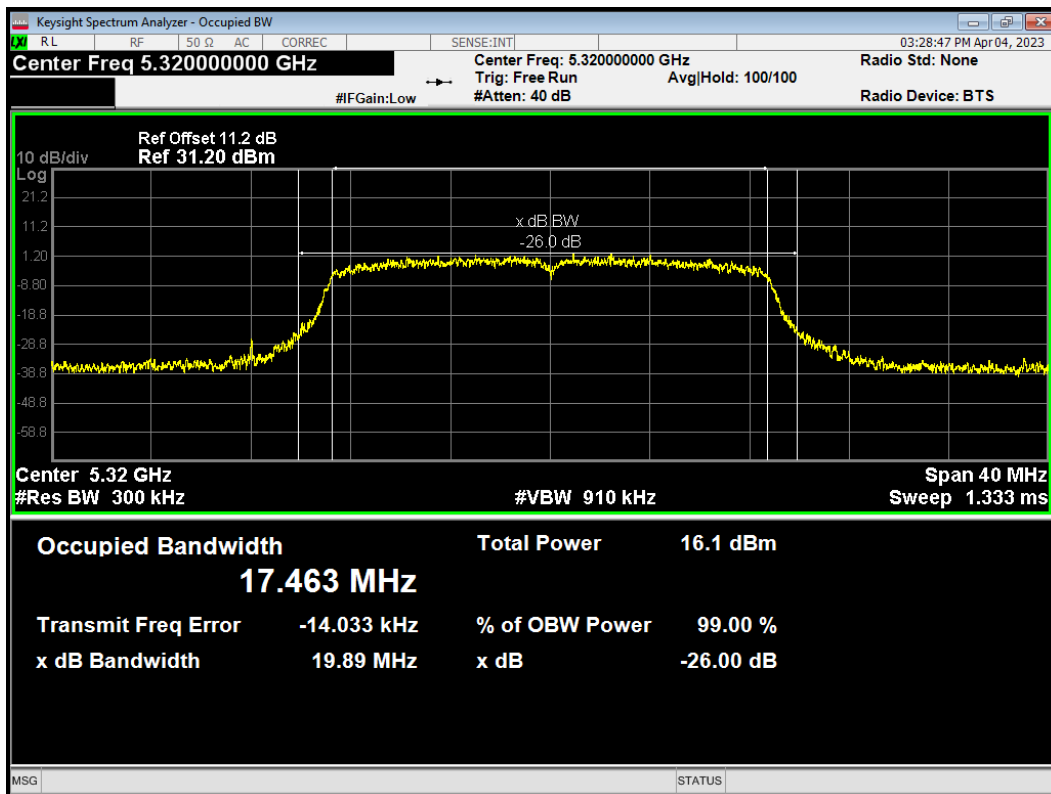

OBW 802.11ac(VHT40) 5270MHz

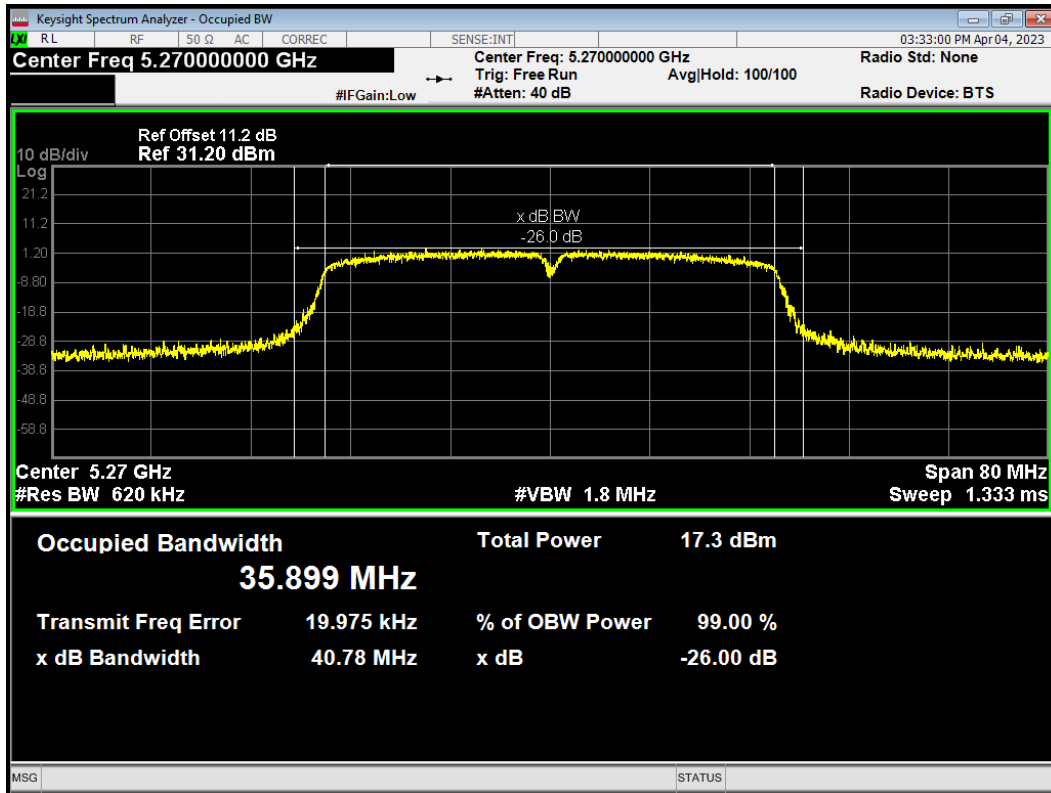

OBW 802.11ac(VHT40) 5310MHz

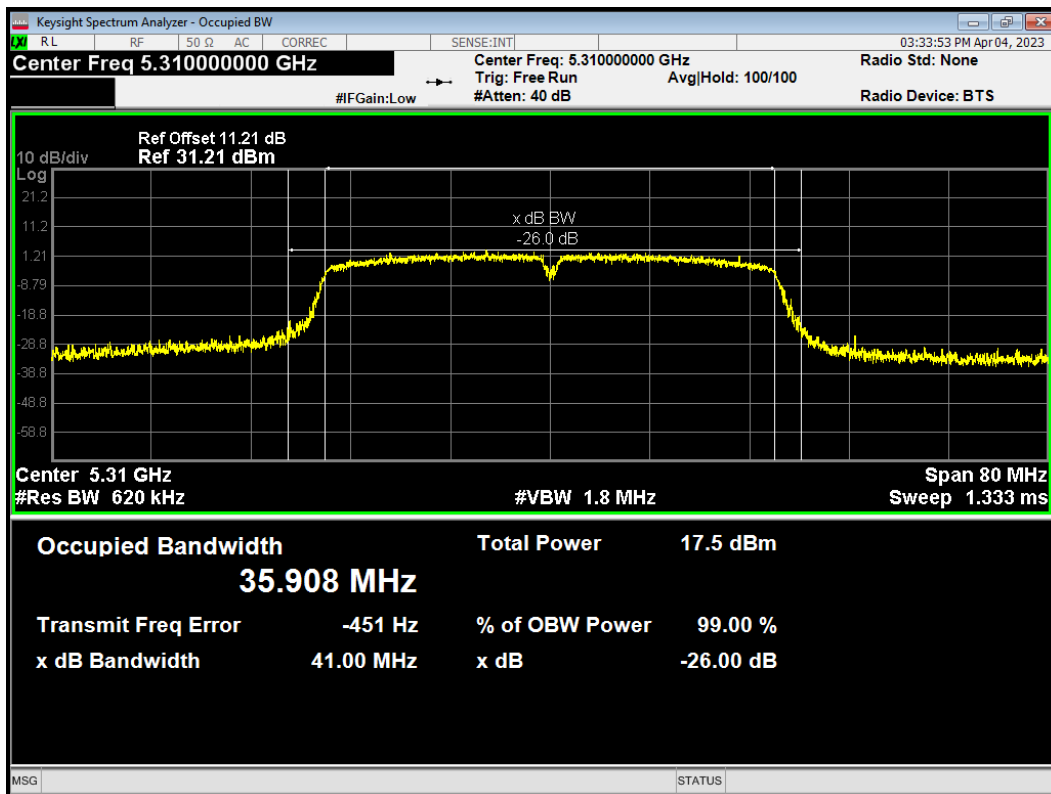

OBW 802.11ac(VHT80) 5290MHz

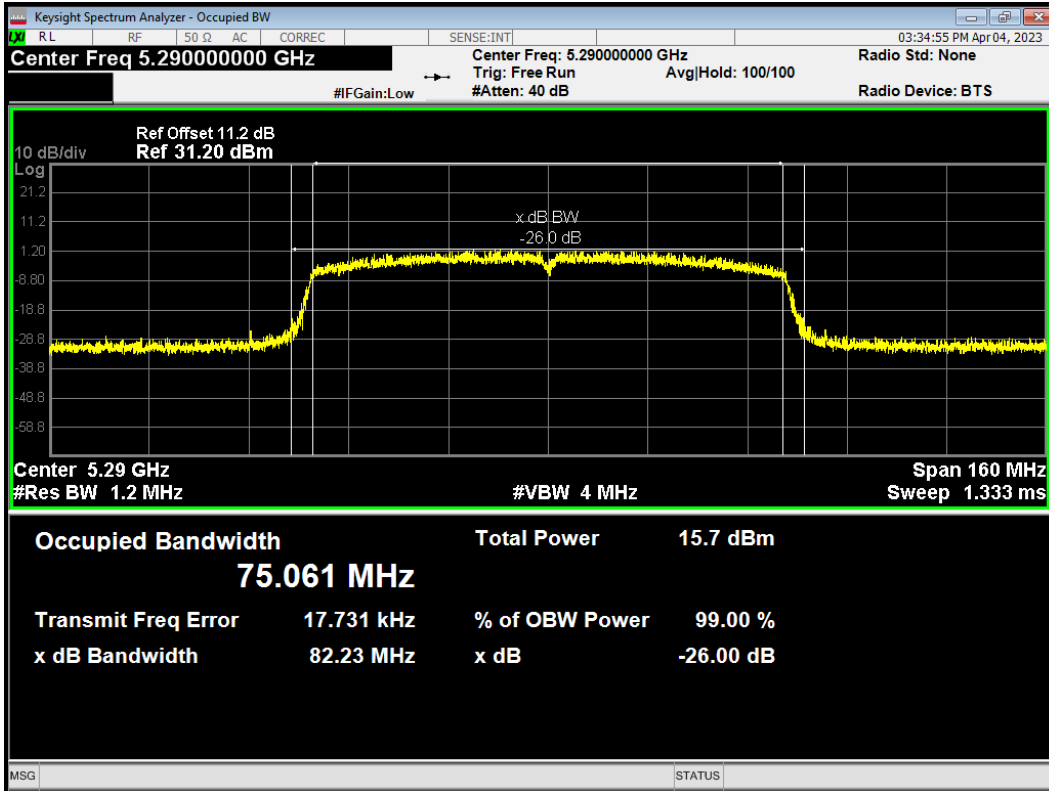

OBW 802.11n(HT20) 5260MHz

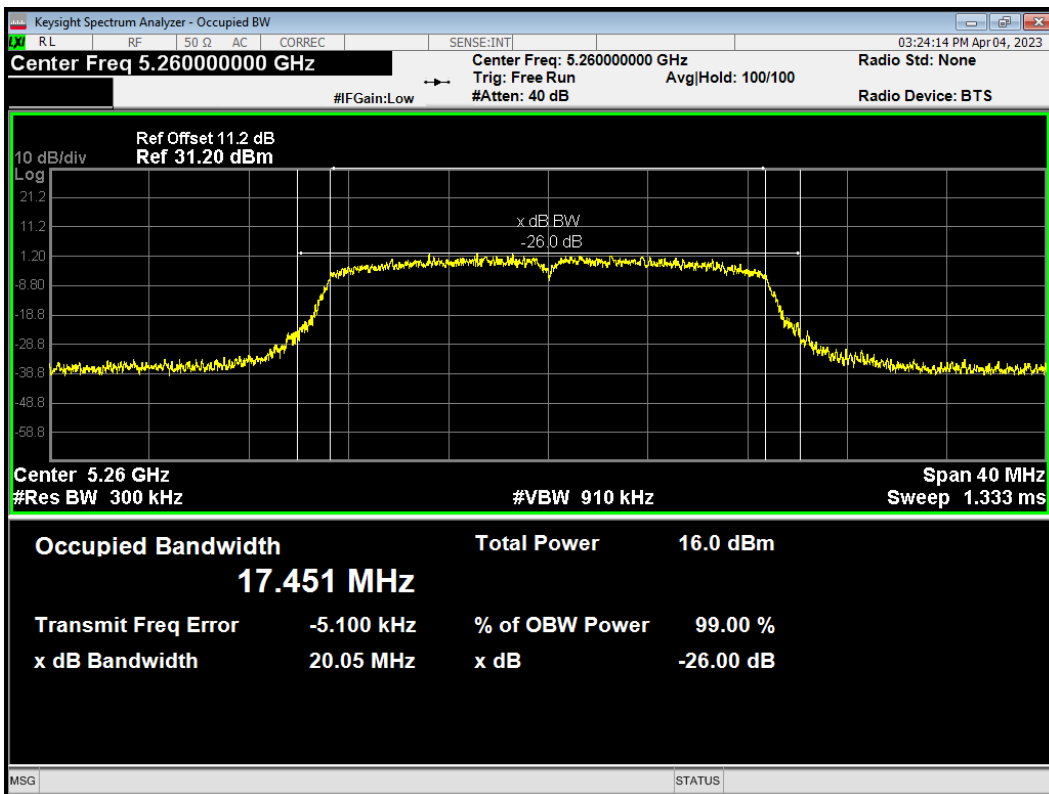

OBW 802.11n(HT20) 5300MHz

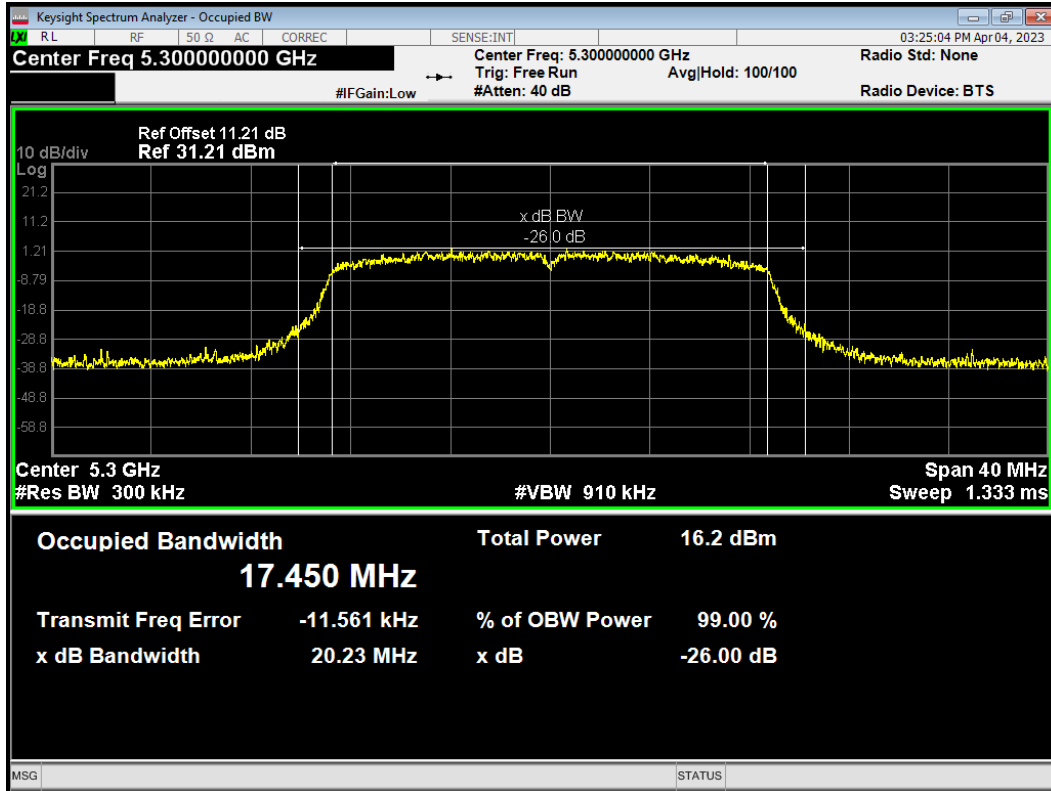

OBW 802.11n(HT20) 5320MHz

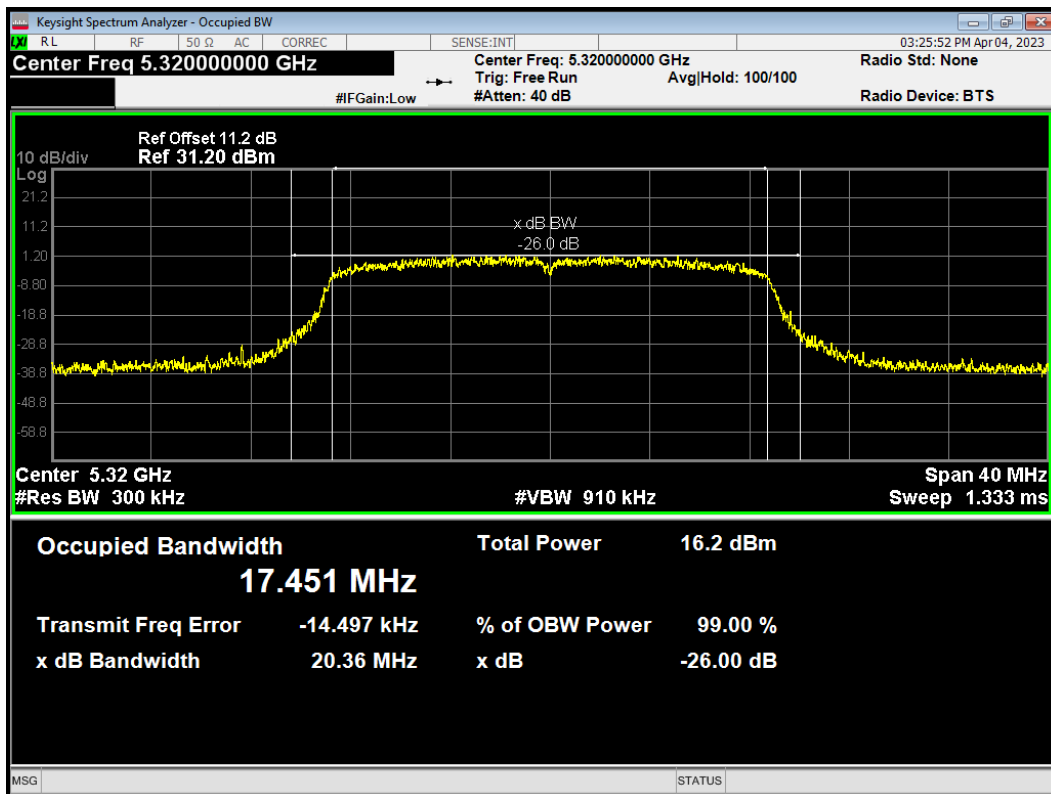

OBW 802.11n(HT40) 5270MHz

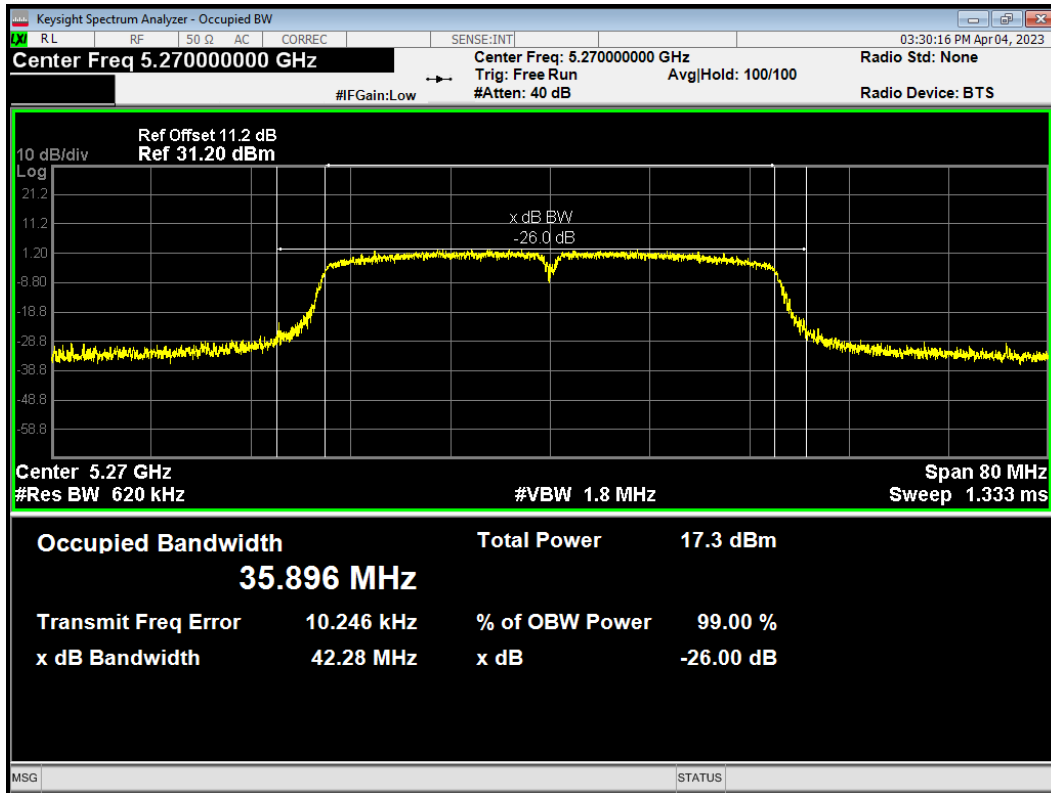

OBW 802.11n(HT40) 5310MHz

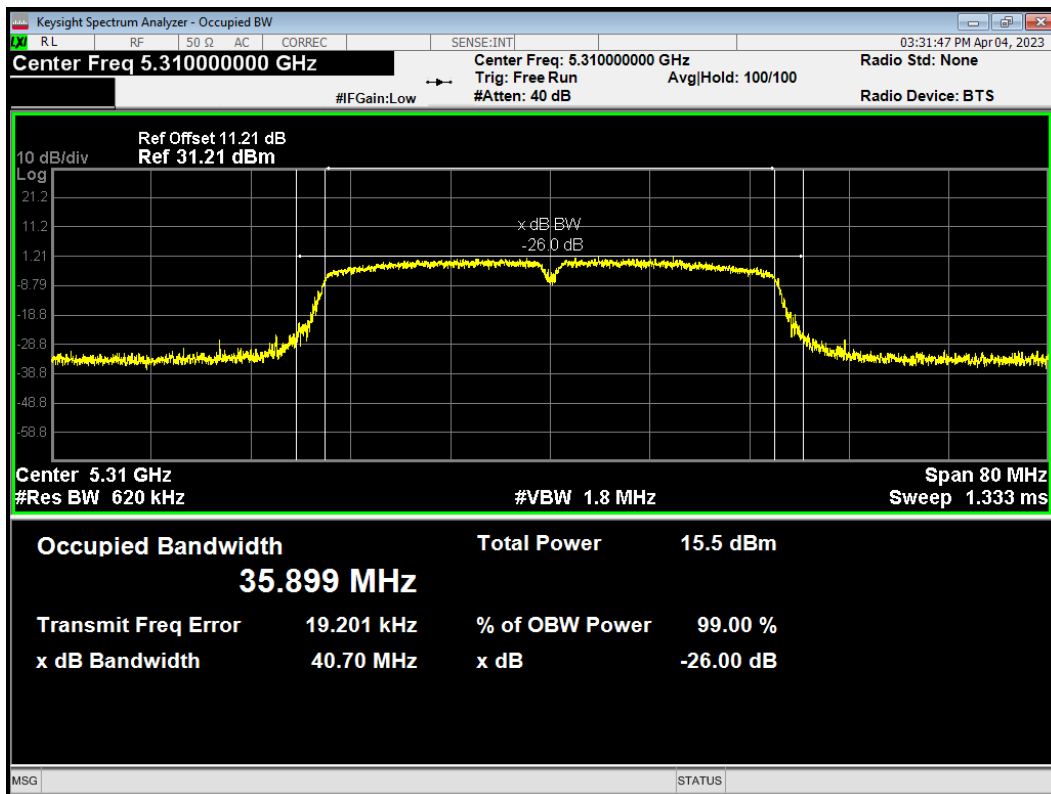

U-NII-2C

OBW 802.11a 5500MHz

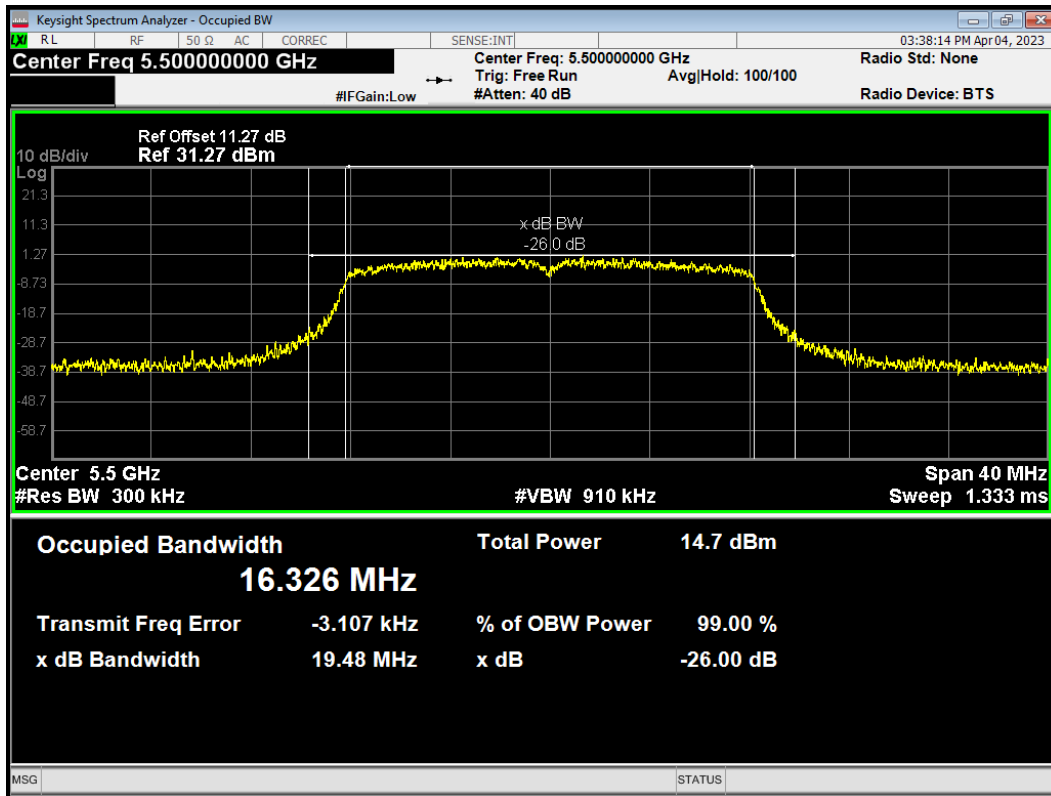

OBW 802.11a 5520MHz

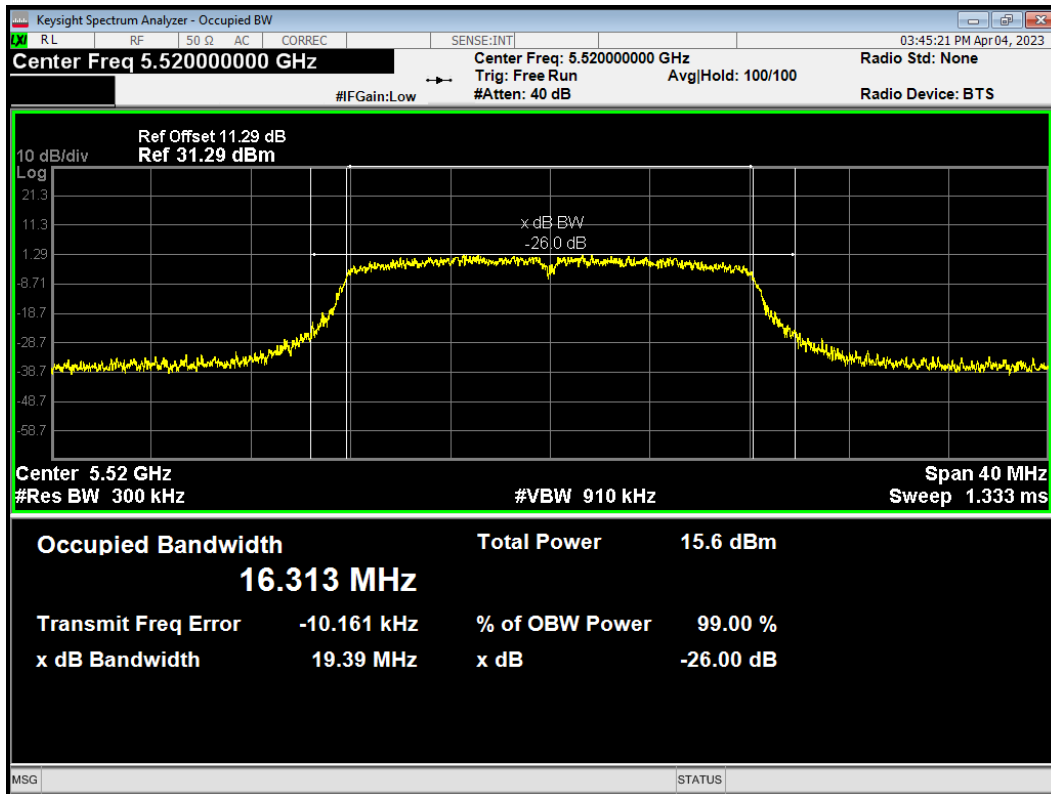

OBW 802.11a 5600MHz

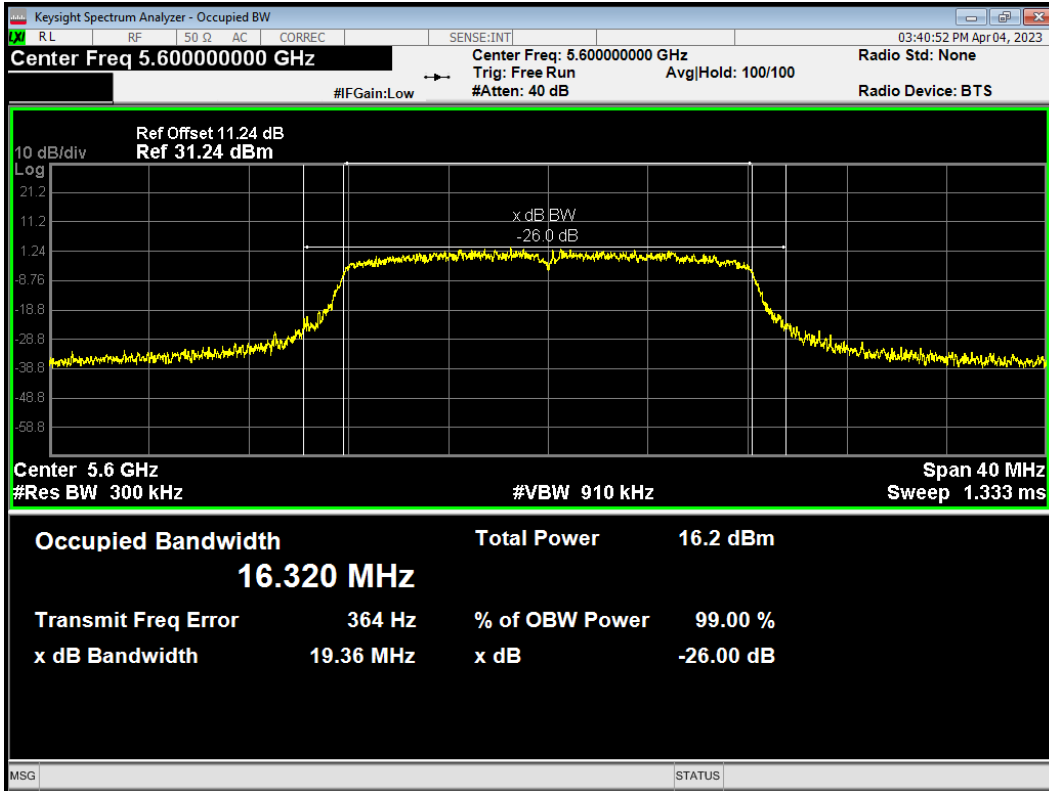

OBW 802.11a 5680MHz

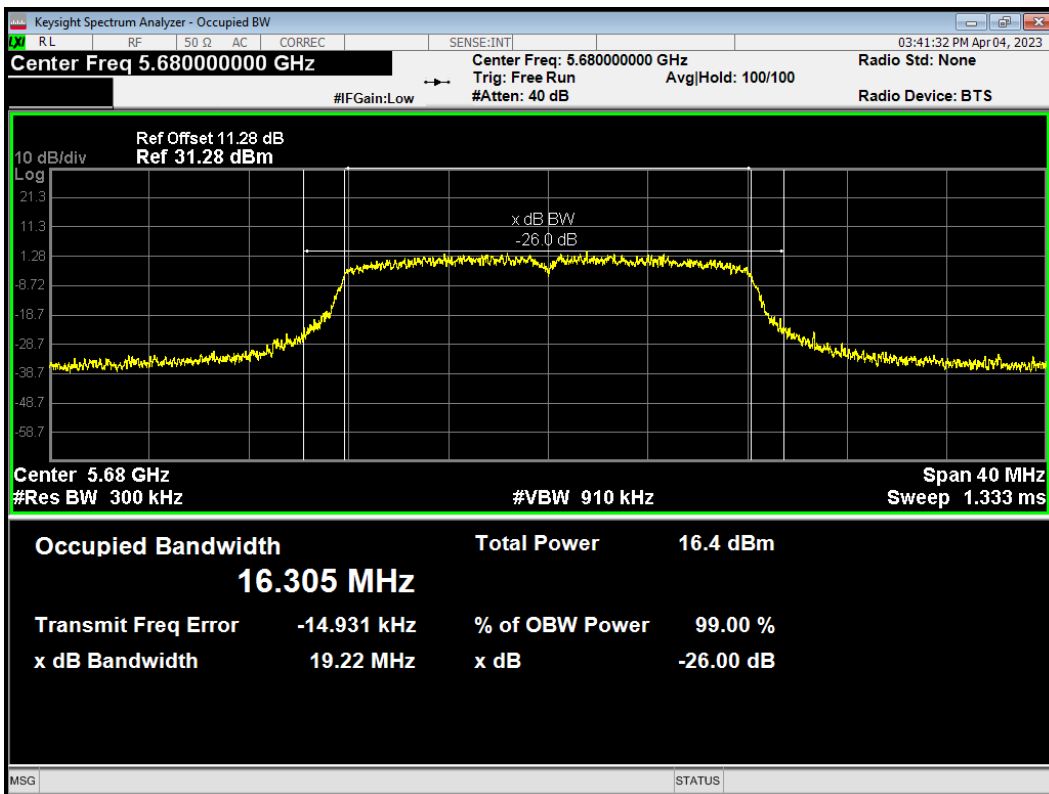

OBW 802.11a 5700MHz

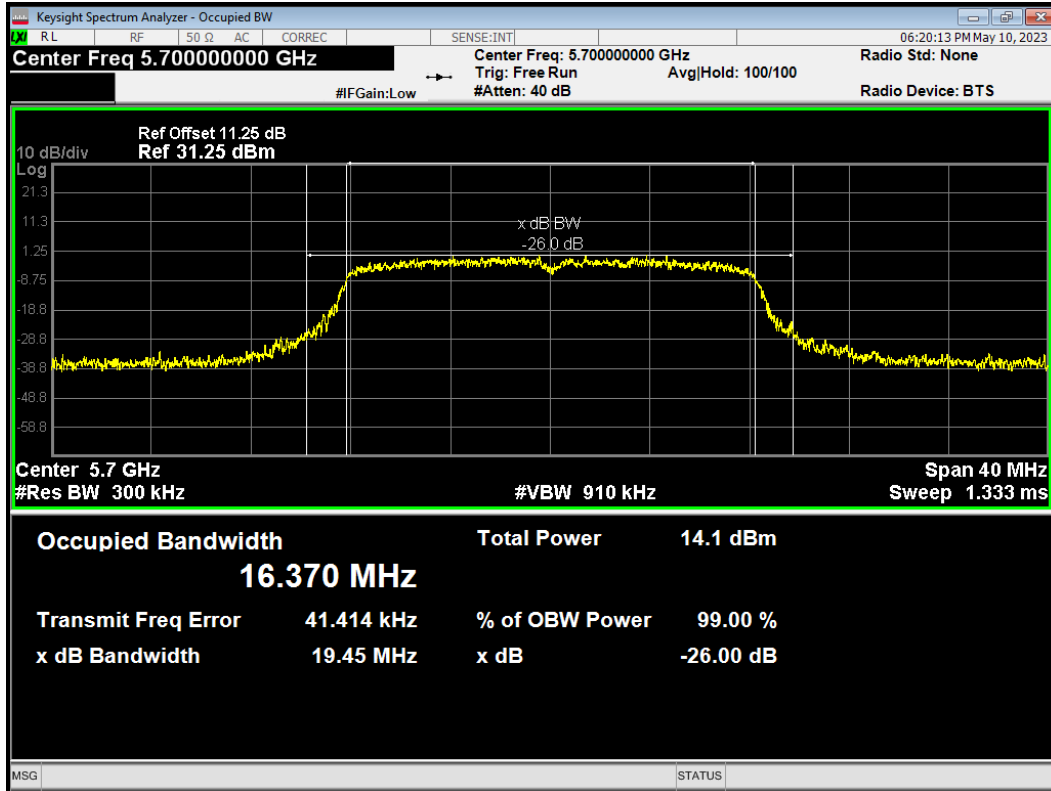

OBW 802.11ac(VHT20) 5500MHz

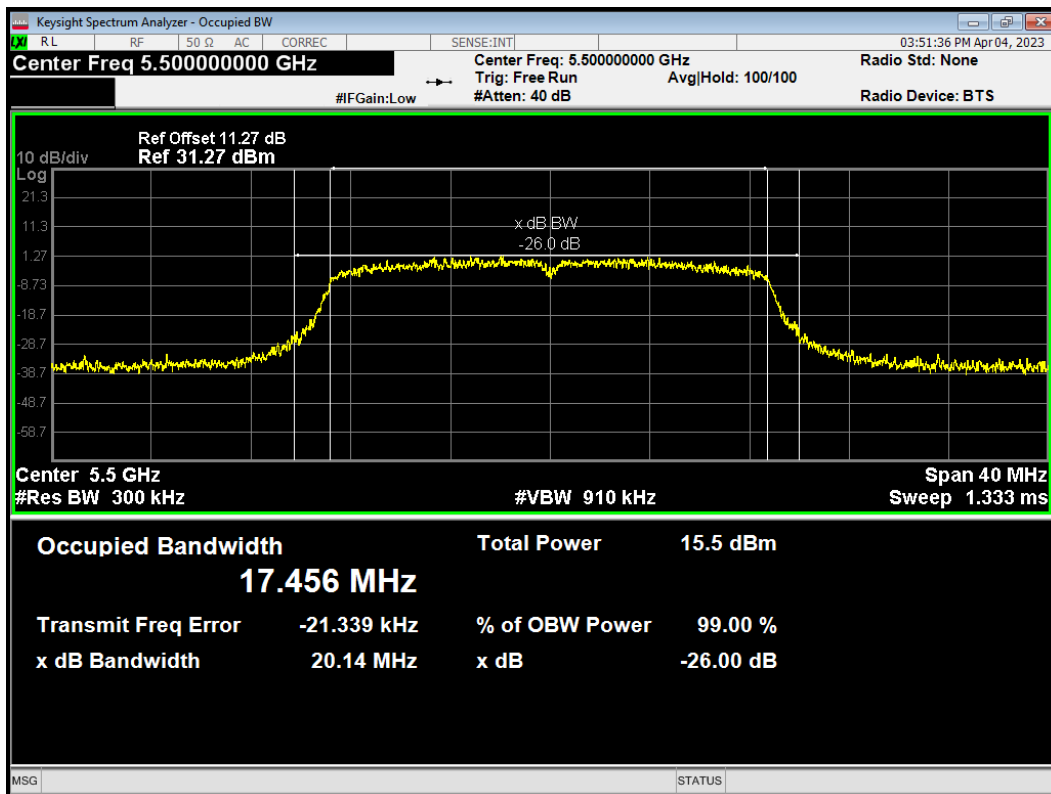

OBW 802.11ac(VHT20) 5600MHz

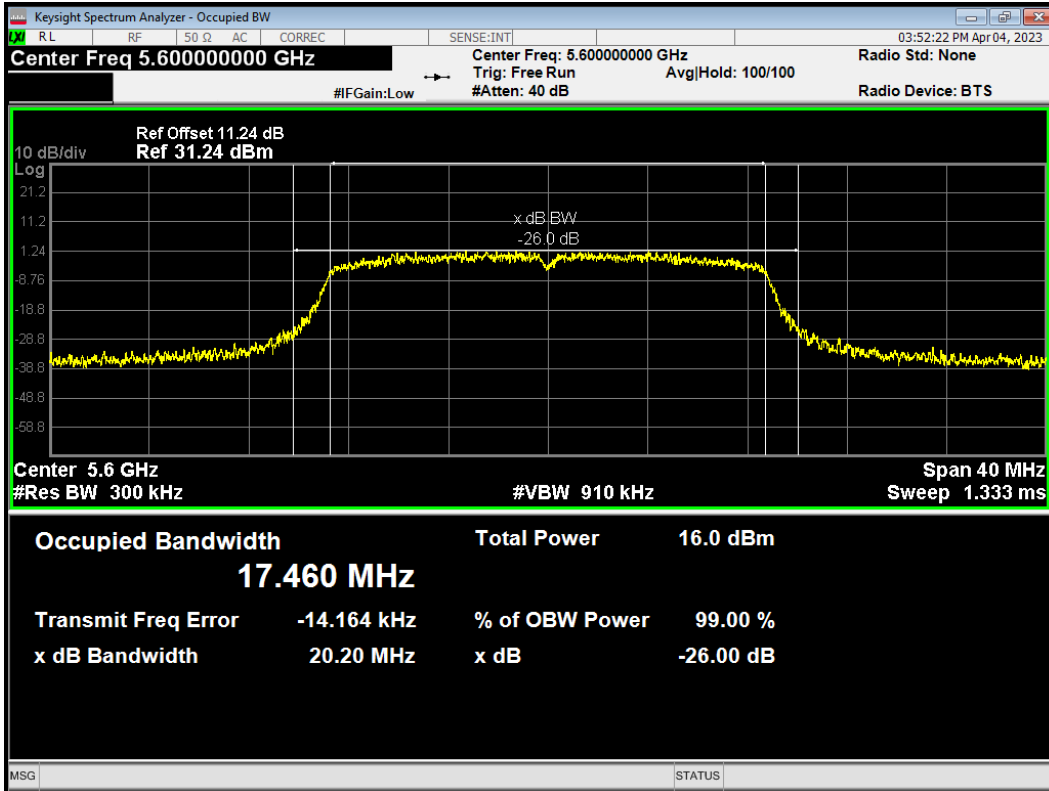

OBW 802.11ac(VHT20) 5700MHz

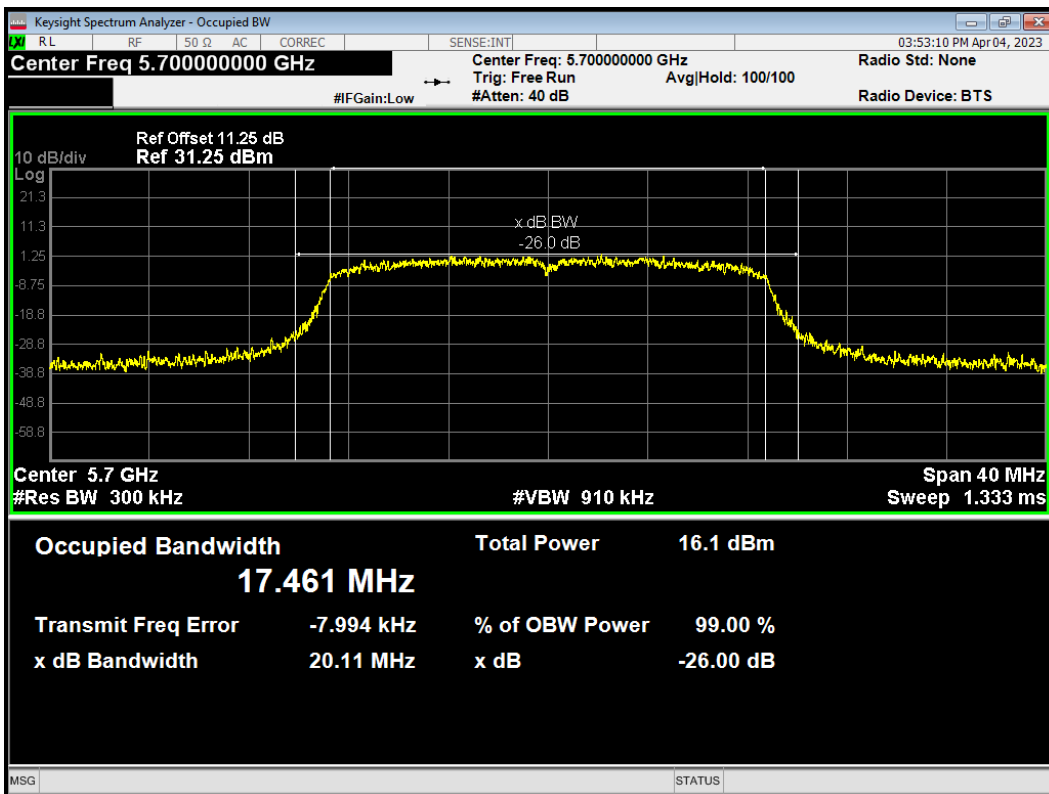

OBW 802.11ac(VHT40) 5510MHz

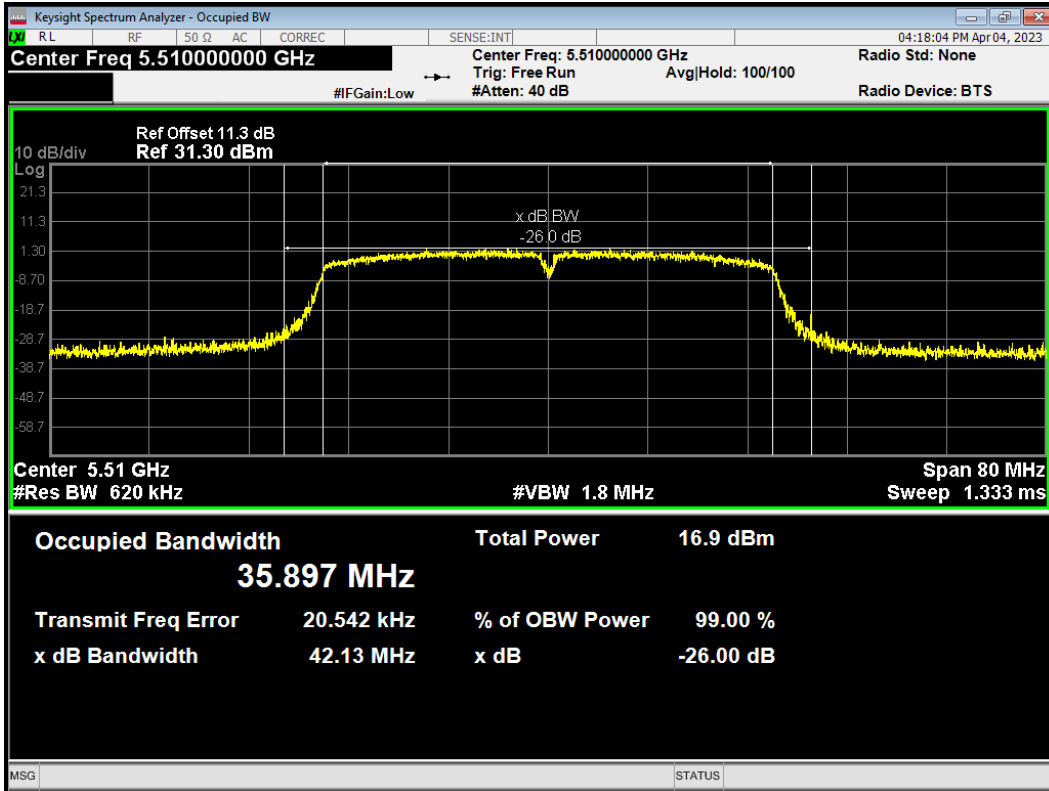

OBW 802.11ac(VHT40) 5590MHz

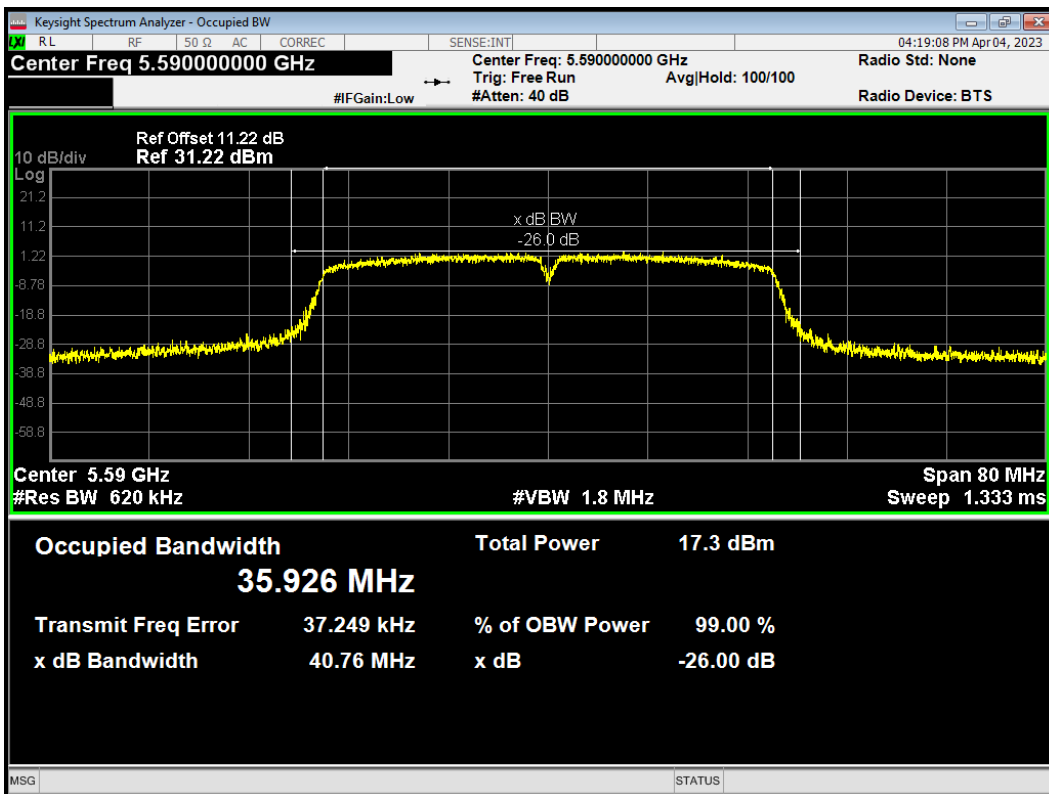

OBW 802.11ac(VHT40) 5670MHz

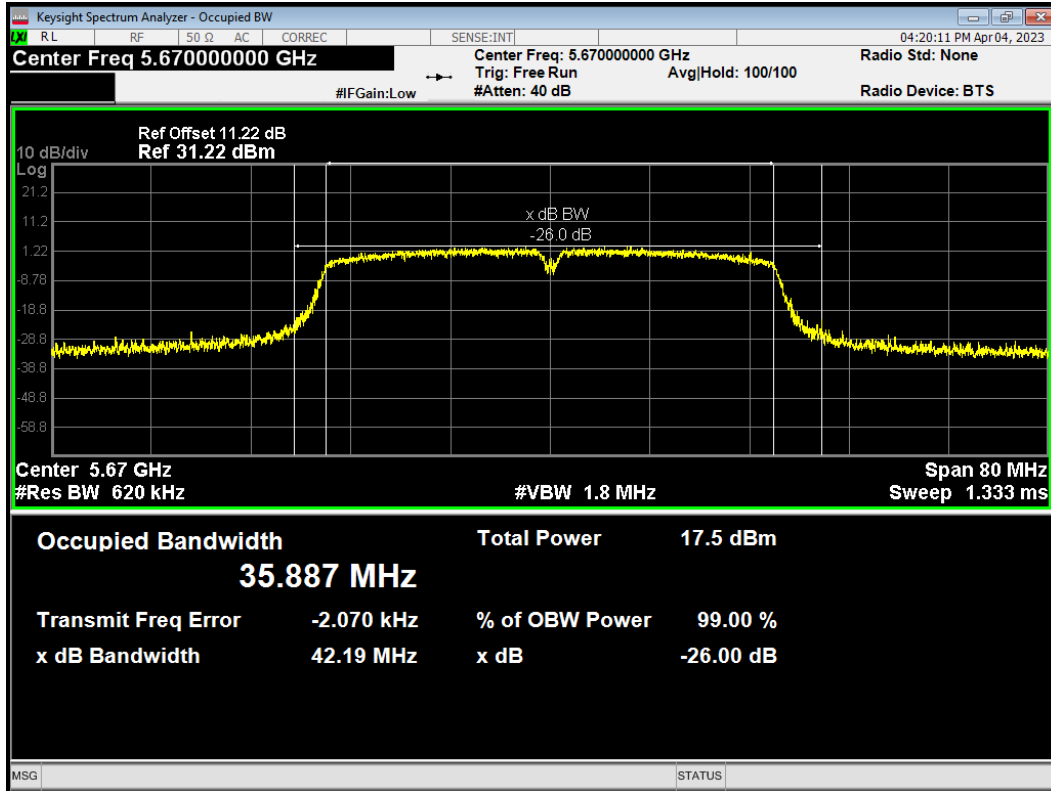

OBW 802.11ac(VHT80) 5530MHz

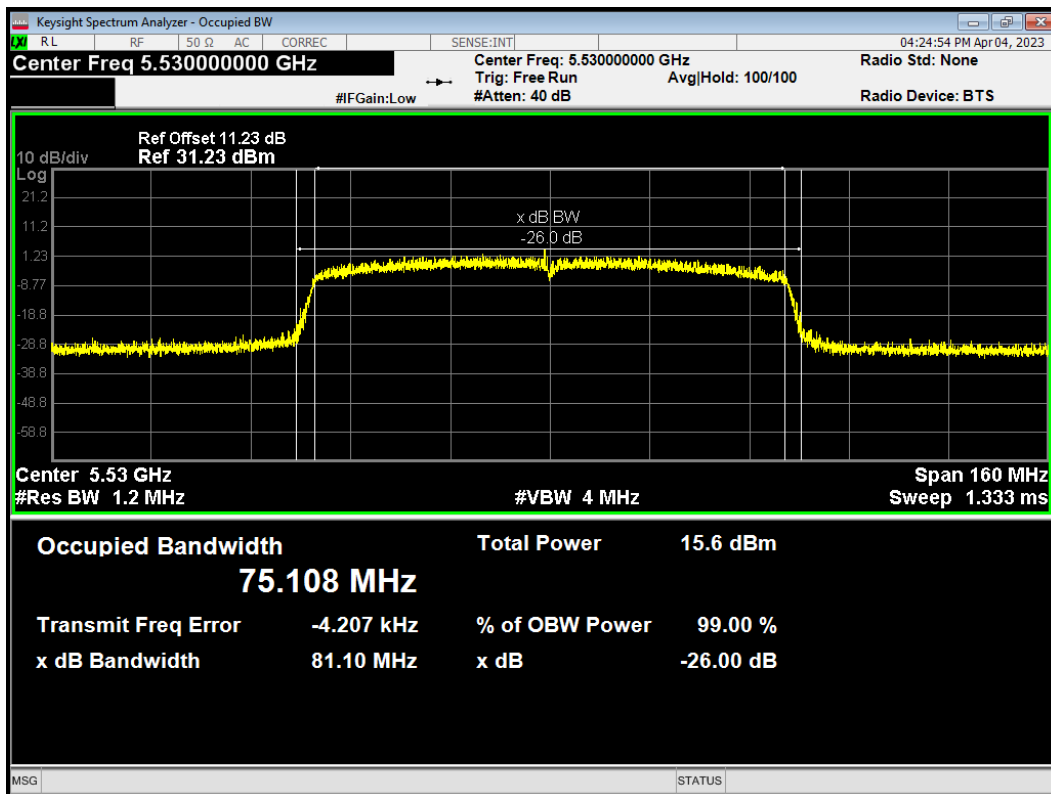

OBW 802.11ac(VHT80) 5610MHz

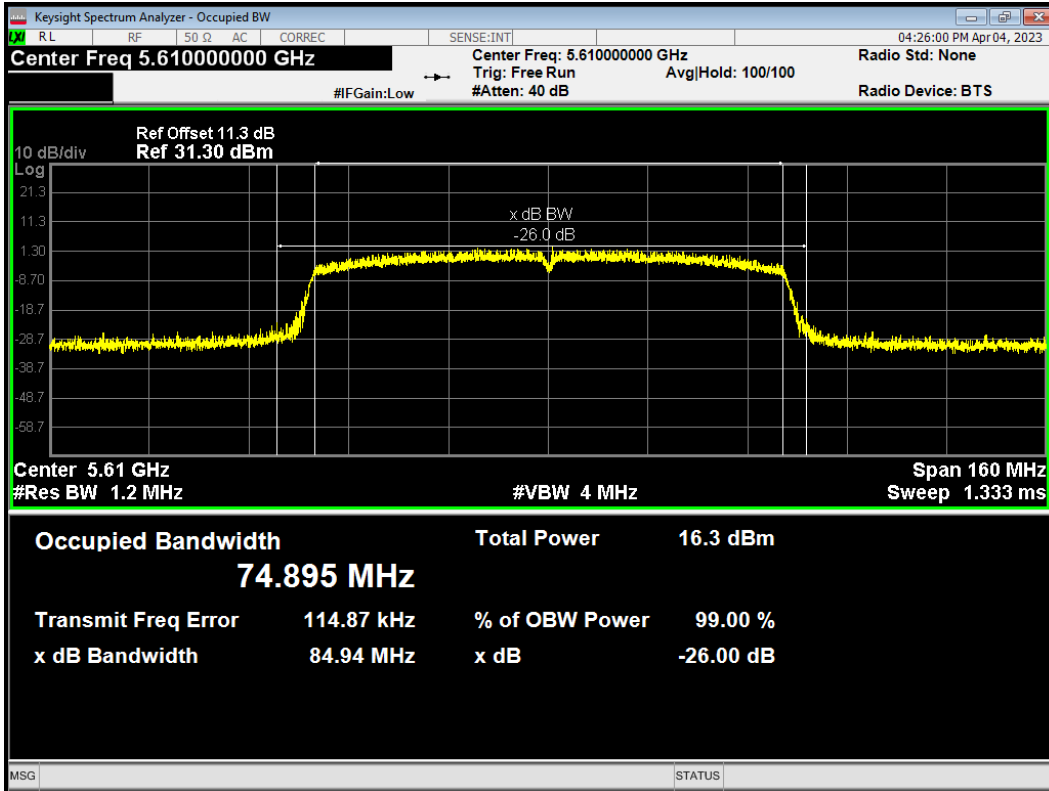

OBW 802.11n(HT20) 5500MHz

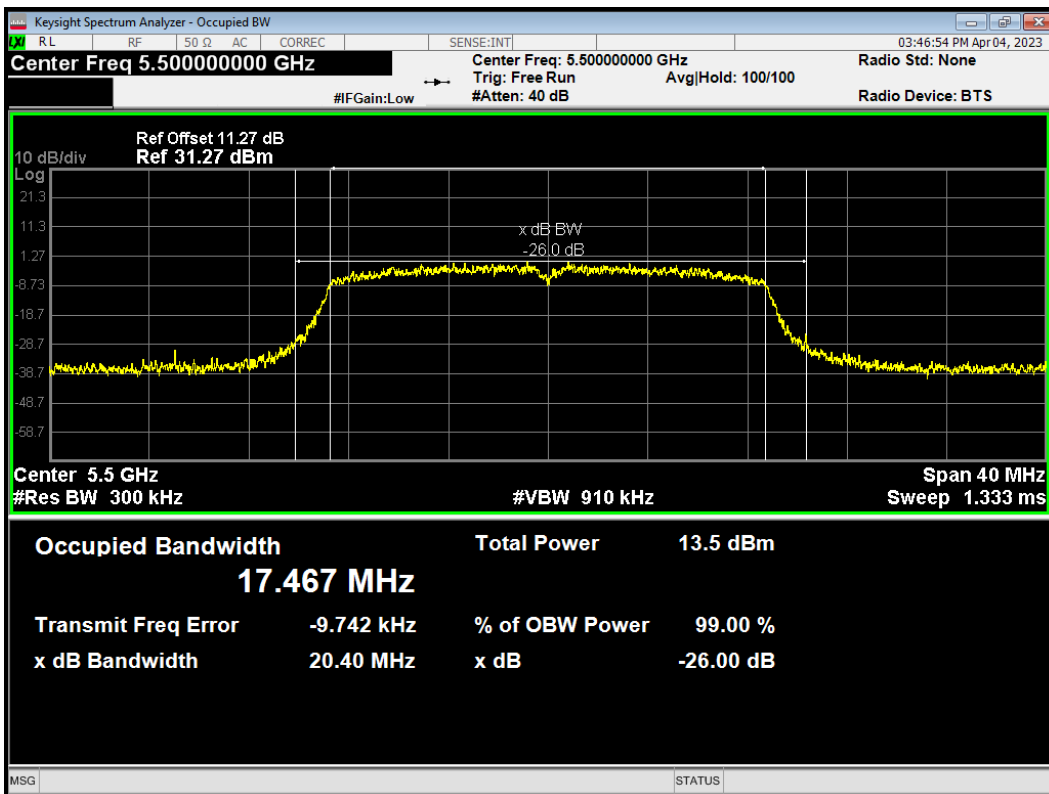

OBW 802.11n(HT20) 5520MHz

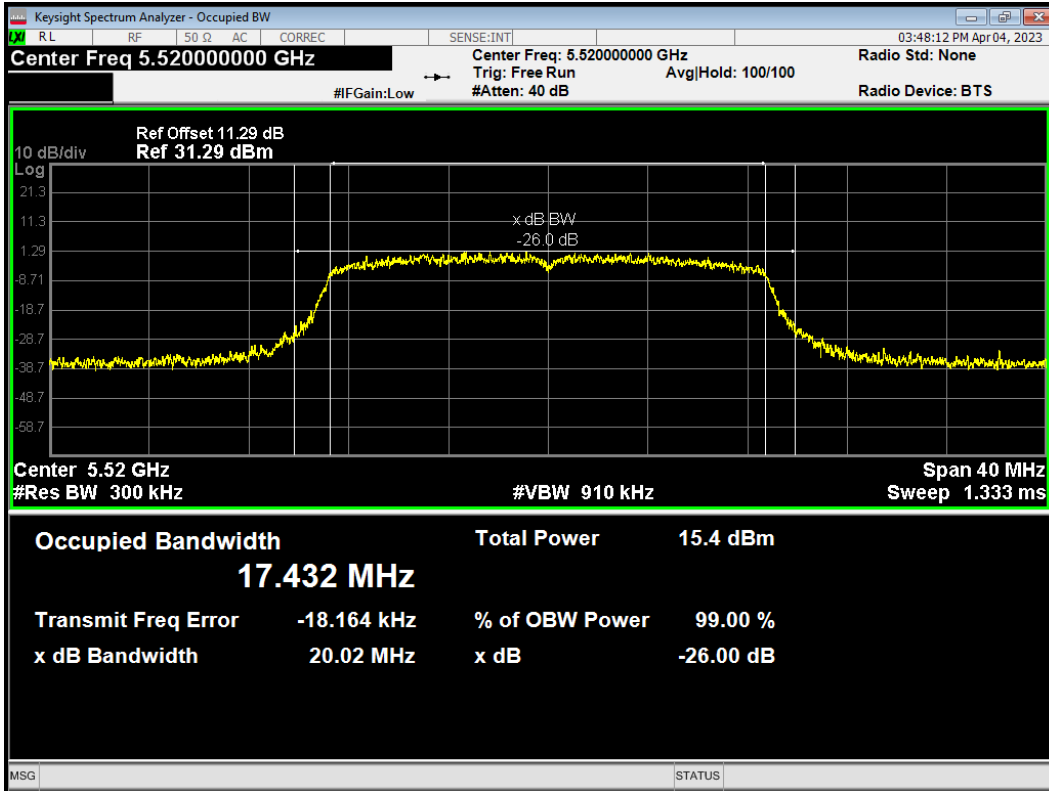

OBW 802.11n(HT20) 5600MHz

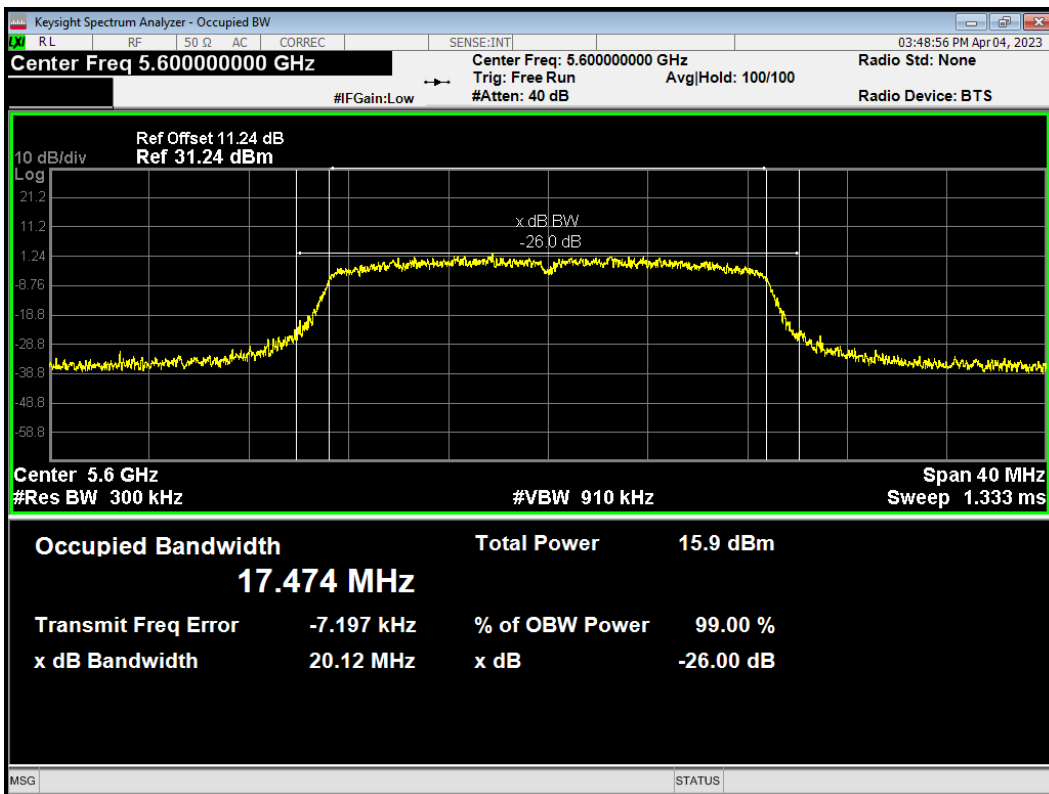

OBW 802.11n(HT20) 5680MHz

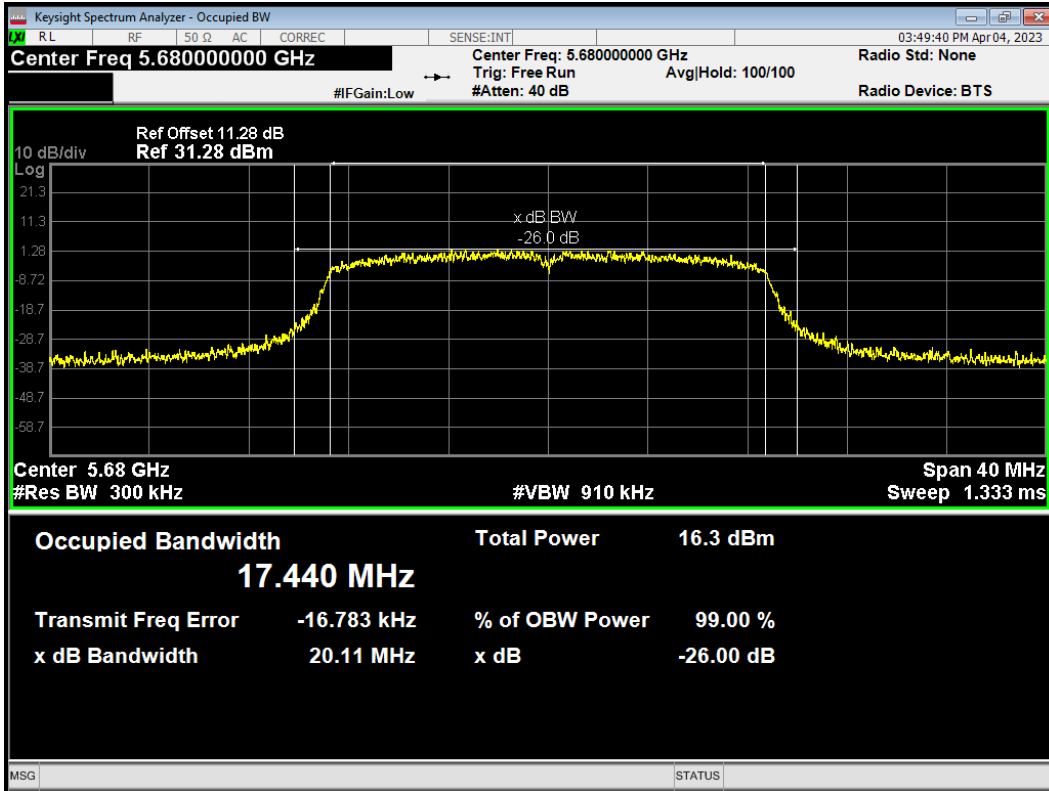

OBW 802.11n(HT20) 5700MHz

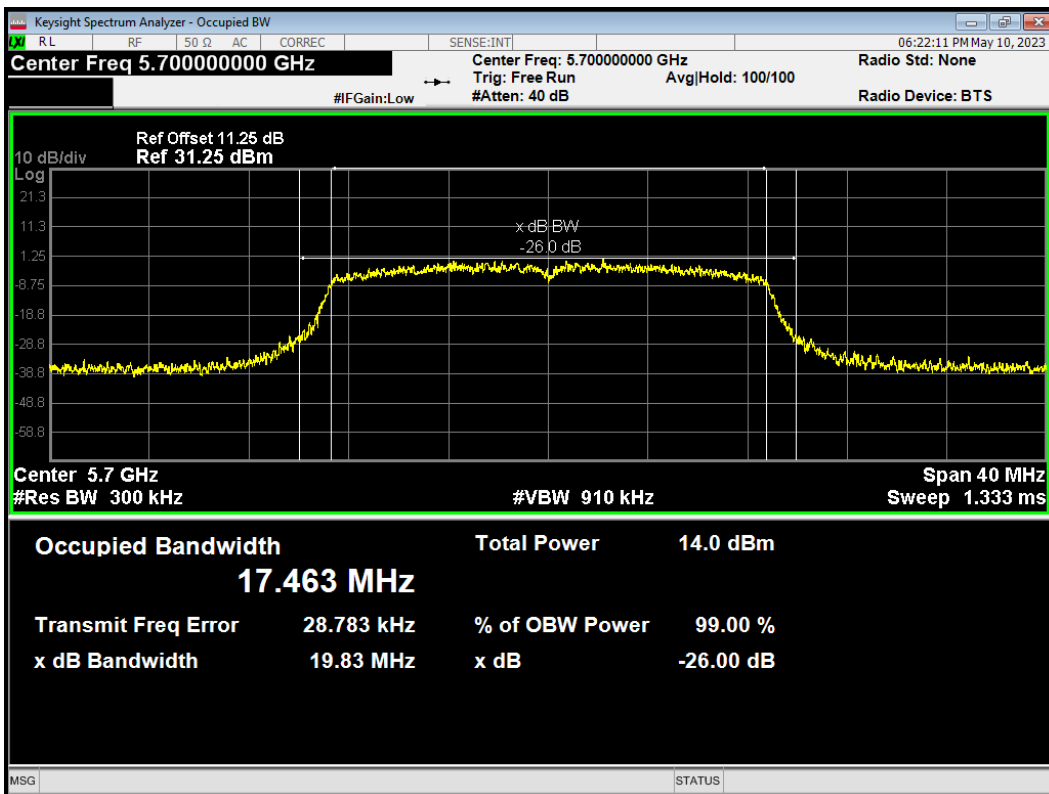

OBW 802.11n(HT40) 5510MHz

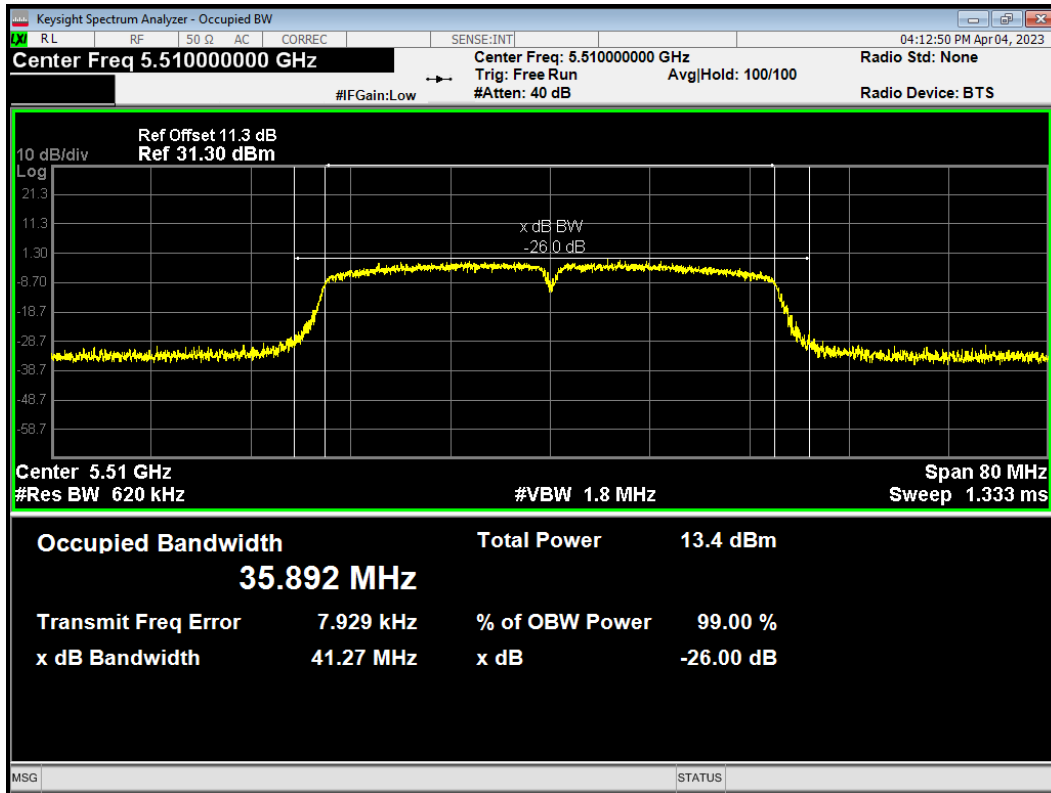

OBW 802.11n(HT40) 5550MHz

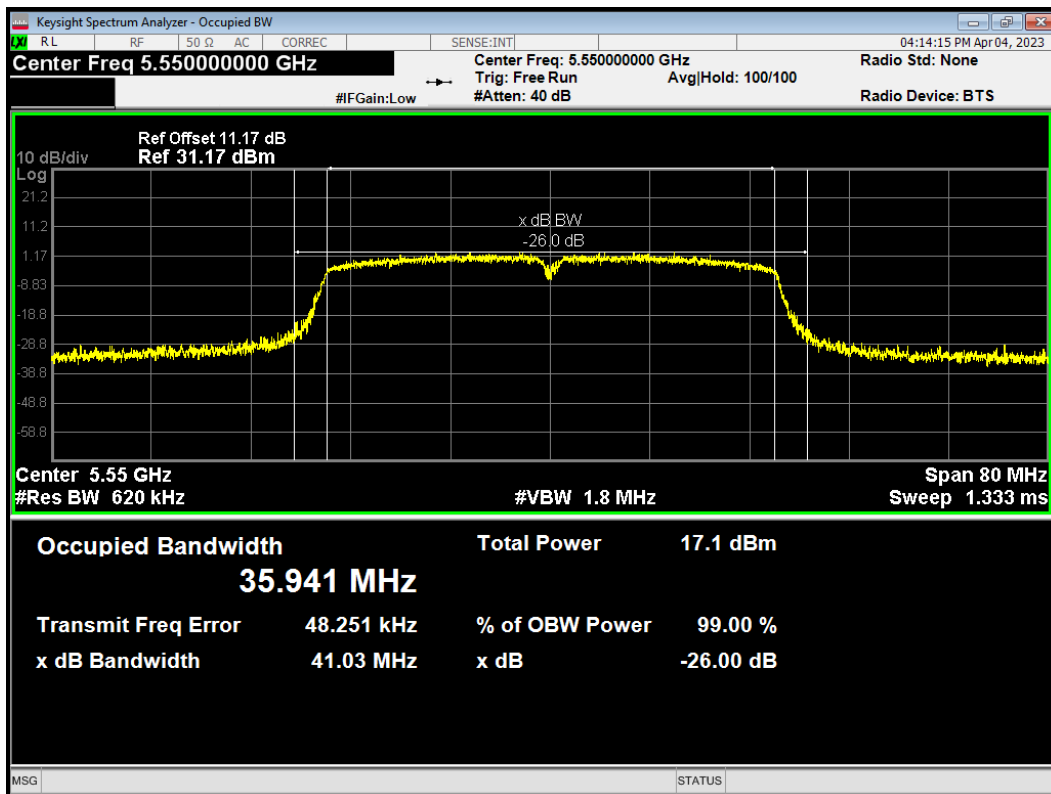

OBW 802.11n(HT40) 5590MHz

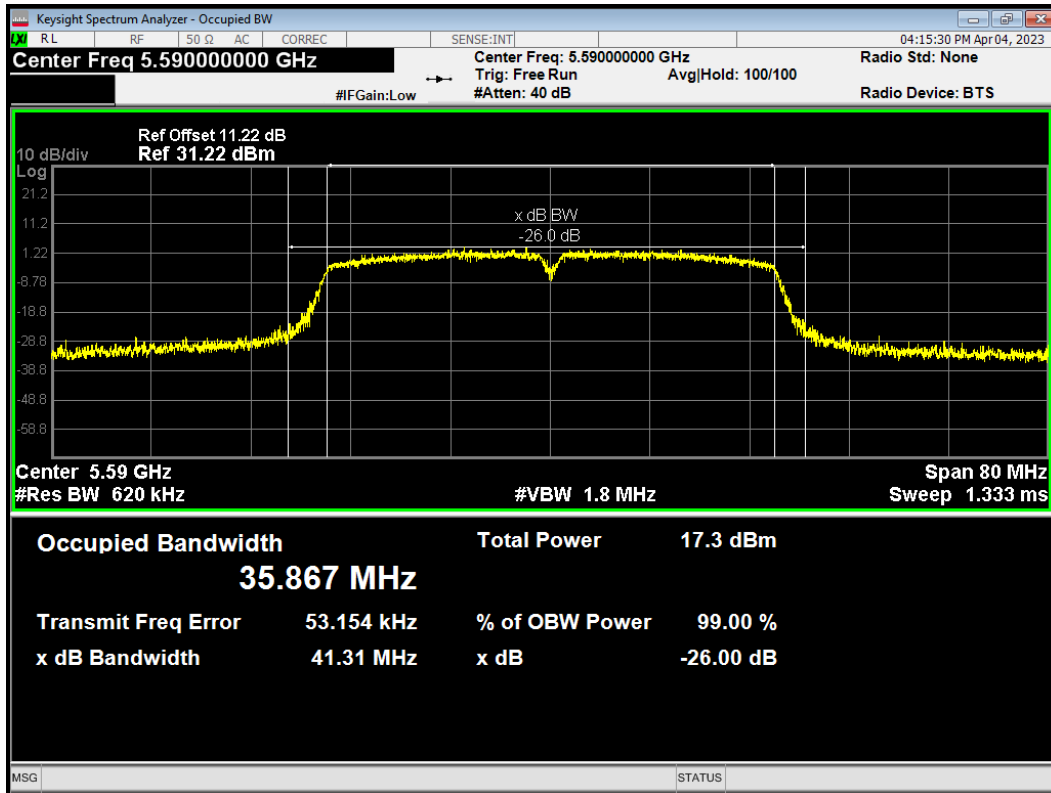

OBW 802.11n(HT40) 5670MHz

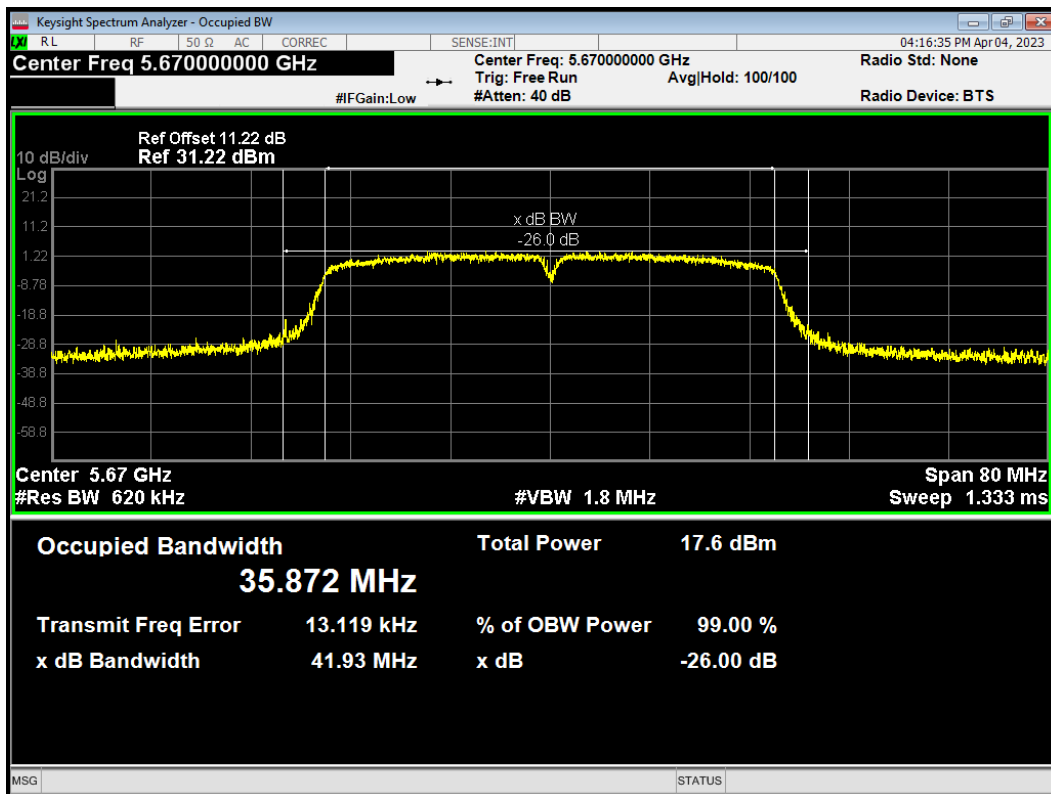

U-NII-3

OBW 802.11a 5745MHz

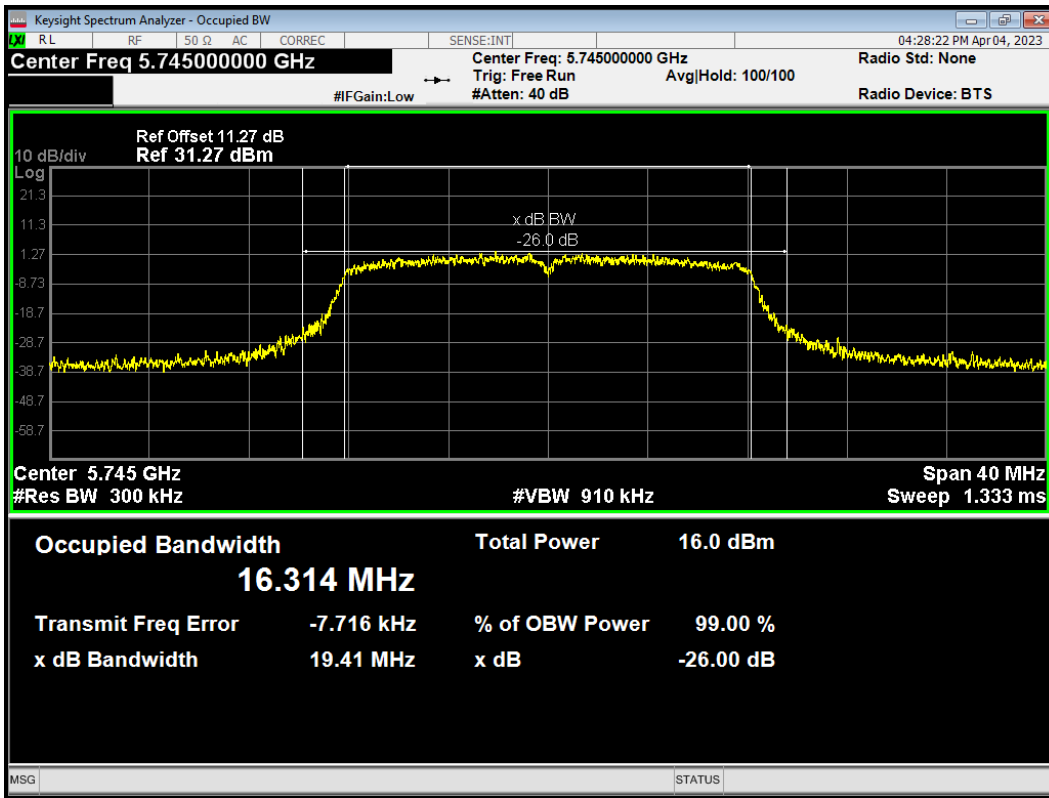

OBW 802.11a 5785MHz

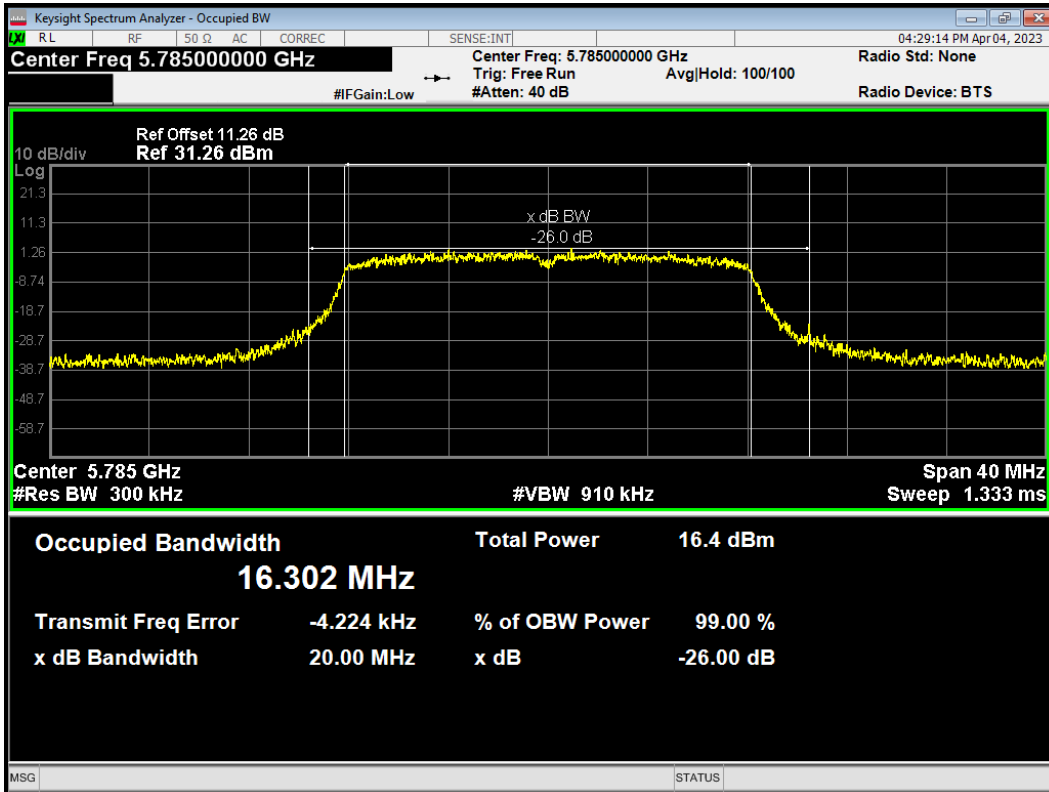

OBW 802.11a 5825MHz

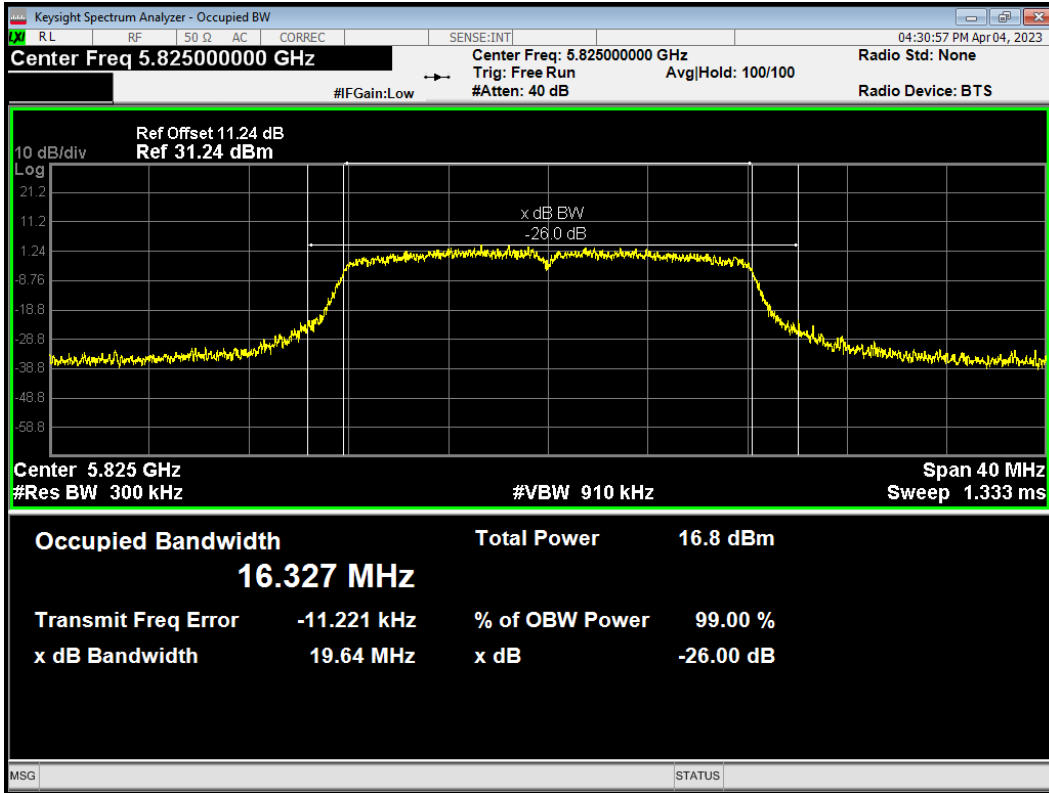

OBW 802.11ac(VHT20) 5745MHz

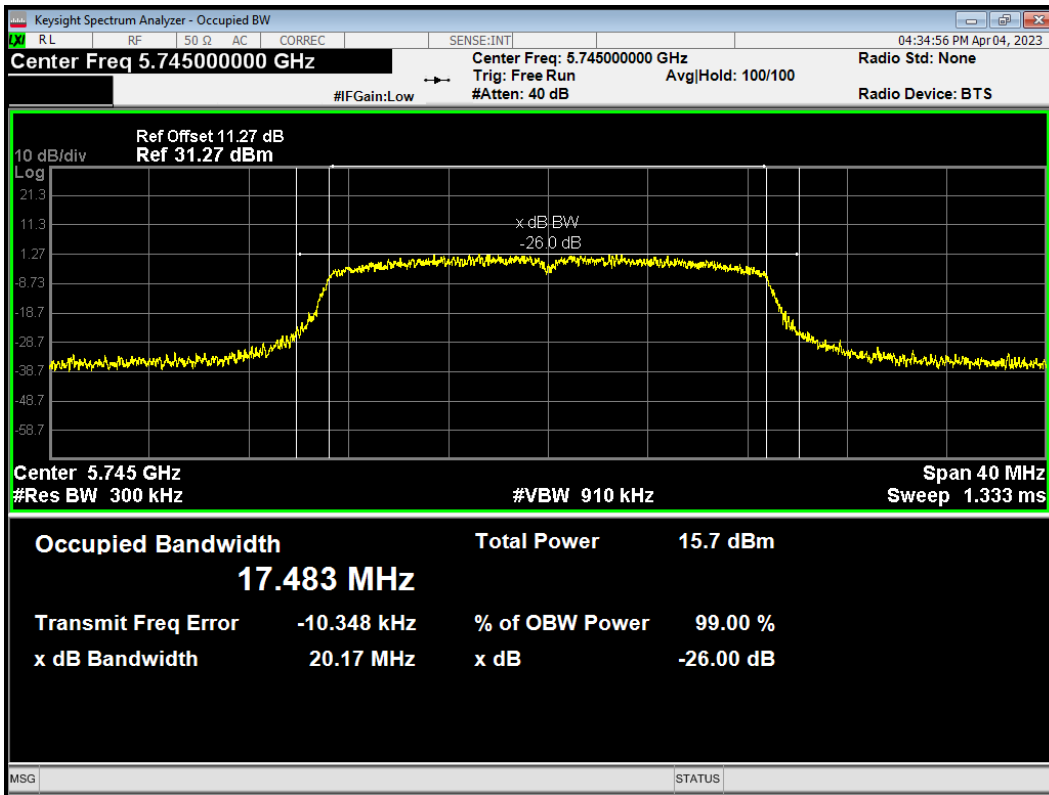

OBW 802.11ac(VHT20) 5785MHz

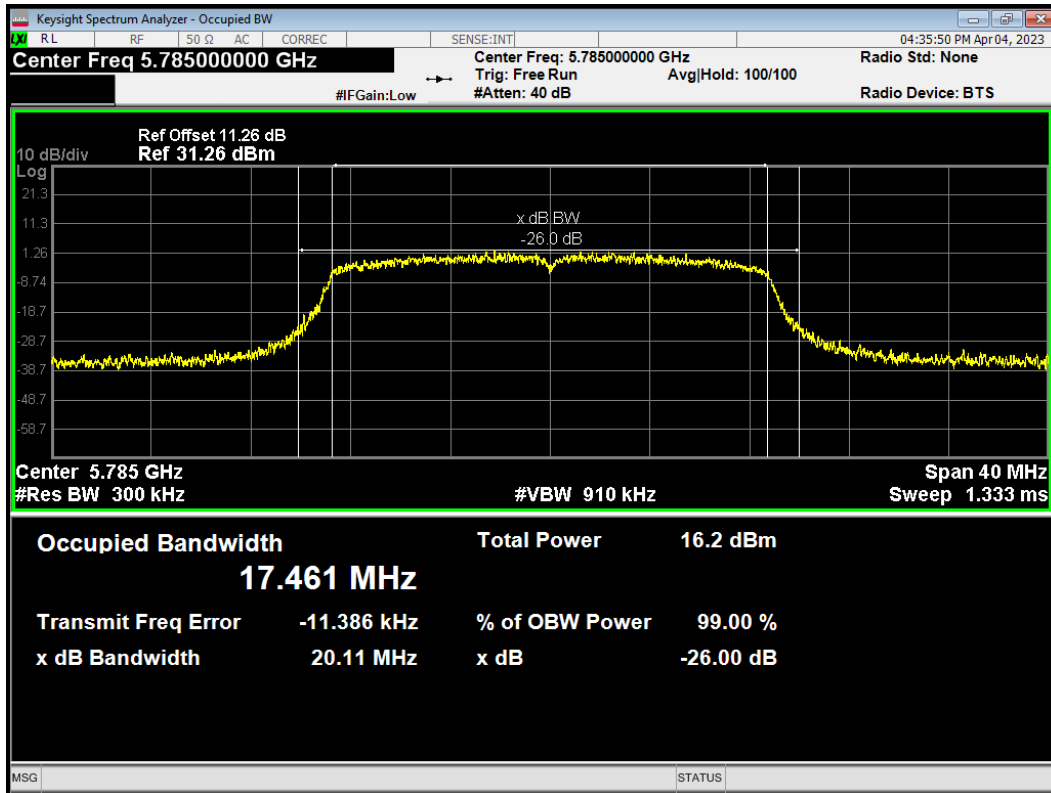

OBW 802.11ac(VHT20) 5825MHz

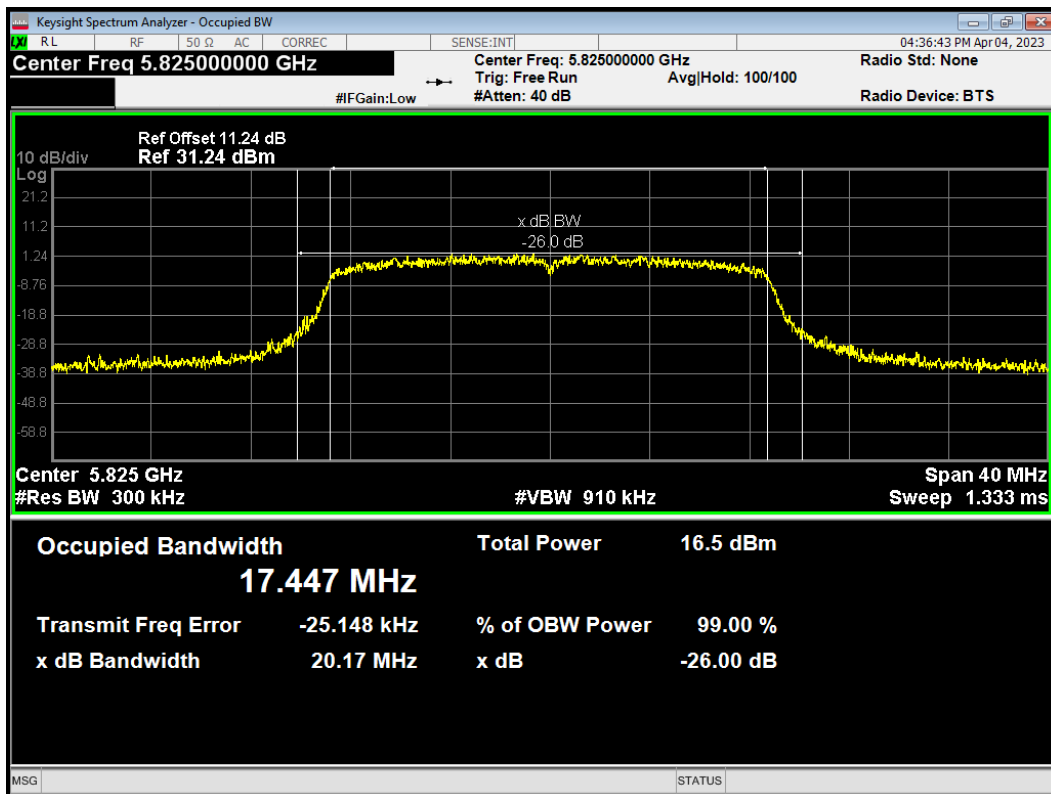

OBW 802.11ac(VHT40) 5755MHz

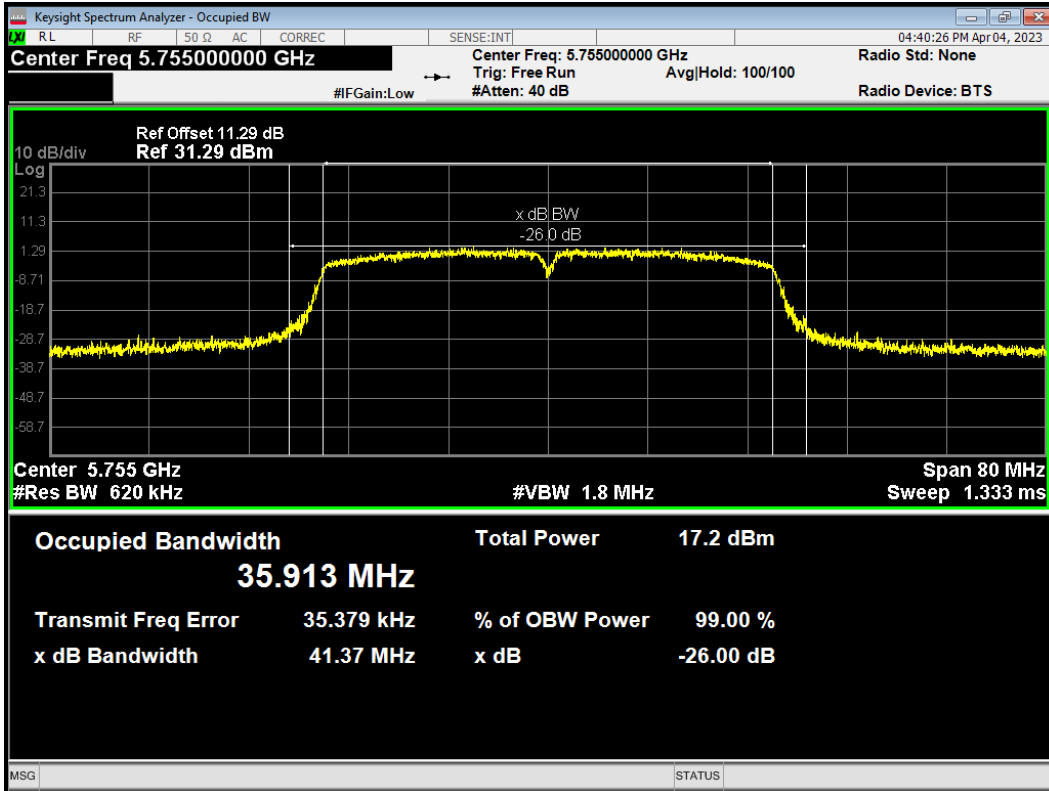

OBW 802.11ac(VHT40) 5795MHz

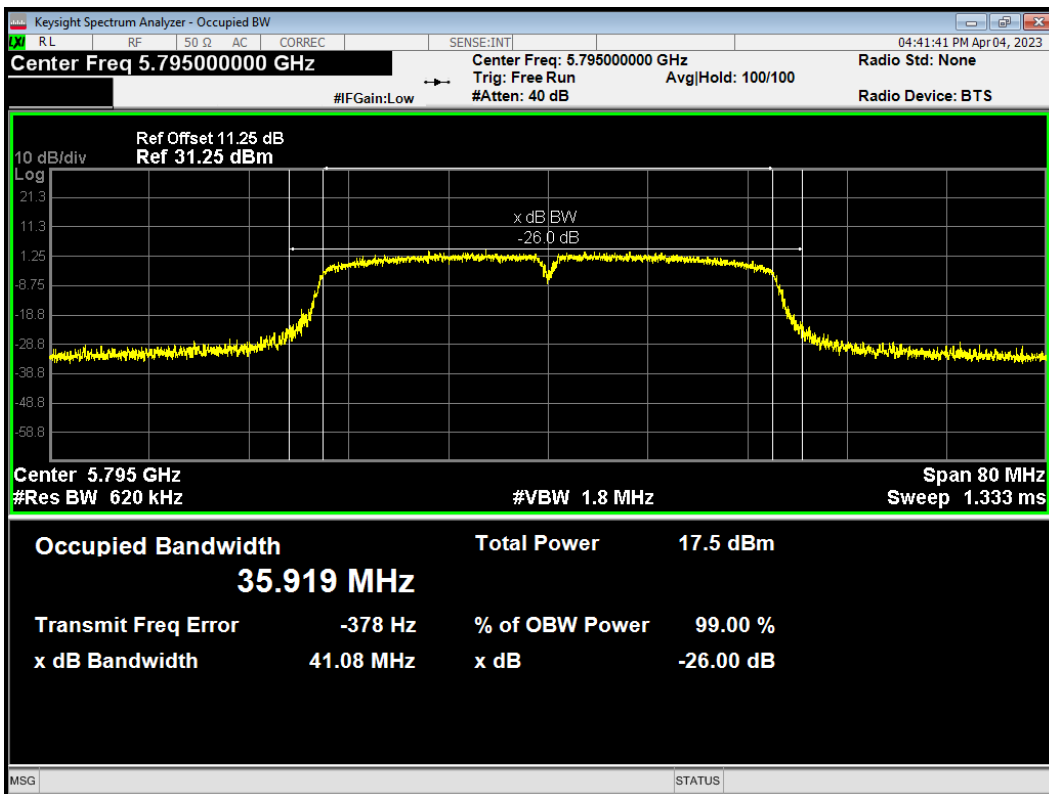

OBW 802.11ac(VHT80) 5775MHz

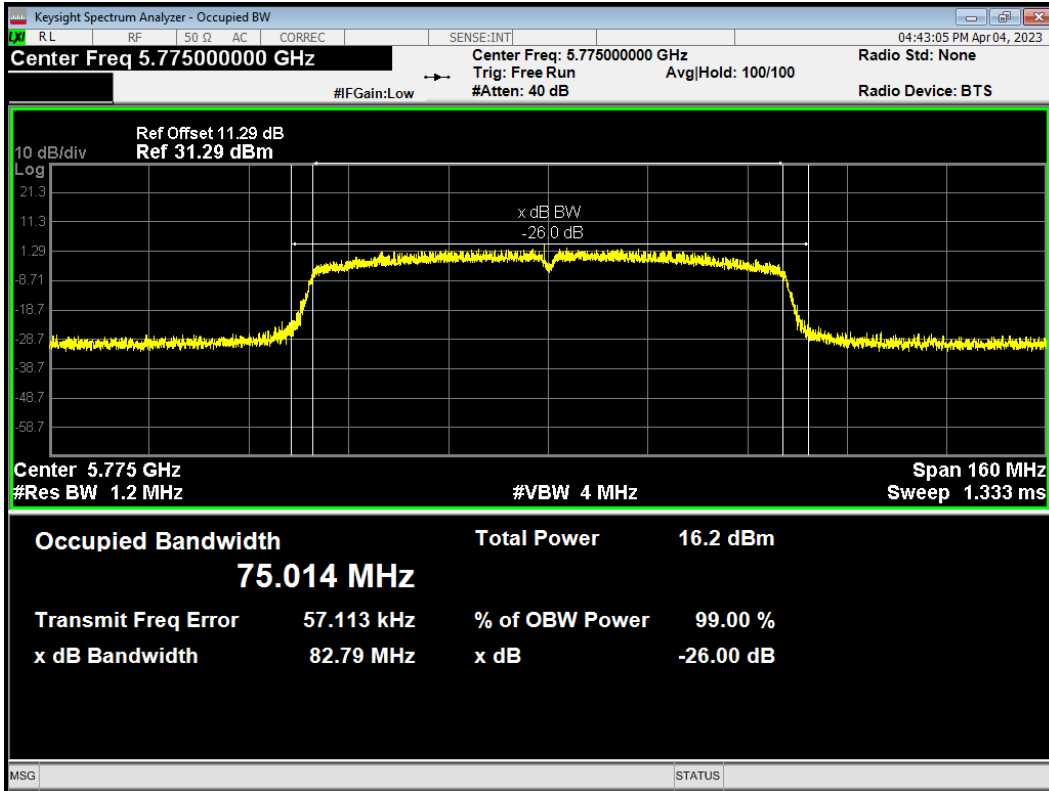

OBW 802.11n(HT20) 5745MHz

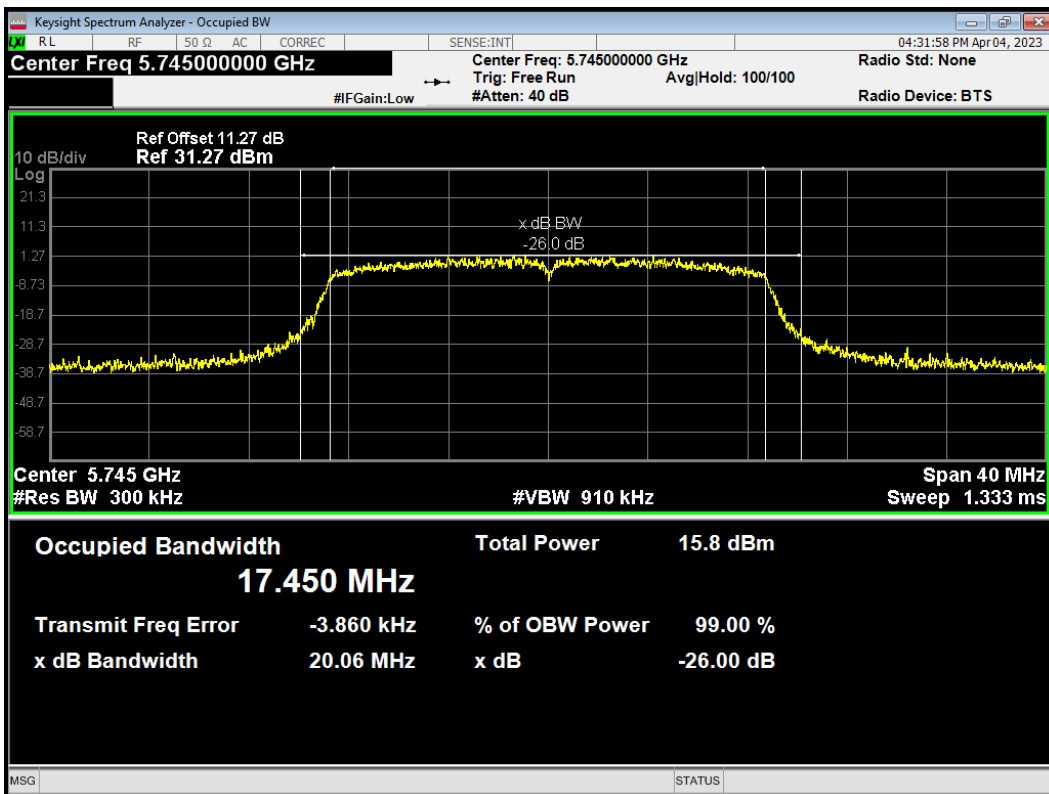

OBW 802.11n(HT20) 5785MHz

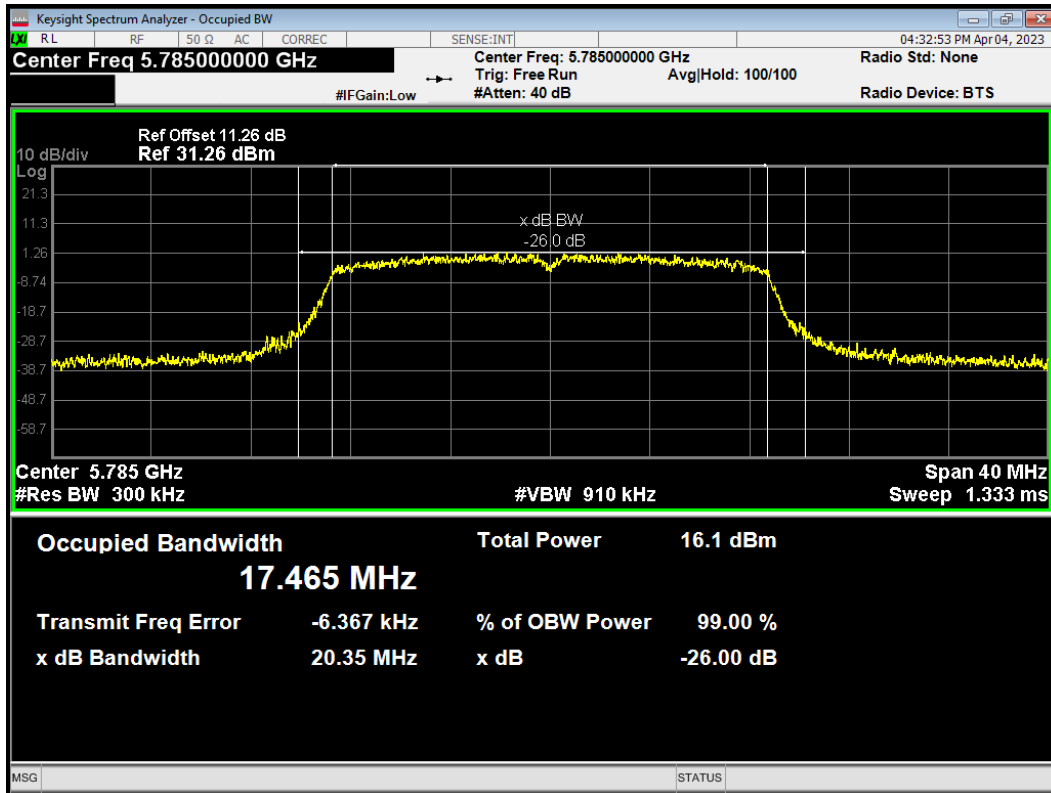

OBW 802.11n(HT20) 5825MHz

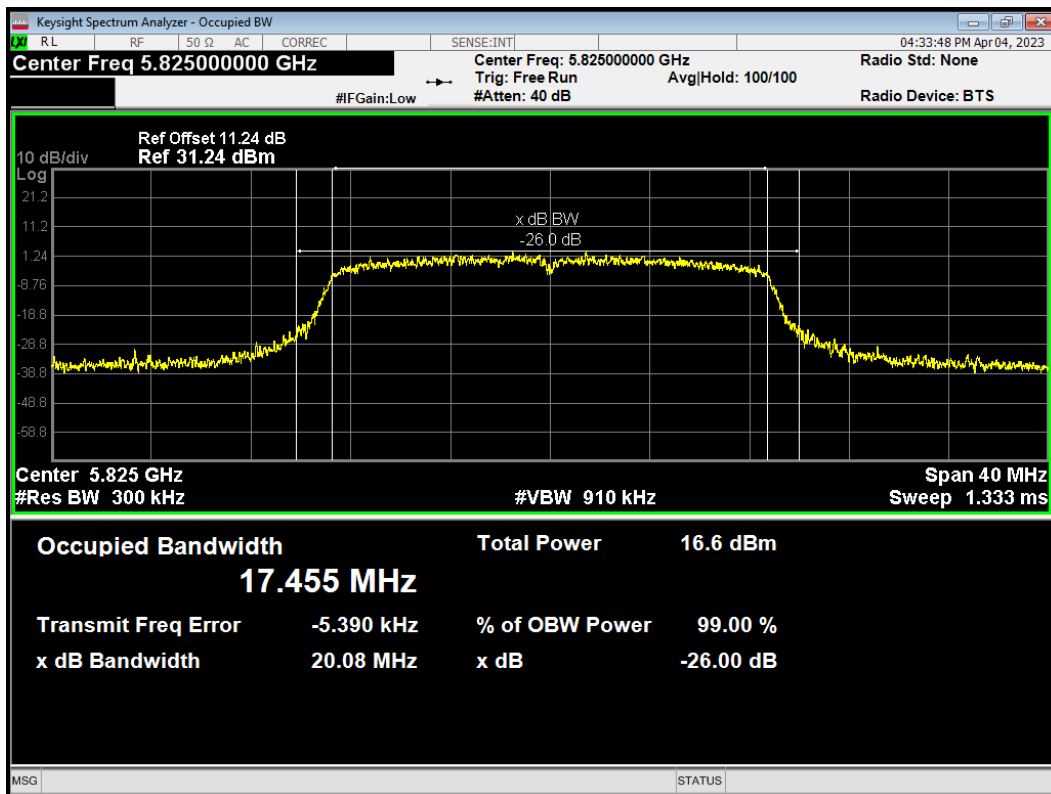

OBW 802.11n(HT40) 5755MHz

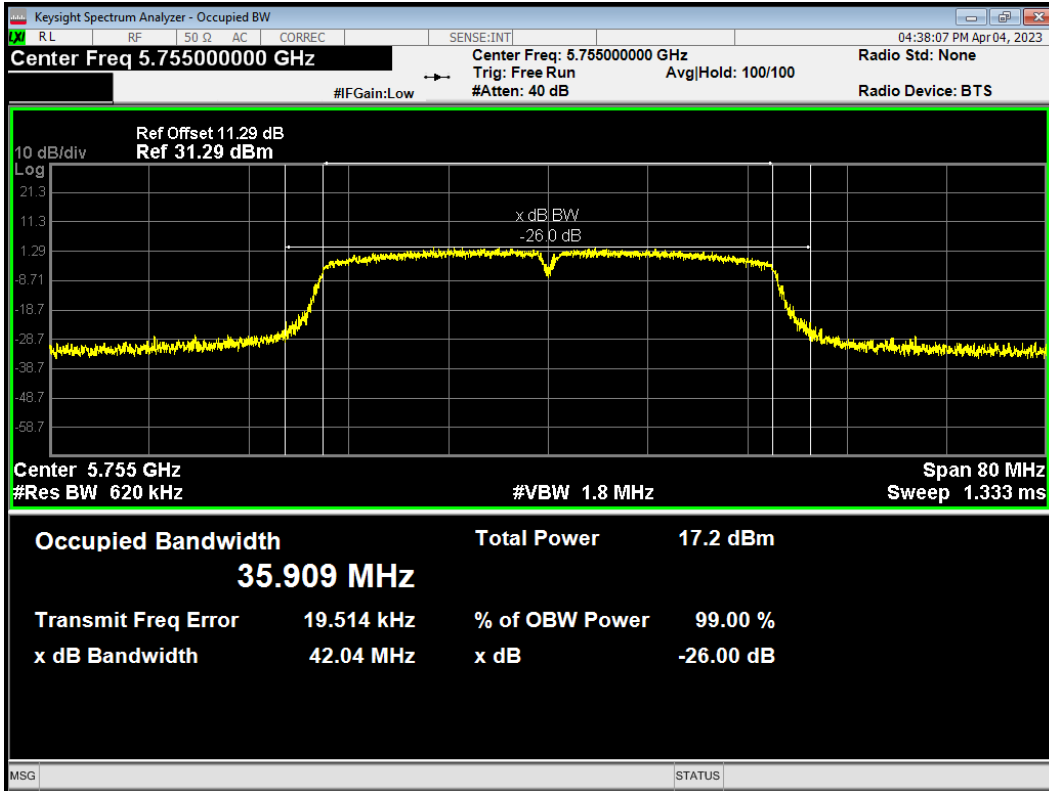

OBW 802.11n(HT40) 5795MHz

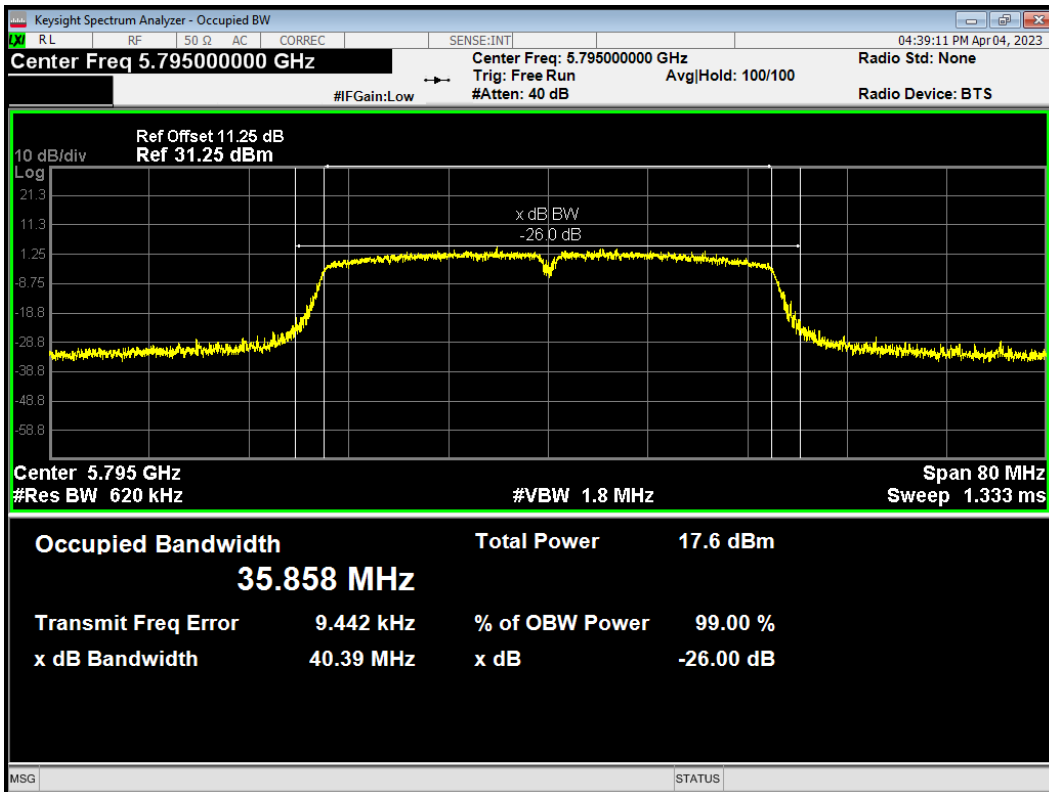

Minimum 6 dB bandwidth

U-NII-3

-6dB Bandwidth 802.11a 5745MHz

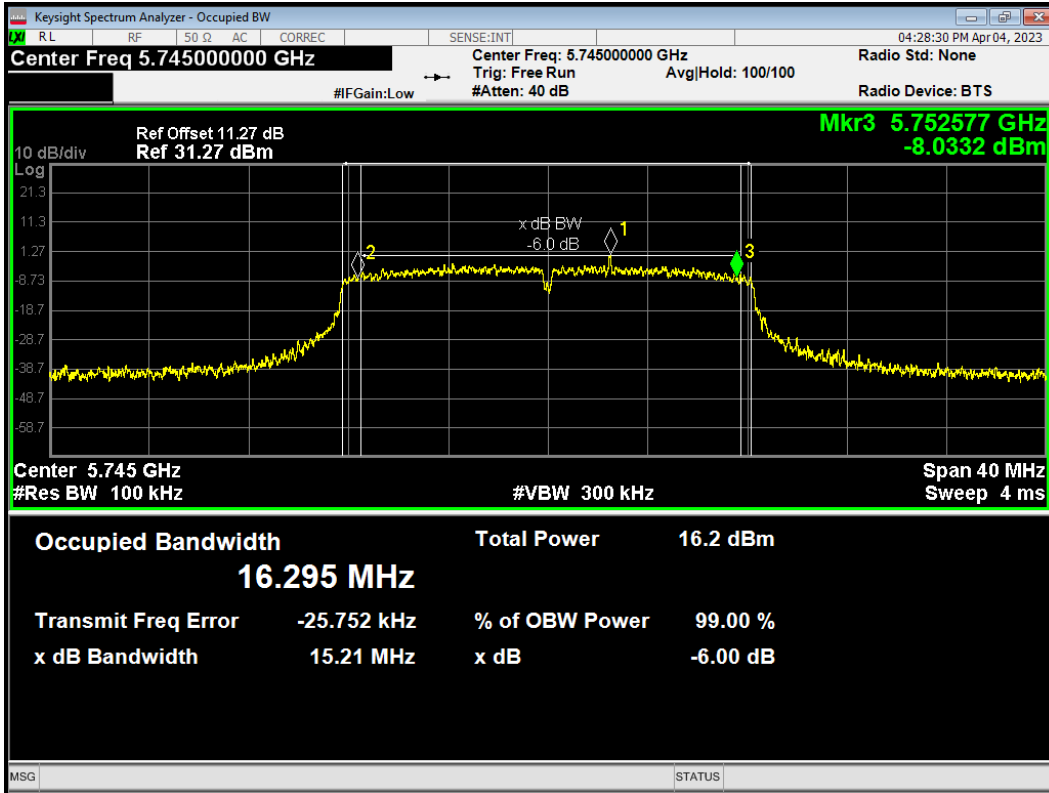

-6dB Bandwidth 802.11a 5785MHz

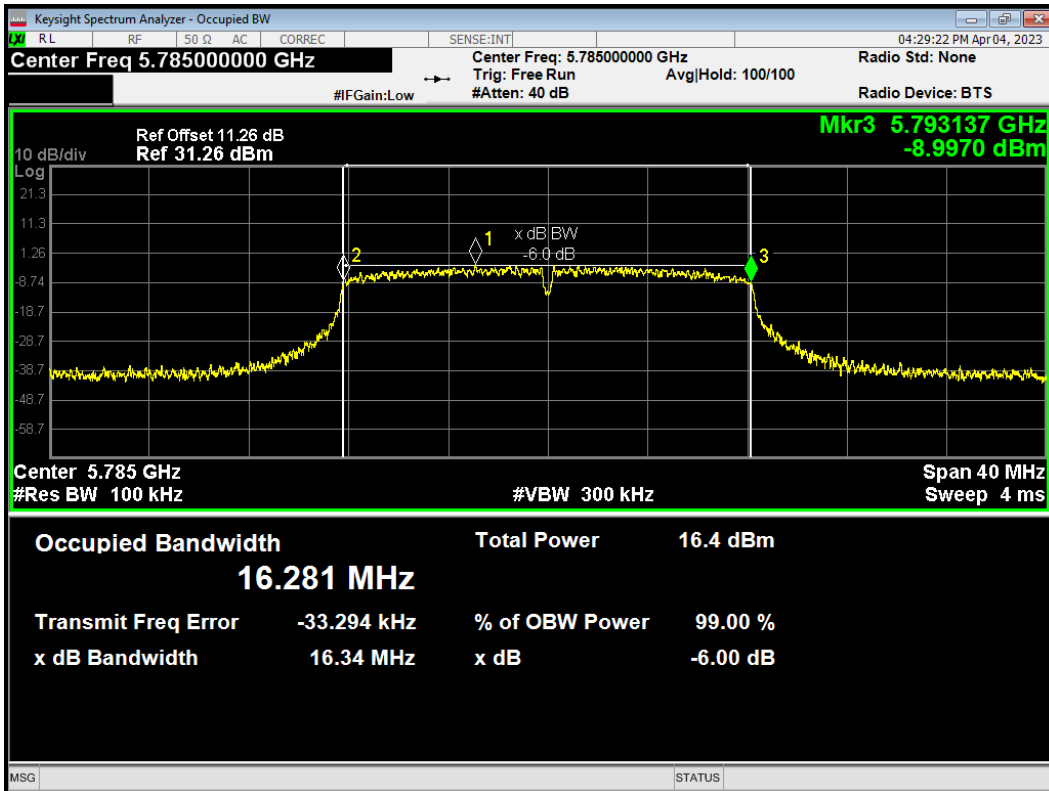

-6dB Bandwidth 802.11a 5825MHz

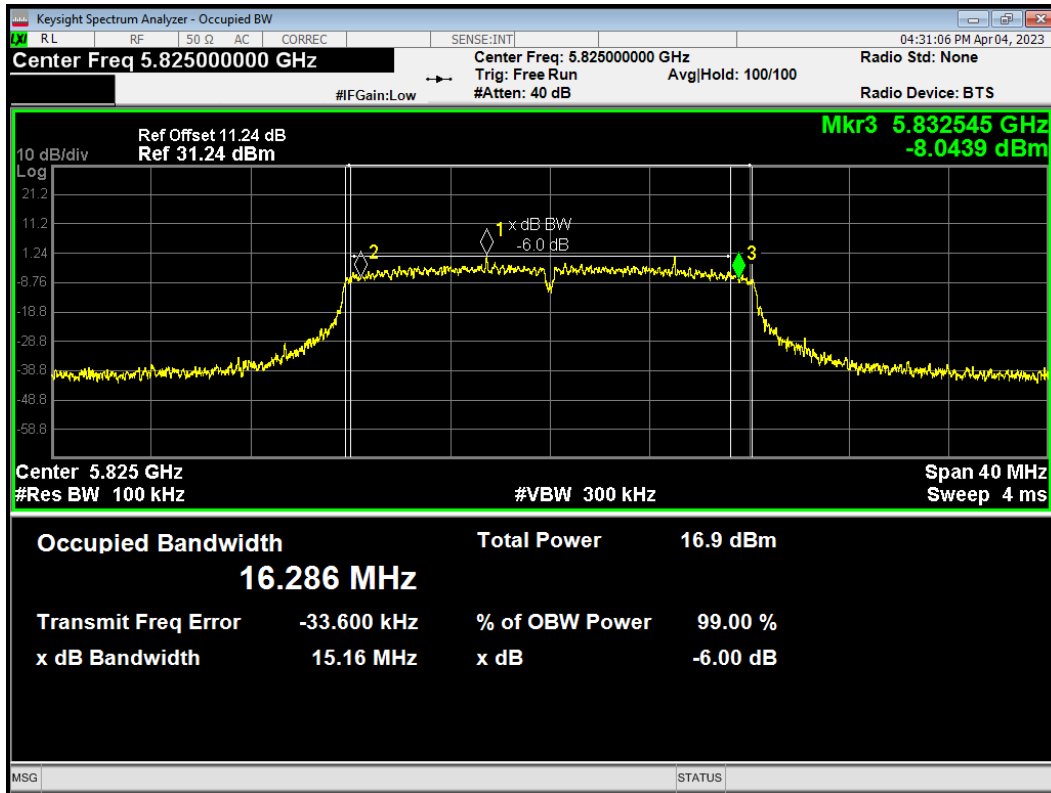

-6dB Bandwidth 802.11ac(VHT20) 5745MHz

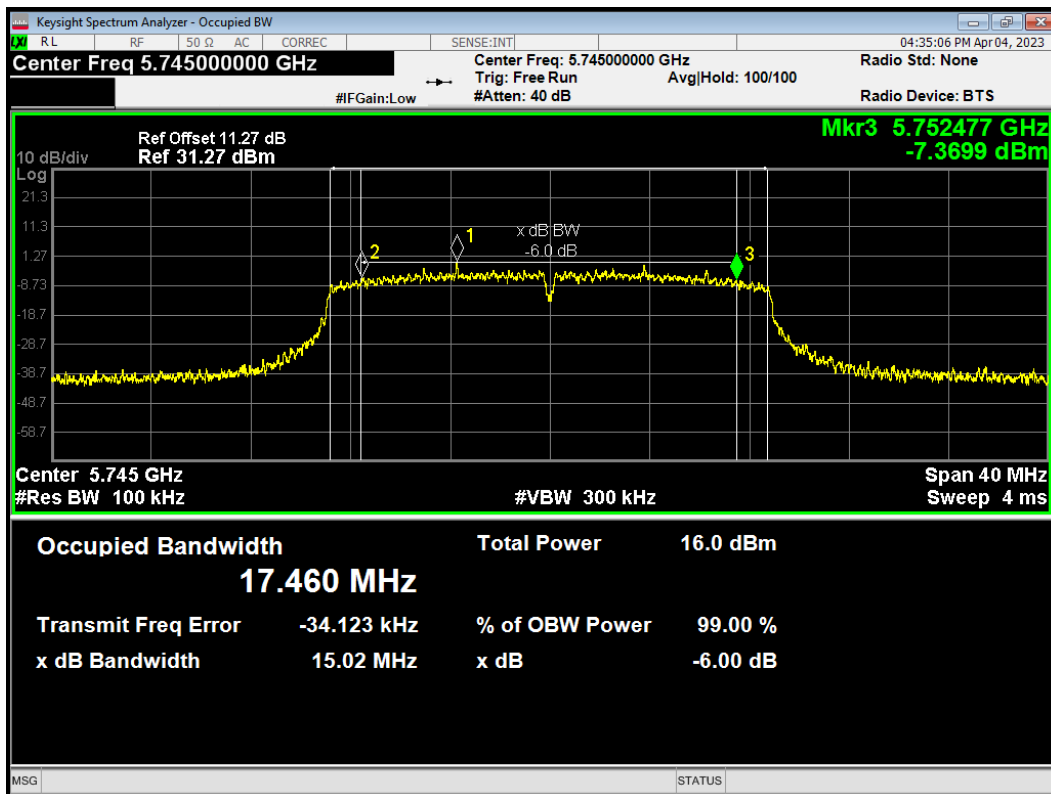

-6dB Bandwidth 802.11ac(VHT20) 5785MHz

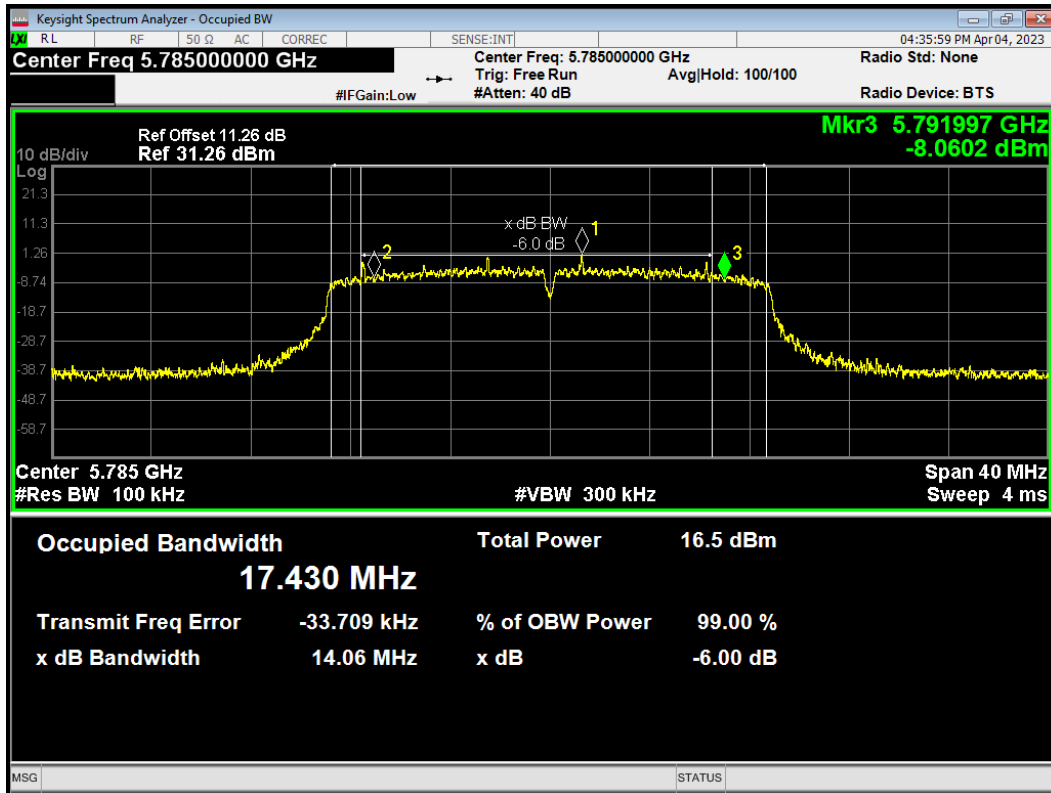

-6dB Bandwidth 802.11ac(VHT20) 5825MHz

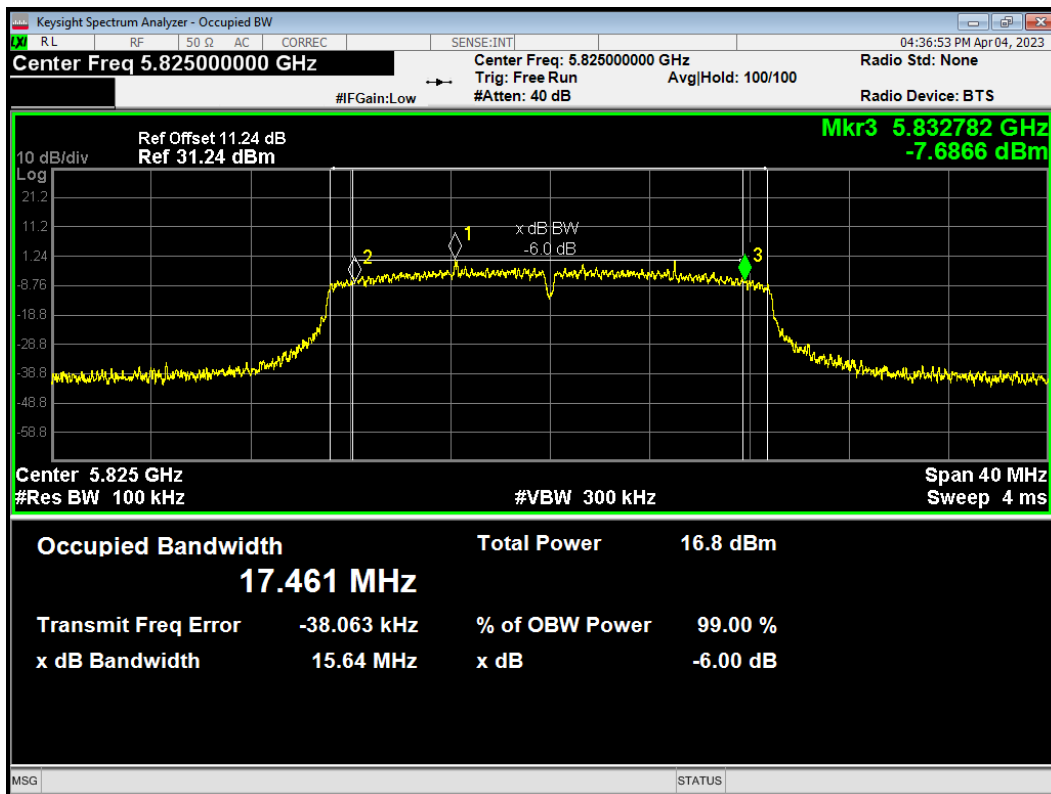

-6dB Bandwidth 802.11ac(VHT40) 5755MHz

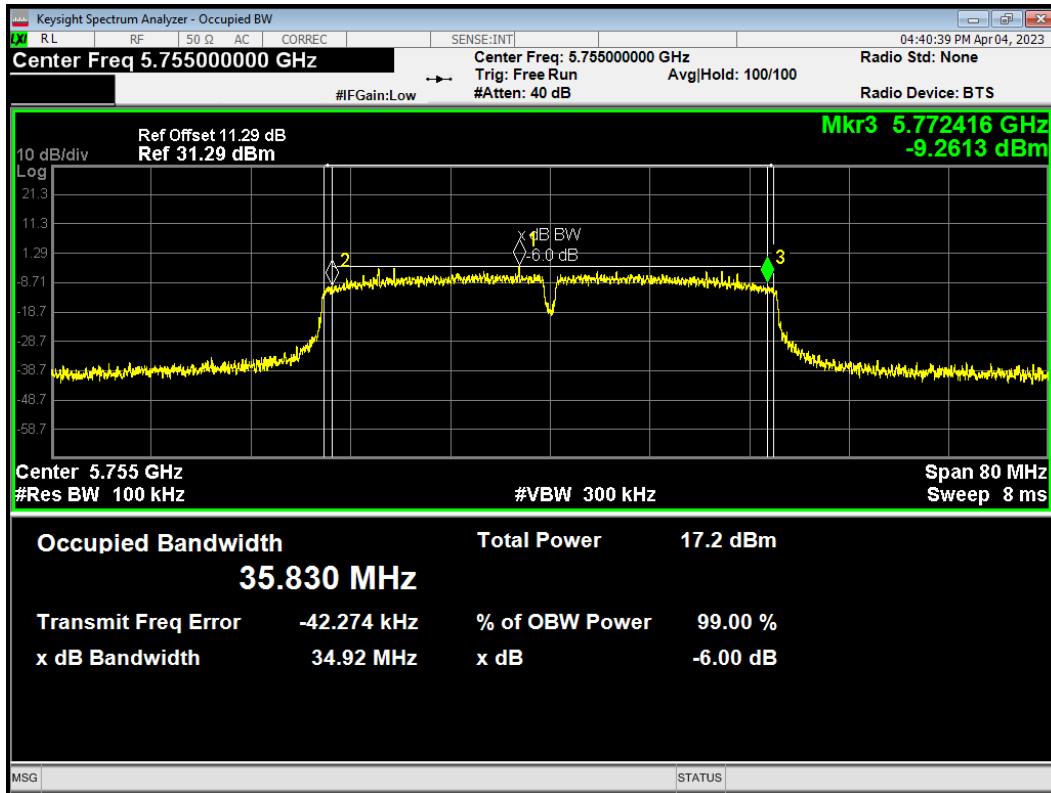

-6dB Bandwidth 802.11ac(VHT40) 5795MHz

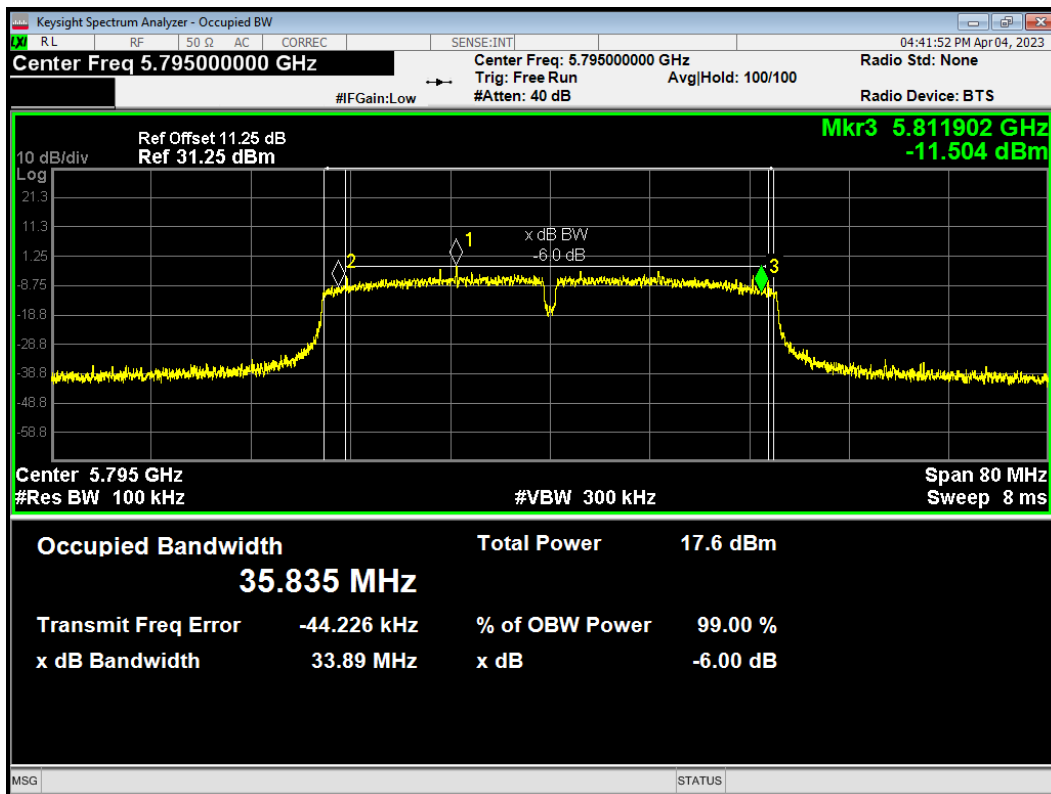

-6dB Bandwidth 802.11ac(VHT80) 5775MHz

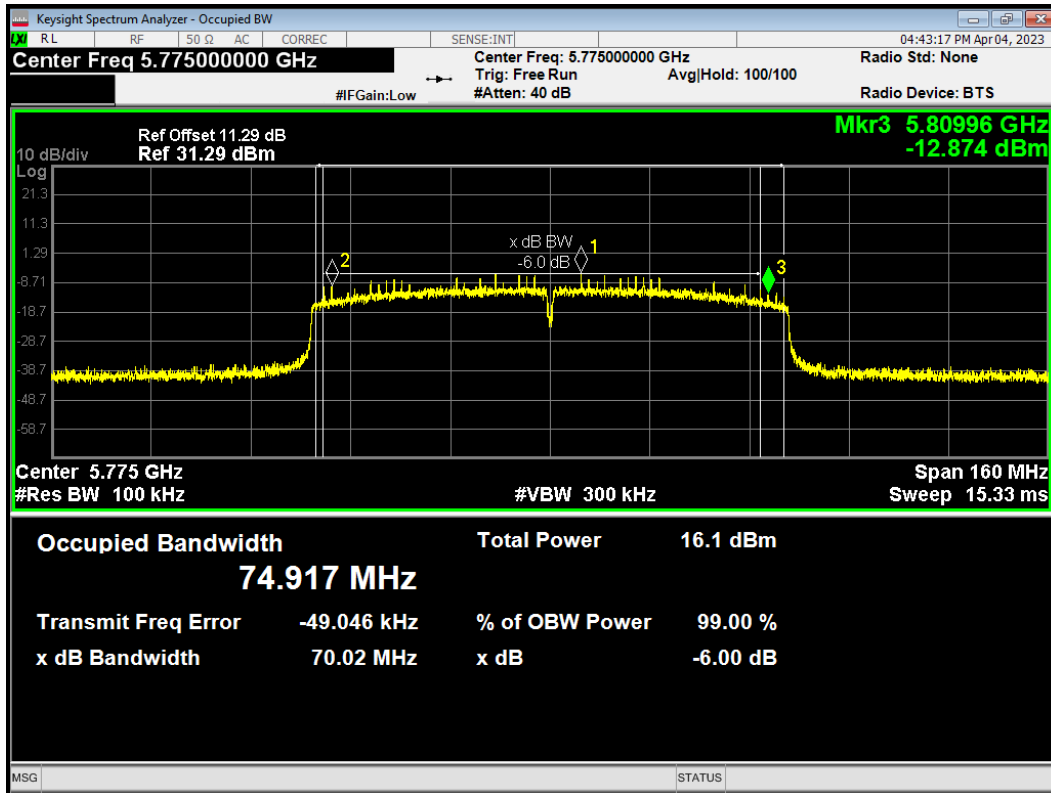

-6dB Bandwidth 802.11n(HT20) 5745MHz

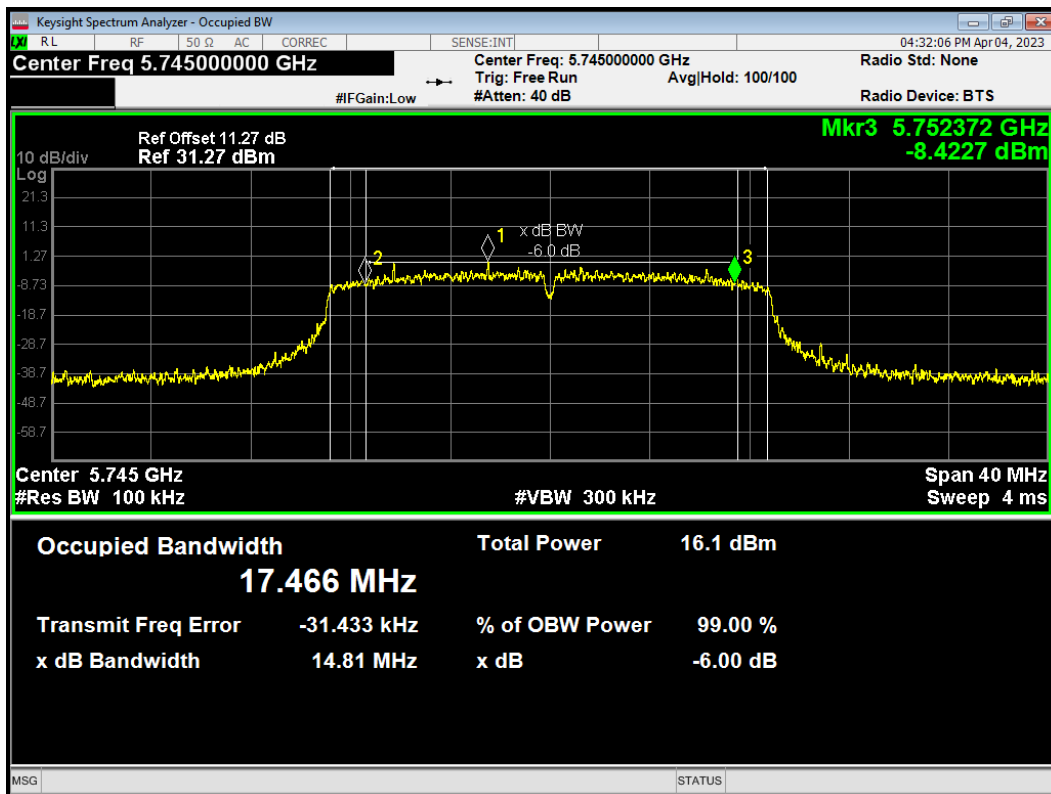

-6dB Bandwidth 802.11n(HT20) 5785MHz

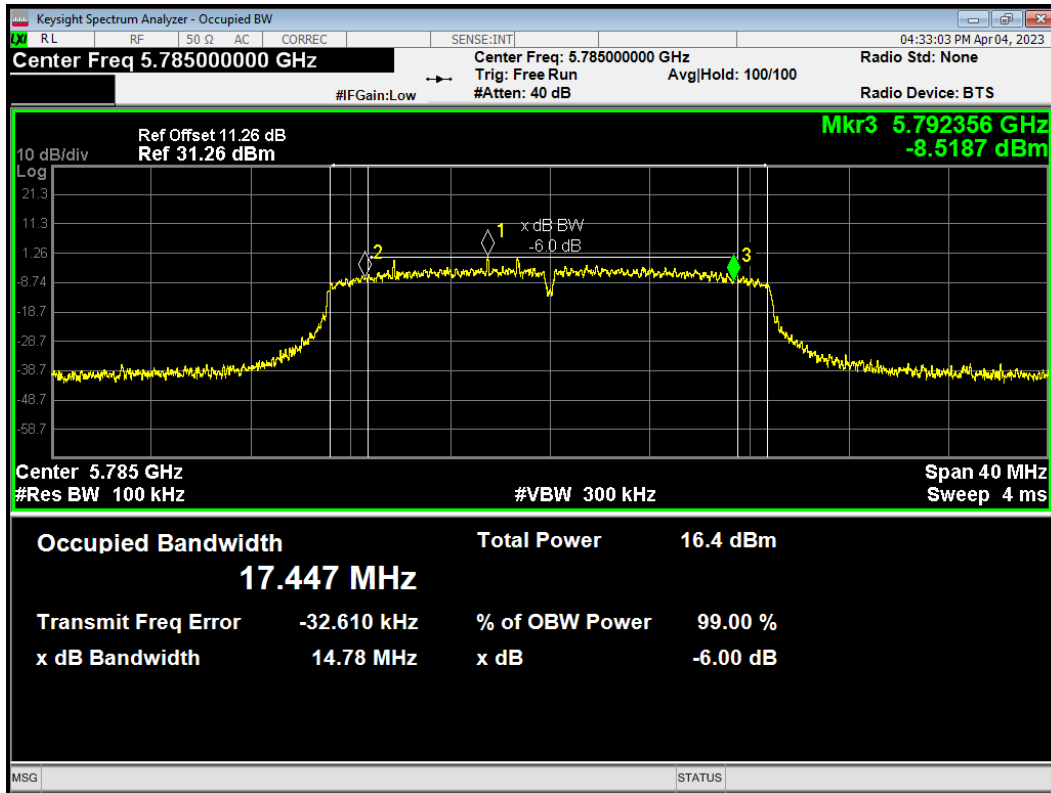

-6dB Bandwidth 802.11n(HT20) 5825MHz

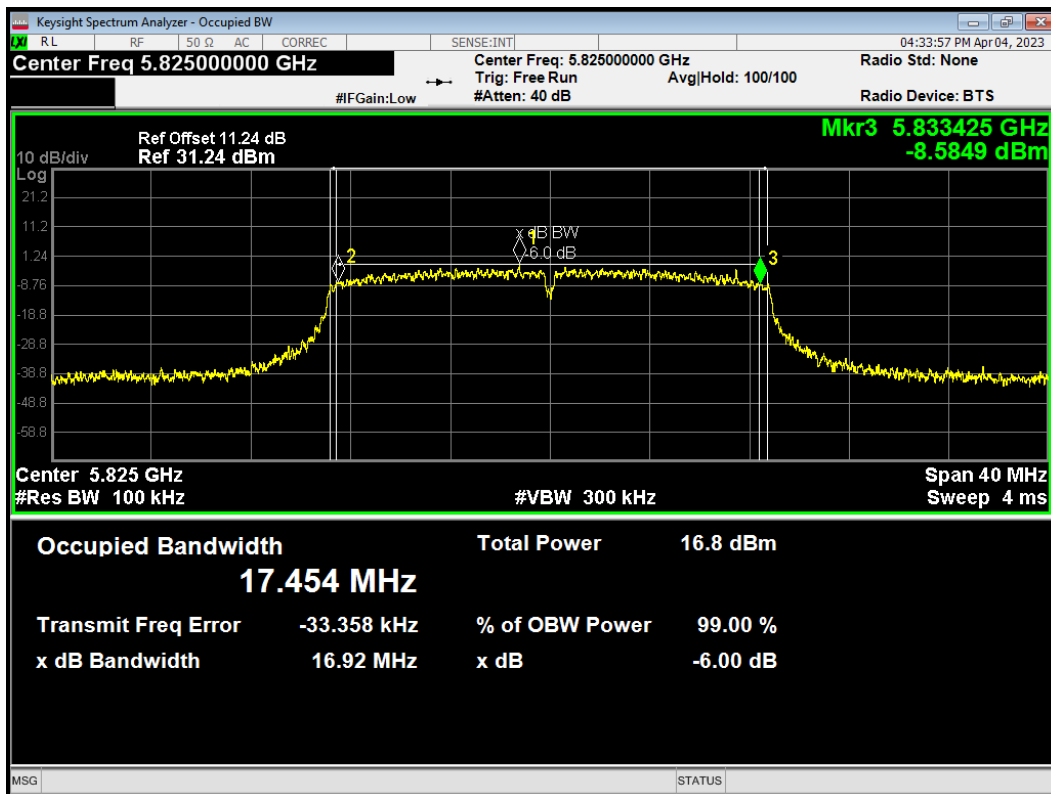

-6dB Bandwidth 802.11n(HT40) 5755MHz

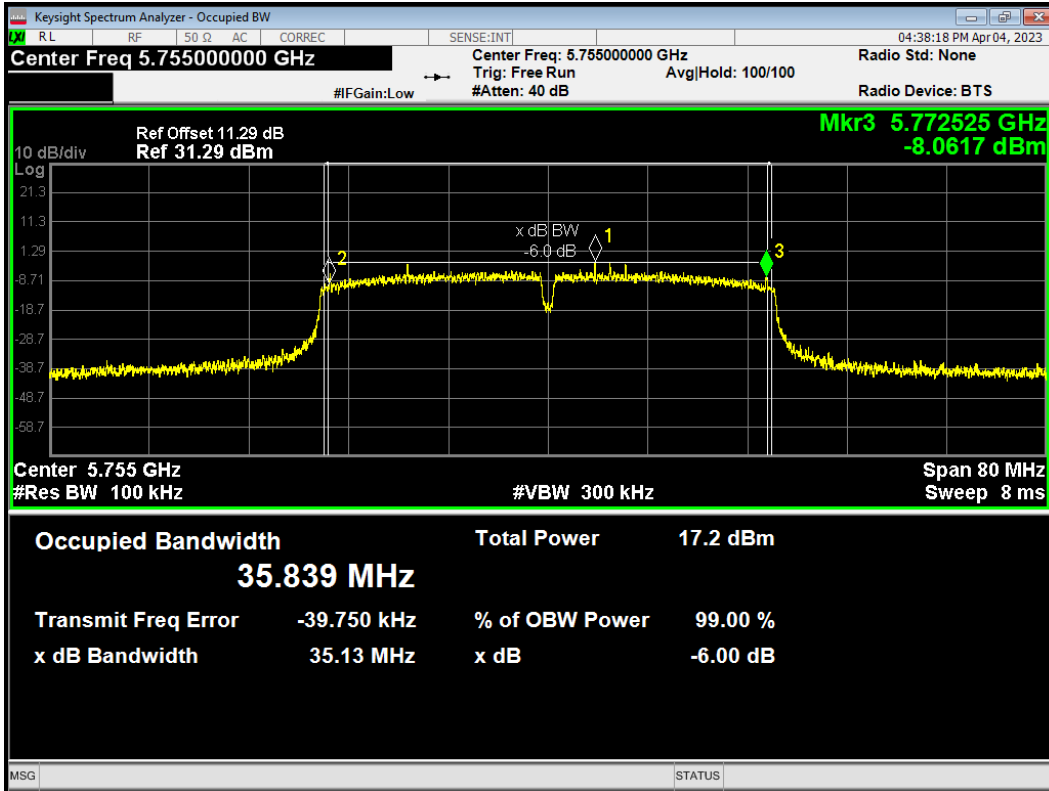

-6dB Bandwidth 802.11n(HT40) 5795MHz

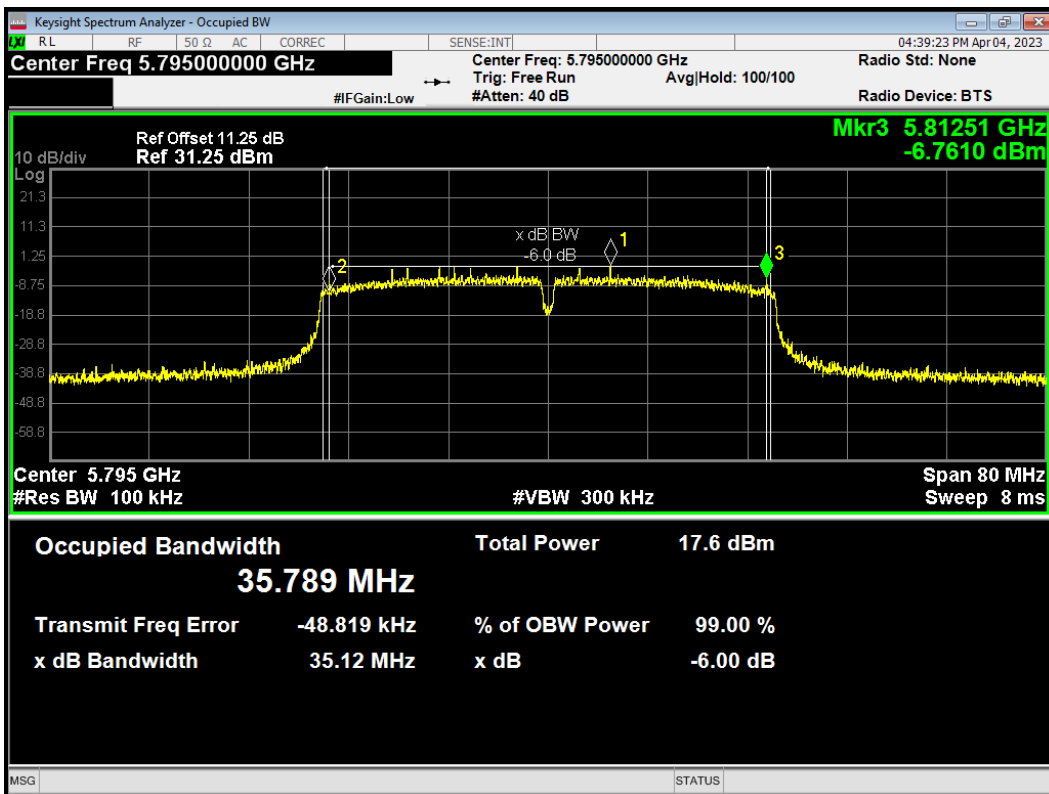

5.2. Average Power Output

Ambient condition

Temperature	Relative humidity
20°C ~ 25°C	45% ~ 50%

Methods of Measurement

During the process of the testing, The EUT was connected to the average power meter through an external attenuator and a known loss cable. The EUT is max power transmission with proper modulation. We use Maximum average Conducted Output Power Level Method in KDB789033 for this test

Test Setup

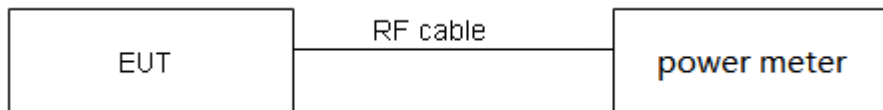

Limits

Rule FCC Part 15.407(a)(1)(2)(3)

(1) For the band 5.15-5.25 GHz.

(i) For an outdoor access point operating in the band 5.15-5.25 GHz, the maximum conducted output power over the frequency band of operation shall not exceed 1 W provided the maximum antenna gain does not exceed 6 dBi. In addition, the maximum power spectral density shall not exceed 17 dBm in any 1 megahertz band. If transmitting antennas of directional gain greater than 6 dBi are used, both the maximum conducted output power and the maximum power spectral density shall be reduced by the amount in dB that the directional gain of the antenna exceeds 6 dBi. The maximum e.i.r.p. at any elevation angle above 30 degrees as measured from the horizon must not exceed 125 mW (21 dBm).

(ii) For an indoor access point operating in the band 5.15-5.25 GHz, the maximum conducted output power over the frequency band of operation shall not exceed 1 W provided the maximum antenna gain does not exceed 6 dBi. In addition, the maximum power spectral density shall not exceed 17 dBm in any 1 megahertz band. If transmitting antennas of directional gain greater than 6 dBi are used, both the maximum conducted output power and the maximum power spectral density shall be reduced by the amount in dB that the directional gain of the antenna exceeds 6 dBi.

(iii) For fixed point-to-point access points operating in the band 5.15-5.25 GHz, the maximum conducted output power over the frequency band of operation shall not exceed 1 W. In addition, the maximum power spectral density shall not exceed 17 dBm in any 1 megahertz band. Fixed point-to-point U-NII devices may employ antennas with directional gain up to 23 dBi without any corresponding reduction in the maximum conducted output power or maximum power spectral density. For fixed point-to-point transmitters that employ a directional antenna gain greater than 23 dBi, a 1 dB reduction in maximum conducted output power and maximum power spectral density is

required for each 1 dB of antenna gain in excess of 23 dBi. Fixed, point-to-point operations exclude the use of point-to-multipoint systems, omnidirectional applications, and multiple collocated transmitters transmitting the same information. The operator of the U-NII device, or if the equipment is professionally installed, the installer, is responsible for ensuring that systems employing high gain directional antennas are used exclusively for fixed, point-to-point operations.

(iv) For client devices in the 5.15-5.25 GHz band, the maximum conducted output power over the frequency band of operation shall not exceed 250 mW provided the maximum antenna gain does not exceed 6 dBi. In addition, the maximum power spectral density shall not exceed 11 dBm in any 1 megahertz band. If transmitting antennas of directional gain greater than 6 dBi are used, both the maximum conducted output power and the maximum power spectral density shall be reduced by the amount in dB that the directional gain of the antenna exceeds 6 dBi.

(2) For the 5.25-5.35 GHz and 5.47-5.725 GHz bands, the maximum conducted output power over the frequency bands of operation shall not exceed the lesser of 250 mW or $11 \text{ dBm} + 10 \log B$, where B is the 26 dB emission bandwidth in megahertz. In addition, the maximum power spectral density shall not exceed 11 dBm in any 1 megahertz band. If transmitting antennas of directional gain greater than 6 dBi are used, both the maximum conducted output power and the maximum power spectral density shall be reduced by the amount in dB that the directional gain of the antenna exceeds 6 dBi.

(3) For the band 5.725-5.85 GHz, the maximum conducted output power over the frequency band of operation shall not exceed 1 W. In addition, the maximum power spectral density shall not exceed 30 dBm in any 500-kHz band. If transmitting antennas of directional gain greater than 6 dBi are used, both the maximum conducted output power and the maximum power spectral density shall be reduced by the amount in dB that the directional gain of the antenna exceeds 6 dBi.

Measurement Uncertainty

The assessed measurement uncertainty to ensure 95% confidence level for the normal distribution is with the coverage factor $k = 2$, $U = 0.44 \text{ dB}$.

Test Results

Mode	Duty cycle	Duty cycle correction Factor(dB)
802.11a	0.98	0.00
802.11n HT20	0.97	0.14
802.11n HT40	0.93	0.30
802.11ac VHT20	0.97	0.11
802.11ac VHT40	0.93	0.30
802.11ac VHT80	0.88	0.53

Note: when Duty cycle ≥ 0.98 , Duty cycle correction Factor not required.

Power Index								
Channel	802.11a	802.11n HT20	802.11ac VHT20	Channel	802.11n HT40	802.11ac VHT40	Channel	802.11ac VHT80
CH36	12	12	12	CH38	10	12.5	CH42	9
CH40	12	12	12	CH46	12.5	12.5	CH58	10
CH48	12	12	12	CH54	12.5	12.5	CH106	11
CH52	12	12	12	CH62	10.5	12.5	CH122	11
CH60	12	12	12	CH102	9	12.5	CH155	11
CH64	12	12	12	CH110	12.5	/	/	/
CH100	11	10	12	CH118	12.5	12.5	/	/
CH104	12	12	/	CH134	12.5	12.5	/	/
CH120	12	12	12	CH151	12.5	12.5	/	/
CH136	12	12	/	CH159	12.5	12.5	/	/
CH140	10	10	12	/	/	/	/	/
CH149	12	12	12	/	/	/	/	/
CH157	12	12	12	/	/	/	/	/
CH165	12	12	12	/	/	/	/	/

Test Mode		Channel/Frequency (MHz)	B=26 dB bandwidth (MHz)	Limit 11 dBm + 10 log B (dBm)	Final Limit (dBm)
U-NII-2A	802.11a	52/5260	19.09	23.81<24	23.81
		60/5300	19.10	23.81<24	23.81
		64/5320	19.27	23.85<24	23.85
	802.11n HT20	52/5260	20.05	24.02>24	24.00
		60/5300	20.23	24.06>24	24.00
		64/5320	20.36	24.09>24	24.00
	802.11n HT40	54/5270	42.28	27.26>24	24.00
		62/5310	40.70	27.10>24	24.00
	802.11ac VHT20	52/5260	20.13	24.04>24	24.00
		60/5300	20.28	24.07>24	24.00
64/5320		19.89	23.99<24	23.99	
802.11ac VHT40	54/5270	40.78	27.10>24	24.00	
	62/5310	41.00	27.13>24	24.00	
802.11ac VHT80	58/5290	82.23	30.15>24	24.00	
U-NII-2C	802.11a	100/5500	19.48	23.90<24	23.90
		104/5520	19.39	23.88<24	23.88
		120/5600	19.36	23.87<24	23.87
		136/5680	19.22	23.84<24	23.84
		140/5700	19.45	23.89<24	23.89
	802.11n HT20	100/5500	20.40	24.10>24	24.00
		104/5520	20.02	24.02>24	24.00
		120/5600	20.12	24.04>24	24.00
		136/5680	20.11	24.03>24	24.00
		140/5700	19.83	23.97<24	23.97
	802.11n HT40	102/5510	41.27	27.16>24	24.00
		110/5550	41.03	27.13>24	24.00
		118/5590	41.31	27.16>24	24.00
		134/5670	41.93	27.23>24	24.00
	802.11ac VHT20	100/5500	20.15	24.04>24	24.00
		120/5600	20.20	24.05>24	24.00
		140/5700	20.11	24.03>24	24.00
	802.11ac VHT40	102/5510	42.13	27.25>24	24.00
		118/5590	40.76	27.10>24	24.00
		134/5670	42.20	27.25>24	24.00
802.11ac VHT80	106/5530	81.10	30.09>24	24.00	
	122/5610	84.94	30.29>24	24.00	

Note: 250mW=24dBm

U-NII-1

Test Mode	Channel/ Frequency (MHz)	Average Power Measured (dBm)	Average Power with duty factor (dBm)	Limit (dBm)	Conclusion
802.11a	36/5180	10.39	10.39	24.00	PASS
	40/5200	10.53	10.53	24.00	PASS
	48/5240	10.64	10.64	24.00	PASS
802.11n HT20	36/5180	10.18	10.32	24.00	PASS
	40/5200	10.26	10.40	24.00	PASS
	48/5240	10.41	10.56	24.00	PASS
802.11n HT40	38/5190	8.79	9.09	24.00	PASS
	46/5230	11.42	11.72	24.00	PASS
802.11ac VHT20	36/5180	10.21	10.32	24.00	PASS
	40/5200	10.30	10.41	24.00	PASS
	48/5240	10.42	10.53	24.00	PASS
802.11ac VHT40	38/5190	11.28	11.58	24.00	PASS
	46/5230	11.49	11.80	24.00	PASS
802.11ac VHT80	42/5210	7.30	7.84	24.00	PASS

Note: Average Power with duty factor = Average Power Measured +Duty cycle correction factor

U-NII-2A

Test Mode	Channel/ Frequency (MHz)	Average Power Measured (dBm)	Average Power with duty factor (dBm)	Limit (dBm)	Conclusion
802.11a	52/5260	10.50	10.50	23.81	PASS
	60/5300	10.68	10.68	23.81	PASS
	64/5320	10.57	10.57	23.85	PASS
802.11n HT20	52/5260	10.27	10.41	24.00	PASS
	60/5300	10.48	10.62	24.00	PASS
	64/5320	10.38	10.52	24.00	PASS
802.11n HT40	54/5270	11.19	11.49	24.00	PASS
	62/5310	9.33	9.63	24.00	PASS
802.11ac VHT20	52/5260	10.24	10.35	24.00	PASS
	60/5300	10.49	10.60	24.00	PASS
	64/5320	10.35	10.46	23.99	PASS
802.11ac VHT40	54/5270	11.19	11.49	24.00	PASS
	62/5310	11.31	11.61	24.00	PASS
802.11ac VHT80	58/5290	8.63	9.16	24.00	PASS

Note: Average Power with duty factor = Average Power Measured +Duty cycle correction factor

U-NII-2C

Test Mode	Channel/ Frequency (MHz)	Average Power Measured (dBm)	Average Power with duty factor (dBm)	Limit (dBm)	Conclusion
802.11a	100/5500	8.92	8.92	23.90	PASS
	104/5520	9.82	9.82	23.88	PASS
	120/5600	10.37	10.37	23.87	PASS
	136/5680	10.68	10.68	23.84	PASS
	140/5700	8.46	8.46	23.89	PASS
802.11n HT20	100/5500	7.73	7.87	24.00	PASS
	104/5520	9.54	9.68	24.00	PASS
	120/5600	10.17	10.31	24.00	PASS
	136/5680	10.41	10.55	24.00	PASS
	140/5700	8.22	8.36	23.97	PASS
802.11n HT40	102/5510	7.16	7.46	24.00	PASS
	110/5550	10.86	11.16	24.00	PASS
	118/5590	11.12	11.42	24.00	PASS
	134/5670	11.42	11.72	24.00	PASS
802.11ac VHT20	100/5500	9.81	9.92	24.00	PASS
	120/5600	10.19	10.30	24.00	PASS
	140/5700	10.35	10.46	24.00	PASS
802.11ac VHT40	102/5510	10.70	11.00	24.00	PASS
	118/5590	11.13	11.43	24.00	PASS
	134/5670	11.40	11.71	24.00	PASS
802.11ac VHT80	106/5530	8.51	9.04	24.00	PASS
	122/5610	9.29	9.82	24.00	PASS

Note: Average Power with duty factor = Average Power Measured +Duty cycle correction factor

U-NII-3

Test Mode	Channel/ Frequency (MHz)	Average Power Measured (dBm)	Average Power with duty factor (dBm)	Limit (dBm)	Conclusion
802.11a	149/5745	10.18	10.18	30.00	PASS
	157/5785	10.53	10.53	30.00	PASS
	165/5825	11.04	11.04	30.00	PASS
802.11n HT20	149/5745	10.02	10.16	30.00	PASS
	157/5785	10.35	10.49	30.00	PASS
	165/5825	10.75	10.89	30.00	PASS
802.11n HT40	151/5755	11.00	11.30	30.00	PASS
	159/5795	11.34	11.64	30.00	PASS
802.11ac VHT20	149/5745	10.04	10.15	30.00	PASS
	157/5785	10.35	10.46	30.00	PASS
	165/5825	10.73	10.84	30.00	PASS
802.11ac VHT40	151/5755	11.00	11.30	30.00	PASS
	159/5795	11.32	11.62	30.00	PASS
802.11ac VHT80	155/5775	9.26	9.79	30.00	PASS

Note: Average Power with duty factor = Average Power Measured +Duty cycle correction factor

5.3. Frequency Stability

Ambient condition

Temperature	Relative humidity
20°C ~ 25°C	45% ~ 50%

Method of Measurement

1. Frequency stability with respect to ambient temperature

- a) Supply the EUT with a nominal ac voltage or install a new or fully charged battery in the EUT. If possible, a dummy load shall be connected to the EUT because an antenna near the metallic walls of an environmental test chamber could affect the output frequency of the EUT. If the EUT is equipped with a permanently attached, adjustable-length antenna, then the EUT shall be placed in the center of the chamber with the antenna adjusted to the shortest length possible. Turn ON the EUT and tune it to one of the number of frequencies shown in 5.6.
- b) Couple the unlicensed wireless device output to the measuring instrument by connecting an antenna to the measuring instrument with a suitable length of coaxial cable and placing the measuring antenna near the EUT (e.g., 15 cm away), or by connecting a dummy load to the measuring instrument, through an attenuator if necessary.
- c) Adjust the location of the measurement antenna and the controls on the measurement instrument to obtain a suitable signal level (i.e., a level that will not overload the measurement instrument but is strong enough to allow measurement of the operating or fundamental frequency of the EUT).
- d) Turn the EUT OFF and place it inside the environmental temperature chamber. For devices that have oscillator heaters, energize only the heater circuit.
- e) Set the temperature control on the chamber to the highest specified in the regulatory requirements for the type of device and allow the oscillator heater and the chamber temperature to stabilize.
- f) While maintaining a constant temperature inside the environmental chamber, turn the EUT ON and record the operating frequency at startup, and at 2 minutes, 5 minutes, and 10 minutes after the EUT is energized. Four measurements in total are made.
- g) Measure the frequency at each of frequencies specified in 5.6.
- h) Switch OFF the EUT but do not switch OFF the oscillator heater.
- i) Lower the chamber temperature by not more than 10°C, and allow the temperature inside the chamber to stabilize.
- j) Repeat step f) through step i) down to the lowest specified temperature.

2. Frequency stability when varying supply voltage

Unless otherwise specified, these tests shall be made at ambient room temperature (+15°C to +25 °C). An antenna shall be connected to the antenna output terminals of the EUT if possible. If the EUT is equipped with or uses an adjustable-length antenna, then it shall be fully extended.

- a) Supply the EUT with nominal voltage or install a new or fully charged battery in the EUT. Turn ON the EUT and couple its output to a frequency counter or other frequency-measuring instrument.

- b) Tune the EUT to one of the number of frequencies required in 5.6. Adjust the location of the measurement antenna and the controls on the measurement instrument to obtain a suitable signal level (i.e., a level that will not overload the measurement instrument but is strong enough to allow measurement of the operating or fundamental frequency of the EUT).
- c) Measure the frequency at each of the frequencies specified in 5.6.
- d) Repeat the above procedure at 85% and 115% of the nominal supply voltage.

Limit

Manufacturers of U-NII devices are responsible for ensuring frequency stability such that an emission is maintained within the band of operation under all conditions of normal operation as specified in the users manual.

Measurement Uncertainty

The assessed measurement uncertainty to ensure 95% confidence level for the normal distribution is with the coverage factor $k = 2$, $U = 936\text{Hz}$

Test Results

Voltage (V)	Temperature (°C)	U-NII-1 Test Results			
		5200MHz			
		1min	2min	5min	10min
3.3	-20	5199.991975	5199.991516	5199.985724	5199.976576
3.3	-10	5200.000338	5199.987155	5199.978730	5199.968859
3.3	0	5199.993096	5199.985653	5199.978300	5199.962659
3.3	10	5199.992981	5199.985004	5199.970314	5199.959781
3.3	20	5199.990304	5199.975572	5199.970249	5199.952730
3.3	30	5199.986927	5199.973430	5199.964593	5199.950212
3.3	40	5199.977198	5199.972190	5199.959439	5199.940441
3.3	50	5199.967703	5199.964730	5199.952458	5199.935553
3.14	20	5199.960893	5199.962180	5199.946235	5199.931381
3.46	20	5199.957769	5199.957159	5199.937365	5199.930501
Max. ΔMHz		-0.042231	-0.042841	-0.062635	-0.069499
PPM		-8.121346	-8.238654	-12.045192	-13.365192

Voltage (V)	Temperature (°C)	U-NII-2A Test Results			
		5300MHz			
		1min	2min	5min	10min
3.3	-20	5299.996849	5299.994700	5299.990576	5299.987972
3.3	-10	5299.993759	5299.986542	5299.985052	5299.985705
3.3	0	5299.988513	5299.983250	5299.983945	5299.983076
3.3	10	5299.981009	5299.974434	5299.979176	5299.974887
3.3	20	5299.975470	5299.967193	5299.974694	5299.968303
3.3	30	5299.967215	5299.962499	5299.974090	5299.959086
3.3	40	5299.960528	5299.959104	5299.966021	5299.956896
3.3	50	5299.953379	5299.954988	5299.965736	5299.947803
3.14	20	5299.948883	5299.950032	5299.958883	5299.940832
3.46	20	5299.947444	5299.944109	5299.956130	5299.938759
Max. ΔMHz		-0.052556	-0.055891	-0.043870	-0.061241
PPM		-9.916226	-10.545472	-8.277358	-11.554906

Voltage (V)	Temperature (°C)	U-NII-2C Test Results			
		5580MHz			
		1min	2min	5min	10min
3.3	-20	5580.009165	5580.006182	5579.999151	5579.992363
3.3	-10	5580.004954	5580.000262	5579.996212	5579.985756
3.3	0	5579.998257	5579.996342	5579.995474	5579.982535
3.3	10	5579.994621	5579.988509	5579.991255	5579.973998
3.3	20	5579.989713	5579.980427	5579.990350	5579.964247
3.3	30	5579.985406	5579.974223	5579.982106	5579.954261
3.3	40	5579.984842	5579.973043	5579.979554	5579.954108
3.3	50	5579.981195	5579.972148	5579.975561	5579.951160
3.14	20	5579.979050	5579.965187	5579.975121	5579.948281
3.46	20	5579.972065	5579.964978	5579.968807	5579.944075
3.3	-20	5580.009165	5580.006182	5579.999151	5579.992363
Max. ΔMHz		-0.027935	-0.035022	-0.031193	-0.055925
PPM		-5.006272	-6.276344	-5.590143	-10.022401

Voltage (V)	Temperature (°C)	U-NII-3 Test Results			
		5785MHz			
		1min	2min	5min	10min
3.3	-20	5784.995155	5784.985427	5784.980714	5784.973358
3.3	-10	5784.992666	5784.977077	5784.973788	5784.966912
3.3	0	5784.990350	5784.971477	5784.972665	5784.963222
3.3	10	5784.983126	5784.968720	5784.969719	5784.961774
3.3	20	5784.974388	5784.966231	5784.959847	5784.954545
3.3	30	5784.967557	5784.959327	5784.953958	5784.952588
3.3	40	5784.958183	5784.955325	5784.953887	5784.951019
3.3	50	5784.957623	5784.949890	5784.948147	5784.948614
3.14	20	5784.956600	5784.942398	5784.941555	5784.942214
3.46	20	5784.947798	5784.936378	5784.932253	5784.935115
3.3	-20	5784.995155	5784.985427	5784.980714	5784.973358
Max. ΔMHz		-0.052202	-0.063622	-0.067747	-0.064885
PPM		-9.023682	-10.997753	-11.710804	-11.216076

5.4. Power Spectral Density

Ambient condition

Temperature	Relative humidity
20°C ~ 25°C	45% ~ 50%

Method of Measurement

The EUT was connected to the spectrum analyzer through an external attenuator (20dB) and a known loss cable.

Set RBW = 1MHz, VBW =3MHz for the band 5.150-5.250GHz, 5.250-5.350GHz, 5.470-5.725GHz.
Set RBW = 470kHz, VBW =1.5MHz for the band 5.725-5.850GHz

The conducted PSD is measured at each antenna port. The measured results at the various antenna ports are then summed mathematically.

Test setup

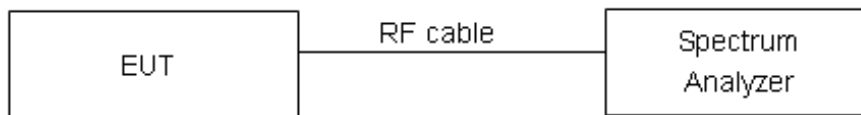

Limits

Rule FCC Part 15.407(a)(1)/ Part 15.407(a)(2) / Part 15.407(a)(3)

For an indoor access point operating in the band 5.15-5.25 GHz, the maximum power spectral density shall not exceed 17 dBm in any 1 megahertz band. If transmitting antennas of directional gain greater than 6 dBi are used, both the maximum conducted output power and the maximum power spectral density shall be reduced by the amount in dB that the directional gain of the antenna exceeds 6 dBi.

For client devices in the 5.15-5.25 GHz band, the maximum conducted output power over the frequency band of operation shall not exceed 250 mW provided the maximum antenna gain does not exceed 6 dBi. In addition, the maximum power spectral density shall not exceed 11 dBm in any 1 megahertz band. If transmitting antennas of directional gain greater than 6 dBi are used, both the maximum conducted output power and the maximum power spectral density shall be reduced by the amount in dB that the directional gain of the antenna exceeds 6 dBi.

For the 5.25-5.35 GHz and 5.47-5.725 GHz bands, the maximum power spectral density shall not exceed 11 dBm in any 1 megahertz band. If transmitting antennas of directional gain greater than 6 dBi are used, both the maximum conducted output power and the maximum power spectral density shall be reduced by the amount in dB that the directional gain of the antenna exceeds 6 dBi.

For the band 5.725-5.85 GHz, the maximum power spectral density shall not exceed 30 dBm in any 500kHz band. If transmitting antennas of directional gain greater than 6 dBi are used, both the maximum conducted output power and the maximum power spectral density shall be reduced by the

amount in dB that the directional gain of the antenna exceeds 6 dBi.

Frequency Bands/MHz	Limits
5150-5250	11dBm/MHz
5.25-5.35 GHz and 5.47-5.725 GHz	11dBm/MHz
5725-5850	30dBm/500kHz

Measurement Uncertainty

The assessed measurement uncertainty to ensure 95% confidence level for the normal distribution is with the coverage factor $k = 2$, $U = 0.75\text{dB}$.

Test Results:
U-NII-1

Mode	Channel Number	Read Value (dBm /MHz)	Power Spectral Density (dBm /MHz)	Limit (dBm /MHz)	Conclusion
802.11a	36	0.21	0.21	11	PASS
	40	0.73	0.73	11	PASS
	48	0.73	0.73	11	PASS
802.11n HT20	36	-0.06	0.08	11	PASS
	40	-0.06	0.08	11	PASS
	48	0.22	0.36	11	PASS
802.11n HT40	38	-4.36	-4.06	11	PASS
	46	-1.39	-1.09	11	PASS
802.11ac VHT20	36	0.03	0.14	11	PASS
	40	0.08	0.19	11	PASS
	48	0.24	0.35	11	PASS
802.11ac VHT40	38	-1.82	-1.52	11	PASS
	46	-1.64	-1.34	11	PASS
802.11ac VHT80	42	-8.82	-8.29	11	PASS

Note: Power Spectral Density =Read Value+Duty cycle correction factor

U-NII-2A

Mode	Channel Number	Read Value (dBm /MHz)	Power Spectral Density (dBm /MHz)	Limit (dBm /MHz)	Conclusion
802.11a	52	0.52	0.52	11	PASS
	60	0.48	0.48	11	PASS
	64	0.56	0.56	11	PASS
802.11n HT20	52	-0.07	0.07	11	PASS
	60	0.26	0.40	11	PASS
	64	0.22	0.36	11	PASS
802.11n HT40	54	-2.27	-1.97	11	PASS
	62	-4.03	-3.73	11	PASS
802.11ac VHT20	52	0.07	0.18	11	PASS
	60	0.19	0.30	11	PASS
	64	0.13	0.24	11	PASS

802.11ac VHT40	54	-2.19	-1.89	11	PASS
	62	-1.67	-1.37	11	PASS
802.11ac VHT80	58	-7.33	-6.80	11	PASS

Note: Power Spectral Density =Read Value+Duty cycle correction factor

U-NII-2C

Mode	Channel Number	Read Value (dBm /MHz)	Power Spectral Density (dBm /MHz)	Limit (dBm /MHz)	Conclusion
802.11a	100	-0.91	-0.91	11	PASS
	104	-0.32	-0.32	11	PASS
	120	0.56	0.56	11	PASS
	136	0.67	0.67	11	PASS
	140	-1.59	-1.59	11	PASS
802.11n HT20	100	-2.65	-2.51	11	PASS
	104	-0.6	-0.46	11	PASS
	120	0.05	0.19	11	PASS
	136	0.32	0.46	11	PASS
	140	-1.77	-1.63	11	PASS
802.11n HT40	102	-6.12	-5.82	11	PASS
	110	-2.58	-2.28	11	PASS
	118	-2.11	-1.81	11	PASS
	134	-2.02	-1.72	11	PASS
802.11ac VHT20	100	-0.34	-0.23	11	PASS
	120	0.08	0.19	11	PASS
	140	0.2	0.31	11	PASS
802.11ac VHT40	102	-2.55	-2.25	11	PASS
	118	-1.94	-1.64	11	PASS
	134	-1.77	-1.47	11	PASS
802.11ac VHT80	106	-7.66	-7.13	11	PASS
	122	-6.81	-6.28	11	PASS

Note: Power Spectral Density =Read Value+Duty cycle correction factor

U-NII-3

Mode	Channel Number	Read Value (dBm/470kHz)	Power Spectral Density (dBm/500kHz)	Limit (dBm/500kHz)	Conclusion
802.11a	149	-3.89	-3.62	30	PASS
	157	-3.41	-3.14	30	PASS
	165	-2.87	-2.60	30	PASS
802.11n HT20	149	-4.09	-3.68	30	PASS
	157	-3.5	-3.09	30	PASS
	165	-3.25	-2.84	30	PASS
802.11n HT40	151	-6.33	-5.76	30	PASS
	159	-6.05	-5.48	30	PASS
802.11ac VHT20	149	-4.2	-3.82	30	PASS
	157	-3.81	-3.43	30	PASS
	165	-3.15	-2.77	30	PASS
802.11ac VHT40	151	-6.19	-5.62	30	PASS
	159	-5.94	-5.37	30	PASS
802.11ac VHT80	155	-10.9	-10.10	30	PASS

Note: PSD=Read Value+Duty cycle correction factor +10*log(500/470)

U-NII-1

PSD 802.11a 5180MHz

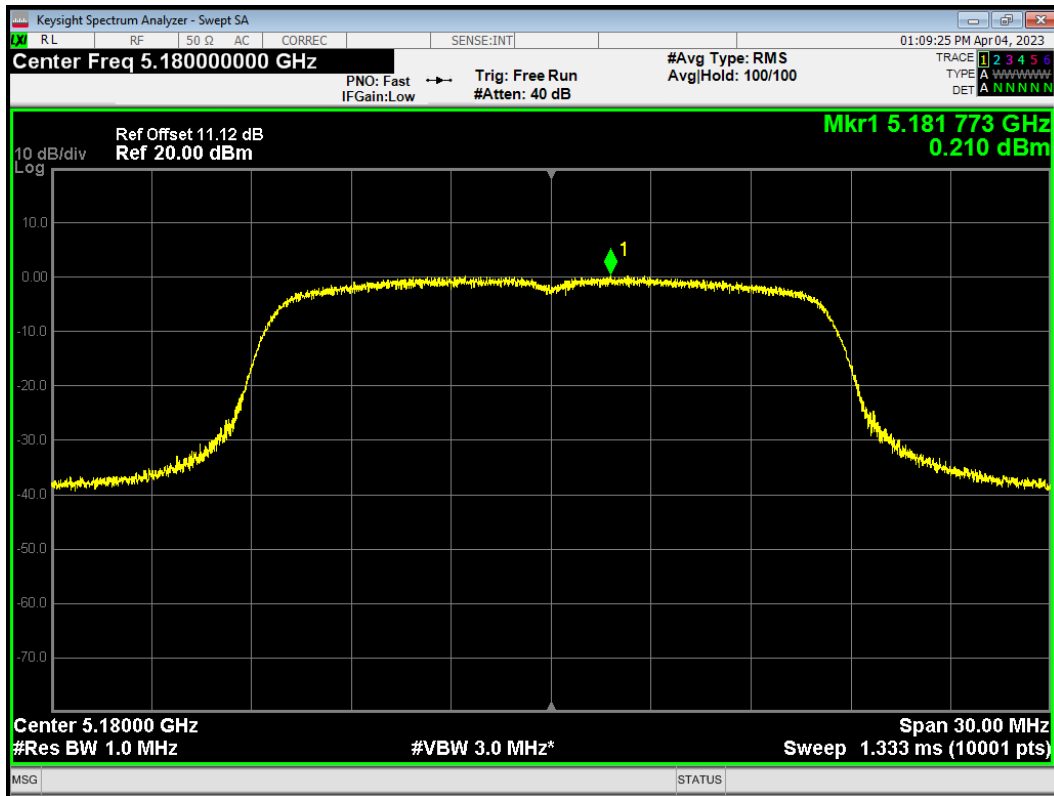

PSD 802.11a 5200MHz

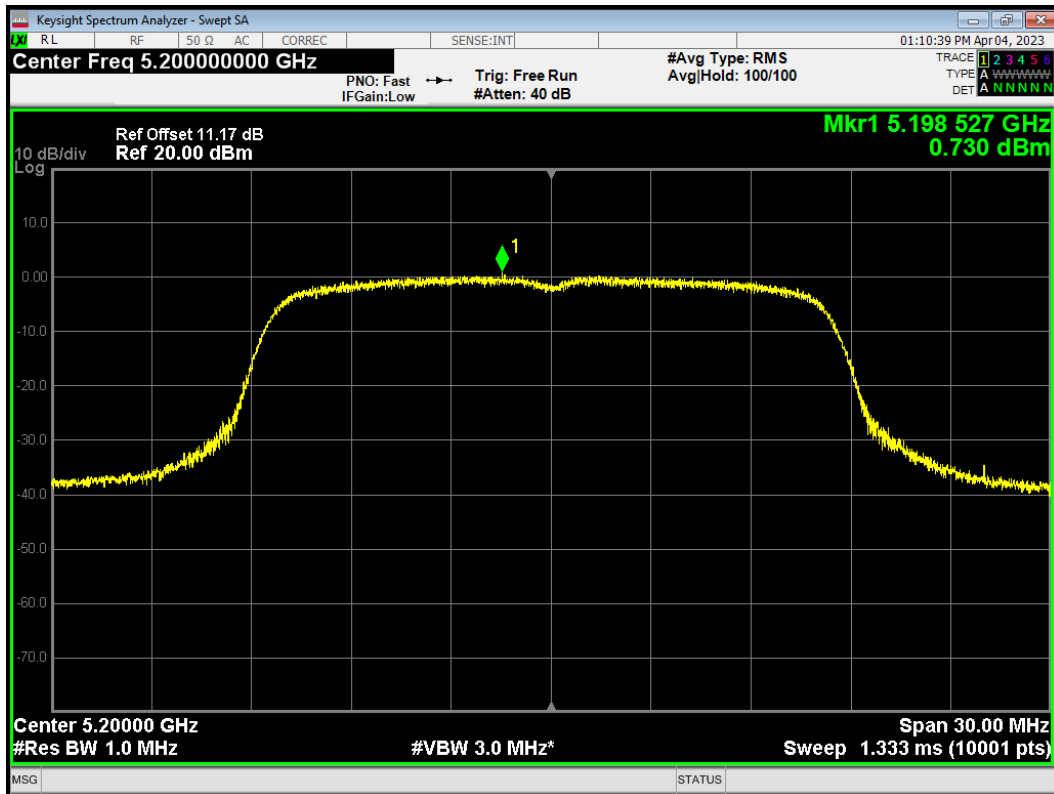

PSD 802.11a 5240MHz

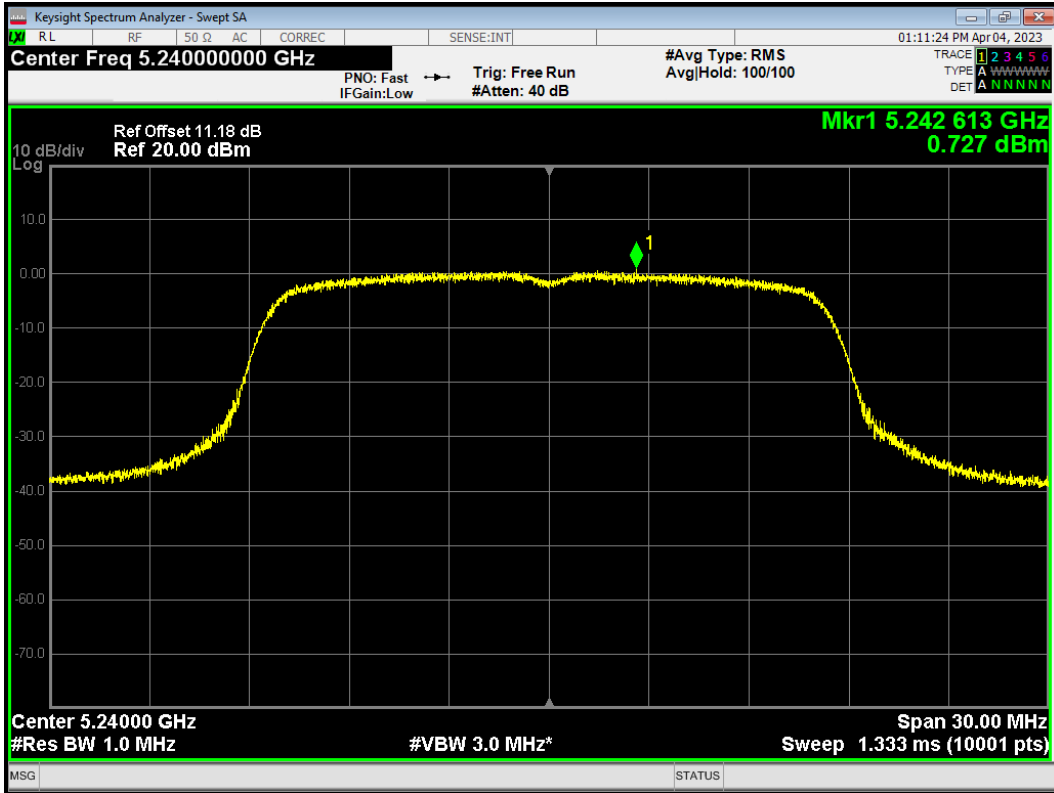

PSD 802.11ac(VHT20) 5180MHz

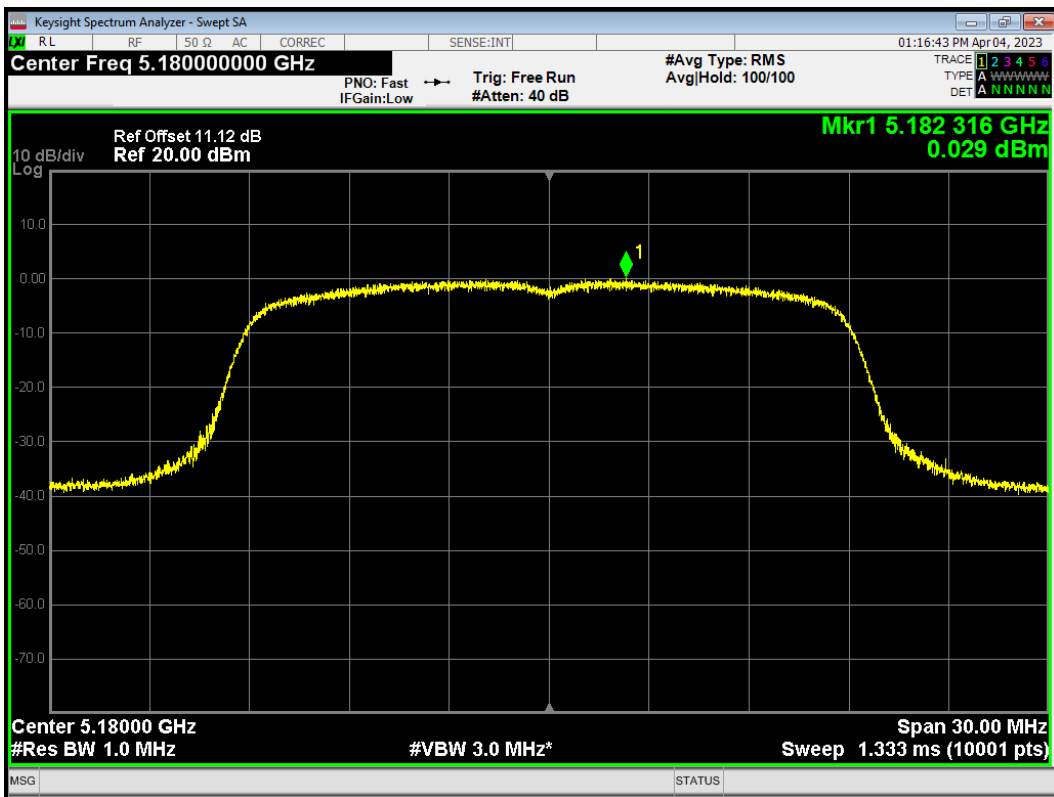

PSD 802.11ac(VHT20) 5200MHz

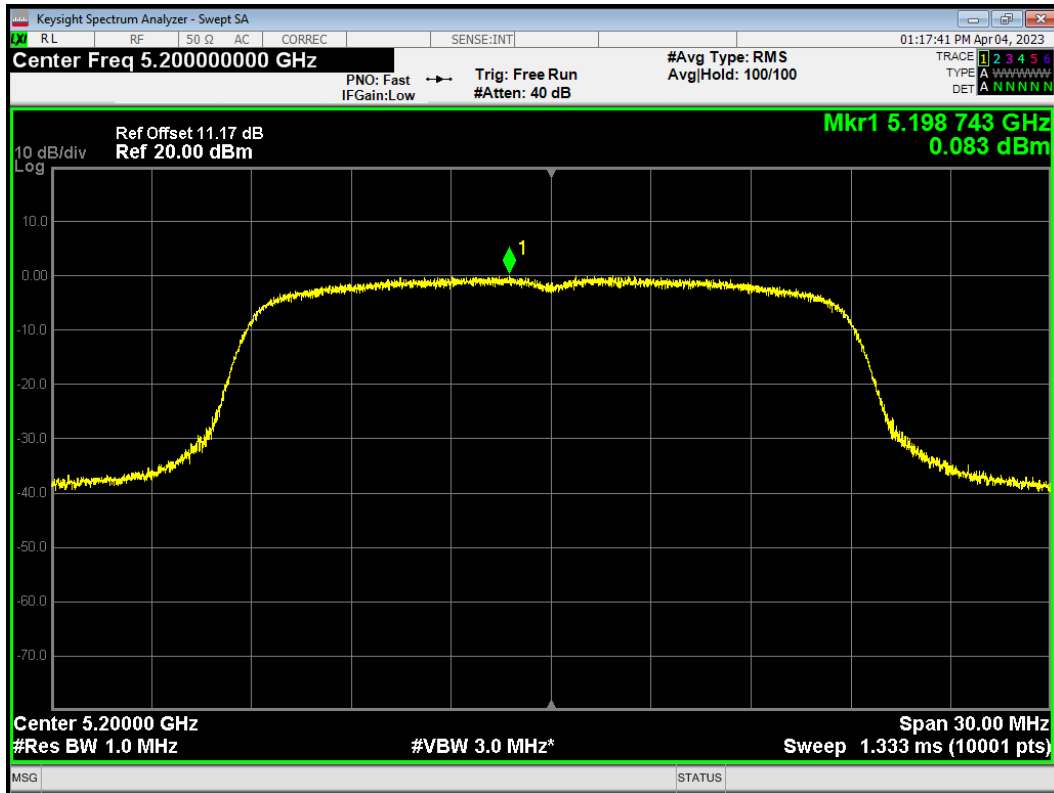

PSD 802.11ac(VHT20) 5240MHz

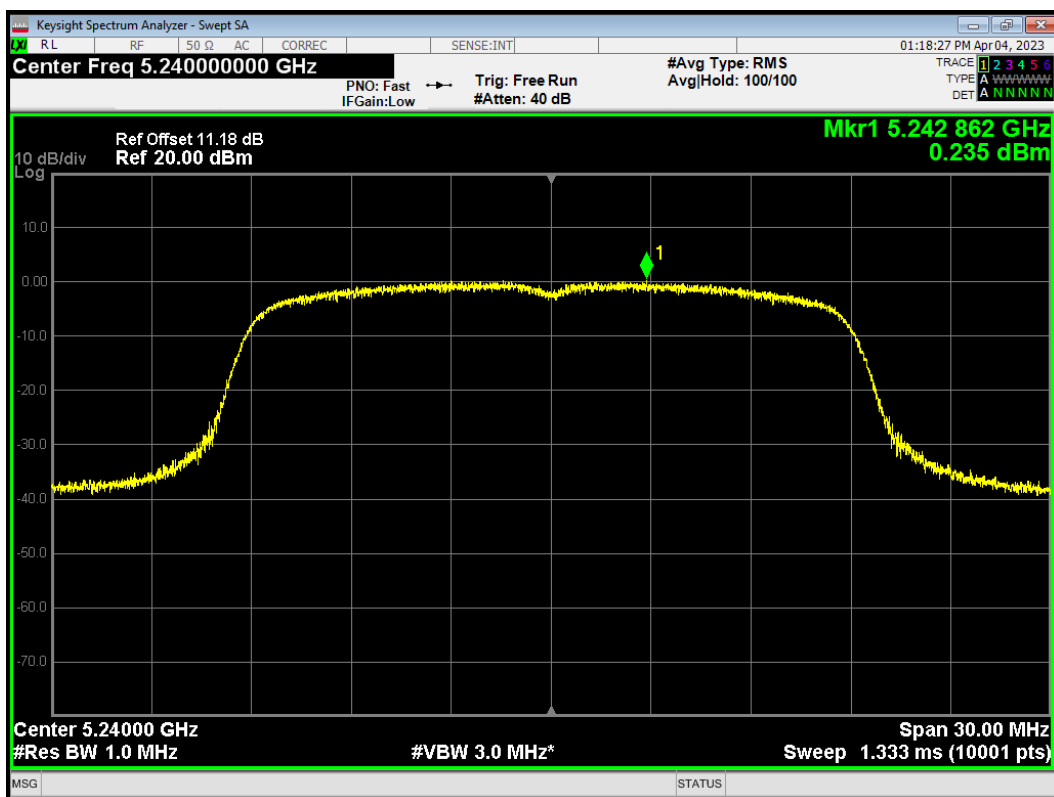

PSD 802.11ac(VHT40) 5190MHz

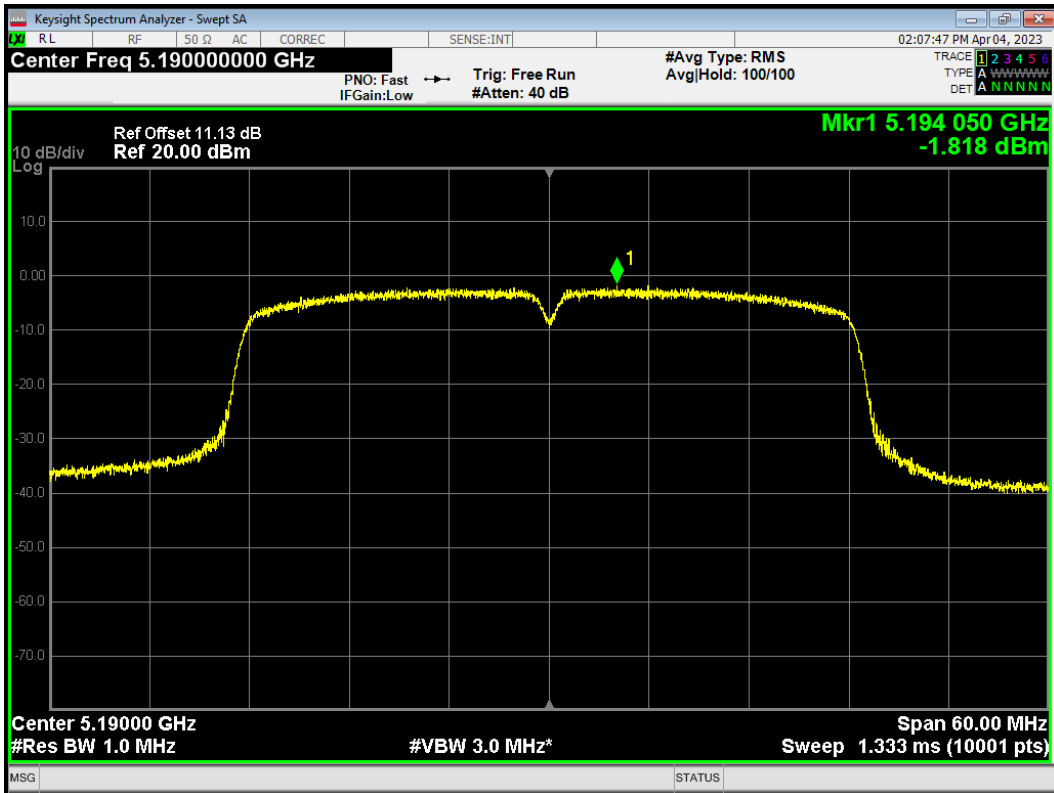

PSD 802.11ac(VHT40) 5230MHz

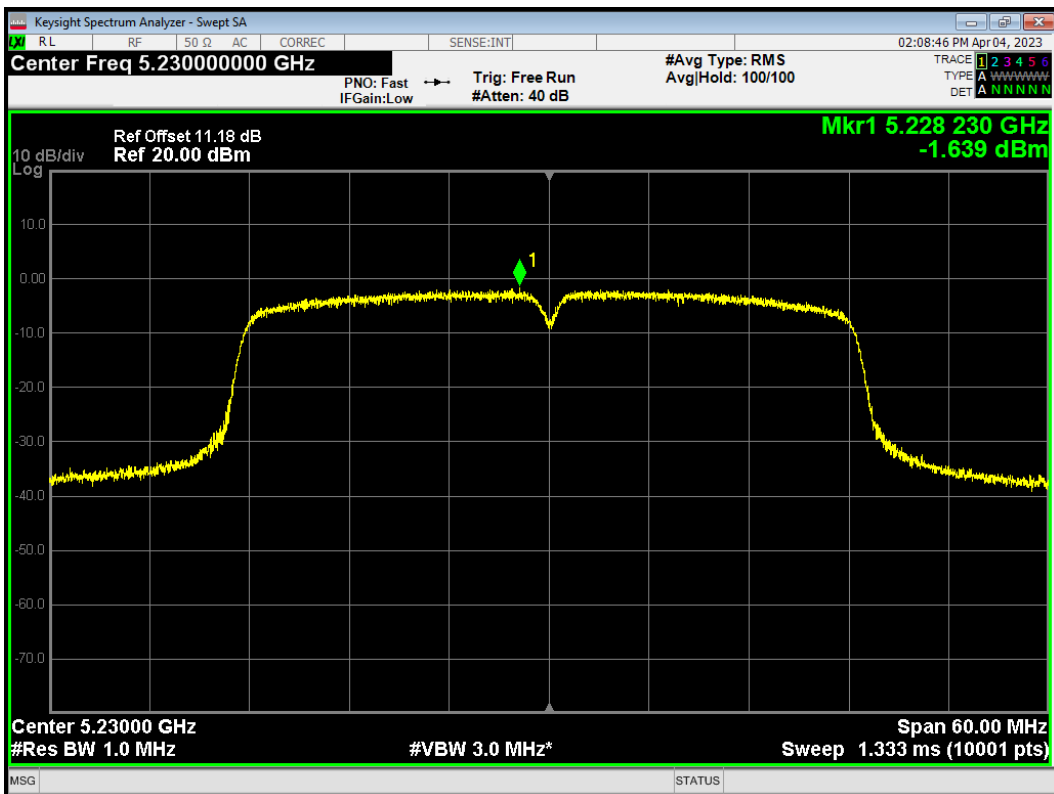

PSD 802.11ac(VHT80) 5210MHz

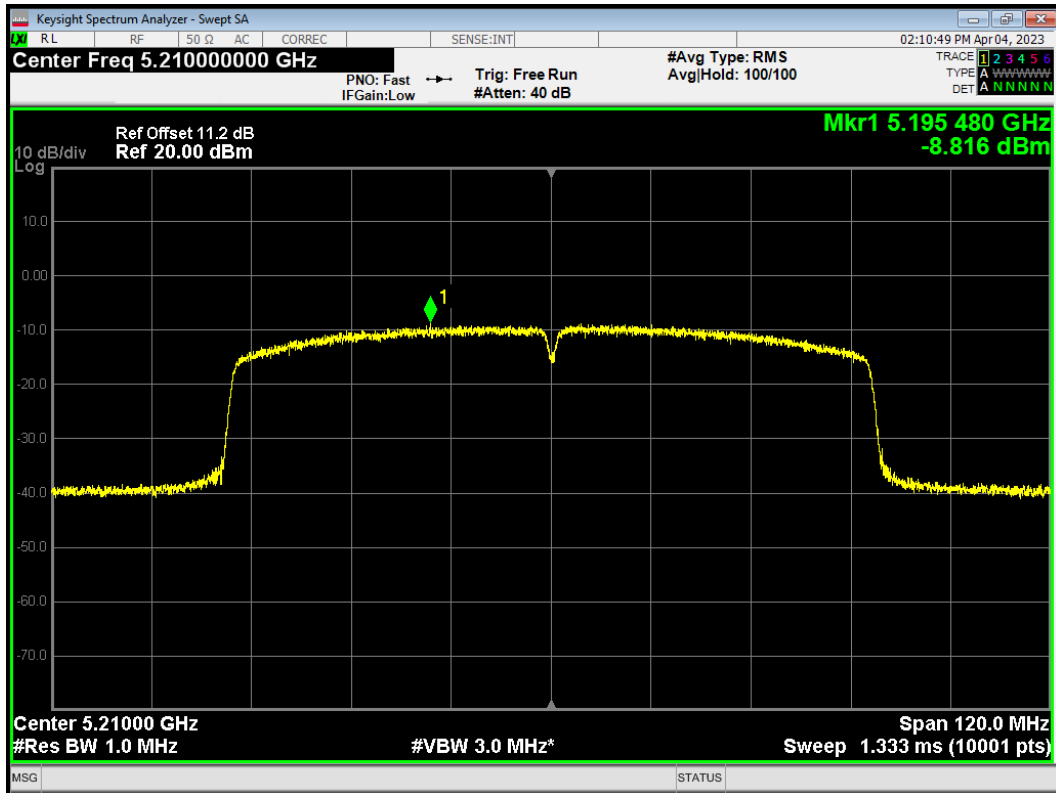

PSD 802.11n(HT20) 5180MHz

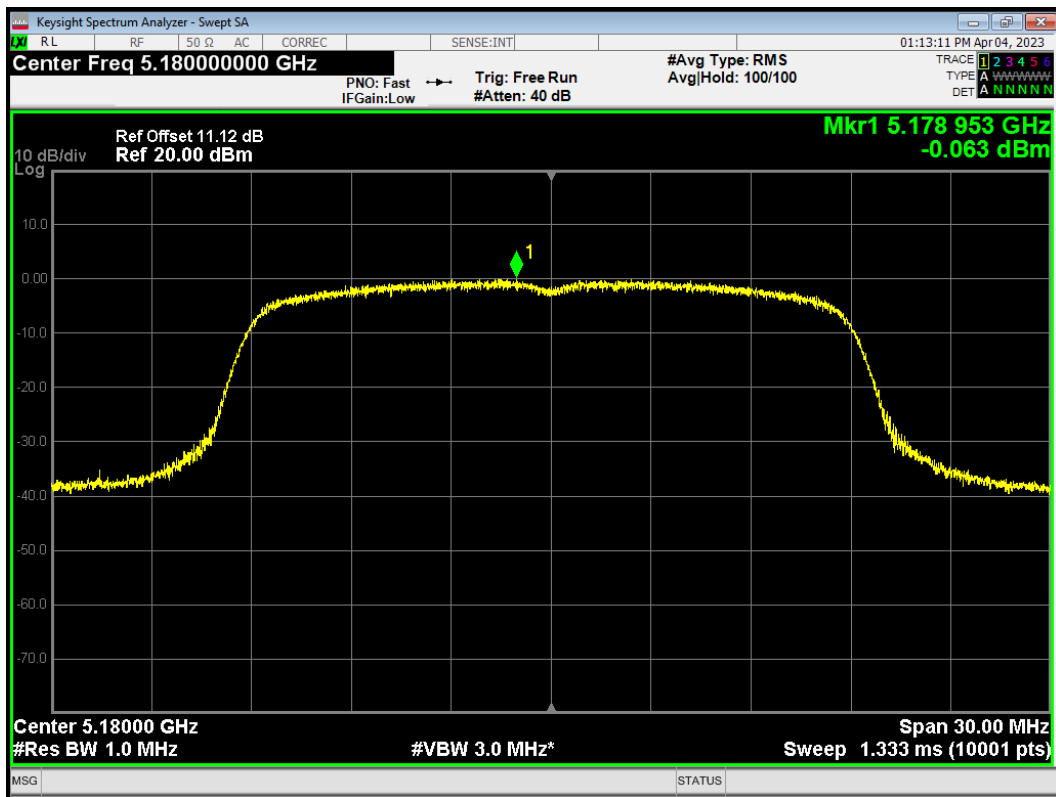

PSD 802.11n(HT20) 5200MHz

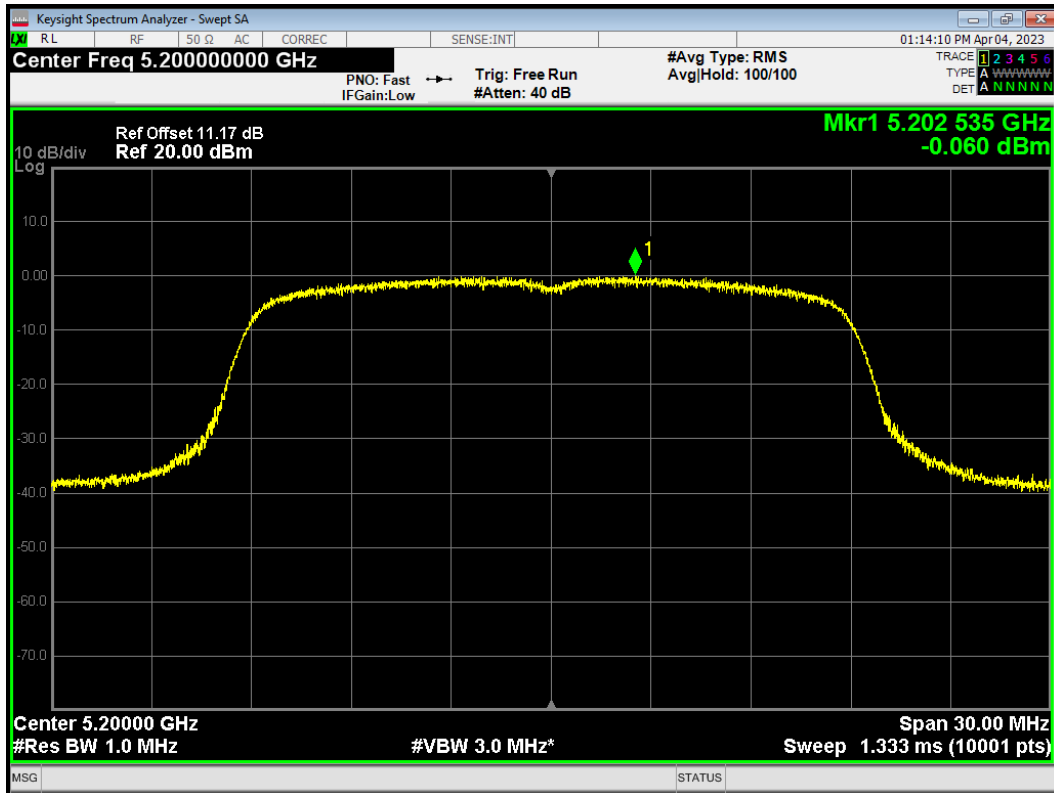

PSD 802.11n(HT20) 5240MHz

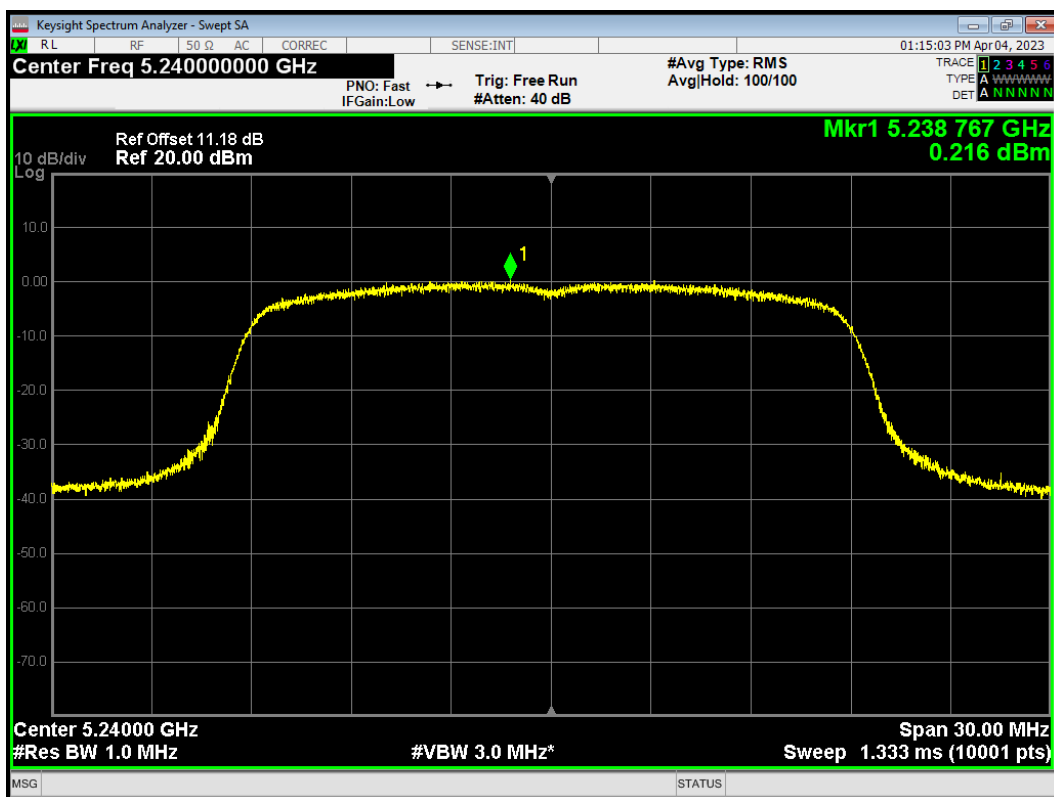

PSD 802.11n(HT40) 5190MHz

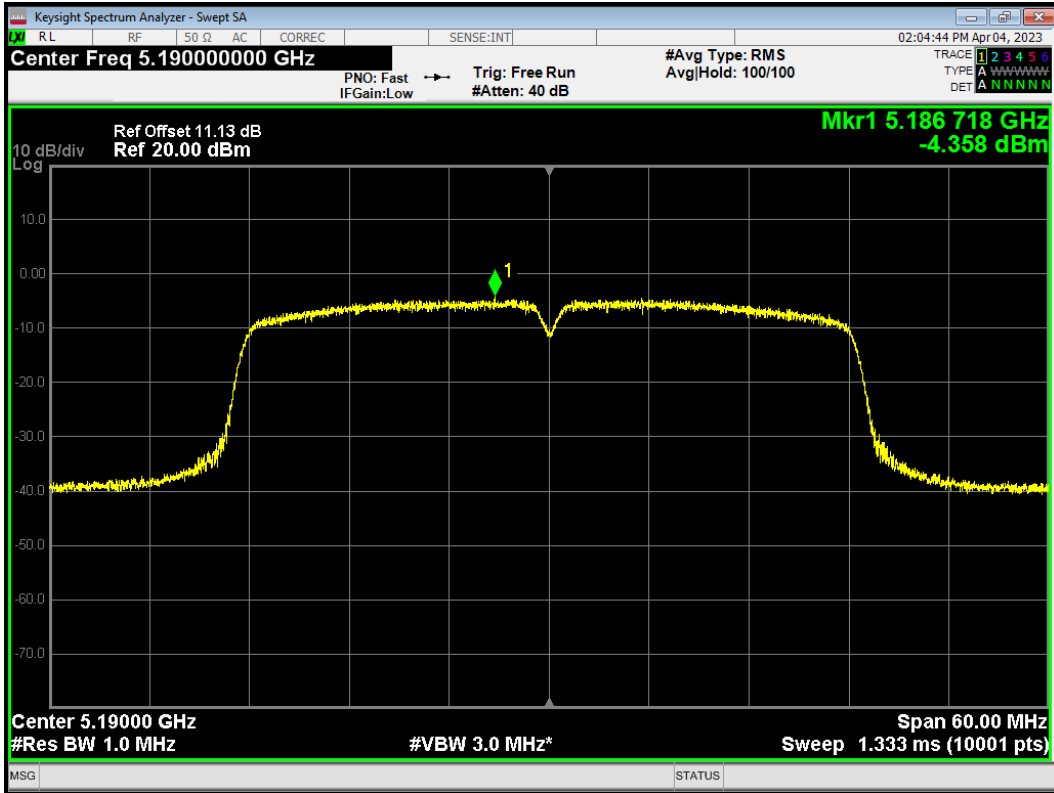

PSD 802.11n(HT40) 5230MHz

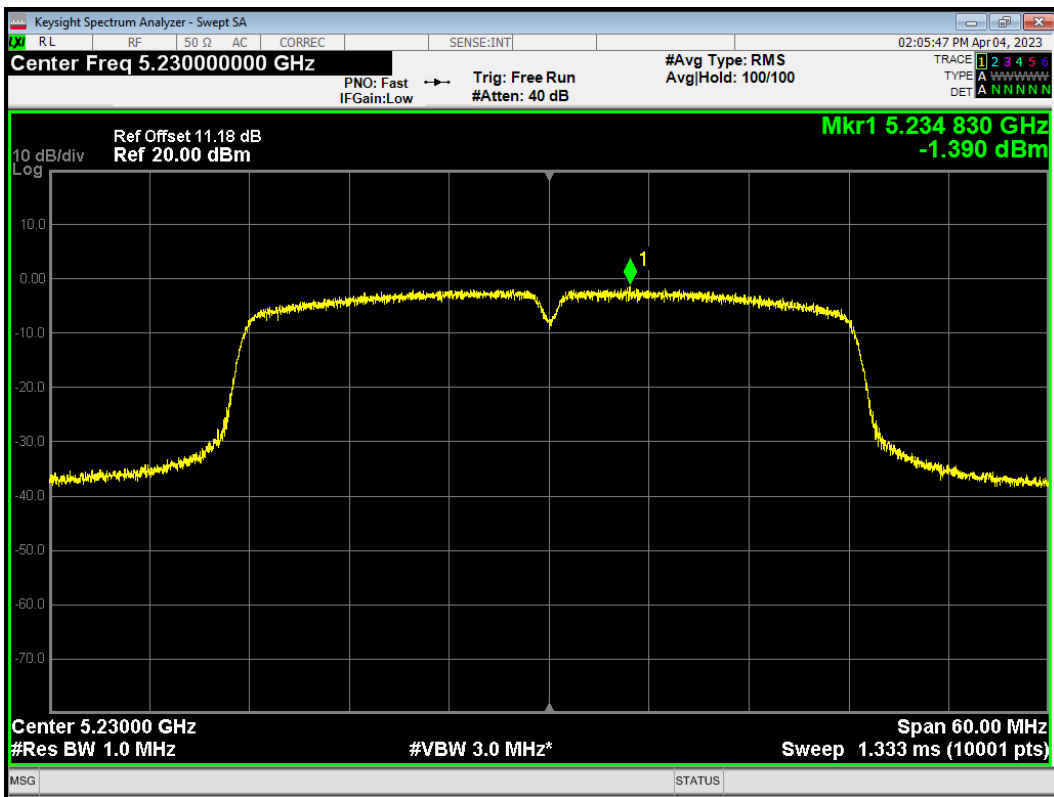

U-NII-2A

PSD 802.11a 5260MHz

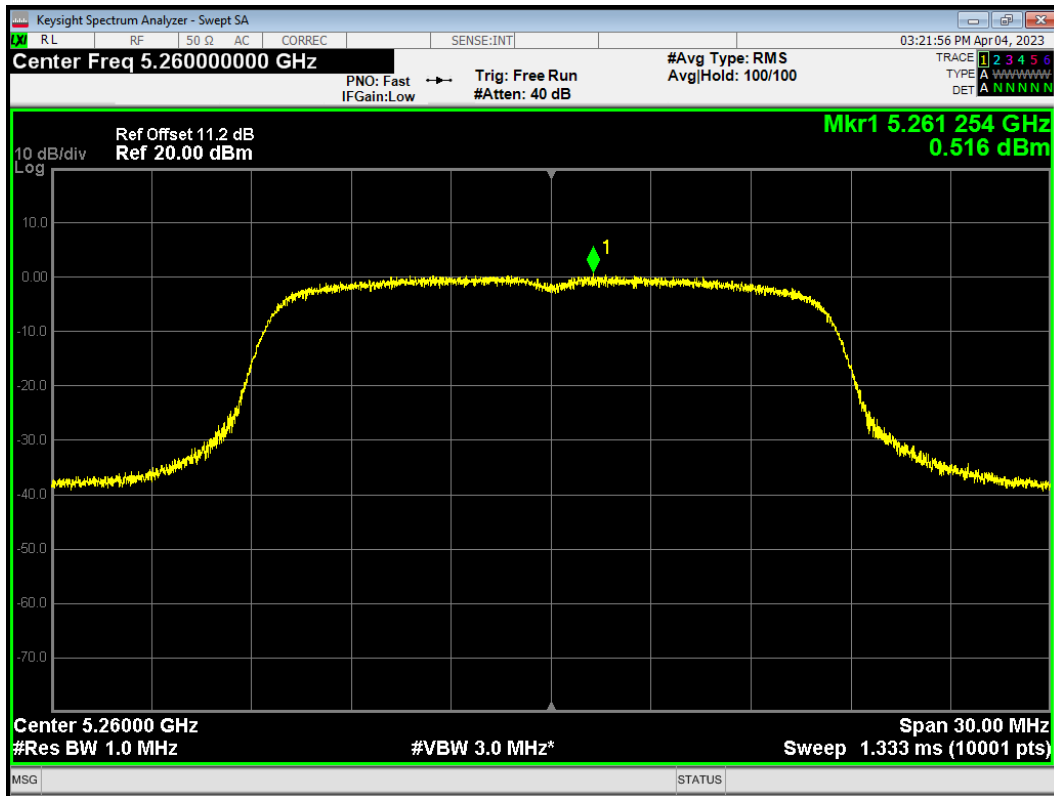

PSD 802.11a 5300MHz

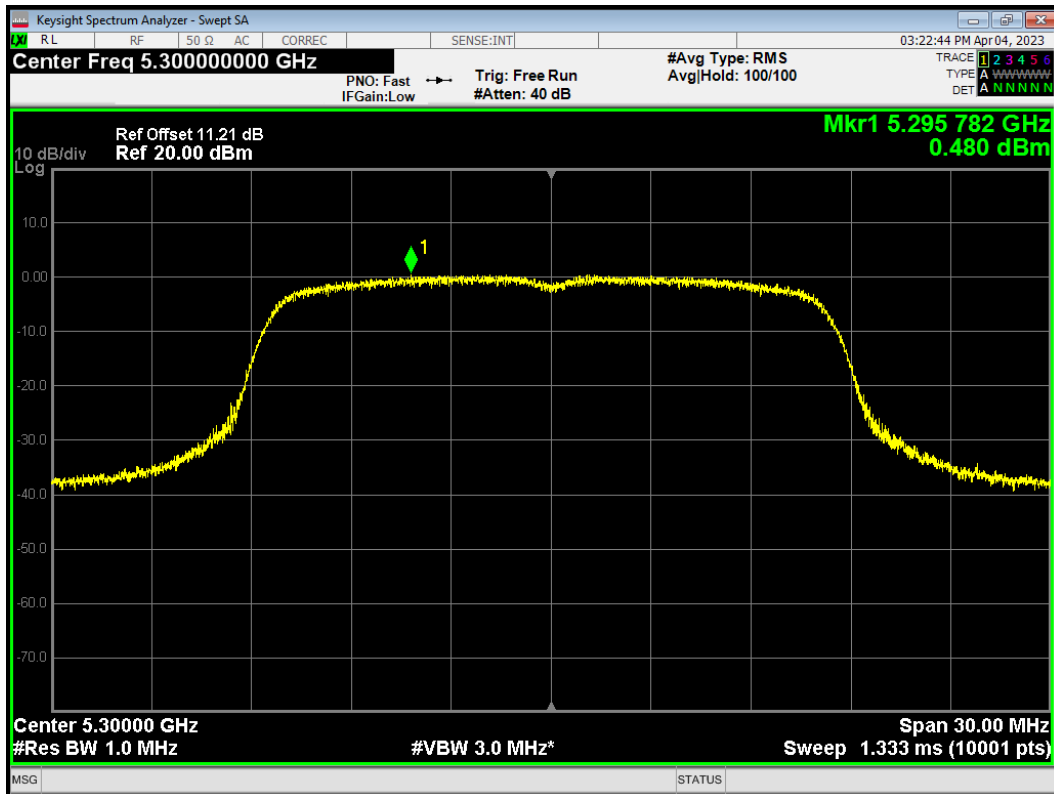

PSD 802.11a 5320MHz

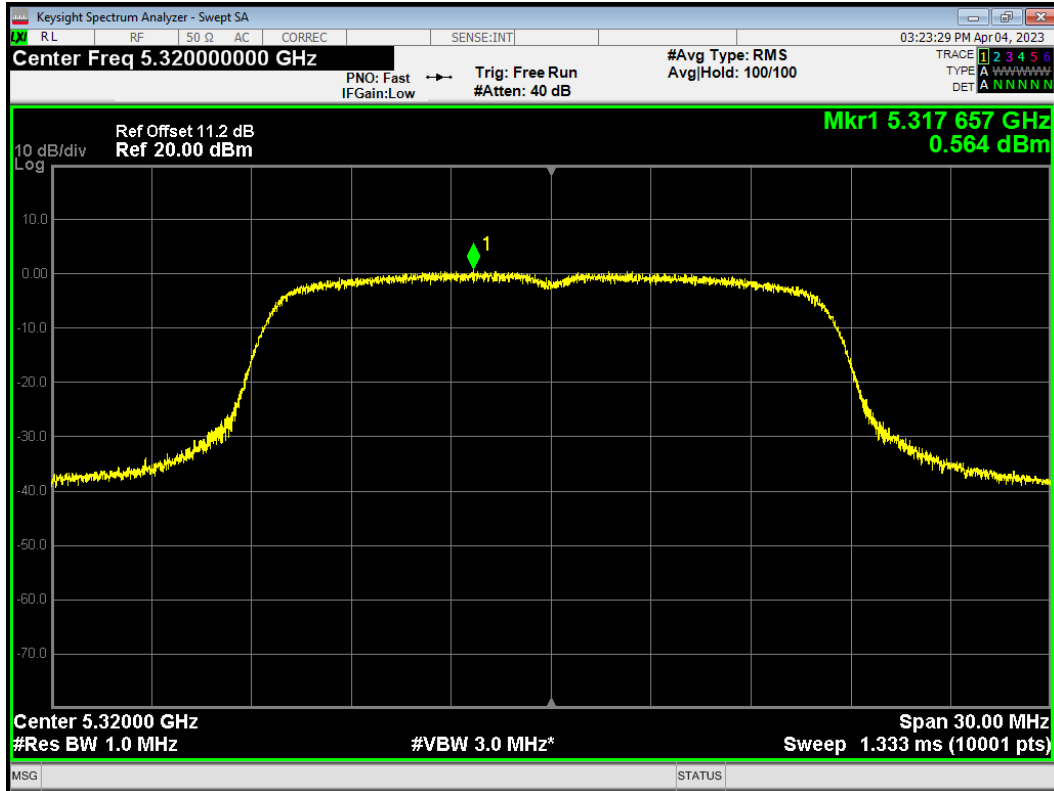

PSD 802.11ac(VHT20) 5260MHz

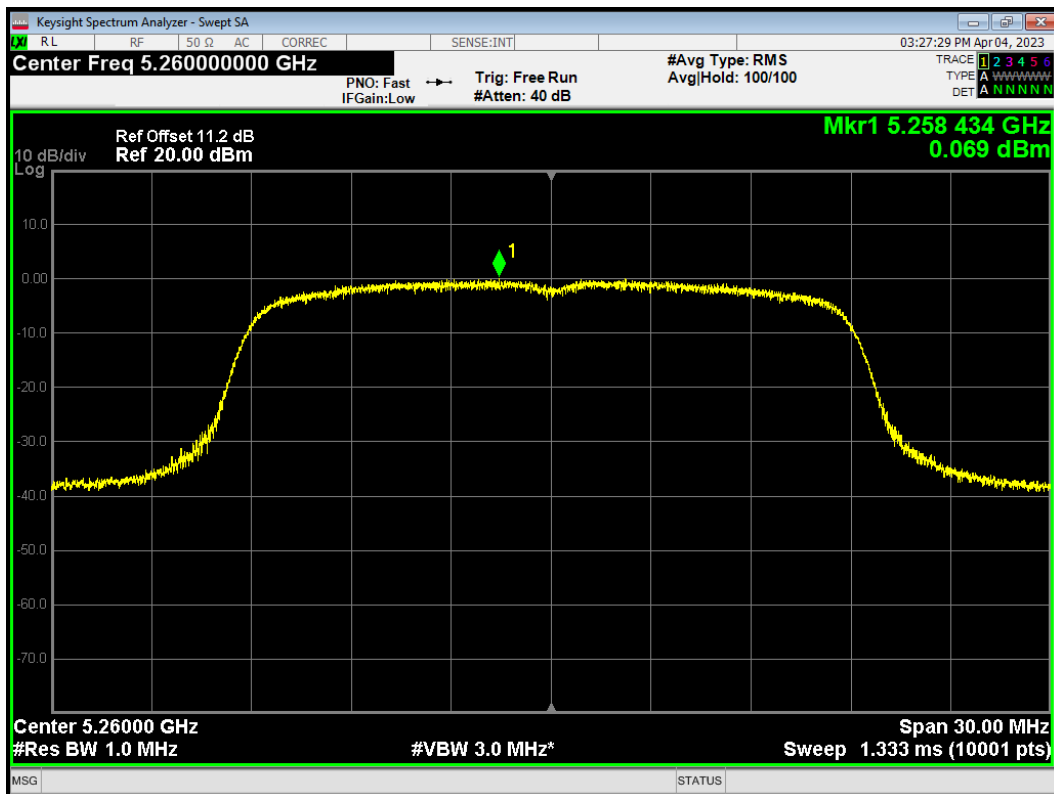

PSD 802.11ac(VHT20) 5300MHz

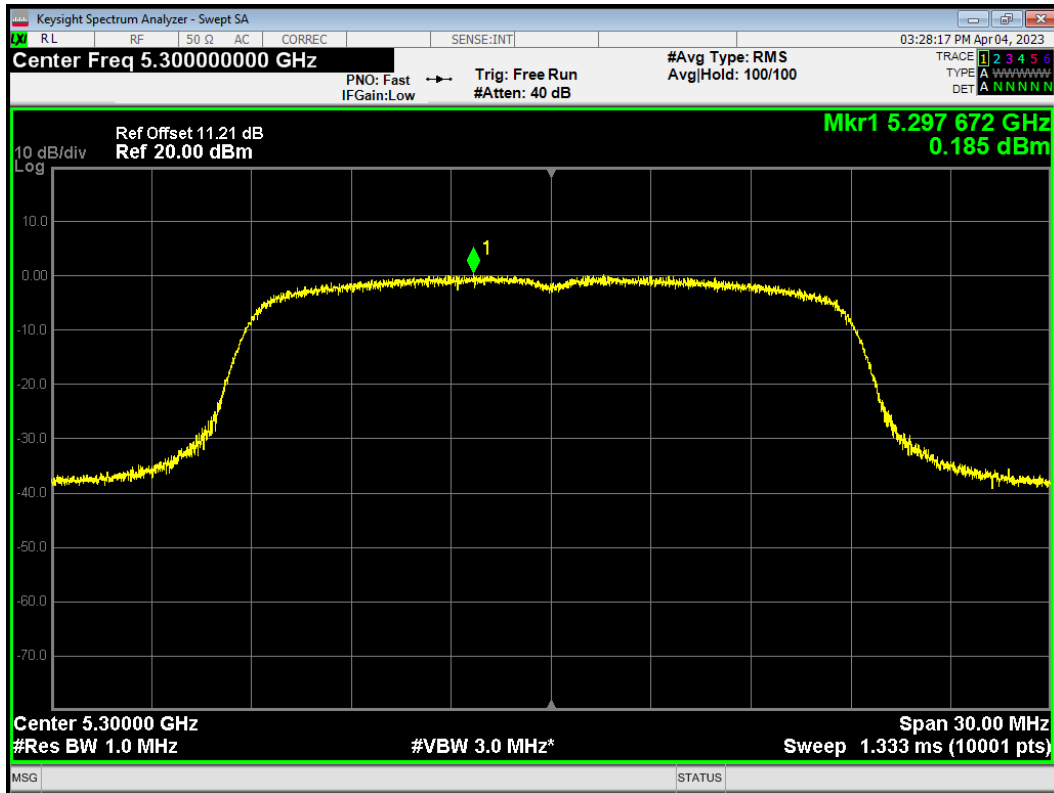

PSD 802.11ac(VHT20) 5320MHz

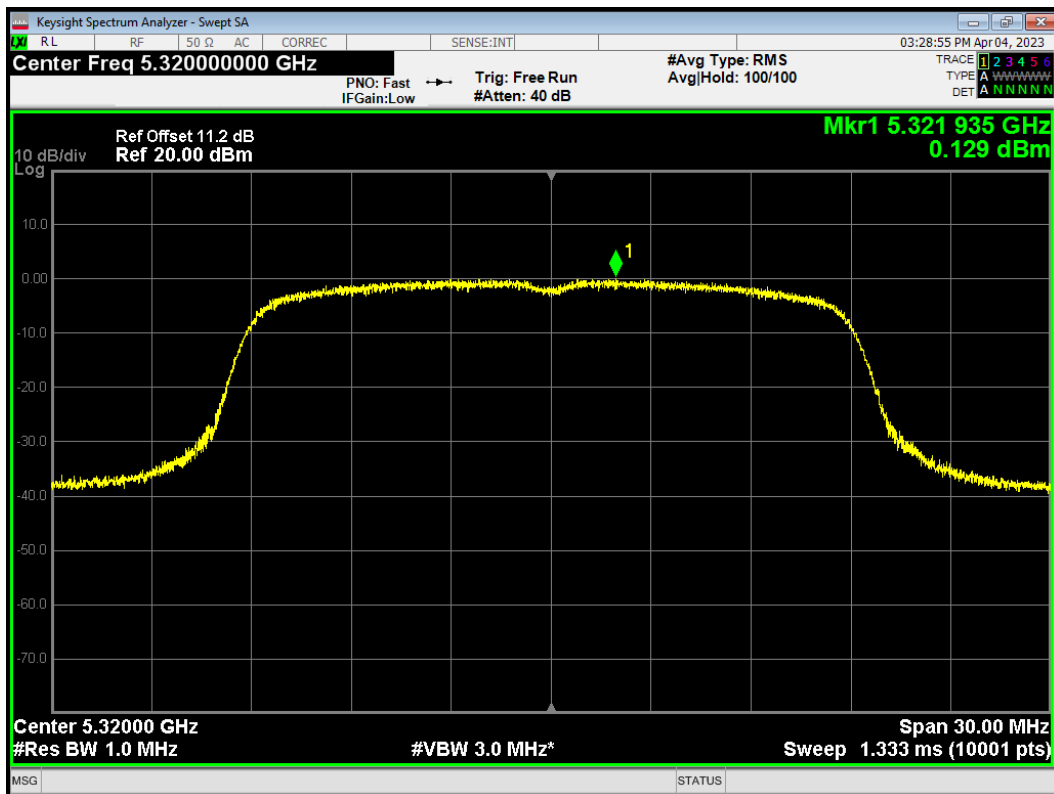

PSD 802.11ac(VHT40) 5270MHz

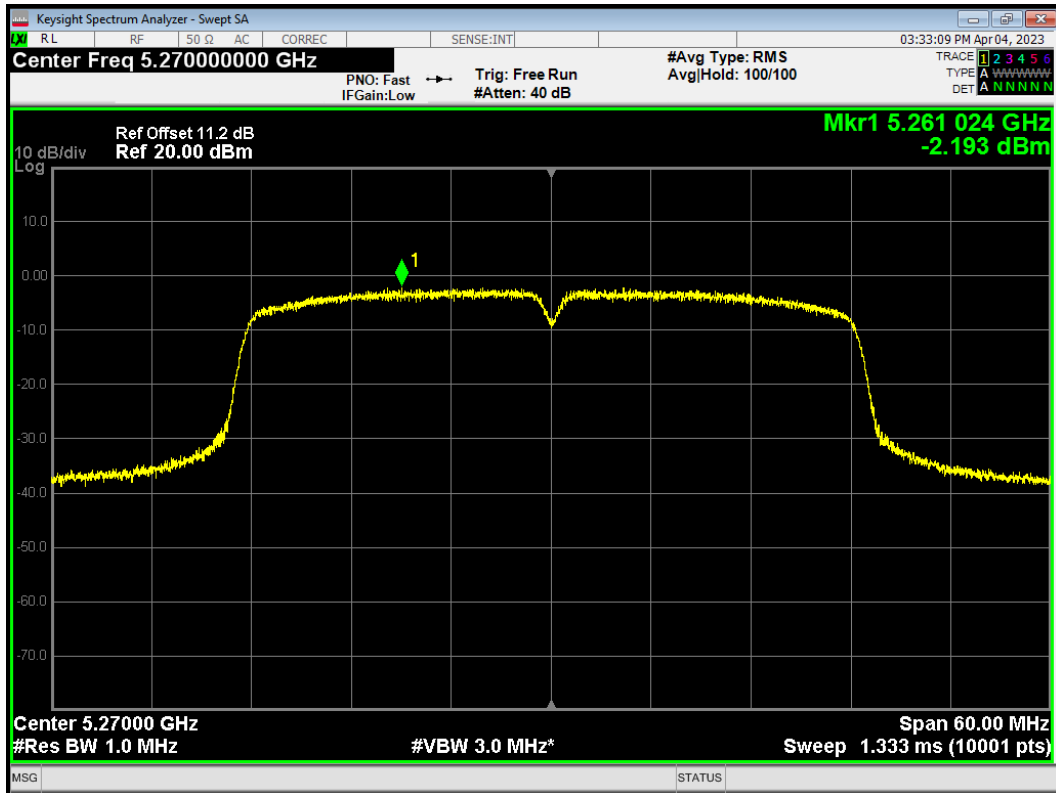

PSD 802.11ac(VHT40) 5310MHz

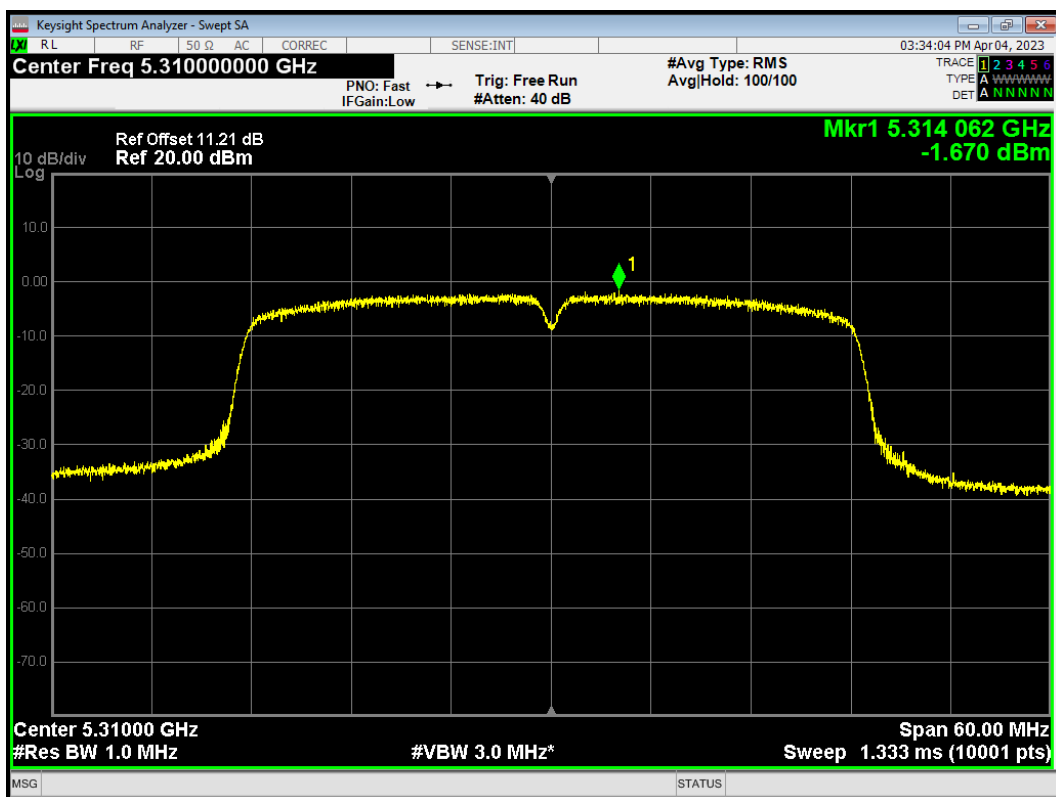

PSD 802.11ac(VHT80) 5290MHz

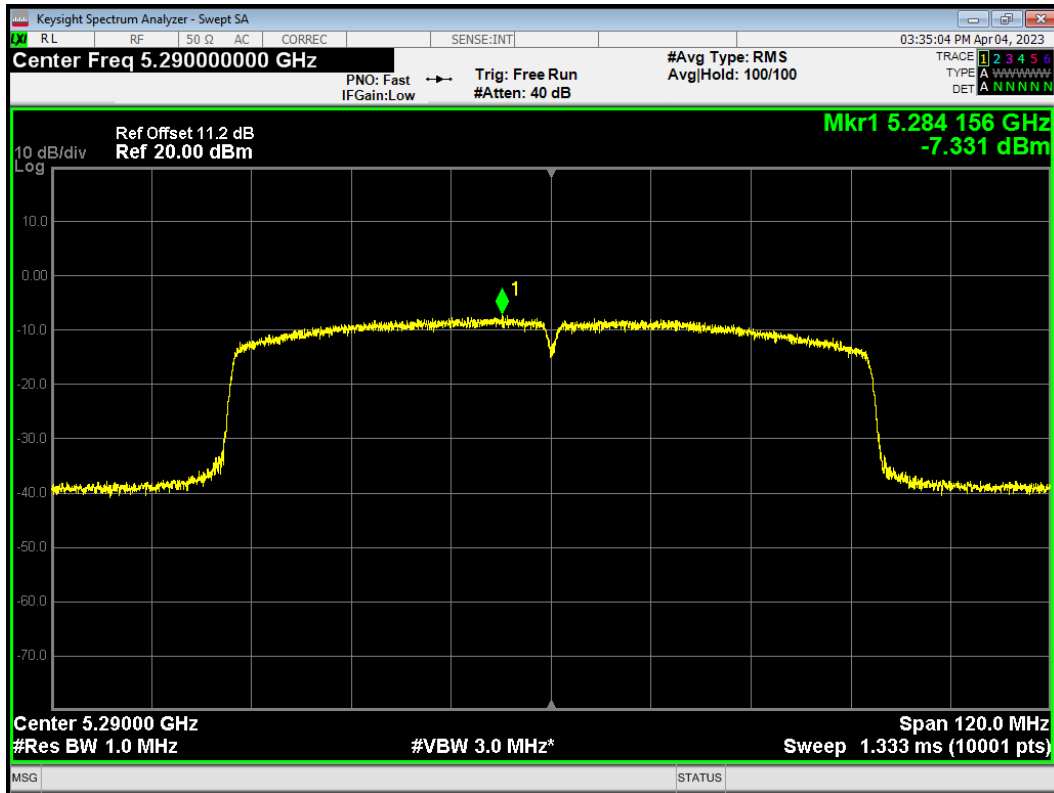

PSD 802.11n(HT20) 5260MHz

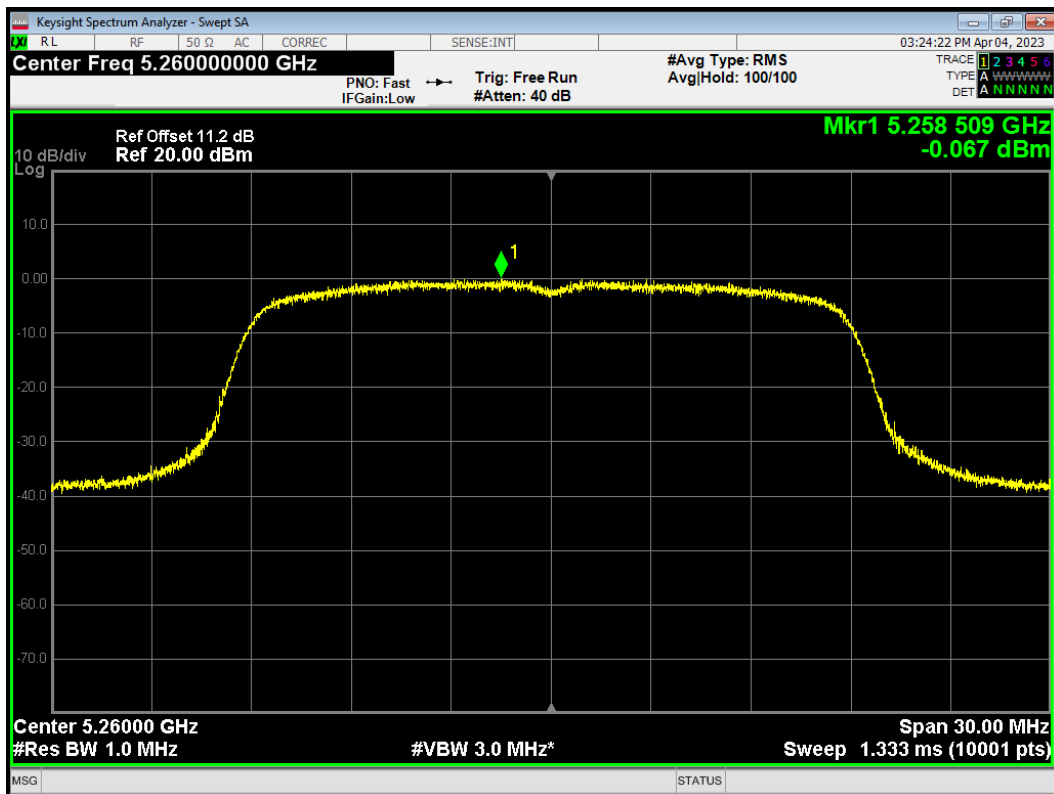

PSD 802.11n(HT20) 5300MHz

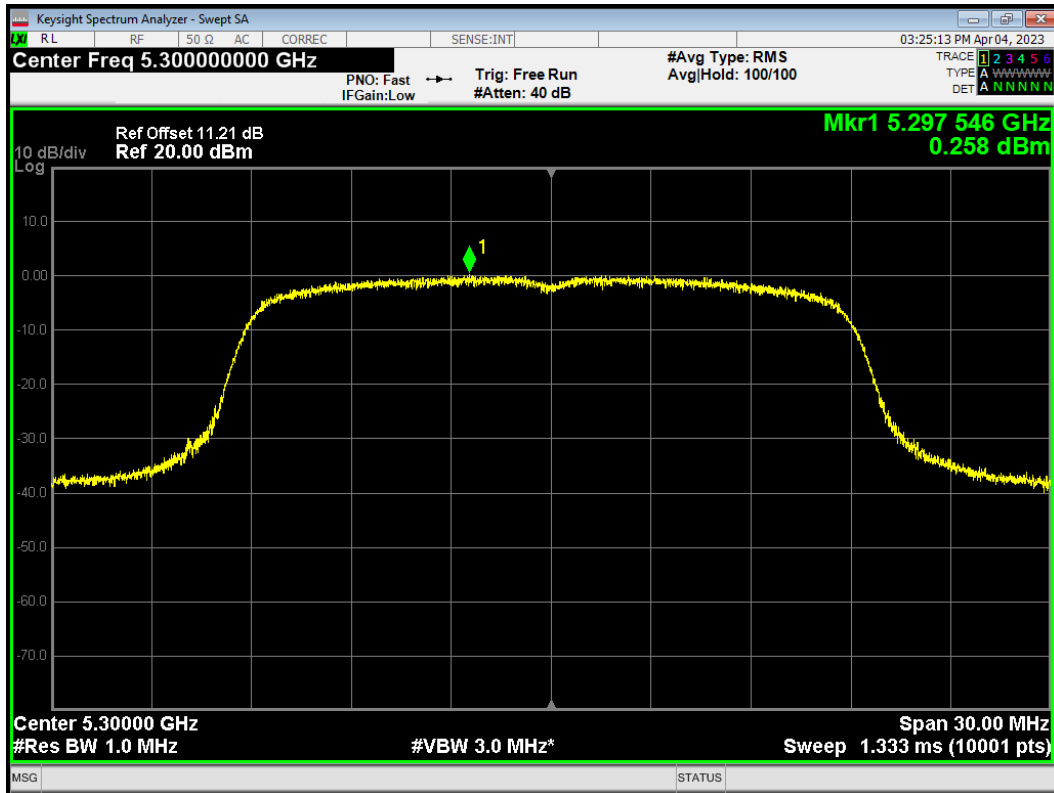

PSD 802.11n(HT20) 5320MHz

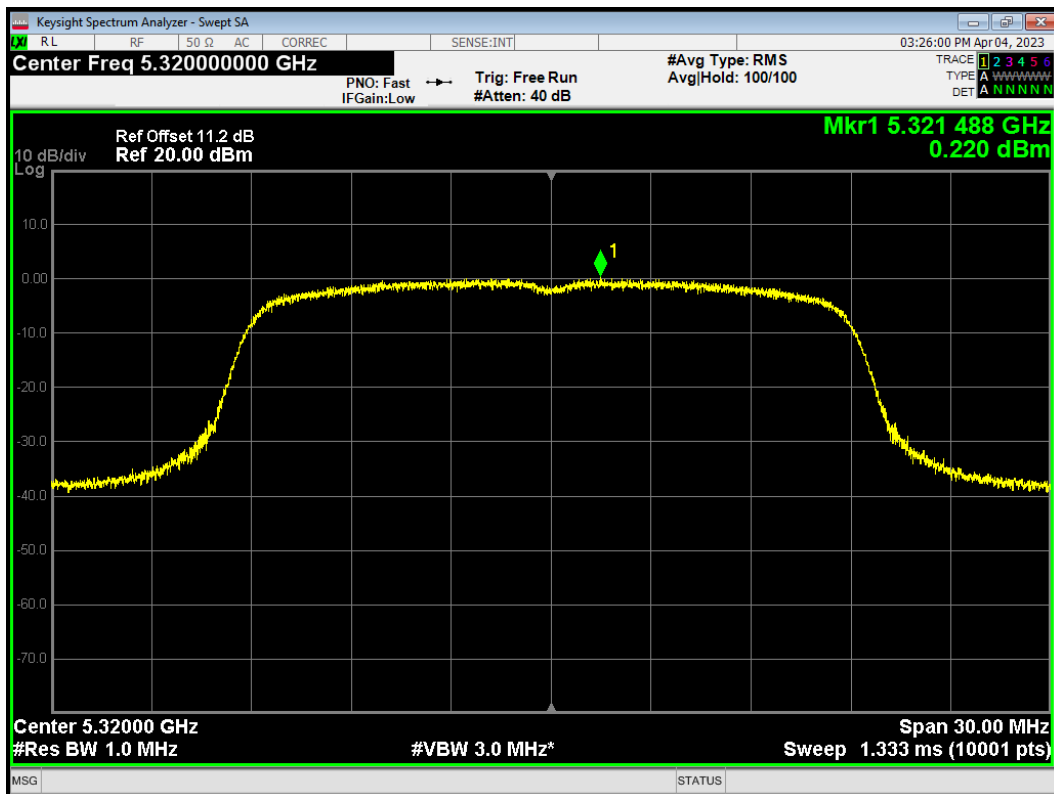

PSD 802.11n(HT40) 5270MHz

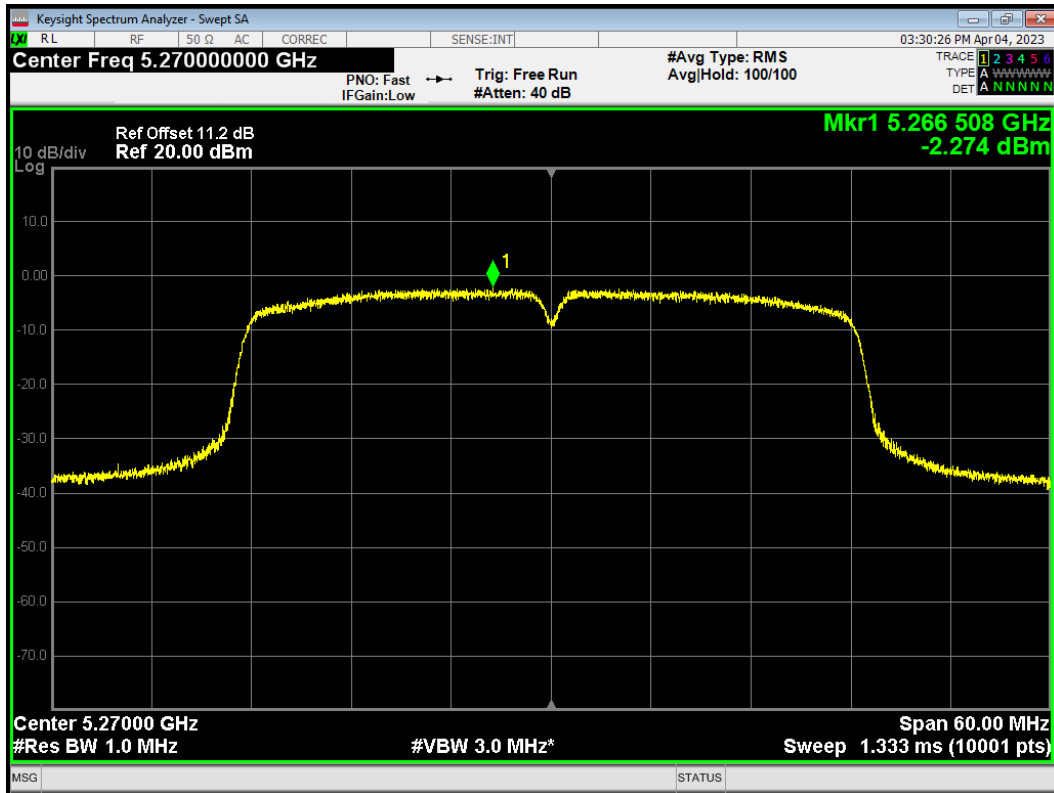

PSD 802.11n(HT40) 5310MHz

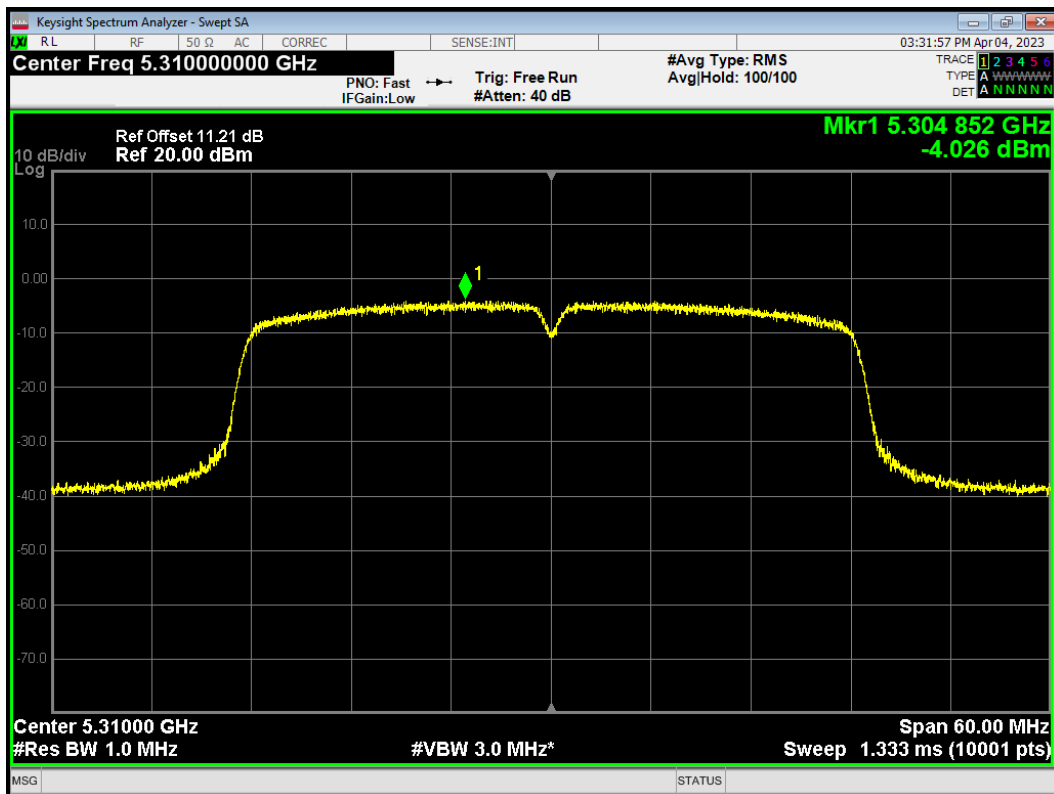

U-NII-2C

PSD 802.11a 5500MHz

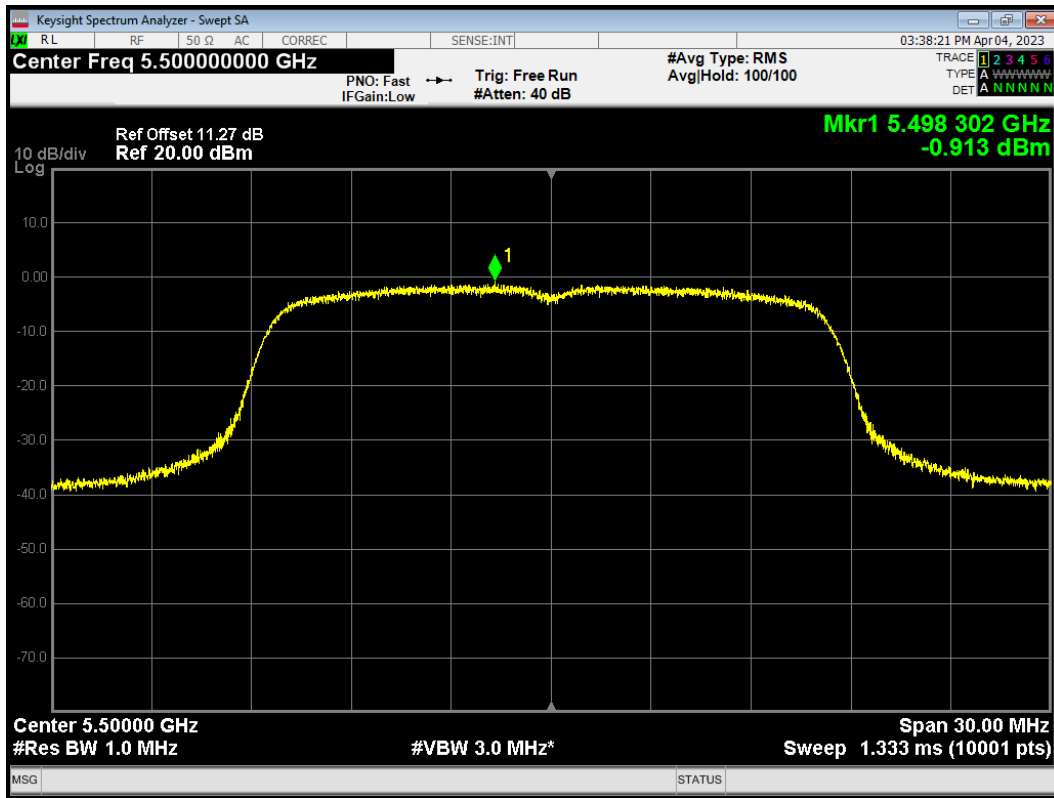

PSD 802.11a 5520MHz

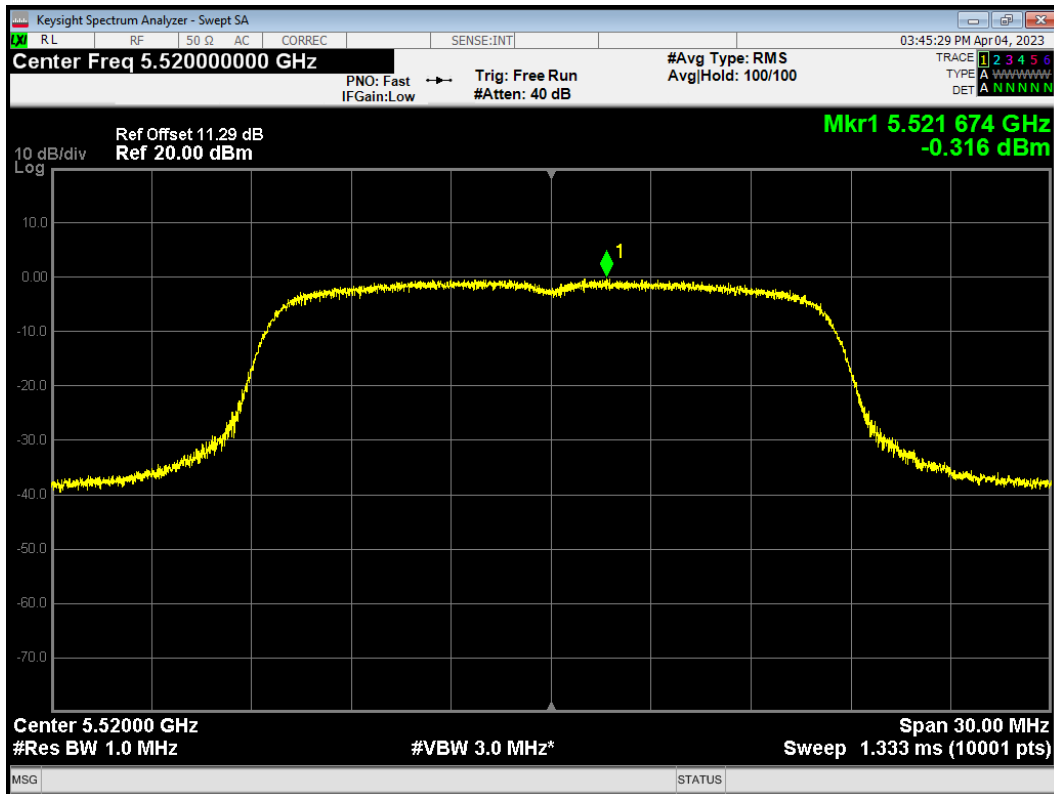

PSD 802.11a 5600MHz

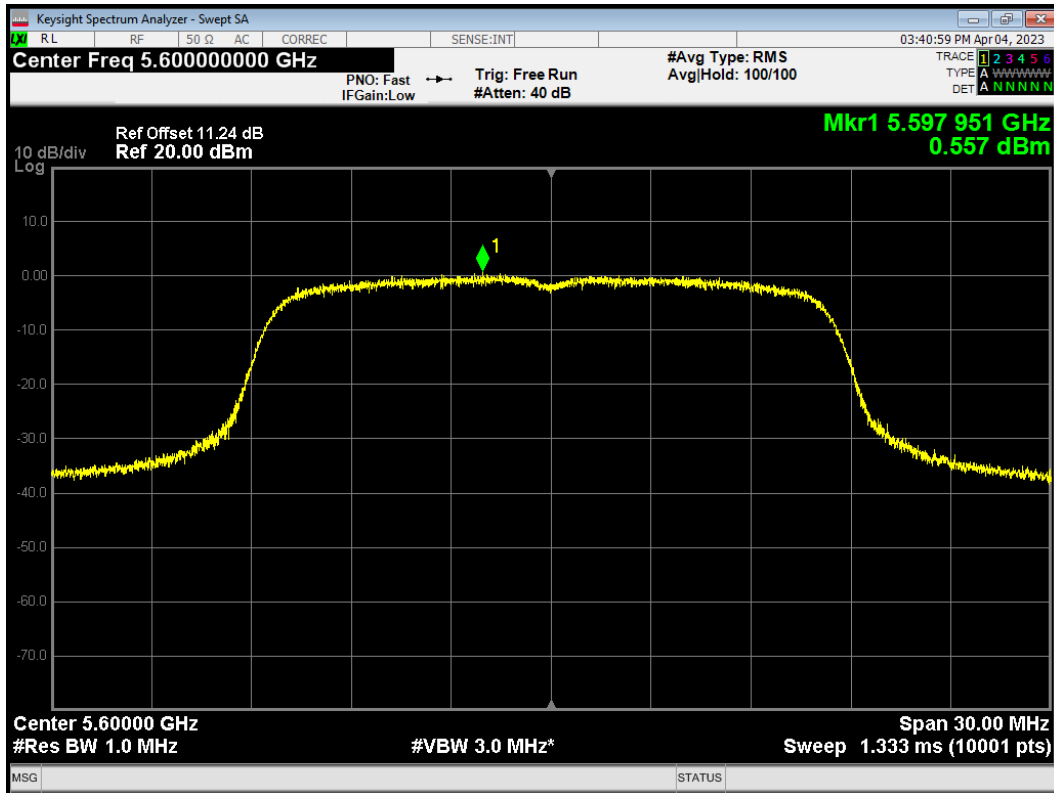

PSD 802.11a 5680MHz

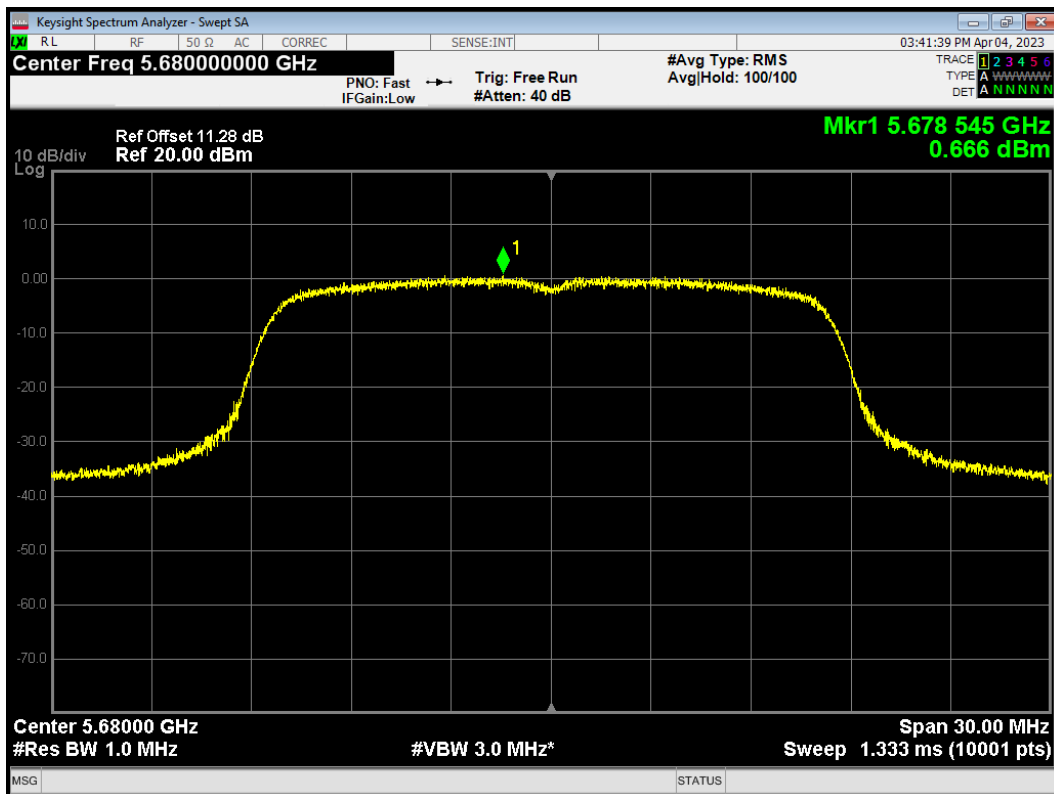

PSD 802.11a 5700MHz

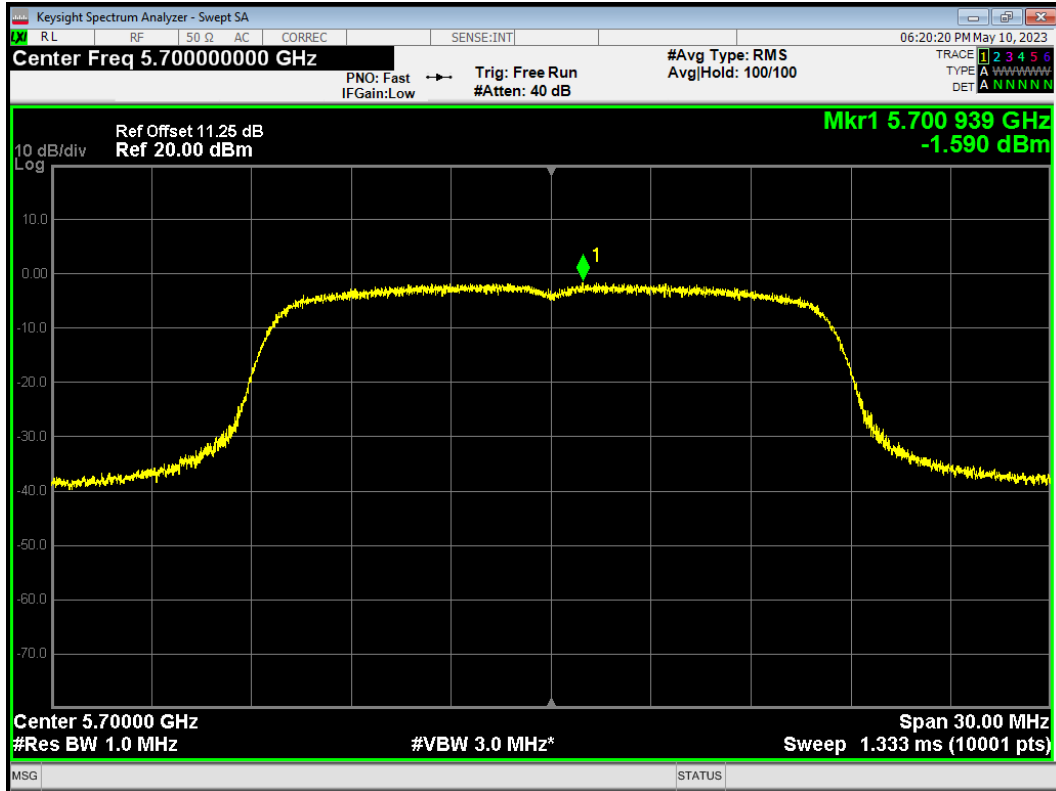

PSD 802.11ac(VHT20) 5500MHz

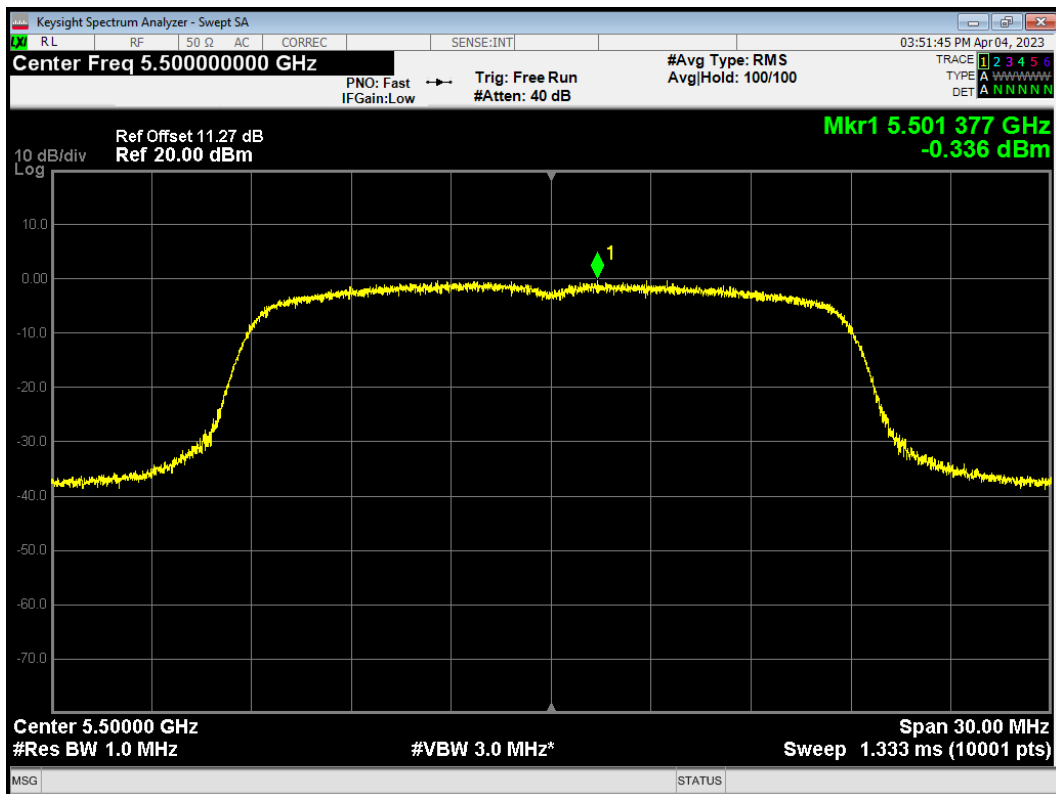

PSD 802.11ac(VHT20) 5600MHz

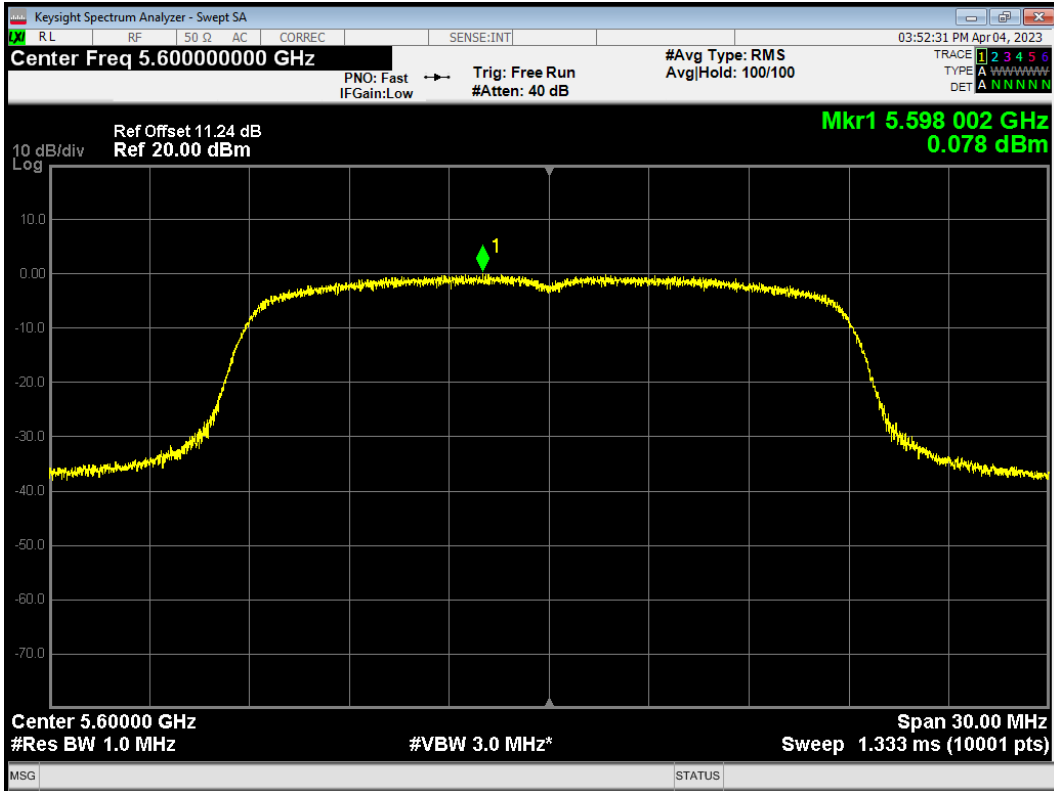

PSD 802.11ac(VHT20) 5700MHz

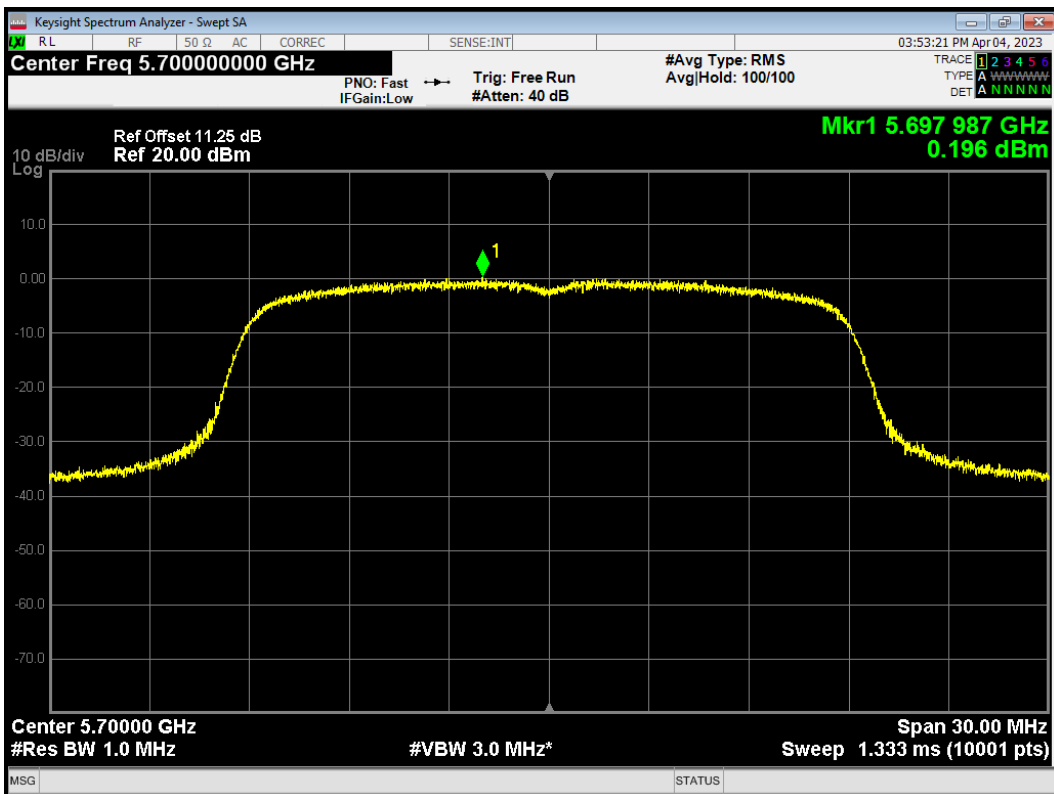

PSD 802.11ac(VHT40) 5510MHz

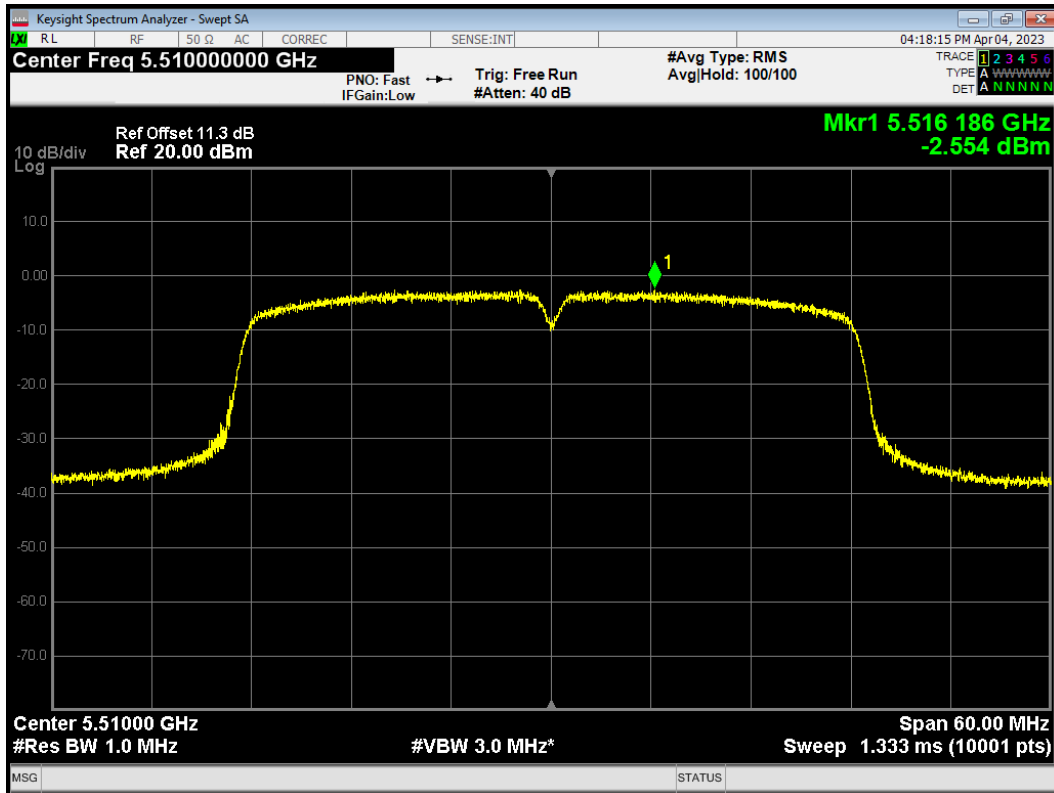

PSD 802.11ac(VHT40) 5590MHz

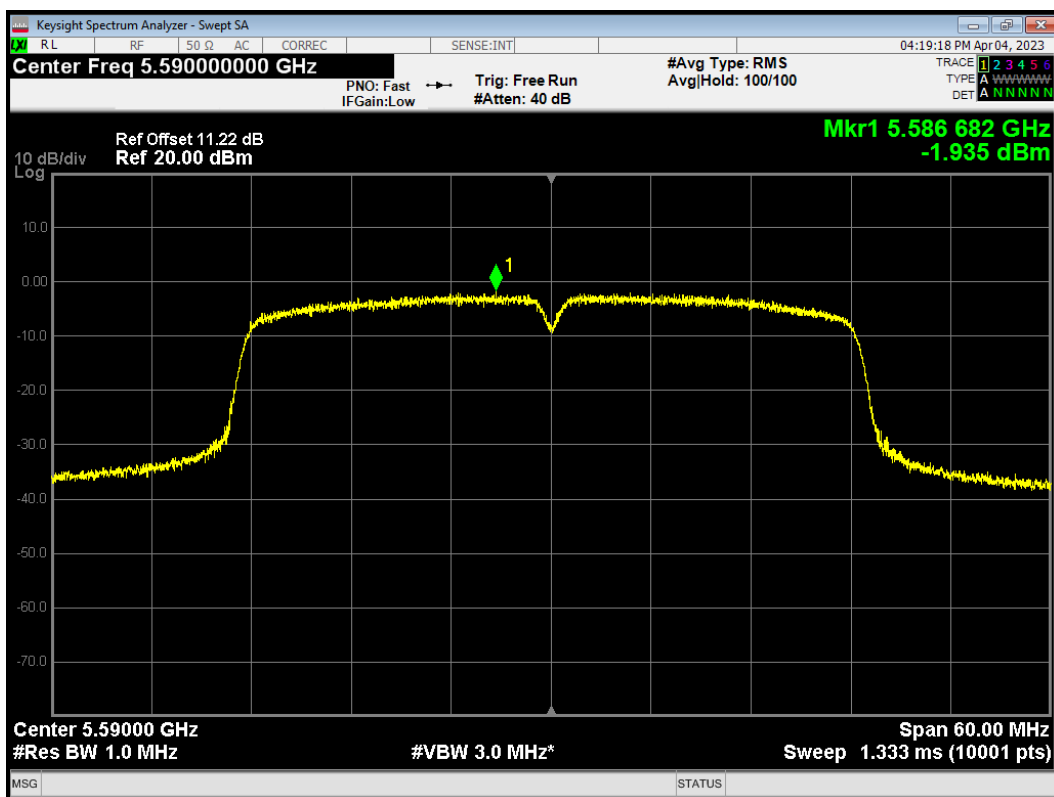

PSD 802.11ac(VHT40) 5670MHz

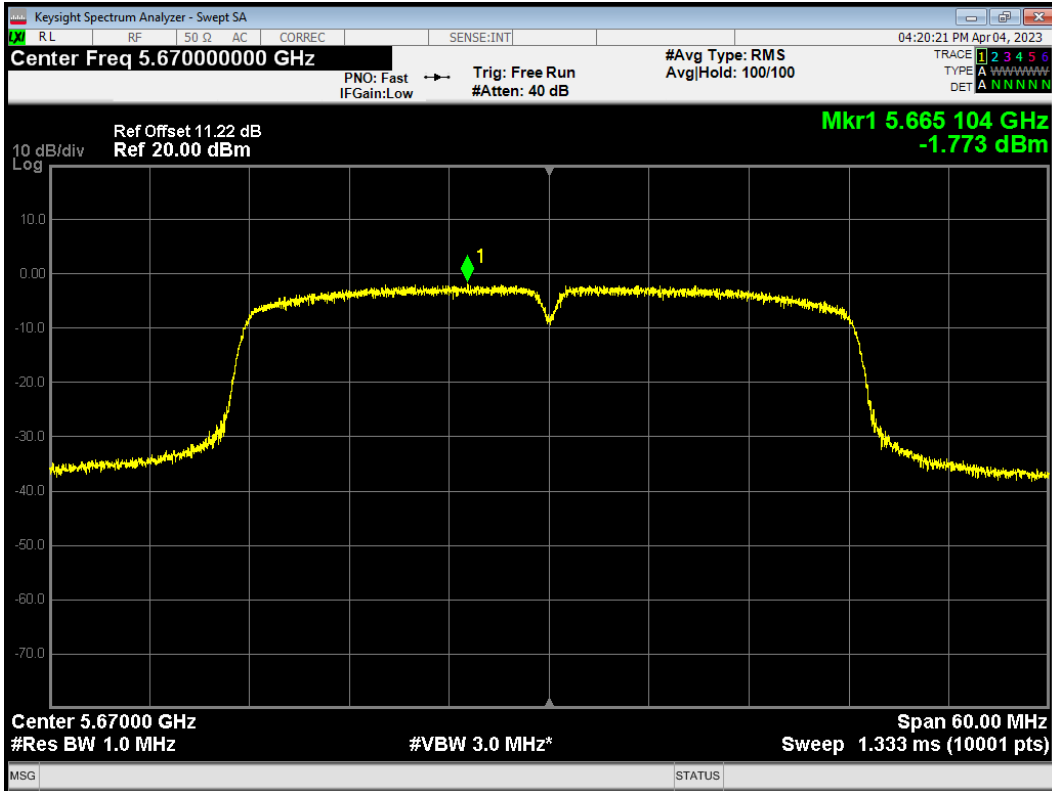

PSD 802.11ac(VHT80) 5530MHz

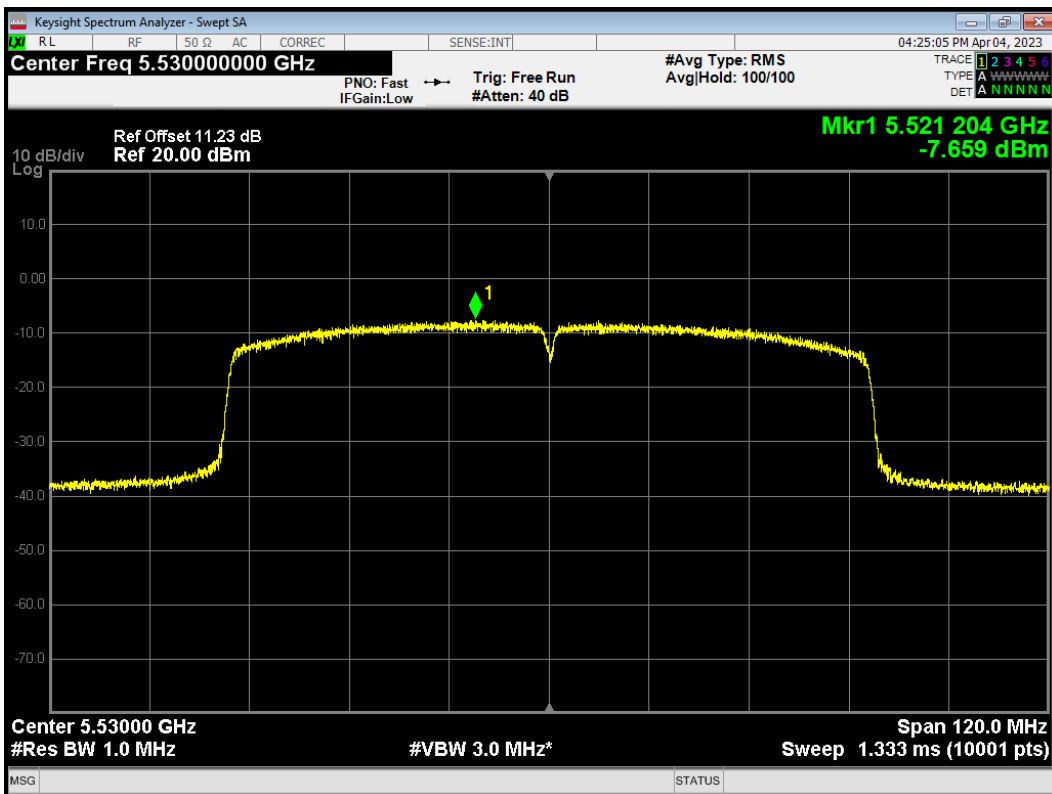

PSD 802.11ac(VHT80) 5610MHz

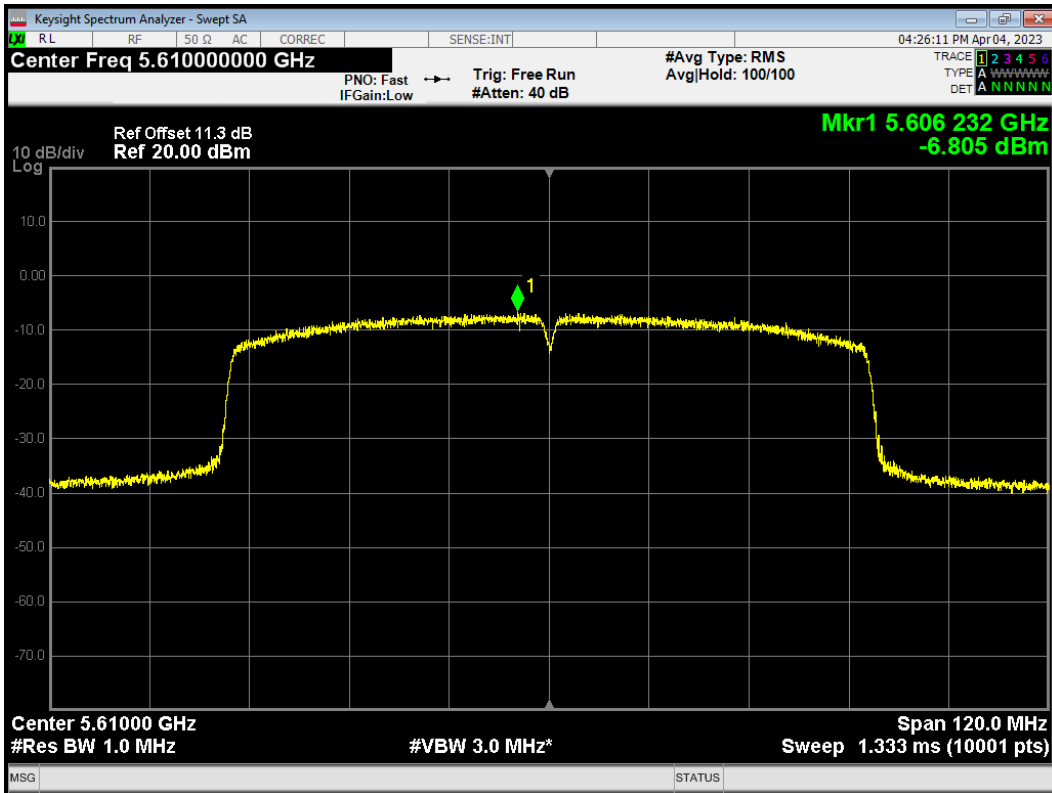

PSD 802.11n(HT20) 5500MHz

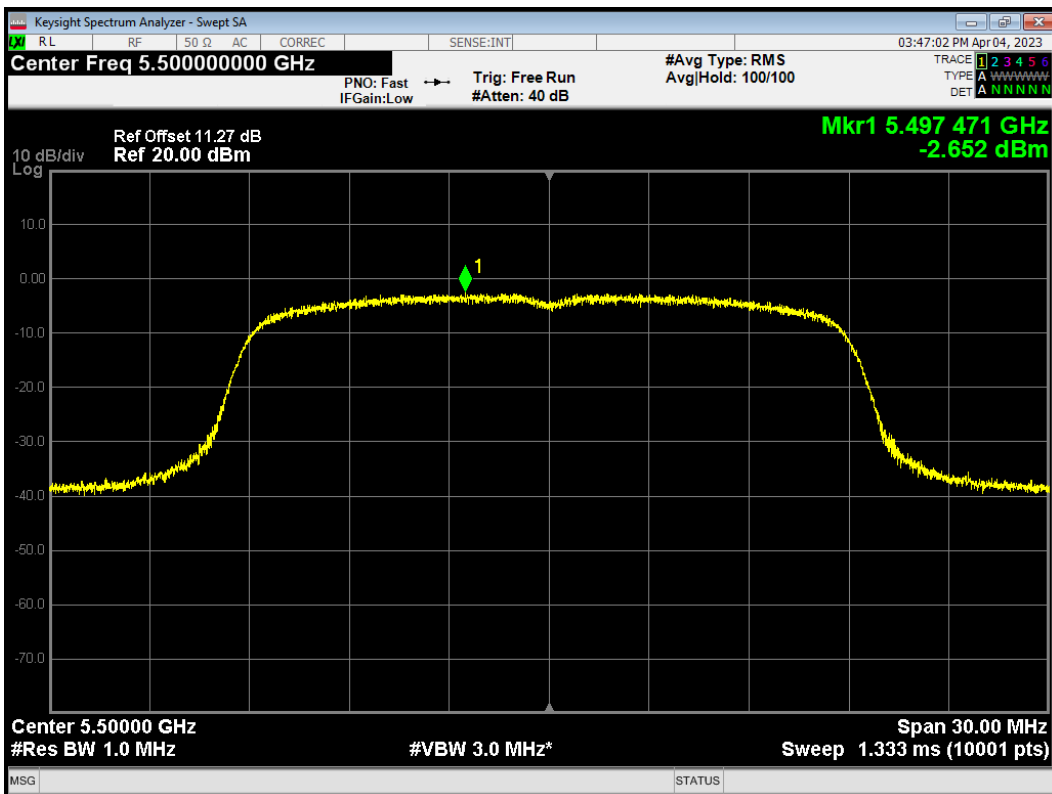

PSD 802.11n(HT20) 5520MHz

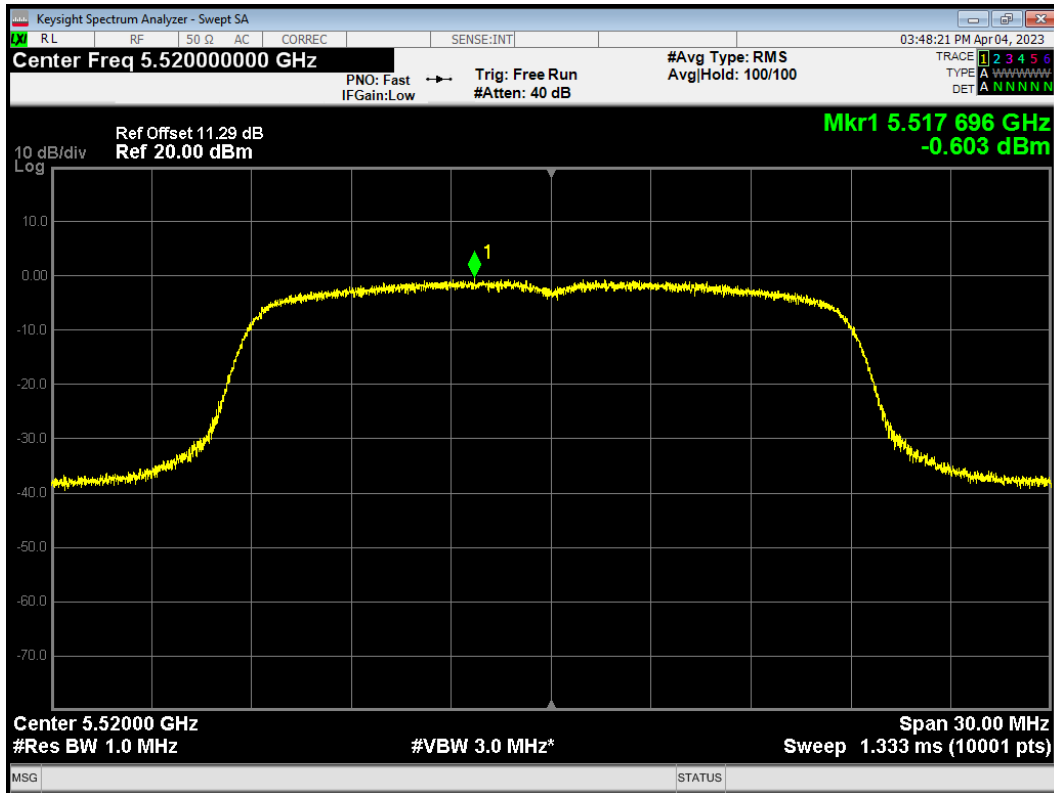

PSD 802.11n(HT20) 5600MHz

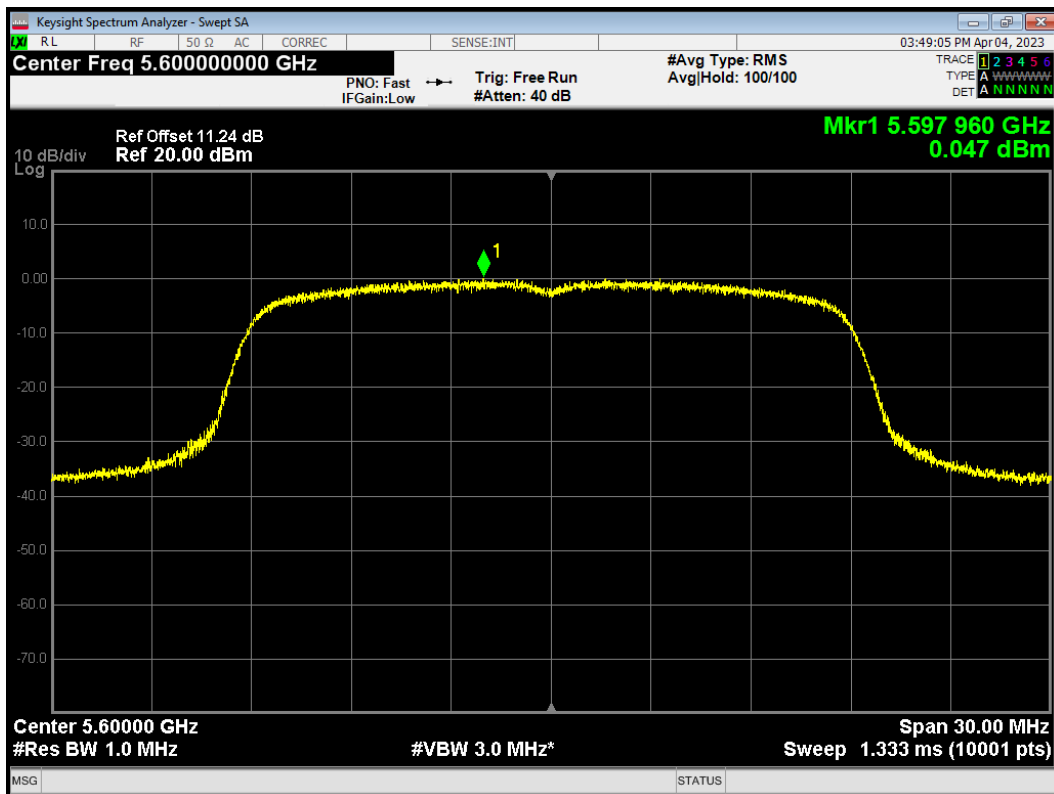

PSD 802.11n(HT20) 5680MHz

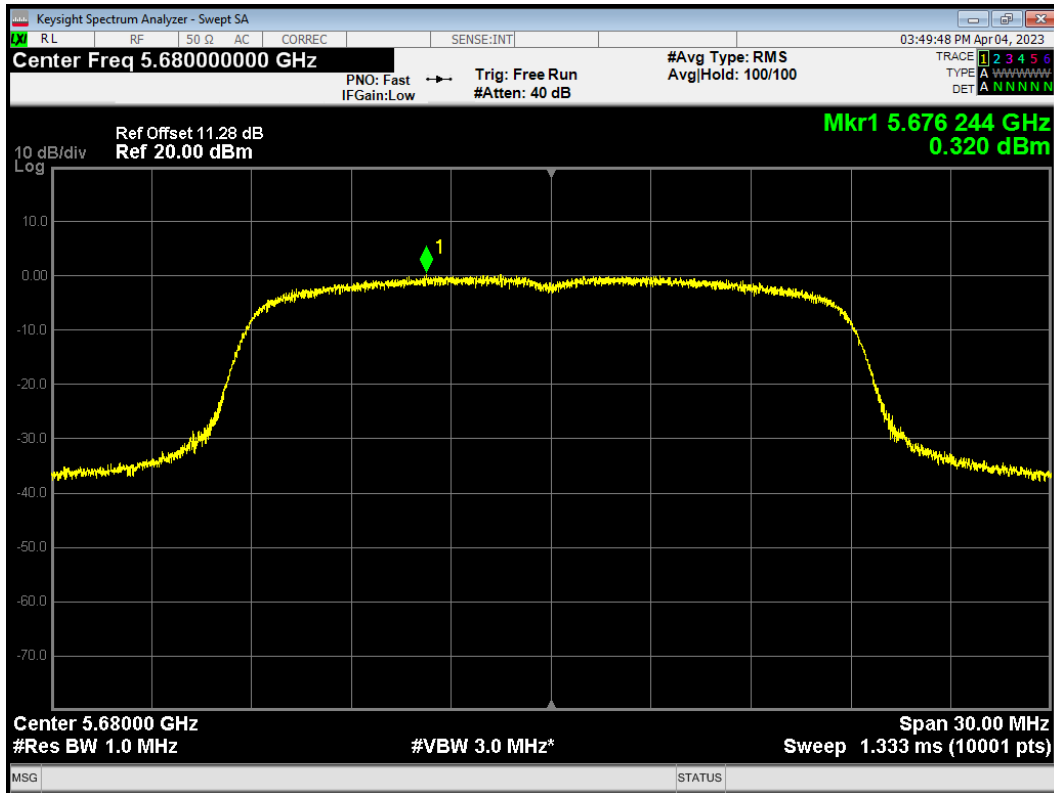

PSD 802.11n(HT20) 5700MHz

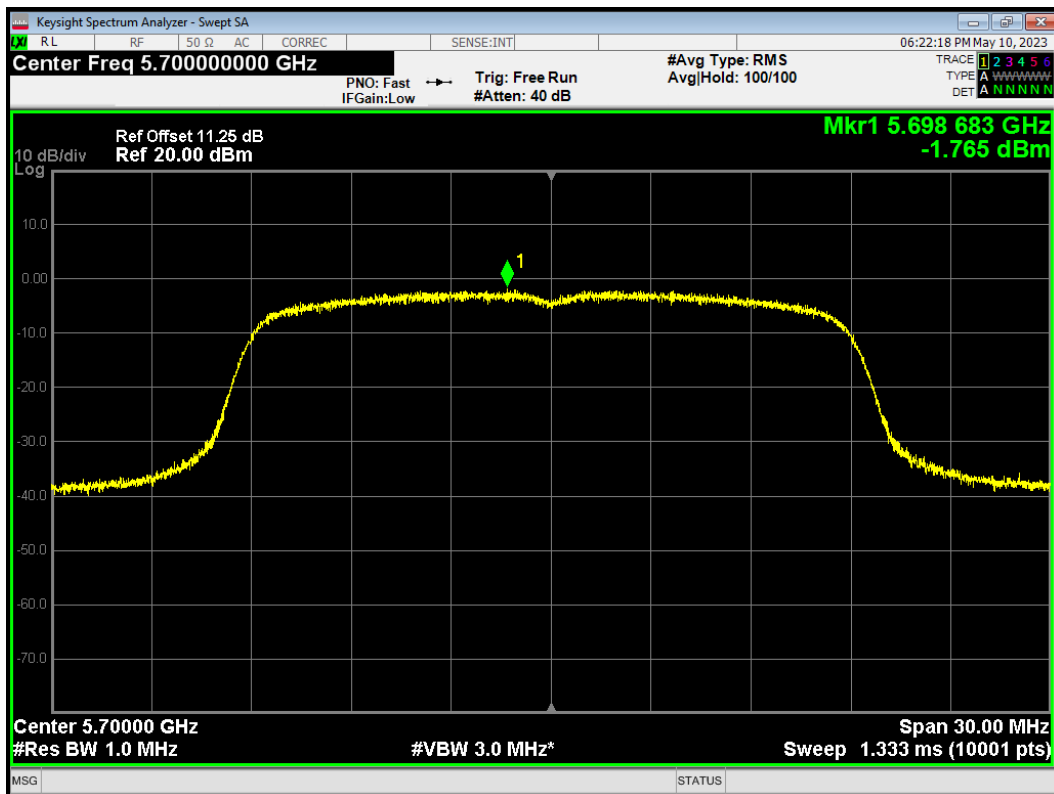

PSD 802.11n(HT40) 5510MHz

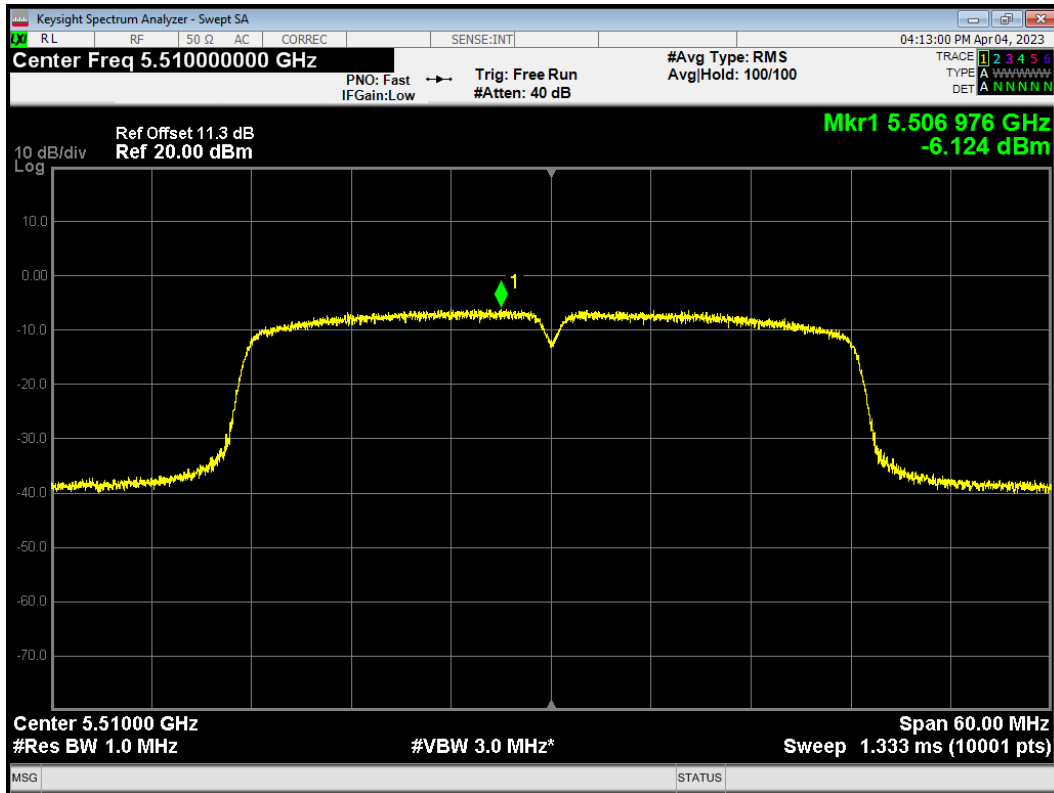

PSD 802.11n(HT40) 5550MHz

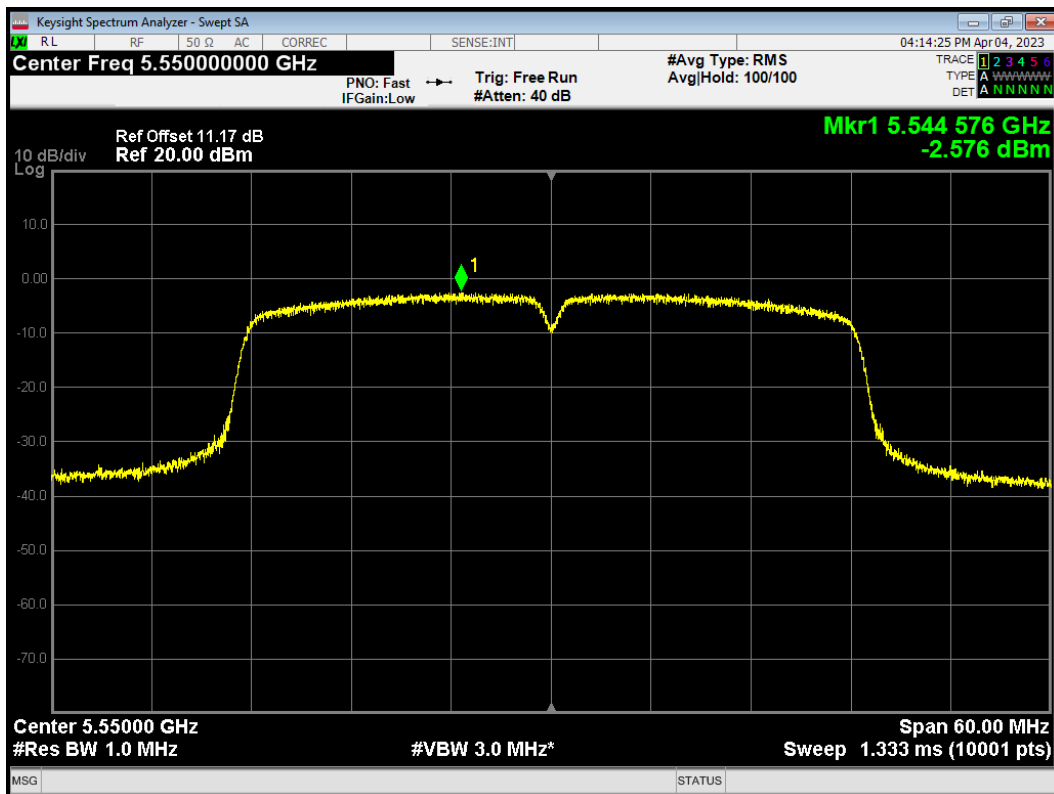

PSD 802.11n(HT40) 5590MHz

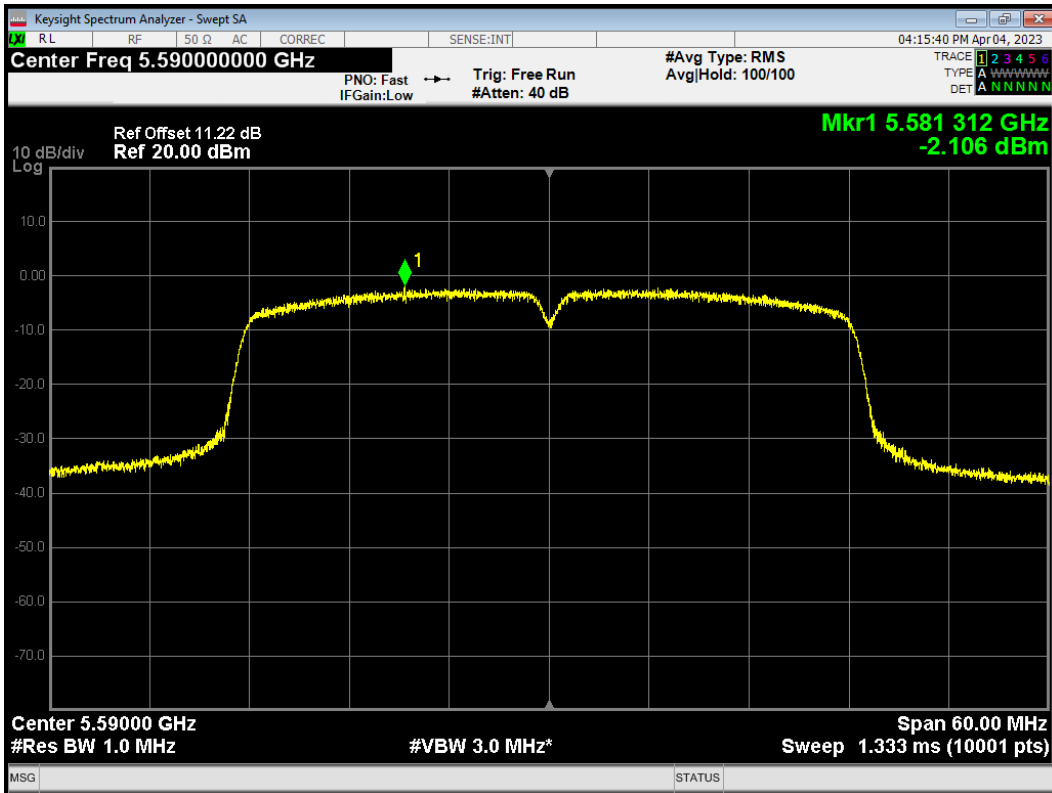

PSD 802.11n(HT40) 5670MHz

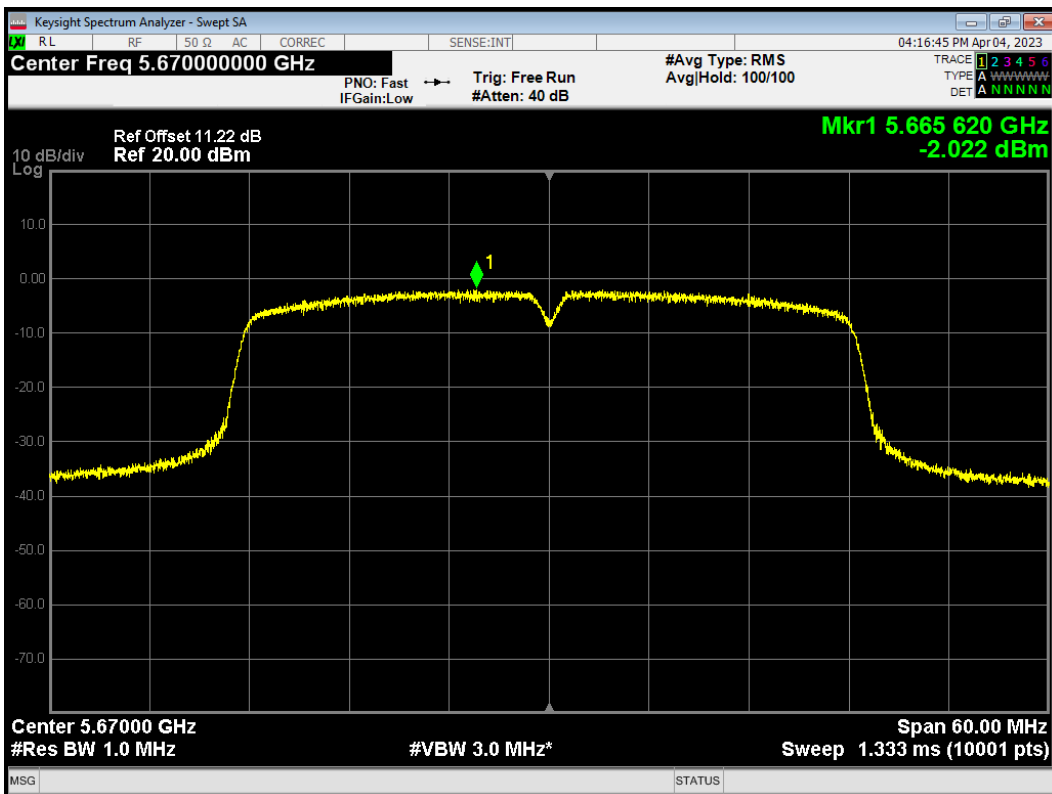

U-NII-3

PSD 802.11a 5745MHz

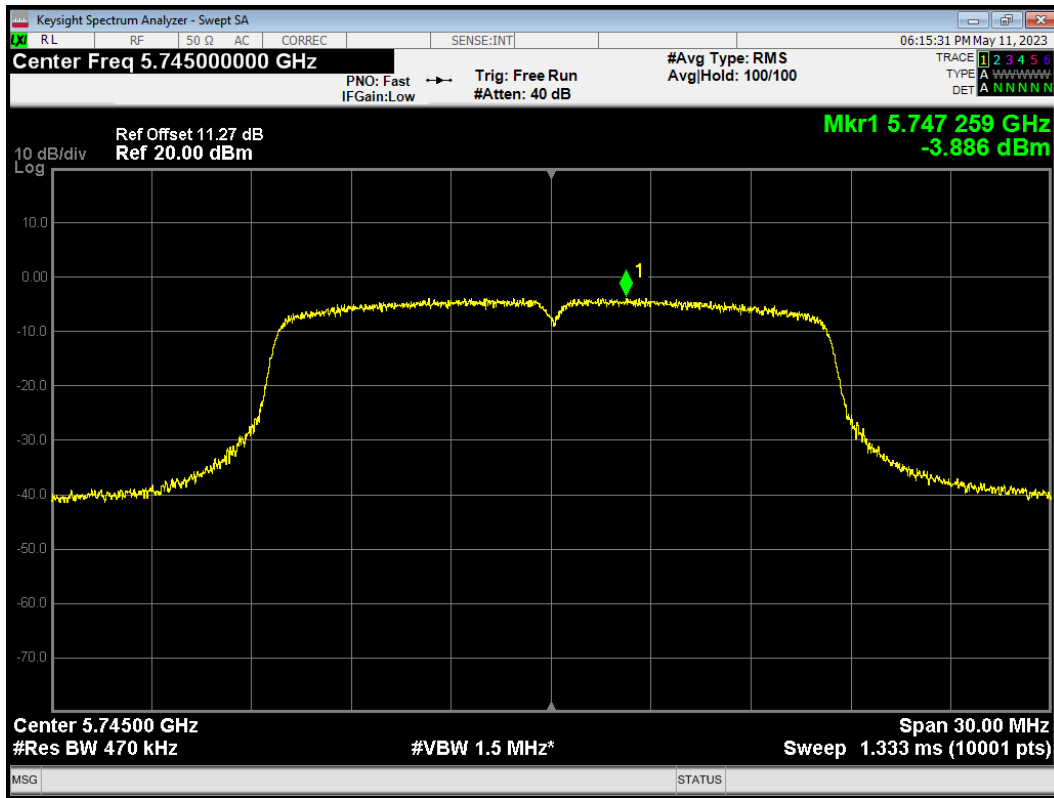

PSD 802.11a 5785MHz

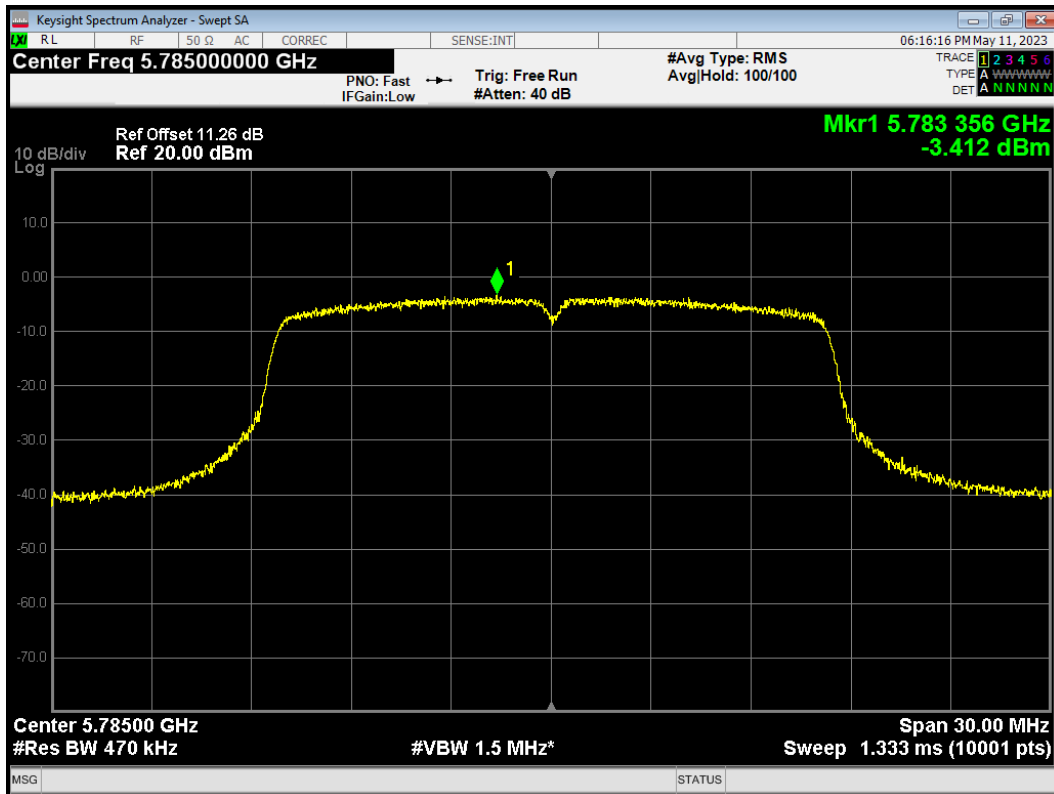

PSD 802.11a 5825MHz

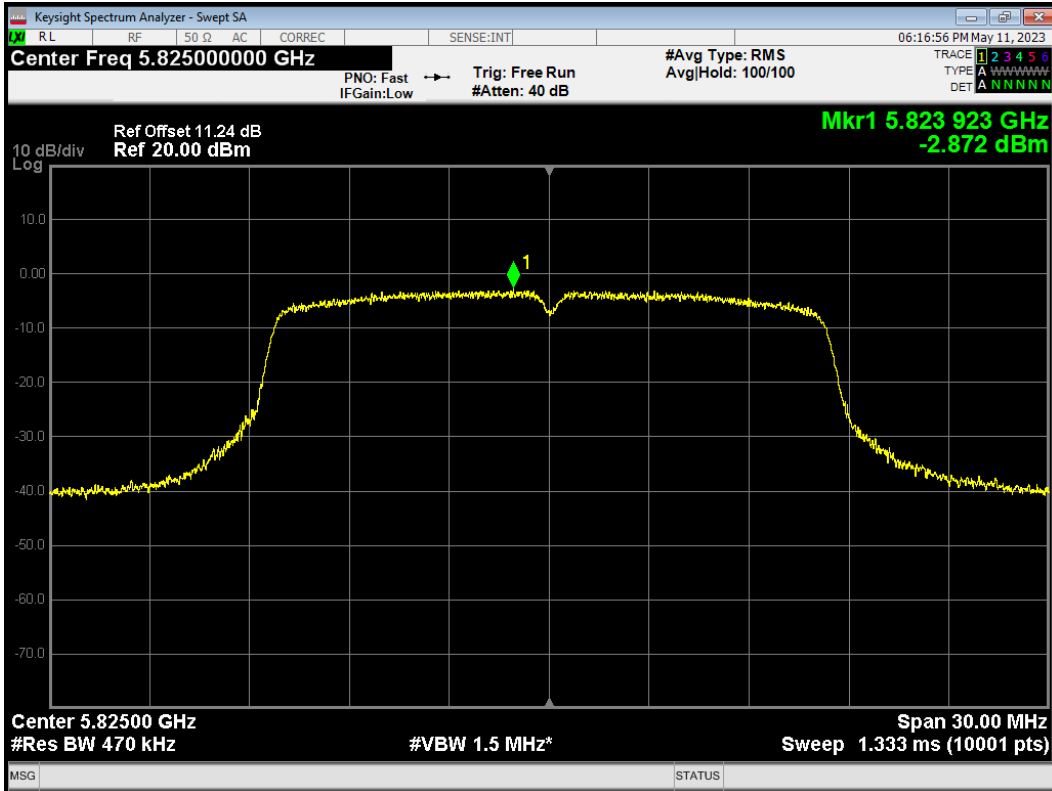

PSD 802.11ac(VHT20) 5745MHz

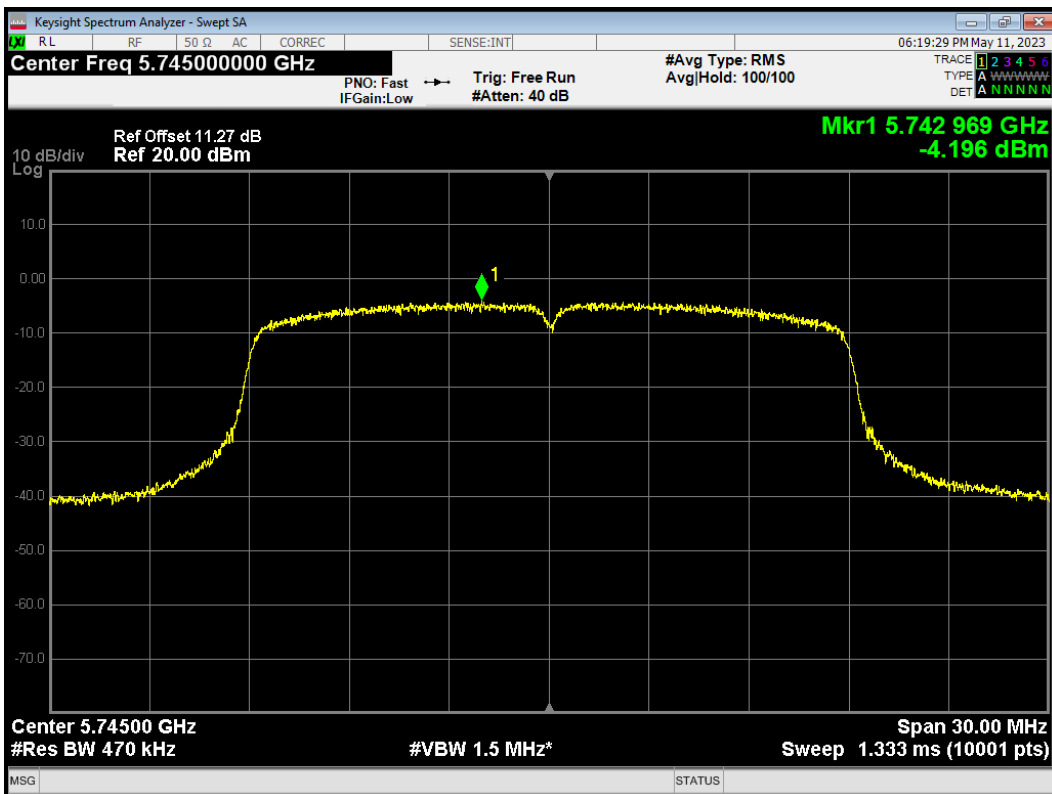

PSD 802.11ac(VHT20) 5785MHz

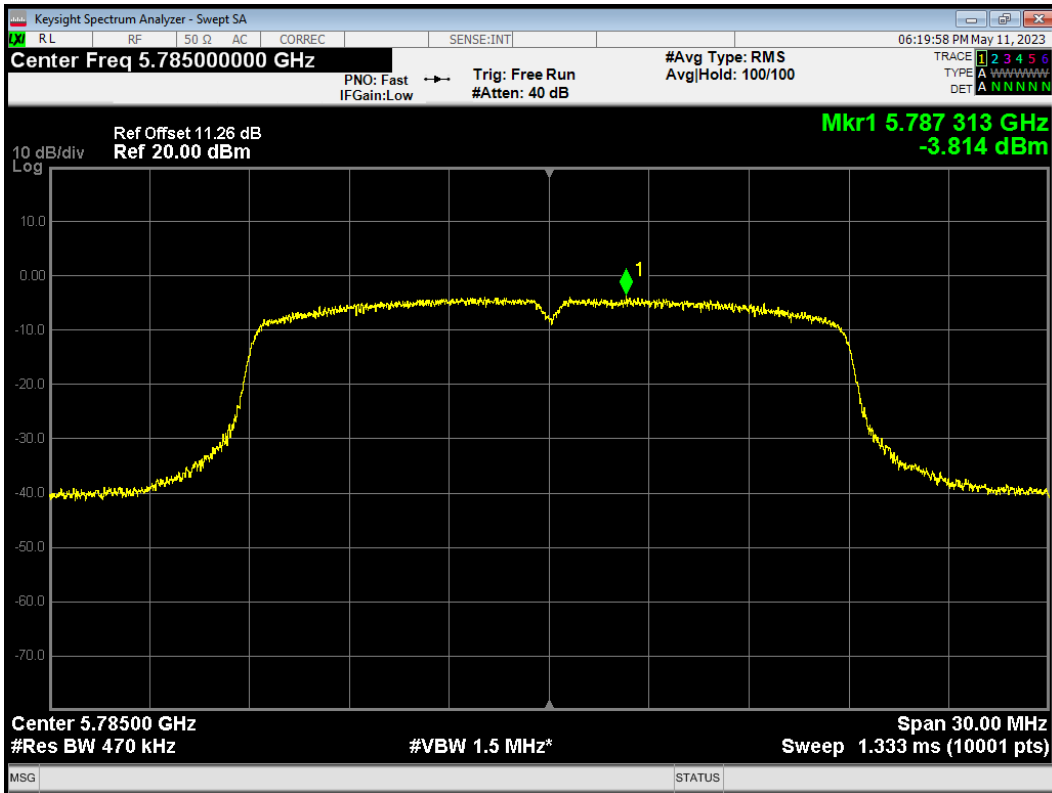

PSD 802.11ac(VHT20) 5825MHz

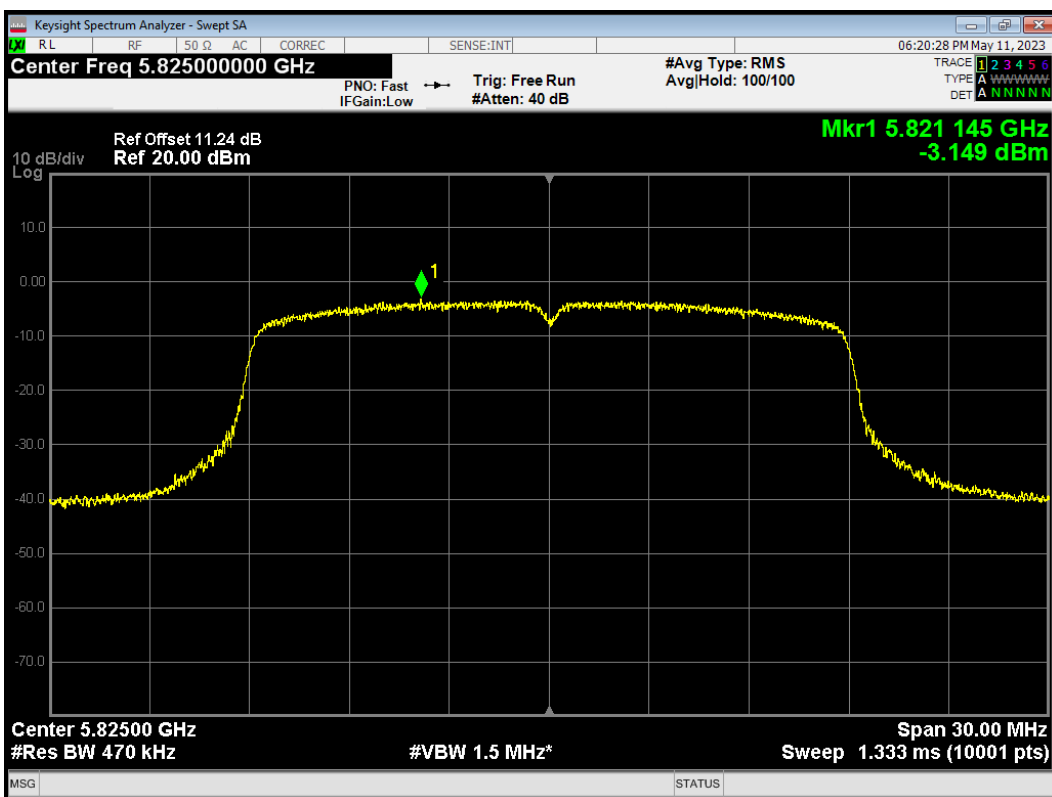

PSD 802.11ac(VHT40) 5755MHz

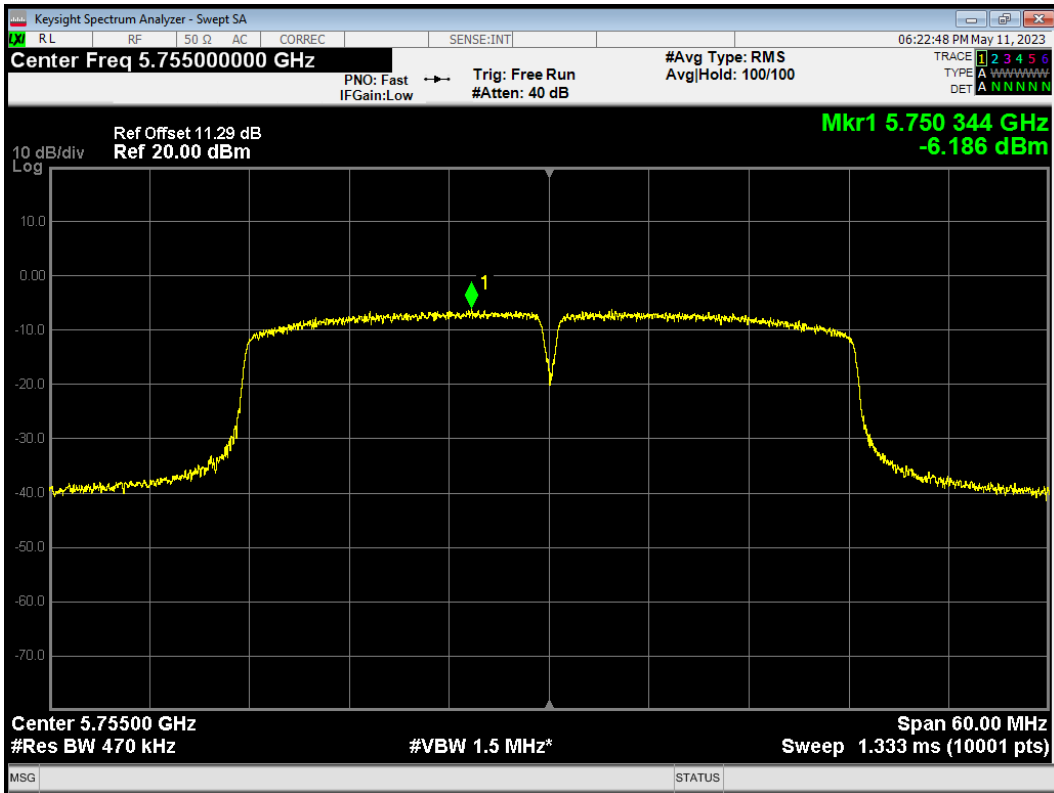

PSD 802.11ac(VHT40) 5795MHz

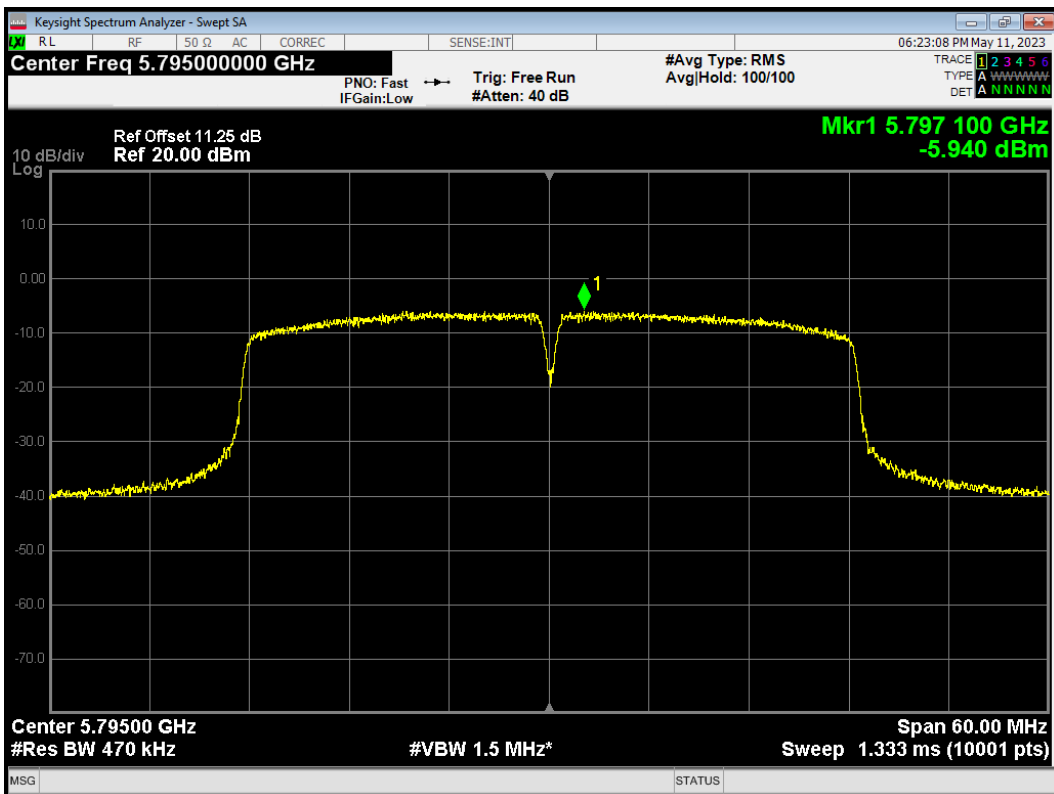

PSD 802.11ac(VHT80) 5775MHz

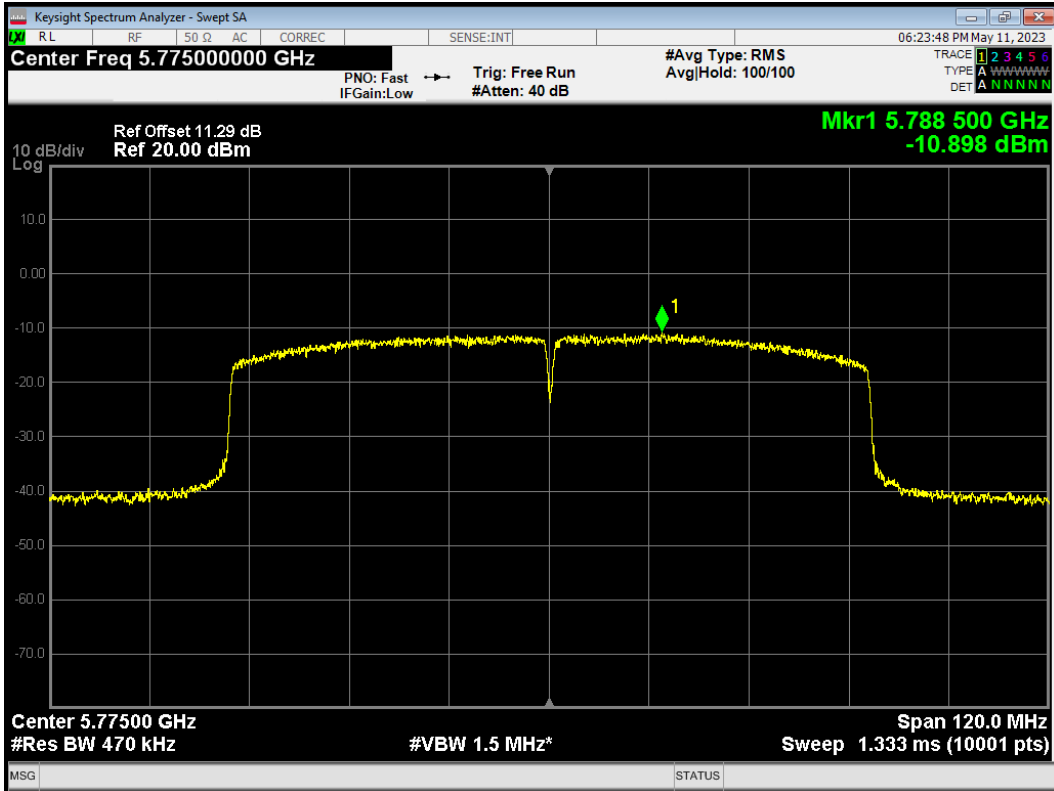

PSD 802.11n(HT20) 5745MHz

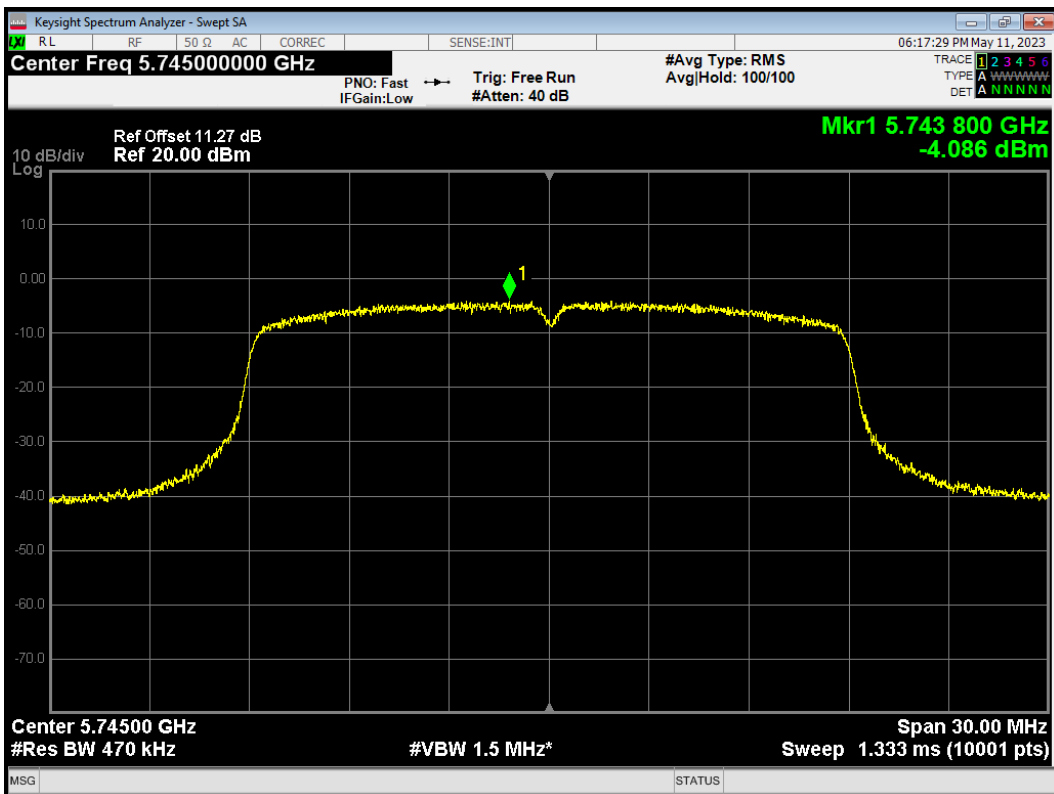

PSD 802.11n(HT20) 5785MHz

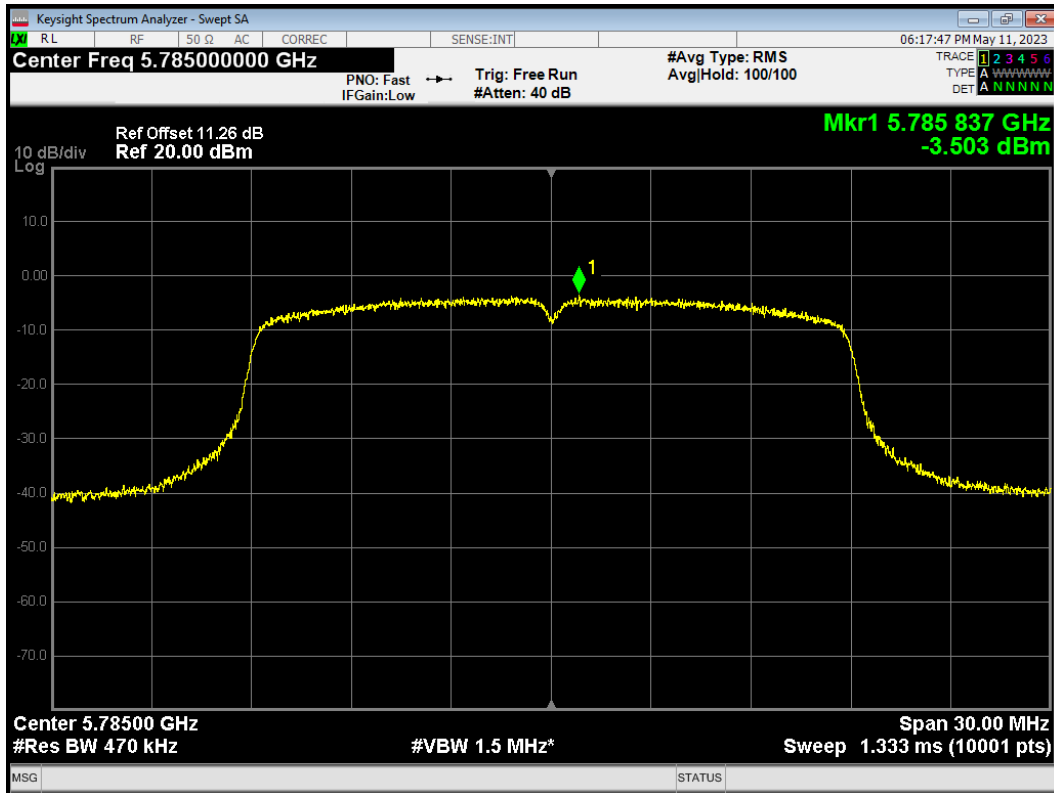

PSD 802.11n(HT20) 5825MHz

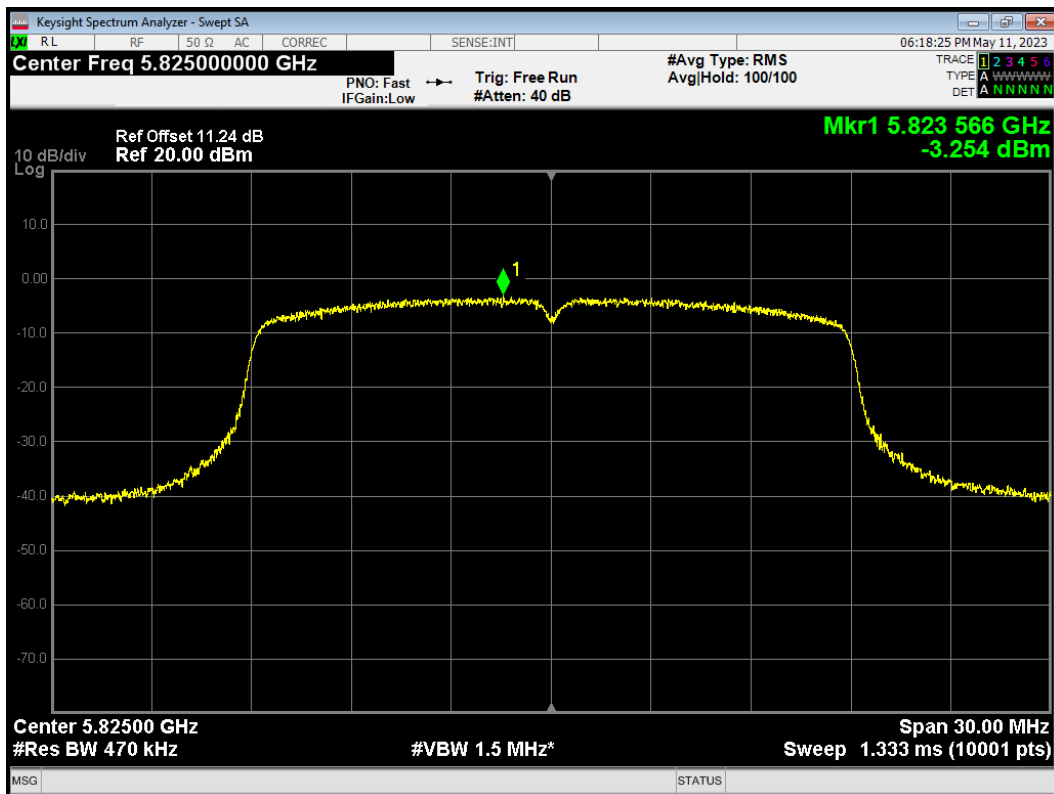

PSD 802.11n(HT40) 5755MHz

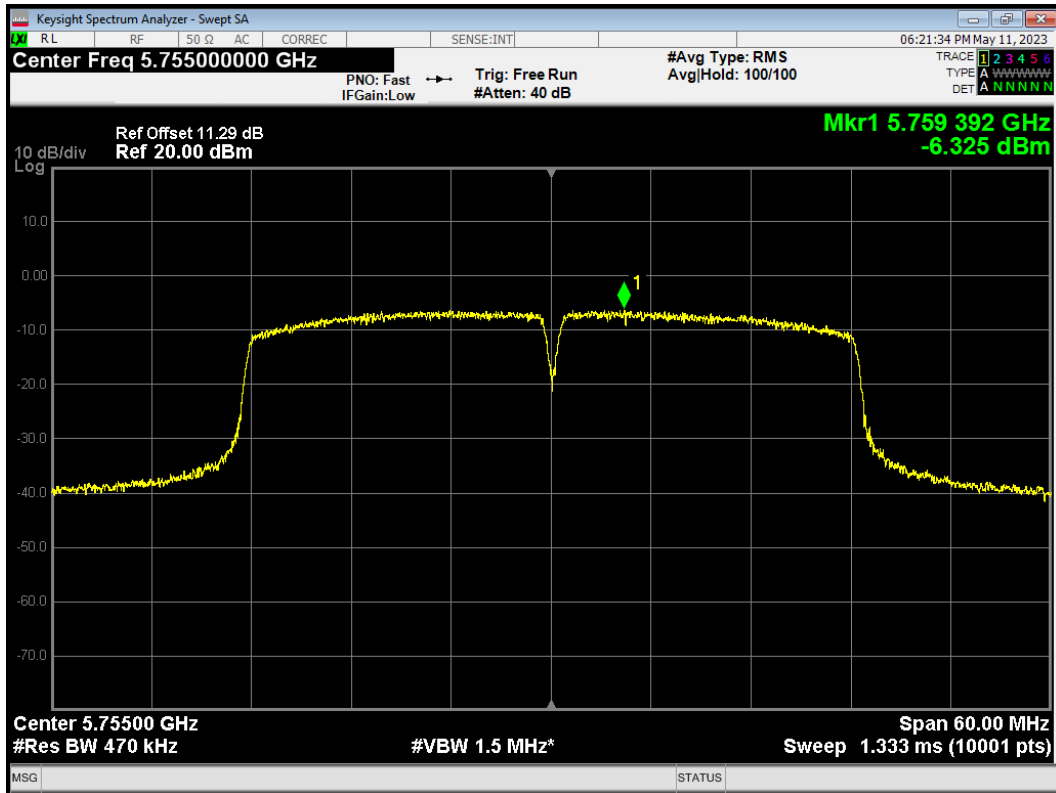

PSD 802.11n(HT40) 5795MHz

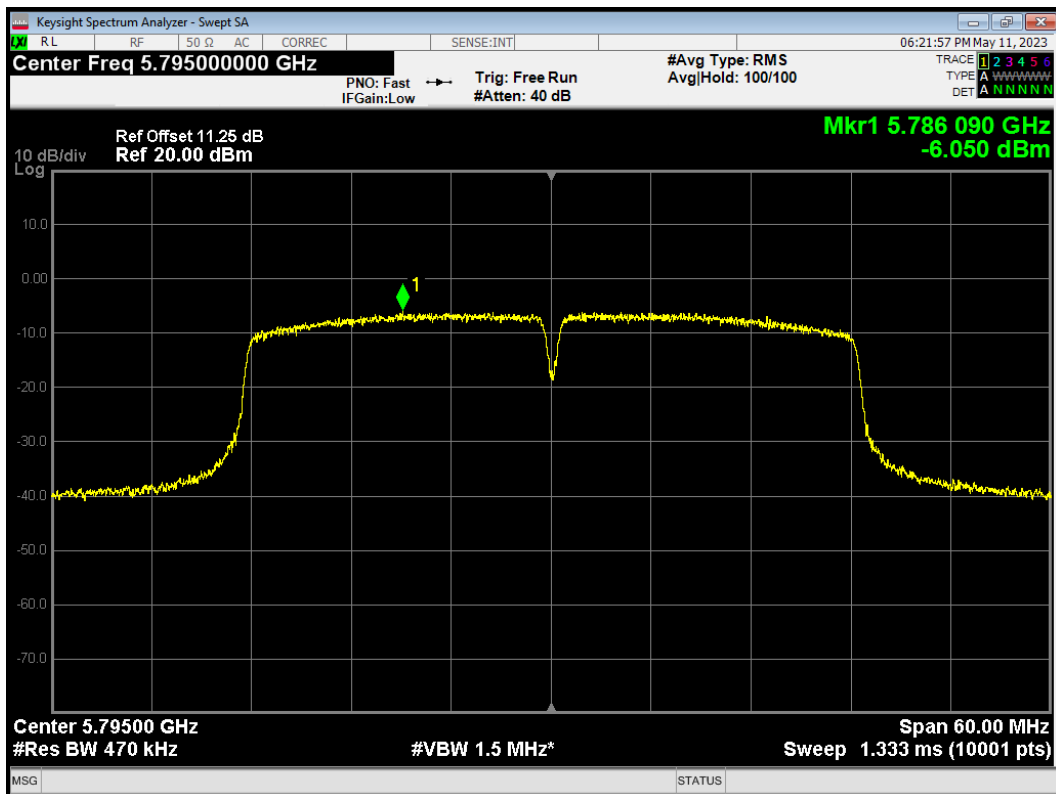

5.5. Unwanted Emission

Ambient condition

Temperature	Relative humidity
20°C ~ 25°C	45% ~ 50%

Method of Measurement

The test set-up was made in accordance to the general provisions of ANSI C63.10. The Equipment Under Test (EUT) was set up on a non-conductive table in the semi-anechoic chamber. The test was performed at the distance of 3 m between the EUT and the receiving antenna. The radiated emissions measurements were made in a typical installation configuration.

Sweep the whole frequency band range from 9kHz to the 10th harmonic of the carrier, and the emissions less than 20 dB below the permissible value are reported.

During the test, the height of receive antenna shall be moved from 1 to 4 meters, and the antenna shall be performed under horizontal and vertical polarization. The turntable shall be rotated from 0 to 360 degrees for detecting the maximum of radiated spurious signal level. The measurements shall be repeated with orthogonal polarization of the test antenna. The data of cable loss and antenna factor has been calibrated in full testing frequency range before the testing.

Set the spectrum analyzer in the following:

9kHz~150 kHz

RBW=200Hz, VBW=1kHz/ Sweep=AUTO

150 kHz~30MHz

RBW=9KHz, VBW=30KHz,/ Sweep=AUTO

Below 1GHz

RBW=100kHz / VBW=300kHz / Sweep=AUTO

a) Peak emission levels are measured by setting the instrument as follows:

Above 1GHz

PEAK: RBW=1MHz VBW=3MHz/ Sweep=AUTO

b) Average emission levels are measured by setting the instrument as follows:

Above 1GHz

AVERAGE: RBW=1MHz / VBW=3MHz / Sweep=AUTO

c) Detector: The measurements employing a CISPR quasi-peak detector except for the frequency bands 9-90 kHz, 110-490 kHz and above 1000 MHz. Radiated emission limits in these three bands are based on measurements employing an average detector.

d) Averaging type = power (i.e., rms) (As an alternative, the detector and averaging type may be set for linear voltage averaging. Some instruments require linear display mode to use linear voltage averaging. Log or dB averaging shall not be used.)

e) Sweep time = auto.

f) Perform a trace average of at least 100 traces if the transmission is continuous. If the transmission is not continuous, then the number of traces shall be increased by a factor of $1 / D$, where D is the duty cycle. For example, with 50% duty cycle, at least 200 traces shall be averaged. (If a specific

emission is demonstrated to be continuous—i.e., 100% duty cycle—then rather than turning ON and OFF with the transmit cycle, at least 100 traces shall be averaged.)

g) If tests are performed with the EUT transmitting at a duty cycle less than 98%, then a correction factor shall be added to the measurement results prior to comparing with the emission limit, to compute the emission level that would have been measured had the test been performed at 100% duty cycle. The correction factor is computed as follows:

1) If power averaging (rms) mode was used in the preceding step e), then the correction factor is $[10 \log (1 / D)]$, where D is the duty cycle. For example, if the transmit duty cycle was 50%, then 3 dB shall be added to the measured emission levels.

2) If linear voltage averaging mode was used in the preceding step e), then the correction factor is $[20 \log (1 / D)]$, where D is the duty cycle. For example, if the transmit duty cycle was 50%, then 6 dB shall be added to the measured emission levels.

3) If a specific emission is demonstrated to be continuous (100% duty cycle) rather than turning ON and OFF with the transmit cycle, then no duty cycle correction is required for that emission.

Reduce the video bandwidth until no significant variations in the displayed signal are observed in subsequent traces, provided the video bandwidth is no less than 1 Hz. For regulatory requirements that specify averaging only over the transmit duration (e.g., digital transmission system [DTS] and Unlicensed National Information Infrastructure [U-NII]), the video bandwidth shall be greater than $[1 / (\text{minimum transmitter on time})]$ and no less than 1 Hz.

The field strength of spurious emission was measured in the following position: EUT stand-up position (Z axis), lie-down position (X, Y axis). The worst emission was found in stand-up position (Z axis) and the loop antenna is vertical, others antenna are vertical and horizontal.

The test is in transmitting mode.

Test setup

9KHz~ 30MHz

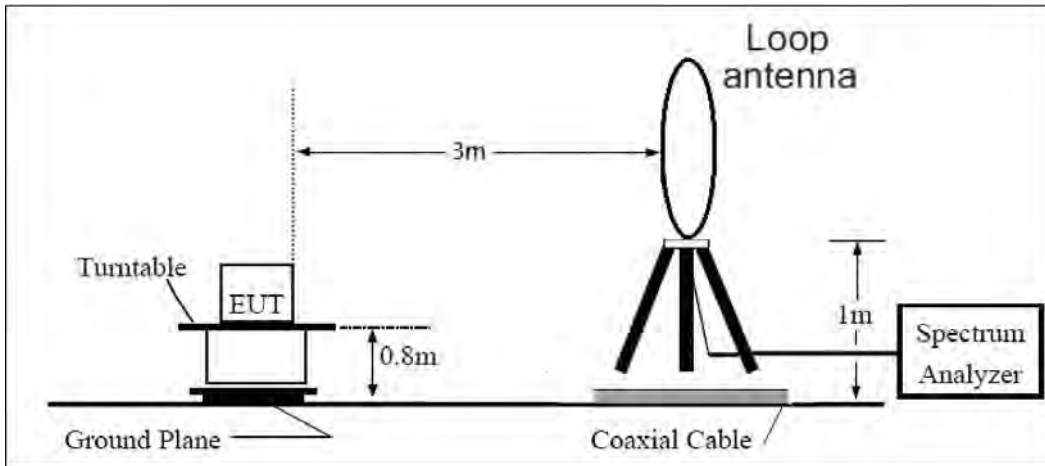

30MHz~ 1GHz

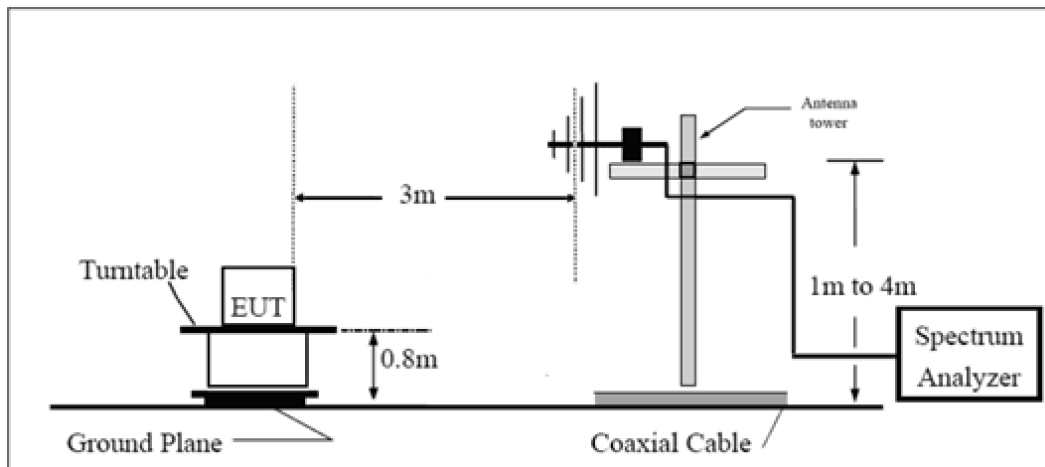

Above 1GHz

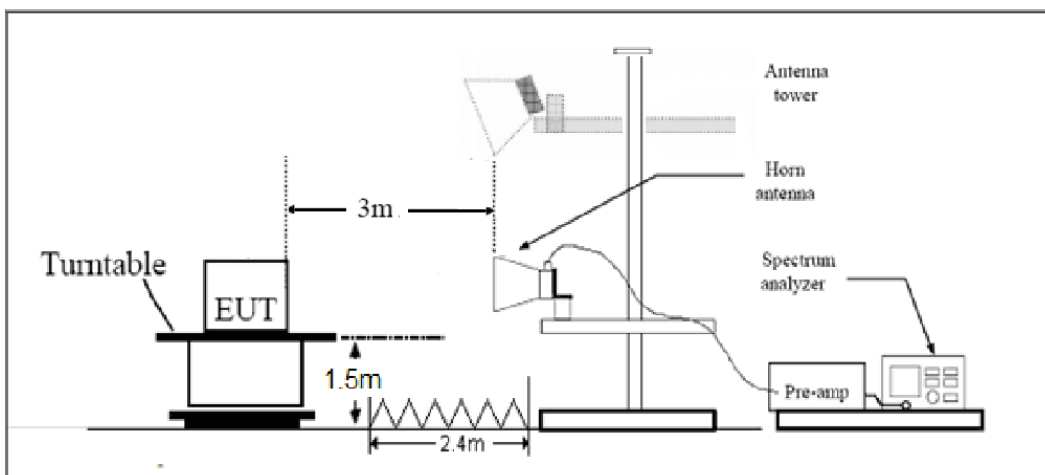

Note: Area side:2.4mX3.6m

Limits

- (1) For transmitters operating in the 5725-5850 MHz band: All emissions shall be limited to a level of -27 dBm/MHz at 75 MHz or more above or below the band edge increasing linearly to 10 dBm/MHz at 25 MHz above or below the band edge, and from 25 MHz above or below the band edge increasing linearly to a level of 15.6 dBm/MHz at 5 MHz above or below the band edge, and from 5 MHz above or below the band edge increasing linearly to a level of 27 dBm/MHz at the band edge.
- (2) For transmitters operating in the 5.15-5.25 GHz band: All emissions outside of the 5.15-5.35 GHz band shall not exceed an e.i.r.p. of -27 dBm/MHz(68.2dBμV/m).
- (3) For transmitters operating in the 5.25-5.35 GHz band: All emissions outside of the 5.15-5.35 GHz band shall not exceed an e.i.r.p. of -27 dBm/MHz(68.2dBμV/m).
- (4) For transmitters operating in the 5.47-5.725 GHz band: All emissions outside of the 5.47-5.725 GHz band shall not exceed an e.i.r.p. of -27 dBm/MHz(68.2dBμV/m).

Note: the following formula is used to convert the EIRP to field strength

§1、 $E[\text{dB}\mu\text{V}/\text{m}] = \text{EIRP}[\text{dBm}] - 20 \log(d[\text{meters}]) + 104.77$, where E = field strength and

d = distance at which field strength limit is specified in the rules;

§2、 $E[\text{dB}\mu\text{V}/\text{m}] = \text{EIRP}[\text{dBm}] + 95.2$, for d = 3 meters

- (5) Unwanted spurious emissions fallen in restricted bands per FCC Part15.205 shall comply with the general field strength limits set forth in § 15.209 as below table.

Frequency of emission (MHz)	Field strength($\mu\text{V}/\text{m}$)	Field strength($\text{dB}\mu\text{V}/\text{m}$)
0.009–0.490	2400/F(kHz)	/
0.490–1.705	24000/F(kHz)	/
1.705–30.0	30	/
30-88	100	40
88-216	150	43.5
216-960	200	46
Above960	500	54

MHz	MHz	MHz	GHz
0.090 - 0.110	16.42 - 16.423	399.9 - 410	4.5 - 5.15
0.495 - 0.505	16.69475 - 16.69525	608 - 614	5.35 - 5.46
2.1735 - 2.1905	16.80425 - 16.80475	960 - 1240	7.25 - 7.75
4.125 - 4.128	25.5 - 25.67	1300 - 1427	8.025 - 8.5
4.17725 - 4.17775	37.5 - 38.25	1435 - 1626.5	9.0 - 9.2
4.20725 - 4.20775	73 - 74.6	1645.5 - 1646.5	9.3 - 9.5
6.215 - 6.218	74.8 - 75.2	1660 - 1710	10.6 - 12.7
6.26775 - 6.26825	108 - 121.94	1718.8 - 1722.2	13.25 - 13.4
6.31175 - 6.31225	123 - 138	2200 - 2300	14.47 - 14.5
8.291 - 8.294	149.9 - 150.05	2310 - 2390	15.35 - 16.2
8.362 - 8.366	156.52475 - 156.52525	2483.5 - 2500	17.7 - 21.4
8.37625 - 8.38675	156.7 - 156.9	2690 - 2900	22.01 - 23.12
8.41425 - 8.41475	162.0125 - 167.17	3260 - 3267	23.6 - 24.0
12.29 - 12.293	167.72 - 173.2	3332 - 3339	31.2 - 31.8
12.51975 - 12.52025	240 - 285	3345.8 - 3358	36.43 - 36.5
12.57675 - 12.57725	322 - 335.4	3600 - 4400	(²)
13.36 - 13.41			

Measurement Uncertainty

The assessed measurement uncertainty to ensure 95% confidence level for the normal distribution is with the coverage factor $k = 1.96$.

Frequency	Uncertainty
9KHz-30MHz	3.55 dB
30MHz-200MHz	4.17 dB
200MHz-1GHz	4.84 dB
1-18GHz	4.35 dB
18-26.5GHz	5.90 dB
26.5GHz~40GHz	5.92 dB

Test Results:

The modulation and bandwidth are similar for 802.11n mode for 20MHz/40MHz and 802.11ac mode for V20MHz/V40MHz, therefore investigated worst case to representative mode in test report.

A symbol (dB V/) in the test plot below means (dBμV/m)

The signal beyond the limit is carrier.

U-NII-1

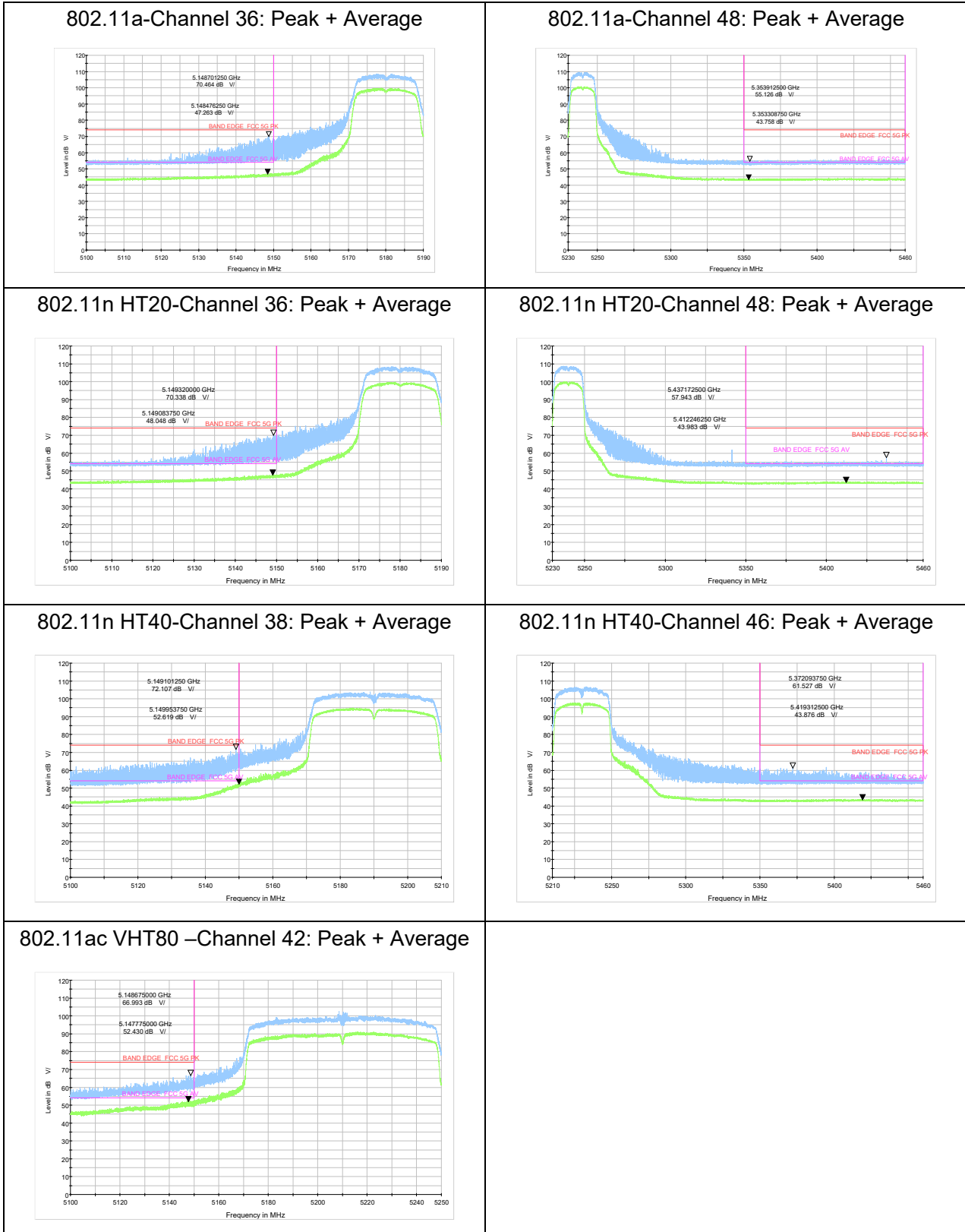

U-NII-2A

802.11a-Channel 52: Peak + Average

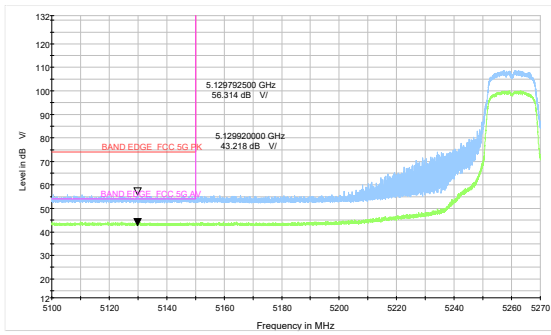

802.11a-Channel 64: Peak + Average

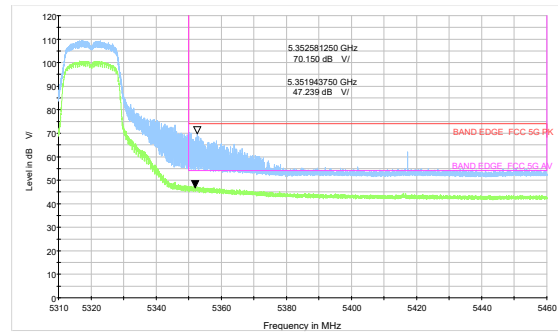

802.11n HT20-Channel 52: Peak + Average

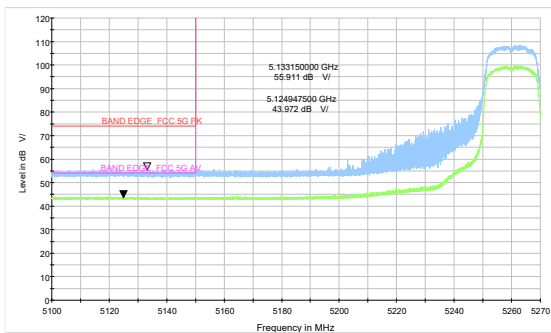

802.11n HT20-Channel 64: Peak + Average

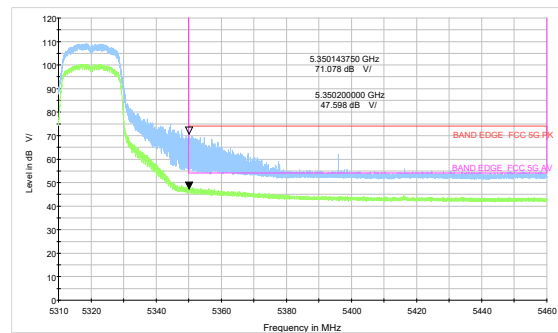

802.11n HT40-Channel 54: Peak + Average

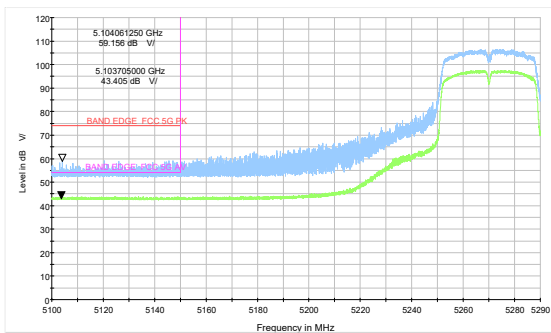

802.11n HT40-Channel 62: Peak + Average

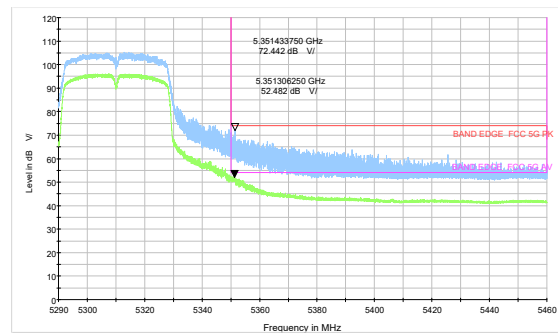

802.11ac VHT80 -Channel 58: Peak + Average

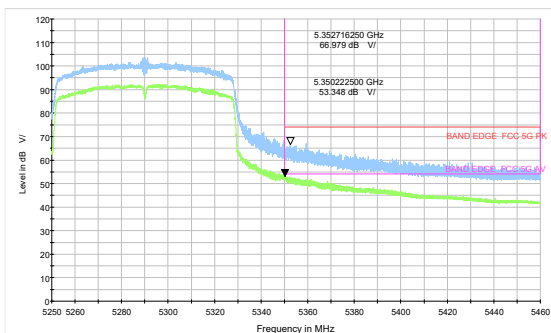

U-NII-2C

802.11a-Channel 100: Peak + Average

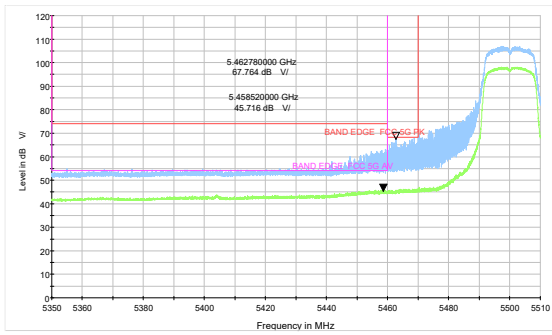

802.11a-Channel 104: Peak + Average

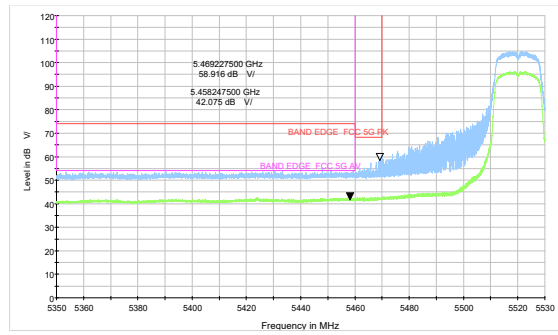

802.11a-Channel 136: Peak

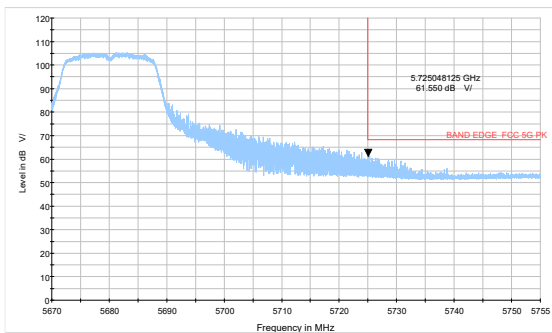

802.11a-Channel 140: Peak

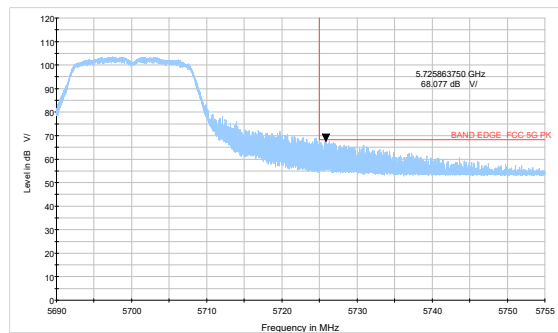

802.11n HT20-Channel 100: Peak + Average

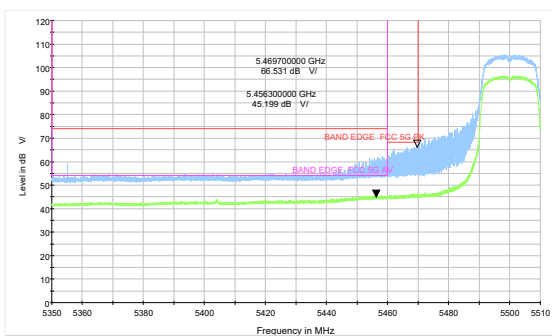

802.11n HT20-Channel 104: Peak + Average

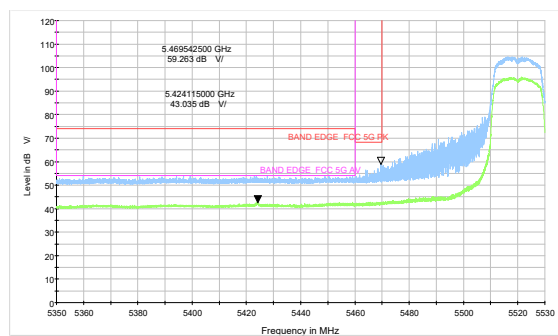

802.11n HT20-Channel 136: Peak

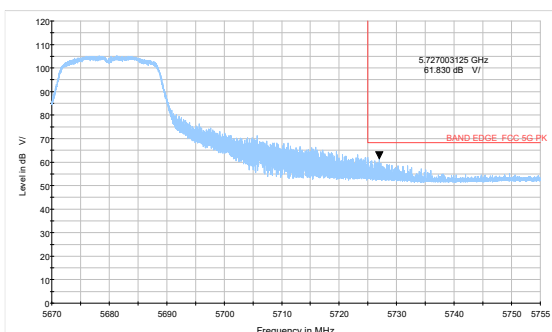

802.11n HT20-Channel 140: Peak

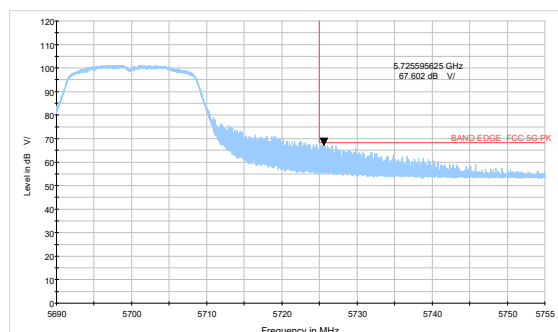

802.11n HT40-Channel 102: Peak + Average

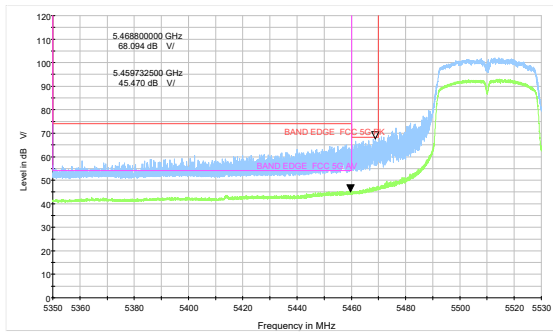

802.11n HT40-Channel 110: Peak + Average

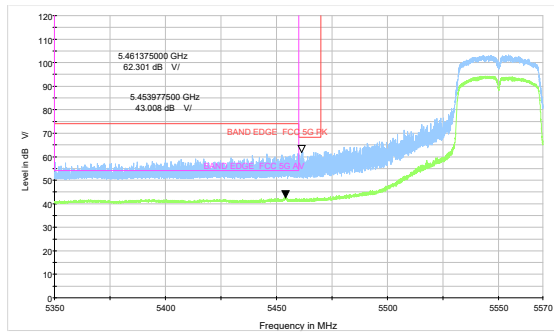

802.11n HT40-Channel 134: Peak

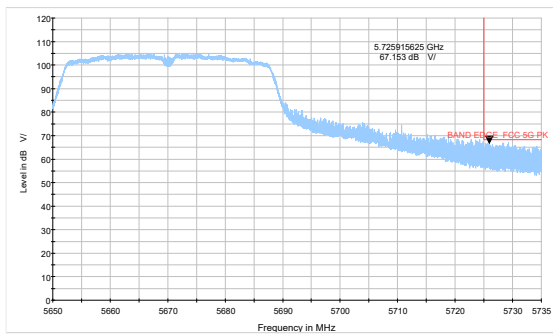

802.11ac VHT80-Channel 106: Peak + Average

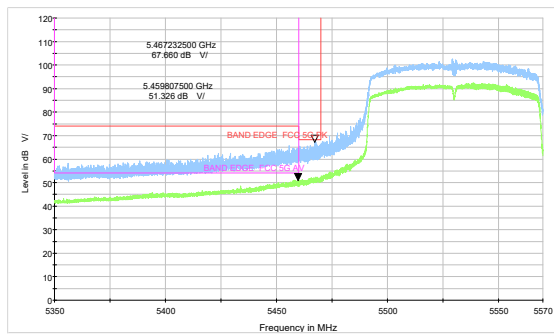

802.11ac VHT80-Channel 122: Peak

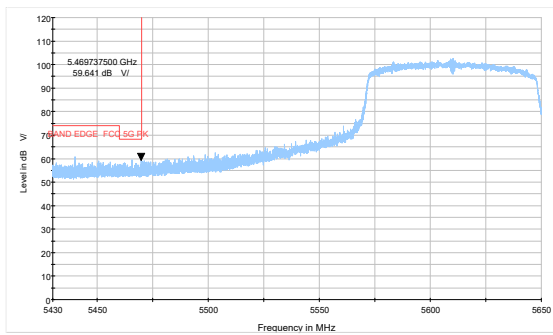

U-NII-3

802.11a-Channel 149: Peak

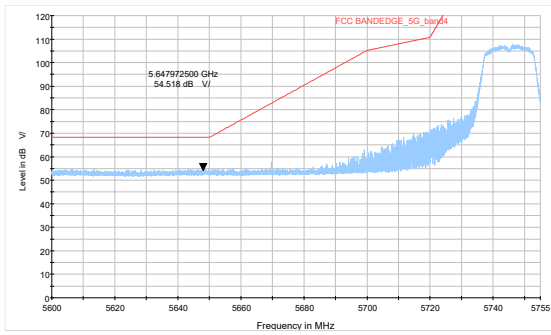

802.11a-Channel 165: Peak

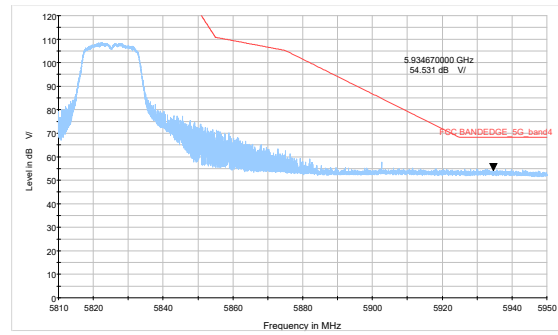

802.11n HT20-Channel 149: Peak

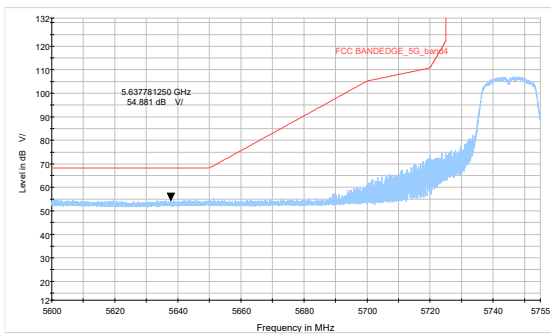

802.11n HT20-Channel 165: Peak

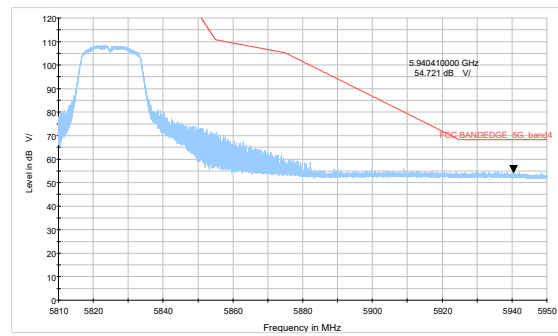

802.11n HT40-Channel 151: Peak

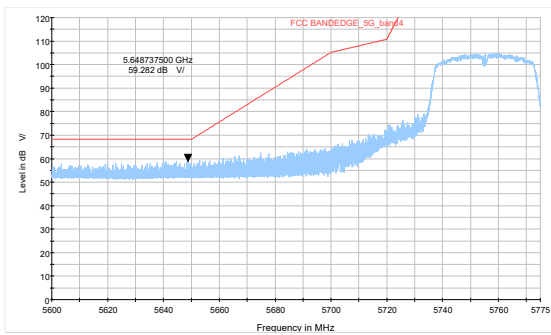

802.11n HT40-Channel 159: Peak

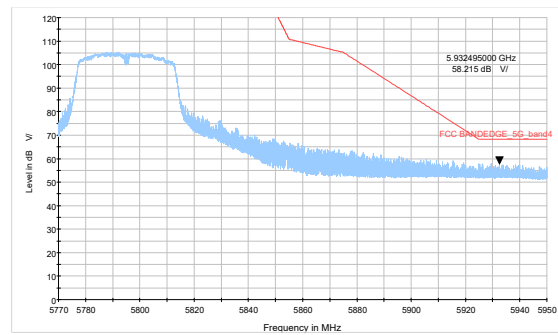

802.11ac VHT80- Channel 155: Peak

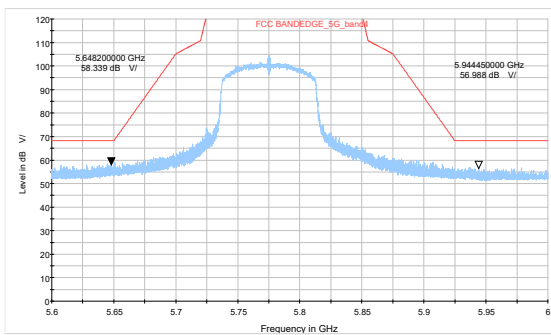

Result of RE

Test result

Sweep the whole frequency band through the range from 9kHz to the 10th harmonic of the carrier, the Emissions in the frequency band 9kHz-30MHz are more than 20dB below the limit are not reported.

A symbol (dB V/) in the test plot below means (dBμV/m)

During the test, the Radiates Emission from 30MHz to 1GHz was performed in all modes with all channels, 802.11ac (VHT80), Channel 106 are selected as the worst condition. The test data of the worst-case condition was recorded in this report.

Continuous TX mode:

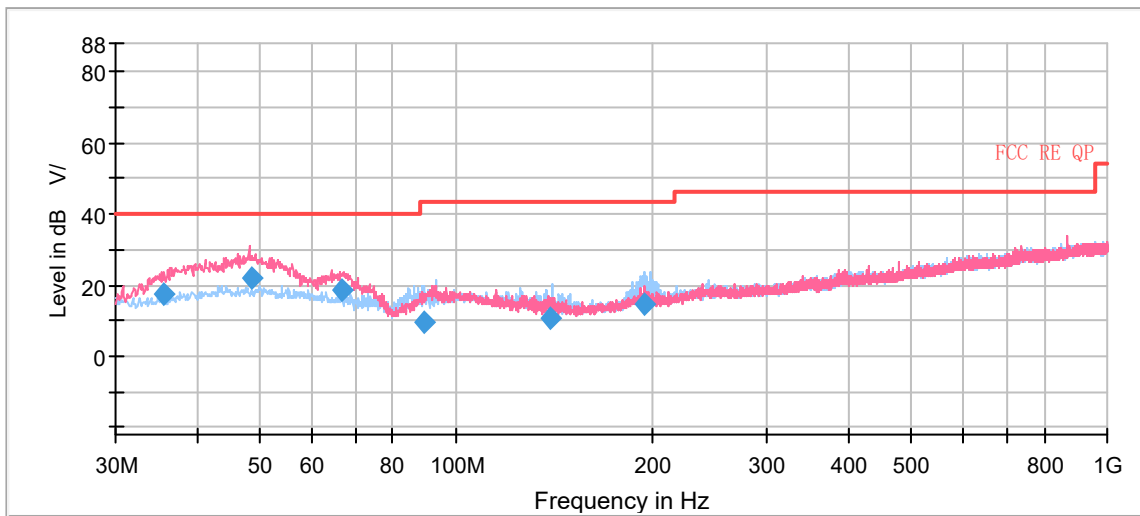

Radiates Emission from 30MHz to 1GHz

Frequency (MHz)	Quasi-Peak (dBμV/m)	Limit (dBμV/m)	Margin (dB)	Height (cm)	Polarization	Azimuth (deg)	Correct Factor (dB)
35.511675	17.38	40.00	22.62	100.0	V	87.0	17.9
48.426563	22.13	40.00	17.87	100.0	V	42.0	20.5
66.646344	18.56	40.00	21.44	100.0	V	27.0	17.4
89.404794	9.43	43.50	34.07	184.0	H	71.0	16.1
139.716000	10.82	43.50	32.68	184.0	H	275.0	14.8
194.606250	14.58	43.50	28.92	175.0	H	92.0	18.6

Remark: 1. Correction Factor = Antenna factor + Insertion loss (cable loss + amplifier gain)

2. Margin = Limit – Quasi-Peak

802.11a CH36

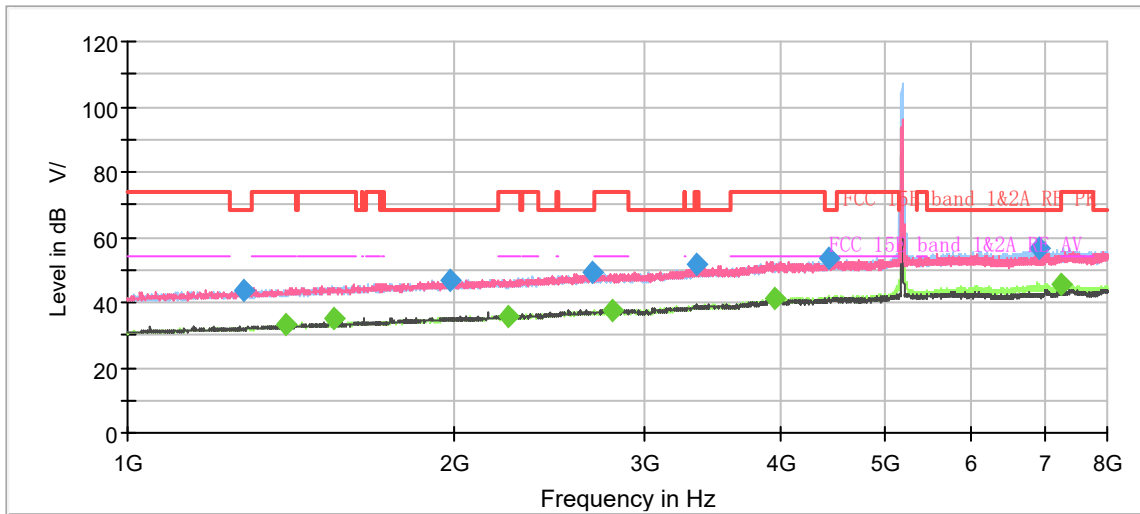

Note: The signal beyond the limit is carrier.
Radiates Emission from 1GHz to 8GHz

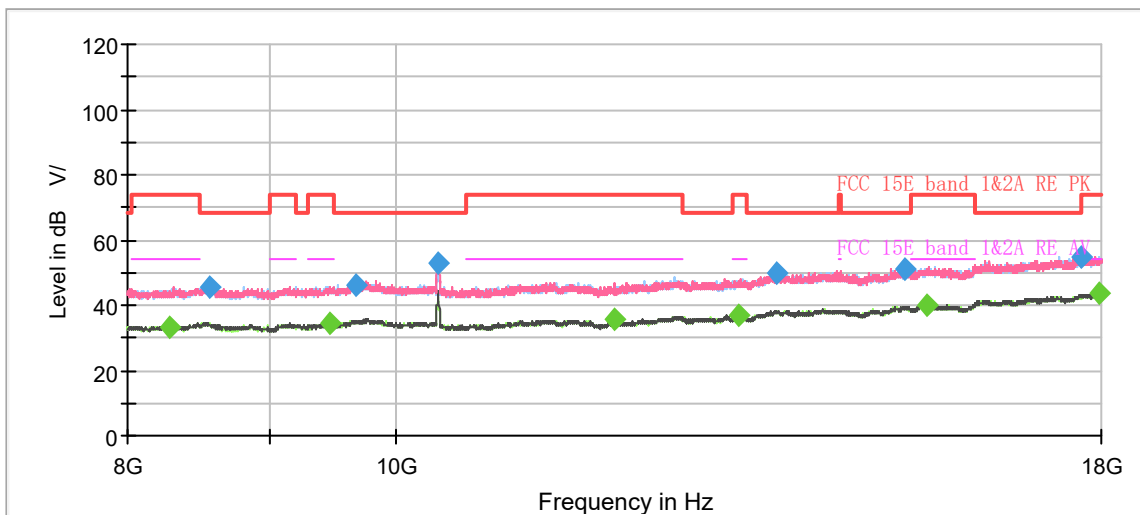

Radiates Emission from 8GHz to 18GHz

Frequency (MHz)	MaxPeak (dB μ V/m)	Average (dB μ V/m)	Limit (dB μ V/m)	Margin (dB)	Meas. Time (ms)	Height (cm)	Pol	Azimuth (deg)	Corr. (dB/m)
1279.125000	43.61	---	68.20	24.59	500.0	100.0	V	337.0	-7.3
1400.750000	---	32.99	54.00	21.01	500.0	200.0	V	193.0	-6.5
1549.500000	---	35.11	54.00	18.89	500.0	200.0	H	357.0	-5.7
1985.250000	46.50	---	68.20	21.70	500.0	200.0	H	342.0	-3.5
2245.125000	---	35.55	54.00	18.45	500.0	100.0	H	111.0	-2.4
2682.625000	48.98	---	68.20	19.22	500.0	200.0	H	274.0	-0.2
2801.625000	---	37.73	54.00	16.27	500.0	100.0	H	3.0	0.0
3339.750000	51.41	---	68.20	16.79	500.0	100.0	H	3.0	2.1
3941.750000	---	41.28	54.00	12.72	500.0	100.0	H	9.0	4.4
4423.875000	53.66	---	68.20	14.54	500.0	100.0	H	0.0	5.2
6920.250000	56.64	---	68.20	11.56	500.0	100.0	H	0.0	8.8
7257.125000	---	45.71	54.00	8.29	500.0	100.0	H	0.0	9.2

Remark: 1. Correction Factor = Antenna factor + Insertion loss (cable loss + amplifier gain)

2. Margin = Limit - MAX Peak/ Average

802.11a CH40

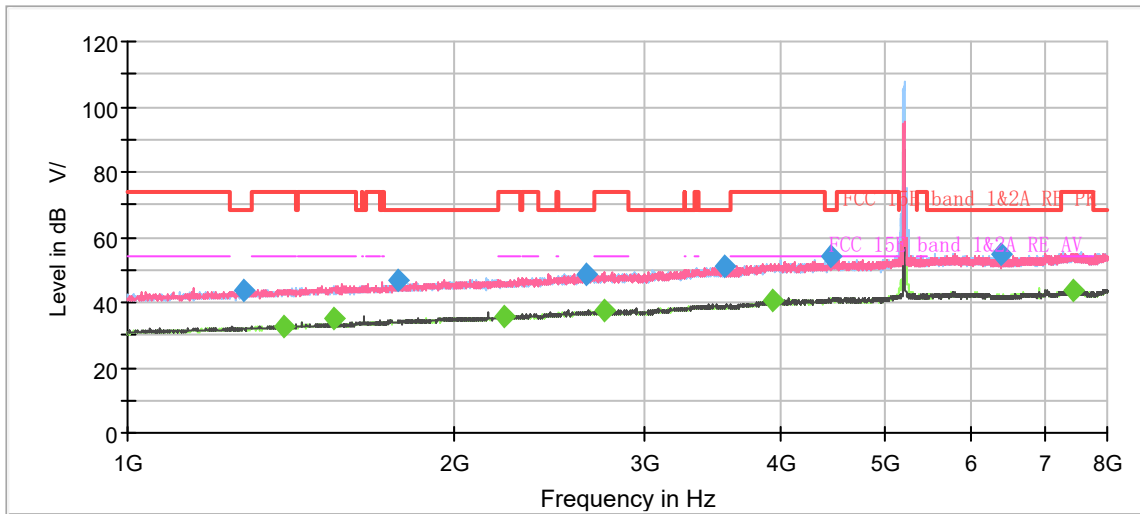

Note: The signal beyond the limit is carrier.
Radiates Emission from 1GHz to 8GHz

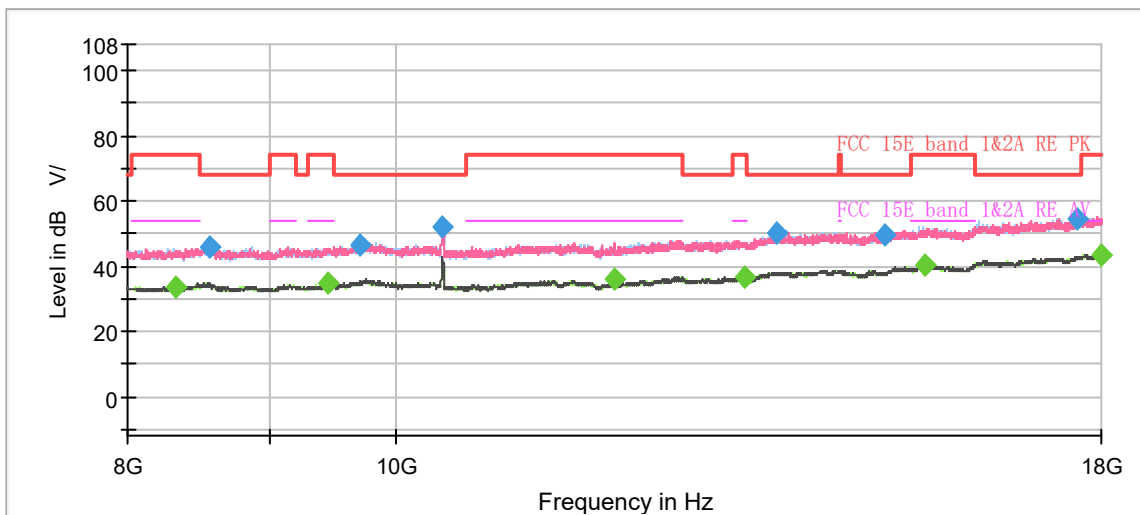

Radiates Emission from 8GHz to 18GHz

Frequency (MHz)	MaxPeak (dB μ V/m)	Average (dB μ V/m)	Limit (dB μ V/m)	Margin (dB)	Meas. Time (ms)	Height (cm)	Pol	Azimuth (deg)	Corr. (dB/m)
1280.875000	43.66	---	68.20	24.54	500.0	200.0	V	294.0	-7.3
1391.125000	---	32.84	54.00	21.16	500.0	200.0	H	166.0	-6.5
1549.500000	---	34.94	54.00	19.06	500.0	200.0	H	157.0	-5.7
1775.250000	46.63	---	68.20	21.57	500.0	200.0	V	207.0	-4.5
2220.625000	---	35.79	54.00	18.21	500.0	100.0	V	358.0	-2.5
2652.875000	48.79	---	68.20	19.41	500.0	200.0	H	181.0	-0.4
2757.000000	---	37.59	54.00	16.41	500.0	200.0	H	81.0	-0.1
3546.250000	51.26	---	68.20	16.94	500.0	200.0	H	222.0	2.6
3934.750000	---	40.74	54.00	13.26	500.0	200.0	V	25.0	4.4
4445.750000	53.92	---	68.20	14.28	500.0	200.0	V	142.0	5.3
6397.875000	54.86	---	68.20	13.34	500.0	200.0	V	10.0	8.0
7433.000000	---	43.62	54.00	10.38	500.0	100.0	H	285.0	9.2

Remark: 1. Correction Factor = Antenna factor + Insertion loss (cable loss + amplifier gain)

2. Margin = Limit - MAX Peak/ Average

802.11a CH48

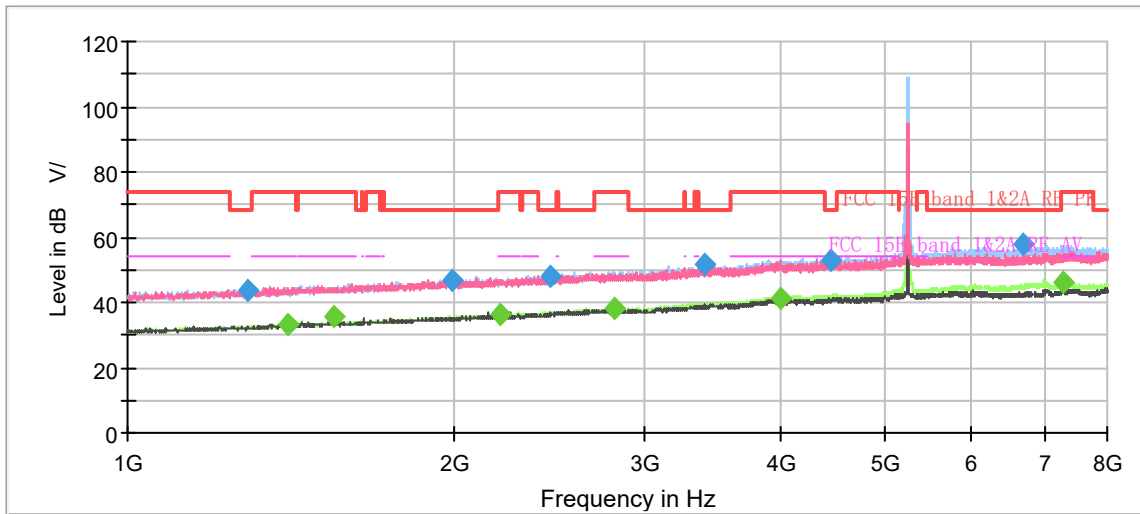

Note: The signal beyond the limit is carrier.
Radiates Emission from 1GHz to 8GHz

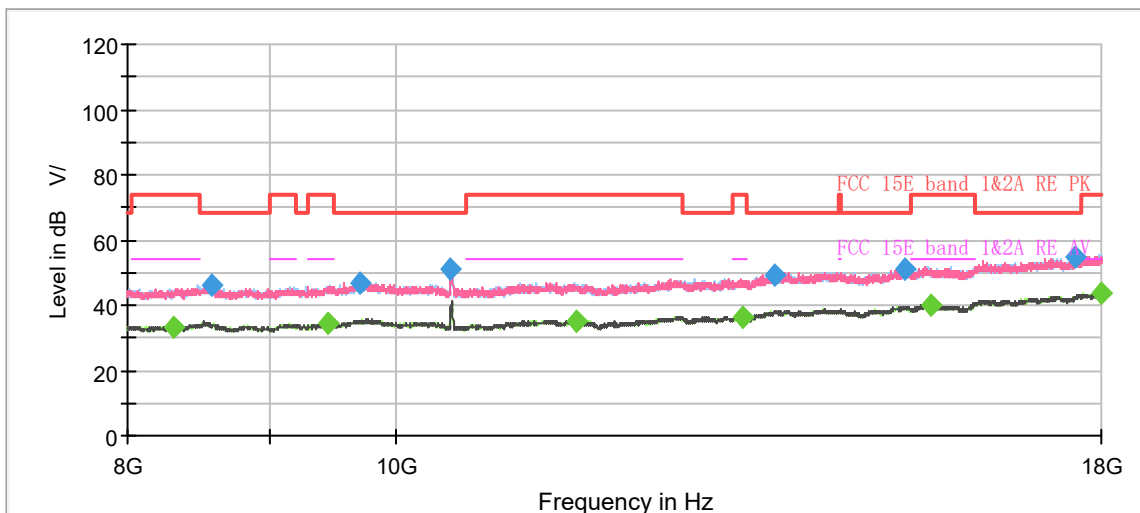

Radiates Emission from 8GHz to 18GHz

Frequency (MHz)	MaxPeak (dB μ V/m)	Average (dB μ V/m)	Limit (dB μ V/m)	Margin (dB)	Meas. Time (ms)	Height (cm)	Pol	Azimuth (deg)	Corr. (dB/m)
1292.250000	43.65	---	68.20	24.55	500.0	200.0	V	180.0	-7.2
1406.000000	---	33.22	54.00	20.78	500.0	100.0	H	355.0	-6.4
1549.500000	---	35.46	54.00	18.54	500.0	100.0	H	355.0	-5.7
1992.250000	47.04	---	68.20	21.16	500.0	100.0	H	330.0	-3.5
2207.500000	---	36.12	54.00	17.88	500.0	100.0	H	345.0	-2.6
2449.875000	47.87	---	68.20	20.33	500.0	100.0	H	179.0	-1.4
2813.000000	---	38.27	54.00	15.73	500.0	100.0	H	245.0	0.0
3403.625000	51.94	---	68.20	16.26	500.0	100.0	H	285.0	2.2
3996.875000	---	41.50	54.00	12.50	500.0	100.0	H	265.0	4.5
4451.875000	53.02	---	68.20	15.18	500.0	100.0	H	330.0	5.3
6696.250000	58.12	---	68.20	10.08	500.0	100.0	H	0.0	8.5
7296.500000	---	45.96	54.00	8.04	500.0	100.0	H	255.0	9.3

Remark: 1. Correction Factor = Antenna factor + Insertion loss (cable loss + amplifier gain)

2. Margin = Limit –MAX Peak/ Average