

RF TEST REPORT

Applicant Quectel Wireless Solutions Co., Ltd.
FCC ID XMR202302AF31G
Product Wi-Fi & Bluetooth Module
Brand Quectel
Model AF31G
Report No. R2211A1014-R4V1
Issue Date May 26, 2023

TA Technology (Shanghai) Co., Ltd. tested the above equipment in accordance with the requirements in **FCC CFR47 Part 15E (2022)**. The test results show that the equipment tested is capable of demonstrating compliance with the requirements as documented in this report.

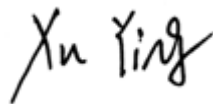

Prepared by: Xu Ying



Approved by: Xu Kai

TA Technology (Shanghai) Co., Ltd.

Building 3, No.145, Jintang Rd, Pudong Shanghai, P.R.China

TEL: +86-021-50791141/2/3

FAX: +86-021-50791141/2/3-8000

TABLE OF CONTENT

1. Test Laboratory	5
1.1. Notes of the Test Report	5
1.2. Test Facility	5
1.3. Testing Location	5
1. General Description of Equipment Under Test	6
2.1. Applicant and Manufacturer Information	6
2.2. General Information	6
3. Applied Standards	8
4. DFS Technical Requirements and Radar Test Waveforms	9
4.1. DFS Overview	9
4.2. DFS Detection Thresholds	10
4.3. Radar Test Waveforms	11
4.4. Test Set-ups	14
5. Test Case	16
5.1. DFS Detection Thresholds	16
5.2. U-NII Detection Bandwidth	17
5.3. Channel Availability Check Time	19
5.4. Channel Move Time, Channel Closing Transmission Time and Non-Occupancy Period ...	22
5.5. Statistical Performance Check	24
6. Test Results	26
6.1. DFS Detection Thresholds	26
6.2. U-NII Detection Bandwidth	34
5.6. Channel Availability Check Time	40
5.7. Channel Move Time, Channel Closing Transmission Time and Non-Occupancy Period ...	43
5.8. Statistical Performance Check	46
6. Main Test Instruments	192
ANNEX A: The EUT Appearance	193
ANNEX B: Test Setup Photos	194

Version	Revision description	Issue Date
Rev.0	Initial issue of report.	April 28, 2023
Rev.1	Update the description on page 16.	May 26, 2023
Note: This revised report (Report No.: R2211A1014-R4V1) supersedes and replaces the previously issued report (Report No.: R2211A1014-R4). Please discard or destroy the previously issued report and dispose of it accordingly.		

Summary of Measurement Results

Number	Test Case	Clause in FCC rules	Verdict
1	DFS Detection Threshold	15.407/KDB 905462 5.2	Pass
2	U-NII Detection Bandwidth	15.407/KDB 905462 7.8.1	Pass
3	Channel Availability Check Time	15.407/KDB 905462 7.8.2	Pass
4	Channel Move Time	15.407/KDB 905462 7.8.3	Pass
5	Channel Closing Transmission Time	15.407/KDB 905462 7.8.3	Pass
6	Non-Occupancy Period(NOP)	15.407/KDB 905462 7.8.3	Pass
7	Statistical Performance Check	15.407/KDB 905462 7.8.4	Pass
Date of Testing: February 23, 2023 ~ March 10, 2023 Date of Sample Received: February 15, 2023			
Note: PASS: The EUT complies with the essential requirements in the standard. FAIL: The EUT does not comply with the essential requirements in the standard. All indications of Pass/Fail in this report are opinions expressed by TA Technology (Shanghai) Co., Ltd. based on interpretations and/or observations of test results. Measurement Uncertainties were not taken into account and are published for informational purposes only.			

1. Test Laboratory

1.1. Notes of the Test Report

This report shall not be reproduced in full or partial, without the written approval of **TA technology (shanghai) co., Ltd.** The results documented in this report apply only to the tested sample, under the conditions and modes of operation as described herein. Measurement Uncertainties were not taken into account and are published for informational purposes only. This report is written to support regulatory compliance of the applicable standards stated above.

1.2. Test Facility

FCC (Designation number: CN1179, Test Firm Registration Number: 446626)

TA Technology (Shanghai) Co., Ltd. has been listed on the US Federal Communications Commission list of test facilities recognized to perform electromagnetic emissions measurements.

A2LA (Certificate Number: 3857.01)

TA Technology (Shanghai) Co., Ltd. has been listed by American Association for Laboratory Accreditation to perform electromagnetic emission measurement.

1.3. Testing Location

Company: TA Technology (Shanghai) Co., Ltd.
Address: Building 3, No.145, Jintang Rd, Pudong Shanghai, P.R.China
City: Shanghai
Post code: 201201
Country: P. R. China
Contact: Xu Kai
Telephone: +86-021-50791141/2/3
Fax: +86-021-50791141/2/3-8000
Website: <http://www.ta-shanghai.com>
E-mail: xukai@ta-shanghai.com

1. General Description of Equipment Under Test

2.1. Applicant and Manufacturer Information

Applicant	Quectel Wireless Solutions Co., Ltd.
Applicant address	Building 5, Shanghai Business Park Phase III (Area B), No.1016 Tianlin Road, Minhang District, Shanghai, China, 200233
Manufacturer	Quectel Wireless Solutions Co., Ltd.
Manufacturer address	Building 5, Shanghai Business Park Phase III (Area B), No.1016 Tianlin Road, Minhang District, Shanghai, China, 200233

2.2. General Information

EUT Description	
Model	AF31G
SN	E1C22KA19000889
Hardware Version	R1.0
Software Version	NA
Power Supply	External power supply
Antenna Type	External Antenna
Operating Frequency Range(s)	U-NII-2A: 5250MHz-5350MHz U-NII-2C: 5470MHz-5725MHz
Modulation Type	802.11a(HT20) : OFDM 802.11n(HT20/HT40) : OFDM 802.11ac (VHT20/VHT40/VHT80):OFDM
Operating Mode	<input checked="" type="checkbox"/> Master <input type="checkbox"/> Client with radar detection <input type="checkbox"/> Client without radar detection
Note: The EUT is sent from the applicant to TA and the information of the EUT is declared by the applicant.	

Wireless Technology and Frequency Range

Wireless Technology		Bandwidth	Channel	Frequency
Wi-Fi	U-NII-2A	20 MHz	52	5260MHz
			56	5280MHz
			60	5300MHz
			64	5320MHz
		40 MHz	54	5270MHz
			62	5310MHz
		80 MHz	58	5290MHz
	U-NII-2C	20 MHz	100	5500MHz
			104	5520MHz
			108	5540MHz
			112	5560MHz
			116	5580MHz
			120	5600MHz
			124	5620MHz
			128	5640MHz
			132	5660MHz
			136	5680MHz
			140	5700MHz
			144	5720MHz
		40 MHz	102	5510MHz
			110	5550MHz
			118	5590MHz
			126	5630MHz
			134	5670MHz
			142	5710MHz
		80 MHz	106	5530MHz
			122	5610MHz
		138	5690MHz	
Does this device support TPC Function? <input checked="" type="checkbox"/> Yes <input type="checkbox"/> No				
Does this device support TDWR Band? <input checked="" type="checkbox"/> Yes <input type="checkbox"/> No				

3. Applied Standards

According to the specifications of the manufacturer, it must comply with the requirements of the following standards:

Test standards:

FCC CFR47 Part 15E (2022) Unlicensed National Information Infrastructure Devices

Reference standard:

FCC KDB 905462 D02 UNII DFS Compliance Procedures New Rules v02

4. DFS Technical Requirements and Radar Test Waveforms

4.1. DFS Overview

Table 1 Applicability of DFS Requirements Prior to Use of a Channel

Requirement	Operational Mode		
	Master	Client Without Radar Detection	Client With Radar Detection
Non-Occupancy Period	Yes	Not required	Yes
DFS Detection Threshold	Yes	Not required	Yes
Channel Availability Check Time	Yes	Not required	Not required
U-NII Detection Bandwidth	Yes	Not required	Yes

Table 2 Applicability of DFS Requirements during Normal Operation

Requirement	Operational Mode	
	Master Device or Client with Radar Detection	Client Without Radar Detection
DFS Detection Threshold	Yes	Not required
Channel Closing Transmission Time	Yes	Yes
Channel Move Time	Yes	Yes
U-NII Detection Bandwidth	Yes	Not required
Additional Requirements for Devices with Multiple Bandwidth Modes	Master Device or Client with Radar Detection	Client Without Radar Detection
U-NII Detection Bandwidth	All BW modes must be tested	Not required
Statistical Performance Check	All BW modes must be tested	Not required
Channel Closing Transmission Time	Test using widest BW mode available	Test using the widest BW mode available for the link
Channel Move Time	Test using widest BW mode available	Test using the widest BW mode available for the link
All other tests	Any single BW mode	Not required
<p>Note: Frequencies selected for statistical performance check should include several frequencies within the radar detection bandwidth and frequencies near the edge of the radar detection bandwidth. For 802.11 devices it is suggested to select frequencies in each of the bonded 20 MHz channels and the channel center frequency.</p>		

4.2. DFS Detection Thresholds

Table 3 DFS Detection Thresholds for Master Devices and Client Devices with Radar Detection

Maximum Transmit Power	Value (See Notes 1, 2, and 3)
EIRP \geq 200 milliwatt	-64 dBm
EIRP < 200 milliwatt and power spectral density < 10 dBm/MHz	-62 dBm
EIRP < 200 milliwatt that do not meet the power spectral density requirement	-64 dBm

Note 1: This is the level at the input of the receiver assuming a 0 dBi receive antenna.

Note 2: Throughout these test procedures an additional 1 dB has been added to the amplitude of the test transmission waveforms to account for variations in measurement equipment. This will ensure that the test signal is at or above the detection threshold level to trigger a DFS response.

Note 3: EIRP is based on the highest antenna gain. For MIMO devices refer to KDB Publication 662911 D01.

Table 4 DFS Response Requirement Values

Parameter	Value
Non-occupancy Period	Minimum 30 minutes
Channel Availability Check Time	60 seconds
Channel Move Time	10 seconds See Note 1.
Channel Closing Transmission Time	200 milliseconds + an aggregate of 60 milliseconds over remaining 10 second period. See Notes 1 and 2.
U-NII Detection Bandwidth	Minimum 100% of the U-NII 99% transmission power bandwidth. See Note 3.

Note 1: Channel Move Time and the Channel Closing Transmission Time should be performed with Radar Type 0. The measurement timing begins at the end of the Radar Type 0 burst.

Note 2: The Channel Closing Transmission Time is comprised of 200 milliseconds starting at the beginning of the Channel Move Time plus any additional intermittent control signals required to facilitate a Channel move (an aggregate of 60 milliseconds) during the remainder of the 10 second period. The aggregate duration of control signals will not count quiet periods in between transmissions.

Note 3: During the U-NII Detection Bandwidth detection test, radar type 0 should be used. For each frequency step the minimum percentage of detection is 90 percent. Measurements are performed with no data traffic

4.3. Radar Test Waveforms

Table 5 Short Pulse Radar Test Waveforms

Radar Type	Pulse Width (μsec)	PRI (μsec)	Number of Pulses	Minimum Percentage of Successful Detection	Minimum Number of Trials
0	1	1428	18	See Note 1	See Note 1
1	1	Test A: 15 unique PRI values randomly selected from the list of 23 PRI values in Table 5a	Roundup	60%	30
		Test B: 15 unique PRI values randomly selected within the range of 518-3066 μsec , with a minimum increment of 1 μsec , excluding PRI values selected in Test A			
2	1-5	150-230	23-29	60%	30
3	6-10	200-500	16-18	60%	30
4	11-20	200-500	12-16	60%	30
Aggregate (Radar Types 1-4)				80%	120
Note 1: Short Pulse Radar Type 0 should be used for the detection bandwidth test, channel move time, and channel closing time tests.					

Table 5a Pulse Repetition Intervals Values for Test A

Pulse Repetition Frequency Number	Pulse Repetition Frequency (Pulses Per Second)	Pulse Repetition Interval (Microseconds)
1	1930.5	518
2	1858.7	538
3	1792.1	558
4	1730.1	578
5	1672.2	598
6	1618.1	618
7	1567.4	638
8	1519.8	658
9	1474.9	678
10	1432.7	698
11	1392.8	718
12	1355	738
13	1319.3	758
14	1285.3	778
15	1253.1	798
16	1222.5	818
17	1193.3	838
18	1165.6	858
19	1139	878
20	1113.6	898
21	1089.3	918
22	1066.1	938
23	326.2	3066

The aggregate is the average of the percentage of successful detections of Short Pulse Radar Types 1-4. For example, the following table indicates how to compute the aggregate of percentage of successful detections.

Radar Type	Number of Trials	Number of Successful Detections	Minimum Percentage of Successful Detection
1	35	29	82.9%
2	30	18	60%
3	30	27	90%
4	50	44	88%
Aggregate $(82.9\% + 60\% + 90\% + 88\%)/4 = 80.2\%$			

Table 6 Long Pulse Radar Test Waveform

Radar Type	Pulse Width (μsec)	Chirp Width (MHz)	PRI (μsec)	Number of Pulses per Burst	Number of Bursts	Minimum Percentage of Successful Detection	Minimum Number of Trials
5	50-100	5-20	1000-2000	1-3	8-20	80%	30

The parameters for this waveform are randomly chosen. Thirty unique waveforms are required for the Long Pulse Radar Type waveforms. If more than 30 waveforms are used for the Long Pulse Radar Type waveforms, then each additional waveform must also be unique and not repeated from the previous waveforms.

Table 7 Frequency Hopping Radar Test Waveform

Radar Type	Pulse Width (μsec)	PRI (μsec)	Pulses per Hop	Hopping Rate (kHz)	Hopping Sequence Length (msec)	Minimum Percentage of Successful Detection	Minimum Number of Trials
6	1	333	9	0.333	300	70%	30

For the Frequency Hopping Radar Type, the same Burst parameters are used for each waveform. The hopping sequence is different for each waveform and a 100-length segment is selected from the hopping sequence defined by the following algorithm: The first frequency in a hopping sequence is selected randomly from the group of 475 integer frequencies from 5250 – 5724 MHz. Next, the frequency that was just chosen is removed from the group and a frequency is randomly selected from the remaining 474 frequencies in the group. This process continues until all 475 frequencies are chosen for the set. For selection of a random frequency, the frequencies remaining within the group are always treated as equally likely.

4.4. Test Set-ups

We test the data stream using MPEG-X files.

Channel loading is based on IP.

Setup for Master with Injection at the Master

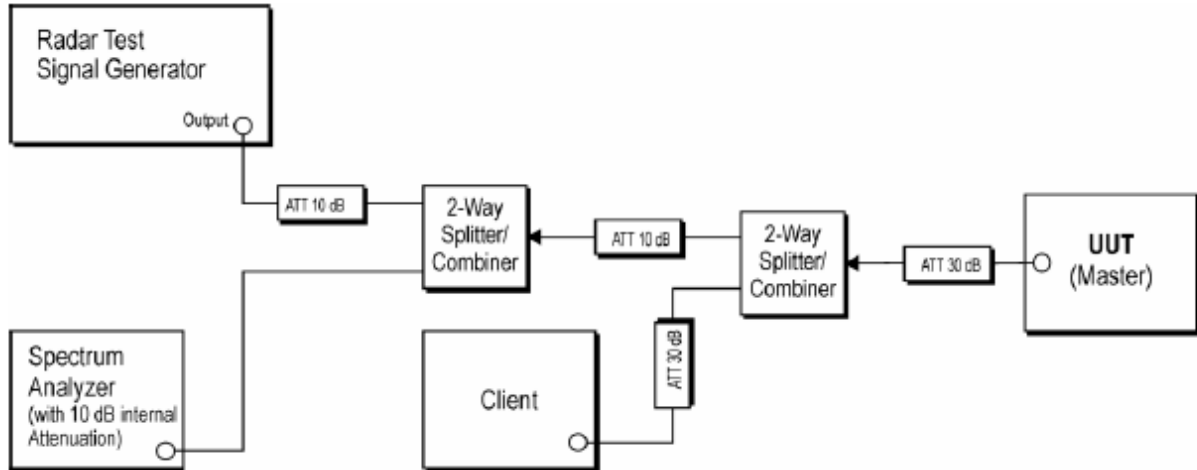

Figure 2: Example Conducted Setup where UUT is a Master and Radar Test Waveforms are injected into the Master

Setup for Client with Injection at the Master

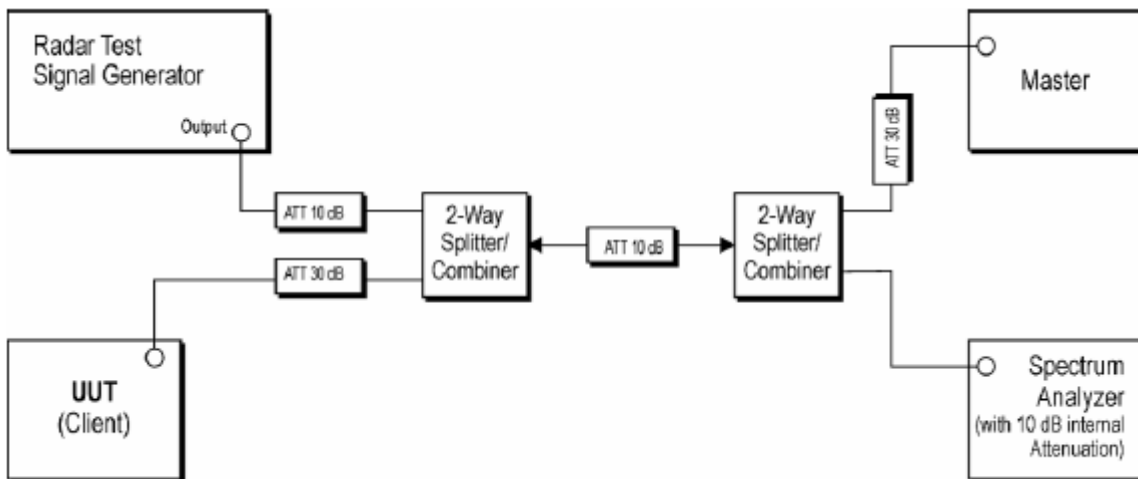

Figure 3: Example Conducted Setup where UUT is a Client and Radar Test Waveforms are injected into the Master

Setup for Client with Injection at the Client

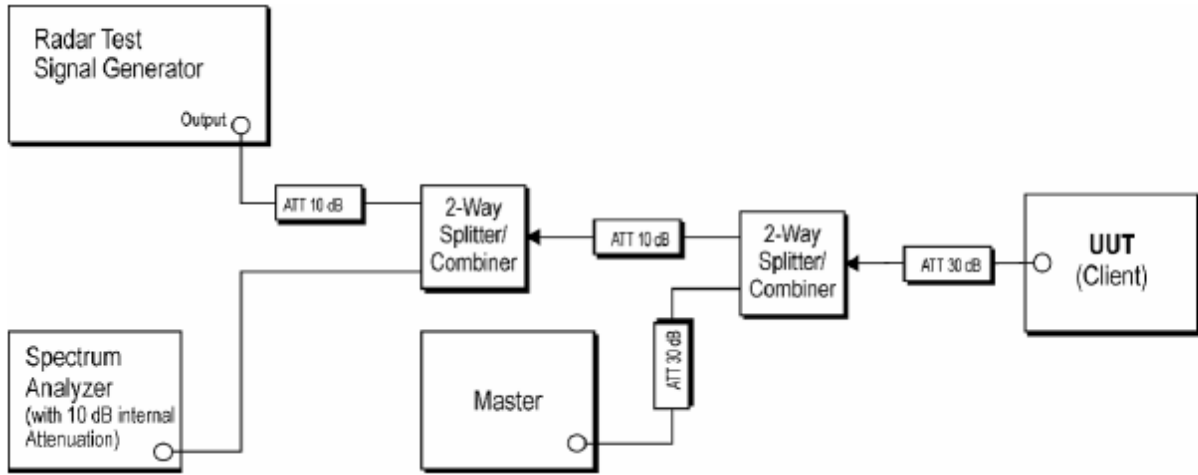

Figure 4: Example Conducted Setup where UUT is a Client and Radar Test Waveforms are injected into the Client

5. Test Case

5.1. DFS Detection Thresholds

Ambient Condition

Temperature	Relative humidity
20°C ~25°C	45%~50%

Methods of Measurement

Client with injection at the Master.

For a detection threshold level of -64dBm, the required signal strength at EUT antenna location is -64dBm, the tested level is lower than required level hence it provides margin to the limit.

Frequency of Calibration		
Mode	Bandwidth	Central Frequency
802.11ac	20MHz	5300MHz
		5500MHz
	40MHz	5270MHz
		5550MHz
	80MHz	5290MHz
		5610MHz

Calibration Result

Refer to the section 6.1 of this report for test data.

5.2. U-NII Detection Bandwidth

Ambient Condition

Temperature	Relative humidity
20°C ~25°C	45%~50%

Methods of Measurement

- 1 Adjust the equipment to produce a single Burst of any one of the Short Pulse Radar Types 0 – 4 in **Table 5** at the center frequency of the EUT Operating Channel at the specified DFS Detection Threshold level found in **Table 3**.
- 2 Set the EUT up as a standalone device (no associated Client or Master, as appropriate) and no traffic. Frame based systems will be set to a talk/listen ratio reflecting the worst case (maximum) that is user configurable during this test.
- 3 Generate a single radar Burst, and note the response of the UUT. Repeat for a minimum of 10 trials. The EUT must detect the Radar Waveform within the DFS band using the specified U-NII Detection Bandwidth criterion shown in **Table 4**. In cases where the channel bandwidth may exceed past the DFS band edge on specific channels select a channel that has the entire emission bandwidth within the DFS band. If this is not possible, test the detection BW to the DFS band edge.
- 4 Starting at the center frequency of the EUT operating Channel, increase the radar frequency in 5 MHz steps, repeating the above test sequence, until the detection rate falls below the U-NII Detection Bandwidth criterion specified in **Table 4**. Repeat this measurement in 1MHz steps at frequencies 5 MHz below where the detection rate begins to fall. Record the highest frequency (denote as FH) at which detection is greater than or equal to the U-NII Detection Bandwidth criterion. Recording the detection rate at frequencies above FH is not required to demonstrate compliance.
- 5 Starting at the center frequency of the EUT operating Channel, decrease the radar frequency in 5 MHz steps, repeating the above test sequence, until the detection rate falls below the U-NII Detection Bandwidth criterion specified in **Table 4**. Repeat this measurement in 1MHz steps at frequencies 5 MHz above where the detection rate begins to fall. Record the lowest frequency (denote as FL) at which detection is greater than or equal to the U-NII Detection Bandwidth criterion. Recording the detection rate at frequencies below FL is not required to demonstrate compliance.
- 6 The U-NII Detection Bandwidth is calculated as follows: U-NII Detection Bandwidth = FH – FL
- 7 The U-NII Detection Bandwidth must meet the U-NII Detection Bandwidth criterion specified in **Table 4**. Otherwise, the EUT does not comply with DFS requirements. This is essential to ensure that the EUT is capable of detecting Radar Waveforms across the same frequency spectrum that contains the significant energy from the system. In the case that the U-NII Detection Bandwidth is greater than or equal to the 99 percent power bandwidth for the measured FH and FL, the test can be truncated and the U-NII Detection Bandwidth can be reported as the measured FH and FL.

Limits

Rule FCC KDB 905462 7.8.1

Minimum 100% of the U-NII 99% transmission power bandwidth. During the U-NII Detection Bandwidth detection test, radar type 0 should be used. For each frequency step the minimum percentage of detection is 90 percent. Measurements are performed with no data traffic.

Measurement Uncertainty

The assessed measurement uncertainty to ensure 95% confidence level for the normal distribution is with the coverage factor $k = 2$, $U=0.44$ dB.

Test Results

Refer to the section 6.2 of this report for test data.

5.3. Channel Availability Check Time

Ambient Condition

Temperature	Relative humidity
20°C ~25°C	45%~50%

Methods of Measurement

Initial Channel Availability Check Time

The U-NII devices will be powered on and be instructed to operate on the appropriate U-NII Channel that must incorporate DFS functions. At the same time the EUT is powered on, the spectrum analyzer will be set to zero span mode with a 3 MHz RBW and 3 MHz VBW on the Channel occupied by the radar with a 2.5 minute sweep time.

The EUT should not transmit any beacon or data transmissions until at least 1 minute after the completion of the power-on cycle.

Confirm that the EUT initiates transmission on the channel

Radar Burst at the Beginning of the Channel Availability Check Time

The steps below define the procedure to verify successful radar detection on the test Channel during a period equal to the Channel Availability Check Time and avoidance of operation on that Channel when a radar Burst with a level equal to the DFS Detection Threshold + 1 dB occurs at the beginning of the Channel Availability Check Time.

The Radar Waveform generator and EUT are connected using the applicable test setup described in the sections on configuration for Conducted Tests or Radiated Tests and the power of the EUT is switched off.

The EUT is powered on at T_0 - T_1 denotes the instant when the EUT has completed its power-up sequence (T_{power_up}). The Channel Availability Check Time commences on Chr at instant T_1 and will end no sooner than $T_1 + T_{ch_avail_check}$.

A single Burst of one of the Short Pulse Radar Types 0-4 will commence within a 6 second window starting at T_1 . An additional 1 dB is added to the radar test signal to ensure it is at or above the DFS Detection Threshold, accounting for equipment variations/errors.

Visual indication or measured results on the EUT of successful detection of the radar Burst will be recorded and reported. Observation of Chr for EUT emissions will continue for 2.5 minutes after the radar Burst has been generated.

Verify that during the 2.5 minute measurement window no EUT transmissions occurred on Chr. The Channel Availability Check results will be recorded.

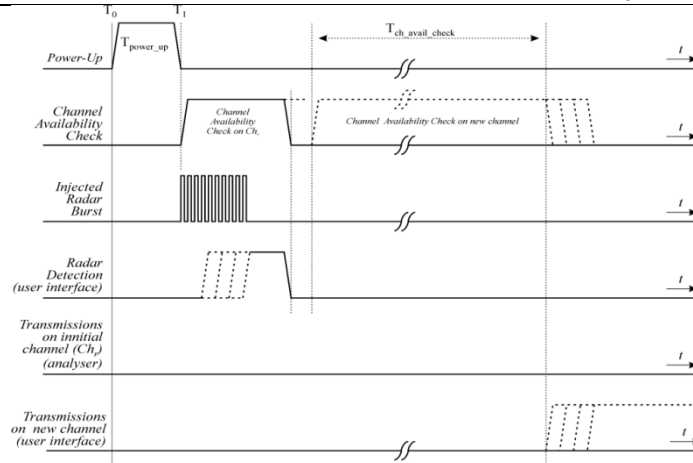

Figure: Example of timing for radar testing at the beginning of the Channel Availability Check Time

Radar Burst at the End of the Channel Availability Check Time

The steps below define the procedure to verify successful radar detection on the test Channel during a period equal to the Channel Availability Check Time and avoidance of operation on that Channel when a radar Burst with a level equal to the DFS Detection Threshold + 1dB occurs at the end of the Channel Availability Check Time.

1. The Radar Waveform generator and EUT are connected using the applicable test setup described in the sections for Conducted Tests or Radiated Tests and the power of the EUT is switched off.
2. The EUT is powered on at T_0 - T_1 denotes the instant when the EUT has completed its power-up sequence (T_{power_up}). The Channel Availability Check Time commences on Chr at instant T_1 and will end no sooner than $T_1 + T_{ch_avail_check}$.
3. A single Burst of one of the Short Pulse Radar Types 0-4 will commence within a 6 second window starting at $T_1 + 54$ seconds. An additional 1 dB is added to the radar test signal to ensure it is at or above the DFS Detection Threshold, accounting for equipment variations/errors.
4. Visual indication or measured results on the EUT of successful detection of the radar Burst will be recorded and reported. Observation of Chr for EUT emissions will continue for 2.5 minutes after the radar Burst has been generated.
5. Verify that during the 2.5 minute measurement window no EUT transmissions occurred on Chr. The Channel Availability Check results will be recorded.

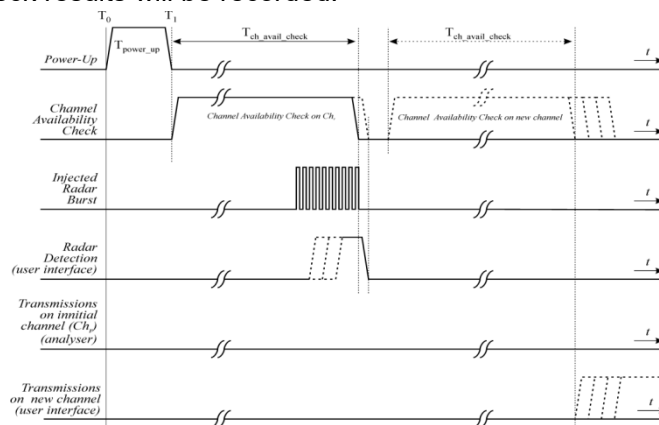

Figure: Example of timing for radar testing towards the end of the Channel Availability Check Time

Limits

Initial Channel Availability Check Time	60s
---	-----

Measurement Uncertainty

The assessed measurement uncertainty to ensure 95% confidence level for the normal distribution is with the coverage factor $k = 1.96$.

Test Results

Refer to the section 6.3 of this report for test data.

5.4. Channel Move Time, Channel Closing Transmission Time and Non-Occupancy Period

Ambient Condition

Temperature	Relative humidity
20°C ~25°C	45%~50%

Methods of Measurement

These tests define how the following DFS parameters are verified during In-Service Monitoring;

- Channel Closing Transmission Time
- Channel Move Time
- Non-Occupancy Period

The steps below define the procedure to determine the above mentioned parameters when a radar Burst with a level equal to the DFS Detection Threshold + 1dB is generated on the Operating Channel of the U-NII device (In- Service Monitoring).

1. One frequency will be chosen from the Operating Channels of the EUT within the 5250-5350 MHz or 5470-5725 MHz bands. For 802.11 devices, the test frequency must contain control signals. This can be verified by disabling channel loading and monitoring the spectrum analyzer. If no control signals are detected, another frequency must be selected within the emission bandwidth where control signals are detected.
2. In case the EUT is a U-NII device operating as a Client Device (with or without DFS), a U-NII device operating as a Master Device will be used to allow the EUT (Client device) to Associate with the Master Device. In case the EUT is a Master Device, a U-NII device operating as a Client Device will be used and it is assumed that the Client will Associate with the EUT (Master). In both cases for conducted tests, the Radar Waveform generator will be connected to the Master Device. For radiated tests, the emissions of the Radar Waveform generator will be directed towards the Master Device. If the Master Device has antenna gain, the main beam of the antenna will be directed toward the radar emitter. Vertical polarization is used for testing.
3. Stream the channel loading test file from the Master Device to the Client Device on the test Channel for the entire period of the test.
4. At time T_0 the Radar Waveform generator sends a Burst of pulses for one of the Radar Type 0 in Table 5 at levels defined in Table 3, on the Operating Channel. An additional 1 dB is added to the radar test signal to ensure it is at or above the DFS Detection Threshold, accounting for equipment variations/errors.
5. Observe the transmissions of the EUT at the end of the radar Burst on the Operating Channel for duration greater than 10 seconds. Measure and record the transmissions from the EUT during the observation time (Channel Move Time). Measure and record the Channel Move Time and Channel Closing Transmission Time if radar detection occurs. Figure 17 illustrates Channel Closing Transmission Time.

6. When operating as a Master Device, monitor the EUT for more than 30 minutes following instant T_2 to verify that the EUT does not resume any transmissions on this Channel. Perform this test once and record the measurement result.

7. In case the EUT is a U-NII device operating as a Client Device with In-Service Monitoring, perform steps 1 to 6.

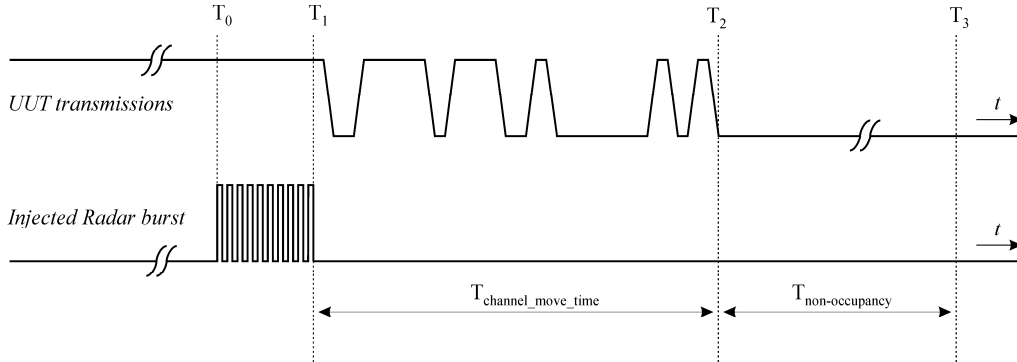

Figure 17: Example of Channel Closing Transmission Time & Channel Closing Time

Limits

Channel Move Time	$\leq 10s$
Channel Closing Transmission Time	$\leq 200ms + 60ms$ (over remaining 10s period)
Non-Occupancy Period	$\geq 30min$

Note 1: Channel Move Time and the Channel Closing Transmission Time should be performed with Radar Type 0. The measurement timing begins at the end of the Radar Type 0 burst.

Note 2: The Channel Closing Transmission Time is comprised of 200 milliseconds starting at the beginning of the Channel Move Time plus any additional intermittent control signals required to facilitate Channel move (an aggregate of 60 milliseconds) during the remainder of the 10 second period. The aggregate duration of control signals will not count quiet periods in between transmissions.

Measurement Uncertainty

The assessed measurement uncertainty to ensure 95% confidence level for the normal distribution is with the coverage factor $k = 1.96$, $U = 2.69$ dB.

Test Results

Refer to the section 6.4 of this report for test data.

5.5. Statistical Performance Check

Ambient Condition

Temperature	Relative humidity
20°C ~25°C	45%~50%

Methods of Measurement

The steps below define the procedure to determine the minimum percentage of successful detection requirements found in Tables 5-7 when a radar burst with a level equal to the DFS Detection Threshold + 1dB is generated on the Operating Channel of the U-NII device (In- Service Monitoring).

1. One frequency will be chosen from the Operating Channels of the UUT within the 5250-5350 MHz or 5470-5725 MHz bands.
2. In case the UUT is a U-NII device operating as a Client Device (with or without Radar Detection), a U-NII device operating as a Master Device will be used to allow the UUT (Client device) to Associate with the Master Device. In case the UUT is a Master Device, a U-NII device operating as a Client Device will be used and it is assumed that the Client will Associate with the UUT(Master). In both cases for conducted tests, the Radar Waveform generator will be connected to the Master Device. For radiated tests, the emissions of the Radar Waveform generator will be directed towards the Master Device. If the Master Device has antenna gain, the main beam of the antenna will be directed toward the radar emitter. Vertical polarization is used for testing.
3. Stream the channel loading test file from the Master Device to the Client Device on the test Channel for the entire period of the test.
4. At time T0 the Radar Waveform generator sends the individual waveform for each of the Radar Types 1- 6 in Tables 5-7, at levels defined in Table 3, on the Operating Channel. An additional 1 dB is added to the radar test signal to ensure it is at or above the DFS Detection Threshold, accounting for equipment variations/errors.
5. Observe the transmissions of the UUT at the end of the Burst on the Operating Channel for duration greater than 10 seconds for Radar Type 0 to ensure detection occurs.
6. Observe the transmissions of the UUT at the end of the Burst on the Operating Channel for duration greater than 22 seconds for Long Pulse Radar Type 5 to ensure detection occurs.
7. In case the UUT is a U-NII device operating as a Client Device with In-Service Monitoring, perform steps 1 to 6.

Limits

Radar Type	Minimum Percentage of Successful Detection	Minimum Number of Trials
1	60%	30
2	60%	30
3	60%	30
4	60%	30
Aggregate (Radar Types 1-4)	80%	120
5	80%	30
6	70%	30

Measurement Uncertainty

The assessed measurement uncertainty to ensure 95% confidence level for the normal distribution is with the coverage factor $k = 1.96$, $U=2.69$ dB.

Test Results

Refer to the section 6.5 of this report for test data.

6. Test Results

6.1. DFS Detection Thresholds

Radar 0

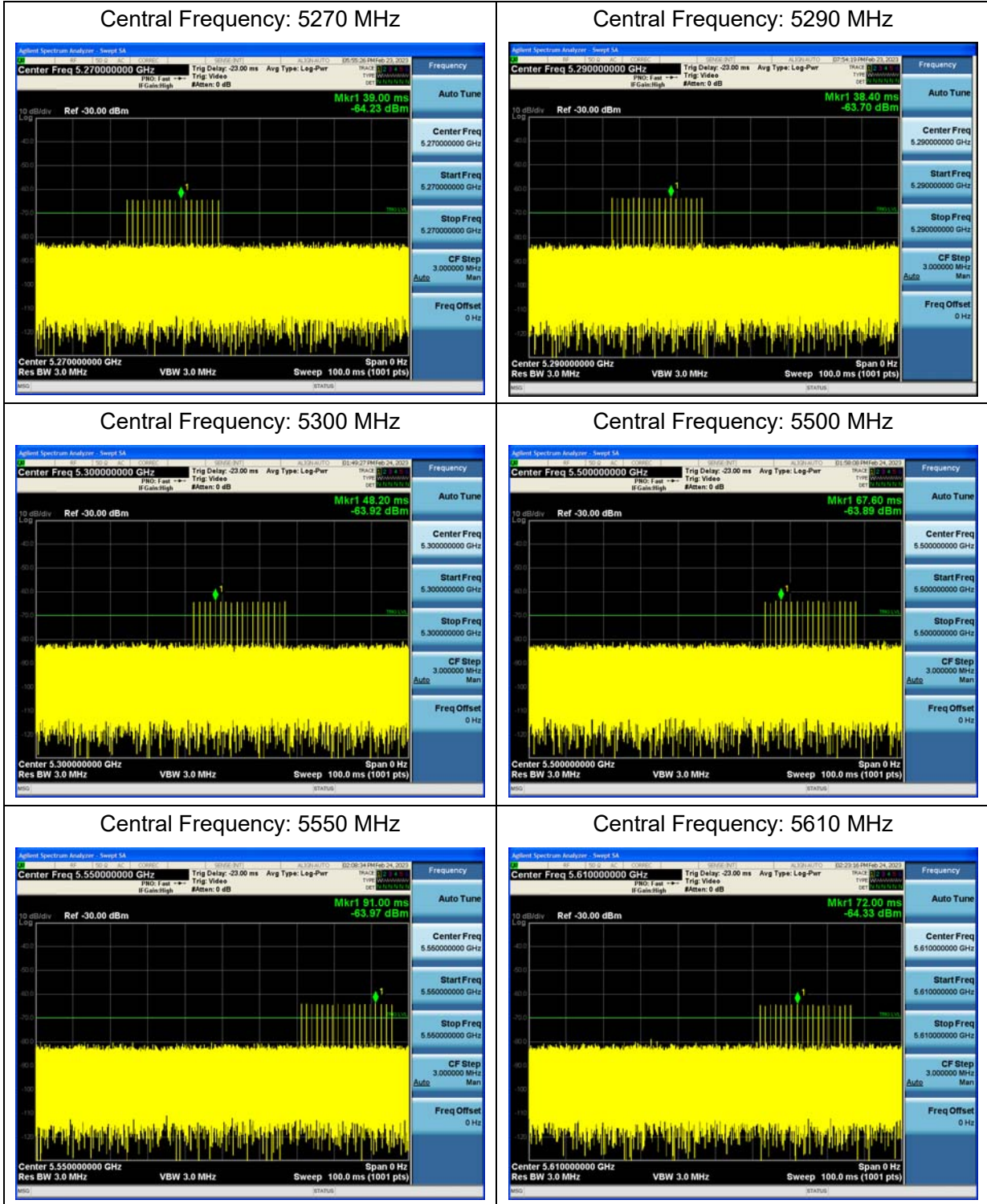

Radar 1A

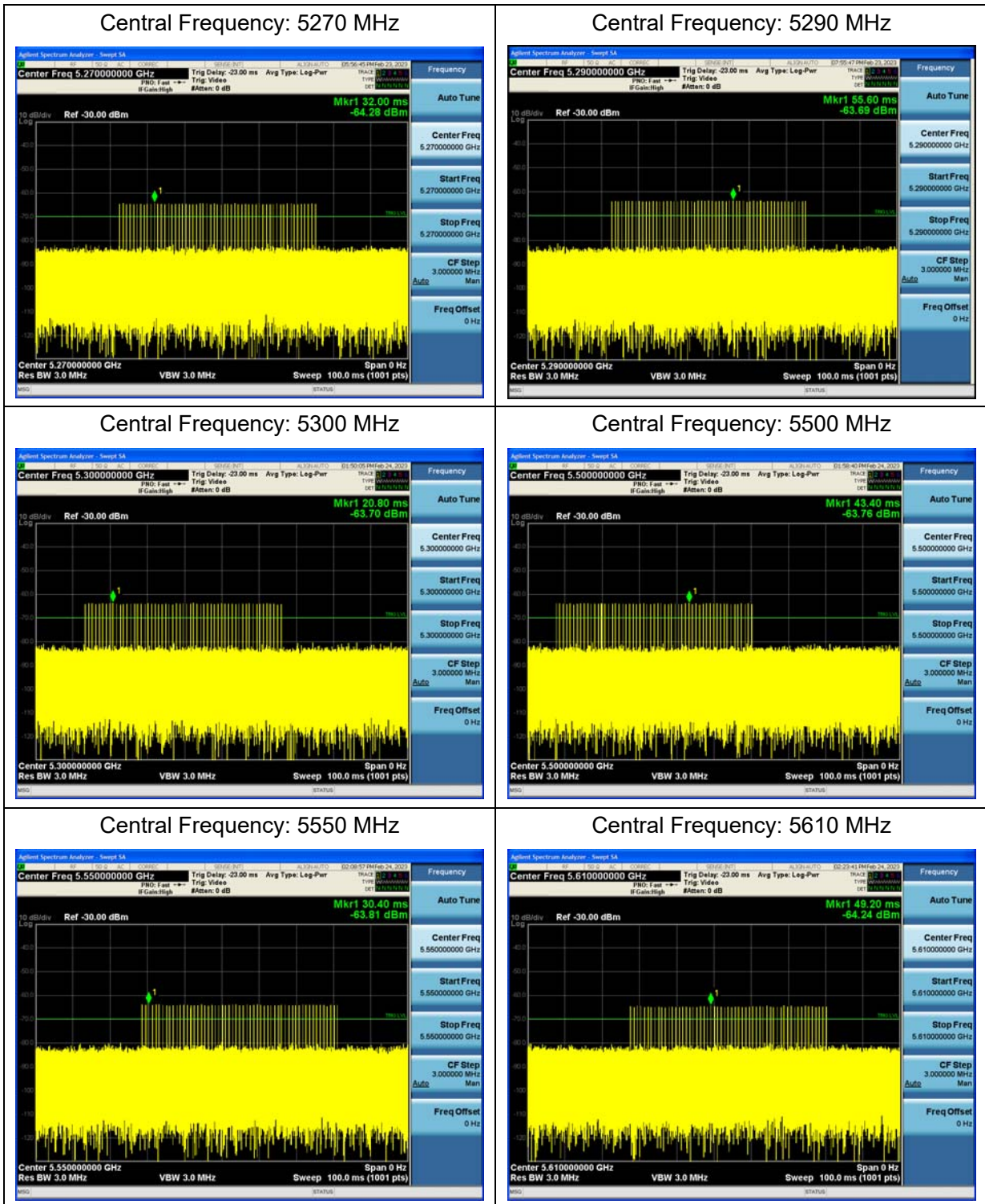

Radar 1B

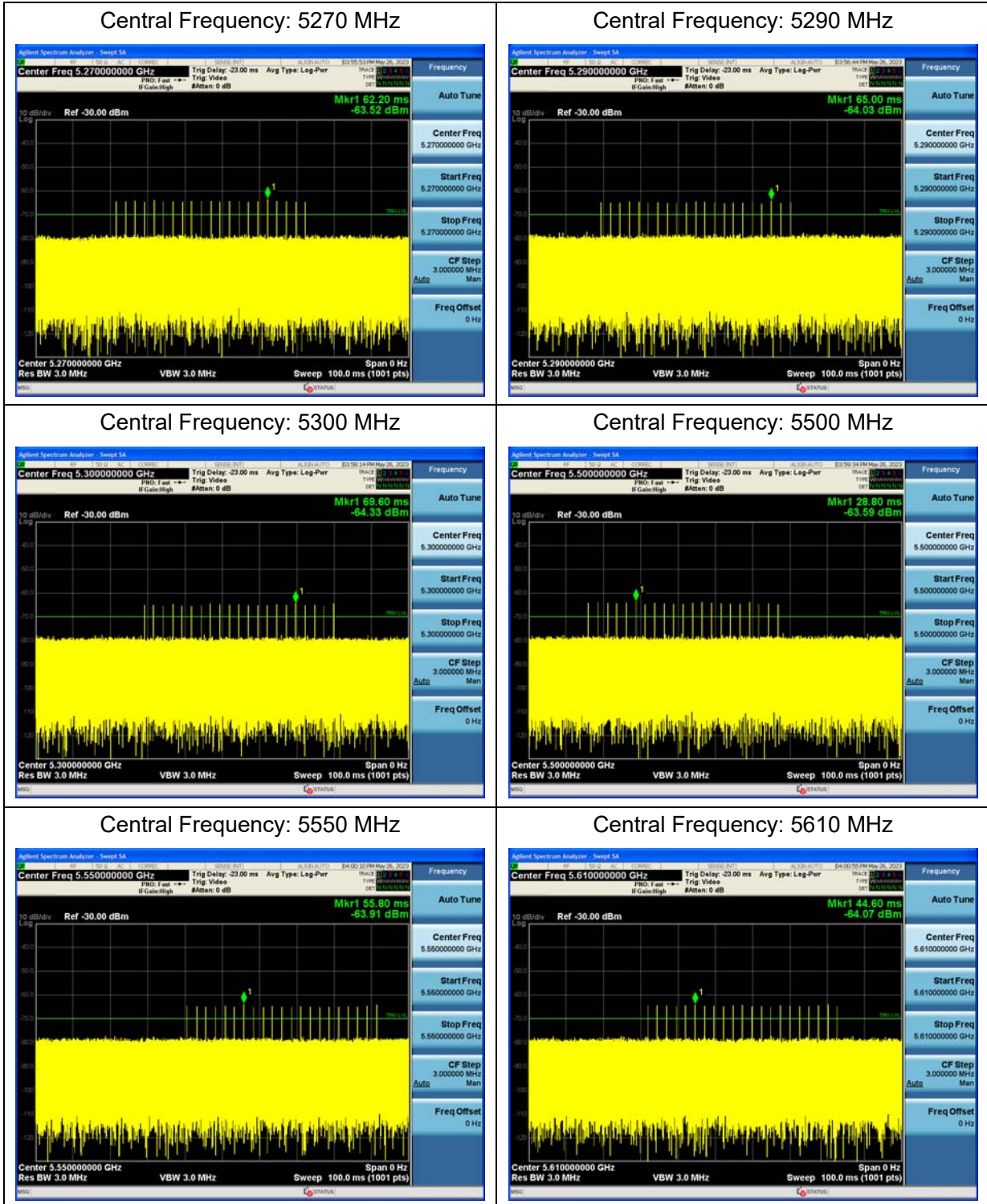

Radat 2

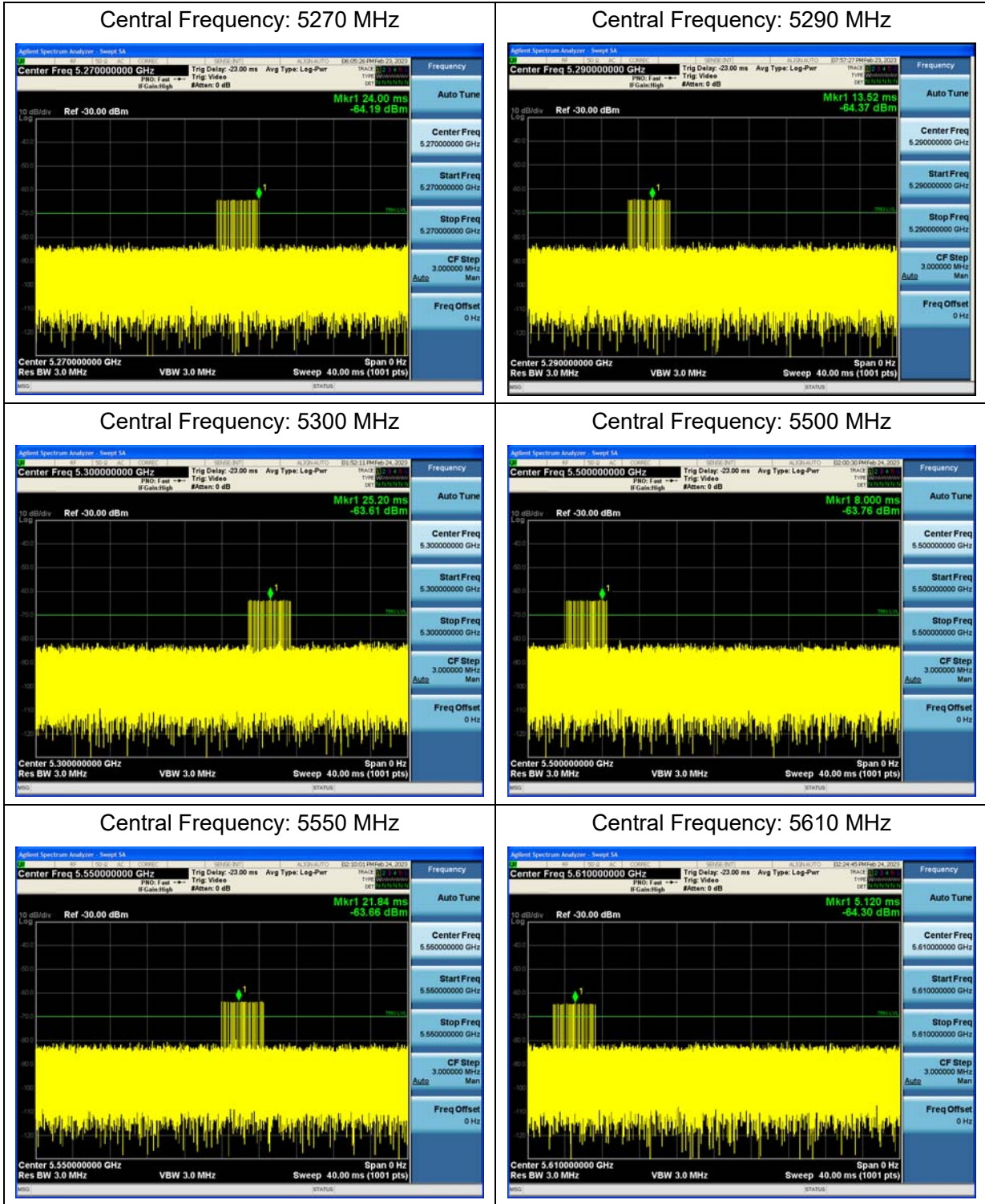

Radar 3

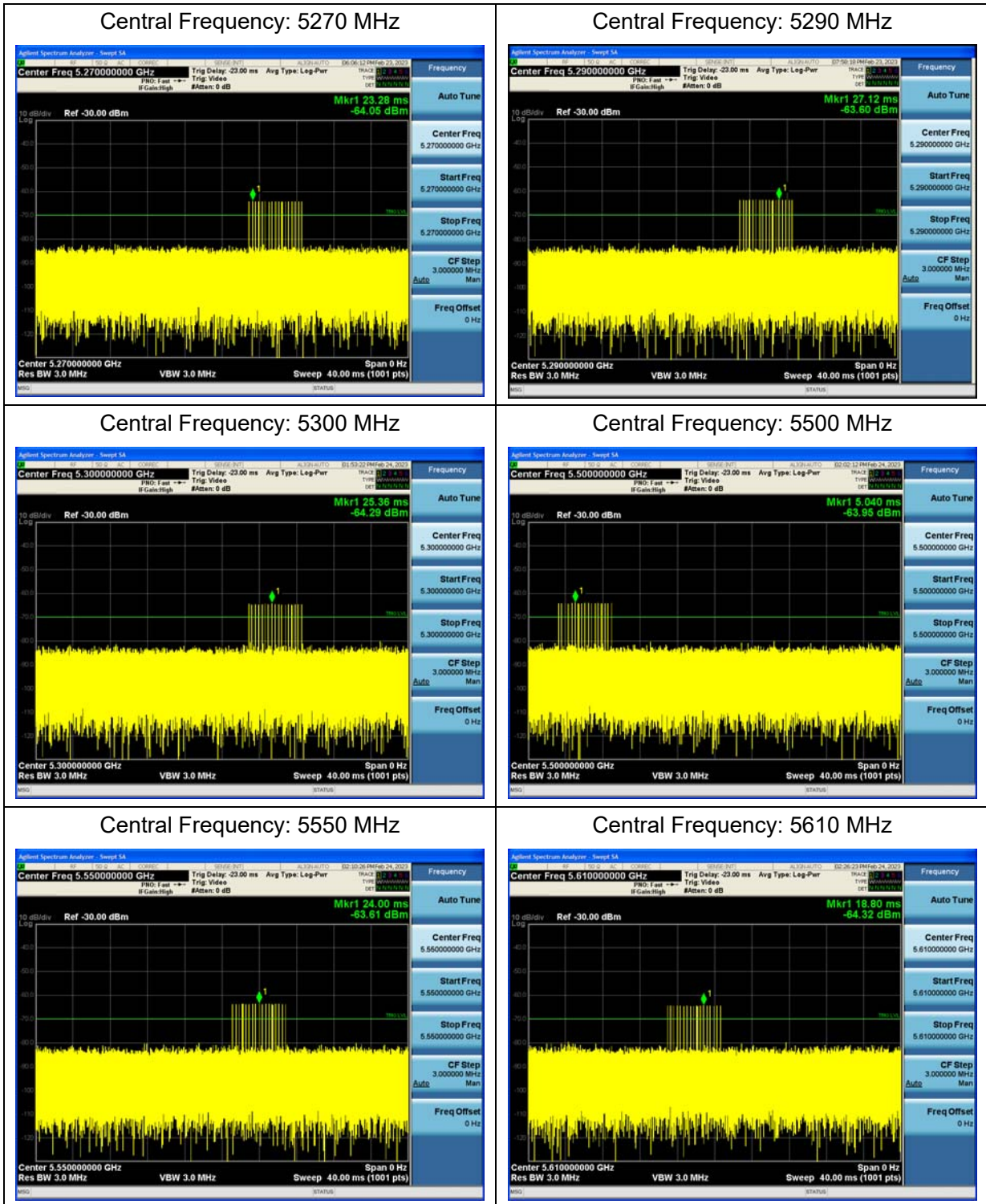

Radar 4

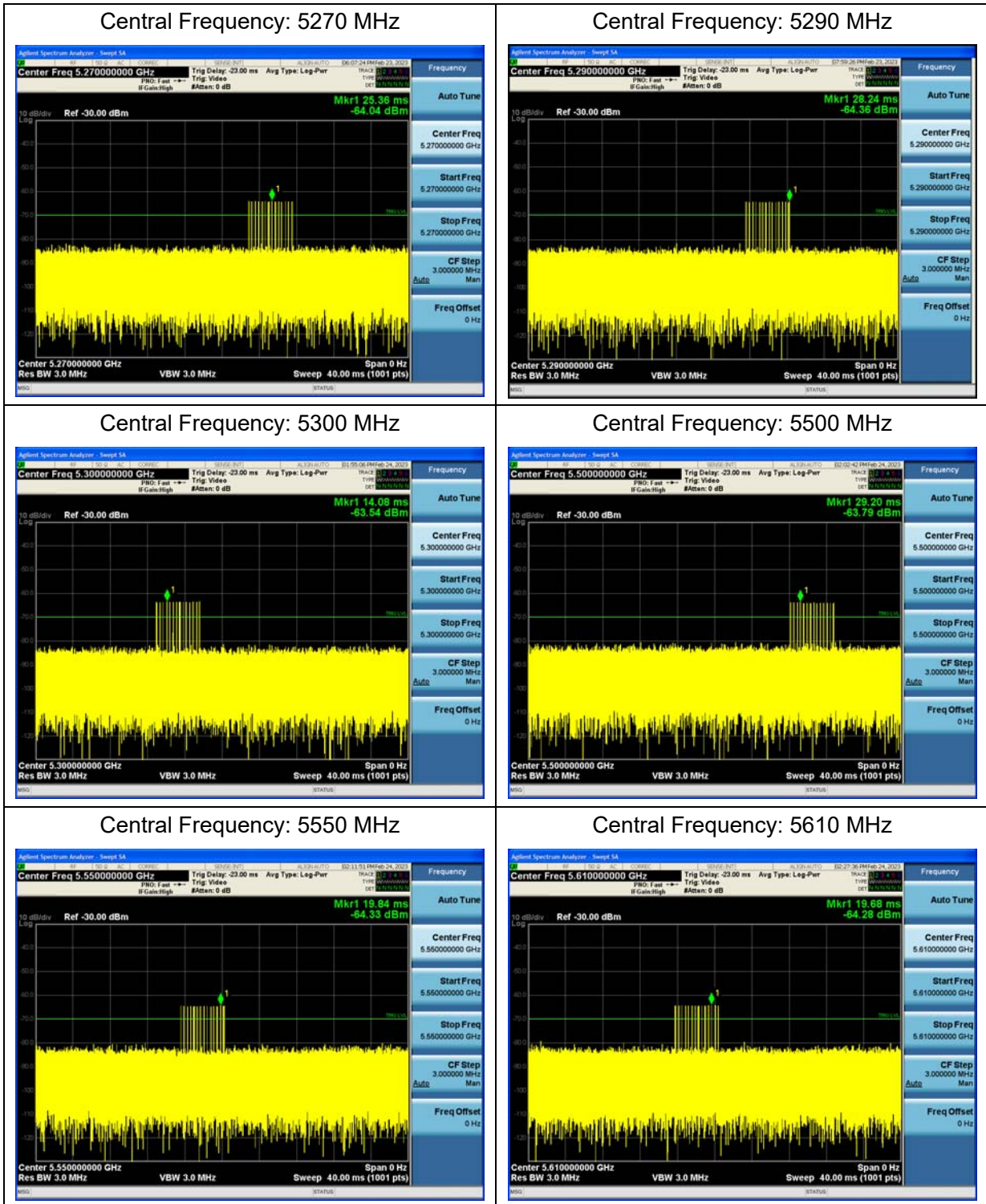

Radars 5

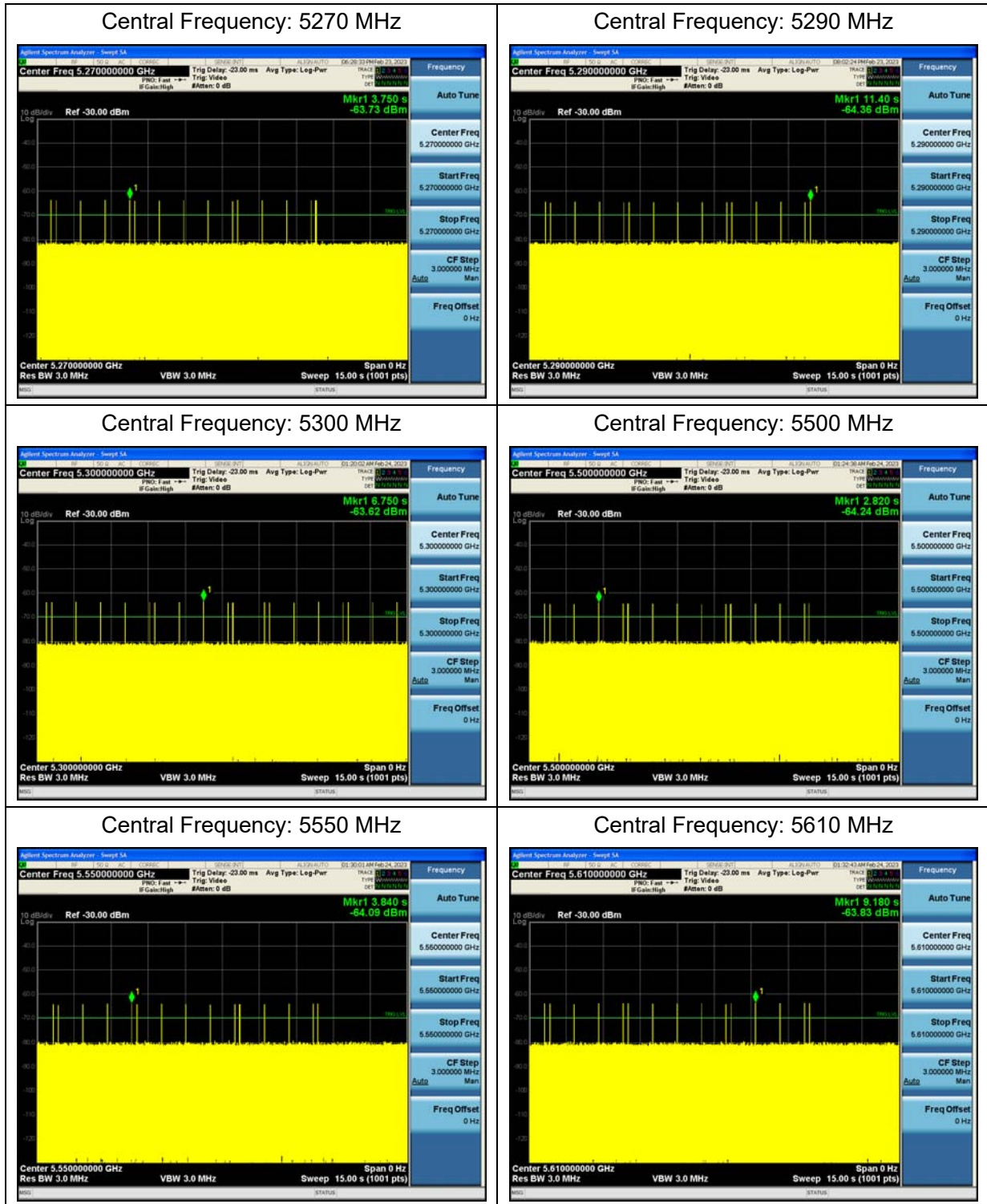

Radar 6

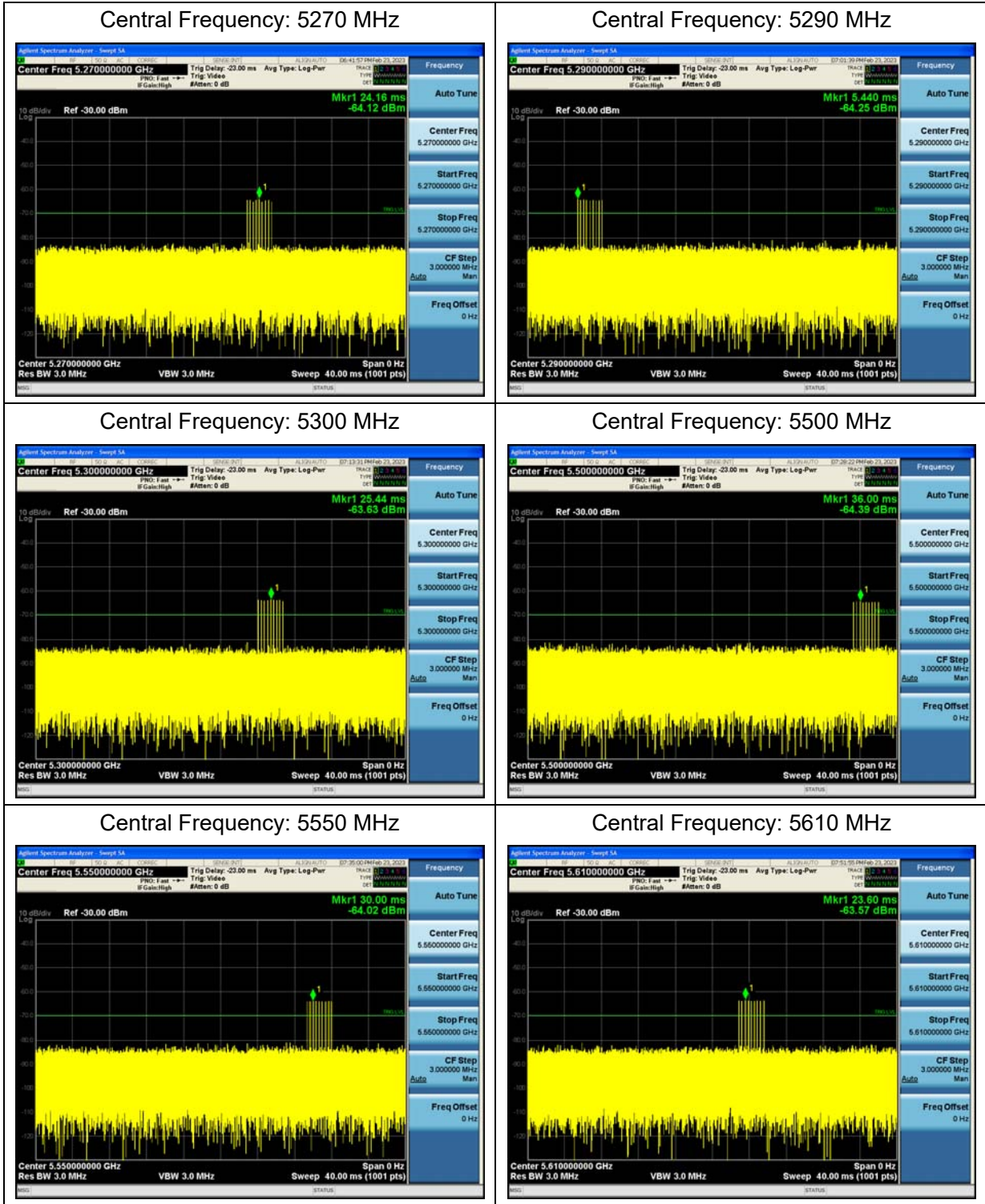

6.2. U-NII Detection Bandwidth

Timing plot

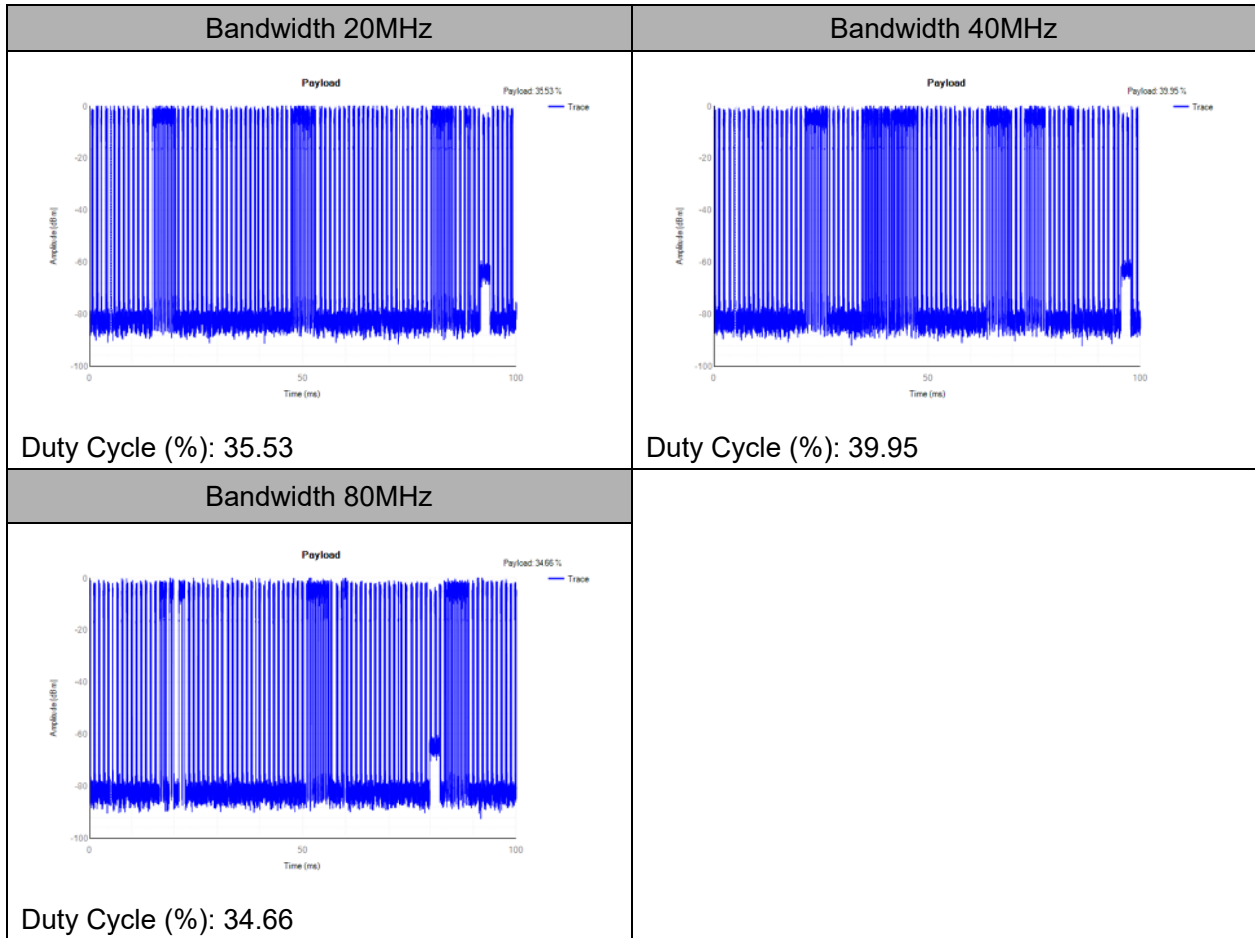

Y=Detected; N=Non-detected

Bandwidth	Frequency (MHz)	Central Frequency: 5270 MHz										Rate	
		1	2	3	4	5	6	7	8	9	10		
40 MHz	5290	N	N	N	N	N	N	N	N	N	N	N	0%
	5289	N	N	N	N	N	N	N	N	N	N	N	0%
	5288(FH)	Y	Y	Y	Y	Y	Y	Y	Y	Y	Y	Y	100%
	5287	Y	Y	Y	Y	Y	Y	Y	Y	Y	Y	Y	100%
	5286	Y	Y	Y	Y	Y	Y	Y	Y	Y	Y	Y	100%
	5285	Y	Y	Y	Y	Y	Y	Y	Y	Y	Y	Y	100%
	5280	Y	Y	Y	Y	Y	Y	Y	Y	Y	Y	Y	100%
	5275	Y	Y	Y	Y	Y	Y	Y	Y	Y	Y	Y	100%
	5270	Y	Y	Y	Y	Y	Y	Y	Y	Y	Y	Y	100%
	5265	Y	Y	Y	Y	Y	Y	Y	Y	Y	Y	Y	100%
	5260	Y	Y	Y	Y	Y	Y	Y	Y	Y	Y	Y	100%
	5255	Y	Y	Y	Y	Y	Y	Y	Y	Y	Y	Y	100%
	5254	Y	Y	Y	Y	Y	Y	Y	Y	Y	Y	Y	100%
	5253	Y	Y	Y	Y	Y	Y	Y	Y	Y	Y	Y	100%
	5252(FL)	Y	Y	Y	Y	Y	Y	Y	Y	Y	Y	Y	100%
	5251	N	N	N	N	N	N	N	N	N	N	N	0%
5250	N	N	N	N	N	N	N	N	N	N	N	0%	
Detection Bandwidth > 99%OCB		FH-FL= 36>35.930											

Bandwidth	Frequency (MHz)	Central Frequency: 5290 MHz										Rate
		1	2	3	4	5	6	7	8	9	10	
80 MHz	5330	N	N	N	N	N	N	N	N	N	N	0%
	5329	N	N	N	N	N	N	N	N	N	N	0%
	5328(FL)	Y	Y	Y	Y	Y	Y	Y	Y	Y	Y	100%
	5327	Y	Y	Y	Y	Y	Y	Y	Y	Y	Y	100%
	5326	Y	Y	Y	Y	Y	Y	Y	Y	Y	Y	100%
	5325	Y	Y	Y	Y	Y	Y	Y	Y	Y	Y	100%
	5320	Y	Y	Y	Y	Y	Y	Y	Y	Y	Y	100%
	5315	Y	Y	Y	Y	Y	Y	Y	Y	Y	Y	100%
	5310	Y	Y	Y	Y	Y	Y	Y	Y	Y	Y	100%
	5305	Y	Y	Y	Y	Y	Y	Y	Y	Y	Y	100%
	5300	Y	Y	Y	Y	Y	Y	Y	Y	Y	Y	100%
	5295	Y	Y	Y	Y	Y	Y	Y	Y	Y	Y	100%
	5290	Y	Y	Y	Y	Y	Y	Y	Y	Y	Y	100%
	5285	Y	Y	Y	Y	Y	Y	Y	Y	Y	Y	100%
	5280	Y	Y	Y	Y	Y	Y	Y	Y	Y	Y	100%
	5275	Y	Y	Y	Y	Y	Y	Y	Y	Y	Y	100%
	5270	Y	Y	Y	Y	Y	Y	Y	Y	Y	Y	100%
	5265	Y	Y	Y	Y	Y	Y	Y	Y	Y	Y	100%
	5260	Y	Y	Y	Y	Y	Y	Y	Y	Y	Y	100%
	5255	Y	Y	Y	Y	Y	Y	Y	Y	Y	Y	100%
5254	Y	Y	Y	Y	Y	Y	Y	Y	Y	Y	100%	
5253	Y	Y	Y	Y	Y	Y	Y	Y	Y	Y	100%	
5252(FL)	Y	Y	Y	Y	Y	Y	Y	Y	Y	Y	100%	
5251	N	N	N	N	N	N	N	N	N	N	0%	
5250	N	N	N	N	N	N	N	N	N	N	0%	
Detection Bandwidth > 99%OCB		FH-FL= 76>75.198										

Bandwidth	Frequency (MHz)	Central Frequency: 5300 MHz											
		1	2	3	4	5	6	7	8	9	10	Rate	
20 MHz	5310	N	N	N	N	N	N	N	N	N	N	N	0%
	5309(FH)	Y	Y	Y	Y	Y	Y	Y	Y	Y	Y	Y	100%
	5308	Y	Y	Y	Y	Y	Y	Y	Y	Y	Y	Y	100%
	5307	Y	Y	Y	Y	Y	Y	Y	Y	Y	Y	Y	100%
	5306	Y	Y	Y	Y	Y	Y	Y	Y	Y	Y	Y	100%
	5305	Y	Y	Y	Y	Y	Y	Y	Y	Y	Y	Y	100%
	5300	Y	Y	Y	Y	Y	Y	Y	Y	Y	Y	Y	100%
	5295	Y	Y	Y	Y	Y	Y	Y	Y	Y	Y	Y	100%
	5294	Y	Y	Y	Y	Y	Y	Y	Y	Y	Y	Y	100%
	5293	Y	Y	Y	Y	Y	Y	Y	Y	Y	Y	Y	100%
	5292	Y	Y	Y	Y	Y	Y	Y	Y	Y	Y	Y	100%
	5291(FL)	Y	Y	Y	Y	Y	Y	Y	Y	Y	Y	Y	100%
	5290	N	N	N	N	N	N	N	N	N	N	N	0%
Detection Bandwidth > 99%OCB		FH-FL= 18>17.467											

Bandwidth	Frequency (MHz)	Central Frequency: 5500 MHz											
		1	2	3	4	5	6	7	8	9	10	Rate	
20 MHz	5510	N	N	N	N	N	N	N	N	N	N	N	0%
	5509(FL)	Y	Y	Y	Y	Y	Y	Y	Y	Y	Y	Y	100%
	5508	Y	Y	Y	Y	Y	Y	Y	Y	Y	Y	Y	100%
	5507	Y	Y	Y	Y	Y	Y	Y	Y	Y	Y	Y	100%
	5506	Y	Y	Y	Y	Y	Y	Y	Y	Y	Y	Y	100%
	5505	Y	Y	Y	Y	Y	Y	Y	Y	Y	Y	Y	100%
	5500	Y	Y	Y	Y	Y	Y	Y	Y	Y	Y	Y	100%
	5495	Y	Y	Y	Y	Y	Y	Y	Y	Y	Y	Y	100%
	5494	Y	Y	Y	Y	Y	Y	Y	Y	Y	Y	Y	100%
	5493	Y	Y	Y	Y	Y	Y	Y	Y	Y	Y	Y	100%
	5492	Y	Y	Y	Y	Y	Y	Y	Y	Y	Y	Y	100%
	5491(FL)	Y	Y	Y	Y	Y	Y	Y	Y	Y	Y	Y	100%
	5490	N	N	N	N	N	N	N	N	N	N	N	0%
Detection Bandwidth > 99%OCB		FH-FL= 18>17.445											

Bandwidth	Frequency (MHz)	Central Frequency: 5550 MHz										Rate	
		1	2	3	4	5	6	7	8	9	10		
40 MHz	5570	N	N	N	N	N	N	N	N	N	N	N	0%
	5569	N	N	N	N	N	N	N	N	N	N	N	0%
	5568(FH)	Y	Y	Y	Y	Y	Y	Y	Y	Y	Y	Y	100%
	5567	Y	Y	Y	Y	Y	Y	Y	Y	Y	Y	Y	100%
	5566	Y	Y	Y	Y	Y	Y	Y	Y	Y	Y	Y	100%
	5565	Y	Y	Y	Y	Y	Y	Y	Y	Y	Y	Y	100%
	5560	Y	Y	Y	Y	Y	Y	Y	Y	Y	Y	Y	100%
	5555	Y	Y	Y	Y	Y	Y	Y	Y	Y	Y	Y	100%
	5550	Y	Y	Y	Y	Y	Y	Y	Y	Y	Y	Y	100%
	5545	Y	Y	Y	Y	Y	Y	Y	Y	Y	Y	Y	100%
	5540	Y	Y	Y	Y	Y	Y	Y	Y	Y	Y	Y	100%
	5535	Y	Y	Y	Y	Y	Y	Y	Y	Y	Y	Y	100%
	5534	Y	Y	Y	Y	Y	Y	Y	Y	Y	Y	Y	100%
	5533	Y	Y	Y	Y	Y	Y	Y	Y	Y	Y	Y	100%
	5532(FL)	Y	Y	Y	Y	Y	Y	Y	Y	Y	Y	Y	100%
	5531	N	N	N	N	N	N	N	N	N	N	N	0%
	5530	N	N	N	N	N	N	N	N	N	N	N	0%
Detection Bandwidth > 99%OCB		FH-FL= 36>35.960											

Bandwidth	Frequency (MHz)	Central Frequency: 5610 MHz										Rate
		1	2	3	4	5	6	7	8	9	10	
80 MHz	5650	N	N	N	N	N	N	N	N	N	N	0%
	5649	N	N	N	N	N	N	N	N	N	N	0%
	5648(FH)	Y	Y	Y	Y	Y	Y	Y	Y	Y	Y	100%
	5647	Y	Y	Y	Y	Y	Y	Y	Y	Y	Y	100%
	5646	Y	Y	Y	Y	Y	Y	Y	Y	Y	Y	100%
	5645	Y	Y	Y	Y	Y	Y	Y	Y	Y	Y	100%
	5640	Y	Y	Y	Y	Y	Y	Y	Y	Y	Y	100%
	5635	Y	Y	Y	Y	Y	Y	Y	Y	Y	Y	100%
	5630	Y	Y	Y	Y	Y	Y	Y	Y	Y	Y	100%
	5625	Y	Y	Y	Y	Y	Y	Y	Y	Y	Y	100%
	5620	Y	Y	Y	Y	Y	Y	Y	Y	Y	Y	100%
	5615	Y	Y	Y	Y	Y	Y	Y	Y	Y	Y	100%
	5610	Y	Y	Y	Y	Y	Y	Y	Y	Y	Y	100%
	5605	Y	Y	Y	Y	Y	Y	Y	Y	Y	Y	100%
	5600	Y	Y	Y	Y	Y	Y	Y	Y	Y	Y	100%
	5595	Y	Y	Y	Y	Y	Y	Y	Y	Y	Y	100%
	5590	Y	Y	Y	Y	Y	Y	Y	Y	Y	Y	100%
	5585	Y	Y	Y	Y	Y	Y	Y	Y	Y	Y	100%
	5580	Y	Y	Y	Y	Y	Y	Y	Y	Y	Y	100%
	5575	Y	Y	Y	Y	Y	Y	Y	Y	Y	Y	100%
5574	Y	Y	Y	Y	Y	Y	Y	Y	Y	Y	100%	
5573	Y	Y	Y	Y	Y	Y	Y	Y	Y	Y	100%	
5572(FL)	Y	Y	Y	Y	Y	Y	Y	Y	Y	Y	100%	
5571	N	N	N	N	N	N	N	N	N	N	0%	
5570	N	N	N	N	N	N	N	N	N	N	0%	
Detection Bandwidth > 99%OCB		FH-FL= 76>75.129										

5.6. Channel Availability Check Time

Initial Channel Availability Check Time

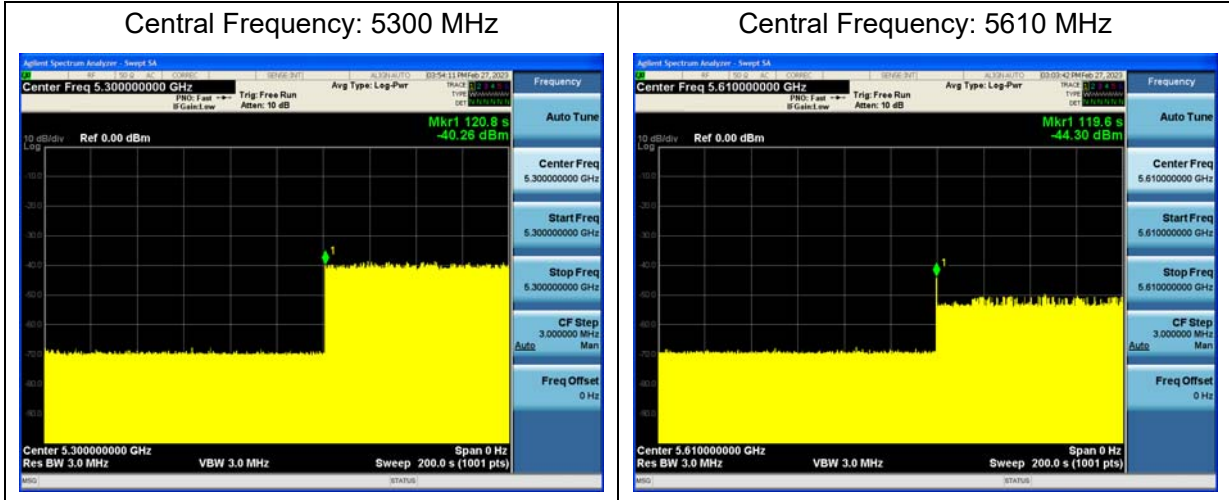

Radar Burst at the Beginning of the Channel Availability Check Time

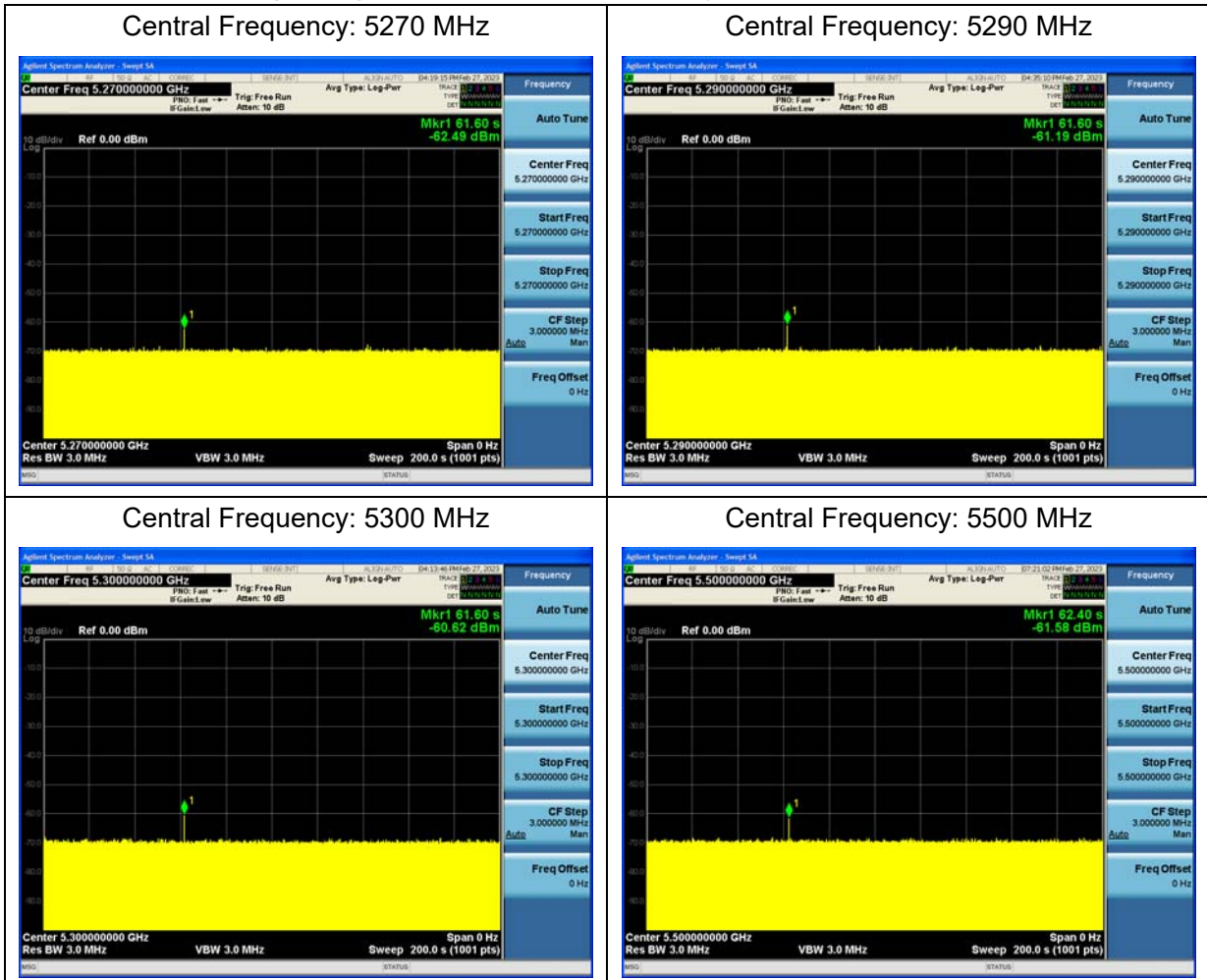

Central Frequency: 5550 MHz

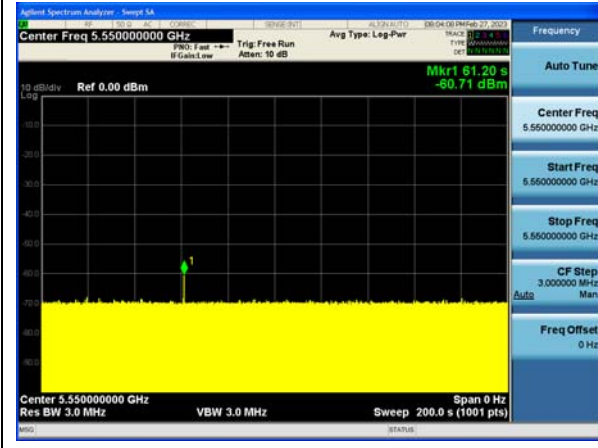

Central Frequency: 5610 MHz

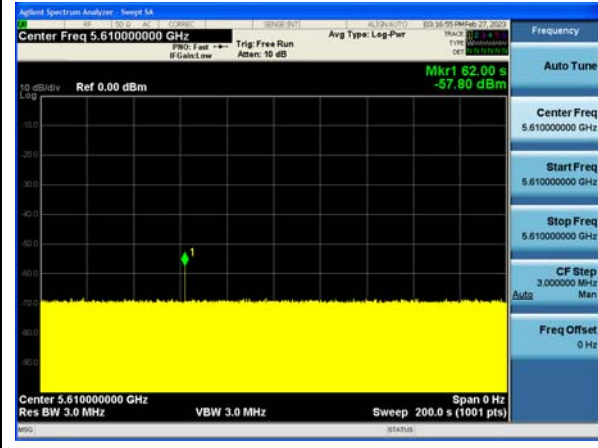

Radar Burst at the End Central Frequency

Central Frequency: 5270 MHz

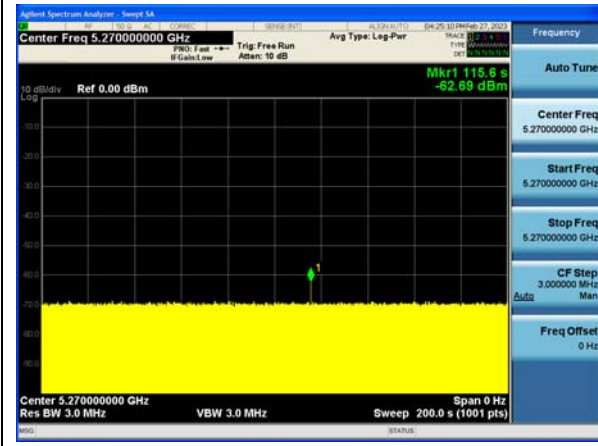

Central Frequency: 5290 MHz

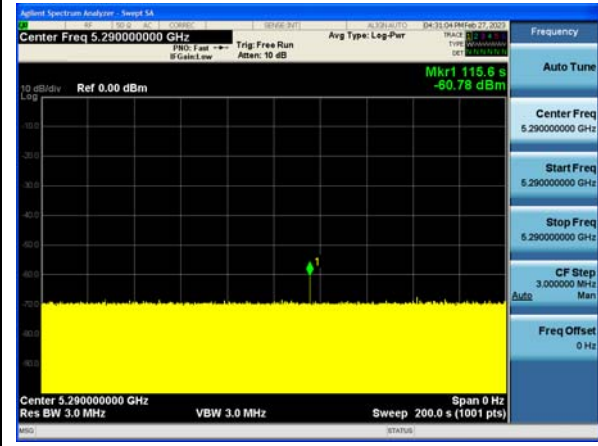

Central Frequency: 5300 MHz

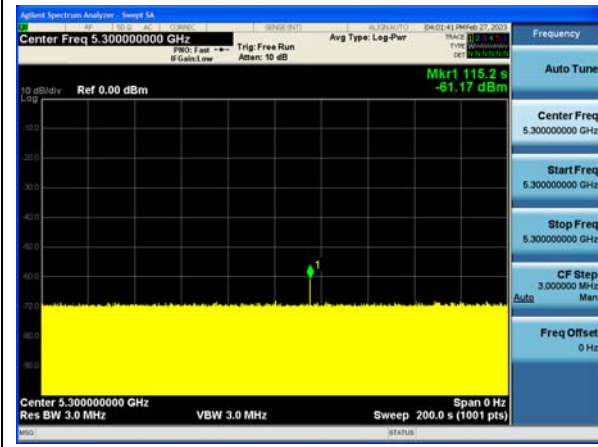

Central Frequency: 5500 MHz

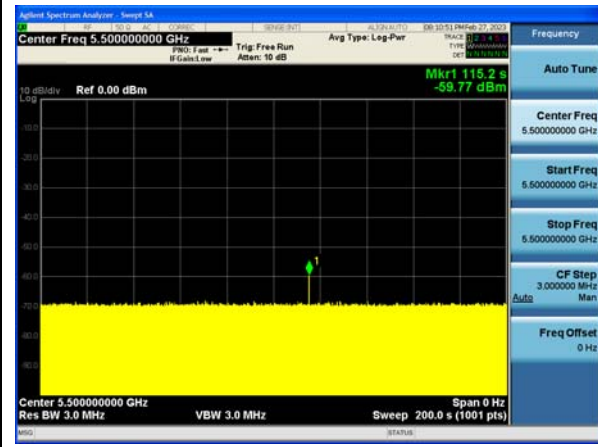

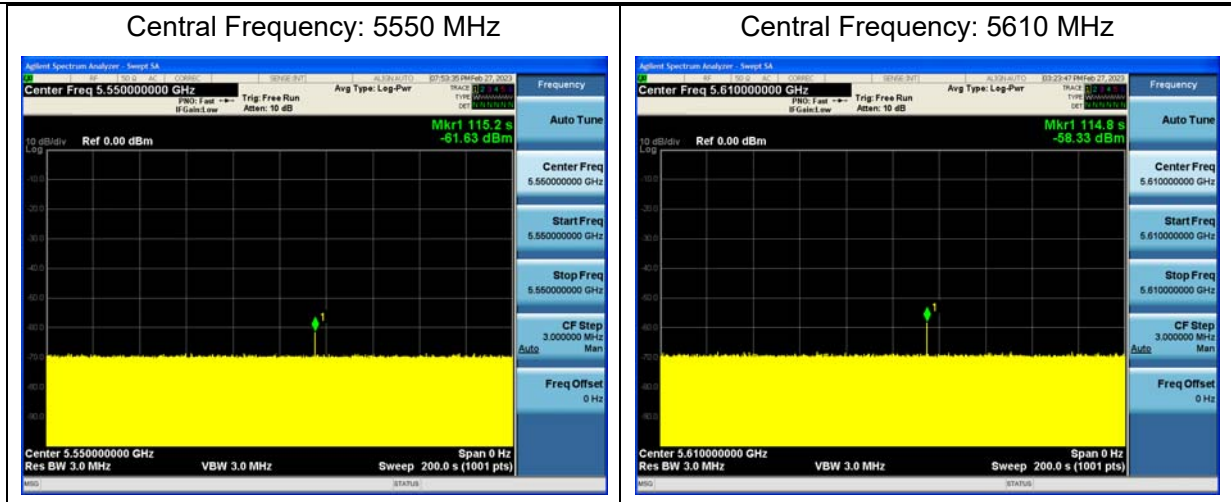

5.7. Channel Move Time, Channel Closing Transmission Time and Non-Occupancy Period

Channel Move Time

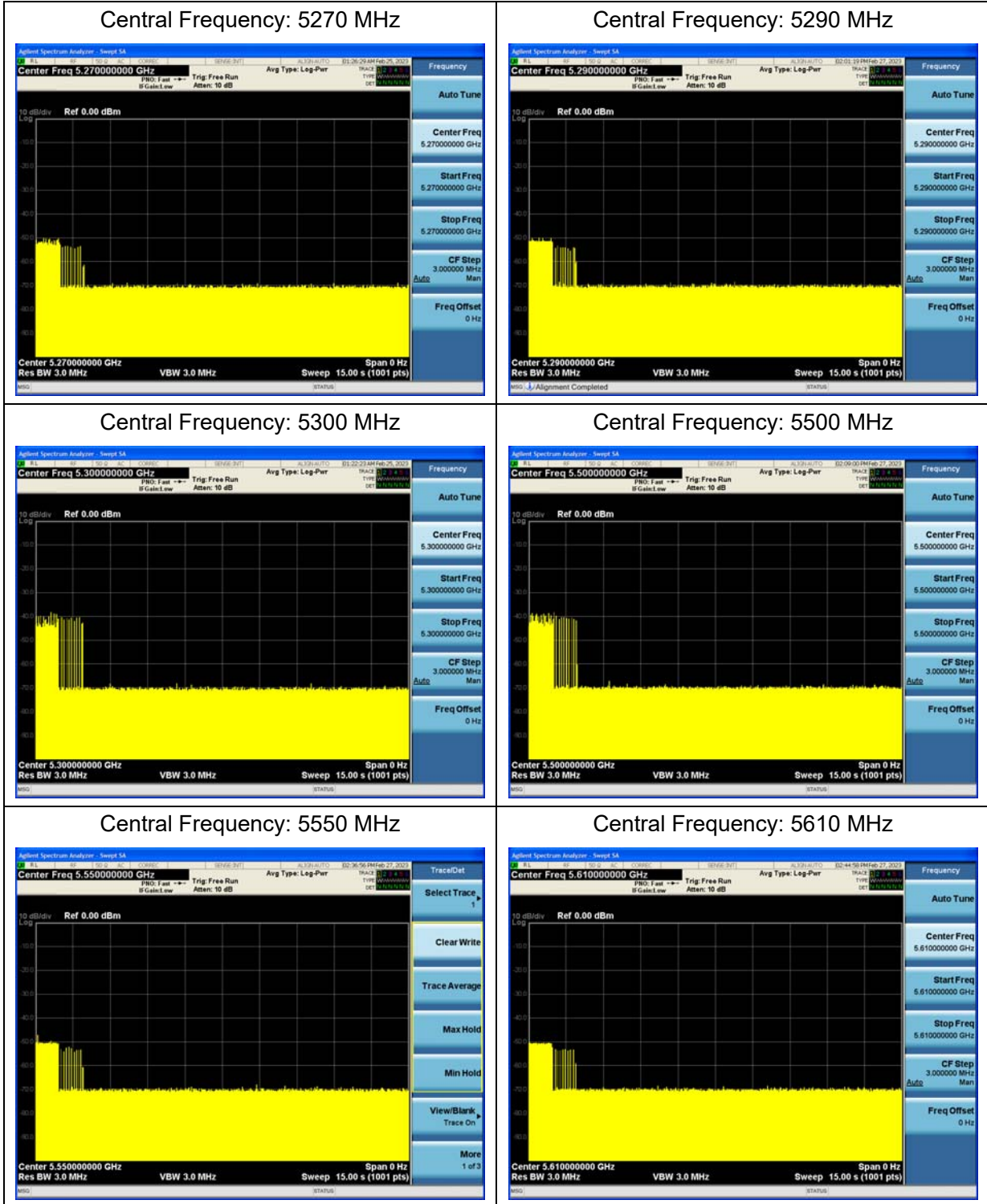

Channel Closing Transmission Time

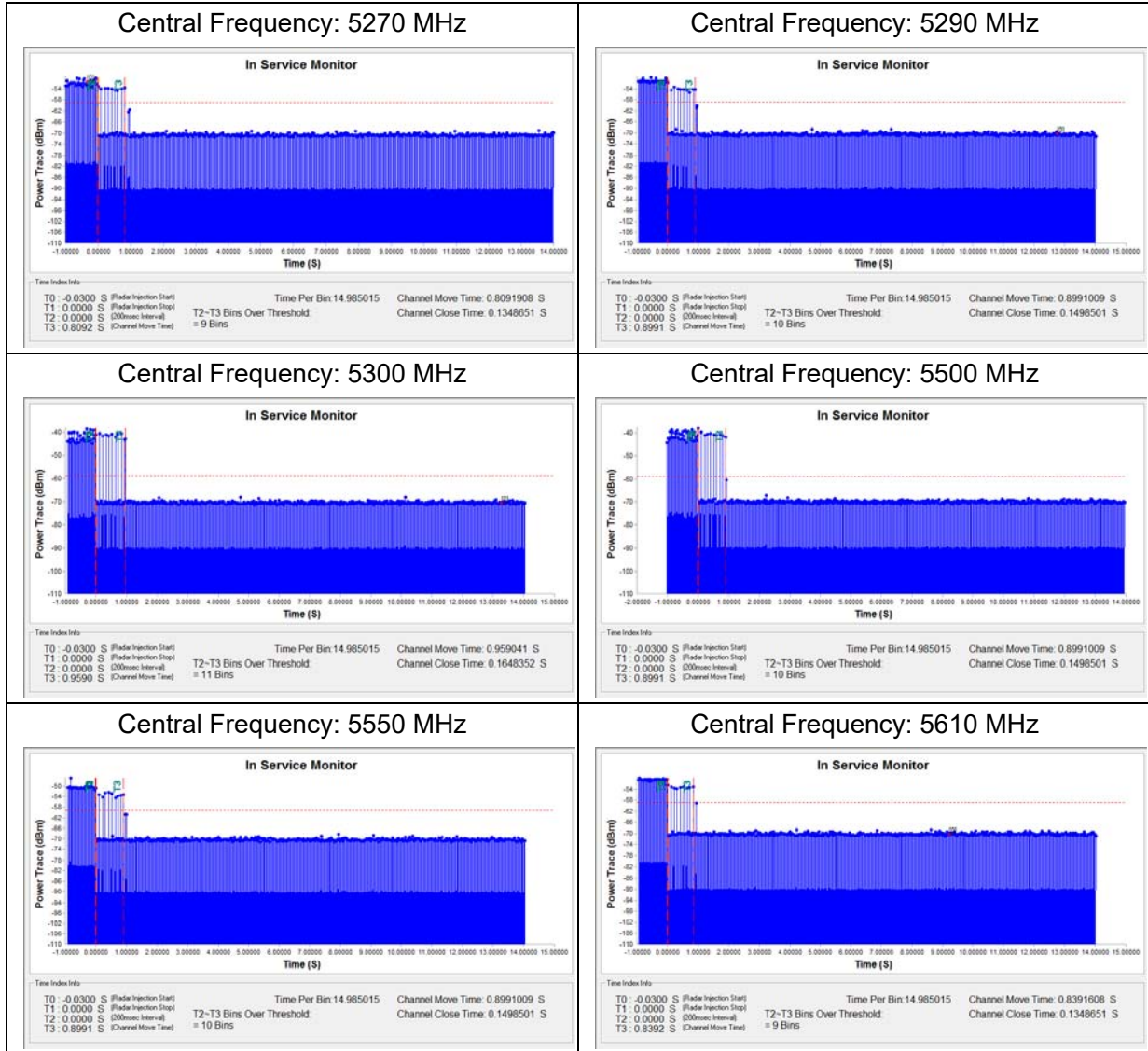

Non-Occupancy Period

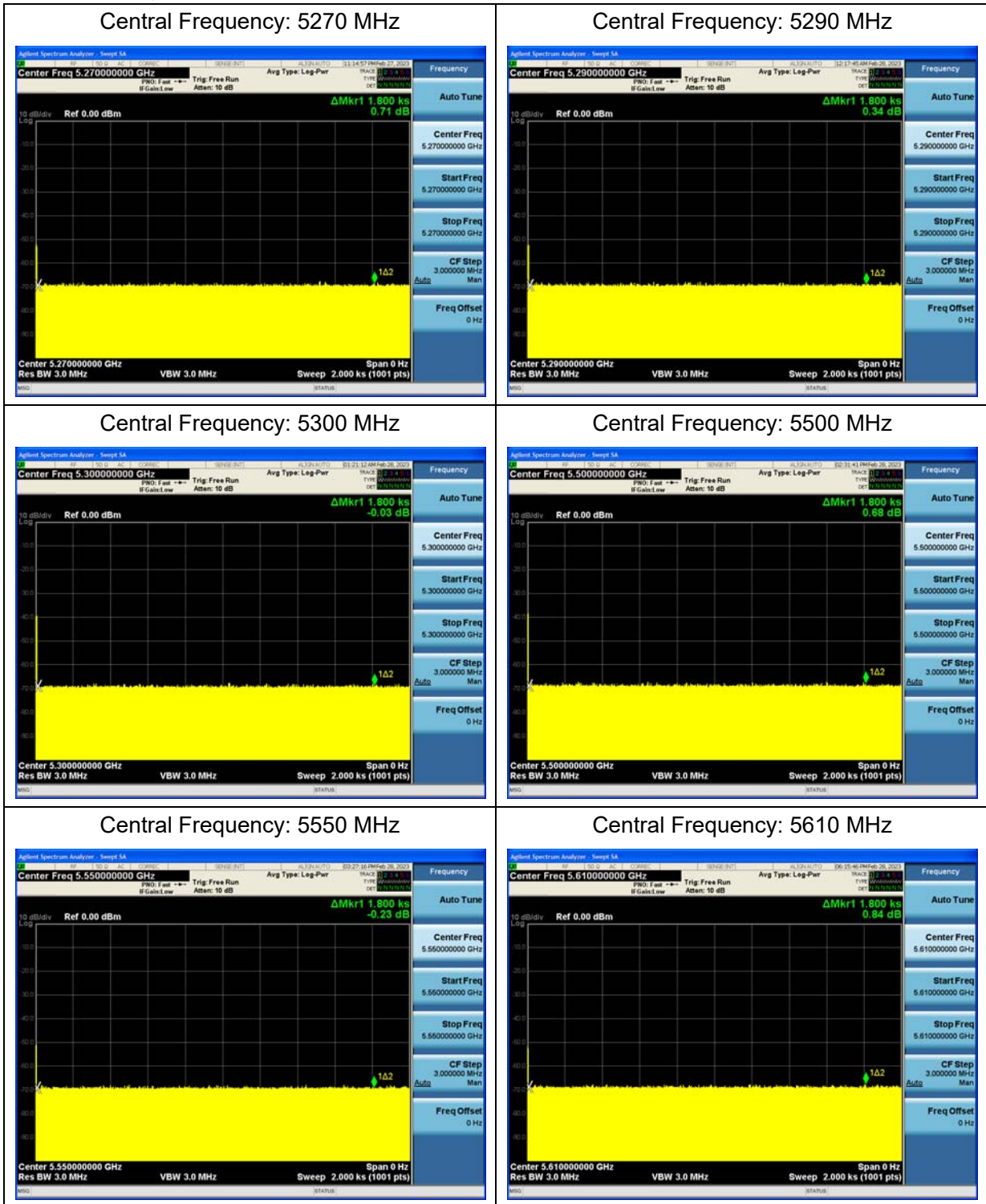

5.8. Statistical Performance Check

Y=Detected; N=Non-detected

Operating Freq (MHz)	Radar Type	Test Result	Limit
☒5270	1	100%	60%
	2	100%	60%
	3	100%	60%
	4	100%	60%
	Aggregate (Radar Types 1-4)	100%	80%
	5	86%	80%
	6	100%	70%
☒5290	1	100%	60%
	2	100%	60%
	3	100%	60%
	4	100%	60%
	Aggregate (Radar Types 1-4)	100%	80%
	5	83%	80%
	6	100%	70%
☒5300	1	100%	60%
	2	100%	60%
	3	100%	60%
	4	100%	60%
	Aggregate (Radar Types 1-4)	100%	80%
	5	86%	80%
	6	100%	70%
☒5500	1	100%	60%
	2	100%	60%
	3	100%	60%
	4	100%	60%
	Aggregate (Radar Types 1-4)	100%	80%
	5	86%	80%
	6	100%	70%
☒5550	1	97%	60%

	2	100%	60%
	3	100%	60%
	4	100%	60%
	Aggregate (Radar Types 1-4)	99.25%	80%
	5	90%	80%
	6	100%	70%
☒5610	1	100%	60%
	2	100%	60%
	3	100%	60%
	4	100%	60%
	Aggregate (Radar Types 1-4)	100%	80%
	5	93%	80%
	6	100%	70%

5270MHz, Radar 1

Trial Id	Radar Type	Pulse Width(μ s)	PRI (μ s)	Number of Pulses	Waveform Length (μ s)	conclusion
0	1	1.0	938.0	57	53466.0	Y
1	1	1.0	698.0	76	53048.0	Y
2	1	1.0	618.0	86	53148.0	Y
3	1	1.0	538.0	99	53262.0	Y
4	1	1.0	878.0	61	53558.0	Y
5	1	1.0	3066.0	18	55188.0	Y
6	1	1.0	638.0	83	52954.0	Y
7	1	1.0	918.0	58	53244.0	Y
8	1	1.0	838.0	63	52794.0	Y
9	1	1.0	858.0	62	53196.0	Y
10	1	1.0	798.0	67	53466.0	Y
11	1	1.0	718.0	74	53132.0	Y
12	1	1.0	578.0	92	53176.0	Y
13	1	1.0	598.0	89	53222.0	Y
14	1	1.0	558.0	95	53010.0	Y
15	1	1.0	2536.0	21	53256.0	Y
16	1	1.0	966.0	55	53130.0	Y
17	1	1.0	827.0	64	52928.0	Y
18	1	1.0	2501.0	22	55022.0	Y
19	1	1.0	2595.0	21	54495.0	Y
20	1	1.0	1114.0	48	53472.0	Y
21	1	1.0	1302.0	41	53382.0	Y
22	1	1.0	3045.0	18	54810.0	Y
23	1	1.0	1624.0	33	53592.0	Y
24	1	1.0	2878.0	19	54682.0	Y
25	1	1.0	1027.0	52	53404.0	Y
26	1	1.0	2485.0	22	54670.0	Y
27	1	1.0	1600.0	33	52800.0	Y
28	1	1.0	1172.0	46	53912.0	Y
29	1	1.0	1177.0	45	52965.0	Y
Detection rate: 100%						

5270MHz, Radar 2

Trial Id	Radar Type	Pulse Width(μ s)	PRI (μ s)	Number of Pulses	Waveform Length (μ s)	conclusion
0	2	3.2	179.0	26	4654.0	Y
1	2	1.1	207.0	23	4761.0	Y
2	2	2.1	230.0	24	5520.0	Y
3	2	4.8	200.0	29	5800.0	Y
4	2	3.9	214.0	28	5992.0	Y
5	2	2.9	222.0	26	5772.0	Y
6	2	3.2	204.0	26	5304.0	Y
7	2	2.5	192.0	25	4800.0	Y
8	2	3.1	164.0	26	4264.0	Y
9	2	1.2	156.0	23	3588.0	Y
10	2	3.9	210.0	27	5670.0	Y
11	2	4.6	201.0	29	5829.0	Y
12	2	3.2	162.0	26	4212.0	Y
13	2	2.2	197.0	25	4925.0	Y
14	2	4.5	163.0	29	4727.0	Y
15	2	3.0	203.0	26	5278.0	Y
16	2	5.0	168.0	29	4872.0	Y
17	2	2.4	217.0	25	5425.0	Y
18	2	2.9	191.0	26	4966.0	Y
19	2	2.3	166.0	25	4150.0	Y
20	2	3.7	150.0	27	4050.0	Y
21	2	2.2	176.0	25	4400.0	Y
22	2	4.9	195.0	29	5655	Y
23	2	2.9	202.0	26	5252.0	Y
24	2	2.5	178.0	25	4450.0	Y
25	2	1.1	206.0	23	4738.0	Y
26	2	3.8	155.0	27	4185.0	Y
27	2	4.7	157.0	29	4553.0	Y
28	2	2.4	224.0	25	5600.0	Y
29	2	4.2	159.0	28	4452.0	Y
Detection rate: 100%						

5270MHz, Radar 3

Trial Id	Radar Type	Pulse Width(μ s)	PRI (μ s)	Number of Pulses	Waveform Length (μ s)	conclusion
0	3	8.2	355.0	17	6035.0	Y
1	3	6.1	487.0	16	7792.0	Y
2	3	7.1	344.0	16	5504.0	Y
3	3	9.8	288.0	18	5184.0	Y
4	3	8.9	230.0	18	4140.0	Y
5	3	7.9	432.0	17	7344.0	Y
6	3	8.2	207.0	17	3519.0	Y
7	3	7.5	443.0	17	7531.0	Y
8	3	8.1	439.0	17	7463.0	Y
9	3	6.2	223.0	16	3568.0	Y
10	3	8.9	208.0	18	3744.0	Y
11	3	9.6	463.0	18	8334.0	Y
12	3	8.2	441.0	17	7497.0	Y
13	3	7.2	323.0	16	5168.0	Y
14	3	9.5	297.0	18	5346.0	Y
15	3	8.0	412.0	17	7004.0	Y
16	3	10.0	324.0	18	5832.0	Y
17	3	7.4	271.0	17	4607.0	Y
18	3	7.9	349.0	17	5933.0	Y
19	3	7.3	409.0	16	6544.0	Y
20	3	8.7	373.0	18	6714.0	Y
21	3	7.2	254.0	16	4064.0	Y
22	3	9.9	274.0	18	4932.0	Y
23	3	7.9	278.0	17	4726.0	Y
24	3	7.5	317.0	17	5389.0	Y
25	3	6.1	260.0	16	4160.0	Y
26	3	8.8	211.0	18	3798.0	Y
27	3	9.7	272.0	18	4896.0	Y
28	3	7.4	264.0	17	4488.0	Y
29	3	9.2	284.0	18	5112.0	Y
Detection rate: 100%						

5270MHz, Radar 4

Trial Id	Radar Type	Pulse Width(μ s)	PRI (μ s)	Number of Pulses	Waveform Length (μ s)	conclusion
0	4	16.0	355.0	14	4970.0	Y
1	4	11.3	487.0	12	5844.0	Y
2	4	13.5	344.0	13	4472.0	Y
3	4	19.4	288.0	16	4608.0	Y
4	4	17.5	230.0	15	3450.0	Y
5	4	15.3	432.0	14	6048.0	Y
6	4	15.9	207.0	14	2898.0	Y
7	4	14.3	443.0	13	5759.0	Y
8	4	15.8	439.0	14	6146.0	Y
9	4	11.5	223.0	12	2676.0	Y
10	4	17.4	208.0	15	3120.0	Y
11	4	19.0	463.0	16	7408.0	Y
12	4	16.0	441.0	14	6174.0	Y
13	4	13.8	323.0	13	4199.0	Y
14	4	18.9	297.0	16	4752.0	Y
15	4	15.5	412.0	14	5768.0	Y
16	4	19.9	324.0	16	5184.0	Y
17	4	14.1	271.0	13	3523.0	Y
18	4	15.2	349.0	14	4886.0	Y
19	4	13.8	409.0	13	5317.0	Y
20	4	17.1	373.0	15	5595.0	Y
21	4	13.8	254.0	13	3302.0	Y
22	4	19.8	274.0	16	4384.0	Y
23	4	15.3	278.0	14	3892.0	Y
24	4	14.5	317.0	13	4121.0	Y
25	4	11.3	260.0	12	3120.0	Y
26	4	17.3	211.0	15	3165.0	Y
27	4	19.2	272.0	16	4352.0	Y
28	4	14.2	264.0	13	3432.0	Y
29	4	18.2	284.0	15	4260.0	Y
Detection rate: 100%						

5270MHz, Radar 5

Trial Id	Radar Type	Number of Pulses	Chip Width (MHz)	Burst Period (s)	Waveform Length (μ s)	Center Frequency (MHz)	conclusion
0	5	15	13	0.8000000	12.0	5.2700	Y
1	5	8	19	1.5000000	12.0	5.2700	Y
2	5	11	11	1.0909091	12.0	5.2700	Y
3	5	20	12	0.6000000	12.0	5.2700	Y
4	5	17	6	0.7058824	12.0	5.2700	Y
5	5	14	15	0.8571429	12.0	5.2700	Y
6	5	15	16	0.8000000	12.0	5.2700	Y
7	5	12	17	1.0000000	12.0	5.2700	Y
8	5	14	19	0.8571429	12.0	5.2700	Y
9	5	8	12	1.5000000	12.0	5.2700	Y
10	5	17	7	0.7058824	12.0	5.2564	N
11	5	19	11	0.6315789	12.0	5.2576	Y
12	5	15	14	0.8000000	12.0	5.2552	Y
13	5	12	16	1.0000000	12.0	5.2540	Y
14	5	19	9	0.6315789	12.0	5.2572	Y
15	5	14	16	0.8571429	12.0	5.2548	Y
16	5	20	13	0.6000000	12.0	5.2580	Y
17	5	12	7	1.0000000	12.0	5.2540	N
18	5	14	10	0.8571429	12.0	5.2548	Y
19	5	12	19	1.0000000	12.0	5.2540	Y
20	5	16	12	0.7500000	12.0	5.2840	Y
21	5	12	14	1.0000000	12.0	5.2864	N
22	5	20	9	0.6000000	12.0	5.2820	Y
23	5	14	14	0.8571429	12.0	5.2852	Y
24	5	13	6	0.9230769	12.0	5.2856	Y
25	5	8	7	1.5000000	12.0	5.2880	Y
26	5	17	18	0.7058824	12.0	5.2836	Y
27	5	19	16	0.6315789	12.0	5.2824	N
28	5	12	17	1.0000000	12.0	5.2860	Y
29	5	18	16	0.6666667	12.0	5.2832	Y

Detection rate: 86%

Trial Number			0			
Bursts in Trial			16			
Center Frequency (MHz)			5270			
Burst	Number of Pulses	Pulse Width (µsec)	Chirp Width (MHz)	Pulse 1-to-2 PRI (µsec)	Pulse 2-to-3 PRI (µsec)	Start Location Within Interval (msec)
1	1	71.5	13	--	--	382.157
2	1	73.2	13	--	--	537.38
3	1	95.5	13	--	--	301.44
4	2	88.4	13	1280	--	586.04
5	2	64.8	13	1624	--	322.44
6	1	77.3	13	--	--	33.47
7	2	64.3	13	1035	--	238.39
8	1	97.4	13	--	--	422.7
9	1	60.5	13	--	--	589.16
10	2	77.3	13	1797	--	269.82
11	1	60.3	13	--	--	14.29
12	1	99.3	13	--	--	734.54
13	2	65.1	13	1528	--	118.33
14	2	56.9	13	1137	--	496.3
15	1	86	13	--	--	208.7
16	1	83.5	13	--	--	545
Detection Check (Y=Detection; N=No Detection)						Y

Trial Number			1			
Bursts in Trial			12			
Center Frequency (MHz)			5270			
Burst	Number of Pulses	Pulse Width (µsec)	Chirp Width (MHz)	Pulse 1-to-2 PRI (µsec)	Pulse 2-to-3 PRI (µsec)	Start Location Within Interval (msec)
1	3	96.6	19	1441	1588	157.072
2	2	57	19	1003	--	31.84
3	1	99.4	19	--	--	593.46
4	3	51.4	19	1076	1207	174.33
5	3	71.5	19	1105	1860	53.87
6	2	99.5	19	1009	--	204.9
7	2	96.8	19	1888	--	972.89
8	2	62.8	19	1708	--	421.81
9	2	68.6	19	1979	--	675.92
10	1	52.2	19	--	--	905.33
11	2	71.2	19	1891	--	626.2
12	1	80.7	19	--	--	297.1
Detection Check (Y=Detection; N=No Detection)						Y

Trial Number			2			
Bursts in Trial			12			
Center Frequency (MHz)			5270			
Burst	Number of Pulses	Pulse Width (µsec)	Chirp Width (MHz)	Pulse 1-to-2 PRI (µsec)	Pulse 2-to-3 PRI (µsec)	Start Location Within Interval (msec)
1	2	73	11	1720	--	60.341
2	2	86.6	11	1086	--	471.34
3	2	52	11	1769	--	149.46
4	3	89.5	11	1050	1774	665.26
5	2	91.3	11	1275	--	763.12
6	1	87.6	11	--	--	242.46
7	2	95.7	11	1592	--	386.09
8	1	79.1	11	--	--	690.82
9	2	63	11	1026	--	448.47
10	3	78.5	11	1233	1434	781.34
11	2	71.4	11	1774	--	534
12	2	93.2	11	1268	--	689.3
Detection Check (Y=Detection; N=No Detection)						Y

Trial Number			3			
Bursts in Trial			15			
Center Frequency (MHz)			5270			
Burst	Number of Pulses	Pulse Width (µsec)	Chirp Width (MHz)	Pulse 1-to-2 PRI (µsec)	Pulse 2-to-3 PRI (µsec)	Start Location Within Interval (msec)
1	3	51.8	12	1987	1673	785.215
2	1	67.1	12	--	--	304.74
3	2	80.4	12	1189	--	234.53
4	2	57.2	12	1369	--	400.36
5	3	80.9	12	1841	1377	257.92
6	2	66.8	12	1850	--	641.28
7	2	78.3	12	1566	--	763.04
8	1	95.7	12	--	--	315.89
9	2	72.6	12	1987	--	694.91
10	2	86.1	12	1099	--	12.39
11	3	54.6	12	1547	1020	744.49
12	3	82.4	12	1778	1816	623.75
13	2	52.6	12	1943	--	704.1
14	3	88.8	12	1592	1140	155.2
15	2	91.6	12	1430	--	771.7
Detection Check (Y=Detection; N=No Detection)						Y

Trial Number			4			
Bursts in Trial			15			
Center Frequency (MHz)			5270			
Burst	Number of Pulses	Pulse Width (µsec)	Chirp Width (MHz)	Pulse 1-to-2 PRI (µsec)	Pulse 2-to-3 PRI (µsec)	Start Location Within Interval (msec)
1	2	91.5	6	1778	--	131.166
2	1	58.6	6	--	--	306.44
3	1	54.2	6	--	--	157.68
4	1	68.4	6	--	--	464.16
5	2	62.8	6	1467	--	725.57
6	1	90.9	6	--	--	277.06
7	1	93.9	6	--	--	278.94
8	2	67.7	6	1128	--	83.93
9	2	57.2	6	1328	--	324.65
10	2	77.5	6	1726	--	269.88
11	1	53.8	6	--	--	538.06
12	2	56.7	6	1884	--	731.59
13	3	50.7	6	1243	1550	206.21
14	2	86.2	6	1189	--	307.7
15	1	82.7	6	--	--	208.1
Detection Check (Y=Detection; N=No Detection)						Y

Trial Number			5			
Bursts in Trial			10			
Center Frequency (MHz)			5270			
Burst	Number of Pulses	Pulse Width (µsec)	Chirp Width (MHz)	Pulse 1-to-2 PRI (µsec)	Pulse 2-to-3 PRI (µsec)	Start Location Within Interval (msec)
1	1	90.1	15	--	--	1033.2
2	2	80.7	15	1532	--	510.9
3	1	99.6	15	--	--	454.39
4	1	50.8	15	--	--	577.37
5	1	60.7	15	--	--	101.54
6	3	90	15	1254	1217	724.3
7	2	89.1	15	1337	--	977.24
8	2	96.6	15	1506	--	497.64
9	1	76.3	15	--	--	19.63
10	1	55.9	15	--	--	793.8
Detection Check (Y=Detection; N=No Detection)						Y

Trial Number			6			
Bursts in Trial			16			
Center Frequency (MHz)			5270			
Burst	Number of Pulses	Pulse Width (µsec)	Chirp Width (MHz)	Pulse 1-to-2 PRI (µsec)	Pulse 2-to-3 PRI (µsec)	Start Location Within Interval (msec)
1	3	57.1	16	1529	1704	329.074
2	2	89.7	16	1153	--	181.929
3	1	57	16	--	--	661.73
4	3	76.3	16	1421	1729	676.54
5	2	85	16	1471	--	195.28
6	2	51.1	16	1777	--	133.14
7	2	87.4	16	1935	--	235.39
8	1	76.9	16	--	--	689.87
9	2	53.7	16	1406	--	108.86
10	1	63.5	16	--	--	298.5
11	2	71.6	16	1480	--	455.93
12	1	54.9	16	--	--	458.73
13	1	54.9	16	--	--	655.32
14	1	74.4	16	--	--	342.5
15	3	57.1	16	1803	1961	253.6
16	2	60.1	16	1173	--	626.3
Detection Check (Y=Detection; N=No Detection)						Y

Trial Number			7			
Bursts in Trial			10			
Center Frequency (MHz)			5270			
Burst	Number of Pulses	Pulse Width (µsec)	Chirp Width (MHz)	Pulse 1-to-2 PRI (µsec)	Pulse 2-to-3 PRI (µsec)	Start Location Within Interval (msec)
1	1	73.5	17	--	--	1027.02
2	1	89.6	17	--	--	288.87
3	2	96.4	17	1502	--	940.16
4	1	55.4	17	--	--	538.88
5	3	77.4	17	1678	1866	313.88
6	3	94.7	17	1377	1225	810.56
7	3	87.8	17	1040	1623	571.58
8	3	69.1	17	1265	1703	573.24
9	2	93.1	17	1526	--	732
10	2	84.2	17	1218	--	1135.7
Detection Check (Y=Detection; N=No Detection)						Y

Trial Number			8			
Bursts in Trial			17			
Center Frequency (MHz)			5270			
Burst	Number of Pulses	Pulse Width (µsec)	Chirp Width (MHz)	Pulse 1-to-2 PRI (µsec)	Pulse 2-to-3 PRI (µsec)	Start Location Within Interval (msec)
1	1	99.9	19	--	--	379.224
2	3	66.9	19	1884	1117	141.215
3	3	93.9	19	1541	1081	385.095
4	1	68.1	19	--	--	381.083
5	3	64.4	19	1524	1742	555.971
6	1	55.5	19	--	--	305.368
7	2	75.7	19	1657	--	524.546
8	2	79.3	19	1445	--	300.074
9	2	92.5	19	1739	--	217.191
10	1	53.5	19	--	--	379.719
11	1	76	19	--	--	408.816
12	2	90.7	19	1974	--	321.334
13	3	50	19	1043	1917	429.582
14	3	55.9	19	1721	1782	269.669
15	3	62.5	19	1735	1532	392.247
16	2	97.3	19	1930	--	543.265
17	3	64	19	1406	1172	103.082
Detection Check (Y=Detection; N=No Detection)						Y

Trial Number			9			
Bursts in Trial			8			
Center Frequency (MHz)			5270			
Burst	Number of Pulses	Pulse Width (µsec)	Chirp Width (MHz)	Pulse 1-to-2 PRI (µsec)	Pulse 2-to-3 PRI (µsec)	Start Location Within Interval (msec)
1	1	72.5	12	--	--	509.857
2	1	82.2	12	--	--	164.27
3	2	95.6	12	1652	--	1336.41
4	3	97.5	12	1913	1669	1403.44
5	3	56.8	12	1289	1286	1431.47
6	1	59.1	12	--	--	847.09
7	2	79.4	12	1668	--	1007.5
8	1	57	12	--	--	1064.5
Detection Check (Y=Detection; N=No Detection)						Y

Trial Number			10			
Bursts in Trial			17			
Center Frequency (MHz)			5270			
Burst	Number of Pulses	Pulse Width (μsec)	Chirp Width (MHz)	Pulse 1-to-2 PRI (μsec)	Pulse 2-to-3 PRI (μsec)	Start Location Within Interval (msec)
1	1	78.3	7	--	--	66.832
2	2	84.7	7	1277	--	533.498
3	3	66.8	7	1498	1487	363.275
4	3	85.1	7	1385	1978	101.033
5	3	50.6	7	1597	1042	240.291
6	2	70.9	7	1963	--	359.558
7	2	52.6	7	1254	--	587.176
8	1	99.2	7	--	--	324.064
9	1	99.4	7	--	--	661.481
10	1	60.8	7	--	--	618.299
11	1	98.1	7	--	--	161.846
12	3	71.3	7	1514	1297	681.744
13	1	71.1	7	--	--	57.432
14	1	64.2	7	--	--	614.609
15	3	94.2	7	1515	1757	3.997
16	2	90.2	7	1007	--	409.465
17	2	94.5	7	1152	--	96.682
Detection Check (Y=Detection; N=No Detection)						N

Trial Number			11			
Bursts in Trial			14			
Center Frequency (MHz)			5270			
Burst	Number of Pulses	Pulse Width (µsec)	Chirp Width (MHz)	Pulse 1-to-2 PRI (µsec)	Pulse 2-to-3 PRI (µsec)	Start Location Within Interval (msec)
1	1	56.2	11	--	--	837.948
2	3	97.4	11	1384	1150	805.177
3	1	82.6	11	--	--	108.874
4	2	81.2	11	1739	--	561.491
5	3	57.1	11	1500	1788	637.839
6	1	96.9	11	--	--	470.256
7	2	78.8	11	1644	--	186.843
8	2	55.2	11	1314	--	537.84
9	2	90.3	11	1517	--	210.307
10	2	86.8	11	1352	--	340.554
11	1	72	11	--	--	461.061
12	2	56.3	11	1749	--	109.089
13	2	77.1	11	1952	--	370.286
14	1	93.2	11	--	--	5.543
Detection Check (Y=Detection; N=No Detection)						Y

Trial Number			12			
Bursts in Trial			13			
Center Frequency (MHz)			5270			
Burst	Number of Pulses	Pulse Width (µsec)	Chirp Width (MHz)	Pulse 1-to-2 PRI (µsec)	Pulse 2-to-3 PRI (µsec)	Start Location Within Interval (msec)
1	3	95.8	14	1940	1066	135.166
2	2	96.9	14	1620	--	508.763
3	2	64.3	14	1609	--	877.786
4	3	97.1	14	1568	1125	354.559
5	2	69.8	14	1068	--	329.312
6	2	82	14	1940	--	103.175
7	2	97	14	1961	--	131.808
8	2	93.5	14	1084	--	199.242
9	3	59.3	14	1735	1223	244.985
10	2	54.1	14	1500	--	916.988
11	1	86.7	14	--	--	784.231
12	3	84.8	14	1763	1920	134.054
13	2	99.9	14	1595	--	885.077
Detection Check (Y=Detection; N=No Detection)						Y

Trial Number			13			
Bursts in Trial			12			
Center Frequency (MHz)			5270			
Burst	Number of Pulses	Pulse Width (µsec)	Chirp Width (MHz)	Pulse 1-to-2 PRI (µsec)	Pulse 2-to-3 PRI (µsec)	Start Location Within Interval (msec)
1	2	53	16	1035	--	758.419
2	2	94.5	16	1456	--	599.82
3	1	92.9	16	--	--	897.55
4	3	50.5	16	1461	1898	387.44
5	1	55.8	16	--	--	663.7
6	2	55.8	16	1153	--	876.84
7	1	96.8	16	--	--	258.85
8	2	57.6	16	1472	--	697.38
9	1	52.8	16	--	--	238.05
10	2	84.7	16	1477	--	269.11
11	2	92.9	16	1337	--	540.7
12	2	61.8	16	1878	--	662.5
Detection Check (Y=Detection; N=No Detection)						Y

Trial Number			14			
Bursts in Trial			12			
Center Frequency (MHz)			5270			
Burst	Number of Pulses	Pulse Width (µsec)	Chirp Width (MHz)	Pulse 1-to-2 PRI (µsec)	Pulse 2-to-3 PRI (µsec)	Start Location Within Interval (msec)
1	3	87.7	9	1289	1972	865.268
2	2	75.3	9	1086	--	643.12
3	3	61.7	9	1399	1818	607.79
4	1	84.4	9	--	--	423.86
5	2	80	9	1874	--	777.53
6	2	91.9	9	1107	--	742.23
7	3	80.6	9	1890	1876	467.68
8	1	52.4	9	--	--	420.12
9	1	65.8	9	--	--	764.91
10	1	88.1	9	--	--	921.18
11	2	97.7	9	1534	--	726
12	2	53.1	9	1425	--	270.3
Detection Check (Y=Detection; N=No Detection)						Y

Trial Number			15			
Bursts in Trial			16			
Center Frequency (MHz)			5270			
Burst	Number of Pulses	Pulse Width (µsec)	Chirp Width (MHz)	Pulse 1-to-2 PRI (µsec)	Pulse 2-to-3 PRI (µsec)	Start Location Within Interval (msec)
1	3	97.9	16	1023	1938	381.483
2	3	70.6	16	1507	1652	143.51
3	3	79.6	16	1185	1158	742.51
4	2	57.2	16	1657	--	694.15
5	2	61.8	16	1683	--	337.15
6	1	66.3	16	--	--	683.08
7	1	82.8	16	--	--	472.18
8	3	93.4	16	1072	1130	445.02
9	2	89.6	16	1646	--	593.37
10	3	94.1	16	1786	1020	448.75
11	1	66.7	16	--	--	26.17
12	2	58.1	16	1687	--	734.86
13	2	72.2	16	1767	--	337.55
14	3	69.4	16	1373	1948	365.9
15	2	90.3	16	1006	--	82.7
16	2	78.6	16	1093	--	219.7
Detection Check (Y=Detection; N=No Detection)						Y

Trial Number			16			
Bursts in Trial			20			
Center Frequency (MHz)			5270			
Burst	Number of Pulses	Pulse Width (μsec)	Chirp Width (MHz)	Pulse 1-to-2 PRI (μsec)	Pulse 2-to-3 PRI (μsec)	Start Location Within Interval (msec)
1	3	86.8	13	1633	1688	157.83
2	2	85.7	13	1004	--	161.457
3	2	68.1	13	1361	--	539.54
4	2	70.2	13	1542	--	410.24
5	3	60.2	13	1702	1157	148.84
6	1	53.2	13	--	--	367.52
7	3	60.5	13	1463	1735	451.72
8	2	93.9	13	1676	--	576.92
9	3	65.7	13	1695	1344	391.29
10	2	62.9	13	1065	--	220.07
11	3	93.5	13	1923	1287	303.52
12	2	75.6	13	1938	--	287.4
13	2	64.2	13	1300	--	193.44
14	3	83.3	13	1347	1628	380.54
15	1	65.3	13	--	--	504.53
16	1	54.3	13	--	--	38.58
17	3	67.7	13	1394	1690	206.63
18	3	80.2	13	1533	1199	278.5
19	1	52.8	13	--	--	418.4
20	1	51.8	13	--	--	522
Detection Check (Y=Detection; N=No Detection)						Y

Trial Number			17			
Bursts in Trial			12			
Center Frequency (MHz)			5270			
Burst	Number of Pulses	Pulse Width (µsec)	Chirp Width (MHz)	Pulse 1-to-2 PRI (µsec)	Pulse 2-to-3 PRI (µsec)	Start Location Within Interval (msec)
1	2	75.1	7	1527	--	378.064
2	1	52	7	--	--	894.91
3	3	86.1	7	1038	1823	566.72
4	2	87.3	7	1203	--	633.91
5	1	76.6	7	--	--	748.36
6	2	52.1	7	1428	--	938.9
7	1	80.2	7	--	--	916.04
8	2	84.9	7	1434	--	220.9
9	3	66	7	1680	1545	735.64
10	3	98.9	7	1069	1516	489.68
11	2	88.8	7	1462	--	6.6
12	2	83.7	7	1680	--	832.6
Detection Check (Y=Detection; N=No Detection)						N

Trial Number			18			
Bursts in Trial			14			
Center Frequency (MHz)			5270			
Burst	Number of Pulses	Pulse Width (µsec)	Chirp Width (MHz)	Pulse 1-to-2 PRI (µsec)	Pulse 2-to-3 PRI (µsec)	Start Location Within Interval (msec)
1	3	79.3	10	1020	1017	192.931
2	1	62.2	10	--	--	96.667
3	3	83.7	10	1630	1335	273.514
4	2	53.7	10	1764	--	110.471
5	2	77.8	10	1592	--	263.819
6	2	60.9	10	1984	--	632.906
7	1	67.9	10	--	--	627.323
8	2	69.3	10	1449	--	368.52
9	2	64.3	10	1398	--	298.147
10	1	58.3	10	--	--	130.664
11	3	54	10	1917	1051	9.831
12	2	58.9	10	1493	--	454.209
13	2	75.9	10	1065	--	520.086
14	2	52.5	10	1808	--	280.443
Detection Check (Y=Detection; N=No Detection)						Y

Trial Number			19			
Bursts in Trial			18			
Center Frequency (MHz)			5270			
Burst	Number of Pulses	Pulse Width (µsec)	Chirp Width (MHz)	Pulse 1-to-2 PRI (µsec)	Pulse 2-to-3 PRI (µsec)	Start Location Within Interval (msec)
1	2	81.4	19	1665	--	379.976
2	2	98.8	19	1428	--	272.868
3	2	60.4	19	1371	--	570.017
4	2	97	19	1547	--	562.33
5	2	86.2	19	1951	--	145.103
6	3	79.4	19	1380	1824	78.747
7	3	88.9	19	1956	1288	310.78
8	2	65	19	1220	--	502.523
9	2	67.4	19	1831	--	239.657
10	3	57.6	19	1469	1682	12.3
11	1	51.4	19	--	--	612.783
12	1	65.1	19	--	--	70.597
13	2	58.8	19	1161	--	630.95
14	1	56.5	19	--	--	239.533
15	3	72.5	19	1697	1127	465.857
16	2	86	19	1139	--	25.3
17	3	82.8	19	1615	1859	279.433
18	3	63.2	19	1338	1480	607.867
Detection Check (Y=Detection; N=No Detection)						Y

Trial Number			20			
Bursts in Trial			16			
Center Frequency (MHz)			5270			
Burst	Number of Pulses	Pulse Width (µsec)	Chirp Width (MHz)	Pulse 1-to-2 PRI (µsec)	Pulse 2-to-3 PRI (µsec)	Start Location Within Interval (msec)
1	1	87.9	12	--	--	203.419
2	3	91.8	12	1177	1664	420.39
3	2	81.2	12	1861	--	263.57
4	3	69	12	1086	1723	420.04
5	3	71.3	12	1867	1451	255.33
6	2	66	12	1807	--	76.06
7	3	59.7	12	1364	1272	600.22
8	2	99.1	12	1254	--	491.16
9	3	76.3	12	1765	1703	475
10	2	74.7	12	1510	--	275.44
11	1	91.8	12	--	--	108
12	3	78	12	1049	1889	264.44

13	2	56.7	12	1249	--	224.56
14	2	78.3	12	1730	--	164.37
15	2	80.3	12	1064	--	105.5
16	2	95.9	12	1232	--	642.7
Detection Check (Y=Detection; N=No Detection)						Y

Trial Number			21			
Bursts in Trial			11			
Center Frequency (MHz)			5270			
Burst	Number of Pulses	Pulse Width (µsec)	Chirp Width (MHz)	Pulse 1-to-2 PRI (µsec)	Pulse 2-to-3 PRI (µsec)	Start Location Within Interval (msec)
1	2	78.3	14	1107	--	328.895
2	2	90.5	14	1373	--	193.381
3	2	52.1	14	1732	--	90.162
4	2	83.4	14	1217	--	576.633
5	2	99.9	14	1450	--	434.734
6	3	80.9	14	1048	1373	344.525
7	2	96.3	14	1883	--	6.815
8	1	58.1	14	--	--	927.796
9	1	71.2	14	--	--	210.757
10	1	66.5	14	--	--	480.218
11	3	94.5	14	1844	1097	523.709
Detection Check (Y=Detection; N=No Detection)						N

Trial Number			22			
Bursts in Trial			11			
Center Frequency (MHz)			5270			
Burst	Number of Pulses	Pulse Width (µsec)	Chirp Width (MHz)	Pulse 1-to-2 PRI (µsec)	Pulse 2-to-3 PRI (µsec)	Start Location Within Interval (msec)
1	1	82	9	--	--	172.917
2	1	59.3	9	--	--	608.461
3	2	89.6	9	1905	--	424.392
4	1	53.5	9	--	--	180.013
5	2	68.9	9	1503	--	348.334
6	2	97.5	9	1399	--	582.715
7	1	65.1	9	--	--	909.895
8	2	63.7	9	1299	--	873.616
9	2	57.5	9	1730	--	417.387
10	3	76.2	9	1237	1939	647.018
11	2	83.3	9	1928	--	781.609
Detection Check (Y=Detection; N=No Detection)						Y

Trial Number			23			
Bursts in Trial			15			
Center Frequency (MHz)			5270			
Burst	Number of Pulses	Pulse Width (µsec)	Chirp Width (MHz)	Pulse 1-to-2 PRI (µsec)	Pulse 2-to-3 PRI (µsec)	Start Location Within Interval (msec)
1	1	57.1	14	--	--	65.901
2	1	86.7	14	--	--	334.79
3	3	91.2	14	1464	1074	722.8
4	2	62.7	14	1790	--	317.33
5	3	80.8	14	1118	1285	129.98
6	2	84.3	14	1360	--	249.47
7	2	64.6	14	1038	--	25.27
8	2	79.1	14	1527	--	756.97
9	1	86.8	14	--	--	409.03
10	2	78.2	14	1256	--	668.58
11	3	50.4	14	1968	1182	306.55
12	2	55.9	14	1089	--	309.2
13	2	67.9	14	1084	--	236.1
14	3	85	14	1065	1119	168.6
15	2	78.1	14	1259	--	728.3
Detection Check (Y=Detection; N=No Detection)						Y

Trial Number			24			
Bursts in Trial			16			
Center Frequency (MHz)			5270			
Burst	Number of Pulses	Pulse Width (µsec)	Chirp Width (MHz)	Pulse 1-to-2 PRI (µsec)	Pulse 2-to-3 PRI (µsec)	Start Location Within Interval (msec)
1	2	64.7	6	1189	--	620.783
2	3	54.8	6	1622	1448	256.86
3	2	75.1	6	1284	--	23.87
4	1	71	6	--	--	303.19
5	3	88.2	6	1851	1581	385.32
6	1	75.6	6	--	--	597.77
7	2	75.6	6	1269	--	435.6
8	1	82.6	6	--	--	360.56
9	2	96.8	6	1761	--	77.78
10	2	58.1	6	1040	--	173.34
11	2	59.3	6	1366	--	737.85
12	3	98.3	6	1913	1459	603.56
13	3	80.2	6	1438	1558	374.67
14	3	78.3	6	1477	1776	335.3
15	3	82.7	6	1555	1484	146.8

16	3	56.2	6	1229	1598	79.4
Detection Check (Y=Detection; N=No Detection)						Y

Trial Number			25			
Bursts in Trial			16			
Center Frequency (MHz)			5270			
Burst	Number of Pulses	Pulse Width (μsec)	Chirp Width (MHz)	Pulse 1-to-2 PRI (μsec)	Pulse 2-to-3 PRI (μsec)	Start Location Within Interval (msec)
1	3	54.5	7	1015	1238	429.994
2	1	80.7	7	--	--	679.08
3	3	70	7	1156	1260	249.98
4	1	56.2	7	--	--	719.15
5	1	61.1	7	--	--	527.59
6	2	78.2	7	1561	--	92.59
7	3	88.1	7	1583	1525	437.61
8	2	57	7	1883	--	39.85
9	1	84	7	--	--	411.41
10	3	86	7	1306	1025	189.06
11	1	77.4	7	--	--	606.17
12	1	93.7	7	--	--	431.02
13	2	54.8	7	1904	--	159.91
14	2	74.2	7	1678	--	147.02
15	2	93.7	7	1653	--	56.4
16	2	86.6	7	1395	--	355.2
Detection Check (Y=Detection; N=No Detection)						Y

Trial Number			26			
Bursts in Trial			19			
Center Frequency (MHz)			5270			
Burst	Number of Pulses	Pulse Width (µsec)	Chirp Width (MHz)	Pulse 1-to-2 PRI (µsec)	Pulse 2-to-3 PRI (µsec)	Start Location Within Interval (msec)
1	1	64.4	18	--	--	308.658
2	2	90.1	18	1488	--	373.081
3	2	86.6	18	1562	--	547.442
4	2	98.4	18	1568	--	139.593
5	2	50.6	18	1465	--	463.894
6	3	66.6	18	1313	1964	83.195
7	2	69.7	18	1977	--	136.706
8	3	51	18	1127	1391	393.717
9	2	57.6	18	1806	--	0.548
10	2	94.8	18	1198	--	469.749
11	2	87	18	1561	--	301.451
12	2	92.4	18	1357	--	62.642
13	2	78.6	18	1422	--	573.103
14	2	85.5	18	1778	--	33.424
15	3	94.5	18	1220	1042	392.475
16	2	57	18	1894	--	168.156
17	3	70	18	1275	1186	160.537
18	2	92.5	18	1694	--	458.758
19	3	89.3	18	1325	1258	311.379
Detection Check (Y=Detection; N=No Detection)						Y

Trial Number			27			
Bursts in Trial			11			
Center Frequency (MHz)			5270			
Burst	Number of Pulses	Pulse Width (µsec)	Chirp Width (MHz)	Pulse 1-to-2 PRI (µsec)	Pulse 2-to-3 PRI (µsec)	Start Location Within Interval (msec)
1	3	64	16	1368	1167	476.207
2	2	62.1	16	1444	--	524.961
3	1	86.2	16	--	--	337.732
4	2	58.5	16	1064	--	8.483
5	3	89.1	16	1071	1544	985.664
6	2	71.8	16	1683	--	770.295
7	2	64.2	16	1878	--	33.785
8	1	85.4	16	--	--	440.826
9	2	91.8	16	1552	--	1052.437
10	2	77.3	16	1498	--	467.118
11	2	77.9	16	1991	--	436.609

Detection Check (Y=Detection; N=No Detection)	N
---	---

Trial Number			28			
Bursts in Trial			19			
Center Frequency (MHz)			5270			
Burst	Number of Pulses	Pulse Width (μsec)	Chirp Width (MHz)	Pulse 1-to-2 PRI (μsec)	Pulse 2-to-3 PRI (μsec)	Start Location Within Interval (msec)
1	3	76.4	17	1347	1144	51.36
2	3	52.4	17	1992	1827	562.281
3	3	85.4	17	1786	1251	43.492
4	2	54.2	17	1282	--	130.973
5	3	83.6	17	1299	1137	613.204
6	2	96.3	17	1921	--	136.395
7	2	92	17	1825	--	343.526
8	2	80.6	17	1159	--	428.897
9	1	67.8	17	--	--	398.418
10	2	58.3	17	1413	--	208.519
11	1	81.9	17	--	--	618.001
12	2	55.6	17	1845	--	299.562
13	2	52.5	17	1827	--	284.473
14	2	99.8	17	1290	--	560.544
15	2	56.5	17	1607	--	396.155
16	1	70.8	17	--	--	506.436
17	2	80	17	1582	--	560.837
18	2	50	17	1957	--	334.158
19	1	86.5	17	--	--	129.179
Detection Check (Y=Detection; N=No Detection)						Y

Trial Number			29			
Bursts in Trial			11			
Center Frequency (MHz)			5270			
Burst	Number of Pulses	Pulse Width (μsec)	Chirp Width (MHz)	Pulse 1-to-2 PRI (μsec)	Pulse 2-to-3 PRI (μsec)	Start Location Within Interval (msec)
1	3	72.5	16	1326	1085	418.338
2	3	53.2	16	1255	1936	774.251
3	2	80.8	16	1517	--	84.442
4	3	52.8	16	1186	1080	587.603
5	3	88.6	16	1232	1276	343.594
6	2	57.3	16	1273	--	151.485
7	2	76.7	16	1543	--	524.595
8	2	78.2	16	1355	--	1037.786
9	3	63.2	16	1638	1805	377.997
10	3	65.6	16	1036	1727	298.618
11	1	97.1	16	--	--	86.409
Detection Check (Y=Detection; N=No Detection)						Y

5270MHz, Radar 6

Trial Id	Radar Type	Pulse Width(μ s)	PRI (μ s)	Pulses Per Hop	Hopping Rate (kHz)	Hopping Sequence Length (ms)	Visible Frequency Number	conclusion
0	6	1.0	333.3	9	0.3333	300.00	33	Y
1	6	1.0	333.3	9	0.3333	300.00	29	Y
2	6	1.0	333.3	9	0.3333	300.00	28	Y
3	6	1.0	333.3	9	0.3333	300.00	35	Y
4	6	1.0	333.3	9	0.3333	300.00	35	Y
5	6	1.0	333.3	9	0.3333	300.00	31	Y
6	6	1.0	333.3	9	0.3333	300.00	33	Y
7	6	1.0	333.3	9	0.3333	300.00	29	Y
8	6	1.0	333.3	9	0.3333	300.00	33	Y
9	6	1.0	333.3	9	0.3333	300.00	32	Y
10	6	1.0	333.3	9	0.3333	300.00	36	Y
11	6	1.0	333.3	9	0.3333	300.00	40	Y
12	6	1.0	333.3	9	0.3333	300.00	37	Y
13	6	1.0	333.3	9	0.3333	300.00	34	Y
14	6	1.0	333.3	9	0.3333	300.00	31	Y
15	6	1.0	333.3	9	0.3333	300.00	39	Y
16	6	1.0	333.3	9	0.3333	300.00	35	Y
17	6	1.0	333.3	9	0.3333	300.00	36	Y
18	6	1.0	333.3	9	0.3333	300.00	29	Y
19	6	1.0	333.3	9	0.3333	300.00	32	Y
20	6	1.0	333.3	9	0.3333	300.00	35	Y
21	6	1.0	333.3	9	0.3333	300.00	38	Y
22	6	1.0	333.3	9	0.3333	300.00	40	Y
23	6	1.0	333.3	9	0.3333	300.00	37	Y
24	6	1.0	333.3	9	0.3333	300.00	31	Y
25	6	1.0	333.3	9	0.3333	300.00	33	Y
26	6	1.0	333.3	9	0.3333	300.00	29	Y
27	6	1.0	333.3	9	0.3333	300.00	35	Y
28	6	1.0	333.3	9	0.3333	300.00	32	Y
29	6	1.0	333.3	9	0.3333	300.00	37	Y

Detection rate: 100%

5290MHz, Radar 1

Trial Id	Radar Type	Pulse Width(μs)	PRI (μs)	Number of Pulses	Waveform Length (μs)	conclusion
0	1	1.0	938.0	57	53466.0	Y
1	1	1.0	698.0	76	53048.0	Y
2	1	1.0	618.0	86	53148.0	Y
3	1	1.0	538.0	99	53262.0	Y
4	1	1.0	878.0	61	53558.0	Y
5	1	1.0	3066.0	18	55188.0	Y
6	1	1.0	638.0	83	52954.0	Y
7	1	1.0	918.0	58	53244.0	Y
8	1	1.0	838.0	63	52794.0	Y
9	1	1.0	858.0	62	53196.0	Y
10	1	1.0	798.0	67	53466.0	Y
11	1	1.0	718.0	74	53132.0	Y
12	1	1.0	578.0	92	53176.0	Y
13	1	1.0	598.0	89	53222.0	Y
14	1	1.0	558.0	95	53010.0	Y
15	1	1.0	2536.0	21	53256.0	Y
16	1	1.0	966.0	55	53130.0	Y
17	1	1.0	827.0	64	52928.0	Y
18	1	1.0	2501.0	22	55022.0	Y
19	1	1.0	2595.0	21	54495.0	Y
20	1	1.0	1114.0	48	53472.0	Y
21	1	1.0	1302.0	41	53382.0	Y
22	1	1.0	3045.0	18	54810.0	Y
23	1	1.0	1624.0	33	53592.0	Y
24	1	1.0	2878.0	19	54682.0	Y
25	1	1.0	1027.0	52	53404.0	Y
26	1	1.0	2485.0	22	54670.0	Y
27	1	1.0	1600.0	33	52800.0	Y
28	1	1.0	1172.0	46	53912.0	Y
29	1	1.0	1177.0	45	52965.0	Y
Detection rate: 100%						

5290MHz, Radar 2

Trial Id	Radar Type	Pulse Width(μ s)	PRI (μ s)	Number of Pulses	Waveform Length (μ s)	conclusion
0	2	3.2	179.0	26	4654.0	Y
1	2	1.1	207.0	23	4761.0	Y
2	2	2.1	230.0	24	5520.0	Y
3	2	4.8	200.0	29	5800.0	Y
4	2	3.9	214.0	28	5992.0	Y
5	2	2.9	222.0	26	5772.0	Y
6	2	3.2	204.0	26	5304.0	Y
7	2	2.5	192.0	25	4800.0	Y
8	2	3.1	164.0	26	4264.0	Y
9	2	1.2	156.0	23	3588.0	Y
10	2	3.9	210.0	27	5670.0	Y
11	2	4.6	201.0	29	5829.0	Y
12	2	3.2	162.0	26	4212.0	Y
13	2	2.2	197.0	25	4925.0	Y
14	2	4.5	163.0	29	4727.0	Y
15	2	3.0	203.0	26	5278.0	Y
16	2	5.0	168.0	29	4872.0	Y
17	2	2.4	217.0	25	5425.0	Y
18	2	2.9	191.0	26	4966.0	Y
19	2	2.3	166.0	25	4150.0	Y
20	2	3.7	150.0	27	4050.0	Y
21	2	2.2	176.0	25	4400.0	Y
22	2	4.9	195.0	29	5655	Y
23	2	2.9	202.0	26	5252.0	Y
24	2	2.5	178.0	25	4450.0	Y
25	2	1.1	206.0	23	4738.0	Y
26	2	3.8	155.0	27	4185.0	Y
27	2	4.7	157.0	29	4553.0	Y
28	2	2.4	224.0	25	5600.0	Y
29	2	4.2	159.0	28	4452.0	Y
Detection rate: 100%						

5290MHz, Radar 3

Trial Id	Radar Type	Pulse Width(μ s)	PRI (μ s)	Number of Pulses	Waveform Length (μ s)	conclusion
0	3	8.2	355.0	17	6035.0	Y
1	3	6.1	487.0	16	7792.0	Y
2	3	7.1	344.0	16	5504.0	Y
3	3	9.8	288.0	18	5184.0	Y
4	3	8.9	230.0	18	4140.0	Y
5	3	7.9	432.0	17	7344.0	Y
6	3	8.2	207.0	17	3519.0	Y
7	3	7.5	443.0	17	7531.0	Y
8	3	8.1	439.0	17	7463.0	Y
9	3	6.2	223.0	16	3568.0	Y
10	3	8.9	208.0	18	3744.0	Y
11	3	9.6	463.0	18	8334.0	Y
12	3	8.2	441.0	17	7497.0	Y
13	3	7.2	323.0	16	5168.0	Y
14	3	9.5	297.0	18	5346.0	Y
15	3	8.0	412.0	17	7004.0	Y
16	3	10.0	324.0	18	5832.0	Y
17	3	7.4	271.0	17	4607.0	Y
18	3	7.9	349.0	17	5933.0	Y
19	3	7.3	409.0	16	6544.0	Y
20	3	8.7	373.0	18	6714.0	Y
21	3	7.2	254.0	16	4064.0	Y
22	3	9.9	274.0	18	4932.0	Y
23	3	7.9	278.0	17	4726.0	Y
24	3	7.5	317.0	17	5389.0	Y
25	3	6.1	260.0	16	4160.0	Y
26	3	8.8	211.0	18	3798.0	Y
27	3	9.7	272.0	18	4896.0	Y
28	3	7.4	264.0	17	4488.0	Y
29	3	9.2	284.0	18	5112.0	Y
Detection rate: 100%						

5290MHz, Radar 4

Trial Id	Radar Type	Pulse Width(μ s)	PRI (μ s)	Number of Pulses	Waveform Length (μ s)	conclusion
0	4	16.0	355.0	14	4970.0	Y
1	4	11.3	487.0	12	5844.0	Y
2	4	13.5	344.0	13	4472.0	Y
3	4	19.4	288.0	16	4608.0	Y
4	4	17.5	230.0	15	3450.0	Y
5	4	15.3	432.0	14	6048.0	Y
6	4	15.9	207.0	14	2898.0	Y
7	4	14.3	443.0	13	5759.0	Y
8	4	15.8	439.0	14	6146.0	Y
9	4	11.5	223.0	12	2676.0	Y
10	4	17.4	208.0	15	3120.0	Y
11	4	19.0	463.0	16	7408.0	Y
12	4	16.0	441.0	14	6174.0	Y
13	4	13.8	323.0	13	4199.0	Y
14	4	18.9	297.0	16	4752.0	Y
15	4	15.5	412.0	14	5768.0	Y
16	4	19.9	324.0	16	5184.0	Y
17	4	14.1	271.0	13	3523.0	Y
18	4	15.2	349.0	14	4886.0	Y
19	4	13.8	409.0	13	5317.0	Y
20	4	17.1	373.0	15	5595.0	Y
21	4	13.8	254.0	13	3302.0	Y
22	4	19.8	274.0	16	4384.0	Y
23	4	15.3	278.0	14	3892.0	Y
24	4	14.5	317.0	13	4121.0	Y
25	4	11.3	260.0	12	3120.0	Y
26	4	17.3	211.0	15	3165.0	Y
27	4	19.2	272.0	16	4352.0	Y
28	4	14.2	264.0	13	3432.0	Y
29	4	18.2	284.0	15	4260.0	Y
Detection rate: 100%						

5290MHz, Radar 5

Trial Id	Radar Type	Number of Pulses	Chirp Width (MHz)	Burst Period (s)	Waveform Length (μ s)	Center Frequency (MHz)	conclusion
0	5	15	13	0.8000000	12.0	5.290	Y
1	5	8	19	1.5000000	12.0	5.258	Y
2	5	11	11	1.0909091	12.0	5.261	Y
3	5	20	12	0.6000000	12.0	5.259	Y
4	5	17	6	0.7058824	12.0	5.262	Y
5	5	14	15	0.8571429	12.0	5.258	N
6	5	15	16	0.8000000	12.0	5.259	Y
7	5	12	17	1.0000000	12.0	5.258	Y
8	5	14	19	0.8571429	12.0	5.320	Y
9	5	8	12	1.5000000	12.0	5.322	Y
10	5	17	7	0.7058824	12.0	5.318	Y
11	5	19	11	0.6315789	12.0	5.321	Y
12	5	15	14	0.8000000	12.0	5.322	Y
13	5	12	16	1.0000000	12.0	5.324	Y
14	5	19	9	0.6315789	12.0	5.320	Y
15	5	14	16	0.8571429	12.0	5.318	Y
16	5	20	13	0.6000000	12.0	5.322	N
17	5	12	7	1.0000000	12.0	5.319	Y
18	5	14	10	0.8571429	12.0	5.290	Y
19	5	12	19	1.0000000	12.0	5.258	N
20	5	16	12	0.7500000	12.0	5.261	Y
21	5	12	14	1.0000000	12.0	5.259	Y
22	5	20	9	0.6000000	12.0	5.262	N
23	5	14	14	0.8571429	12.0	5.258	Y
24	5	13	6	0.9230769	12.0	5.259	Y
25	5	8	7	1.5000000	12.0	5.258	Y
26	5	17	18	0.7058824	12.0	5.320	N
27	5	19	16	0.6315789	12.0	5.322	Y
28	5	12	17	1.0000000	12.0	5.318	Y
29	5	18	16	0.6666667	12.0	5.321	Y

Detection rate: 83%

Trial Number			0			
Bursts in Trial			16			
Center Frequency (MHz)			5290			
Burst	Number of Pulses	Pulse Width (µsec)	Chirp Width (MHz)	Pulse 1-to-2 PRI (µsec)	Pulse 2-to-3 PRI (µsec)	Start Location Within Interval (msec)
1	1	71.5	13	--	--	382.157
2	1	73.2	13	--	--	537.38
3	1	95.5	13	--	--	301.44
4	2	88.4	13	1280	--	586.04
5	2	64.8	13	1624	--	322.44
6	1	77.3	13	--	--	33.47
7	2	64.3	13	1035	--	238.39
8	1	97.4	13	--	--	422.7
9	1	60.5	13	--	--	589.16
10	2	77.3	13	1797	--	269.82
11	1	60.3	13	--	--	14.29
12	1	99.3	13	--	--	734.54
13	2	65.1	13	1528	--	118.33
14	2	56.9	13	1137	--	496.3
15	1	86	13	--	--	208.7
16	1	83.5	13	--	--	545
Detection Check (Y=Detection; N=No Detection)						Y

Trial Number			1			
Bursts in Trial			12			
Center Frequency (MHz)			5290			
Burst	Number of Pulses	Pulse Width (µsec)	Chirp Width (MHz)	Pulse 1-to-2 PRI (µsec)	Pulse 2-to-3 PRI (µsec)	Start Location Within Interval (msec)
1	3	96.6	19	1441	1588	157.072
2	2	57	19	1003	--	31.84
3	1	99.4	19	--	--	593.46
4	3	51.4	19	1076	1207	174.33
5	3	71.5	19	1105	1860	53.87
6	2	99.5	19	1009	--	204.9
7	2	96.8	19	1888	--	972.89
8	2	62.8	19	1708	--	421.81
9	2	68.6	19	1979	--	675.92
10	1	52.2	19	--	--	905.33
11	2	71.2	19	1891	--	626.2
12	1	80.7	19	--	--	297.1
Detection Check (Y=Detection; N=No Detection)						Y

Trial Number			2			
Bursts in Trial			12			
Center Frequency (MHz)			5290			
Burst	Number of Pulses	Pulse Width (µsec)	Chirp Width (MHz)	Pulse 1-to-2 PRI (µsec)	Pulse 2-to-3 PRI (µsec)	Start Location Within Interval (msec)
1	2	73	11	1720	--	60.341
2	2	86.6	11	1086	--	471.34
3	2	52	11	1769	--	149.46
4	3	89.5	11	1050	1774	665.26
5	2	91.3	11	1275	--	763.12
6	1	87.6	11	--	--	242.46
7	2	95.7	11	1592	--	386.09
8	1	79.1	11	--	--	690.82
9	2	63	11	1026	--	448.47
10	3	78.5	11	1233	1434	781.34
11	2	71.4	11	1774	--	534
12	2	93.2	11	1268	--	689.3
Detection Check (Y=Detection; N=No Detection)						Y

Trial Number			3			
Bursts in Trial			15			
Center Frequency (MHz)			5290			
Burst	Number of Pulses	Pulse Width (µsec)	Chirp Width (MHz)	Pulse 1-to-2 PRI (µsec)	Pulse 2-to-3 PRI (µsec)	Start Location Within Interval (msec)
1	3	51.8	12	1987	1673	785.215
2	1	67.1	12	--	--	304.74
3	2	80.4	12	1189	--	234.53
4	2	57.2	12	1369	--	400.36
5	3	80.9	12	1841	1377	257.92
6	2	66.8	12	1850	--	641.28
7	2	78.3	12	1566	--	763.04
8	1	95.7	12	--	--	315.89
9	2	72.6	12	1987	--	694.91
10	2	86.1	12	1099	--	12.39
11	3	54.6	12	1547	1020	744.49
12	3	82.4	12	1778	1816	623.75
13	2	52.6	12	1943	--	704.1
14	3	88.8	12	1592	1140	155.2
15	2	91.6	12	1430	--	771.7
Detection Check (Y=Detection; N=No Detection)						Y

Trial Number			4			
Bursts in Trial			15			
Center Frequency (MHz)			5290			
Burst	Number of Pulses	Pulse Width (µsec)	Chirp Width (MHz)	Pulse 1-to-2 PRI (µsec)	Pulse 2-to-3 PRI (µsec)	Start Location Within Interval (msec)
1	2	91.5	6	1778	--	131.166
2	1	58.6	6	--	--	306.44
3	1	54.2	6	--	--	157.68
4	1	68.4	6	--	--	464.16
5	2	62.8	6	1467	--	725.57
6	1	90.9	6	--	--	277.06
7	1	93.9	6	--	--	278.94
8	2	67.7	6	1128	--	83.93
9	2	57.2	6	1328	--	324.65
10	2	77.5	6	1726	--	269.88
11	1	53.8	6	--	--	538.06
12	2	56.7	6	1884	--	731.59
13	3	50.7	6	1243	1550	206.21
14	2	86.2	6	1189	--	307.7
15	1	82.7	6	--	--	208.1
Detection Check (Y=Detection; N=No Detection)						Y

Trial Number			5			
Bursts in Trial			10			
Center Frequency (MHz)			5290			
Burst	Number of Pulses	Pulse Width (µsec)	Chirp Width (MHz)	Pulse 1-to-2 PRI (µsec)	Pulse 2-to-3 PRI (µsec)	Start Location Within Interval (msec)
1	1	90.1	15	--	--	1033.2
2	2	80.7	15	1532	--	510.9
3	1	99.6	15	--	--	454.39
4	1	50.8	15	--	--	577.37
5	1	60.7	15	--	--	101.54
6	3	90	15	1254	1217	724.3
7	2	89.1	15	1337	--	977.24
8	2	96.6	15	1506	--	497.64
9	1	76.3	15	--	--	19.63
10	1	55.9	15	--	--	793.8
Detection Check (Y=Detection; N=No Detection)						N

Trial Number			6			
Bursts in Trial			16			
Center Frequency (MHz)			5290			
Burst	Number of Pulses	Pulse Width (µsec)	Chirp Width (MHz)	Pulse 1-to-2 PRI (µsec)	Pulse 2-to-3 PRI (µsec)	Start Location Within Interval (msec)
1	3	57.1	16	1529	1704	329.074
2	2	89.7	16	1153	--	181.929
3	1	57	16	--	--	661.73
4	3	76.3	16	1421	1729	676.54
5	2	85	16	1471	--	195.28
6	2	51.1	16	1777	--	133.14
7	2	87.4	16	1935	--	235.39
8	1	76.9	16	--	--	689.87
9	2	53.7	16	1406	--	108.86
10	1	63.5	16	--	--	298.5
11	2	71.6	16	1480	--	455.93
12	1	54.9	16	--	--	458.73
13	1	54.9	16	--	--	655.32
14	1	74.4	16	--	--	342.5
15	3	57.1	16	1803	1961	253.6
16	2	60.1	16	1173	--	626.3
Detection Check (Y=Detection; N=No Detection)						Y

Trial Number			7			
Bursts in Trial			10			
Center Frequency (MHz)			5290			
Burst	Number of Pulses	Pulse Width (µsec)	Chirp Width (MHz)	Pulse 1-to-2 PRI (µsec)	Pulse 2-to-3 PRI (µsec)	Start Location Within Interval (msec)
1	1	73.5	17	--	--	1027.02
2	1	89.6	17	--	--	288.87
3	2	96.4	17	1502	--	940.16
4	1	55.4	17	--	--	538.88
5	3	77.4	17	1678	1866	313.88
6	3	94.7	17	1377	1225	810.56
7	3	87.8	17	1040	1623	571.58
8	3	69.1	17	1265	1703	573.24
9	2	93.1	17	1526	--	732
10	2	84.2	17	1218	--	1135.7
Detection Check (Y=Detection; N=No Detection)						Y

Trial Number			8			
Bursts in Trial			17			
Center Frequency (MHz)			5290			
Burst	Number of Pulses	Pulse Width (μsec)	Chirp Width (MHz)	Pulse 1-to-2 PRI (μsec)	Pulse 2-to-3 PRI (μsec)	Start Location Within Interval (msec)
1	1	99.9	19	--	--	379.224
2	3	66.9	19	1884	1117	141.215
3	3	93.9	19	1541	1081	385.095
4	1	68.1	19	--	--	381.083
5	3	64.4	19	1524	1742	555.971
6	1	55.5	19	--	--	305.368
7	2	75.7	19	1657	--	524.546
8	2	79.3	19	1445	--	300.074
9	2	92.5	19	1739	--	217.191
10	1	53.5	19	--	--	379.719
11	1	76	19	--	--	408.816
12	2	90.7	19	1974	--	321.334
13	3	50	19	1043	1917	429.582
14	3	55.9	19	1721	1782	269.669
15	3	62.5	19	1735	1532	392.247
16	2	97.3	19	1930	--	543.265
17	3	64	19	1406	1172	103.082
Detection Check (Y=Detection; N=No Detection)						Y

Trial Number			9			
Bursts in Trial			8			
Center Frequency (MHz)			5290			
Burst	Number of Pulses	Pulse Width (μsec)	Chirp Width (MHz)	Pulse 1-to-2 PRI (μsec)	Pulse 2-to-3 PRI (μsec)	Start Location Within Interval (msec)
1	1	72.5	12	--	--	509.857
2	1	82.2	12	--	--	164.27
3	2	95.6	12	1652	--	1336.41
4	3	97.5	12	1913	1669	1403.44
5	3	56.8	12	1289	1286	1431.47
6	1	59.1	12	--	--	847.09
7	2	79.4	12	1668	--	1007.5
8	1	57	12	--	--	1064.5
Detection Check (Y=Detection; N=No Detection)						Y

Trial Number			10			
Bursts in Trial			17			
Center Frequency (MHz)			5290			
Burst	Number of Pulses	Pulse Width (μsec)	Chirp Width (MHz)	Pulse 1-to-2 PRI (μsec)	Pulse 2-to-3 PRI (μsec)	Start Location Within Interval (msec)
1	1	78.3	7	--	--	66.832
2	2	84.7	7	1277	--	533.498
3	3	66.8	7	1498	1487	363.275
4	3	85.1	7	1385	1978	101.033
5	3	50.6	7	1597	1042	240.291
6	2	70.9	7	1963	--	359.558
7	2	52.6	7	1254	--	587.176
8	1	99.2	7	--	--	324.064
9	1	99.4	7	--	--	661.481
10	1	60.8	7	--	--	618.299
11	1	98.1	7	--	--	161.846
12	3	71.3	7	1514	1297	681.744
13	1	71.1	7	--	--	57.432
14	1	64.2	7	--	--	614.609
15	3	94.2	7	1515	1757	3.997
16	2	90.2	7	1007	--	409.465
17	2	94.5	7	1152	--	96.682
Detection Check (Y=Detection; N=No Detection)						Y

Trial Number			11			
Bursts in Trial			14			
Center Frequency (MHz)			5290			
Burst	Number of Pulses	Pulse Width (µsec)	Chirp Width (MHz)	Pulse 1-to-2 PRI (µsec)	Pulse 2-to-3 PRI (µsec)	Start Location Within Interval (msec)
1	1	56.2	11	--	--	837.948
2	3	97.4	11	1384	1150	805.177
3	1	82.6	11	--	--	108.874
4	2	81.2	11	1739	--	561.491
5	3	57.1	11	1500	1788	637.839
6	1	96.9	11	--	--	470.256
7	2	78.8	11	1644	--	186.843
8	2	55.2	11	1314	--	537.84
9	2	90.3	11	1517	--	210.307
10	2	86.8	11	1352	--	340.554
11	1	72	11	--	--	461.061
12	2	56.3	11	1749	--	109.089
13	2	77.1	11	1952	--	370.286
14	1	93.2	11	--	--	5.543
Detection Check (Y=Detection; N=No Detection)						Y

Trial Number			12			
Bursts in Trial			13			
Center Frequency (MHz)			5290			
Burst	Number of Pulses	Pulse Width (µsec)	Chirp Width (MHz)	Pulse 1-to-2 PRI (µsec)	Pulse 2-to-3 PRI (µsec)	Start Location Within Interval (msec)
1	3	95.8	14	1940	1066	135.166
2	2	96.9	14	1620	--	508.763
3	2	64.3	14	1609	--	877.786
4	3	97.1	14	1568	1125	354.559
5	2	69.8	14	1068	--	329.312
6	2	82	14	1940	--	103.175
7	2	97	14	1961	--	131.808
8	2	93.5	14	1084	--	199.242
9	3	59.3	14	1735	1223	244.985
10	2	54.1	14	1500	--	916.988
11	1	86.7	14	--	--	784.231
12	3	84.8	14	1763	1920	134.054
13	2	99.9	14	1595	--	885.077
Detection Check (Y=Detection; N=No Detection)						Y

Trial Number			13			
Bursts in Trial			12			
Center Frequency (MHz)			5290			
Burst	Number of Pulses	Pulse Width (µsec)	Chirp Width (MHz)	Pulse 1-to-2 PRI (µsec)	Pulse 2-to-3 PRI (µsec)	Start Location Within Interval (msec)
1	2	53	16	1035	--	758.419
2	2	94.5	16	1456	--	599.82
3	1	92.9	16	--	--	897.55
4	3	50.5	16	1461	1898	387.44
5	1	55.8	16	--	--	663.7
6	2	55.8	16	1153	--	876.84
7	1	96.8	16	--	--	258.85
8	2	57.6	16	1472	--	697.38
9	1	52.8	16	--	--	238.05
10	2	84.7	16	1477	--	269.11
11	2	92.9	16	1337	--	540.7
12	2	61.8	16	1878	--	662.5
Detection Check (Y=Detection; N=No Detection)						Y

Trial Number			14			
Bursts in Trial			12			
Center Frequency (MHz)			5290			
Burst	Number of Pulses	Pulse Width (µsec)	Chirp Width (MHz)	Pulse 1-to-2 PRI (µsec)	Pulse 2-to-3 PRI (µsec)	Start Location Within Interval (msec)
1	3	87.7	9	1289	1972	865.268
2	2	75.3	9	1086	--	643.12
3	3	61.7	9	1399	1818	607.79
4	1	84.4	9	--	--	423.86
5	2	80	9	1874	--	777.53
6	2	91.9	9	1107	--	742.23
7	3	80.6	9	1890	1876	467.68
8	1	52.4	9	--	--	420.12
9	1	65.8	9	--	--	764.91
10	1	88.1	9	--	--	921.18
11	2	97.7	9	1534	--	726
12	2	53.1	9	1425	--	270.3
Detection Check (Y=Detection; N=No Detection)						Y

Trial Number			15			
Bursts in Trial			16			
Center Frequency (MHz)			5290			
Burst	Number of Pulses	Pulse Width (μsec)	Chirp Width (MHz)	Pulse 1-to-2 PRI (μsec)	Pulse 2-to-3 PRI (μsec)	Start Location Within Interval (msec)
1	3	97.9	16	1023	1938	381.483
2	3	70.6	16	1507	1652	143.51
3	3	79.6	16	1185	1158	742.51
4	2	57.2	16	1657	--	694.15
5	2	61.8	16	1683	--	337.15
6	1	66.3	16	--	--	683.08
7	1	82.8	16	--	--	472.18
8	3	93.4	16	1072	1130	445.02
9	2	89.6	16	1646	--	593.37
10	3	94.1	16	1786	1020	448.75
11	1	66.7	16	--	--	26.17
12	2	58.1	16	1687	--	734.86
13	2	72.2	16	1767	--	337.55
14	3	69.4	16	1373	1948	365.9
15	2	90.3	16	1006	--	82.7
16	2	78.6	16	1093	--	219.7
Detection Check (Y=Detection; N=No Detection)						Y

Trial Number			16			
Bursts in Trial			20			
Center Frequency (MHz)			5290			
Burst	Number of Pulses	Pulse Width (μsec)	Chirp Width (MHz)	Pulse 1-to-2 PRI (μsec)	Pulse 2-to-3 PRI (μsec)	Start Location Within Interval (msec)
1	3	86.8	13	1633	1688	157.83
2	2	85.7	13	1004	--	161.457
3	2	68.1	13	1361	--	539.54
4	2	70.2	13	1542	--	410.24
5	3	60.2	13	1702	1157	148.84
6	1	53.2	13	--	--	367.52
7	3	60.5	13	1463	1735	451.72
8	2	93.9	13	1676	--	576.92
9	3	65.7	13	1695	1344	391.29
10	2	62.9	13	1065	--	220.07
11	3	93.5	13	1923	1287	303.52
12	2	75.6	13	1938	--	287.4
13	2	64.2	13	1300	--	193.44
14	3	83.3	13	1347	1628	380.54
15	1	65.3	13	--	--	504.53
16	1	54.3	13	--	--	38.58
17	3	67.7	13	1394	1690	206.63
18	3	80.2	13	1533	1199	278.5
19	1	52.8	13	--	--	418.4
20	1	51.8	13	--	--	522
Detection Check (Y=Detection; N=No Detection)						N

Trial Number			17			
Bursts in Trial			12			
Center Frequency (MHz)			5290			
Burst	Number of Pulses	Pulse Width (µsec)	Chirp Width (MHz)	Pulse 1-to-2 PRI (µsec)	Pulse 2-to-3 PRI (µsec)	Start Location Within Interval (msec)
1	2	75.1	7	1527	--	378.064
2	1	52	7	--	--	894.91
3	3	86.1	7	1038	1823	566.72
4	2	87.3	7	1203	--	633.91
5	1	76.6	7	--	--	748.36
6	2	52.1	7	1428	--	938.9
7	1	80.2	7	--	--	916.04
8	2	84.9	7	1434	--	220.9
9	3	66	7	1680	1545	735.64
10	3	98.9	7	1069	1516	489.68
11	2	88.8	7	1462	--	6.6
12	2	83.7	7	1680	--	832.6
Detection Check (Y=Detection; N=No Detection)						Y

Trial Number			18			
Bursts in Trial			14			
Center Frequency (MHz)			5290			
Burst	Number of Pulses	Pulse Width (µsec)	Chirp Width (MHz)	Pulse 1-to-2 PRI (µsec)	Pulse 2-to-3 PRI (µsec)	Start Location Within Interval (msec)
1	3	79.3	10	1020	1017	192.931
2	1	62.2	10	--	--	96.667
3	3	83.7	10	1630	1335	273.514
4	2	53.7	10	1764	--	110.471
5	2	77.8	10	1592	--	263.819
6	2	60.9	10	1984	--	632.906
7	1	67.9	10	--	--	627.323
8	2	69.3	10	1449	--	368.52
9	2	64.3	10	1398	--	298.147
10	1	58.3	10	--	--	130.664
11	3	54	10	1917	1051	9.831
12	2	58.9	10	1493	--	454.209
13	2	75.9	10	1065	--	520.086
14	2	52.5	10	1808	--	280.443
Detection Check (Y=Detection; N=No Detection)						Y

Trial Number			19			
Bursts in Trial			18			
Center Frequency (MHz)			5290			
Burst	Number of Pulses	Pulse Width (µsec)	Chirp Width (MHz)	Pulse 1-to-2 PRI (µsec)	Pulse 2-to-3 PRI (µsec)	Start Location Within Interval (msec)
1	2	81.4	19	1665	--	379.976
2	2	98.8	19	1428	--	272.868
3	2	60.4	19	1371	--	570.017
4	2	97	19	1547	--	562.33
5	2	86.2	19	1951	--	145.103
6	3	79.4	19	1380	1824	78.747
7	3	88.9	19	1956	1288	310.78
8	2	65	19	1220	--	502.523
9	2	67.4	19	1831	--	239.657
10	3	57.6	19	1469	1682	12.3
11	1	51.4	19	--	--	612.783
12	1	65.1	19	--	--	70.597
13	2	58.8	19	1161	--	630.95
14	1	56.5	19	--	--	239.533
15	3	72.5	19	1697	1127	465.857
16	2	86	19	1139	--	25.3
17	3	82.8	19	1615	1859	279.433
18	3	63.2	19	1338	1480	607.867
Detection Check (Y=Detection; N=No Detection)						N

Trial Number			20			
Bursts in Trial			16			
Center Frequency (MHz)			5290			
Burst	Number of Pulses	Pulse Width (µsec)	Chirp Width (MHz)	Pulse 1-to-2 PRI (µsec)	Pulse 2-to-3 PRI (µsec)	Start Location Within Interval (msec)
1	1	87.9	12	--	--	203.419
2	3	91.8	12	1177	1664	420.39
3	2	81.2	12	1861	--	263.57
4	3	69	12	1086	1723	420.04
5	3	71.3	12	1867	1451	255.33
6	2	66	12	1807	--	76.06
7	3	59.7	12	1364	1272	600.22
8	2	99.1	12	1254	--	491.16
9	3	76.3	12	1765	1703	475
10	2	74.7	12	1510	--	275.44
11	1	91.8	12	--	--	108
12	3	78	12	1049	1889	264.44

13	2	56.7	12	1249	--	224.56
14	2	78.3	12	1730	--	164.37
15	2	80.3	12	1064	--	105.5
16	2	95.9	12	1232	--	642.7
Detection Check (Y=Detection; N=No Detection)						Y

Trial Number			21			
Bursts in Trial			11			
Center Frequency (MHz)			5290			
Burst	Number of Pulses	Pulse Width (μsec)	Chirp Width (MHz)	Pulse 1-to-2 PRI (μsec)	Pulse 2-to-3 PRI (μsec)	Start Location Within Interval (msec)
1	2	78.3	14	1107	--	328.895
2	2	90.5	14	1373	--	193.381
3	2	52.1	14	1732	--	90.162
4	2	83.4	14	1217	--	576.633
5	2	99.9	14	1450	--	434.734
6	3	80.9	14	1048	1373	344.525
7	2	96.3	14	1883	--	6.815
8	1	58.1	14	--	--	927.796
9	1	71.2	14	--	--	210.757
10	1	66.5	14	--	--	480.218
11	3	94.5	14	1844	1097	523.709
Detection Check (Y=Detection; N=No Detection)						Y

Trial Number			22			
Bursts in Trial			11			
Center Frequency (MHz)			5290			
Burst	Number of Pulses	Pulse Width (μsec)	Chirp Width (MHz)	Pulse 1-to-2 PRI (μsec)	Pulse 2-to-3 PRI (μsec)	Start Location Within Interval (msec)
1	1	82	9	--	--	172.917
2	1	59.3	9	--	--	608.461
3	2	89.6	9	1905	--	424.392
4	1	53.5	9	--	--	180.013
5	2	68.9	9	1503	--	348.334
6	2	97.5	9	1399	--	582.715
7	1	65.1	9	--	--	909.895
8	2	63.7	9	1299	--	873.616
9	2	57.5	9	1730	--	417.387
10	3	76.2	9	1237	1939	647.018
11	2	83.3	9	1928	--	781.609
Detection Check (Y=Detection; N=No Detection)						N

Trial Number			23			
Bursts in Trial			15			
Center Frequency (MHz)			5290			
Burst	Number of Pulses	Pulse Width (µsec)	Chirp Width (MHz)	Pulse 1-to-2 PRI (µsec)	Pulse 2-to-3 PRI (µsec)	Start Location Within Interval (msec)
1	1	57.1	14	--	--	65.901
2	1	86.7	14	--	--	334.79
3	3	91.2	14	1464	1074	722.8
4	2	62.7	14	1790	--	317.33
5	3	80.8	14	1118	1285	129.98
6	2	84.3	14	1360	--	249.47
7	2	64.6	14	1038	--	25.27
8	2	79.1	14	1527	--	756.97
9	1	86.8	14	--	--	409.03
10	2	78.2	14	1256	--	668.58
11	3	50.4	14	1968	1182	306.55
12	2	55.9	14	1089	--	309.2
13	2	67.9	14	1084	--	236.1
14	3	85	14	1065	1119	168.6
15	2	78.1	14	1259	--	728.3
Detection Check (Y=Detection; N=No Detection)						Y

Trial Number			24			
Bursts in Trial			16			
Center Frequency (MHz)			5290			
Burst	Number of Pulses	Pulse Width (µsec)	Chirp Width (MHz)	Pulse 1-to-2 PRI (µsec)	Pulse 2-to-3 PRI (µsec)	Start Location Within Interval (msec)
1	2	64.7	6	1189	--	620.783
2	3	54.8	6	1622	1448	256.86
3	2	75.1	6	1284	--	23.87
4	1	71	6	--	--	303.19
5	3	88.2	6	1851	1581	385.32
6	1	75.6	6	--	--	597.77
7	2	75.6	6	1269	--	435.6
8	1	82.6	6	--	--	360.56
9	2	96.8	6	1761	--	77.78
10	2	58.1	6	1040	--	173.34
11	2	59.3	6	1366	--	737.85
12	3	98.3	6	1913	1459	603.56
13	3	80.2	6	1438	1558	374.67
14	3	78.3	6	1477	1776	335.3

15	3	82.7	6	1555	1484	146.8
16	3	56.2	6	1229	1598	79.4
Detection Check (Y=Detection; N=No Detection)						Y

Trial Number		25				
Bursts in Trial		16				
Center Frequency (MHz)		5290				
Burst	Number of Pulses	Pulse Width (µsec)	Chirp Width (MHz)	Pulse 1-to-2 PRI (µsec)	Pulse 2-to-3 PRI (µsec)	Start Location Within Interval (msec)
1	3	54.5	7	1015	1238	429.994
2	1	80.7	7	--	--	679.08
3	3	70	7	1156	1260	249.98
4	1	56.2	7	--	--	719.15
5	1	61.1	7	--	--	527.59
6	2	78.2	7	1561	--	92.59
7	3	88.1	7	1583	1525	437.61
8	2	57	7	1883	--	39.85
9	1	84	7	--	--	411.41
10	3	86	7	1306	1025	189.06
11	1	77.4	7	--	--	606.17
12	1	93.7	7	--	--	431.02
13	2	54.8	7	1904	--	159.91
14	2	74.2	7	1678	--	147.02
15	2	93.7	7	1653	--	56.4
16	2	86.6	7	1395	--	355.2
Detection Check (Y=Detection; N=No Detection)						Y

Trial Number			26			
Bursts in Trial			19			
Center Frequency (MHz)			5290			
Burst	Number of Pulses	Pulse Width (µsec)	Chirp Width (MHz)	Pulse 1-to-2 PRI (µsec)	Pulse 2-to-3 PRI (µsec)	Start Location Within Interval (msec)
1	1	64.4	18	--	--	308.658
2	2	90.1	18	1488	--	373.081
3	2	86.6	18	1562	--	547.442
4	2	98.4	18	1568	--	139.593
5	2	50.6	18	1465	--	463.894
6	3	66.6	18	1313	1964	83.195
7	2	69.7	18	1977	--	136.706
8	3	51	18	1127	1391	393.717
9	2	57.6	18	1806	--	0.548
10	2	94.8	18	1198	--	469.749
11	2	87	18	1561	--	301.451
12	2	92.4	18	1357	--	62.642
13	2	78.6	18	1422	--	573.103
14	2	85.5	18	1778	--	33.424
15	3	94.5	18	1220	1042	392.475
16	2	57	18	1894	--	168.156
17	3	70	18	1275	1186	160.537
18	2	92.5	18	1694	--	458.758
19	3	89.3	18	1325	1258	311.379
Detection Check (Y=Detection; N=No Detection)						N

Trial Number			27			
Bursts in Trial			11			
Center Frequency (MHz)			5290			
Burst	Number of Pulses	Pulse Width (µsec)	Chirp Width (MHz)	Pulse 1-to-2 PRI (µsec)	Pulse 2-to-3 PRI (µsec)	Start Location Within Interval (msec)
1	3	64	16	1368	1167	476.207
2	2	62.1	16	1444	--	524.961
3	1	86.2	16	--	--	337.732
4	2	58.5	16	1064	--	8.483
5	3	89.1	16	1071	1544	985.664
6	2	71.8	16	1683	--	770.295
7	2	64.2	16	1878	--	33.785
8	1	85.4	16	--	--	440.826
9	2	91.8	16	1552	--	1052.437
10	2	77.3	16	1498	--	467.118

11	2	77.9	16	1991	--	436.609
Detection Check (Y=Detection; N=No Detection)						Y

Trial Number			28			
Bursts in Trial			19			
Center Frequency (MHz)			5290			
Burst	Number of Pulses	Pulse Width (μsec)	Chirp Width (MHz)	Pulse 1-to-2 PRI (μsec)	Pulse 2-to-3 PRI (μsec)	Start Location Within Interval (msec)
1	3	76.4	17	1347	1144	51.36
2	3	52.4	17	1992	1827	562.281
3	3	85.4	17	1786	1251	43.492
4	2	54.2	17	1282	--	130.973
5	3	83.6	17	1299	1137	613.204
6	2	96.3	17	1921	--	136.395
7	2	92	17	1825	--	343.526
8	2	80.6	17	1159	--	428.897
9	1	67.8	17	--	--	398.418
10	2	58.3	17	1413	--	208.519
11	1	81.9	17	--	--	618.001
12	2	55.6	17	1845	--	299.562
13	2	52.5	17	1827	--	284.473
14	2	99.8	17	1290	--	560.544
15	2	56.5	17	1607	--	396.155
16	1	70.8	17	--	--	506.436
17	2	80	17	1582	--	560.837
18	2	50	17	1957	--	334.158
19	1	86.5	17	--	--	129.179
Detection Check (Y=Detection; N=No Detection)						Y

Trial Number			29			
Bursts in Trial			11			
Center Frequency (MHz)			5290			
Burst	Number of Pulses	Pulse Width (μsec)	Chirp Width (MHz)	Pulse 1-to-2 PRI (μsec)	Pulse 2-to-3 PRI (μsec)	Start Location Within Interval (msec)
1	3	72.5	16	1326	1085	418.338
2	3	53.2	16	1255	1936	774.251
3	2	80.8	16	1517	--	84.442
4	3	52.8	16	1186	1080	587.603
5	3	88.6	16	1232	1276	343.594
6	2	57.3	16	1273	--	151.485
7	2	76.7	16	1543	--	524.595
8	2	78.2	16	1355	--	1037.786
9	3	63.2	16	1638	1805	377.997
10	3	65.6	16	1036	1727	298.618
11	1	97.1	16	--	--	86.409
Detection Check (Y=Detection; N=No Detection)						Y

5290MHz, Radar 6

Trial Id	Radar Type	Pulse Width(μ s)	PRI (μ s)	Pulses Per Hop	Hopping Rate (kHz)	Hopping Sequence Length (ms)	Visible Frequency Number	conclusion
0	6	1.0	333.3	9	0.3333	300.00	33	Y
1	6	1.0	333.3	9	0.3333	300.00	29	Y
2	6	1.0	333.3	9	0.3333	300.00	28	Y
3	6	1.0	333.3	9	0.3333	300.00	35	Y
4	6	1.0	333.3	9	0.3333	300.00	35	Y
5	6	1.0	333.3	9	0.3333	300.00	31	Y
6	6	1.0	333.3	9	0.3333	300.00	33	Y
7	6	1.0	333.3	9	0.3333	300.00	29	Y
8	6	1.0	333.3	9	0.3333	300.00	33	Y
9	6	1.0	333.3	9	0.3333	300.00	32	Y
10	6	1.0	333.3	9	0.3333	300.00	36	Y
11	6	1.0	333.3	9	0.3333	300.00	40	Y
12	6	1.0	333.3	9	0.3333	300.00	37	Y
13	6	1.0	333.3	9	0.3333	300.00	34	Y
14	6	1.0	333.3	9	0.3333	300.00	31	Y
15	6	1.0	333.3	9	0.3333	300.00	39	Y
16	6	1.0	333.3	9	0.3333	300.00	35	Y
17	6	1.0	333.3	9	0.3333	300.00	36	Y
18	6	1.0	333.3	9	0.3333	300.00	29	Y
19	6	1.0	333.3	9	0.3333	300.00	32	Y
20	6	1.0	333.3	9	0.3333	300.00	35	Y
21	6	1.0	333.3	9	0.3333	300.00	38	Y
22	6	1.0	333.3	9	0.3333	300.00	40	Y
23	6	1.0	333.3	9	0.3333	300.00	37	Y
24	6	1.0	333.3	9	0.3333	300.00	31	Y
25	6	1.0	333.3	9	0.3333	300.00	33	Y
26	6	1.0	333.3	9	0.3333	300.00	29	Y
27	6	1.0	333.3	9	0.3333	300.00	35	Y
28	6	1.0	333.3	9	0.3333	300.00	32	Y
29	6	1.0	333.3	9	0.3333	300.00	37	Y
Detection rate: 100%								

5300MHz, Radar 1

Trial Id	Radar Type	Pulse Width(μs)	PRI (μs)	Number of Pulses	Waveform Length (μs)	conclusion
0	1	1.0	938.0	57	53466.0	Y
1	1	1.0	698.0	76	53048.0	Y
2	1	1.0	618.0	86	53148.0	Y
3	1	1.0	538.0	99	53262.0	Y
4	1	1.0	878.0	61	53558.0	Y
5	1	1.0	3066.0	18	55188.0	Y
6	1	1.0	638.0	83	52954.0	Y
7	1	1.0	918.0	58	53244.0	Y
8	1	1.0	838.0	63	52794.0	Y
9	1	1.0	858.0	62	53196.0	Y
10	1	1.0	798.0	67	53466.0	Y
11	1	1.0	718.0	74	53132.0	Y
12	1	1.0	578.0	92	53176.0	Y
13	1	1.0	598.0	89	53222.0	Y
14	1	1.0	558.0	95	53010.0	Y
15	1	1.0	2536.0	21	53256.0	Y
16	1	1.0	966.0	55	53130.0	Y
17	1	1.0	827.0	64	52928.0	Y
18	1	1.0	2501.0	22	55022.0	Y
19	1	1.0	2595.0	21	54495.0	Y
20	1	1.0	1114.0	48	53472.0	Y
21	1	1.0	1302.0	41	53382.0	Y
22	1	1.0	3045.0	18	54810.0	Y
23	1	1.0	1624.0	33	53592.0	Y
24	1	1.0	2878.0	19	54682.0	Y
25	1	1.0	1027.0	52	53404.0	Y
26	1	1.0	2485.0	22	54670.0	Y
27	1	1.0	1600.0	33	52800.0	Y
28	1	1.0	1172.0	46	53912.0	Y
29	1	1.0	1177.0	45	52965.0	Y
Detection rate: 100%						

5300MHz, Radar 2

Trial Id	Radar Type	Pulse Width(μ s)	PRI (μ s)	Number of Pulses	Waveform Length (μ s)	conclusion
0	2	3.2	179.0	26	4654.0	Y
1	2	1.1	207.0	23	4761.0	Y
2	2	2.1	230.0	24	5520.0	Y
3	2	4.8	200.0	29	5800.0	Y
4	2	3.9	214.0	28	5992.0	Y
5	2	2.9	222.0	26	5772.0	Y
6	2	3.2	204.0	26	5304.0	Y
7	2	2.5	192.0	25	4800.0	Y
8	2	3.1	164.0	26	4264.0	Y
9	2	1.2	156.0	23	3588.0	Y
10	2	3.9	210.0	27	5670.0	Y
11	2	4.6	201.0	29	5829.0	Y
12	2	3.2	162.0	26	4212.0	Y
13	2	2.2	197.0	25	4925.0	Y
14	2	4.5	163.0	29	4727.0	Y
15	2	3.0	203.0	26	5278.0	Y
16	2	5.0	168.0	29	4872.0	Y
17	2	2.4	217.0	25	5425.0	Y
18	2	2.9	191.0	26	4966.0	Y
19	2	2.3	166.0	25	4150.0	Y
20	2	3.7	150.0	27	4050.0	Y
21	2	2.2	176.0	25	4400.0	Y
22	2	4.9	195.0	29	5655	Y
23	2	2.9	202.0	26	5252.0	Y
24	2	2.5	178.0	25	4450.0	Y
25	2	1.1	206.0	23	4738.0	Y
26	2	3.8	155.0	27	4185.0	Y
27	2	4.7	157.0	29	4553.0	Y
28	2	2.4	224.0	25	5600.0	Y
29	2	4.2	159.0	28	4452.0	Y
Detection rate: 100%						

5300MHz, Radar 3

Trial Id	Radar Type	Pulse Width(μs)	PRI (μs)	Number of Pulses	Waveform Length (μs)	conclusion
0	3	8.2	355.0	17	6035.0	Y
1	3	6.1	487.0	16	7792.0	Y
2	3	7.1	344.0	16	5504.0	Y
3	3	9.8	288.0	18	5184.0	Y
4	3	8.9	230.0	18	4140.0	Y
5	3	7.9	432.0	17	7344.0	Y
6	3	8.2	207.0	17	3519.0	Y
7	3	7.5	443.0	17	7531.0	Y
8	3	8.1	439.0	17	7463.0	Y
9	3	6.2	223.0	16	3568.0	Y
10	3	8.9	208.0	18	3744.0	Y
11	3	9.6	463.0	18	8334.0	Y
12	3	8.2	441.0	17	7497.0	Y
13	3	7.2	323.0	16	5168.0	Y
14	3	9.5	297.0	18	5346.0	Y
15	3	8.0	412.0	17	7004.0	Y
16	3	10.0	324.0	18	5832.0	Y
17	3	7.4	271.0	17	4607.0	Y
18	3	7.9	349.0	17	5933.0	Y
19	3	7.3	409.0	16	6544.0	Y
20	3	8.7	373.0	18	6714.0	Y
21	3	7.2	254.0	16	4064.0	Y
22	3	9.9	274.0	18	4932.0	Y
23	3	7.9	278.0	17	4726.0	Y
24	3	7.5	317.0	17	5389.0	Y
25	3	6.1	260.0	16	4160.0	Y
26	3	8.8	211.0	18	3798.0	Y
27	3	9.7	272.0	18	4896.0	Y
28	3	7.4	264.0	17	4488.0	Y
29	3	9.2	284.0	18	5112.0	Y
Detection rate: 100%						

5300MHz, Radar 4

Trial Id	Radar Type	Pulse Width(μ s)	PRI (μ s)	Number of Pulses	Waveform Length (μ s)	conclusion
0	4	16.0	355.0	14	4970.0	Y
1	4	11.3	487.0	12	5844.0	Y
2	4	13.5	344.0	13	4472.0	Y
3	4	19.4	288.0	16	4608.0	Y
4	4	17.5	230.0	15	3450.0	Y
5	4	15.3	432.0	14	6048.0	Y
6	4	15.9	207.0	14	2898.0	Y
7	4	14.3	443.0	13	5759.0	Y
8	4	15.8	439.0	14	6146.0	Y
9	4	11.5	223.0	12	2676.0	Y
10	4	17.4	208.0	15	3120.0	Y
11	4	19.0	463.0	16	7408.0	Y
12	4	16.0	441.0	14	6174.0	Y
13	4	13.8	323.0	13	4199.0	Y
14	4	18.9	297.0	16	4752.0	Y
15	4	15.5	412.0	14	5768.0	Y
16	4	19.9	324.0	16	5184.0	Y
17	4	14.1	271.0	13	3523.0	Y
18	4	15.2	349.0	14	4886.0	Y
19	4	13.8	409.0	13	5317.0	Y
20	4	17.1	373.0	15	5595.0	Y
21	4	13.8	254.0	13	3302.0	Y
22	4	19.8	274.0	16	4384.0	Y
23	4	15.3	278.0	14	3892.0	Y
24	4	14.5	317.0	13	4121.0	Y
25	4	11.3	260.0	12	3120.0	Y
26	4	17.3	211.0	15	3165.0	Y
27	4	19.2	272.0	16	4352.0	Y
28	4	14.2	264.0	13	3432.0	Y
29	4	18.2	284.0	15	4260.0	Y
Detection rate: 100%						

5300MHz, Radar 5

Trial Id	Radar Type	Number of Pulses	Chirp Width (MHz)	Burst Period (s)	Waveform Length (μs)	Center Frequency (MHz)	conclusion
0	5	15	13	0.8000000	12.0	5.3000	Y
1	5	8	19	1.5000000	12.0	5.3000	Y
2	5	11	11	1.0909091	12.0	5.3000	Y
3	5	20	12	0.6000000	12.0	5.3000	Y
4	5	17	6	0.7058824	12.0	5.3000	Y
5	5	14	15	0.8571429	12.0	5.3000	Y
6	5	15	16	0.8000000	12.0	5.3000	Y
7	5	12	17	1.0000000	12.0	5.3000	Y
8	5	14	19	0.8571429	12.0	5.3000	Y
9	5	8	12	1.5000000	12.0	5.3000	Y
10	5	17	7	0.7058824	12.0	5.2964	Y
11	5	19	11	0.6315789	12.0	5.2976	Y
12	5	15	14	0.8000000	12.0	5.2952	N
13	5	12	16	1.0000000	12.0	5.2940	Y
14	5	19	9	0.6315789	12.0	5.2972	Y
15	5	14	16	0.8571429	12.0	5.2948	Y
16	5	20	13	0.6000000	12.0	5.2980	N
17	5	12	7	1.0000000	12.0	5.2940	Y
18	5	14	10	0.8571429	12.0	5.2948	Y
19	5	12	19	1.0000000	12.0	5.2940	Y
20	5	16	12	0.7500000	12.0	5.3040	Y
21	5	12	14	1.0000000	12.0	5.3064	N
22	5	20	9	0.6000000	12.0	5.3020	Y
23	5	14	14	0.8571429	12.0	5.3052	Y
24	5	13	6	0.9230769	12.0	5.3056	Y
25	5	8	7	1.5000000	12.0	5.3080	Y
26	5	17	18	0.7058824	12.0	5.3036	N
27	5	19	16	0.6315789	12.0	5.3024	Y
28	5	12	17	1.0000000	12.0	5.3060	Y
29	5	18	16	0.6666667	12.0	5.3032	Y

Detection rate: 86%

Trial Number			0			
Bursts in Trial			16			
Center Frequency (MHz)			5300			
Burst	Number of Pulses	Pulse Width (µsec)	Chirp Width (MHz)	Pulse 1-to-2 PRI (µsec)	Pulse 2-to-3 PRI (µsec)	Start Location Within Interval (msec)
1	1	71.5	13	--	--	382.157
2	1	73.2	13	--	--	537.38
3	1	95.5	13	--	--	301.44
4	2	88.4	13	1280	--	586.04
5	2	64.8	13	1624	--	322.44
6	1	77.3	13	--	--	33.47
7	2	64.3	13	1035	--	238.39
8	1	97.4	13	--	--	422.7
9	1	60.5	13	--	--	589.16
10	2	77.3	13	1797	--	269.82
11	1	60.3	13	--	--	14.29
12	1	99.3	13	--	--	734.54
13	2	65.1	13	1528	--	118.33
14	2	56.9	13	1137	--	496.3
15	1	86	13	--	--	208.7
16	1	83.5	13	--	--	545
Detection Check (Y=Detection; N=No Detection)						Y

Trial Number			1			
Bursts in Trial			12			
Center Frequency (MHz)			5300			
Burst	Number of Pulses	Pulse Width (µsec)	Chirp Width (MHz)	Pulse 1-to-2 PRI (µsec)	Pulse 2-to-3 PRI (µsec)	Start Location Within Interval (msec)
1	3	96.6	19	1441	1588	157.072
2	2	57	19	1003	--	31.84
3	1	99.4	19	--	--	593.46
4	3	51.4	19	1076	1207	174.33
5	3	71.5	19	1105	1860	53.87
6	2	99.5	19	1009	--	204.9
7	2	96.8	19	1888	--	972.89
8	2	62.8	19	1708	--	421.81
9	2	68.6	19	1979	--	675.92
10	1	52.2	19	--	--	905.33
11	2	71.2	19	1891	--	626.2
12	1	80.7	19	--	--	297.1
Detection Check (Y=Detection; N=No Detection)						Y

Trial Number			2			
Bursts in Trial			12			
Center Frequency (MHz)			5300			
Burst	Number of Pulses	Pulse Width (µsec)	Chirp Width (MHz)	Pulse 1-to-2 PRI (µsec)	Pulse 2-to-3 PRI (µsec)	Start Location Within Interval (msec)
1	2	73	11	1720	--	60.341
2	2	86.6	11	1086	--	471.34
3	2	52	11	1769	--	149.46
4	3	89.5	11	1050	1774	665.26
5	2	91.3	11	1275	--	763.12
6	1	87.6	11	--	--	242.46
7	2	95.7	11	1592	--	386.09
8	1	79.1	11	--	--	690.82
9	2	63	11	1026	--	448.47
10	3	78.5	11	1233	1434	781.34
11	2	71.4	11	1774	--	534
12	2	93.2	11	1268	--	689.3
Detection Check (Y=Detection; N=No Detection)						Y

Trial Number			3			
Bursts in Trial			15			
Center Frequency (MHz)			5300			
Burst	Number of Pulses	Pulse Width (µsec)	Chirp Width (MHz)	Pulse 1-to-2 PRI (µsec)	Pulse 2-to-3 PRI (µsec)	Start Location Within Interval (msec)
1	3	51.8	12	1987	1673	785.215
2	1	67.1	12	--	--	304.74
3	2	80.4	12	1189	--	234.53
4	2	57.2	12	1369	--	400.36
5	3	80.9	12	1841	1377	257.92
6	2	66.8	12	1850	--	641.28
7	2	78.3	12	1566	--	763.04
8	1	95.7	12	--	--	315.89
9	2	72.6	12	1987	--	694.91
10	2	86.1	12	1099	--	12.39
11	3	54.6	12	1547	1020	744.49
12	3	82.4	12	1778	1816	623.75
13	2	52.6	12	1943	--	704.1
14	3	88.8	12	1592	1140	155.2
15	2	91.6	12	1430	--	771.7
Detection Check (Y=Detection; N=No Detection)						Y

Trial Number			4			
Bursts in Trial			15			
Center Frequency (MHz)			5300			
Burst	Number of Pulses	Pulse Width (μsec)	Chirp Width (MHz)	Pulse 1-to-2 PRI (μsec)	Pulse 2-to-3 PRI (μsec)	Start Location Within Interval (msec)
1	2	91.5	6	1778	--	131.166
2	1	58.6	6	--	--	306.44
3	1	54.2	6	--	--	157.68
4	1	68.4	6	--	--	464.16
5	2	62.8	6	1467	--	725.57
6	1	90.9	6	--	--	277.06
7	1	93.9	6	--	--	278.94
8	2	67.7	6	1128	--	83.93
9	2	57.2	6	1328	--	324.65
10	2	77.5	6	1726	--	269.88
11	1	53.8	6	--	--	538.06
12	2	56.7	6	1884	--	731.59
13	3	50.7	6	1243	1550	206.21
14	2	86.2	6	1189	--	307.7
15	1	82.7	6	--	--	208.1
Detection Check (Y=Detection; N=No Detection)						Y

Trial Number			5			
Bursts in Trial			10			
Center Frequency (MHz)			5300			
Burst	Number of Pulses	Pulse Width (μsec)	Chirp Width (MHz)	Pulse 1-to-2 PRI (μsec)	Pulse 2-to-3 PRI (μsec)	Start Location Within Interval (msec)
1	1	90.1	15	--	--	1033.2
2	2	80.7	15	1532	--	510.9
3	1	99.6	15	--	--	454.39
4	1	50.8	15	--	--	577.37
5	1	60.7	15	--	--	101.54
6	3	90	15	1254	1217	724.3
7	2	89.1	15	1337	--	977.24
8	2	96.6	15	1506	--	497.64
9	1	76.3	15	--	--	19.63
10	1	55.9	15	--	--	793.8
Detection Check (Y=Detection; N=No Detection)						Y

Trial Number			6			
Bursts in Trial			16			
Center Frequency (MHz)			5300			
Burst	Number of Pulses	Pulse Width (µsec)	Chirp Width (MHz)	Pulse 1-to-2 PRI (µsec)	Pulse 2-to-3 PRI (µsec)	Start Location Within Interval (msec)
1	3	57.1	16	1529	1704	329.074
2	2	89.7	16	1153	--	181.929
3	1	57	16	--	--	661.73
4	3	76.3	16	1421	1729	676.54
5	2	85	16	1471	--	195.28
6	2	51.1	16	1777	--	133.14
7	2	87.4	16	1935	--	235.39
8	1	76.9	16	--	--	689.87
9	2	53.7	16	1406	--	108.86
10	1	63.5	16	--	--	298.5
11	2	71.6	16	1480	--	455.93
12	1	54.9	16	--	--	458.73
13	1	54.9	16	--	--	655.32
14	1	74.4	16	--	--	342.5
15	3	57.1	16	1803	1961	253.6
16	2	60.1	16	1173	--	626.3
Detection Check (Y=Detection; N=No Detection)						Y

Trial Number			7			
Bursts in Trial			10			
Center Frequency (MHz)			5300			
Burst	Number of Pulses	Pulse Width (µsec)	Chirp Width (MHz)	Pulse 1-to-2 PRI (µsec)	Pulse 2-to-3 PRI (µsec)	Start Location Within Interval (msec)
1	1	73.5	17	--	--	1027.02
2	1	89.6	17	--	--	288.87
3	2	96.4	17	1502	--	940.16
4	1	55.4	17	--	--	538.88
5	3	77.4	17	1678	1866	313.88
6	3	94.7	17	1377	1225	810.56
7	3	87.8	17	1040	1623	571.58
8	3	69.1	17	1265	1703	573.24
9	2	93.1	17	1526	--	732
10	2	84.2	17	1218	--	1135.7
Detection Check (Y=Detection; N=No Detection)						Y

Trial Number			8			
Bursts in Trial			17			
Center Frequency (MHz)			5300			
Burst	Number of Pulses	Pulse Width (μsec)	Chirp Width (MHz)	Pulse 1-to-2 PRI (μsec)	Pulse 2-to-3 PRI (μsec)	Start Location Within Interval (msec)
1	1	99.9	19	--	--	379.224
2	3	66.9	19	1884	1117	141.215
3	3	93.9	19	1541	1081	385.095
4	1	68.1	19	--	--	381.083
5	3	64.4	19	1524	1742	555.971
6	1	55.5	19	--	--	305.368
7	2	75.7	19	1657	--	524.546
8	2	79.3	19	1445	--	300.074
9	2	92.5	19	1739	--	217.191
10	1	53.5	19	--	--	379.719
11	1	76	19	--	--	408.816
12	2	90.7	19	1974	--	321.334
13	3	50	19	1043	1917	429.582
14	3	55.9	19	1721	1782	269.669
15	3	62.5	19	1735	1532	392.247
16	2	97.3	19	1930	--	543.265
17	3	64	19	1406	1172	103.082
Detection Check (Y=Detection; N=No Detection)						Y

Trial Number			9			
Bursts in Trial			8			
Center Frequency (MHz)			5300			
Burst	Number of Pulses	Pulse Width (μsec)	Chirp Width (MHz)	Pulse 1-to-2 PRI (μsec)	Pulse 2-to-3 PRI (μsec)	Start Location Within Interval (msec)
1	1	72.5	12	--	--	509.857
2	1	82.2	12	--	--	164.27
3	2	95.6	12	1652	--	1336.41
4	3	97.5	12	1913	1669	1403.44
5	3	56.8	12	1289	1286	1431.47
6	1	59.1	12	--	--	847.09
7	2	79.4	12	1668	--	1007.5
8	1	57	12	--	--	1064.5
Detection Check (Y=Detection; N=No Detection)						Y

Trial Number			10			
Bursts in Trial			17			
Center Frequency (MHz)			5300			
Burst	Number of Pulses	Pulse Width (μsec)	Chirp Width (MHz)	Pulse 1-to-2 PRI (μsec)	Pulse 2-to-3 PRI (μsec)	Start Location Within Interval (msec)
1	1	78.3	7	--	--	66.832
2	2	84.7	7	1277	--	533.498
3	3	66.8	7	1498	1487	363.275
4	3	85.1	7	1385	1978	101.033
5	3	50.6	7	1597	1042	240.291
6	2	70.9	7	1963	--	359.558
7	2	52.6	7	1254	--	587.176
8	1	99.2	7	--	--	324.064
9	1	99.4	7	--	--	661.481
10	1	60.8	7	--	--	618.299
11	1	98.1	7	--	--	161.846
12	3	71.3	7	1514	1297	681.744
13	1	71.1	7	--	--	57.432
14	1	64.2	7	--	--	614.609
15	3	94.2	7	1515	1757	3.997
16	2	90.2	7	1007	--	409.465
17	2	94.5	7	1152	--	96.682
Detection Check (Y=Detection; N=No Detection)						Y

Trial Number			11			
Bursts in Trial			14			
Center Frequency (MHz)			5300			
Burst	Number of Pulses	Pulse Width (µsec)	Chirp Width (MHz)	Pulse 1-to-2 PRI (µsec)	Pulse 2-to-3 PRI (µsec)	Start Location Within Interval (msec)
1	1	56.2	11	--	--	837.948
2	3	97.4	11	1384	1150	805.177
3	1	82.6	11	--	--	108.874
4	2	81.2	11	1739	--	561.491
5	3	57.1	11	1500	1788	637.839
6	1	96.9	11	--	--	470.256
7	2	78.8	11	1644	--	186.843
8	2	55.2	11	1314	--	537.84
9	2	90.3	11	1517	--	210.307
10	2	86.8	11	1352	--	340.554
11	1	72	11	--	--	461.061
12	2	56.3	11	1749	--	109.089
13	2	77.1	11	1952	--	370.286
14	1	93.2	11	--	--	5.543
Detection Check (Y=Detection; N=No Detection)						Y

Trial Number			12			
Bursts in Trial			13			
Center Frequency (MHz)			5300			
Burst	Number of Pulses	Pulse Width (µsec)	Chirp Width (MHz)	Pulse 1-to-2 PRI (µsec)	Pulse 2-to-3 PRI (µsec)	Start Location Within Interval (msec)
1	3	95.8	14	1940	1066	135.166
2	2	96.9	14	1620	--	508.763
3	2	64.3	14	1609	--	877.786
4	3	97.1	14	1568	1125	354.559
5	2	69.8	14	1068	--	329.312
6	2	82	14	1940	--	103.175
7	2	97	14	1961	--	131.808
8	2	93.5	14	1084	--	199.242
9	3	59.3	14	1735	1223	244.985
10	2	54.1	14	1500	--	916.988
11	1	86.7	14	--	--	784.231
12	3	84.8	14	1763	1920	134.054
13	2	99.9	14	1595	--	885.077
Detection Check (Y=Detection; N=No Detection)						N

Trial Number			13			
Bursts in Trial			12			
Center Frequency (MHz)			5300			
Burst	Number of Pulses	Pulse Width (µsec)	Chirp Width (MHz)	Pulse 1-to-2 PRI (µsec)	Pulse 2-to-3 PRI (µsec)	Start Location Within Interval (msec)
1	2	53	16	1035	--	758.419
2	2	94.5	16	1456	--	599.82
3	1	92.9	16	--	--	897.55
4	3	50.5	16	1461	1898	387.44
5	1	55.8	16	--	--	663.7
6	2	55.8	16	1153	--	876.84
7	1	96.8	16	--	--	258.85
8	2	57.6	16	1472	--	697.38
9	1	52.8	16	--	--	238.05
10	2	84.7	16	1477	--	269.11
11	2	92.9	16	1337	--	540.7
12	2	61.8	16	1878	--	662.5
Detection Check (Y=Detection; N=No Detection)						Y

Trial Number			14			
Bursts in Trial			12			
Center Frequency (MHz)			5300			
Burst	Number of Pulses	Pulse Width (µsec)	Chirp Width (MHz)	Pulse 1-to-2 PRI (µsec)	Pulse 2-to-3 PRI (µsec)	Start Location Within Interval (msec)
1	3	87.7	9	1289	1972	865.268
2	2	75.3	9	1086	--	643.12
3	3	61.7	9	1399	1818	607.79
4	1	84.4	9	--	--	423.86
5	2	80	9	1874	--	777.53
6	2	91.9	9	1107	--	742.23
7	3	80.6	9	1890	1876	467.68
8	1	52.4	9	--	--	420.12
9	1	65.8	9	--	--	764.91
10	1	88.1	9	--	--	921.18
11	2	97.7	9	1534	--	726
12	2	53.1	9	1425	--	270.3
Detection Check (Y=Detection; N=No Detection)						Y

Trial Number			15			
Bursts in Trial			16			
Center Frequency (MHz)			5300			
Burst	Number of Pulses	Pulse Width (μsec)	Chirp Width (MHz)	Pulse 1-to-2 PRI (μsec)	Pulse 2-to-3 PRI (μsec)	Start Location Within Interval (msec)
1	3	97.9	16	1023	1938	381.483
2	3	70.6	16	1507	1652	143.51
3	3	79.6	16	1185	1158	742.51
4	2	57.2	16	1657	--	694.15
5	2	61.8	16	1683	--	337.15
6	1	66.3	16	--	--	683.08
7	1	82.8	16	--	--	472.18
8	3	93.4	16	1072	1130	445.02
9	2	89.6	16	1646	--	593.37
10	3	94.1	16	1786	1020	448.75
11	1	66.7	16	--	--	26.17
12	2	58.1	16	1687	--	734.86
13	2	72.2	16	1767	--	337.55
14	3	69.4	16	1373	1948	365.9
15	2	90.3	16	1006	--	82.7
16	2	78.6	16	1093	--	219.7
Detection Check (Y=Detection; N=No Detection)						Y

Trial Number			16			
Bursts in Trial			20			
Center Frequency (MHz)			5300			
Burst	Number of Pulses	Pulse Width (µsec)	Chirp Width (MHz)	Pulse 1-to-2 PRI (µsec)	Pulse 2-to-3 PRI (µsec)	Start Location Within Interval (msec)
1	3	86.8	13	1633	1688	157.83
2	2	85.7	13	1004	--	161.457
3	2	68.1	13	1361	--	539.54
4	2	70.2	13	1542	--	410.24
5	3	60.2	13	1702	1157	148.84
6	1	53.2	13	--	--	367.52
7	3	60.5	13	1463	1735	451.72
8	2	93.9	13	1676	--	576.92
9	3	65.7	13	1695	1344	391.29
10	2	62.9	13	1065	--	220.07
11	3	93.5	13	1923	1287	303.52
12	2	75.6	13	1938	--	287.4
13	2	64.2	13	1300	--	193.44
14	3	83.3	13	1347	1628	380.54
15	1	65.3	13	--	--	504.53
16	1	54.3	13	--	--	38.58
17	3	67.7	13	1394	1690	206.63
18	3	80.2	13	1533	1199	278.5
19	1	52.8	13	--	--	418.4
20	1	51.8	13	--	--	522
Detection Check (Y=Detection; N=No Detection)						N

Trial Number			17			
Bursts in Trial			12			
Center Frequency (MHz)			5300			
Burst	Number of Pulses	Pulse Width (µsec)	Chirp Width (MHz)	Pulse 1-to-2 PRI (µsec)	Pulse 2-to-3 PRI (µsec)	Start Location Within Interval (msec)
1	2	75.1	7	1527	--	378.064
2	1	52	7	--	--	894.91
3	3	86.1	7	1038	1823	566.72
4	2	87.3	7	1203	--	633.91
5	1	76.6	7	--	--	748.36
6	2	52.1	7	1428	--	938.9
7	1	80.2	7	--	--	916.04
8	2	84.9	7	1434	--	220.9
9	3	66	7	1680	1545	735.64
10	3	98.9	7	1069	1516	489.68
11	2	88.8	7	1462	--	6.6
12	2	83.7	7	1680	--	832.6
Detection Check (Y=Detection; N=No Detection)						Y

Trial Number			18			
Bursts in Trial			14			
Center Frequency (MHz)			5300			
Burst	Number of Pulses	Pulse Width (µsec)	Chirp Width (MHz)	Pulse 1-to-2 PRI (µsec)	Pulse 2-to-3 PRI (µsec)	Start Location Within Interval (msec)
1	3	79.3	10	1020	1017	192.931
2	1	62.2	10	--	--	96.667
3	3	83.7	10	1630	1335	273.514
4	2	53.7	10	1764	--	110.471
5	2	77.8	10	1592	--	263.819
6	2	60.9	10	1984	--	632.906
7	1	67.9	10	--	--	627.323
8	2	69.3	10	1449	--	368.52
9	2	64.3	10	1398	--	298.147
10	1	58.3	10	--	--	130.664
11	3	54	10	1917	1051	9.831
12	2	58.9	10	1493	--	454.209
13	2	75.9	10	1065	--	520.086
14	2	52.5	10	1808	--	280.443
Detection Check (Y=Detection; N=No Detection)						Y

Trial Number		19				
Bursts in Trial		18				
Center Frequency (MHz)		5300				
Burst	Number of Pulses	Pulse Width (µsec)	Chirp Width (MHz)	Pulse 1-to-2 PRI (µsec)	Pulse 2-to-3 PRI (µsec)	Start Location Within Interval (msec)
1	2	81.4	19	1665	--	379.976
2	2	98.8	19	1428	--	272.868
3	2	60.4	19	1371	--	570.017
4	2	97	19	1547	--	562.33
5	2	86.2	19	1951	--	145.103
6	3	79.4	19	1380	1824	78.747
7	3	88.9	19	1956	1288	310.78
8	2	65	19	1220	--	502.523
9	2	67.4	19	1831	--	239.657
10	3	57.6	19	1469	1682	12.3
11	1	51.4	19	--	--	612.783
12	1	65.1	19	--	--	70.597
13	2	58.8	19	1161	--	630.95
14	1	56.5	19	--	--	239.533
15	3	72.5	19	1697	1127	465.857
16	2	86	19	1139	--	25.3
17	3	82.8	19	1615	1859	279.433
18	3	63.2	19	1338	1480	607.867
Detection Check (Y=Detection; N=No Detection)						Y

Trial Number		20				
Bursts in Trial		16				
Center Frequency (MHz)		5300				
Burst	Number of Pulses	Pulse Width (µsec)	Chirp Width (MHz)	Pulse 1-to-2 PRI (µsec)	Pulse 2-to-3 PRI (µsec)	Start Location Within Interval (msec)
1	1	87.9	12	--	--	203.419
2	3	91.8	12	1177	1664	420.39
3	2	81.2	12	1861	--	263.57
4	3	69	12	1086	1723	420.04
5	3	71.3	12	1867	1451	255.33
6	2	66	12	1807	--	76.06
7	3	59.7	12	1364	1272	600.22
8	2	99.1	12	1254	--	491.16
9	3	76.3	12	1765	1703	475
10	2	74.7	12	1510	--	275.44
11	1	91.8	12	--	--	108
12	3	78	12	1049	1889	264.44

13	2	56.7	12	1249	--	224.56
14	2	78.3	12	1730	--	164.37
15	2	80.3	12	1064	--	105.5
16	2	95.9	12	1232	--	642.7
Detection Check (Y=Detection; N=No Detection)						Y

Trial Number			21			
Bursts in Trial			11			
Center Frequency (MHz)			5300			
Burst	Number of Pulses	Pulse Width (µsec)	Chirp Width (MHz)	Pulse 1-to-2 PRI (µsec)	Pulse 2-to-3 PRI (µsec)	Start Location Within Interval (msec)
1	2	78.3	14	1107	--	328.895
2	2	90.5	14	1373	--	193.381
3	2	52.1	14	1732	--	90.162
4	2	83.4	14	1217	--	576.633
5	2	99.9	14	1450	--	434.734
6	3	80.9	14	1048	1373	344.525
7	2	96.3	14	1883	--	6.815
8	1	58.1	14	--	--	927.796
9	1	71.2	14	--	--	210.757
10	1	66.5	14	--	--	480.218
11	3	94.5	14	1844	1097	523.709
Detection Check (Y=Detection; N=No Detection)						N

Trial Number			22			
Bursts in Trial			11			
Center Frequency (MHz)			5300			
Burst	Number of Pulses	Pulse Width (µsec)	Chirp Width (MHz)	Pulse 1-to-2 PRI (µsec)	Pulse 2-to-3 PRI (µsec)	Start Location Within Interval (msec)
1	1	82	9	--	--	172.917
2	1	59.3	9	--	--	608.461
3	2	89.6	9	1905	--	424.392
4	1	53.5	9	--	--	180.013
5	2	68.9	9	1503	--	348.334
6	2	97.5	9	1399	--	582.715
7	1	65.1	9	--	--	909.895
8	2	63.7	9	1299	--	873.616
9	2	57.5	9	1730	--	417.387
10	3	76.2	9	1237	1939	647.018
11	2	83.3	9	1928	--	781.609
Detection Check (Y=Detection; N=No Detection)						Y

Trial Number			23			
Bursts in Trial			15			
Center Frequency (MHz)			5300			
Burst	Number of Pulses	Pulse Width (µsec)	Chirp Width (MHz)	Pulse 1-to-2 PRI (µsec)	Pulse 2-to-3 PRI (µsec)	Start Location Within Interval (msec)
1	1	57.1	14	--	--	65.901
2	1	86.7	14	--	--	334.79
3	3	91.2	14	1464	1074	722.8
4	2	62.7	14	1790	--	317.33
5	3	80.8	14	1118	1285	129.98
6	2	84.3	14	1360	--	249.47
7	2	64.6	14	1038	--	25.27
8	2	79.1	14	1527	--	756.97
9	1	86.8	14	--	--	409.03
10	2	78.2	14	1256	--	668.58
11	3	50.4	14	1968	1182	306.55
12	2	55.9	14	1089	--	309.2
13	2	67.9	14	1084	--	236.1
14	3	85	14	1065	1119	168.6
15	2	78.1	14	1259	--	728.3
Detection Check (Y=Detection; N=No Detection)						Y

Trial Number			24			
Bursts in Trial			16			
Center Frequency (MHz)			5300			
Burst	Number of Pulses	Pulse Width (µsec)	Chirp Width (MHz)	Pulse 1-to-2 PRI (µsec)	Pulse 2-to-3 PRI (µsec)	Start Location Within Interval (msec)
1	2	64.7	6	1189	--	620.783
2	3	54.8	6	1622	1448	256.86
3	2	75.1	6	1284	--	23.87
4	1	71	6	--	--	303.19
5	3	88.2	6	1851	1581	385.32
6	1	75.6	6	--	--	597.77
7	2	75.6	6	1269	--	435.6
8	1	82.6	6	--	--	360.56
9	2	96.8	6	1761	--	77.78
10	2	58.1	6	1040	--	173.34
11	2	59.3	6	1366	--	737.85
12	3	98.3	6	1913	1459	603.56
13	3	80.2	6	1438	1558	374.67
14	3	78.3	6	1477	1776	335.3

15	3	82.7	6	1555	1484	146.8
16	3	56.2	6	1229	1598	79.4
Detection Check (Y=Detection; N=No Detection)						Y

Trial Number		25				
Bursts in Trial		16				
Center Frequency (MHz)		5300				
Burst	Number of Pulses	Pulse Width (µsec)	Chirp Width (MHz)	Pulse 1-to-2 PRI (µsec)	Pulse 2-to-3 PRI (µsec)	Start Location Within Interval (msec)
1	3	54.5	7	1015	1238	429.994
2	1	80.7	7	--	--	679.08
3	3	70	7	1156	1260	249.98
4	1	56.2	7	--	--	719.15
5	1	61.1	7	--	--	527.59
6	2	78.2	7	1561	--	92.59
7	3	88.1	7	1583	1525	437.61
8	2	57	7	1883	--	39.85
9	1	84	7	--	--	411.41
10	3	86	7	1306	1025	189.06
11	1	77.4	7	--	--	606.17
12	1	93.7	7	--	--	431.02
13	2	54.8	7	1904	--	159.91
14	2	74.2	7	1678	--	147.02
15	2	93.7	7	1653	--	56.4
16	2	86.6	7	1395	--	355.2
Detection Check (Y=Detection; N=No Detection)						Y

Trial Number			26			
Bursts in Trial			19			
Center Frequency (MHz)			5300			
Burst	Number of Pulses	Pulse Width (µsec)	Chirp Width (MHz)	Pulse 1-to-2 PRI (µsec)	Pulse 2-to-3 PRI (µsec)	Start Location Within Interval (msec)
1	1	64.4	18	--	--	308.658
2	2	90.1	18	1488	--	373.081
3	2	86.6	18	1562	--	547.442
4	2	98.4	18	1568	--	139.593
5	2	50.6	18	1465	--	463.894
6	3	66.6	18	1313	1964	83.195
7	2	69.7	18	1977	--	136.706
8	3	51	18	1127	1391	393.717
9	2	57.6	18	1806	--	0.548
10	2	94.8	18	1198	--	469.749
11	2	87	18	1561	--	301.451
12	2	92.4	18	1357	--	62.642
13	2	78.6	18	1422	--	573.103
14	2	85.5	18	1778	--	33.424
15	3	94.5	18	1220	1042	392.475
16	2	57	18	1894	--	168.156
17	3	70	18	1275	1186	160.537
18	2	92.5	18	1694	--	458.758
19	3	89.3	18	1325	1258	311.379
Detection Check (Y=Detection; N=No Detection)						N

Trial Number			27			
Bursts in Trial			11			
Center Frequency (MHz)			5300			
Burst	Number of Pulses	Pulse Width (µsec)	Chirp Width (MHz)	Pulse 1-to-2 PRI (µsec)	Pulse 2-to-3 PRI (µsec)	Start Location Within Interval (msec)
1	3	64	16	1368	1167	476.207
2	2	62.1	16	1444	--	524.961
3	1	86.2	16	--	--	337.732
4	2	58.5	16	1064	--	8.483
5	3	89.1	16	1071	1544	985.664
6	2	71.8	16	1683	--	770.295
7	2	64.2	16	1878	--	33.785
8	1	85.4	16	--	--	440.826
9	2	91.8	16	1552	--	1052.437
10	2	77.3	16	1498	--	467.118

11	2	77.9	16	1991	--	436.609
Detection Check (Y=Detection; N=No Detection)						Y

Trial Number			28			
Bursts in Trial			19			
Center Frequency (MHz)			5300			
Burst	Number of Pulses	Pulse Width (μsec)	Chirp Width (MHz)	Pulse 1-to-2 PRI (μsec)	Pulse 2-to-3 PRI (μsec)	Start Location Within Interval (msec)
1	3	76.4	17	1347	1144	51.36
2	3	52.4	17	1992	1827	562.281
3	3	85.4	17	1786	1251	43.492
4	2	54.2	17	1282	--	130.973
5	3	83.6	17	1299	1137	613.204
6	2	96.3	17	1921	--	136.395
7	2	92	17	1825	--	343.526
8	2	80.6	17	1159	--	428.897
9	1	67.8	17	--	--	398.418
10	2	58.3	17	1413	--	208.519
11	1	81.9	17	--	--	618.001
12	2	55.6	17	1845	--	299.562
13	2	52.5	17	1827	--	284.473
14	2	99.8	17	1290	--	560.544
15	2	56.5	17	1607	--	396.155
16	1	70.8	17	--	--	506.436
17	2	80	17	1582	--	560.837
18	2	50	17	1957	--	334.158
19	1	86.5	17	--	--	129.179
Detection Check (Y=Detection; N=No Detection)						Y

Trial Number			29			
Bursts in Trial			11			
Center Frequency (MHz)			5300			
Burst	Number of Pulses	Pulse Width (μsec)	Chirp Width (MHz)	Pulse 1-to-2 PRI (μsec)	Pulse 2-to-3 PRI (μsec)	Start Location Within Interval (msec)
1	3	72.5	16	1326	1085	418.338
2	3	53.2	16	1255	1936	774.251
3	2	80.8	16	1517	--	84.442
4	3	52.8	16	1186	1080	587.603
5	3	88.6	16	1232	1276	343.594
6	2	57.3	16	1273	--	151.485
7	2	76.7	16	1543	--	524.595
8	2	78.2	16	1355	--	1037.786
9	3	63.2	16	1638	1805	377.997
10	3	65.6	16	1036	1727	298.618
11	1	97.1	16	--	--	86.409
Detection Check (Y=Detection; N=No Detection)						Y

5300MHz, Radar 6

Trial Id	Radar Type	Pulse Width(μ s)	PRI (μ s)	Pulses Per Hop	Hopping Rate (kHz)	Hopping Sequence Length (ms)	Visible Frequency Number	conclusion
0	6	1.0	333.3	9	0.3333	300.00	33	Y
1	6	1.0	333.3	9	0.3333	300.00	29	Y
2	6	1.0	333.3	9	0.3333	300.00	28	Y
3	6	1.0	333.3	9	0.3333	300.00	35	Y
4	6	1.0	333.3	9	0.3333	300.00	35	Y
5	6	1.0	333.3	9	0.3333	300.00	31	Y
6	6	1.0	333.3	9	0.3333	300.00	33	Y
7	6	1.0	333.3	9	0.3333	300.00	29	Y
8	6	1.0	333.3	9	0.3333	300.00	33	Y
9	6	1.0	333.3	9	0.3333	300.00	32	Y
10	6	1.0	333.3	9	0.3333	300.00	36	Y
11	6	1.0	333.3	9	0.3333	300.00	40	Y
12	6	1.0	333.3	9	0.3333	300.00	37	Y
13	6	1.0	333.3	9	0.3333	300.00	34	Y
14	6	1.0	333.3	9	0.3333	300.00	31	Y
15	6	1.0	333.3	9	0.3333	300.00	39	Y
16	6	1.0	333.3	9	0.3333	300.00	35	Y
17	6	1.0	333.3	9	0.3333	300.00	36	Y
18	6	1.0	333.3	9	0.3333	300.00	29	Y
19	6	1.0	333.3	9	0.3333	300.00	32	Y
20	6	1.0	333.3	9	0.3333	300.00	35	Y
21	6	1.0	333.3	9	0.3333	300.00	38	Y
22	6	1.0	333.3	9	0.3333	300.00	40	Y
23	6	1.0	333.3	9	0.3333	300.00	37	Y
24	6	1.0	333.3	9	0.3333	300.00	31	Y
25	6	1.0	333.3	9	0.3333	300.00	33	Y
26	6	1.0	333.3	9	0.3333	300.00	29	Y
27	6	1.0	333.3	9	0.3333	300.00	35	Y
28	6	1.0	333.3	9	0.3333	300.00	32	Y
29	6	1.0	333.3	9	0.3333	300.00	37	Y

Detection rate: 100%

5500MHz, Radar 1

Trial Id	Radar Type	Pulse Width(μ s)	PRI (μ s)	Number of Pulses	Waveform Length (μ s)	conclusion
0	1	1.0	938.0	57	53466.0	Y
1	1	1.0	698.0	76	53048.0	Y
2	1	1.0	618.0	86	53148.0	Y
3	1	1.0	538.0	99	53262.0	Y
4	1	1.0	878.0	61	53558.0	Y
5	1	1.0	3066.0	18	55188.0	Y
6	1	1.0	638.0	83	52954.0	Y
7	1	1.0	918.0	58	53244.0	Y
8	1	1.0	838.0	63	52794.0	Y
9	1	1.0	858.0	62	53196.0	Y
10	1	1.0	798.0	67	53466.0	Y
11	1	1.0	718.0	74	53132.0	Y
12	1	1.0	578.0	92	53176.0	Y
13	1	1.0	598.0	89	53222.0	Y
14	1	1.0	558.0	95	53010.0	Y
15	1	1.0	2536.0	21	53256.0	Y
16	1	1.0	966.0	55	53130.0	Y
17	1	1.0	827.0	64	52928.0	Y
18	1	1.0	2501.0	22	55022.0	Y
19	1	1.0	2595.0	21	54495.0	Y
20	1	1.0	1114.0	48	53472.0	Y
21	1	1.0	1302.0	41	53382.0	Y
22	1	1.0	3045.0	18	54810.0	Y
23	1	1.0	1624.0	33	53592.0	Y
24	1	1.0	2878.0	19	54682.0	Y
25	1	1.0	1027.0	52	53404.0	Y
26	1	1.0	2485.0	22	54670.0	Y
27	1	1.0	1600.0	33	52800.0	Y
28	1	1.0	1172.0	46	53912.0	Y
29	1	1.0	1177.0	45	52965.0	Y
Detection rate: 100%						

5500MHz, Radar 2

Trial Id	Radar Type	Pulse Width(μ s)	PRI (μ s)	Number of Pulses	Waveform Length (μ s)	conclusion
0	2	3.2	179.0	26	4654.0	Y
1	2	1.1	207.0	23	4761.0	Y
2	2	2.1	230.0	24	5520.0	Y
3	2	4.8	200.0	29	5800.0	Y
4	2	3.9	214.0	28	5992.0	Y
5	2	2.9	222.0	26	5772.0	Y
6	2	3.2	204.0	26	5304.0	Y
7	2	2.5	192.0	25	4800.0	Y
8	2	3.1	164.0	26	4264.0	Y
9	2	1.2	156.0	23	3588.0	Y
10	2	3.9	210.0	27	5670.0	Y
11	2	4.6	201.0	29	5829.0	Y
12	2	3.2	162.0	26	4212.0	Y
13	2	2.2	197.0	25	4925.0	Y
14	2	4.5	163.0	29	4727.0	Y
15	2	3.0	203.0	26	5278.0	Y
16	2	5.0	168.0	29	4872.0	Y
17	2	2.4	217.0	25	5425.0	Y
18	2	2.9	191.0	26	4966.0	Y
19	2	2.3	166.0	25	4150.0	Y
20	2	3.7	150.0	27	4050.0	Y
21	2	2.2	176.0	25	4400.0	Y
22	2	4.9	195.0	29	5655	Y
23	2	2.9	202.0	26	5252.0	Y
24	2	2.5	178.0	25	4450.0	Y
25	2	1.1	206.0	23	4738.0	Y
26	2	3.8	155.0	27	4185.0	Y
27	2	4.7	157.0	29	4553.0	Y
28	2	2.4	224.0	25	5600.0	Y
29	2	4.2	159.0	28	4452.0	Y
Detection rate: 100%						

5500MHz, Radar 3

Trial Id	Radar Type	Pulse Width(μ s)	PRI (μ s)	Number of Pulses	Waveform Length (μ s)	conclusion
0	3	8.2	355.0	17	6035.0	Y
1	3	6.1	487.0	16	7792.0	Y
2	3	7.1	344.0	16	5504.0	Y
3	3	9.8	288.0	18	5184.0	Y
4	3	8.9	230.0	18	4140.0	Y
5	3	7.9	432.0	17	7344.0	Y
6	3	8.2	207.0	17	3519.0	Y
7	3	7.5	443.0	17	7531.0	Y
8	3	8.1	439.0	17	7463.0	Y
9	3	6.2	223.0	16	3568.0	Y
10	3	8.9	208.0	18	3744.0	Y
11	3	9.6	463.0	18	8334.0	Y
12	3	8.2	441.0	17	7497.0	Y
13	3	7.2	323.0	16	5168.0	Y
14	3	9.5	297.0	18	5346.0	Y
15	3	8.0	412.0	17	7004.0	Y
16	3	10.0	324.0	18	5832.0	Y
17	3	7.4	271.0	17	4607.0	Y
18	3	7.9	349.0	17	5933.0	Y
19	3	7.3	409.0	16	6544.0	Y
20	3	8.7	373.0	18	6714.0	Y
21	3	7.2	254.0	16	4064.0	Y
22	3	9.9	274.0	18	4932.0	Y
23	3	7.9	278.0	17	4726.0	Y
24	3	7.5	317.0	17	5389.0	Y
25	3	6.1	260.0	16	4160.0	Y
26	3	8.8	211.0	18	3798.0	Y
27	3	9.7	272.0	18	4896.0	Y
28	3	7.4	264.0	17	4488.0	Y
29	3	9.2	284.0	18	5112.0	Y
Detection rate: 100%						

5500MHz, Radar 4

Trial Id	Radar Type	Pulse Width(μ s)	PRI (μ s)	Number of Pulses	Waveform Length (μ s)	conclusion
0	4	16.0	355.0	14	4970.0	Y
1	4	11.3	487.0	12	5844.0	Y
2	4	13.5	344.0	13	4472.0	Y
3	4	19.4	288.0	16	4608.0	Y
4	4	17.5	230.0	15	3450.0	Y
5	4	15.3	432.0	14	6048.0	Y
6	4	15.9	207.0	14	2898.0	Y
7	4	14.3	443.0	13	5759.0	Y
8	4	15.8	439.0	14	6146.0	Y
9	4	11.5	223.0	12	2676.0	Y
10	4	17.4	208.0	15	3120.0	Y
11	4	19.0	463.0	16	7408.0	Y
12	4	16.0	441.0	14	6174.0	Y
13	4	13.8	323.0	13	4199.0	Y
14	4	18.9	297.0	16	4752.0	Y
15	4	15.5	412.0	14	5768.0	Y
16	4	19.9	324.0	16	5184.0	Y
17	4	14.1	271.0	13	3523.0	Y
18	4	15.2	349.0	14	4886.0	Y
19	4	13.8	409.0	13	5317.0	Y
20	4	17.1	373.0	15	5595.0	Y
21	4	13.8	254.0	13	3302.0	Y
22	4	19.8	274.0	16	4384.0	Y
23	4	15.3	278.0	14	3892.0	Y
24	4	14.5	317.0	13	4121.0	Y
25	4	11.3	260.0	12	3120.0	Y
26	4	17.3	211.0	15	3165.0	Y
27	4	19.2	272.0	16	4352.0	Y
28	4	14.2	264.0	13	3432.0	Y
29	4	18.2	284.0	15	4260.0	Y
Detection rate: 100%						

5500MHz, Radar 5

Trial Id	Radar Type	Number of Pulses	Chirp Width (MHz)	Burst Period (s)	Waveform Length (μ s)	Center Frequency (MHz)	conclusion
0	5	15	13	0.8000000	12.0	5.5000	Y
1	5	8	19	1.5000000	12.0	5.5000	Y
2	5	11	11	1.0909091	12.0	5.5000	Y
3	5	20	12	0.6000000	12.0	5.5000	Y
4	5	17	6	0.7058824	12.0	5.5000	Y
5	5	14	15	0.8571429	12.0	5.5000	Y
6	5	15	16	0.8000000	12.0	5.5000	Y
7	5	12	17	1.0000000	12.0	5.5000	Y
8	5	14	19	0.8571429	12.0	5.5000	Y
9	5	8	12	1.5000000	12.0	5.5000	Y
10	5	17	7	0.7058824	12.0	5.4964	N
11	5	19	11	0.6315789	12.0	5.4976	Y
12	5	15	14	0.8000000	12.0	5.4952	Y
13	5	12	16	1.0000000	12.0	5.4940	Y
14	5	19	9	0.6315789	12.0	5.4972	Y
15	5	14	16	0.8571429	12.0	5.4948	Y
16	5	20	13	0.6000000	12.0	5.4980	Y
17	5	12	7	1.0000000	12.0	5.4940	N
18	5	14	10	0.8571429	12.0	5.4948	Y
19	5	12	19	1.0000000	12.0	5.4940	Y
20	5	16	12	0.7500000	12.0	5.5040	Y
21	5	12	14	1.0000000	12.0	5.5064	Y
22	5	20	9	0.6000000	12.0	5.5020	N
23	5	14	14	0.8571429	12.0	5.5052	Y
24	5	13	6	0.9230769	12.0	5.5056	N
25	5	8	7	1.5000000	12.0	5.5080	Y
26	5	17	18	0.7058824	12.0	5.5036	Y
27	5	19	16	0.6315789	12.0	5.5024	Y
28	5	12	17	1.0000000	12.0	5.5060	Y
29	5	18	16	0.6666667	12.0	5.5032	Y

Detection rate: 86%

Trial Number			0			
Bursts in Trial			16			
Center Frequency (MHz)			5500			
Burst	Number of Pulses	Pulse Width (µsec)	Chirp Width (MHz)	Pulse 1-to-2 PRI (µsec)	Pulse 2-to-3 PRI (µsec)	Start Location Within Interval (msec)
1	1	71.5	13	--	--	382.157
2	1	73.2	13	--	--	537.38
3	1	95.5	13	--	--	301.44
4	2	88.4	13	1280	--	586.04
5	2	64.8	13	1624	--	322.44
6	1	77.3	13	--	--	33.47
7	2	64.3	13	1035	--	238.39
8	1	97.4	13	--	--	422.7
9	1	60.5	13	--	--	589.16
10	2	77.3	13	1797	--	269.82
11	1	60.3	13	--	--	14.29
12	1	99.3	13	--	--	734.54
13	2	65.1	13	1528	--	118.33
14	2	56.9	13	1137	--	496.3
15	1	86	13	--	--	208.7
16	1	83.5	13	--	--	545
Detection Check (Y=Detection; N=No Detection)						Y

Trial Number			1			
Bursts in Trial			12			
Center Frequency (MHz)			5500			
Burst	Number of Pulses	Pulse Width (µsec)	Chirp Width (MHz)	Pulse 1-to-2 PRI (µsec)	Pulse 2-to-3 PRI (µsec)	Start Location Within Interval (msec)
1	3	96.6	19	1441	1588	157.072
2	2	57	19	1003	--	31.84
3	1	99.4	19	--	--	593.46
4	3	51.4	19	1076	1207	174.33
5	3	71.5	19	1105	1860	53.87
6	2	99.5	19	1009	--	204.9
7	2	96.8	19	1888	--	972.89
8	2	62.8	19	1708	--	421.81
9	2	68.6	19	1979	--	675.92
10	1	52.2	19	--	--	905.33
11	2	71.2	19	1891	--	626.2
12	1	80.7	19	--	--	297.1
Detection Check (Y=Detection; N=No Detection)						Y

Trial Number			2			
Bursts in Trial			12			
Center Frequency (MHz)			5500			
Burst	Number of Pulses	Pulse Width (µsec)	Chirp Width (MHz)	Pulse 1-to-2 PRI (µsec)	Pulse 2-to-3 PRI (µsec)	Start Location Within Interval (msec)
1	2	73	11	1720	--	60.341
2	2	86.6	11	1086	--	471.34
3	2	52	11	1769	--	149.46
4	3	89.5	11	1050	1774	665.26
5	2	91.3	11	1275	--	763.12
6	1	87.6	11	--	--	242.46
7	2	95.7	11	1592	--	386.09
8	1	79.1	11	--	--	690.82
9	2	63	11	1026	--	448.47
10	3	78.5	11	1233	1434	781.34
11	2	71.4	11	1774	--	534
12	2	93.2	11	1268	--	689.3
Detection Check (Y=Detection; N=No Detection)						Y

Trial Number			3			
Bursts in Trial			15			
Center Frequency (MHz)			5500			
Burst	Number of Pulses	Pulse Width (µsec)	Chirp Width (MHz)	Pulse 1-to-2 PRI (µsec)	Pulse 2-to-3 PRI (µsec)	Start Location Within Interval (msec)
1	3	51.8	12	1987	1673	785.215
2	1	67.1	12	--	--	304.74
3	2	80.4	12	1189	--	234.53
4	2	57.2	12	1369	--	400.36
5	3	80.9	12	1841	1377	257.92
6	2	66.8	12	1850	--	641.28
7	2	78.3	12	1566	--	763.04
8	1	95.7	12	--	--	315.89
9	2	72.6	12	1987	--	694.91
10	2	86.1	12	1099	--	12.39
11	3	54.6	12	1547	1020	744.49
12	3	82.4	12	1778	1816	623.75
13	2	52.6	12	1943	--	704.1
14	3	88.8	12	1592	1140	155.2
15	2	91.6	12	1430	--	771.7
Detection Check (Y=Detection; N=No Detection)						Y

Trial Number			4			
Bursts in Trial			15			
Center Frequency (MHz)			5500			
Burst	Number of Pulses	Pulse Width (μsec)	Chirp Width (MHz)	Pulse 1-to-2 PRI (μsec)	Pulse 2-to-3 PRI (μsec)	Start Location Within Interval (msec)
1	2	91.5	6	1778	--	131.166
2	1	58.6	6	--	--	306.44
3	1	54.2	6	--	--	157.68
4	1	68.4	6	--	--	464.16
5	2	62.8	6	1467	--	725.57
6	1	90.9	6	--	--	277.06
7	1	93.9	6	--	--	278.94
8	2	67.7	6	1128	--	83.93
9	2	57.2	6	1328	--	324.65
10	2	77.5	6	1726	--	269.88
11	1	53.8	6	--	--	538.06
12	2	56.7	6	1884	--	731.59
13	3	50.7	6	1243	1550	206.21
14	2	86.2	6	1189	--	307.7
15	1	82.7	6	--	--	208.1
Detection Check (Y=Detection; N=No Detection)						Y

Trial Number			5			
Bursts in Trial			10			
Center Frequency (MHz)			5500			
Burst	Number of Pulses	Pulse Width (μsec)	Chirp Width (MHz)	Pulse 1-to-2 PRI (μsec)	Pulse 2-to-3 PRI (μsec)	Start Location Within Interval (msec)
1	1	90.1	15	--	--	1033.2
2	2	80.7	15	1532	--	510.9
3	1	99.6	15	--	--	454.39
4	1	50.8	15	--	--	577.37
5	1	60.7	15	--	--	101.54
6	3	90	15	1254	1217	724.3
7	2	89.1	15	1337	--	977.24
8	2	96.6	15	1506	--	497.64
9	1	76.3	15	--	--	19.63
10	1	55.9	15	--	--	793.8
Detection Check (Y=Detection; N=No Detection)						Y

Trial Number			6			
Bursts in Trial			16			
Center Frequency (MHz)			5500			
Burst	Number of Pulses	Pulse Width (µsec)	Chirp Width (MHz)	Pulse 1-to-2 PRI (µsec)	Pulse 2-to-3 PRI (µsec)	Start Location Within Interval (msec)
1	3	57.1	16	1529	1704	329.074
2	2	89.7	16	1153	--	181.929
3	1	57	16	--	--	661.73
4	3	76.3	16	1421	1729	676.54
5	2	85	16	1471	--	195.28
6	2	51.1	16	1777	--	133.14
7	2	87.4	16	1935	--	235.39
8	1	76.9	16	--	--	689.87
9	2	53.7	16	1406	--	108.86
10	1	63.5	16	--	--	298.5
11	2	71.6	16	1480	--	455.93
12	1	54.9	16	--	--	458.73
13	1	54.9	16	--	--	655.32
14	1	74.4	16	--	--	342.5
15	3	57.1	16	1803	1961	253.6
16	2	60.1	16	1173	--	626.3
Detection Check (Y=Detection; N=No Detection)						Y

Trial Number			7			
Bursts in Trial			10			
Center Frequency (MHz)			5500			
Burst	Number of Pulses	Pulse Width (µsec)	Chirp Width (MHz)	Pulse 1-to-2 PRI (µsec)	Pulse 2-to-3 PRI (µsec)	Start Location Within Interval (msec)
1	1	73.5	17	--	--	1027.02
2	1	89.6	17	--	--	288.87
3	2	96.4	17	1502	--	940.16
4	1	55.4	17	--	--	538.88
5	3	77.4	17	1678	1866	313.88
6	3	94.7	17	1377	1225	810.56
7	3	87.8	17	1040	1623	571.58
8	3	69.1	17	1265	1703	573.24
9	2	93.1	17	1526	--	732
10	2	84.2	17	1218	--	1135.7
Detection Check (Y=Detection; N=No Detection)						Y

Trial Number			8			
Bursts in Trial			17			
Center Frequency (MHz)			5500			
Burst	Number of Pulses	Pulse Width (μsec)	Chirp Width (MHz)	Pulse 1-to-2 PRI (μsec)	Pulse 2-to-3 PRI (μsec)	Start Location Within Interval (msec)
1	1	99.9	19	--	--	379.224
2	3	66.9	19	1884	1117	141.215
3	3	93.9	19	1541	1081	385.095
4	1	68.1	19	--	--	381.083
5	3	64.4	19	1524	1742	555.971
6	1	55.5	19	--	--	305.368
7	2	75.7	19	1657	--	524.546
8	2	79.3	19	1445	--	300.074
9	2	92.5	19	1739	--	217.191
10	1	53.5	19	--	--	379.719
11	1	76	19	--	--	408.816
12	2	90.7	19	1974	--	321.334
13	3	50	19	1043	1917	429.582
14	3	55.9	19	1721	1782	269.669
15	3	62.5	19	1735	1532	392.247
16	2	97.3	19	1930	--	543.265
17	3	64	19	1406	1172	103.082
Detection Check (Y=Detection; N=No Detection)						Y

Trial Number			9			
Bursts in Trial			8			
Center Frequency (MHz)			5500			
Burst	Number of Pulses	Pulse Width (μsec)	Chirp Width (MHz)	Pulse 1-to-2 PRI (μsec)	Pulse 2-to-3 PRI (μsec)	Start Location Within Interval (msec)
1	1	72.5	12	--	--	509.857
2	1	82.2	12	--	--	164.27
3	2	95.6	12	1652	--	1336.41
4	3	97.5	12	1913	1669	1403.44
5	3	56.8	12	1289	1286	1431.47
6	1	59.1	12	--	--	847.09
7	2	79.4	12	1668	--	1007.5
8	1	57	12	--	--	1064.5
Detection Check (Y=Detection; N=No Detection)						Y

Trial Number			10			
Bursts in Trial			17			
Center Frequency (MHz)			5500			
Burst	Number of Pulses	Pulse Width (μsec)	Chirp Width (MHz)	Pulse 1-to-2 PRI (μsec)	Pulse 2-to-3 PRI (μsec)	Start Location Within Interval (msec)
1	1	78.3	7	--	--	66.832
2	2	84.7	7	1277	--	533.498
3	3	66.8	7	1498	1487	363.275
4	3	85.1	7	1385	1978	101.033
5	3	50.6	7	1597	1042	240.291
6	2	70.9	7	1963	--	359.558
7	2	52.6	7	1254	--	587.176
8	1	99.2	7	--	--	324.064
9	1	99.4	7	--	--	661.481
10	1	60.8	7	--	--	618.299
11	1	98.1	7	--	--	161.846
12	3	71.3	7	1514	1297	681.744
13	1	71.1	7	--	--	57.432
14	1	64.2	7	--	--	614.609
15	3	94.2	7	1515	1757	3.997
16	2	90.2	7	1007	--	409.465
17	2	94.5	7	1152	--	96.682
Detection Check (Y=Detection; N=No Detection)						N

Trial Number			11			
Bursts in Trial			14			
Center Frequency (MHz)			5500			
Burst	Number of Pulses	Pulse Width (µsec)	Chirp Width (MHz)	Pulse 1-to-2 PRI (µsec)	Pulse 2-to-3 PRI (µsec)	Start Location Within Interval (msec)
1	1	56.2	11	--	--	837.948
2	3	97.4	11	1384	1150	805.177
3	1	82.6	11	--	--	108.874
4	2	81.2	11	1739	--	561.491
5	3	57.1	11	1500	1788	637.839
6	1	96.9	11	--	--	470.256
7	2	78.8	11	1644	--	186.843
8	2	55.2	11	1314	--	537.84
9	2	90.3	11	1517	--	210.307
10	2	86.8	11	1352	--	340.554
11	1	72	11	--	--	461.061
12	2	56.3	11	1749	--	109.089
13	2	77.1	11	1952	--	370.286
14	1	93.2	11	--	--	5.543
Detection Check (Y=Detection; N=No Detection)						Y

Trial Number			12			
Bursts in Trial			13			
Center Frequency (MHz)			5500			
Burst	Number of Pulses	Pulse Width (µsec)	Chirp Width (MHz)	Pulse 1-to-2 PRI (µsec)	Pulse 2-to-3 PRI (µsec)	Start Location Within Interval (msec)
1	3	95.8	14	1940	1066	135.166
2	2	96.9	14	1620	--	508.763
3	2	64.3	14	1609	--	877.786
4	3	97.1	14	1568	1125	354.559
5	2	69.8	14	1068	--	329.312
6	2	82	14	1940	--	103.175
7	2	97	14	1961	--	131.808
8	2	93.5	14	1084	--	199.242
9	3	59.3	14	1735	1223	244.985
10	2	54.1	14	1500	--	916.988
11	1	86.7	14	--	--	784.231
12	3	84.8	14	1763	1920	134.054
13	2	99.9	14	1595	--	885.077
Detection Check (Y=Detection; N=No Detection)						Y

Trial Number			13			
Bursts in Trial			12			
Center Frequency (MHz)			5500			
Burst	Number of Pulses	Pulse Width (µsec)	Chirp Width (MHz)	Pulse 1-to-2 PRI (µsec)	Pulse 2-to-3 PRI (µsec)	Start Location Within Interval (msec)
1	2	53	16	1035	--	758.419
2	2	94.5	16	1456	--	599.82
3	1	92.9	16	--	--	897.55
4	3	50.5	16	1461	1898	387.44
5	1	55.8	16	--	--	663.7
6	2	55.8	16	1153	--	876.84
7	1	96.8	16	--	--	258.85
8	2	57.6	16	1472	--	697.38
9	1	52.8	16	--	--	238.05
10	2	84.7	16	1477	--	269.11
11	2	92.9	16	1337	--	540.7
12	2	61.8	16	1878	--	662.5
Detection Check (Y=Detection; N=No Detection)						Y

Trial Number			14			
Bursts in Trial			12			
Center Frequency (MHz)			5500			
Burst	Number of Pulses	Pulse Width (µsec)	Chirp Width (MHz)	Pulse 1-to-2 PRI (µsec)	Pulse 2-to-3 PRI (µsec)	Start Location Within Interval (msec)
1	3	87.7	9	1289	1972	865.268
2	2	75.3	9	1086	--	643.12
3	3	61.7	9	1399	1818	607.79
4	1	84.4	9	--	--	423.86
5	2	80	9	1874	--	777.53
6	2	91.9	9	1107	--	742.23
7	3	80.6	9	1890	1876	467.68
8	1	52.4	9	--	--	420.12
9	1	65.8	9	--	--	764.91
10	1	88.1	9	--	--	921.18
11	2	97.7	9	1534	--	726
12	2	53.1	9	1425	--	270.3
Detection Check (Y=Detection; N=No Detection)						Y

Trial Number			15			
Bursts in Trial			16			
Center Frequency (MHz)			5500			
Burst	Number of Pulses	Pulse Width (μsec)	Chirp Width (MHz)	Pulse 1-to-2 PRI (μsec)	Pulse 2-to-3 PRI (μsec)	Start Location Within Interval (msec)
1	3	97.9	16	1023	1938	381.483
2	3	70.6	16	1507	1652	143.51
3	3	79.6	16	1185	1158	742.51
4	2	57.2	16	1657	--	694.15
5	2	61.8	16	1683	--	337.15
6	1	66.3	16	--	--	683.08
7	1	82.8	16	--	--	472.18
8	3	93.4	16	1072	1130	445.02
9	2	89.6	16	1646	--	593.37
10	3	94.1	16	1786	1020	448.75
11	1	66.7	16	--	--	26.17
12	2	58.1	16	1687	--	734.86
13	2	72.2	16	1767	--	337.55
14	3	69.4	16	1373	1948	365.9
15	2	90.3	16	1006	--	82.7
16	2	78.6	16	1093	--	219.7
Detection Check (Y=Detection; N=No Detection)						Y

Trial Number			16			
Bursts in Trial			20			
Center Frequency (MHz)			5500			
Burst	Number of Pulses	Pulse Width (µsec)	Chirp Width (MHz)	Pulse 1-to-2 PRI (µsec)	Pulse 2-to-3 PRI (µsec)	Start Location Within Interval (msec)
1	3	86.8	13	1633	1688	157.83
2	2	85.7	13	1004	--	161.457
3	2	68.1	13	1361	--	539.54
4	2	70.2	13	1542	--	410.24
5	3	60.2	13	1702	1157	148.84
6	1	53.2	13	--	--	367.52
7	3	60.5	13	1463	1735	451.72
8	2	93.9	13	1676	--	576.92
9	3	65.7	13	1695	1344	391.29
10	2	62.9	13	1065	--	220.07
11	3	93.5	13	1923	1287	303.52
12	2	75.6	13	1938	--	287.4
13	2	64.2	13	1300	--	193.44
14	3	83.3	13	1347	1628	380.54
15	1	65.3	13	--	--	504.53
16	1	54.3	13	--	--	38.58
17	3	67.7	13	1394	1690	206.63
18	3	80.2	13	1533	1199	278.5
19	1	52.8	13	--	--	418.4
20	1	51.8	13	--	--	522
Detection Check (Y=Detection; N=No Detection)						Y

Trial Number			17			
Bursts in Trial			12			
Center Frequency (MHz)			5500			
Burst	Number of Pulses	Pulse Width (µsec)	Chirp Width (MHz)	Pulse 1-to-2 PRI (µsec)	Pulse 2-to-3 PRI (µsec)	Start Location Within Interval (msec)
1	2	75.1	7	1527	--	378.064
2	1	52	7	--	--	894.91
3	3	86.1	7	1038	1823	566.72
4	2	87.3	7	1203	--	633.91
5	1	76.6	7	--	--	748.36
6	2	52.1	7	1428	--	938.9
7	1	80.2	7	--	--	916.04
8	2	84.9	7	1434	--	220.9
9	3	66	7	1680	1545	735.64
10	3	98.9	7	1069	1516	489.68
11	2	88.8	7	1462	--	6.6
12	2	83.7	7	1680	--	832.6
Detection Check (Y=Detection; N=No Detection)						N

Trial Number			18			
Bursts in Trial			14			
Center Frequency (MHz)			5500			
Burst	Number of Pulses	Pulse Width (µsec)	Chirp Width (MHz)	Pulse 1-to-2 PRI (µsec)	Pulse 2-to-3 PRI (µsec)	Start Location Within Interval (msec)
1	3	79.3	10	1020	1017	192.931
2	1	62.2	10	--	--	96.667
3	3	83.7	10	1630	1335	273.514
4	2	53.7	10	1764	--	110.471
5	2	77.8	10	1592	--	263.819
6	2	60.9	10	1984	--	632.906
7	1	67.9	10	--	--	627.323
8	2	69.3	10	1449	--	368.52
9	2	64.3	10	1398	--	298.147
10	1	58.3	10	--	--	130.664
11	3	54	10	1917	1051	9.831
12	2	58.9	10	1493	--	454.209
13	2	75.9	10	1065	--	520.086
14	2	52.5	10	1808	--	280.443
Detection Check (Y=Detection; N=No Detection)						Y

Trial Number		19				
Bursts in Trial		18				
Center Frequency (MHz)		5500				
Burst	Number of Pulses	Pulse Width (μ sec)	Chirp Width (MHz)	Pulse 1-to-2 PRI (μ sec)	Pulse 2-to-3 PRI (μ sec)	Start Location Within Interval (msec)
1	2	81.4	19	1665	--	379.976
2	2	98.8	19	1428	--	272.868
3	2	60.4	19	1371	--	570.017
4	2	97	19	1547	--	562.33
5	2	86.2	19	1951	--	145.103
6	3	79.4	19	1380	1824	78.747
7	3	88.9	19	1956	1288	310.78
8	2	65	19	1220	--	502.523
9	2	67.4	19	1831	--	239.657
10	3	57.6	19	1469	1682	12.3
11	1	51.4	19	--	--	612.783
12	1	65.1	19	--	--	70.597
13	2	58.8	19	1161	--	630.95
14	1	56.5	19	--	--	239.533
15	3	72.5	19	1697	1127	465.857
16	2	86	19	1139	--	25.3
17	3	82.8	19	1615	1859	279.433
18	3	63.2	19	1338	1480	607.867
Detection Check (Y=Detection; N=No Detection)						Y

Trial Number		20				
Bursts in Trial		16				
Center Frequency (MHz)		5500				
Burst	Number of Pulses	Pulse Width (μ sec)	Chirp Width (MHz)	Pulse 1-to-2 PRI (μ sec)	Pulse 2-to-3 PRI (μ sec)	Start Location Within Interval (msec)
1	1	87.9	12	--	--	203.419
2	3	91.8	12	1177	1664	420.39
3	2	81.2	12	1861	--	263.57
4	3	69	12	1086	1723	420.04
5	3	71.3	12	1867	1451	255.33
6	2	66	12	1807	--	76.06
7	3	59.7	12	1364	1272	600.22
8	2	99.1	12	1254	--	491.16
9	3	76.3	12	1765	1703	475
10	2	74.7	12	1510	--	275.44
11	1	91.8	12	--	--	108
12	3	78	12	1049	1889	264.44

13	2	56.7	12	1249	--	224.56
14	2	78.3	12	1730	--	164.37
15	2	80.3	12	1064	--	105.5
16	2	95.9	12	1232	--	642.7
Detection Check (Y=Detection; N=No Detection)						Y

Trial Number			21			
Bursts in Trial			11			
Center Frequency (MHz)			5500			
Burst	Number of Pulses	Pulse Width (μsec)	Chirp Width (MHz)	Pulse 1-to-2 PRI (μsec)	Pulse 2-to-3 PRI (μsec)	Start Location Within Interval (msec)
1	2	78.3	14	1107	--	328.895
2	2	90.5	14	1373	--	193.381
3	2	52.1	14	1732	--	90.162
4	2	83.4	14	1217	--	576.633
5	2	99.9	14	1450	--	434.734
6	3	80.9	14	1048	1373	344.525
7	2	96.3	14	1883	--	6.815
8	1	58.1	14	--	--	927.796
9	1	71.2	14	--	--	210.757
10	1	66.5	14	--	--	480.218
11	3	94.5	14	1844	1097	523.709
Detection Check (Y=Detection; N=No Detection)						Y

Trial Number			22			
Bursts in Trial			11			
Center Frequency (MHz)			5500			
Burst	Number of Pulses	Pulse Width (μsec)	Chirp Width (MHz)	Pulse 1-to-2 PRI (μsec)	Pulse 2-to-3 PRI (μsec)	Start Location Within Interval (msec)
1	1	82	9	--	--	172.917
2	1	59.3	9	--	--	608.461
3	2	89.6	9	1905	--	424.392
4	1	53.5	9	--	--	180.013
5	2	68.9	9	1503	--	348.334
6	2	97.5	9	1399	--	582.715
7	1	65.1	9	--	--	909.895
8	2	63.7	9	1299	--	873.616
9	2	57.5	9	1730	--	417.387
10	3	76.2	9	1237	1939	647.018
11	2	83.3	9	1928	--	781.609
Detection Check (Y=Detection; N=No Detection)						N

Trial Number			23			
Bursts in Trial			15			
Center Frequency (MHz)			5500			
Burst	Number of Pulses	Pulse Width (µsec)	Chirp Width (MHz)	Pulse 1-to-2 PRI (µsec)	Pulse 2-to-3 PRI (µsec)	Start Location Within Interval (msec)
1	1	57.1	14	--	--	65.901
2	1	86.7	14	--	--	334.79
3	3	91.2	14	1464	1074	722.8
4	2	62.7	14	1790	--	317.33
5	3	80.8	14	1118	1285	129.98
6	2	84.3	14	1360	--	249.47
7	2	64.6	14	1038	--	25.27
8	2	79.1	14	1527	--	756.97
9	1	86.8	14	--	--	409.03
10	2	78.2	14	1256	--	668.58
11	3	50.4	14	1968	1182	306.55
12	2	55.9	14	1089	--	309.2
13	2	67.9	14	1084	--	236.1
14	3	85	14	1065	1119	168.6
15	2	78.1	14	1259	--	728.3
Detection Check (Y=Detection; N=No Detection)						Y

Trial Number			24			
Bursts in Trial			16			
Center Frequency (MHz)			5500			
Burst	Number of Pulses	Pulse Width (µsec)	Chirp Width (MHz)	Pulse 1-to-2 PRI (µsec)	Pulse 2-to-3 PRI (µsec)	Start Location Within Interval (msec)
1	2	64.7	6	1189	--	620.783
2	3	54.8	6	1622	1448	256.86
3	2	75.1	6	1284	--	23.87
4	1	71	6	--	--	303.19
5	3	88.2	6	1851	1581	385.32
6	1	75.6	6	--	--	597.77
7	2	75.6	6	1269	--	435.6
8	1	82.6	6	--	--	360.56
9	2	96.8	6	1761	--	77.78
10	2	58.1	6	1040	--	173.34
11	2	59.3	6	1366	--	737.85
12	3	98.3	6	1913	1459	603.56
13	3	80.2	6	1438	1558	374.67
14	3	78.3	6	1477	1776	335.3

15	3	82.7	6	1555	1484	146.8
16	3	56.2	6	1229	1598	79.4
Detection Check (Y=Detection; N=No Detection)						N

Trial Number		25				
Bursts in Trial		16				
Center Frequency (MHz)		5500				
Burst	Number of Pulses	Pulse Width (μsec)	Chirp Width (MHz)	Pulse 1-to-2 PRI (μsec)	Pulse 2-to-3 PRI (μsec)	Start Location Within Interval (msec)
1	3	54.5	7	1015	1238	429.994
2	1	80.7	7	--	--	679.08
3	3	70	7	1156	1260	249.98
4	1	56.2	7	--	--	719.15
5	1	61.1	7	--	--	527.59
6	2	78.2	7	1561	--	92.59
7	3	88.1	7	1583	1525	437.61
8	2	57	7	1883	--	39.85
9	1	84	7	--	--	411.41
10	3	86	7	1306	1025	189.06
11	1	77.4	7	--	--	606.17
12	1	93.7	7	--	--	431.02
13	2	54.8	7	1904	--	159.91
14	2	74.2	7	1678	--	147.02
15	2	93.7	7	1653	--	56.4
16	2	86.6	7	1395	--	355.2
Detection Check (Y=Detection; N=No Detection)						Y

Trial Number			26			
Bursts in Trial			19			
Center Frequency (MHz)			5500			
Burst	Number of Pulses	Pulse Width (µsec)	Chirp Width (MHz)	Pulse 1-to-2 PRI (µsec)	Pulse 2-to-3 PRI (µsec)	Start Location Within Interval (msec)
1	1	64.4	18	--	--	308.658
2	2	90.1	18	1488	--	373.081
3	2	86.6	18	1562	--	547.442
4	2	98.4	18	1568	--	139.593
5	2	50.6	18	1465	--	463.894
6	3	66.6	18	1313	1964	83.195
7	2	69.7	18	1977	--	136.706
8	3	51	18	1127	1391	393.717
9	2	57.6	18	1806	--	0.548
10	2	94.8	18	1198	--	469.749
11	2	87	18	1561	--	301.451
12	2	92.4	18	1357	--	62.642
13	2	78.6	18	1422	--	573.103
14	2	85.5	18	1778	--	33.424
15	3	94.5	18	1220	1042	392.475
16	2	57	18	1894	--	168.156
17	3	70	18	1275	1186	160.537
18	2	92.5	18	1694	--	458.758
19	3	89.3	18	1325	1258	311.379
Detection Check (Y=Detection; N=No Detection)						Y

Trial Number			27			
Bursts in Trial			11			
Center Frequency (MHz)			5500			
Burst	Number of Pulses	Pulse Width (µsec)	Chirp Width (MHz)	Pulse 1-to-2 PRI (µsec)	Pulse 2-to-3 PRI (µsec)	Start Location Within Interval (msec)
1	3	64	16	1368	1167	476.207
2	2	62.1	16	1444	--	524.961
3	1	86.2	16	--	--	337.732
4	2	58.5	16	1064	--	8.483
5	3	89.1	16	1071	1544	985.664
6	2	71.8	16	1683	--	770.295
7	2	64.2	16	1878	--	33.785
8	1	85.4	16	--	--	440.826
9	2	91.8	16	1552	--	1052.437
10	2	77.3	16	1498	--	467.118

11	2	77.9	16	1991	--	436.609
Detection Check (Y=Detection; N=No Detection)						Y

Trial Number			28			
Bursts in Trial			19			
Center Frequency (MHz)			5500			
Burst	Number of Pulses	Pulse Width (μsec)	Chirp Width (MHz)	Pulse 1-to-2 PRI (μsec)	Pulse 2-to-3 PRI (μsec)	Start Location Within Interval (msec)
1	3	76.4	17	1347	1144	51.36
2	3	52.4	17	1992	1827	562.281
3	3	85.4	17	1786	1251	43.492
4	2	54.2	17	1282	--	130.973
5	3	83.6	17	1299	1137	613.204
6	2	96.3	17	1921	--	136.395
7	2	92	17	1825	--	343.526
8	2	80.6	17	1159	--	428.897
9	1	67.8	17	--	--	398.418
10	2	58.3	17	1413	--	208.519
11	1	81.9	17	--	--	618.001
12	2	55.6	17	1845	--	299.562
13	2	52.5	17	1827	--	284.473
14	2	99.8	17	1290	--	560.544
15	2	56.5	17	1607	--	396.155
16	1	70.8	17	--	--	506.436
17	2	80	17	1582	--	560.837
18	2	50	17	1957	--	334.158
19	1	86.5	17	--	--	129.179
Detection Check (Y=Detection; N=No Detection)						Y

Trial Number			29			
Bursts in Trial			11			
Center Frequency (MHz)			5500			
Burst	Number of Pulses	Pulse Width (μsec)	Chirp Width (MHz)	Pulse 1-to-2 PRI (μsec)	Pulse 2-to-3 PRI (μsec)	Start Location Within Interval (msec)
1	3	72.5	16	1326	1085	418.338
2	3	53.2	16	1255	1936	774.251
3	2	80.8	16	1517	--	84.442
4	3	52.8	16	1186	1080	587.603
5	3	88.6	16	1232	1276	343.594
6	2	57.3	16	1273	--	151.485
7	2	76.7	16	1543	--	524.595
8	2	78.2	16	1355	--	1037.786
9	3	63.2	16	1638	1805	377.997
10	3	65.6	16	1036	1727	298.618
11	1	97.1	16	--	--	86.409
Detection Check (Y=Detection; N=No Detection)						Y

5500MHz, Radar 6

Trial Id	Radar Type	Pulse Width(μ s)	PRI (μ s)	Pulses Per Hop	Hopping Rate (kHz)	Hopping Sequence Length (ms)	Visible Frequency Number	conclusion
0	6	1.0	333.3	9	0.3333	300.00	33	Y
1	6	1.0	333.3	9	0.3333	300.00	29	Y
2	6	1.0	333.3	9	0.3333	300.00	28	Y
3	6	1.0	333.3	9	0.3333	300.00	35	Y
4	6	1.0	333.3	9	0.3333	300.00	35	Y
5	6	1.0	333.3	9	0.3333	300.00	31	Y
6	6	1.0	333.3	9	0.3333	300.00	33	Y
7	6	1.0	333.3	9	0.3333	300.00	29	Y
8	6	1.0	333.3	9	0.3333	300.00	33	Y
9	6	1.0	333.3	9	0.3333	300.00	32	Y
10	6	1.0	333.3	9	0.3333	300.00	36	Y
11	6	1.0	333.3	9	0.3333	300.00	40	Y
12	6	1.0	333.3	9	0.3333	300.00	37	Y
13	6	1.0	333.3	9	0.3333	300.00	34	Y
14	6	1.0	333.3	9	0.3333	300.00	31	Y
15	6	1.0	333.3	9	0.3333	300.00	39	Y
16	6	1.0	333.3	9	0.3333	300.00	35	Y
17	6	1.0	333.3	9	0.3333	300.00	36	Y
18	6	1.0	333.3	9	0.3333	300.00	29	Y
19	6	1.0	333.3	9	0.3333	300.00	32	Y
20	6	1.0	333.3	9	0.3333	300.00	35	Y
21	6	1.0	333.3	9	0.3333	300.00	38	Y
22	6	1.0	333.3	9	0.3333	300.00	40	Y
23	6	1.0	333.3	9	0.3333	300.00	37	Y
24	6	1.0	333.3	9	0.3333	300.00	31	Y
25	6	1.0	333.3	9	0.3333	300.00	33	Y
26	6	1.0	333.3	9	0.3333	300.00	29	Y
27	6	1.0	333.3	9	0.3333	300.00	35	Y
28	6	1.0	333.3	9	0.3333	300.00	32	Y
29	6	1.0	333.3	9	0.3333	300.00	37	Y

Detection rate: 100%

5550MHz, Radar 1

Trial Id	Radar Type	Pulse Width(μs)	PRI (μs)	Number of Pulses	Waveform Length (μs)	conclusion
0	1	1.0	938.0	57	53466.0	Y
1	1	1.0	698.0	76	53048.0	Y
2	1	1.0	618.0	86	53148.0	Y
3	1	1.0	538.0	99	53262.0	Y
4	1	1.0	878.0	61	53558.0	Y
5	1	1.0	3066.0	18	55188.0	Y
6	1	1.0	638.0	83	52954.0	Y
7	1	1.0	918.0	58	53244.0	Y
8	1	1.0	838.0	63	52794.0	Y
9	1	1.0	858.0	62	53196.0	Y
10	1	1.0	798.0	67	53466.0	Y
11	1	1.0	718.0	74	53132.0	N
12	1	1.0	578.0	92	53176.0	Y
13	1	1.0	598.0	89	53222.0	Y
14	1	1.0	558.0	95	53010.0	Y
15	1	1.0	2536.0	21	53256.0	Y
16	1	1.0	966.0	55	53130.0	Y
17	1	1.0	827.0	64	52928.0	Y
18	1	1.0	2501.0	22	55022.0	Y
19	1	1.0	2595.0	21	54495.0	Y
20	1	1.0	1114.0	48	53472.0	Y
21	1	1.0	1302.0	41	53382.0	Y
22	1	1.0	3045.0	18	54810.0	Y
23	1	1.0	1624.0	33	53592.0	Y
24	1	1.0	2878.0	19	54682.0	Y
25	1	1.0	1027.0	52	53404.0	Y
26	1	1.0	2485.0	22	54670.0	Y
27	1	1.0	1600.0	33	52800.0	Y
28	1	1.0	1172.0	46	53912.0	Y
29	1	1.0	1177.0	45	52965.0	Y
Detection rate: 97%						

5550MHz, Radar 2

Trial Id	Radar Type	Pulse Width(μ s)	PRI (μ s)	Number of Pulses	Waveform Length (μ s)	conclusion
0	2	3.2	179.0	26	4654.0	Y
1	2	1.1	207.0	23	4761.0	Y
2	2	2.1	230.0	24	5520.0	Y
3	2	4.8	200.0	29	5800.0	Y
4	2	3.9	214.0	28	5992.0	Y
5	2	2.9	222.0	26	5772.0	Y
6	2	3.2	204.0	26	5304.0	Y
7	2	2.5	192.0	25	4800.0	Y
8	2	3.1	164.0	26	4264.0	Y
9	2	1.2	156.0	23	3588.0	Y
10	2	3.9	210.0	27	5670.0	Y
11	2	4.6	201.0	29	5829.0	Y
12	2	3.2	162.0	26	4212.0	Y
13	2	2.2	197.0	25	4925.0	Y
14	2	4.5	163.0	29	4727.0	Y
15	2	3.0	203.0	26	5278.0	Y
16	2	5.0	168.0	29	4872.0	Y
17	2	2.4	217.0	25	5425.0	Y
18	2	2.9	191.0	26	4966.0	Y
19	2	2.3	166.0	25	4150.0	Y
20	2	3.7	150.0	27	4050.0	Y
21	2	2.2	176.0	25	4400.0	Y
22	2	4.9	195.0	29	5655	Y
23	2	2.9	202.0	26	5252.0	Y
24	2	2.5	178.0	25	4450.0	Y
25	2	1.1	206.0	23	4738.0	Y
26	2	3.8	155.0	27	4185.0	Y
27	2	4.7	157.0	29	4553.0	Y
28	2	2.4	224.0	25	5600.0	Y
29	2	4.2	159.0	28	4452.0	Y
Detection rate: 100%						

5550MHz, Radar 3

Trial Id	Radar Type	Pulse Width(μ s)	PRI (μ s)	Number of Pulses	Waveform Length (μ s)	conclusion
0	3	8.2	355.0	17	6035.0	Y
1	3	6.1	487.0	16	7792.0	Y
2	3	7.1	344.0	16	5504.0	Y
3	3	9.8	288.0	18	5184.0	Y
4	3	8.9	230.0	18	4140.0	Y
5	3	7.9	432.0	17	7344.0	Y
6	3	8.2	207.0	17	3519.0	Y
7	3	7.5	443.0	17	7531.0	Y
8	3	8.1	439.0	17	7463.0	Y
9	3	6.2	223.0	16	3568.0	Y
10	3	8.9	208.0	18	3744.0	Y
11	3	9.6	463.0	18	8334.0	Y
12	3	8.2	441.0	17	7497.0	Y
13	3	7.2	323.0	16	5168.0	Y
14	3	9.5	297.0	18	5346.0	Y
15	3	8.0	412.0	17	7004.0	Y
16	3	10.0	324.0	18	5832.0	Y
17	3	7.4	271.0	17	4607.0	Y
18	3	7.9	349.0	17	5933.0	Y
19	3	7.3	409.0	16	6544.0	Y
20	3	8.7	373.0	18	6714.0	Y
21	3	7.2	254.0	16	4064.0	Y
22	3	9.9	274.0	18	4932.0	Y
23	3	7.9	278.0	17	4726.0	Y
24	3	7.5	317.0	17	5389.0	Y
25	3	6.1	260.0	16	4160.0	Y
26	3	8.8	211.0	18	3798.0	Y
27	3	9.7	272.0	18	4896.0	Y
28	3	7.4	264.0	17	4488.0	Y
29	3	9.2	284.0	18	5112.0	Y
Detection rate: 100%						

5550MHz, Radar 4

Trial Id	Radar Type	Pulse Width(μ s)	PRI (μ s)	Number of Pulses	Waveform Length (μ s)	conclusion
0	4	16.0	355.0	14	4970.0	Y
1	4	11.3	487.0	12	5844.0	Y
2	4	13.5	344.0	13	4472.0	Y
3	4	19.4	288.0	16	4608.0	Y
4	4	17.5	230.0	15	3450.0	Y
5	4	15.3	432.0	14	6048.0	Y
6	4	15.9	207.0	14	2898.0	Y
7	4	14.3	443.0	13	5759.0	Y
8	4	15.8	439.0	14	6146.0	Y
9	4	11.5	223.0	12	2676.0	Y
10	4	17.4	208.0	15	3120.0	Y
11	4	19.0	463.0	16	7408.0	Y
12	4	16.0	441.0	14	6174.0	Y
13	4	13.8	323.0	13	4199.0	Y
14	4	18.9	297.0	16	4752.0	Y
15	4	15.5	412.0	14	5768.0	Y
16	4	19.9	324.0	16	5184.0	Y
17	4	14.1	271.0	13	3523.0	Y
18	4	15.2	349.0	14	4886.0	Y
19	4	13.8	409.0	13	5317.0	Y
20	4	17.1	373.0	15	5595.0	Y
21	4	13.8	254.0	13	3302.0	Y
22	4	19.8	274.0	16	4384.0	Y
23	4	15.3	278.0	14	3892.0	Y
24	4	14.5	317.0	13	4121.0	Y
25	4	11.3	260.0	12	3120.0	Y
26	4	17.3	211.0	15	3165.0	Y
27	4	19.2	272.0	16	4352.0	Y
28	4	14.2	264.0	13	3432.0	Y
29	4	18.2	284.0	15	4260.0	Y
Detection rate: 100%						

5550MHz, Radar 5

Trial Id	Radar Type	Number of Pulses	Chirp Width (MHz)	Burst Period (s)	Waveform Length (μ s)	Center Frequency	conclusion
0	5	15	13	0.8000000	12.0	5.5500	Y
1	5	8	19	1.5000000	12.0	5.5500	Y
2	5	11	11	1.0909091	12.0	5.5500	Y
3	5	20	12	0.6000000	12.0	5.5500	Y
4	5	17	6	0.7058824	12.0	5.5500	Y
5	5	14	15	0.8571429	12.0	5.5500	Y
6	5	15	16	0.8000000	12.0	5.5500	Y
7	5	12	17	1.0000000	12.0	5.5500	Y
8	5	14	19	0.8571429	12.0	5.5500	Y
9	5	8	12	1.5000000	12.0	5.5500	Y
10	5	17	7	0.7058824	12.0	5.5364	Y
11	5	19	11	0.6315789	12.0	5.5376	Y
12	5	15	14	0.8000000	12.0	5.5352	Y
13	5	12	16	1.0000000	12.0	5.5340	N
14	5	19	9	0.6315789	12.0	5.5372	Y
15	5	14	16	0.8571429	12.0	5.5348	Y
16	5	20	13	0.6000000	12.0	5.5380	Y
17	5	12	7	1.0000000	12.0	5.5340	Y
18	5	14	10	0.8571429	12.0	5.5348	Y
19	5	12	19	1.0000000	12.0	5.5340	Y
20	5	16	12	0.7500000	12.0	5.5640	Y
21	5	12	14	1.0000000	12.0	5.5664	Y
22	5	20	9	0.6000000	12.0	5.5620	Y
23	5	14	14	0.8571429	12.0	5.5652	Y
24	5	13	6	0.9230769	12.0	5.5656	N
25	5	8	7	1.5000000	12.0	5.5680	Y
26	5	17	18	0.7058824	12.0	5.5636	Y
27	5	19	16	0.6315789	12.0	5.5624	N
28	5	12	17	1.0000000	12.0	5.5660	Y
29	5	18	16	0.6666667	12.0	5.5632	Y

Detection rate: 90%

Trial Number			0			
Bursts in Trial			16			
Center Frequency (MHz)			5550			
Burst	Number of Pulses	Pulse Width (µsec)	Chirp Width (MHz)	Pulse 1-to-2 PRI (µsec)	Pulse 2-to-3 PRI (µsec)	Start Location Within Interval (msec)
1	1	71.5	13	--	--	382.157
2	1	73.2	13	--	--	537.38
3	1	95.5	13	--	--	301.44
4	2	88.4	13	1280	--	586.04
5	2	64.8	13	1624	--	322.44
6	1	77.3	13	--	--	33.47
7	2	64.3	13	1035	--	238.39
8	1	97.4	13	--	--	422.7
9	1	60.5	13	--	--	589.16
10	2	77.3	13	1797	--	269.82
11	1	60.3	13	--	--	14.29
12	1	99.3	13	--	--	734.54
13	2	65.1	13	1528	--	118.33
14	2	56.9	13	1137	--	496.3
15	1	86	13	--	--	208.7
16	1	83.5	13	--	--	545
Detection Check (Y=Detection; N=No Detection)						Y

Trial Number			1			
Bursts in Trial			12			
Center Frequency (MHz)			5550			
Burst	Number of Pulses	Pulse Width (µsec)	Chirp Width (MHz)	Pulse 1-to-2 PRI (µsec)	Pulse 2-to-3 PRI (µsec)	Start Location Within Interval (msec)
1	3	96.6	19	1441	1588	157.072
2	2	57	19	1003	--	31.84
3	1	99.4	19	--	--	593.46
4	3	51.4	19	1076	1207	174.33
5	3	71.5	19	1105	1860	53.87
6	2	99.5	19	1009	--	204.9
7	2	96.8	19	1888	--	972.89
8	2	62.8	19	1708	--	421.81
9	2	68.6	19	1979	--	675.92
10	1	52.2	19	--	--	905.33
11	2	71.2	19	1891	--	626.2
12	1	80.7	19	--	--	297.1
Detection Check (Y=Detection; N=No Detection)						Y

Trial Number			2			
Bursts in Trial			12			
Center Frequency (MHz)			5550			
Burst	Number of Pulses	Pulse Width (µsec)	Chirp Width (MHz)	Pulse 1-to-2 PRI (µsec)	Pulse 2-to-3 PRI (µsec)	Start Location Within Interval (msec)
1	2	73	11	1720	--	60.341
2	2	86.6	11	1086	--	471.34
3	2	52	11	1769	--	149.46
4	3	89.5	11	1050	1774	665.26
5	2	91.3	11	1275	--	763.12
6	1	87.6	11	--	--	242.46
7	2	95.7	11	1592	--	386.09
8	1	79.1	11	--	--	690.82
9	2	63	11	1026	--	448.47
10	3	78.5	11	1233	1434	781.34
11	2	71.4	11	1774	--	534
12	2	93.2	11	1268	--	689.3
Detection Check (Y=Detection; N=No Detection)						Y

Trial Number			3			
Bursts in Trial			15			
Center Frequency (MHz)			5550			
Burst	Number of Pulses	Pulse Width (µsec)	Chirp Width (MHz)	Pulse 1-to-2 PRI (µsec)	Pulse 2-to-3 PRI (µsec)	Start Location Within Interval (msec)
1	3	51.8	12	1987	1673	785.215
2	1	67.1	12	--	--	304.74
3	2	80.4	12	1189	--	234.53
4	2	57.2	12	1369	--	400.36
5	3	80.9	12	1841	1377	257.92
6	2	66.8	12	1850	--	641.28
7	2	78.3	12	1566	--	763.04
8	1	95.7	12	--	--	315.89
9	2	72.6	12	1987	--	694.91
10	2	86.1	12	1099	--	12.39
11	3	54.6	12	1547	1020	744.49
12	3	82.4	12	1778	1816	623.75
13	2	52.6	12	1943	--	704.1
14	3	88.8	12	1592	1140	155.2
15	2	91.6	12	1430	--	771.7
Detection Check (Y=Detection; N=No Detection)						Y

Trial Number			4			
Bursts in Trial			15			
Center Frequency (MHz)			5550			
Burst	Number of Pulses	Pulse Width (µsec)	Chirp Width (MHz)	Pulse 1-to-2 PRI (µsec)	Pulse 2-to-3 PRI (µsec)	Start Location Within Interval (msec)
1	2	91.5	6	1778	--	131.166
2	1	58.6	6	--	--	306.44
3	1	54.2	6	--	--	157.68
4	1	68.4	6	--	--	464.16
5	2	62.8	6	1467	--	725.57
6	1	90.9	6	--	--	277.06
7	1	93.9	6	--	--	278.94
8	2	67.7	6	1128	--	83.93
9	2	57.2	6	1328	--	324.65
10	2	77.5	6	1726	--	269.88
11	1	53.8	6	--	--	538.06
12	2	56.7	6	1884	--	731.59
13	3	50.7	6	1243	1550	206.21
14	2	86.2	6	1189	--	307.7
15	1	82.7	6	--	--	208.1
Detection Check (Y=Detection; N=No Detection)						Y

Trial Number			5			
Bursts in Trial			10			
Center Frequency (MHz)			5550			
Burst	Number of Pulses	Pulse Width (µsec)	Chirp Width (MHz)	Pulse 1-to-2 PRI (µsec)	Pulse 2-to-3 PRI (µsec)	Start Location Within Interval (msec)
1	1	90.1	15	--	--	1033.2
2	2	80.7	15	1532	--	510.9
3	1	99.6	15	--	--	454.39
4	1	50.8	15	--	--	577.37
5	1	60.7	15	--	--	101.54
6	3	90	15	1254	1217	724.3
7	2	89.1	15	1337	--	977.24
8	2	96.6	15	1506	--	497.64
9	1	76.3	15	--	--	19.63
10	1	55.9	15	--	--	793.8
Detection Check (Y=Detection; N=No Detection)						Y

Trial Number			6			
Bursts in Trial			16			
Center Frequency (MHz)			5550			
Burst	Number of Pulses	Pulse Width (µsec)	Chirp Width (MHz)	Pulse 1-to-2 PRI (µsec)	Pulse 2-to-3 PRI (µsec)	Start Location Within Interval (msec)
1	3	57.1	16	1529	1704	329.074
2	2	89.7	16	1153	--	181.929
3	1	57	16	--	--	661.73
4	3	76.3	16	1421	1729	676.54
5	2	85	16	1471	--	195.28
6	2	51.1	16	1777	--	133.14
7	2	87.4	16	1935	--	235.39
8	1	76.9	16	--	--	689.87
9	2	53.7	16	1406	--	108.86
10	1	63.5	16	--	--	298.5
11	2	71.6	16	1480	--	455.93
12	1	54.9	16	--	--	458.73
13	1	54.9	16	--	--	655.32
14	1	74.4	16	--	--	342.5
15	3	57.1	16	1803	1961	253.6
16	2	60.1	16	1173	--	626.3
Detection Check (Y=Detection; N=No Detection)						Y

Trial Number			7			
Bursts in Trial			10			
Center Frequency (MHz)			5550			
Burst	Number of Pulses	Pulse Width (µsec)	Chirp Width (MHz)	Pulse 1-to-2 PRI (µsec)	Pulse 2-to-3 PRI (µsec)	Start Location Within Interval (msec)
1	1	73.5	17	--	--	1027.02
2	1	89.6	17	--	--	288.87
3	2	96.4	17	1502	--	940.16
4	1	55.4	17	--	--	538.88
5	3	77.4	17	1678	1866	313.88
6	3	94.7	17	1377	1225	810.56
7	3	87.8	17	1040	1623	571.58
8	3	69.1	17	1265	1703	573.24
9	2	93.1	17	1526	--	732
10	2	84.2	17	1218	--	1135.7
Detection Check (Y=Detection; N=No Detection)						Y

Trial Number			8			
Bursts in Trial			17			
Center Frequency (MHz)			5550			
Burst	Number of Pulses	Pulse Width (μsec)	Chirp Width (MHz)	Pulse 1-to-2 PRI (μsec)	Pulse 2-to-3 PRI (μsec)	Start Location Within Interval (msec)
1	1	99.9	19	--	--	379.224
2	3	66.9	19	1884	1117	141.215
3	3	93.9	19	1541	1081	385.095
4	1	68.1	19	--	--	381.083
5	3	64.4	19	1524	1742	555.971
6	1	55.5	19	--	--	305.368
7	2	75.7	19	1657	--	524.546
8	2	79.3	19	1445	--	300.074
9	2	92.5	19	1739	--	217.191
10	1	53.5	19	--	--	379.719
11	1	76	19	--	--	408.816
12	2	90.7	19	1974	--	321.334
13	3	50	19	1043	1917	429.582
14	3	55.9	19	1721	1782	269.669
15	3	62.5	19	1735	1532	392.247
16	2	97.3	19	1930	--	543.265
17	3	64	19	1406	1172	103.082
Detection Check (Y=Detection; N=No Detection)						Y

Trial Number			9			
Bursts in Trial			8			
Center Frequency (MHz)			5550			
Burst	Number of Pulses	Pulse Width (μsec)	Chirp Width (MHz)	Pulse 1-to-2 PRI (μsec)	Pulse 2-to-3 PRI (μsec)	Start Location Within Interval (msec)
1	1	72.5	12	--	--	509.857
2	1	82.2	12	--	--	164.27
3	2	95.6	12	1652	--	1336.41
4	3	97.5	12	1913	1669	1403.44
5	3	56.8	12	1289	1286	1431.47
6	1	59.1	12	--	--	847.09
7	2	79.4	12	1668	--	1007.5
8	1	57	12	--	--	1064.5
Detection Check (Y=Detection; N=No Detection)						Y

Trial Number			10			
Bursts in Trial			17			
Center Frequency (MHz)			5550			
Burst	Number of Pulses	Pulse Width (μsec)	Chirp Width (MHz)	Pulse 1-to-2 PRI (μsec)	Pulse 2-to-3 PRI (μsec)	Start Location Within Interval (msec)
1	1	78.3	7	--	--	66.832
2	2	84.7	7	1277	--	533.498
3	3	66.8	7	1498	1487	363.275
4	3	85.1	7	1385	1978	101.033
5	3	50.6	7	1597	1042	240.291
6	2	70.9	7	1963	--	359.558
7	2	52.6	7	1254	--	587.176
8	1	99.2	7	--	--	324.064
9	1	99.4	7	--	--	661.481
10	1	60.8	7	--	--	618.299
11	1	98.1	7	--	--	161.846
12	3	71.3	7	1514	1297	681.744
13	1	71.1	7	--	--	57.432
14	1	64.2	7	--	--	614.609
15	3	94.2	7	1515	1757	3.997
16	2	90.2	7	1007	--	409.465
17	2	94.5	7	1152	--	96.682
Detection Check (Y=Detection; N=No Detection)						Y

Trial Number			11			
Bursts in Trial			14			
Center Frequency (MHz)			5550			
Burst	Number of Pulses	Pulse Width (µsec)	Chirp Width (MHz)	Pulse 1-to-2 PRI (µsec)	Pulse 2-to-3 PRI (µsec)	Start Location Within Interval (msec)
1	1	56.2	11	--	--	837.948
2	3	97.4	11	1384	1150	805.177
3	1	82.6	11	--	--	108.874
4	2	81.2	11	1739	--	561.491
5	3	57.1	11	1500	1788	637.839
6	1	96.9	11	--	--	470.256
7	2	78.8	11	1644	--	186.843
8	2	55.2	11	1314	--	537.84
9	2	90.3	11	1517	--	210.307
10	2	86.8	11	1352	--	340.554
11	1	72	11	--	--	461.061
12	2	56.3	11	1749	--	109.089
13	2	77.1	11	1952	--	370.286
14	1	93.2	11	--	--	5.543
Detection Check (Y=Detection; N=No Detection)						Y

Trial Number			12			
Bursts in Trial			13			
Center Frequency (MHz)			5550			
Burst	Number of Pulses	Pulse Width (µsec)	Chirp Width (MHz)	Pulse 1-to-2 PRI (µsec)	Pulse 2-to-3 PRI (µsec)	Start Location Within Interval (msec)
1	3	95.8	14	1940	1066	135.166
2	2	96.9	14	1620	--	508.763
3	2	64.3	14	1609	--	877.786
4	3	97.1	14	1568	1125	354.559
5	2	69.8	14	1068	--	329.312
6	2	82	14	1940	--	103.175
7	2	97	14	1961	--	131.808
8	2	93.5	14	1084	--	199.242
9	3	59.3	14	1735	1223	244.985
10	2	54.1	14	1500	--	916.988
11	1	86.7	14	--	--	784.231
12	3	84.8	14	1763	1920	134.054
13	2	99.9	14	1595	--	885.077
Detection Check (Y=Detection; N=No Detection)						Y

Trial Number			13			
Bursts in Trial			12			
Center Frequency (MHz)			5550			
Burst	Number of Pulses	Pulse Width (µsec)	Chirp Width (MHz)	Pulse 1-to-2 PRI (µsec)	Pulse 2-to-3 PRI (µsec)	Start Location Within Interval (msec)
1	2	53	16	1035	--	758.419
2	2	94.5	16	1456	--	599.82
3	1	92.9	16	--	--	897.55
4	3	50.5	16	1461	1898	387.44
5	1	55.8	16	--	--	663.7
6	2	55.8	16	1153	--	876.84
7	1	96.8	16	--	--	258.85
8	2	57.6	16	1472	--	697.38
9	1	52.8	16	--	--	238.05
10	2	84.7	16	1477	--	269.11
11	2	92.9	16	1337	--	540.7
12	2	61.8	16	1878	--	662.5
Detection Check (Y=Detection; N=No Detection)						N

Trial Number			14			
Bursts in Trial			12			
Center Frequency (MHz)			5550			
Burst	Number of Pulses	Pulse Width (µsec)	Chirp Width (MHz)	Pulse 1-to-2 PRI (µsec)	Pulse 2-to-3 PRI (µsec)	Start Location Within Interval (msec)
1	3	87.7	9	1289	1972	865.268
2	2	75.3	9	1086	--	643.12
3	3	61.7	9	1399	1818	607.79
4	1	84.4	9	--	--	423.86
5	2	80	9	1874	--	777.53
6	2	91.9	9	1107	--	742.23
7	3	80.6	9	1890	1876	467.68
8	1	52.4	9	--	--	420.12
9	1	65.8	9	--	--	764.91
10	1	88.1	9	--	--	921.18
11	2	97.7	9	1534	--	726
12	2	53.1	9	1425	--	270.3
Detection Check (Y=Detection; N=No Detection)						Y

Trial Number			15			
Bursts in Trial			16			
Center Frequency (MHz)			5550			
Burst	Number of Pulses	Pulse Width (µsec)	Chirp Width (MHz)	Pulse 1-to-2 PRI (µsec)	Pulse 2-to-3 PRI (µsec)	Start Location Within Interval (msec)
1	3	97.9	16	1023	1938	381.483
2	3	70.6	16	1507	1652	143.51
3	3	79.6	16	1185	1158	742.51
4	2	57.2	16	1657	--	694.15
5	2	61.8	16	1683	--	337.15
6	1	66.3	16	--	--	683.08
7	1	82.8	16	--	--	472.18
8	3	93.4	16	1072	1130	445.02
9	2	89.6	16	1646	--	593.37
10	3	94.1	16	1786	1020	448.75
11	1	66.7	16	--	--	26.17
12	2	58.1	16	1687	--	734.86
13	2	72.2	16	1767	--	337.55
14	3	69.4	16	1373	1948	365.9
15	2	90.3	16	1006	--	82.7
16	2	78.6	16	1093	--	219.7
Detection Check (Y=Detection; N=No Detection)						Y

Trial Number			16			
Bursts in Trial			20			
Center Frequency (MHz)			5550			
Burst	Number of Pulses	Pulse Width (µsec)	Chirp Width (MHz)	Pulse 1-to-2 PRI (µsec)	Pulse 2-to-3 PRI (µsec)	Start Location Within Interval (msec)
1	3	86.8	13	1633	1688	157.83
2	2	85.7	13	1004	--	161.457
3	2	68.1	13	1361	--	539.54
4	2	70.2	13	1542	--	410.24
5	3	60.2	13	1702	1157	148.84
6	1	53.2	13	--	--	367.52
7	3	60.5	13	1463	1735	451.72
8	2	93.9	13	1676	--	576.92
9	3	65.7	13	1695	1344	391.29
10	2	62.9	13	1065	--	220.07
11	3	93.5	13	1923	1287	303.52
12	2	75.6	13	1938	--	287.4
13	2	64.2	13	1300	--	193.44
14	3	83.3	13	1347	1628	380.54
15	1	65.3	13	--	--	504.53
16	1	54.3	13	--	--	38.58
17	3	67.7	13	1394	1690	206.63
18	3	80.2	13	1533	1199	278.5
19	1	52.8	13	--	--	418.4
20	1	51.8	13	--	--	522
Detection Check (Y=Detection; N=No Detection)						Y

Trial Number			17			
Bursts in Trial			12			
Center Frequency (MHz)			5550			
Burst	Number of Pulses	Pulse Width (µsec)	Chirp Width (MHz)	Pulse 1-to-2 PRI (µsec)	Pulse 2-to-3 PRI (µsec)	Start Location Within Interval (msec)
1	2	75.1	7	1527	--	378.064
2	1	52	7	--	--	894.91
3	3	86.1	7	1038	1823	566.72
4	2	87.3	7	1203	--	633.91
5	1	76.6	7	--	--	748.36
6	2	52.1	7	1428	--	938.9
7	1	80.2	7	--	--	916.04
8	2	84.9	7	1434	--	220.9
9	3	66	7	1680	1545	735.64
10	3	98.9	7	1069	1516	489.68
11	2	88.8	7	1462	--	6.6
12	2	83.7	7	1680	--	832.6
Detection Check (Y=Detection; N=No Detection)						Y

Trial Number			18			
Bursts in Trial			14			
Center Frequency (MHz)			5550			
Burst	Number of Pulses	Pulse Width (µsec)	Chirp Width (MHz)	Pulse 1-to-2 PRI (µsec)	Pulse 2-to-3 PRI (µsec)	Start Location Within Interval (msec)
1	3	79.3	10	1020	1017	192.931
2	1	62.2	10	--	--	96.667
3	3	83.7	10	1630	1335	273.514
4	2	53.7	10	1764	--	110.471
5	2	77.8	10	1592	--	263.819
6	2	60.9	10	1984	--	632.906
7	1	67.9	10	--	--	627.323
8	2	69.3	10	1449	--	368.52
9	2	64.3	10	1398	--	298.147
10	1	58.3	10	--	--	130.664
11	3	54	10	1917	1051	9.831
12	2	58.9	10	1493	--	454.209
13	2	75.9	10	1065	--	520.086
14	2	52.5	10	1808	--	280.443
Detection Check (Y=Detection; N=No Detection)						Y

Trial Number			19			
Bursts in Trial			18			
Center Frequency (MHz)			5550			
Burst	Number of Pulses	Pulse Width (µsec)	Chirp Width (MHz)	Pulse 1-to-2 PRI (µsec)	Pulse 2-to-3 PRI (µsec)	Start Location Within Interval (msec)
1	2	81.4	19	1665	--	379.976
2	2	98.8	19	1428	--	272.868
3	2	60.4	19	1371	--	570.017
4	2	97	19	1547	--	562.33
5	2	86.2	19	1951	--	145.103
6	3	79.4	19	1380	1824	78.747
7	3	88.9	19	1956	1288	310.78
8	2	65	19	1220	--	502.523
9	2	67.4	19	1831	--	239.657
10	3	57.6	19	1469	1682	12.3
11	1	51.4	19	--	--	612.783
12	1	65.1	19	--	--	70.597
13	2	58.8	19	1161	--	630.95
14	1	56.5	19	--	--	239.533
15	3	72.5	19	1697	1127	465.857
16	2	86	19	1139	--	25.3
17	3	82.8	19	1615	1859	279.433
18	3	63.2	19	1338	1480	607.867
Detection Check (Y=Detection; N=No Detection)						Y

Trial Number			20			
Bursts in Trial			16			
Center Frequency (MHz)			5550			
Burst	Number of Pulses	Pulse Width (µsec)	Chirp Width (MHz)	Pulse 1-to-2 PRI (µsec)	Pulse 2-to-3 PRI (µsec)	Start Location Within Interval (msec)
1	1	87.9	12	--	--	203.419
2	3	91.8	12	1177	1664	420.39
3	2	81.2	12	1861	--	263.57
4	3	69	12	1086	1723	420.04
5	3	71.3	12	1867	1451	255.33
6	2	66	12	1807	--	76.06
7	3	59.7	12	1364	1272	600.22
8	2	99.1	12	1254	--	491.16
9	3	76.3	12	1765	1703	475
10	2	74.7	12	1510	--	275.44
11	1	91.8	12	--	--	108
12	3	78	12	1049	1889	264.44

13	2	56.7	12	1249	--	224.56
14	2	78.3	12	1730	--	164.37
15	2	80.3	12	1064	--	105.5
16	2	95.9	12	1232	--	642.7
Detection Check (Y=Detection; N=No Detection)						Y

Trial Number			21			
Bursts in Trial			11			
Center Frequency (MHz)			5550			
Burst	Number of Pulses	Pulse Width (µsec)	Chirp Width (MHz)	Pulse 1-to-2 PRI (µsec)	Pulse 2-to-3 PRI (µsec)	Start Location Within Interval (msec)
1	2	78.3	14	1107	--	328.895
2	2	90.5	14	1373	--	193.381
3	2	52.1	14	1732	--	90.162
4	2	83.4	14	1217	--	576.633
5	2	99.9	14	1450	--	434.734
6	3	80.9	14	1048	1373	344.525
7	2	96.3	14	1883	--	6.815
8	1	58.1	14	--	--	927.796
9	1	71.2	14	--	--	210.757
10	1	66.5	14	--	--	480.218
11	3	94.5	14	1844	1097	523.709
Detection Check (Y=Detection; N=No Detection)						Y

Trial Number			22			
Bursts in Trial			11			
Center Frequency (MHz)			5550			
Burst	Number of Pulses	Pulse Width (µsec)	Chirp Width (MHz)	Pulse 1-to-2 PRI (µsec)	Pulse 2-to-3 PRI (µsec)	Start Location Within Interval (msec)
1	1	82	9	--	--	172.917
2	1	59.3	9	--	--	608.461
3	2	89.6	9	1905	--	424.392
4	1	53.5	9	--	--	180.013
5	2	68.9	9	1503	--	348.334
6	2	97.5	9	1399	--	582.715
7	1	65.1	9	--	--	909.895
8	2	63.7	9	1299	--	873.616
9	2	57.5	9	1730	--	417.387
10	3	76.2	9	1237	1939	647.018
11	2	83.3	9	1928	--	781.609
Detection Check (Y=Detection; N=No Detection)						Y

Trial Number			23			
Bursts in Trial			15			
Center Frequency (MHz)			5550			
Burst	Number of Pulses	Pulse Width (µsec)	Chirp Width (MHz)	Pulse 1-to-2 PRI (µsec)	Pulse 2-to-3 PRI (µsec)	Start Location Within Interval (msec)
1	1	57.1	14	--	--	65.901
2	1	86.7	14	--	--	334.79
3	3	91.2	14	1464	1074	722.8
4	2	62.7	14	1790	--	317.33
5	3	80.8	14	1118	1285	129.98
6	2	84.3	14	1360	--	249.47
7	2	64.6	14	1038	--	25.27
8	2	79.1	14	1527	--	756.97
9	1	86.8	14	--	--	409.03
10	2	78.2	14	1256	--	668.58
11	3	50.4	14	1968	1182	306.55
12	2	55.9	14	1089	--	309.2
13	2	67.9	14	1084	--	236.1
14	3	85	14	1065	1119	168.6
15	2	78.1	14	1259	--	728.3
Detection Check (Y=Detection; N=No Detection)						Y

Trial Number			24			
Bursts in Trial			16			
Center Frequency (MHz)			5550			
Burst	Number of Pulses	Pulse Width (µsec)	Chirp Width (MHz)	Pulse 1-to-2 PRI (µsec)	Pulse 2-to-3 PRI (µsec)	Start Location Within Interval (msec)
1	2	64.7	6	1189	--	620.783
2	3	54.8	6	1622	1448	256.86
3	2	75.1	6	1284	--	23.87
4	1	71	6	--	--	303.19
5	3	88.2	6	1851	1581	385.32
6	1	75.6	6	--	--	597.77
7	2	75.6	6	1269	--	435.6
8	1	82.6	6	--	--	360.56
9	2	96.8	6	1761	--	77.78
10	2	58.1	6	1040	--	173.34
11	2	59.3	6	1366	--	737.85
12	3	98.3	6	1913	1459	603.56
13	3	80.2	6	1438	1558	374.67
14	3	78.3	6	1477	1776	335.3

15	3	82.7	6	1555	1484	146.8
16	3	56.2	6	1229	1598	79.4
Detection Check (Y=Detection; N=No Detection)						N

Trial Number		25				
Bursts in Trial		16				
Center Frequency (MHz)		5550				
Burst	Number of Pulses	Pulse Width (μsec)	Chirp Width (MHz)	Pulse 1-to-2 PRI (μsec)	Pulse 2-to-3 PRI (μsec)	Start Location Within Interval (msec)
1	3	54.5	7	1015	1238	429.994
2	1	80.7	7	--	--	679.08
3	3	70	7	1156	1260	249.98
4	1	56.2	7	--	--	719.15
5	1	61.1	7	--	--	527.59
6	2	78.2	7	1561	--	92.59
7	3	88.1	7	1583	1525	437.61
8	2	57	7	1883	--	39.85
9	1	84	7	--	--	411.41
10	3	86	7	1306	1025	189.06
11	1	77.4	7	--	--	606.17
12	1	93.7	7	--	--	431.02
13	2	54.8	7	1904	--	159.91
14	2	74.2	7	1678	--	147.02
15	2	93.7	7	1653	--	56.4
16	2	86.6	7	1395	--	355.2
Detection Check (Y=Detection; N=No Detection)						Y

Trial Number			26			
Bursts in Trial			19			
Center Frequency (MHz)			5550			
Burst	Number of Pulses	Pulse Width (µsec)	Chirp Width (MHz)	Pulse 1-to-2 PRI (µsec)	Pulse 2-to-3 PRI (µsec)	Start Location Within Interval (msec)
1	1	64.4	18	--	--	308.658
2	2	90.1	18	1488	--	373.081
3	2	86.6	18	1562	--	547.442
4	2	98.4	18	1568	--	139.593
5	2	50.6	18	1465	--	463.894
6	3	66.6	18	1313	1964	83.195
7	2	69.7	18	1977	--	136.706
8	3	51	18	1127	1391	393.717
9	2	57.6	18	1806	--	0.548
10	2	94.8	18	1198	--	469.749
11	2	87	18	1561	--	301.451
12	2	92.4	18	1357	--	62.642
13	2	78.6	18	1422	--	573.103
14	2	85.5	18	1778	--	33.424
15	3	94.5	18	1220	1042	392.475
16	2	57	18	1894	--	168.156
17	3	70	18	1275	1186	160.537
18	2	92.5	18	1694	--	458.758
19	3	89.3	18	1325	1258	311.379
Detection Check (Y=Detection; N=No Detection)						Y

Trial Number			27			
Bursts in Trial			11			
Center Frequency (MHz)			5550			
Burst	Number of Pulses	Pulse Width (µsec)	Chirp Width (MHz)	Pulse 1-to-2 PRI (µsec)	Pulse 2-to-3 PRI (µsec)	Start Location Within Interval (msec)
1	3	64	16	1368	1167	476.207
2	2	62.1	16	1444	--	524.961
3	1	86.2	16	--	--	337.732
4	2	58.5	16	1064	--	8.483
5	3	89.1	16	1071	1544	985.664
6	2	71.8	16	1683	--	770.295
7	2	64.2	16	1878	--	33.785
8	1	85.4	16	--	--	440.826
9	2	91.8	16	1552	--	1052.437
10	2	77.3	16	1498	--	467.118

11	2	77.9	16	1991	--	436.609
Detection Check (Y=Detection; N=No Detection)						N

Trial Number			28			
Bursts in Trial			19			
Center Frequency (MHz)			5550			
Burst	Number of Pulses	Pulse Width (μsec)	Chirp Width (MHz)	Pulse 1-to-2 PRI (μsec)	Pulse 2-to-3 PRI (μsec)	Start Location Within Interval (msec)
1	3	76.4	17	1347	1144	51.36
2	3	52.4	17	1992	1827	562.281
3	3	85.4	17	1786	1251	43.492
4	2	54.2	17	1282	--	130.973
5	3	83.6	17	1299	1137	613.204
6	2	96.3	17	1921	--	136.395
7	2	92	17	1825	--	343.526
8	2	80.6	17	1159	--	428.897
9	1	67.8	17	--	--	398.418
10	2	58.3	17	1413	--	208.519
11	1	81.9	17	--	--	618.001
12	2	55.6	17	1845	--	299.562
13	2	52.5	17	1827	--	284.473
14	2	99.8	17	1290	--	560.544
15	2	56.5	17	1607	--	396.155
16	1	70.8	17	--	--	506.436
17	2	80	17	1582	--	560.837
18	2	50	17	1957	--	334.158
19	1	86.5	17	--	--	129.179
Detection Check (Y=Detection; N=No Detection)						Y

Trial Number			29			
Bursts in Trial			11			
Center Frequency (MHz)			5550			
Burst	Number of Pulses	Pulse Width (μsec)	Chirp Width (MHz)	Pulse 1-to-2 PRI (μsec)	Pulse 2-to-3 PRI (μsec)	Start Location Within Interval (msec)
1	3	72.5	16	1326	1085	418.338
2	3	53.2	16	1255	1936	774.251
3	2	80.8	16	1517	--	84.442
4	3	52.8	16	1186	1080	587.603
5	3	88.6	16	1232	1276	343.594
6	2	57.3	16	1273	--	151.485
7	2	76.7	16	1543	--	524.595
8	2	78.2	16	1355	--	1037.786
9	3	63.2	16	1638	1805	377.997
10	3	65.6	16	1036	1727	298.618
11	1	97.1	16	--	--	86.409
Detection Check (Y=Detection; N=No Detection)						Y

5550MHz, Radar 6

Trial Id	Radar Type	Pulse Width(μ s)	PRI (μ s)	Pulses Per Hop	Hopping Rate (kHz)	Hopping Sequence Length (ms)	Visible Frequency Number	conclusion
0	6	1.0	333.3	9	0.3333	300.00	33	Y
1	6	1.0	333.3	9	0.3333	300.00	29	Y
2	6	1.0	333.3	9	0.3333	300.00	28	Y
3	6	1.0	333.3	9	0.3333	300.00	35	Y
4	6	1.0	333.3	9	0.3333	300.00	35	Y
5	6	1.0	333.3	9	0.3333	300.00	31	Y
6	6	1.0	333.3	9	0.3333	300.00	33	Y
7	6	1.0	333.3	9	0.3333	300.00	29	Y
8	6	1.0	333.3	9	0.3333	300.00	33	Y
9	6	1.0	333.3	9	0.3333	300.00	32	Y
10	6	1.0	333.3	9	0.3333	300.00	36	Y
11	6	1.0	333.3	9	0.3333	300.00	40	Y
12	6	1.0	333.3	9	0.3333	300.00	37	Y
13	6	1.0	333.3	9	0.3333	300.00	34	Y
14	6	1.0	333.3	9	0.3333	300.00	31	Y
15	6	1.0	333.3	9	0.3333	300.00	39	Y
16	6	1.0	333.3	9	0.3333	300.00	35	Y
17	6	1.0	333.3	9	0.3333	300.00	36	Y
18	6	1.0	333.3	9	0.3333	300.00	29	Y
19	6	1.0	333.3	9	0.3333	300.00	32	Y
20	6	1.0	333.3	9	0.3333	300.00	35	Y
21	6	1.0	333.3	9	0.3333	300.00	38	Y
22	6	1.0	333.3	9	0.3333	300.00	40	Y
23	6	1.0	333.3	9	0.3333	300.00	37	Y
24	6	1.0	333.3	9	0.3333	300.00	31	Y
25	6	1.0	333.3	9	0.3333	300.00	33	Y
26	6	1.0	333.3	9	0.3333	300.00	29	Y
27	6	1.0	333.3	9	0.3333	300.00	35	Y
28	6	1.0	333.3	9	0.3333	300.00	32	Y
29	6	1.0	333.3	9	0.3333	300.00	37	Y
Detection rate: 100%								

5610MHz, Radar 1

Trial Id	Radar Type	Pulse Width(μs)	PRI (μs)	Number of Pulses	Waveform Length (μs)	conclusion
0	1	1.0	938.0	57	53466.0	Y
1	1	1.0	698.0	76	53048.0	Y
2	1	1.0	618.0	86	53148.0	Y
3	1	1.0	538.0	99	53262.0	Y
4	1	1.0	878.0	61	53558.0	Y
5	1	1.0	3066.0	18	55188.0	Y
6	1	1.0	638.0	83	52954.0	Y
7	1	1.0	918.0	58	53244.0	Y
8	1	1.0	838.0	63	52794.0	Y
9	1	1.0	858.0	62	53196.0	Y
10	1	1.0	798.0	67	53466.0	Y
11	1	1.0	718.0	74	53132.0	Y
12	1	1.0	578.0	92	53176.0	Y
13	1	1.0	598.0	89	53222.0	Y
14	1	1.0	558.0	95	53010.0	Y
15	1	1.0	2536.0	21	53256.0	Y
16	1	1.0	966.0	55	53130.0	Y
17	1	1.0	827.0	64	52928.0	Y
18	1	1.0	2501.0	22	55022.0	Y
19	1	1.0	2595.0	21	54495.0	Y
20	1	1.0	1114.0	48	53472.0	Y
21	1	1.0	1302.0	41	53382.0	Y
22	1	1.0	3045.0	18	54810.0	Y
23	1	1.0	1624.0	33	53592.0	Y
24	1	1.0	2878.0	19	54682.0	Y
25	1	1.0	1027.0	52	53404.0	Y
26	1	1.0	2485.0	22	54670.0	Y
27	1	1.0	1600.0	33	52800.0	Y
28	1	1.0	1172.0	46	53912.0	Y
29	1	1.0	1177.0	45	52965.0	Y
Detection rate: 100%						

5610MHz, Radar 2

Trial Id	Radar Type	Pulse Width(μ s)	PRI (μ s)	Number of Pulses	Waveform Length (μ s)	conclusion
0	2	3.2	179.0	26	4654.0	Y
1	2	1.1	207.0	23	4761.0	Y
2	2	2.1	230.0	24	5520.0	Y
3	2	4.8	200.0	29	5800.0	Y
4	2	3.9	214.0	28	5992.0	Y
5	2	2.9	222.0	26	5772.0	Y
6	2	3.2	204.0	26	5304.0	Y
7	2	2.5	192.0	25	4800.0	Y
8	2	3.1	164.0	26	4264.0	Y
9	2	1.2	156.0	23	3588.0	Y
10	2	3.9	210.0	27	5670.0	Y
11	2	4.6	201.0	29	5829.0	Y
12	2	3.2	162.0	26	4212.0	Y
13	2	2.2	197.0	25	4925.0	Y
14	2	4.5	163.0	29	4727.0	Y
15	2	3.0	203.0	26	5278.0	Y
16	2	5.0	168.0	29	4872.0	Y
17	2	2.4	217.0	25	5425.0	Y
18	2	2.9	191.0	26	4966.0	Y
19	2	2.3	166.0	25	4150.0	Y
20	2	3.7	150.0	27	4050.0	Y
21	2	2.2	176.0	25	4400.0	Y
22	2	4.9	195.0	29	5655	Y
23	2	2.9	202.0	26	5252.0	Y
24	2	2.5	178.0	25	4450.0	Y
25	2	1.1	206.0	23	4738.0	Y
26	2	3.8	155.0	27	4185.0	Y
27	2	4.7	157.0	29	4553.0	Y
28	2	2.4	224.0	25	5600.0	Y
29	2	4.2	159.0	28	4452.0	Y
Detection rate: 100%						

5610MHz, Radar 3

Trial Id	Radar Type	Pulse Width(μ s)	PRI (μ s)	Number of Pulses	Waveform Length (μ s)	conclusion
0	3	8.2	355.0	17	6035.0	Y
1	3	6.1	487.0	16	7792.0	Y
2	3	7.1	344.0	16	5504.0	Y
3	3	9.8	288.0	18	5184.0	Y
4	3	8.9	230.0	18	4140.0	Y
5	3	7.9	432.0	17	7344.0	Y
6	3	8.2	207.0	17	3519.0	Y
7	3	7.5	443.0	17	7531.0	Y
8	3	8.1	439.0	17	7463.0	Y
9	3	6.2	223.0	16	3568.0	Y
10	3	8.9	208.0	18	3744.0	Y
11	3	9.6	463.0	18	8334.0	Y
12	3	8.2	441.0	17	7497.0	Y
13	3	7.2	323.0	16	5168.0	Y
14	3	9.5	297.0	18	5346.0	Y
15	3	8.0	412.0	17	7004.0	Y
16	3	10.0	324.0	18	5832.0	Y
17	3	7.4	271.0	17	4607.0	Y
18	3	7.9	349.0	17	5933.0	Y
19	3	7.3	409.0	16	6544.0	Y
20	3	8.7	373.0	18	6714.0	Y
21	3	7.2	254.0	16	4064.0	Y
22	3	9.9	274.0	18	4932.0	Y
23	3	7.9	278.0	17	4726.0	Y
24	3	7.5	317.0	17	5389.0	Y
25	3	6.1	260.0	16	4160.0	Y
26	3	8.8	211.0	18	3798.0	Y
27	3	9.7	272.0	18	4896.0	Y
28	3	7.4	264.0	17	4488.0	Y
29	3	9.2	284.0	18	5112.0	Y
Detection rate: 100%						

5610MHz, Radar 4

Trial Id	Radar Type	Pulse Width(μ s)	PRI (μ s)	Number of Pulses	Waveform Length (μ s)	conclusion
0	4	16.0	355.0	14	4970.0	Y
1	4	11.3	487.0	12	5844.0	Y
2	4	13.5	344.0	13	4472.0	Y
3	4	19.4	288.0	16	4608.0	Y
4	4	17.5	230.0	15	3450.0	Y
5	4	15.3	432.0	14	6048.0	Y
6	4	15.9	207.0	14	2898.0	Y
7	4	14.3	443.0	13	5759.0	Y
8	4	15.8	439.0	14	6146.0	Y
9	4	11.5	223.0	12	2676.0	Y
10	4	17.4	208.0	15	3120.0	Y
11	4	19.0	463.0	16	7408.0	Y
12	4	16.0	441.0	14	6174.0	Y
13	4	13.8	323.0	13	4199.0	Y
14	4	18.9	297.0	16	4752.0	Y
15	4	15.5	412.0	14	5768.0	Y
16	4	19.9	324.0	16	5184.0	Y
17	4	14.1	271.0	13	3523.0	Y
18	4	15.2	349.0	14	4886.0	Y
19	4	13.8	409.0	13	5317.0	Y
20	4	17.1	373.0	15	5595.0	Y
21	4	13.8	254.0	13	3302.0	Y
22	4	19.8	274.0	16	4384.0	Y
23	4	15.3	278.0	14	3892.0	Y
24	4	14.5	317.0	13	4121.0	Y
25	4	11.3	260.0	12	3120.0	Y
26	4	17.3	211.0	15	3165.0	Y
27	4	19.2	272.0	16	4352.0	Y
28	4	14.2	264.0	13	3432.0	Y
29	4	18.2	284.0	15	4260.0	Y
Detection rate: 100%						

5610MHz, Radar 5

Trial Id	Radar Type	Number of Pulses	Chirp Width (MHz)	Burst Period (s)	Waveform Length (μs)	Center Frequency (MHz)	conclusion
0	5	15	13	0.8000000	12.0	5.610	Y
1	5	8	19	1.5000000	12.0	5.610	Y
2	5	11	11	1.0909091	12.0	5.610	Y
3	5	20	12	0.6000000	12.0	5.610	Y
4	5	17	6	0.7058824	12.0	5.610	Y
5	5	14	15	0.8571429	12.0	5.610	Y
6	5	15	16	0.8000000	12.0	5.610	Y
7	5	12	17	1.0000000	12.0	5.610	Y
8	5	14	19	0.8571429	12.0	5.610	Y
9	5	8	12	1.5000000	12.0	5.610	Y
10	5	17	7	0.7058824	12.0	5.580	N
11	5	19	11	0.6315789	12.0	5.582	Y
12	5	15	14	0.8000000	12.0	5.579	Y
13	5	12	16	1.0000000	12.0	5.578	Y
14	5	19	9	0.6315789	12.0	5.581	Y
15	5	14	16	0.8571429	12.0	5.579	Y
16	5	20	13	0.6000000	12.0	5.582	Y
17	5	12	7	1.0000000	12.0	5.578	Y
18	5	14	10	0.8571429	12.0	5.579	Y
19	5	12	19	1.0000000	12.0	5.578	Y
20	5	16	12	0.7500000	12.0	5.640	Y
21	5	12	14	1.0000000	12.0	5.642	Y
22	5	20	9	0.6000000	12.0	5.638	Y
23	5	14	14	0.8571429	12.0	5.641	N
24	5	13	6	0.9230769	12.0	5.642	Y
25	5	8	7	1.5000000	12.0	5.644	Y
26	5	17	18	0.7058824	12.0	5.640	Y
27	5	19	16	0.6315789	12.0	5.638	Y
28	5	12	17	1.0000000	12.0	5.642	Y
29	5	18	16	0.6666667	12.0	5.639	Y

Detection rate: 93%

Trial Number			0			
Bursts in Trial			16			
Center Frequency (MHz)			5610			
Burst	Number of Pulses	Pulse Width (µsec)	Chirp Width (MHz)	Pulse 1-to-2 PRI (µsec)	Pulse 2-to-3 PRI (µsec)	Start Location Within Interval (msec)
1	1	71.5	13	--	--	382.157
2	1	73.2	13	--	--	537.38
3	1	95.5	13	--	--	301.44
4	2	88.4	13	1280	--	586.04
5	2	64.8	13	1624	--	322.44
6	1	77.3	13	--	--	33.47
7	2	64.3	13	1035	--	238.39
8	1	97.4	13	--	--	422.7
9	1	60.5	13	--	--	589.16
10	2	77.3	13	1797	--	269.82
11	1	60.3	13	--	--	14.29
12	1	99.3	13	--	--	734.54
13	2	65.1	13	1528	--	118.33
14	2	56.9	13	1137	--	496.3
15	1	86	13	--	--	208.7
16	1	83.5	13	--	--	545
Detection Check (Y=Detection; N=No Detection)						Y

Trial Number			1			
Bursts in Trial			12			
Center Frequency (MHz)			5610			
Burst	Number of Pulses	Pulse Width (µsec)	Chirp Width (MHz)	Pulse 1-to-2 PRI (µsec)	Pulse 2-to-3 PRI (µsec)	Start Location Within Interval (msec)
1	3	96.6	19	1441	1588	157.072
2	2	57	19	1003	--	31.84
3	1	99.4	19	--	--	593.46
4	3	51.4	19	1076	1207	174.33
5	3	71.5	19	1105	1860	53.87
6	2	99.5	19	1009	--	204.9
7	2	96.8	19	1888	--	972.89
8	2	62.8	19	1708	--	421.81
9	2	68.6	19	1979	--	675.92
10	1	52.2	19	--	--	905.33
11	2	71.2	19	1891	--	626.2
12	1	80.7	19	--	--	297.1
Detection Check (Y=Detection; N=No Detection)						Y

Trial Number			2			
Bursts in Trial			12			
Center Frequency (MHz)			5610			
Burst	Number of Pulses	Pulse Width (µsec)	Chirp Width (MHz)	Pulse 1-to-2 PRI (µsec)	Pulse 2-to-3 PRI (µsec)	Start Location Within Interval (msec)
1	2	73	11	1720	--	60.341
2	2	86.6	11	1086	--	471.34
3	2	52	11	1769	--	149.46
4	3	89.5	11	1050	1774	665.26
5	2	91.3	11	1275	--	763.12
6	1	87.6	11	--	--	242.46
7	2	95.7	11	1592	--	386.09
8	1	79.1	11	--	--	690.82
9	2	63	11	1026	--	448.47
10	3	78.5	11	1233	1434	781.34
11	2	71.4	11	1774	--	534
12	2	93.2	11	1268	--	689.3
Detection Check (Y=Detection; N=No Detection)						Y

Trial Number			3			
Bursts in Trial			15			
Center Frequency (MHz)			5610			
Burst	Number of Pulses	Pulse Width (µsec)	Chirp Width (MHz)	Pulse 1-to-2 PRI (µsec)	Pulse 2-to-3 PRI (µsec)	Start Location Within Interval (msec)
1	3	51.8	12	1987	1673	785.215
2	1	67.1	12	--	--	304.74
3	2	80.4	12	1189	--	234.53
4	2	57.2	12	1369	--	400.36
5	3	80.9	12	1841	1377	257.92
6	2	66.8	12	1850	--	641.28
7	2	78.3	12	1566	--	763.04
8	1	95.7	12	--	--	315.89
9	2	72.6	12	1987	--	694.91
10	2	86.1	12	1099	--	12.39
11	3	54.6	12	1547	1020	744.49
12	3	82.4	12	1778	1816	623.75
13	2	52.6	12	1943	--	704.1
14	3	88.8	12	1592	1140	155.2
15	2	91.6	12	1430	--	771.7
Detection Check (Y=Detection; N=No Detection)						Y

Trial Number			4			
Bursts in Trial			15			
Center Frequency (MHz)			5610			
Burst	Number of Pulses	Pulse Width (μsec)	Chirp Width (MHz)	Pulse 1-to-2 PRI (μsec)	Pulse 2-to-3 PRI (μsec)	Start Location Within Interval (msec)
1	2	91.5	6	1778	--	131.166
2	1	58.6	6	--	--	306.44
3	1	54.2	6	--	--	157.68
4	1	68.4	6	--	--	464.16
5	2	62.8	6	1467	--	725.57
6	1	90.9	6	--	--	277.06
7	1	93.9	6	--	--	278.94
8	2	67.7	6	1128	--	83.93
9	2	57.2	6	1328	--	324.65
10	2	77.5	6	1726	--	269.88
11	1	53.8	6	--	--	538.06
12	2	56.7	6	1884	--	731.59
13	3	50.7	6	1243	1550	206.21
14	2	86.2	6	1189	--	307.7
15	1	82.7	6	--	--	208.1
Detection Check (Y=Detection; N=No Detection)						Y

Trial Number			5			
Bursts in Trial			10			
Center Frequency (MHz)			5610			
Burst	Number of Pulses	Pulse Width (μsec)	Chirp Width (MHz)	Pulse 1-to-2 PRI (μsec)	Pulse 2-to-3 PRI (μsec)	Start Location Within Interval (msec)
1	1	90.1	15	--	--	1033.2
2	2	80.7	15	1532	--	510.9
3	1	99.6	15	--	--	454.39
4	1	50.8	15	--	--	577.37
5	1	60.7	15	--	--	101.54
6	3	90	15	1254	1217	724.3
7	2	89.1	15	1337	--	977.24
8	2	96.6	15	1506	--	497.64
9	1	76.3	15	--	--	19.63
10	1	55.9	15	--	--	793.8
Detection Check (Y=Detection; N=No Detection)						Y

Trial Number			6			
Bursts in Trial			16			
Center Frequency (MHz)			5610			
Burst	Number of Pulses	Pulse Width (µsec)	Chirp Width (MHz)	Pulse 1-to-2 PRI (µsec)	Pulse 2-to-3 PRI (µsec)	Start Location Within Interval (msec)
1	3	57.1	16	1529	1704	329.074
2	2	89.7	16	1153	--	181.929
3	1	57	16	--	--	661.73
4	3	76.3	16	1421	1729	676.54
5	2	85	16	1471	--	195.28
6	2	51.1	16	1777	--	133.14
7	2	87.4	16	1935	--	235.39
8	1	76.9	16	--	--	689.87
9	2	53.7	16	1406	--	108.86
10	1	63.5	16	--	--	298.5
11	2	71.6	16	1480	--	455.93
12	1	54.9	16	--	--	458.73
13	1	54.9	16	--	--	655.32
14	1	74.4	16	--	--	342.5
15	3	57.1	16	1803	1961	253.6
16	2	60.1	16	1173	--	626.3
Detection Check (Y=Detection; N=No Detection)						Y

Trial Number			7			
Bursts in Trial			10			
Center Frequency (MHz)			5610			
Burst	Number of Pulses	Pulse Width (µsec)	Chirp Width (MHz)	Pulse 1-to-2 PRI (µsec)	Pulse 2-to-3 PRI (µsec)	Start Location Within Interval (msec)
1	1	73.5	17	--	--	1027.02
2	1	89.6	17	--	--	288.87
3	2	96.4	17	1502	--	940.16
4	1	55.4	17	--	--	538.88
5	3	77.4	17	1678	1866	313.88
6	3	94.7	17	1377	1225	810.56
7	3	87.8	17	1040	1623	571.58
8	3	69.1	17	1265	1703	573.24
9	2	93.1	17	1526	--	732
10	2	84.2	17	1218	--	1135.7
Detection Check (Y=Detection; N=No Detection)						Y

Trial Number			8			
Bursts in Trial			17			
Center Frequency (MHz)			5610			
Burst	Number of Pulses	Pulse Width (μsec)	Chirp Width (MHz)	Pulse 1-to-2 PRI (μsec)	Pulse 2-to-3 PRI (μsec)	Start Location Within Interval (msec)
1	1	99.9	19	--	--	379.224
2	3	66.9	19	1884	1117	141.215
3	3	93.9	19	1541	1081	385.095
4	1	68.1	19	--	--	381.083
5	3	64.4	19	1524	1742	555.971
6	1	55.5	19	--	--	305.368
7	2	75.7	19	1657	--	524.546
8	2	79.3	19	1445	--	300.074
9	2	92.5	19	1739	--	217.191
10	1	53.5	19	--	--	379.719
11	1	76	19	--	--	408.816
12	2	90.7	19	1974	--	321.334
13	3	50	19	1043	1917	429.582
14	3	55.9	19	1721	1782	269.669
15	3	62.5	19	1735	1532	392.247
16	2	97.3	19	1930	--	543.265
17	3	64	19	1406	1172	103.082
Detection Check (Y=Detection; N=No Detection)						Y

Trial Number			9			
Bursts in Trial			8			
Center Frequency (MHz)			5610			
Burst	Number of Pulses	Pulse Width (μsec)	Chirp Width (MHz)	Pulse 1-to-2 PRI (μsec)	Pulse 2-to-3 PRI (μsec)	Start Location Within Interval (msec)
1	1	72.5	12	--	--	509.857
2	1	82.2	12	--	--	164.27
3	2	95.6	12	1652	--	1336.41
4	3	97.5	12	1913	1669	1403.44
5	3	56.8	12	1289	1286	1431.47
6	1	59.1	12	--	--	847.09
7	2	79.4	12	1668	--	1007.5
8	1	57	12	--	--	1064.5
Detection Check (Y=Detection; N=No Detection)						Y

Trial Number			10			
Bursts in Trial			17			
Center Frequency (MHz)			5610			
Burst	Number of Pulses	Pulse Width (μsec)	Chirp Width (MHz)	Pulse 1-to-2 PRI (μsec)	Pulse 2-to-3 PRI (μsec)	Start Location Within Interval (msec)
1	1	78.3	7	--	--	66.832
2	2	84.7	7	1277	--	533.498
3	3	66.8	7	1498	1487	363.275
4	3	85.1	7	1385	1978	101.033
5	3	50.6	7	1597	1042	240.291
6	2	70.9	7	1963	--	359.558
7	2	52.6	7	1254	--	587.176
8	1	99.2	7	--	--	324.064
9	1	99.4	7	--	--	661.481
10	1	60.8	7	--	--	618.299
11	1	98.1	7	--	--	161.846
12	3	71.3	7	1514	1297	681.744
13	1	71.1	7	--	--	57.432
14	1	64.2	7	--	--	614.609
15	3	94.2	7	1515	1757	3.997
16	2	90.2	7	1007	--	409.465
17	2	94.5	7	1152	--	96.682
Detection Check (Y=Detection; N=No Detection)						N

Trial Number			11			
Bursts in Trial			14			
Center Frequency (MHz)			5610			
Burst	Number of Pulses	Pulse Width (µsec)	Chirp Width (MHz)	Pulse 1-to-2 PRI (µsec)	Pulse 2-to-3 PRI (µsec)	Start Location Within Interval (msec)
1	1	56.2	11	--	--	837.948
2	3	97.4	11	1384	1150	805.177
3	1	82.6	11	--	--	108.874
4	2	81.2	11	1739	--	561.491
5	3	57.1	11	1500	1788	637.839
6	1	96.9	11	--	--	470.256
7	2	78.8	11	1644	--	186.843
8	2	55.2	11	1314	--	537.84
9	2	90.3	11	1517	--	210.307
10	2	86.8	11	1352	--	340.554
11	1	72	11	--	--	461.061
12	2	56.3	11	1749	--	109.089
13	2	77.1	11	1952	--	370.286
14	1	93.2	11	--	--	5.543
Detection Check (Y=Detection; N=No Detection)						Y

Trial Number			12			
Bursts in Trial			13			
Center Frequency (MHz)			5610			
Burst	Number of Pulses	Pulse Width (µsec)	Chirp Width (MHz)	Pulse 1-to-2 PRI (µsec)	Pulse 2-to-3 PRI (µsec)	Start Location Within Interval (msec)
1	3	95.8	14	1940	1066	135.166
2	2	96.9	14	1620	--	508.763
3	2	64.3	14	1609	--	877.786
4	3	97.1	14	1568	1125	354.559
5	2	69.8	14	1068	--	329.312
6	2	82	14	1940	--	103.175
7	2	97	14	1961	--	131.808
8	2	93.5	14	1084	--	199.242
9	3	59.3	14	1735	1223	244.985
10	2	54.1	14	1500	--	916.988
11	1	86.7	14	--	--	784.231
12	3	84.8	14	1763	1920	134.054
13	2	99.9	14	1595	--	885.077
Detection Check (Y=Detection; N=No Detection)						Y

Trial Number			13			
Bursts in Trial			12			
Center Frequency (MHz)			5610			
Burst	Number of Pulses	Pulse Width (µsec)	Chirp Width (MHz)	Pulse 1-to-2 PRI (µsec)	Pulse 2-to-3 PRI (µsec)	Start Location Within Interval (msec)
1	2	53	16	1035	--	758.419
2	2	94.5	16	1456	--	599.82
3	1	92.9	16	--	--	897.55
4	3	50.5	16	1461	1898	387.44
5	1	55.8	16	--	--	663.7
6	2	55.8	16	1153	--	876.84
7	1	96.8	16	--	--	258.85
8	2	57.6	16	1472	--	697.38
9	1	52.8	16	--	--	238.05
10	2	84.7	16	1477	--	269.11
11	2	92.9	16	1337	--	540.7
12	2	61.8	16	1878	--	662.5
Detection Check (Y=Detection; N=No Detection)						Y

Trial Number			14			
Bursts in Trial			12			
Center Frequency (MHz)			5610			
Burst	Number of Pulses	Pulse Width (µsec)	Chirp Width (MHz)	Pulse 1-to-2 PRI (µsec)	Pulse 2-to-3 PRI (µsec)	Start Location Within Interval (msec)
1	3	87.7	9	1289	1972	865.268
2	2	75.3	9	1086	--	643.12
3	3	61.7	9	1399	1818	607.79
4	1	84.4	9	--	--	423.86
5	2	80	9	1874	--	777.53
6	2	91.9	9	1107	--	742.23
7	3	80.6	9	1890	1876	467.68
8	1	52.4	9	--	--	420.12
9	1	65.8	9	--	--	764.91
10	1	88.1	9	--	--	921.18
11	2	97.7	9	1534	--	726
12	2	53.1	9	1425	--	270.3
Detection Check (Y=Detection; N=No Detection)						Y

Trial Number			15			
Bursts in Trial			16			
Center Frequency (MHz)			5610			
Burst	Number of Pulses	Pulse Width (μsec)	Chirp Width (MHz)	Pulse 1-to-2 PRI (μsec)	Pulse 2-to-3 PRI (μsec)	Start Location Within Interval (msec)
1	3	97.9	16	1023	1938	381.483
2	3	70.6	16	1507	1652	143.51
3	3	79.6	16	1185	1158	742.51
4	2	57.2	16	1657	--	694.15
5	2	61.8	16	1683	--	337.15
6	1	66.3	16	--	--	683.08
7	1	82.8	16	--	--	472.18
8	3	93.4	16	1072	1130	445.02
9	2	89.6	16	1646	--	593.37
10	3	94.1	16	1786	1020	448.75
11	1	66.7	16	--	--	26.17
12	2	58.1	16	1687	--	734.86
13	2	72.2	16	1767	--	337.55
14	3	69.4	16	1373	1948	365.9
15	2	90.3	16	1006	--	82.7
16	2	78.6	16	1093	--	219.7
Detection Check (Y=Detection; N=No Detection)						Y

Trial Number			16			
Bursts in Trial			20			
Center Frequency (MHz)			5610			
Burst	Number of Pulses	Pulse Width (µsec)	Chirp Width (MHz)	Pulse 1-to-2 PRI (µsec)	Pulse 2-to-3 PRI (µsec)	Start Location Within Interval (msec)
1	3	86.8	13	1633	1688	157.83
2	2	85.7	13	1004	--	161.457
3	2	68.1	13	1361	--	539.54
4	2	70.2	13	1542	--	410.24
5	3	60.2	13	1702	1157	148.84
6	1	53.2	13	--	--	367.52
7	3	60.5	13	1463	1735	451.72
8	2	93.9	13	1676	--	576.92
9	3	65.7	13	1695	1344	391.29
10	2	62.9	13	1065	--	220.07
11	3	93.5	13	1923	1287	303.52
12	2	75.6	13	1938	--	287.4
13	2	64.2	13	1300	--	193.44
14	3	83.3	13	1347	1628	380.54
15	1	65.3	13	--	--	504.53
16	1	54.3	13	--	--	38.58
17	3	67.7	13	1394	1690	206.63
18	3	80.2	13	1533	1199	278.5
19	1	52.8	13	--	--	418.4
20	1	51.8	13	--	--	522
Detection Check (Y=Detection; N=No Detection)						Y

Trial Number		17				
Bursts in Trial		12				
Center Frequency (MHz)		5610				
Burst	Number of Pulses	Pulse Width (µsec)	Chirp Width (MHz)	Pulse 1-to-2 PRI (µsec)	Pulse 2-to-3 PRI (µsec)	Start Location Within Interval (msec)
1	2	75.1	7	1527	--	378.064
2	1	52	7	--	--	894.91
3	3	86.1	7	1038	1823	566.72
4	2	87.3	7	1203	--	633.91
5	1	76.6	7	--	--	748.36
6	2	52.1	7	1428	--	938.9
7	1	80.2	7	--	--	916.04
8	2	84.9	7	1434	--	220.9
9	3	66	7	1680	1545	735.64
10	3	98.9	7	1069	1516	489.68
11	2	88.8	7	1462	--	6.6
12	2	83.7	7	1680	--	832.6
Detection Check (Y=Detection; N=No Detection)						Y

Trial Number		18				
Bursts in Trial		14				
Center Frequency (MHz)		5610				
Burst	Number of Pulses	Pulse Width (µsec)	Chirp Width (MHz)	Pulse 1-to-2 PRI (µsec)	Pulse 2-to-3 PRI (µsec)	Start Location Within Interval (msec)
1	3	79.3	10	1020	1017	192.931
2	1	62.2	10	--	--	96.667
3	3	83.7	10	1630	1335	273.514
4	2	53.7	10	1764	--	110.471
5	2	77.8	10	1592	--	263.819
6	2	60.9	10	1984	--	632.906
7	1	67.9	10	--	--	627.323
8	2	69.3	10	1449	--	368.52
9	2	64.3	10	1398	--	298.147
10	1	58.3	10	--	--	130.664
11	3	54	10	1917	1051	9.831
12	2	58.9	10	1493	--	454.209
13	2	75.9	10	1065	--	520.086
14	2	52.5	10	1808	--	280.443
Detection Check (Y=Detection; N=No Detection)						Y

Trial Number			19			
Bursts in Trial			18			
Center Frequency (MHz)			5610			
Burst	Number of Pulses	Pulse Width (µsec)	Chirp Width (MHz)	Pulse 1-to-2 PRI (µsec)	Pulse 2-to-3 PRI (µsec)	Start Location Within Interval (msec)
1	2	81.4	19	1665	--	379.976
2	2	98.8	19	1428	--	272.868
3	2	60.4	19	1371	--	570.017
4	2	97	19	1547	--	562.33
5	2	86.2	19	1951	--	145.103
6	3	79.4	19	1380	1824	78.747
7	3	88.9	19	1956	1288	310.78
8	2	65	19	1220	--	502.523
9	2	67.4	19	1831	--	239.657
10	3	57.6	19	1469	1682	12.3
11	1	51.4	19	--	--	612.783
12	1	65.1	19	--	--	70.597
13	2	58.8	19	1161	--	630.95
14	1	56.5	19	--	--	239.533
15	3	72.5	19	1697	1127	465.857
16	2	86	19	1139	--	25.3
17	3	82.8	19	1615	1859	279.433
18	3	63.2	19	1338	1480	607.867
Detection Check (Y=Detection; N=No Detection)						Y

Trial Number			20			
Bursts in Trial			16			
Center Frequency (MHz)			5610			
Burst	Number of Pulses	Pulse Width (µsec)	Chirp Width (MHz)	Pulse 1-to-2 PRI (µsec)	Pulse 2-to-3 PRI (µsec)	Start Location Within Interval (msec)
1	1	87.9	12	--	--	203.419
2	3	91.8	12	1177	1664	420.39
3	2	81.2	12	1861	--	263.57
4	3	69	12	1086	1723	420.04
5	3	71.3	12	1867	1451	255.33
6	2	66	12	1807	--	76.06
7	3	59.7	12	1364	1272	600.22
8	2	99.1	12	1254	--	491.16
9	3	76.3	12	1765	1703	475
10	2	74.7	12	1510	--	275.44
11	1	91.8	12	--	--	108
12	3	78	12	1049	1889	264.44

13	2	56.7	12	1249	--	224.56
14	2	78.3	12	1730	--	164.37
15	2	80.3	12	1064	--	105.5
16	2	95.9	12	1232	--	642.7
Detection Check (Y=Detection; N=No Detection)						Y

Trial Number			21			
Bursts in Trial			11			
Center Frequency (MHz)			5610			
Burst	Number of Pulses	Pulse Width (μsec)	Chirp Width (MHz)	Pulse 1-to-2 PRI (μsec)	Pulse 2-to-3 PRI (μsec)	Start Location Within Interval (msec)
1	2	78.3	14	1107	--	328.895
2	2	90.5	14	1373	--	193.381
3	2	52.1	14	1732	--	90.162
4	2	83.4	14	1217	--	576.633
5	2	99.9	14	1450	--	434.734
6	3	80.9	14	1048	1373	344.525
7	2	96.3	14	1883	--	6.815
8	1	58.1	14	--	--	927.796
9	1	71.2	14	--	--	210.757
10	1	66.5	14	--	--	480.218
11	3	94.5	14	1844	1097	523.709
Detection Check (Y=Detection; N=No Detection)						Y

Trial Number			22			
Bursts in Trial			11			
Center Frequency (MHz)			5610			
Burst	Number of Pulses	Pulse Width (μsec)	Chirp Width (MHz)	Pulse 1-to-2 PRI (μsec)	Pulse 2-to-3 PRI (μsec)	Start Location Within Interval (msec)
1	1	82	9	--	--	172.917
2	1	59.3	9	--	--	608.461
3	2	89.6	9	1905	--	424.392
4	1	53.5	9	--	--	180.013
5	2	68.9	9	1503	--	348.334
6	2	97.5	9	1399	--	582.715
7	1	65.1	9	--	--	909.895
8	2	63.7	9	1299	--	873.616
9	2	57.5	9	1730	--	417.387
10	3	76.2	9	1237	1939	647.018
11	2	83.3	9	1928	--	781.609
Detection Check (Y=Detection; N=No Detection)						Y

Trial Number			23			
Bursts in Trial			15			
Center Frequency (MHz)			5610			
Burst	Number of Pulses	Pulse Width (μsec)	Chirp Width (MHz)	Pulse 1-to-2 PRI (μsec)	Pulse 2-to-3 PRI (μsec)	Start Location Within Interval (msec)
1	1	57.1	14	--	--	65.901
2	1	86.7	14	--	--	334.79
3	3	91.2	14	1464	1074	722.8
4	2	62.7	14	1790	--	317.33
5	3	80.8	14	1118	1285	129.98
6	2	84.3	14	1360	--	249.47
7	2	64.6	14	1038	--	25.27
8	2	79.1	14	1527	--	756.97
9	1	86.8	14	--	--	409.03
10	2	78.2	14	1256	--	668.58
11	3	50.4	14	1968	1182	306.55
12	2	55.9	14	1089	--	309.2
13	2	67.9	14	1084	--	236.1
14	3	85	14	1065	1119	168.6
15	2	78.1	14	1259	--	728.3
Detection Check (Y=Detection; N=No Detection)						N

Trial Number			24			
Bursts in Trial			16			
Center Frequency (MHz)			5610			
Burst	Number of Pulses	Pulse Width (μsec)	Chirp Width (MHz)	Pulse 1-to-2 PRI (μsec)	Pulse 2-to-3 PRI (μsec)	Start Location Within Interval (msec)
1	2	64.7	6	1189	--	620.783
2	3	54.8	6	1622	1448	256.86
3	2	75.1	6	1284	--	23.87
4	1	71	6	--	--	303.19
5	3	88.2	6	1851	1581	385.32
6	1	75.6	6	--	--	597.77
7	2	75.6	6	1269	--	435.6
8	1	82.6	6	--	--	360.56
9	2	96.8	6	1761	--	77.78
10	2	58.1	6	1040	--	173.34
11	2	59.3	6	1366	--	737.85
12	3	98.3	6	1913	1459	603.56
13	3	80.2	6	1438	1558	374.67
14	3	78.3	6	1477	1776	335.3

15	3	82.7	6	1555	1484	146.8
16	3	56.2	6	1229	1598	79.4
Detection Check (Y=Detection; N=No Detection)						Y

Trial Number		25				
Bursts in Trial		16				
Center Frequency (MHz)		5610				
Burst	Number of Pulses	Pulse Width (µsec)	Chirp Width (MHz)	Pulse 1-to-2 PRI (µsec)	Pulse 2-to-3 PRI (µsec)	Start Location Within Interval (msec)
1	3	54.5	7	1015	1238	429.994
2	1	80.7	7	--	--	679.08
3	3	70	7	1156	1260	249.98
4	1	56.2	7	--	--	719.15
5	1	61.1	7	--	--	527.59
6	2	78.2	7	1561	--	92.59
7	3	88.1	7	1583	1525	437.61
8	2	57	7	1883	--	39.85
9	1	84	7	--	--	411.41
10	3	86	7	1306	1025	189.06
11	1	77.4	7	--	--	606.17
12	1	93.7	7	--	--	431.02
13	2	54.8	7	1904	--	159.91
14	2	74.2	7	1678	--	147.02
15	2	93.7	7	1653	--	56.4
16	2	86.6	7	1395	--	355.2
Detection Check (Y=Detection; N=No Detection)						Y

Trial Number			26			
Bursts in Trial			19			
Center Frequency (MHz)			5610			
Burst	Number of Pulses	Pulse Width (µsec)	Chirp Width (MHz)	Pulse 1-to-2 PRI (µsec)	Pulse 2-to-3 PRI (µsec)	Start Location Within Interval (msec)
1	1	64.4	18	--	--	308.658
2	2	90.1	18	1488	--	373.081
3	2	86.6	18	1562	--	547.442
4	2	98.4	18	1568	--	139.593
5	2	50.6	18	1465	--	463.894
6	3	66.6	18	1313	1964	83.195
7	2	69.7	18	1977	--	136.706
8	3	51	18	1127	1391	393.717
9	2	57.6	18	1806	--	0.548
10	2	94.8	18	1198	--	469.749
11	2	87	18	1561	--	301.451
12	2	92.4	18	1357	--	62.642
13	2	78.6	18	1422	--	573.103
14	2	85.5	18	1778	--	33.424
15	3	94.5	18	1220	1042	392.475
16	2	57	18	1894	--	168.156
17	3	70	18	1275	1186	160.537
18	2	92.5	18	1694	--	458.758
19	3	89.3	18	1325	1258	311.379
Detection Check (Y=Detection; N=No Detection)						Y

Trial Number			27			
Bursts in Trial			11			
Center Frequency (MHz)			5610			
Burst	Number of Pulses	Pulse Width (µsec)	Chirp Width (MHz)	Pulse 1-to-2 PRI (µsec)	Pulse 2-to-3 PRI (µsec)	Start Location Within Interval (msec)
1	3	64	16	1368	1167	476.207
2	2	62.1	16	1444	--	524.961
3	1	86.2	16	--	--	337.732
4	2	58.5	16	1064	--	8.483
5	3	89.1	16	1071	1544	985.664
6	2	71.8	16	1683	--	770.295
7	2	64.2	16	1878	--	33.785
8	1	85.4	16	--	--	440.826
9	2	91.8	16	1552	--	1052.437
10	2	77.3	16	1498	--	467.118

11	2	77.9	16	1991	--	436.609
Detection Check (Y=Detection; N=No Detection)						Y

Trial Number			28			
Bursts in Trial			19			
Center Frequency (MHz)			5610			
Burst	Number of Pulses	Pulse Width (μsec)	Chirp Width (MHz)	Pulse 1-to-2 PRI (μsec)	Pulse 2-to-3 PRI (μsec)	Start Location Within Interval (msec)
1	3	76.4	17	1347	1144	51.36
2	3	52.4	17	1992	1827	562.281
3	3	85.4	17	1786	1251	43.492
4	2	54.2	17	1282	--	130.973
5	3	83.6	17	1299	1137	613.204
6	2	96.3	17	1921	--	136.395
7	2	92	17	1825	--	343.526
8	2	80.6	17	1159	--	428.897
9	1	67.8	17	--	--	398.418
10	2	58.3	17	1413	--	208.519
11	1	81.9	17	--	--	618.001
12	2	55.6	17	1845	--	299.562
13	2	52.5	17	1827	--	284.473
14	2	99.8	17	1290	--	560.544
15	2	56.5	17	1607	--	396.155
16	1	70.8	17	--	--	506.436
17	2	80	17	1582	--	560.837
18	2	50	17	1957	--	334.158
19	1	86.5	17	--	--	129.179
Detection Check (Y=Detection; N=No Detection)						Y

Trial Number			29			
Bursts in Trial			11			
Center Frequency (MHz)			5610			
Burst	Number of Pulses	Pulse Width (μsec)	Chirp Width (MHz)	Pulse 1-to-2 PRI (μsec)	Pulse 2-to-3 PRI (μsec)	Start Location Within Interval (msec)
1	3	72.5	16	1326	1085	418.338
2	3	53.2	16	1255	1936	774.251
3	2	80.8	16	1517	--	84.442
4	3	52.8	16	1186	1080	587.603
5	3	88.6	16	1232	1276	343.594
6	2	57.3	16	1273	--	151.485
7	2	76.7	16	1543	--	524.595
8	2	78.2	16	1355	--	1037.786
9	3	63.2	16	1638	1805	377.997
10	3	65.6	16	1036	1727	298.618
11	1	97.1	16	--	--	86.409
Detection Check (Y=Detection; N=No Detection)						Y

5610MHz, Radar 6

Trial Id	Radar Type	Pulse Width(μ s)	PRI (μ s)	Pulses Per Hop	Hopping Rate (kHz)	Hopping Sequence Length (ms)	Visible Frequency Number	conclusion
0	6	1.0	333.3	9	0.3333	300.00	33	Y
1	6	1.0	333.3	9	0.3333	300.00	29	Y
2	6	1.0	333.3	9	0.3333	300.00	28	Y
3	6	1.0	333.3	9	0.3333	300.00	35	Y
4	6	1.0	333.3	9	0.3333	300.00	35	Y
5	6	1.0	333.3	9	0.3333	300.00	31	Y
6	6	1.0	333.3	9	0.3333	300.00	33	Y
7	6	1.0	333.3	9	0.3333	300.00	29	Y
8	6	1.0	333.3	9	0.3333	300.00	33	Y
9	6	1.0	333.3	9	0.3333	300.00	32	Y
10	6	1.0	333.3	9	0.3333	300.00	36	Y
11	6	1.0	333.3	9	0.3333	300.00	40	Y
12	6	1.0	333.3	9	0.3333	300.00	37	Y
13	6	1.0	333.3	9	0.3333	300.00	34	Y
14	6	1.0	333.3	9	0.3333	300.00	31	Y
15	6	1.0	333.3	9	0.3333	300.00	39	Y
16	6	1.0	333.3	9	0.3333	300.00	35	Y
17	6	1.0	333.3	9	0.3333	300.00	36	Y
18	6	1.0	333.3	9	0.3333	300.00	29	Y
19	6	1.0	333.3	9	0.3333	300.00	32	Y
20	6	1.0	333.3	9	0.3333	300.00	35	Y
21	6	1.0	333.3	9	0.3333	300.00	38	Y
22	6	1.0	333.3	9	0.3333	300.00	40	Y
23	6	1.0	333.3	9	0.3333	300.00	37	Y
24	6	1.0	333.3	9	0.3333	300.00	31	Y
25	6	1.0	333.3	9	0.3333	300.00	33	Y
26	6	1.0	333.3	9	0.3333	300.00	29	Y
27	6	1.0	333.3	9	0.3333	300.00	35	Y
28	6	1.0	333.3	9	0.3333	300.00	32	Y
29	6	1.0	333.3	9	0.3333	300.00	37	Y

Detection rate: 100%

6. Main Test Instruments

Name	Manufacturer	Type	Serial Number	Calibration Date	Expiration Date
Vector Signal Generator	KEYSIGHT	N5172B	MY53050900	2022-12-10	2023-12-09
Spectrum Analyzer	Agilent	N9010A	MY50210259	2022-12-10	2023-12-09
Wireless Network Adapter	Intel	AX200NGW	G86C0007U410	/	/

*****END OF REPORT *****

ANNEX A: The EUT Appearance

The EUT Appearance is submitted separately.

ANNEX B: Test Setup Photos

The Test Setup Photos is submitted separately.