

TEST REPORT

Application No.: SEWM2207000133RG
Applicant: Quectel Wireless Solutions Co., Ltd
Address of Applicant: Building 5, Shanghai Business Park Phase III (Area B), No.1016 Tianlin Road, Minhang District, Shanghai, China 200233
Manufacturer: Quectel Wireless Solutions Co., Ltd
Address of Manufacturer: Building 5, Shanghai Business Park Phase III (Area B), No.1016 Tianlin Road, Minhang District, Shanghai, China 200233
EUT Description: Smart Module
Model No.: SA800U-WF
Trade Mark: QUECTEL
FCC ID: XMR2022SA800UWF
Standards: FCC 47 CFR Part 2, Subpart J
 FCC 47 CFR Part 15, Subpart C
Date of Receipt: 2022/08/09
Date of Test: 2022/08/15 to 2022/09/02
Date of Issue: 2022/09/06

Test Result :	PASS *
----------------------	---------------

* In the configuration tested, the EUT detailed in this report complied with the standards specified above.

Authorized Signature:

Panta Sun
 Wireless Laboratory Manager



Unless otherwise agreed in writing, this document is issued by the Company subject to its General Conditions of Service printed overleaf, available on request or accessible at <http://www.sgs.com/en/Terms-and-Conditions.aspx> and, for electronic format documents, subject to Terms and Conditions for Electronic Documents at <http://www.sgs.com/en/Terms-and-Conditions/Terms-e-Documents.aspx>. Attention is drawn to the limitation of liability, indemnification and jurisdiction issues defined therein. Any holder of this document is advised that information contained hereon reflects the Company's findings at the time of its intervention only and within the limits of Client's instructions, if any. The Company's sole responsibility is to its Client and this document does not exonerate parties to a transaction from exercising all their rights and obligations under the transaction documents. This document cannot be reproduced except in full, without prior written approval of the Company. Any unauthorized alteration, forgery or falsification of the content or appearance of this document is unlawful and offenders may be prosecuted to the fullest extent of the law. Unless otherwise stated the results shown in this test report refer only to the sample(s) tested and such sample(s) are retained for 30 days only.
Attention: To check the authenticity of testing/inspection report & certificate, please contact us at telephone: (86-755) 8307 1443, or email: CN.Doccheck@sgs.com
 South of No. 6 Plant, No. 1, Runsheng Road, Suzhou Industrial Park, Suzhou Area, China (Jiangsu) Pilot Free Trade Zone 215000 t (86-512) 62992980 www.sgs.com.cn
 中国·苏州·中国(江苏)自由贸易试验区苏州片区苏州工业园区润胜路1号的6号厂房南楼 邮编: 215000 t (86-512) 62992980 sgs.china@sgs.com

1 Version

Revision Record				
Version	Chapter	Date	Modifier	Remark
01		2022/09/06		Original

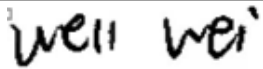
Prepared By		 <hr/> (Tizy Song) / Test Engineer
Checked By		 <hr/> (Well Wei) / Reviewer



Unless otherwise agreed in writing, this document is issued by the Company subject to its General Conditions of Service printed overleaf, available on request or accessible at <http://www.sgs.com/en/Terms-and-Conditions.aspx> and, for electronic format documents, subject to Terms and Conditions for Electronic Documents at <http://www.sgs.com/en/Terms-and-Conditions/Terms-e-Documents.aspx>. Attention is drawn to the limitation of liability, indemnification and jurisdiction issues defined therein. Any holder of this document is advised that information contained hereon reflects the Company's findings at the time of its intervention only and within the limits of Client's instructions, if any. The Company's sole responsibility is to its Client and this document does not exonerate parties to a transaction from exercising all their rights and obligations under the transaction documents. This document cannot be reproduced except in full, without prior written approval of the Company. Any unauthorized alteration, forgery or falsification of the content or appearance of this document is unlawful and offenders may be prosecuted to the fullest extent of the law. Unless otherwise stated the results shown in this test report refer only to the sample(s) tested and such sample(s) are retained for 30 days only.

Attention: To check the authenticity of testing/inspection report & certificate, please contact us at telephone: (86-755) 8307 1443, or email: CN.Doccheck@sgs.com

2 Test Summary

Test Item	FCC Rule No.	Test Method	Test Result	Result
Antenna Requirement	15.203/15.247(b)	--	Clause 4.1	PASS
AC Power Line Conducted Emission	15.207	ANSI C63.10 2013 Section 6.2	Clause 4.2	PASS
Conducted Output Power	15.247 (b)(3)	ANSI C63.10 2013 Section 11.9.2.3	Clause 4.4	PASS
DTS (6 dB) Bandwidth & 99% Occupied Bandwidth	15.247 (a)(2)	ANSI C63.10 2013 Section 11.8 Option 2 / 6.9.3	Clause 4.5	PASS
Power Spectral Density	15.247 (e)	ANSI C63.10 2013 Section 11.10.2	Clause 4.6	PASS
Band-edge for RF Conducted Emissions	15.247(d)	ANSI C63.10 2013 Section 11.11	Clause 4.7	PASS
RF Conducted Spurious Emissions	15.247(d)	ANSI C63.10 2013 Section 11.11	Clause 4.8	PASS
Radiated Spurious Emissions	15.205/15.209	ANSI C63.10 2013 Section 11.12	Clause 4.9	PASS
Restricted bands around fundamental frequency (Radiated Emission)	15.205/15.209	ANSI C63.10 2013 Section 11.12	Clause 4.10	PASS



Unless otherwise agreed in writing, this document is issued by the Company subject to its General Conditions of Service printed overleaf, available on request or accessible at <http://www.sgs.com/en/Terms-and-Conditions.aspx> and, for electronic format documents, subject to Terms and Conditions for Electronic Documents at <http://www.sgs.com/en/Terms-and-Conditions/Terms-e-Documents.aspx>. Attention is drawn to the limitation of liability, indemnification and jurisdiction issues defined therein. Any holder of this document is advised that information contained hereon reflects the Company's findings at the time of its intervention only and within the limits of Client's instructions, if any. The Company's sole responsibility is to its Client and this document does not exonerate parties to a transaction from exercising all their rights and obligations under the transaction documents. This document cannot be reproduced except in full, without prior written approval of the Company. Any unauthorized alteration, forgery or falsification of the content or appearance of this document is unlawful and offenders may be prosecuted to the fullest extent of the law. Unless otherwise stated the results shown in this test report refer only to the sample(s) tested and such sample(s) are retained for 30 days only.

Attention: To check the authenticity of testing/inspection report & certificate, please contact us at telephone: (86-755) 8307 1443, or email: CN.Doccheck@sgs.com

South of No. 6 Plant, No. 1, Runsheng Road, Suzhou Industrial Park, Suzhou Area, China (Jiangsu) Pilot Free Trade Zone 215000
 中国·苏州·中国(江苏)自由贸易试验区苏州片区苏州工业园区润胜路1号的6号厂房南楼 邮编: 215000

t (86-512) 62992980 www.sgs.com.cn
 s (86-512) 62992980 sgs.china@sgs.com

Contents

1	Version	2
2	Test Summary	3
3	General Information	5
3.1	Details of Client	5
3.2	Test Location	5
3.3	Test Facility	5
3.4	General Description of EUT	6
3.5	Test Environment	8
3.6	Description of Support Units	8
4	Test results and Measurement Data	9
4.1	Antenna Requirement	9
4.2	AC Power Line Conducted Emissions	10
4.3	Duty Cycle	16
4.4	Conducted Output Power	17
4.5	DTS (6 dB) Bandwidth & 99% Occupied Bandwidth	18
4.6	Power Spectral Density	19
4.7	Band-edge for RF Conducted Emissions	20
4.8	RF Conducted Spurious Emissions	21
4.9	Radiated Spurious Emissions	22
4.10	Restricted bands around fundamental frequency	25
5	Measurement Uncertainty (95% confidence levels, k=2)	27
6	Equipment List	28
7	Photographs - Setup Photos	30



Unless otherwise agreed in writing, this document is issued by the Company subject to its General Conditions of Service printed overleaf, available on request or accessible at <http://www.sgs.com/en/Terms-and-Conditions.aspx> and, for electronic format documents, subject to Terms and Conditions for Electronic Documents at <http://www.sgs.com/en/Terms-and-Conditions/Terms-e-Documents.aspx>. Attention is drawn to the limitation of liability, indemnification and jurisdiction issues defined therein. Any holder of this document is advised that information contained hereon reflects the Company's findings at the time of its intervention only and within the limits of Client's instructions, if any. The Company's sole responsibility is to its Client and this document does not exonerate parties to a transaction from exercising all their rights and obligations under the transaction documents. This document cannot be reproduced except in full, without prior written approval of the Company. Any unauthorized alteration, forgery or falsification of the content or appearance of this document is unlawful and offenders may be prosecuted to the fullest extent of the law. Unless otherwise stated the results shown in this test report refer only to the sample(s) tested and such sample(s) are retained for 30 days only.
Attention: To check the authenticity of testing /inspection report & certificate, please contact us at telephone: (86-755) 8307 1443, or email: CN.Doccheck@sgs.com

SGS-CSTC Standards Technical Services (Suzhou) Co., Ltd.
 Wireless Laboratory

South of No. 6 Plant, No. 1, Runsheng Road, Suzhou Industrial Park, Suzhou Area, China (Jiangsu) Pilot Free Trade Zone 215000 t (86-512) 62992980 www.sgs.com.cn
 中国·苏州·中国(江苏)自由贸易试验区苏州片区苏州工业园区润胜路1号的6号厂房南楼 邮编: 215000 t (86-512) 62992980 sgs.china@sgs.com

Report No.: SEWM2207000133RG02
 Rev.: 01
 Page: 5 of 79

3 General Information

3.1 Details of Client

Applicant:	Quectel Wireless Solutions Co., Ltd
Address of Applicant:	Building 5, Shanghai Business Park Phase III (Area B), No.1016 Tianlin Road, Minhang District, Shanghai, China 200233
Manufacturer:	Quectel Wireless Solutions Co., Ltd
Address of Manufacturer:	Building 5, Shanghai Business Park Phase III (Area B), No.1016 Tianlin Road, Minhang District, Shanghai, China 200233

3.2 Test Location

Company:	SGS-CSTC Standards Technical Services (Suzhou) Co., Ltd.
Address:	South of No. 6 Plant, No. 1, Runsheng Road, Suzhou Industrial Park, Suzhou Area, China (Jiangsu) Pilot Free Trade Zone
Post code:	215000
Test engineer:	Lves Cheng, Tizzy Song

3.3 Test Facility

The test facility is recognized, certified, or accredited by the following organizations:

<ul style="list-style-type: none"> A2LA (Certificate No. 6336.01) SGS-CSTC STANDARDS TECHNICAL SERVICES (SUZHOU) CO., LTD. is accredited by the American Association for Laboratory Accreditation(A2LA). Certificate No. 6336.01. Innovation, Science and Economic Development Canada SGS-CSTC STANDARDS TECHNICAL SERVICES (SUZHOU) CO., LTD. has been recognized by ISED as an accredited testing laboratory. CAB identifier: CN0120. IC#: 27594. FCC –Designation Number: CN1312 SGS-CSTC STANDARDS TECHNICAL SERVICES (SUZHOU) CO., LTD. has been recognized as an accredited testing laboratory. Designation Number: CN1312. Test Firm Registration Number: 717327



Unless otherwise agreed in writing, this document is issued by the Company subject to its General Conditions of Service printed overleaf, available on request or accessible at <http://www.sgs.com/en/Terms-and-Conditions.aspx> and, for electronic format documents, subject to Terms and Conditions for Electronic Documents at <http://www.sgs.com/en/Terms-and-Conditions/Terms-e-Documents.aspx>. Attention is drawn to the limitation of liability, indemnification and jurisdiction issues defined therein. Any holder of this document is advised that information contained hereon reflects the Company's findings at the time of its intervention only and within the limits of Client's instructions, if any. The Company's sole responsibility is to its Client and this document does not exonerate parties to a transaction from exercising all their rights and obligations under the transaction documents. This document cannot be reproduced except in full, without prior written approval of the Company. Any unauthorized alteration, forgery or falsification of the content or appearance of this document is unlawful and offenders may be prosecuted to the fullest extent of the law. Unless otherwise stated the results shown in this test report refer only to the sample(s) tested and such sample(s) are retained for 30 days only.
Attention: To check the authenticity of testing /inspection report & certificate, please contact us at telephone: (86-755) 8307 1443, or email: CN.Doccheck@sgs.com
 South of No. 6 Plant, No. 1, Runsheng Road, Suzhou Industrial Park, Suzhou Area, China (Jiangsu) Pilot Free Trade Zone 215000 t (86-512) 62992980 www.sgs.com.cn
 中国·苏州·中国(江苏)自由贸易试验区苏州片区苏州工业园区润胜路1号的6号厂房南楼 邮编: 215000 t (86-512) 62992980 sgs.china@sgs.com

3.4 General Description of EUT

EUT Description:	Smart Module	
Model No.:	SA800U-WF	
Trade Mark:	QUECTEL	
Hardware Version:	R1.0	
Software Version:	SA800UWFPAR01A06	
SN:	RF Conducted	P1C20LH18000327
	RSE & AC power line	P1C20LH18000832
Operation Frequency:	2400MHz~2483.5MHz $f_c = 2402 \text{ MHz} + N * 2 \text{ MHz}$, where: - f_c = "Operating Frequency" in MHz, - N = "Channel Number" with the range from 0 to 39.	
Bluetooth version:	Bluetooth V5.0	
Modulation Type:	GFSK	
Number of Channel:	40	
Rates Type*:	<input checked="" type="checkbox"/> Provided by client	
	1M PHY	2M PHY
Antenna Type:	PCB Antenna	
Antenna Gain:	4.61dBi(Ant1)	
	Note: The antenna gain are derived from the gain information report provided by the manufacturer.	
RF Cable:	0.5dB	
Note: *Since the above data and/or information is provided by the client relevant results or conclusions of this report are only made for these data and/or information, SGS is not responsible for the authenticity, integrity and results of the data and information and/or the validity of the conclusion. Remark: As above information is provided and confirmed by the applicant. SGS is not liable to the accuracy, suitability, reliability or/and integrity of the information.		



Operation Frequency of each channel							
Channel	Frequency	Channel	Frequency	Channel	Frequency	Channel	Frequency
0	2402MHz	10	2422MHz	20	2442MHz	30	2462MHz
1	2404MHz	11	2424MHz	21	2444MHz	31	2464MHz
2	2406MHz	12	2426MHz	22	2446MHz	32	2466MHz
3	2408MHz	13	2428MHz	23	2448MHz	33	2468MHz
4	2410MHz	14	2430MHz	24	2450MHz	34	2470MHz
5	2412MHz	15	2432MHz	25	2452MHz	35	2472MHz
6	2414MHz	16	2434MHz	26	2454MHz	36	2474MHz
7	2416MHz	17	2436MHz	27	2456MHz	37	2476MHz
8	2418MHz	18	2438MHz	28	2458MHz	38	2478MHz
9	2420MHz	19	2440MHz	29	2460MHz	39	2480MHz

Remark:

In section 15.31(m), regards to the operating frequency range over 10 MHz, the Lowest frequency, the middle frequency, and the highest frequency of channel were selected to perform the test, and the selected channel see below:

Channel	Frequency
The Lowest channel(CH0)	2402MHz
The Middle channel(CH19)	2440MHz
The Highest channel(CH39)	2480MHz



Unless otherwise agreed in writing, this document is issued by the Company subject to its General Conditions of Service printed overleaf, available on request or accessible at <http://www.sgs.com/en/Terms-and-Conditions.aspx> and, for electronic format documents, subject to Terms and Conditions for Electronic Documents at <http://www.sgs.com/en/Terms-and-Conditions/Terms-e-Documents.aspx>. Attention is drawn to the limitation of liability, indemnification and jurisdiction issues defined therein. Any holder of this document is advised that information contained hereon reflects the Company's findings at the time of its intervention only and within the limits of Client's instructions, if any. The Company's sole responsibility is to its Client and this document does not exonerate parties to a transaction from exercising all their rights and obligations under the transaction documents. This document cannot be reproduced except in full, without prior written approval of the Company. Any unauthorized alteration, forgery or falsification of the content or appearance of this document is unlawful and offenders may be prosecuted to the fullest extent of the law. Unless otherwise stated the results shown in this test report refer only to the sample(s) tested and such sample(s) are retained for 30 days only.
Attention: To check the authenticity of testing /inspection report & certificate, please contact us at telephone: (86-755) 8307 1443, or email: CN.Doccheck@sgs.com

South of No. 6 Plant, No. 1, Runsheng Road, Suzhou Industrial Park, Suzhou Area, China (Jiangsu) Pilot Free Trade Zone 215000 t (86-512) 62992980 www.sgs.com.cn
 中国·苏州·中国(江苏)自由贸易试验区苏州片区苏州工业园区润胜路1号的6号厂房南楼 邮编: 215000 t (86-512) 62992980 sgs.china@sgs.com

Report No.: SEWM2207000133RG02
 Rev.: 01
 Page: 8 of 79

3.5 Test Environment

Environment Parameter	101.0 kPa Selected Values During Tests	
Relative Humidity	44-46 % RH Ambient	
Value	Temperature(°C)	Voltage(V)
NTNV	22~23	3.8
Remark: NV: Normal Voltage NT: Normal Temperature		

3.6 Description of Support Units

Description	Manufacturer	Model No.
Test auxiliary PCB board	Quectel	N/A
Remark: all above the information of table are provided by client.		



Unless otherwise agreed in writing, this document is issued by the Company subject to its General Conditions of Service printed overleaf, available on request or accessible at <http://www.sgs.com/en/Terms-and-Conditions.aspx> and, for electronic format documents, subject to Terms and Conditions for Electronic Documents at <http://www.sgs.com/en/Terms-and-Conditions/Terms-e-Documents.aspx>. Attention is drawn to the limitation of liability, indemnification and jurisdiction issues defined therein. Any holder of this document is advised that information contained hereon reflects the Company's findings at the time of its intervention only and within the limits of Client's instructions, if any. The Company's sole responsibility is to its Client and this document does not exonerate parties to a transaction from exercising all their rights and obligations under the transaction documents. This document cannot be reproduced except in full, without prior written approval of the Company. Any unauthorized alteration, forgery or falsification of the content or appearance of this document is unlawful and offenders may be prosecuted to the fullest extent of the law. Unless otherwise stated the results shown in this test report refer only to the sample(s) tested and such sample(s) are retained for 30 days only.

Attention: To check the authenticity of testing / inspection report & certificate, please contact us at telephone: (86-755) 8307 1443, or email: CN.Doccheck@sgs.com

South of No. 6 Plant, No. 1, Runsheng Road, Suzhou Industrial Park, Suzhou Area, China (Jiangsu) Pilot Free Trade Zone 215000 t (86-512) 62992980 www.sgs.com.cn
 中国·苏州·中国(江苏)自由贸易试验区苏州片区苏州工业园区润胜路1号的6号厂房南楼 邮编: 215000 t (86-512) 62992980 sgs.china@sgs.com

4 Test results and Measurement Data

4.1 Antenna Requirement

Standard requirement:	47 CFR Part 15C Section 15.203 /247(b)
<p>15.203 requirement: An intentional radiator shall be designed to ensure that no antenna other than that furnished by the responsible party shall be used with the device. The use of a permanently attached antenna or of an antenna that uses a unique coupling to the intentional radiator, the manufacturer may design the unit so that a broken antenna can be replaced by the user, but the use of a standard antenna jack or electrical connector is prohibited.</p> <p>15.247(b) (4) requirement: The conducted output power limit specified in paragraph (b) of this section is based on the use of antennas with directional gains that do not exceed 6 dBi. Except as shown in paragraph (c) of this section, if transmitting antennas of directional gain greater than 6 dBi are used, the conducted output power from the intentional radiator shall be reduced below the stated values in paragraphs (b)(1), (b)(2), and (b)(3) of this section, as appropriate, by the amount in dB that the directional gain of the antenna exceeds 6 dBi.</p>	
<p>The antenna is PCB Antenna on the main PCB and no consideration of replacement. The best case gain of the antenna is 4.61dBi(Ant1). *</p>	
<p><i>*Note:</i> <i>The antenna gain are derived from the gain information report provided by the manufacturer.</i></p> <p><i>Remark:</i> <i>As above information is provided and confirmed by the applicant. SGS is not liable to the accuracy, suitability, reliability or/and integrity of the information.</i></p>	



Unless otherwise agreed in writing, this document is issued by the Company subject to its General Conditions of Service printed overleaf, available on request or accessible at <http://www.sgs.com/en/Terms-and-Conditions.aspx> and, for electronic format documents, subject to Terms and Conditions for Electronic Documents at <http://www.sgs.com/en/Terms-and-Conditions/Terms-e-Documents.aspx>. Attention is drawn to the limitation of liability, indemnification and jurisdiction issues defined therein. Any holder of this document is advised that information contained hereon reflects the Company's findings at the time of its intervention only and within the limits of Client's instructions, if any. The Company's sole responsibility is to its Client and this document does not exonerate parties to a transaction from exercising all their rights and obligations under the transaction documents. This document cannot be reproduced except in full, without prior written approval of the Company. Any unauthorized alteration, forgery or falsification of the content or appearance of this document is unlawful and offenders may be prosecuted to the fullest extent of the law. Unless otherwise stated the results shown in this test report refer only to the sample(s) tested and such sample(s) are retained for 30 days only.

Attention: To check the authenticity of testing /inspection report & certificate, please contact us at telephone: (86-755) 8307 1443, or email: CN.Doccheck@sgs.com

4.2 AC Power Line Conducted Emissions

Test Requirement:	47 CFR Part 15C Section 15.207		
Test Method:	ANSI C63.10: 2013 Section 6.2		
Test Frequency Range:	150kHz to 30MHz		
Receiver Setup:	RBW = 9kHz, VBW = 30kHz		
Limit:	Frequency range(MHz)	Limit (dBuV)	
		Quasi-peak	Average
	0.15-0.5	66 to 56*	56 to 46*
	0.5-5	56	46
	5-30	60	50
* Decreases with the logarithm of the frequency.			
Test Procedure:	<ol style="list-style-type: none"> 1) The mains terminal disturbance voltage test was conducted in a shielded room. 2) The EUT was connected to AC power source through a LISN 1 (Line Impedance Stabilization Network) which provides a 50Ω/50μH + 5Ω linear impedance. The power cables of all other units of the EUT were connected to a second LISN 2, which was bonded to the ground reference plane in the same way as the LISN 1 for the unit being measured. A multiple socket outlet strip was used to connect multiple power cables to a single LISN provided the rating of the LISN was not exceeded. 3) The tabletop EUT was placed upon a non-metallic table 0.8m above the ground reference plane. And for floor-standing arrangement, the EUT was placed on the horizontal ground reference plane. 4) The test was performed with a vertical ground reference plane. The rear of the EUT shall be 0.4 m from the vertical ground reference plane. The vertical ground reference plane was bonded to the horizontal ground reference plane. The LISN 1 was placed 0.8 m from the boundary of the unit under test and bonded to a ground reference plane for LISNs mounted on top of the ground reference plane. This distance was between the closest points of the LISN 1 and the EUT. All other units of the EUT and associated equipment was at least 0.8 m from the LISN 2. 5) In order to find the maximum emission, the relative positions of equipment and all of the interface cables must be changed according to ANSI C63.10: 2013 on conducted measurement. 		



Unless otherwise agreed in writing, this document is issued by the Company subject to its General Conditions of Service printed overleaf, available on request or accessible at <http://www.sgs.com/en/Terms-and-Conditions.aspx> and, for electronic format documents, subject to Terms and Conditions for Electronic Documents at <http://www.sgs.com/en/Terms-and-Conditions/Terms-e-Documents.aspx>. Attention is drawn to the limitation of liability, indemnification and jurisdiction issues defined therein. Any holder of this document is advised that information contained hereon reflects the Company's findings at the time of its intervention only and within the limits of Client's instructions, if any. The Company's sole responsibility is to its Client and this document does not exonerate parties to a transaction from exercising all their rights and obligations under the transaction documents. This document cannot be reproduced except in full, without prior written approval of the Company. Any unauthorized alteration, forgery or falsification of the content or appearance of this document is unlawful and offenders may be prosecuted to the fullest extent of the law. Unless otherwise stated the results shown in this test report refer only to the sample(s) tested and such sample(s) are retained for 30 days only.
 Attention: To check the authenticity of testing / inspection report & certificate, please contact us at telephone: (86-755) 8307 1443, or email: CN.Doccheck@sgs.com

South of No. 6 Plant, No. 1, Runsheng Road, Suzhou Industrial Park, Suzhou Area, China (Jiangsu) Pilot Free Trade Zone 215000 t (86-512) 62992980 www.sgs.com.cn
 中国·苏州·中国 (江苏) 自由贸易试验区苏州片区苏州工业园区润胜路1号的6号厂房南楼 邮编: 215000 t (86-512) 62992980 sgs.china@sgs.com

<p>Test Setup:</p>	
<p>Test Mode:</p>	<p>Transmitting with GFSK modulation. Charge + Transmitting mode.</p>
<p>Instruments Used:</p>	<p>Refer to section 6 for details.</p>
<p>Test Results:</p>	<p>Pass</p>



Unless otherwise agreed in writing, this document is issued by the Company subject to its General Conditions of Service printed overleaf, available on request or accessible at <http://www.sgs.com/en/Terms-and-Conditions.aspx> and, for electronic format documents, subject to Terms and Conditions for Electronic Documents at <http://www.sgs.com/en/Terms-and-Conditions/Terms-e-Documents.aspx>. Attention is drawn to the limitation of liability, indemnification and jurisdiction issues defined therein. Any holder of this document is advised that information contained hereon reflects the Company's findings at the time of its intervention only and within the limits of Client's instructions, if any. The Company's sole responsibility is to its Client and this document does not exonerate parties to a transaction from exercising all their rights and obligations under the transaction documents. This document cannot be reproduced except in full, without prior written approval of the Company. Any unauthorized alteration, forgery or falsification of the content or appearance of this document is unlawful and offenders may be prosecuted to the fullest extent of the law. Unless otherwise stated the results shown in this test report refer only to the sample(s) tested and such sample(s) are retained for 30 days only.

Attention: To check the authenticity of testing / inspection report & certificate, please contact us at telephone: (86-755) 8307 1443, or email: CN.Doccheck@sgs.com

South of No. 6 Plant, No. 1, Runsheng Road, Suzhou Industrial Park, Suzhou Area, China (Jiangsu) Pilot Free Trade Zone 215000 t (86-512) 62992980 www.sgs.com.cn
 中国·苏州·中国 (江苏) 自由贸易试验区苏州片区苏州工业园区润胜路1号的6号厂房南楼 邮编: 215000 t (86-512) 62992980 sgs.china@sgs.com

Measurement Data

An initial pre-scan was performed on the live and neutral lines with peak detector.

Quasi-Peak and Average measurement were performed at the frequencies with maximized peak emission were detected.

BLE 1M

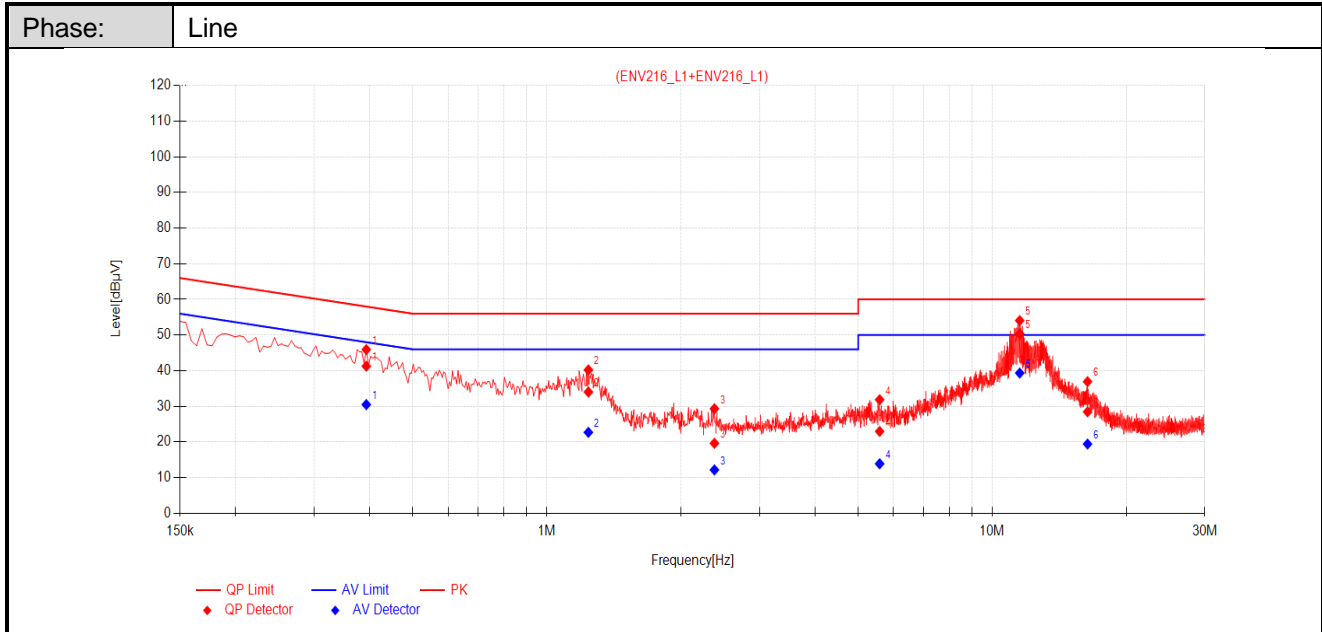

Final Data List											
NO.	Frequency [MHz]	Factor [dB]	QP Reading [dBµV]	QP Value [dBµV]	QP Limit [dBµV]	QP Margin [dB]	AV Reading [dBµV]	AV Value [dBµV]	AV Limit [dBµV]	AV Margin [dB]	Verdict
1	0.3930	10.49	30.78	41.27	58.00	16.73	20.01	30.50	48.00	17.50	PASS
2	1.2390	10.78	23.24	34.02	56.00	21.98	11.93	22.71	46.00	23.29	PASS
3	2.3775	10.66	8.98	19.64	56.00	36.36	1.52	12.18	46.00	33.82	PASS
4	5.5860	10.66	12.32	22.98	60.00	37.02	3.24	13.90	50.00	36.10	PASS
5	11.5260	10.59	39.77	50.36	60.00	9.64	28.75	39.34	50.00	10.66	PASS
6	16.3680	10.50	17.96	28.46	60.00	31.54	8.94	19.44	50.00	30.56	PASS

Remark:

1. The following Quasi-Peak and Average measurements were performed on the EUT:
2. Value = Reading [dBµV] + Factor (Lisn factor [dB] + cable loss [dB]).
3. Margin = Limit [dBµV] – Value [dBµV]



Unless otherwise agreed in writing, this document is issued by the Company subject to its General Conditions of Service printed overleaf, available on request or accessible at <http://www.sgs.com/en/Terms-and-Conditions.aspx> and for electronic format documents, subject to Terms and Conditions for Electronic Documents at <http://www.sgs.com/en/Terms-and-Conditions/Terms-e-Documents.aspx>. Attention is drawn to the limitation of liability, indemnification and jurisdiction issues defined therein. Any holder of this document is advised that information contained hereon reflects the Company's findings at the time of its intervention only and within the limits of Client's instructions, if any. The Company's sole responsibility is to its Client and this document does not exonerate parties to a transaction from exercising all their rights and obligations under the transaction documents. This document cannot be reproduced except in full, without prior written approval of the Company. Any unauthorized alteration, forgery or falsification of the content or appearance of this document is unlawful and offenders may be prosecuted to the fullest extent of the law. Unless otherwise stated the results shown in this test report refer only to the sample(s) tested and such sample(s) are retained for 30 days only.

Attention: To check the authenticity of testing / inspection report & certificate, please contact us at telephone: (86-755) 8307 1443, or email: QN.Doccheck@sgsgroup.com

South of No. 6 Plant, No. 1, Runsheng Road, Suzhou Industrial Park, Suzhou Area, China (Jiangsu) Pilot Free Trade Zone 215000 t (86-512) 62992980 www.sgsgroup.com.cn
 中国·苏州·中国 (江苏) 自由贸易试验区苏州片区苏州工业园区润胜路1号的6号厂房南楼 邮编: 215000 t (86-512) 62992980 sgs.china@sgsgroup.com

Phase: Neutral

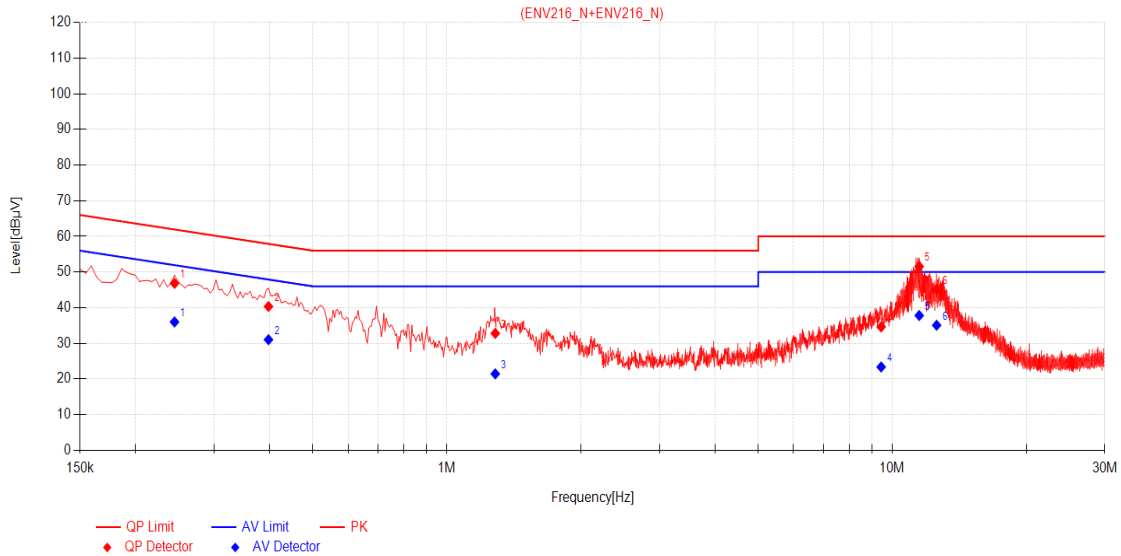

Final Data List

NO.	Frequency [MHz]	Factor [dB]	QP Reading [dBµV]	QP Value [dBµV]	QP Limit [dBµV]	QP Margin [dB]	AV Reading [dBµV]	AV Value [dBµV]	AV Limit [dBµV]	AV Margin [dB]	Verdict
1	0.2445	10.72	36.09	46.81	61.94	15.13	25.29	36.01	51.94	15.93	PASS
2	0.3975	10.83	29.51	40.34	57.91	17.57	20.20	31.03	47.91	16.88	PASS
3	1.2840	10.78	22.03	32.81	56.00	23.19	10.66	21.44	46.00	24.56	PASS
4	9.4425	10.64	23.98	34.62	60.00	25.38	12.74	23.38	50.00	26.62	PASS
5	11.4945	10.65	40.93	51.58	60.00	8.42	27.15	37.80	50.00	12.20	PASS
6	12.5790	10.63	34.53	45.16	60.00	14.84	24.45	35.08	50.00	14.92	PASS

Remark:

- The following Quasi-Peak and Average measurements were performed on the EUT:
- Value = Reading[dBµV] + Factor(Lisn factor[dB] + cable loss[dB]).
- Margin = Limit[dBµV] – Value[dBµV]



Unless otherwise agreed in writing, this document is issued by the Company subject to its General Conditions of Service printed overleaf, available on request or accessible at <http://www.sgs.com/en/Terms-and-Conditions.aspx> and for electronic format documents, subject to Terms and Conditions for Electronic Documents at <http://www.sgs.com/en/Terms-and-Conditions/Terms-e-Documents.aspx>. Attention is drawn to the limitation of liability, indemnification and jurisdiction issues defined therein. Any holder of this document is advised that information contained hereon reflects the Company's findings at the time of its intervention only and within the limits of Client's instructions, if any. The Company's sole responsibility is to its Client and this document does not exonerate parties to a transaction from exercising all their rights and obligations under the transaction documents. This document cannot be reproduced except in full, without prior written approval of the Company. Any unauthorized alteration, forgery or falsification of the content or appearance of this document is unlawful and offenders may be prosecuted to the fullest extent of the law. Unless otherwise stated the results shown in this test report refer only to the sample(s) tested and such sample(s) are retained for 30 days only.
 Attention: To check the authenticity of testing /inspection report & certificate, please contact us at telephone: (86-755) 8307 1443, or email: QN.Doccheck@sgs.com

South of No. 6 Plant, No. 1, Runsheng Road, Suzhou Industrial Park, Suzhou Area, China (Jiangsu) Pilot Free Trade Zone 215000 t (86-512) 62992980 www.sgsgroup.com.cn
 中国·苏州·中国 (江苏) 自由贸易试验区苏州片区苏州工业园区润胜路1号的6号厂房南座 邮编: 215000 t (86-512) 62992980 sgs.china@sgs.com

BLE 2M

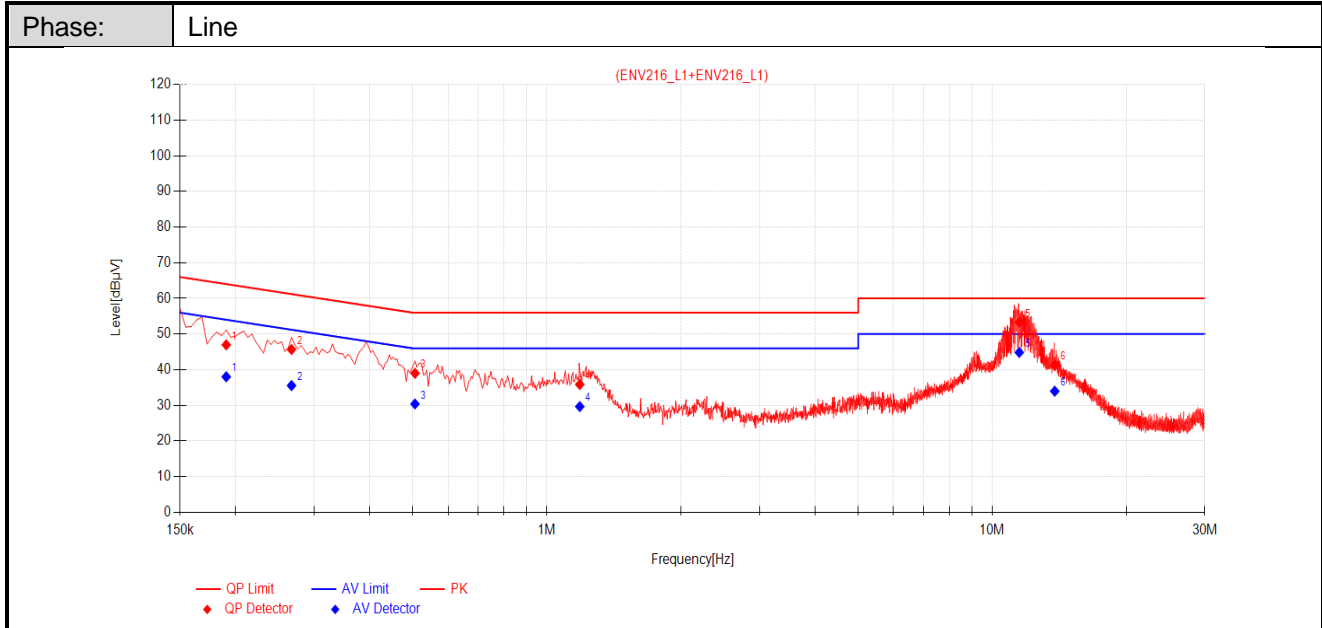

Final Data List											
NO.	Frequency [MHz]	Factor [dB]	QP Reading [dBµV]	QP Value [dBµV]	QP Limit [dBµV]	QP Margin [dB]	AV Reading [dBµV]	AV Value [dBµV]	AV Limit [dBµV]	AV Margin [dB]	Verdict
1	0.1905	10.78	36.20	46.98	64.01	17.03	27.24	38.02	54.01	15.99	PASS
2	0.2670	10.74	34.94	45.68	61.21	15.53	24.80	35.54	51.21	15.67	PASS
3	0.5055	10.61	28.38	38.99	56.00	17.01	19.77	30.38	46.00	15.62	PASS
4	1.1850	10.76	25.10	35.86	56.00	20.14	18.90	29.66	46.00	16.34	PASS
5	11.4990	10.60	42.69	53.29	60.00	6.71	34.23	44.83	50.00	5.17	PASS
6	13.8120	10.54	30.72	41.26	60.00	18.74	23.44	33.98	50.00	16.02	PASS

Remark:

- The following Quasi-Peak and Average measurements were performed on the EUT:
- Value = Reading[dBµV] + Factor(Lisn factor[dB] + cable loss[dB]).
- Margin = Limit[dBµV] – Value[dBµV]



Unless otherwise agreed in writing, this document is issued by the Company subject to its General Conditions of Service printed overleaf, available on request or accessible at <http://www.sgs.com/en/Terms-and-Conditions.aspx> and for electronic format documents, subject to Terms and Conditions for Electronic Documents at <http://www.sgs.com/en/Terms-and-Conditions/Terms-e-Documents.aspx>. Attention is drawn to the limitation of liability, indemnification and jurisdiction issues defined therein. Any holder of this document is advised that information contained hereon reflects the Company's findings at the time of its intervention only and within the limits of Client's instructions, if any. The Company's sole responsibility is to its Client and this document does not exonerate parties to a transaction from exercising all their rights and obligations under the transaction documents. This document cannot be reproduced except in full, without prior written approval of the Company. Any unauthorized alteration, forgery or falsification of the content or appearance of this document is unlawful and offenders may be prosecuted to the fullest extent of the law. Unless otherwise stated the results shown in this test report refer only to the sample(s) tested and such sample(s) are retained for 30 days only.

Attention: To check the authenticity of testing / inspection report & certificate, please contact us at telephone: (86-755) 8307 1443, or email: CN.Doccheck@sgs.com

South of No. 6 Plant, No. 1, Runsheng Road, Suzhou Industrial Park, Suzhou Area, China (Jiangsu) Pilot Free Trade Zone 215000 t (86-512) 62992980 www.sgs.com.cn
 中国·苏州·中国 (江苏) 自由贸易试验区苏州片区苏州工业园区润胜路1号的6号厂房南座 邮编: 215000 t (86-512) 62992980 sgs.china@sgs.com

Phase: Neutral

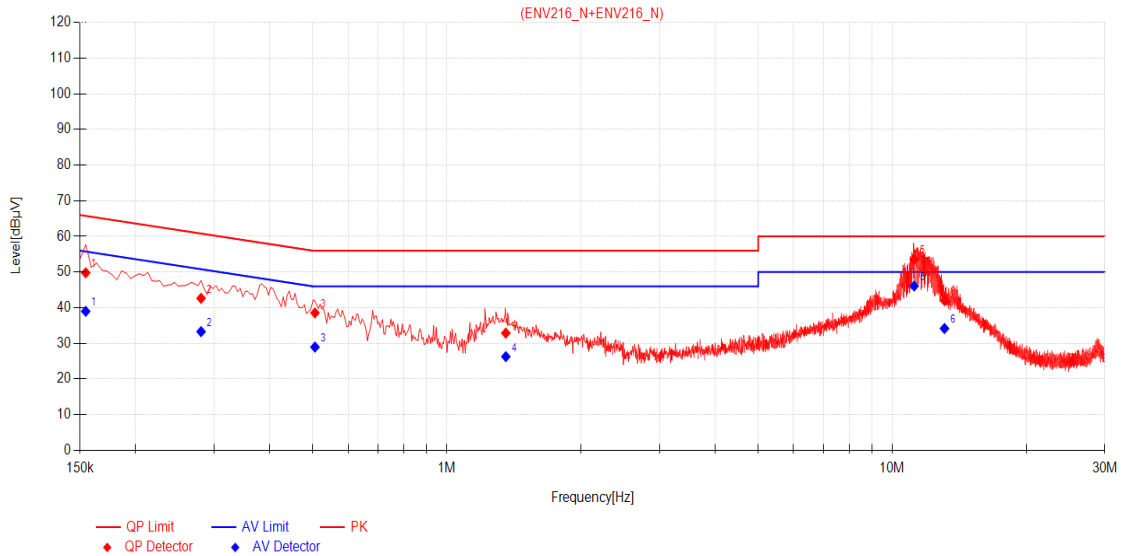

Final Data List

NO.	Frequency [MHz]	Factor [dB]	QP Reading [dBµV]	QP Value [dBµV]	QP Limit [dBµV]	QP Margin [dB]	AV Reading [dBµV]	AV Value [dBµV]	AV Limit [dBµV]	AV Margin [dB]	Verdict
1	0.1545	10.72	39.08	49.80	65.75	15.95	28.26	38.98	55.75	16.77	PASS
2	0.2805	10.74	31.90	42.64	60.80	18.16	22.54	33.28	50.80	17.52	PASS
3	0.5055	10.80	27.74	38.54	56.00	17.46	18.15	28.95	46.00	17.05	PASS
4	1.3560	10.78	22.10	32.88	56.00	23.12	15.50	26.28	46.00	19.72	PASS
5	11.2020	10.66	42.89	53.55	60.00	6.45	35.43	46.09	50.00	3.91	PASS
6	13.1010	10.62	31.41	42.03	60.00	17.97	23.54	34.16	50.00	15.84	PASS

Remark:

- The following Quasi-Peak and Average measurements were performed on the EUT:
- Value = Reading[dBµV] + Factor(Lisn factor[dB] + cable loss[dB]).
- Margin = Limit[dBµV] – Value[dBµV]



Unless otherwise agreed in writing, this document is issued by the Company subject to its General Conditions of Service printed overleaf, available on request or accessible at <http://www.sgs.com/en/Terms-and-Conditions.aspx> and, for electronic format documents, subject to Terms and Conditions for Electronic Documents at <http://www.sgs.com/en/Terms-and-Conditions/Terms-e-Documents.aspx>. Attention is drawn to the limitation of liability, indemnification and jurisdiction issues defined therein. Any holder of this document is advised that information contained hereon reflects the Company's findings at the time of its intervention only and within the limits of Client's instructions, if any. The Company's sole responsibility is to its Client and this document does not exonerate parties to a transaction from exercising all their rights and obligations under the transaction documents. This document cannot be reproduced except in full, without prior written approval of the Company. Any unauthorized alteration, forgery or falsification of the content or appearance of this document is unlawful and offenders may be prosecuted to the fullest extent of the law. Unless otherwise stated the results shown in this test report refer only to the sample(s) tested and such sample(s) are retained for 30 days only.
Attention: To check the authenticity of testing/inspection report & certificate, please contact us at telephone: (86-755) 8307 1443, or email: CN.Doccheck@sgs.com
 South of No. 6 Plant, No. 1, Runsheng Road, Suzhou Industrial Park, Suzhou Area, China (Jiangsu) Pilot Free Trade Zone 215000 t (86-512) 62992980 www.sgs.com.cn
 中国·苏州·中国(江苏)自由贸易试验区苏州片区苏州工业园区润胜路1号的6号厂房南楼 邮编: 215000 t (86-512) 62992980 sgs.china@sgs.com

Report No.: SEWM2207000133RG02

Rev.: 01

Page: 16 of 79

4.3 Duty Cycle

The detailed test data see: **Appendix**



Unless otherwise agreed in writing, this document is issued by the Company subject to its General Conditions of Service printed overleaf, available on request or accessible at <http://www.sgs.com/en/Terms-and-Conditions.aspx> and, for electronic format documents, subject to Terms and Conditions for Electronic Documents at <http://www.sgs.com/en/Terms-and-Conditions/Terms-e-Documents.aspx>. Attention is drawn to the limitation of liability, indemnification and jurisdiction issues defined therein. Any holder of this document is advised that information contained hereon reflects the Company's findings at the time of its intervention only and within the limits of Client's instructions, if any. The Company's sole responsibility is to its Client and this document does not exonerate parties to a transaction from exercising all their rights and obligations under the transaction documents. This document cannot be reproduced except in full, without prior written approval of the Company. Any unauthorized alteration, forgery or falsification of the content or appearance of this document is unlawful and offenders may be prosecuted to the fullest extent of the law. Unless otherwise stated the results shown in this test report refer only to the sample(s) tested and such sample(s) are retained for 30 days only.
Attention: To check the authenticity of testing/inspection report & certificate, please contact us at telephone: (86-755) 8307 1443, or email: CN.Doccheck@sgs.com

SGS-CSTC Standards Technical Services (Suzhou) Co., Ltd.
Wireless Laboratory

South of No. 6 Plant, No. 1, Runsheng Road, Suzhou Industrial Park, Suzhou Area, China (Jiangsu) Pilot Free Trade Zone 215000
中国·苏州·中国(江苏)自由贸易试验区苏州片区苏州工业园区润胜路1号的6号厂房南面 邮编: 215000

t (86-512) 62992980 www.sgs.com.cn
t (86-512) 62992980 sgs.china@sgs.com

4.4 Conducted Output Power

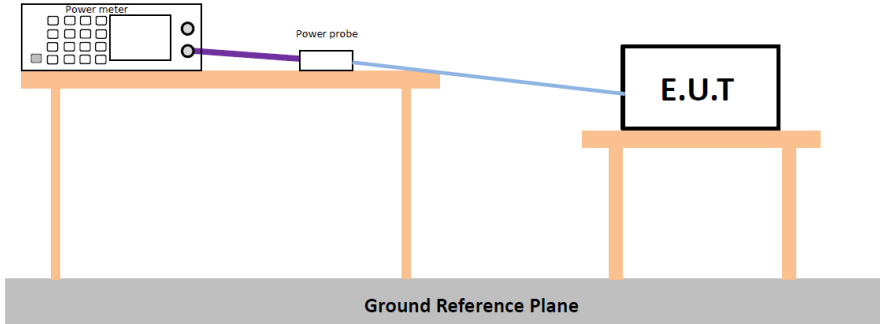
Test Requirement:	47 CFR Part 15C Section 15.247 (b)(3)
Test Method:	ANSI C63.10 :2013 Section11.9.2.3
Test Setup:	 <p>* Test with power meter (Detector function: Peak)</p>
Test Instruments:	Refer to section 6 for details
Test Mode:	Transmitting with GFSK modulation.
Limit:	30dBm
Test Results:	Pass
The detailed test data see: Appendix	



4.5 DTS (6 dB) Bandwidth & 99% Occupied Bandwidth

Test Requirement:	47 CFR Part 15C Section 15.247 (a)(2)
Test Method:	ANSI C63.10: 2013 Section 11.8 Option 2 / 6.9.3
Test Setup:	
Instruments Used:	Refer to section 6 for details
Test Mode:	Transmitting with GFSK modulation.
Limit:	≥ 500 kHz
Test Results:	Pass
The detailed test data see: Appendix	



4.6 Power Spectral Density

Test Requirement:	47 CFR Part 15C Section 15.247 (e)
Test Method:	ANSI C63.10 :2013 Section 11.10.2
Test Setup:	
Test Instruments:	Refer to section 6 for details
Test Mode:	Transmitting with GFSK modulation.
Limit:	≤8.00dBm/3kHz
Test Results:	Pass
The detailed test data see: Appendix	



Unless otherwise agreed in writing, this document is issued by the Company subject to its General Conditions of Service printed overleaf, available on request or accessible at <http://www.sgs.com/en/Terms-and-Conditions.aspx> and, for electronic format documents, subject to Terms and Conditions for Electronic Documents at <http://www.sgs.com/en/Terms-and-Conditions/Terms-e-Documents.aspx>. Attention is drawn to the limitation of liability, indemnification and jurisdiction issues defined therein. Any holder of this document is advised that information contained hereon reflects the Company's findings at the time of its intervention only and within the limits of Client's instructions, if any. The Company's sole responsibility is to its Client and this document does not exonerate parties to a transaction from exercising all their rights and obligations under the transaction documents. This document cannot be reproduced except in full, without prior written approval of the Company. Any unauthorized alteration, forgery or falsification of the content or appearance of this document is unlawful and offenders may be prosecuted to the fullest extent of the law. Unless otherwise stated the results shown in this test report refer only to the sample(s) tested and such sample(s) are retained for 30 days only.

Attention: To check the authenticity of testing/inspection report & certificate, please contact us at telephone: (86-755) 8307 1443, or email: CN.Doccheck@sgs.com

South of No. 6 Plant, No. 1, Runsheng Road, Suzhou Industrial Park, Suzhou Area, China (Jiangsu) Pilot Free Trade Zone 215000
 中国·苏州·中国(江苏)自由贸易试验区苏州片区苏州工业园区润胜路1号的6号厂房南楼 邮编: 215000

t (86-512) 62992980 www.sgs.com.cn
 t (86-512) 62992980 sgs.china@sgs.com

4.7 Band-edge for RF Conducted Emissions

Test Requirement:	47 CFR Part 15C Section 15.247 (d)
Test Method:	ANSI C63.10: 2013 Section 11.11
Test Setup:	
Instruments Used:	Refer to section 6 for details
Test Mode:	Transmitting with GFSK modulation.
Limit:	In any 100 kHz bandwidth outside the frequency band in which the spread spectrum intentional radiator is operating, the radio frequency power that is produced by the intentional radiator shall be at least 20 dB below that in the 100 kHz bandwidth within the band that contains the highest level of the desired power, based on either an RF conducted or a radiated measurement.
Test Results:	Pass
The detailed test data see: Appendix	



4.8 RF Conducted Spurious Emissions

Test Requirement:	47 CFR Part 15C Section 15.247 (d)
Test Method:	ANSI C63.10: 2013 Section 11.11
Test Setup:	
Instruments Used:	Refer to section 6 for details
Test Mode:	Transmitting with GFSK modulation.
Limit:	In any 100 kHz bandwidth outside the frequency band in which the spread spectrum intentional radiator is operating, the radio frequency power that is produced by the intentional radiator shall be at least 20 dB below that in the 100 kHz bandwidth within the band that contains the highest level of the desired power, based on either an RF conducted or a radiated measurement.
Test Results:	Pass
The detailed test data see: Appendix	



Unless otherwise agreed in writing, this document is issued by the Company subject to its General Conditions of Service printed overleaf, available on request or accessible at <http://www.sgs.com/en/Terms-and-Conditions.aspx> and, for electronic format documents, subject to Terms and Conditions for Electronic Documents at <http://www.sgs.com/en/Terms-and-Conditions/Terms-e-Documents.aspx>. Attention is drawn to the limitation of liability, indemnification and jurisdiction issues defined therein. Any holder of this document is advised that information contained hereon reflects the Company's findings at the time of its intervention only and within the limits of Client's instructions, if any. The Company's sole responsibility is to its Client and this document does not exonerate parties to a transaction from exercising all their rights and obligations under the transaction documents. This document cannot be reproduced except in full, without prior written approval of the Company. Any unauthorized alteration, forgery or falsification of the content or appearance of this document is unlawful and offenders may be prosecuted to the fullest extent of the law. Unless otherwise stated the results shown in this test report refer only to the sample(s) tested and such sample(s) are retained for 30 days only.
Attention: To check the authenticity of testing /inspection report & certificate, please contact us at telephone: (86-755) 8307 1443, or email: CN.Doccheck@sgs.com

4.9 Radiated Spurious Emissions

Test Requirement:	47 CFR Part 15C Section 15.209 and 15.205				
Test Method:	ANSI C63.10 :2013 Section 11.12				
Test Site:	Measurement Distance: 3m (Semi-Anechoic Chamber)				
Test Frequency:	9kHz ~ 25GHz				
Limit:	Frequency	Field strength (microvolt/meter)	Limit (dBuV/m)	Remark	Measurement distance (m)
	0.009MHz-0.490MHz	2400/F(kHz)	-	-	300
	0.490MHz-1.705MHz	24000/F(kHz)	-	-	30
	1.705MHz-30MHz	30	-	-	30
	30MHz-88MHz	100	40.0	Quasi-peak	3
	88MHz-216MHz	150	43.5	Quasi-peak	3
	216MHz-960MHz	200	46.0	Quasi-peak	3
	960MHz-1GHz	500	54.0	Quasi-peak	3
	Above 1GHz	500	54.0	Average	3
Remark: 15.35(b), Unless otherwise specified, the limit on peak radio frequency emissions is 20dB above the maximum permitted average emission limit applicable to the equipment under test. This peak limit applies to the total peak emission level radiated by the device.					

Test Setup:

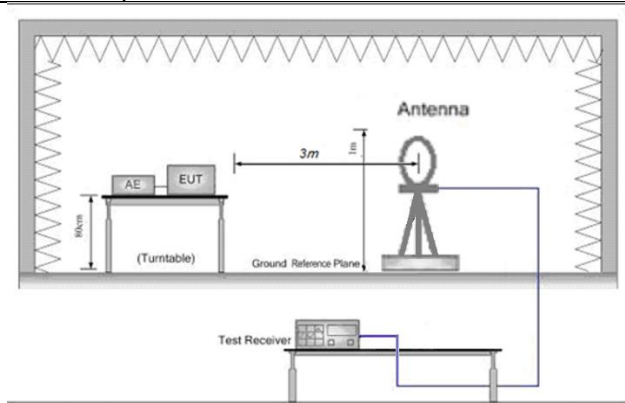

Figure 1. Below 30MHz

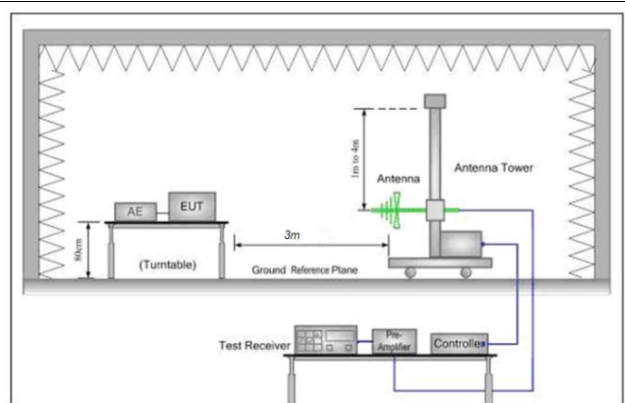

Figure 2. 30MHz to 1GHz



Unless otherwise agreed in writing, this document is issued by the Company subject to its General Conditions of Service printed overleaf, available on request or accessible at <http://www.sgs.com/en/Terms-and-Conditions.aspx> and, for electronic format documents, subject to Terms and Conditions for Electronic Documents at <http://www.sgs.com/en/Terms-and-Conditions/Terms-e-Documents.aspx>. Attention is drawn to the limitation of liability, indemnification and jurisdiction issues defined therein. Any holder of this document is advised that information contained hereon reflects the Company's findings at the time of its intervention only and within the limits of Client's instructions, if any. The Company's sole responsibility is to its Client and this document does not exonerate parties to a transaction from exercising all their rights and obligations under the transaction documents. This document cannot be reproduced except in full, without prior written approval of the Company. Any unauthorized alteration, forgery or falsification of the content or appearance of this document is unlawful and offenders may be prosecuted to the fullest extent of the law. Unless otherwise stated the results shown in this test report refer only to the sample(s) tested and such sample(s) are retained for 30 days only.
Attention: To check the authenticity of testing/inspection report & certificate, please contact us at telephone: (86-755) 8307 1443, or email: CN.Doccheck@sgs.com

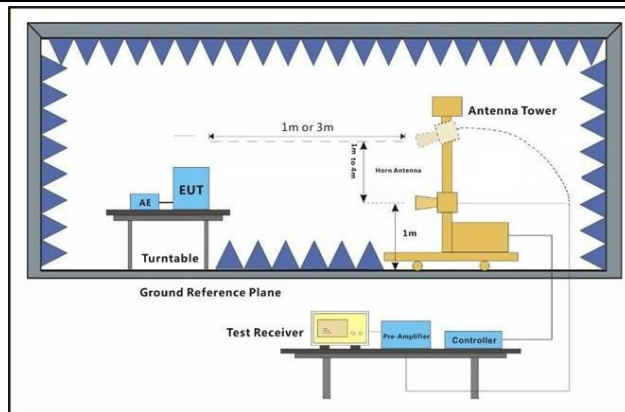

Figure 3. Above 1 GHz

<p>Test Procedure:</p>	<ol style="list-style-type: none"> For below 1GHz, the EUT was placed on the top of a rotating table 0.8 meters above the ground at a 3 or 10 meter semi-anechoic chamber. The table was rotated 360 degrees to determine the position of the highest radiation. For above 1GHz, the EUT was placed on the top of a rotating table 1.5 meters above the ground at a 3 meter semi-anechoic chamber. The table was rotated 360 degrees to determine the position of the highest radiation (Distance from antenna to EUT is 1m for measurements >18GHz). The EUT was set 3 or 10 meters away from the interference-receiving antenna, which was mounted on the top of a variable-height antenna tower. The antenna height is varied from one meter to four meters above the ground to determine the maximum value of the field strength. Both horizontal and vertical polarizations of the antenna are set to make the measurement. For each suspected emission, the EUT was arranged to its worst case and then the antenna was tuned to heights from 1 meter to 4 meters (for the test frequency of below 30MHz, the antenna was tuned to heights 1 meter) and the rotatable table was turned from 0 degrees to 360 degrees to find the maximum reading. The test-receiver system was set to Peak Detect Function and Specified Bandwidth with Maximum Hold Mode. Test the EUT in the lowest channel, the middle channel, the Highest channel. The radiation measurements are performed in X, Y, Z axis positioning for Transmitting mode, And found the X axis positioning which it is worse case. Repeat above procedures until all frequencies measured was complete. The low frequency, which started from 9 kHz to 30MHz, was pre-scanned and the result which was 20dB lower than the limit line was not reported The disturbance above 18GHz was very low, and the harmonics were the highest point could be found when testing, so only the harmonics had been displayed. At a measurement distance of 1 meter the limit line was increased by $20 \cdot \text{LOG}(3/1) = 9.54 \text{ dB}$.
<p>Test Configuration:</p>	<p>Measurements Below 1000MHz</p> <ul style="list-style-type: none"> RBW = 120 kHz VBW = 300 kHz Detector = Peak Trace mode = max hold



Unless otherwise agreed in writing, this document is issued by the Company subject to its General Conditions of Service printed overleaf, available on request or accessible at <http://www.sgs.com/en/Terms-and-Conditions.aspx> and, for electronic format documents, subject to Terms and Conditions for Electronic Documents at <http://www.sgs.com/en/Terms-and-Conditions/Terms-e-Documents.aspx>. Attention is drawn to the limitation of liability, indemnification and jurisdiction issues defined therein. Any holder of this document is advised that information contained hereon reflects the Company's findings at the time of its intervention only and within the limits of Client's instructions, if any. The Company's sole responsibility is to its Client and this document does not exonerate parties to a transaction from exercising all their rights and obligations under the transaction documents. This document cannot be reproduced except in full, without prior written approval of the Company. Any unauthorized alteration, forgery or falsification of the content or appearance of this document is unlawful and offenders may be prosecuted to the fullest extent of the law. Unless otherwise stated the results shown in this test report refer only to the sample(s) tested and such sample(s) are retained for 30 days only.

Attention: To check the authenticity of testing/inspection report & certificate, please contact us at telephone: (86-755) 8307 1443, or email: CN.Doccheck@sgs.com

	<p>Peak Measurements Above 1000 MHz</p> <ul style="list-style-type: none"> • RBW = 1 MHz • VBW ≥ 3 MHz • Detector = Peak • Sweep time = auto • Trace mode = max hold <p>Average Measurements Above 1000MHz</p> <ul style="list-style-type: none"> • RBW = 1 MHz • VBW ≥ [3 *RBW] • Detector = RMS (power averaging), if span / (# of points in sweep) ≤ (RBW / 2). Satisfying this condition may require increasing the number of points in the sweep or reducing the span. If this condition cannot be satisfied, then the detector mode shall be set to peak. • Sweep time = auto • Perform a trace average of at least 100 traces.
Exploratory Test Mode:	<p>Transmitting with GFSK modulation. Charge + Transmitting mode.</p>
Final Test Mode:	<p>Transmitting with GFSK modulation. Pretest the EUT at Charge + Transmitting mode, For below 1GHz part, through pre-scan, the worst case is the lowest channel. Only the worst case is recorded in the report.</p>
Instruments Used:	Refer to section 6 for details
Test Results:	Pass
The detailed test data see: Appendix	



Unless otherwise agreed in writing, this document is issued by the Company subject to its General Conditions of Service printed overleaf, available on request or accessible at <http://www.sgs.com/en/Terms-and-Conditions.aspx> and, for electronic format documents, subject to Terms and Conditions for Electronic Documents at <http://www.sgs.com/en/Terms-and-Conditions/Terms-e-Documents.aspx>. Attention is drawn to the limitation of liability, indemnification and jurisdiction issues defined therein. Any holder of this document is advised that information contained hereon reflects the Company's findings at the time of its intervention only and within the limits of Client's instructions, if any. The Company's sole responsibility is to its Client and this document does not exonerate parties to a transaction from exercising all their rights and obligations under the transaction documents. This document cannot be reproduced except in full, without prior written approval of the Company. Any unauthorized alteration, forgery or falsification of the content or appearance of this document is unlawful and offenders may be prosecuted to the fullest extent of the law. Unless otherwise stated the results shown in this test report refer only to the sample(s) tested and such sample(s) are retained for 30 days only.
Attention: To check the authenticity of testing/inspection report & certificate, please contact us at telephone: (86-755) 8307 1443, or email: CN.Doccheck@sgs.com

4.10 Restricted bands around fundamental frequency

Test Requirement:	47 CFR Part 15C Section 15.209 and 15.205		
Test Method:	ANSI C63.10: 2013 Section 11.12		
Test Site:	Measurement Distance: 3m (Semi-Anechoic Chamber)		
Limit:	Frequency	Limit (dBuV/m)	Remark
	30MHz-88MHz	40.0	Quasi-peak
	88MHz-216MHz	43.5	Quasi-peak
	216MHz-960MHz	46.0	Quasi-peak
	960MHz-1GHz	54.0	Quasi-peak
	Above 1GHz	54.0	Average Value
		74.0	Peak Value

Test Setup:

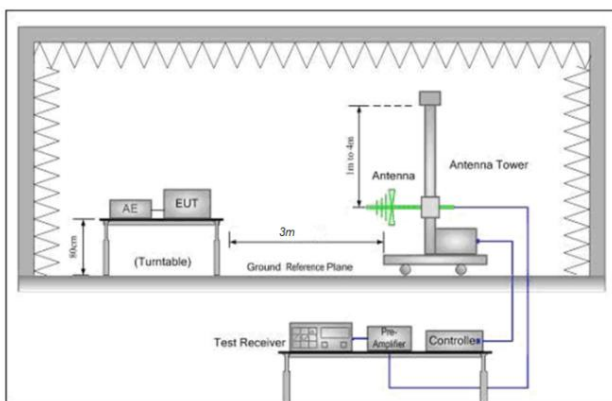

Figure 1. 30MHz to 1GHz

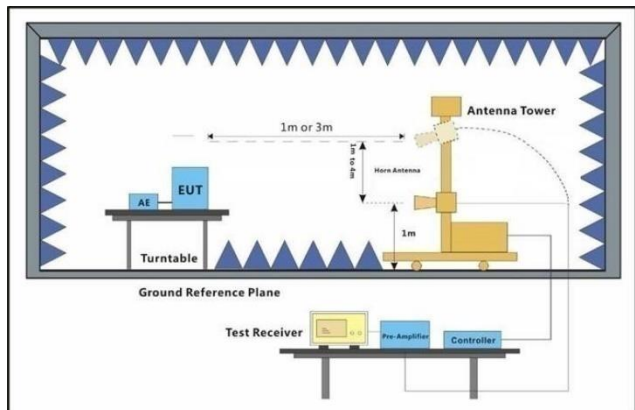

Figure 2. Above 1 GHz

Test Procedure:

- For below 1GHz, the EUT was placed on the top of a rotating table 0.8 meters above the ground at a 3 or 10 meter semi-anechoic chamber. The table was rotated 360 degrees to determine the position of the highest radiation.
- For above 1GHz, the EUT was placed on the top of a rotating table 1.5 meters above the ground at a 3 meter semi-anechoic chamber. The table was rotated 360 degrees to determine the position of the highest radiation.
- The EUT was set 3 or 10 meters away from the interference-receiving antenna, which was mounted on the top of a variable-height antenna tower.
- The antenna height is varied from one meter to four meters above the ground to determine the maximum value of the field strength. Both horizontal and vertical polarizations of the antenna are set to make the measurement.
- For each suspected emission, the EUT was arranged to its worst case and then the antenna was tuned to heights from 1 meter to 4 meters and the rotatable table was turned from 0 degrees to 360 degrees to find the maximum reading.
- The test-receiver system was set to Peak Detect Function and Specified Bandwidth with Maximum Hold Mode.
- Place a marker at the end of the restricted band closest to the transmit frequency to show compliance. Also measure any emissions in the restricted



	<p>bands. Save the spectrum analyzer plot. Repeat for each power and modulation for lowest and highest channel</p> <p>h. Test the EUT in the lowest channel , the Highest channel</p> <p>i. The radiation measurements are performed in X, Y, Z axis positioning for Transmitting mode, And found the X axis positioning which it is worse case.</p> <p>j. Repeat above procedures until all frequencies measured was complete.</p>
Test Configuration:	<p>Measurements Below 1000MHz</p> <ul style="list-style-type: none"> • RBW = 120 kHz • VBW = 300 kHz • Detector = Peak • Trace mode = max hold <p>Peak Measurements Above 1000 MHz</p> <ul style="list-style-type: none"> • RBW = 1 MHz • VBW ≥ 3 MHz • Detector = Peak • Sweep time = auto • Trace mode = max hold <p>Average Measurements Above 1000MHz</p> <ul style="list-style-type: none"> • RBW = 1 MHz • VBW ≥ [3 *RBW] • Detector = RMS (power averaging), if span / (# of points in sweep) ≤ (RBW / 2). Satisfying this condition may require increasing the number of points in the sweep or reducing the span. If this condition cannot be satisfied, then the detector mode shall be set to peak. • Sweep time = auto • Perform a trace average of at least 100 traces.
Exploratory Test Mode:	<p>Transmitting with GFSK modulation. Charge + Transmitting mode.</p>
Final Test Mode:	<p>Transmitting with GFSK modulation. Pretest the EUT at Charge + Transmitting mode. Only the worst case is recorded in the report.</p>
Instruments Used:	Refer to section 6 for details
Test Results:	Pass
The detailed test data see: Appendix	



Unless otherwise agreed in writing, this document is issued by the Company subject to its General Conditions of Service printed overleaf, available on request or accessible at <http://www.sgs.com/en/Terms-and-Conditions.aspx> and, for electronic format documents, subject to Terms and Conditions for Electronic Documents at <http://www.sgs.com/en/Terms-and-Conditions/Terms-e-Documents.aspx>. Attention is drawn to the limitation of liability, indemnification and jurisdiction issues defined therein. Any holder of this document is advised that information contained hereon reflects the Company's findings at the time of its intervention only and within the limits of Client's instructions, if any. The Company's sole responsibility is to its Client and this document does not exonerate parties to a transaction from exercising all their rights and obligations under the transaction documents. This document cannot be reproduced except in full, without prior written approval of the Company. Any unauthorized alteration, forgery or falsification of the content or appearance of this document is unlawful and offenders may be prosecuted to the fullest extent of the law. Unless otherwise stated the results shown in this test report refer only to the sample(s) tested and such sample(s) are retained for 30 days only.

Attention: To check the authenticity of testing /inspection report & certificate, please contact us at telephone: (86-755) 8307 1443, or email: CN.Doccheck@sgs.com

South of No. 6 Plant, No. 1, Runsheng Road, Suzhou Industrial Park, Suzhou Area, China (Jiangsu) Pilot Free Trade Zone 215000
中国·苏州·中国(江苏)自由贸易试验区苏州片区苏州工业园区润胜路1号的6号厂房南楼 邮编: 215000

t (86-512) 62992980 www.sgs.com.cn
t (86-512) 62992980 sgs.china@sgs.com

5 Measurement Uncertainty (95% confidence levels, k=2)

No.	Item	Measurement Uncertainty
1	Total RF power, conducted	±0.54dB
2	RF power density, conducted	±1.03dB
3	Spurious emissions, conducted	±0.54dB
4	Radio Frequency	±1.0 %
5	Duty Cycle	±0.37%
6	Occupied Bandwidth	±1.0 %
7	Conduction Emission	± 2.90dB (150kHz to 30MHz)
8	Radiated Emission	± 3.13dB (9k -30MHz)
		± 4.80dB (30M -1GHz)
		± 4.80dB (1GHz to 18GHz)
		± 4.80dB (Above 18GHz)

Remark:

The U_{lab} (lab Uncertainty) is less than $U_{CISPR/ETSI}$ (CISPR/ETSI Uncertainty), so the test results
 – compliance is deemed to occur if no measured disturbance level exceeds the disturbance limit;
 – non-compliance is deemed to occur if any measured disturbance level exceeds the disturbance limit.



Unless otherwise agreed in writing, this document is issued by the Company subject to its General Conditions of Service printed overleaf, available on request or accessible at <http://www.sgs.com/en/Terms-and-Conditions.aspx> and, for electronic format documents, subject to Terms and Conditions for Electronic Documents at <http://www.sgs.com/en/Terms-and-Conditions/Terms-e-Documents.aspx>. Attention is drawn to the limitation of liability, indemnification and jurisdiction issues defined therein. Any holder of this document is advised that information contained hereon reflects the Company's findings at the time of its intervention only and within the limits of Client's instructions, if any. The Company's sole responsibility is to its Client and this document does not exonerate parties to a transaction from exercising all their rights and obligations under the transaction documents. This document cannot be reproduced except in full, without prior written approval of the Company. Any unauthorized alteration, forgery or falsification of the content or appearance of this document is unlawful and offenders may be prosecuted to the fullest extent of the law. Unless otherwise stated the results shown in this test report refer only to the sample(s) tested and such sample(s) are retained for 30 days only.
Attention: To check the authenticity of testing /inspection report & certificate, please contact us at telephone: (86-755) 8307 1443, or email: CN.Doccheck@sgs.com

SGS-CSTC Standards Technical Services (Suzhou) Co., Ltd.
 Wireless Laboratory

South of No. 6 Plant, No. 1, Runsheng Road, Suzhou Industrial Park, Suzhou Area, China (Jiangsu) Pilot Free Trade Zone 215000
 中国·苏州·中国(江苏)自由贸易试验区苏州片区苏州工业园区润胜路1号的6号厂房南楼 邮编: 215000

t (86-512) 62992980 www.sgs.com.cn
 t (86-512) 62992980 sgs.china@sgs.com

6 Equipment List

RF Test Equipment					
Equipment	Manufacturer	Model No.	Inventory No.	Cal Date (yyyy/mm/dd)	Cal Due Date (yyyy/mm/dd)
Shielding Room	Brilliant-emc	N/A	SUWI-04-01-06	2021/05/08	2024/05/07
Temperature and humidity meter	MingGao	TH101B	SUWI-01-01-07	2022/02/16	2023/02/15
Signal Analyzer	ROHDE &SCHWARZ	FSV3030	SUWI-01-02-02	2022/05/17	2023/05/16
Measurement Software	Tonscend	JS1120-3 Test System V3.1.55	SUWI-02-09-09	NCR	NCR
DC Power Supply	HYELEC	HY3005B	SUWI-01-18-01	2022/02/15	2023/02/14
Signal Analyzer	ROHDE &SCHWARZ	FSW43	SUWI-01-02-04	2022/05/28	2023/05/27
Power meter	Anritsu	ML2495A	SUWI-01-31-01	2021/12/04	2022/12/03
Pulse power sensor	Anritsu	MA2411B	SUWI-01-32-01	2021/12/04	2022/12/03
MXG Vector signal genitor	KEYSIGHT	N5182B	SUWI-01-38-01	2022/02/14	2023/02/13
Temperature Chamber	ESPEC	SU-242	SUWI-01-13-01	2022/02/15	2023/02/14
Wideband Radio Communication Tester	ROHDE &SCHWARZ	CMW500	SUWI-01-16-05	2022/02/14	2023/02/13

CE Test System					
Equipment	Manufacturer	Model No.	Inventory No.	Cal Date (yyyy/mm/dd)	Cal Due Date (yyyy/mm/dd)
Shielding Room	Brilliant-emc	N/A	SUWI-04-03-01	2021/05/08	2024/05/07
Artificial network	ROHDE&SCHWARZ	ENV216	SUWI-01-19-01	2022/02/19	2023/02/18
Artificial network	ROHDE&SCHWARZ	ENV216	SUWI-01-19-02	2022/02/19	2023/02/18
Measurement Software	Tonscend	JS32-CE V4.0.0.2	SUWI-02-09-05	NCR	NCR
Test receiver	ROHDE&SCHWARZ	ESR7	SUWI-01-10-01	2022/02/19	2023/02/18
Temperature and humidity meter	MingGao	TH101B	SUWI-01-01-06	2022/02/16	2023/02/15
DC Power Supply	HYELEC	HY3005B	SUWI-01-18-01	2022/02/15	2023/02/14



Unless otherwise agreed in writing, this document is issued by the Company subject to its General Conditions of Service printed overleaf, available on request or accessible at <http://www.sgs.com/en/Terms-and-Conditions.aspx> and, for electronic format documents, subject to Terms and Conditions for Electronic Documents at <http://www.sgs.com/en/Terms-and-Conditions/Terms-e-Documents.aspx>. Attention is drawn to the limitation of liability, indemnification and jurisdiction issues defined therein. Any holder of this document is advised that information contained hereon reflects the Company's findings at the time of its intervention only and within the limits of Client's instructions, if any. The Company's sole responsibility is to its Client and this document does not exonerate parties to a transaction from exercising all their rights and obligations under the transaction documents. This document cannot be reproduced except in full, without prior written approval of the Company. Any unauthorized alteration, forgery or falsification of the content or appearance of this document is unlawful and offenders may be prosecuted to the fullest extent of the law. Unless otherwise stated the results shown in this test report refer only to the sample(s) tested and such sample(s) are retained for 30 days only.

Attention: To check the authenticity of testing/inspection report & certificate, please contact us at telephone: (86-755) 8307 1443, or email: CN.Doccheck@sgs.com

SGS-CSTC Standards Technical Services (Suzhou) Co., Ltd.
Wireless Laboratory

South of No. 6 Plant, No. 1, Runsheng Road, Suzhou Industrial Park, Suzhou Area, China (Jiangsu) Pilot Free Trade Zone 215000
中国·苏州·中国(江苏)自由贸易试验区苏州片区苏州工业园区润胜路1号的6号厂房南楼 邮编: 215000

t (86-512) 62992980 www.sgs.com.cn
t (86-512) 62992980 sgs.china@sgs.com

Report No.: SEWM2207000133RG02

Rev.: 01

Page: 29 of 79

RSE Test System					
Equipment	Manufacturer	Model No.	Inventory No.	Cal Date (yyyy/mm/dd)	Cal Due Date (yyyy/mm/dd)
Semi-Anechoic Chamber	Brilliant-emc	N/A	SUWI-04-02-01	2021/05/08	2024/05/07
Temperature and humidity meter	MingGao	TH101B	SUWI-01-01-05	2022/02/16	2023/02/15
Signal Analyzer	ROHDE&SCHWARZ	FSW43	SUWI-01-02-04	2022/05/28	2023/05/27
Signal Analyzer	KEYSIGHT	N9020A	SUWI-01-02-05	2021/12/04	2022/12/03
Test receiver	ROHDE&SCHWARZ	ESR7	SUWI-01-10-01	2022/02/19	2023/02/18
Receiving antenna	SCHWRZBECK MESS-ELEKTRONIK	VULB 9163	SUWI-01-11-01	2021/05/16	2023/05/15
Receiving antenna	SCHWRZBECK MESS-ELEKTRONIK	BBHA 9120D	SUWI-01-11-02	2021/05/16	2023/05/15
Receiving antenna	SCHWRZBECK MESS-ELEKTRONIK	BBHA 9170	SUWI-01-11-03	2021/05/14	2023/05/13
Amplifier	Tonscend	TAP9K3G40	SUWI-01-14-01	2022/02/14	2023/02/13
Amplifier	Tonscend	TAP01018050	SUWI-01-14-02	2022/02/14	2023/02/13
Amplifier	Tonscend	TAP18040048	SUWI-01-14-03	2022/02/19	2023/02/18
Active Loop Antenna	SCHWRZBECK MESS-ELEKTRONIK	FMZB 1519B	SUWI-01-21-01	2021/06/10	2023/06/09
Measurement Software	Tonscend	JS32-RSE V4.0.0.0	SUWI-02-09-06	NCR	NCR



Unless otherwise agreed in writing, this document is issued by the Company subject to its General Conditions of Service printed overleaf, available on request or accessible at <http://www.sgs.com/en/Terms-and-Conditions.aspx> and, for electronic format documents, subject to Terms and Conditions for Electronic Documents at <http://www.sgs.com/en/Terms-and-Conditions/Terms-e-Documents.aspx>. Attention is drawn to the limitation of liability, indemnification and jurisdiction issues defined therein. Any holder of this document is advised that information contained hereon reflects the Company's findings at the time of its intervention only and within the limits of Client's instructions, if any. The Company's sole responsibility is to its Client and this document does not exonerate parties to a transaction from exercising all their rights and obligations under the transaction documents. This document cannot be reproduced except in full, without prior written approval of the Company. Any unauthorized alteration, forgery or falsification of the content or appearance of this document is unlawful and offenders may be prosecuted to the fullest extent of the law. Unless otherwise stated the results shown in this test report refer only to the sample(s) tested and such sample(s) are retained for 30 days only.
Attention: To check the authenticity of testing/inspection report & certificate, please contact us at telephone: (86-755) 8307 1443, or email: CN.Doccheck@sgs.com

South of No. 6 Plant, No. 1, Runsheng Road, Suzhou Industrial Park, Suzhou Area, China (Jiangsu) Pilot Free Trade Zone 215000
 中国·苏州·中国(江苏)自由贸易试验区苏州片区苏州工业园区润胜路1号的6号厂房南楼 邮编: 215000

t (86-512) 62992980 www.sgs.com.cn
 t (86-512) 62992980 sgs.china@sgs.com

Report No.: SEWM2207000133RG02

Rev.: 01

Page: 30 of 79

7 Photographs - Setup Photos

Refer to Appendix A.2 WLAN Setup Photos.



Unless otherwise agreed in writing, this document is issued by the Company subject to its General Conditions of Service printed overleaf, available on request or accessible at <http://www.sgs.com/en/Terms-and-Conditions.aspx> and, for electronic format documents, subject to Terms and Conditions for Electronic Documents at <http://www.sgs.com/en/Terms-and-Conditions/Terms-e-Documents.aspx>. Attention is drawn to the limitation of liability, indemnification and jurisdiction issues defined therein. Any holder of this document is advised that information contained hereon reflects the Company's findings at the time of its intervention only and within the limits of Client's instructions, if any. The Company's sole responsibility is to its Client and this document does not exonerate parties to a transaction from exercising all their rights and obligations under the transaction documents. This document cannot be reproduced except in full, without prior written approval of the Company. Any unauthorized alteration, forgery or falsification of the content or appearance of this document is unlawful and offenders may be prosecuted to the fullest extent of the law. Unless otherwise stated the results shown in this test report refer only to the sample(s) tested and such sample(s) are retained for 30 days only.
Attention: To check the authenticity of testing/inspection report & certificate, please contact us at telephone: (86-755) 8307 1443, or email: CN.Doccheck@sgs.com

SGS-CSTC Standards Technical Services (Suzhou) Co., Ltd.
Wireless Laboratory

South of No. 6 Plant, No. 1, Runsheng Road, Suzhou Industrial Park, Suzhou Area, China (Jiangsu) Pilot Free Trade Zone 215000
中国·苏州·中国(江苏)自由贸易试验区苏州片区苏州工业园区润胜路1号的6号厂房南楼 邮编: 215000

t (86-512) 62992980 www.sgs.com.cn
t (86-512) 62992980 sgs.china@sgs.com

Report No.: SEWM2207000133RG02

Rev.: 01

Page: 31 of 79

Appendix



Unless otherwise agreed in writing, this document is issued by the Company subject to its General Conditions of Service printed overleaf, available on request or accessible at <http://www.sgs.com/en/Terms-and-Conditions.aspx> and, for electronic format documents, subject to Terms and Conditions for Electronic Documents at <http://www.sgs.com/en/Terms-and-Conditions/Terms-e-Documents.aspx>. Attention is drawn to the limitation of liability, indemnification and jurisdiction issues defined therein. Any holder of this document is advised that information contained hereon reflects the Company's findings at the time of its intervention only and within the limits of Client's instructions, if any. The Company's sole responsibility is to its Client and this document does not exonerate parties to a transaction from exercising all their rights and obligations under the transaction documents. This document cannot be reproduced except in full, without prior written approval of the Company. Any unauthorized alteration, forgery or falsification of the content or appearance of this document is unlawful and offenders may be prosecuted to the fullest extent of the law. Unless otherwise stated the results shown in this test report refer only to the sample(s) tested and such sample(s) are retained for 30 days only.
Attention: To check the authenticity of testing/inspection report & certificate, please contact us at telephone: (86-755) 8307 1443, or email: CN.Doccheck@sgs.com

SGS-CSTC Standards Technical Services (Suzhou) Co., Ltd.
Wireless Laboratory

South of No. 6 Plant, No. 1, Runsheng Road, Suzhou Industrial Park, Suzhou Area, China (Jiangsu) Pilot Free Trade Zone 215000
中国·苏州·中国(江苏)自由贸易试验区苏州片区苏州工业园区润胜路1号的6号厂房南楼 邮编: 215000

t (86-512) 62992980 www.sgs.com.cn
t (86-512) 62992980 sgs.china@sgs.com

Report No.: SEWM2207000133RG02

Rev.: 01

Page: 32 of 79

**DTS Bandwidth
Test Result**

TestMode	Antenna	Frequency[MHz]	DTS BW [MHz]	FL[MHz]	FH[MHz]	Limit[MHz]	Verdict
BLE_1M	Ant1	2402	0.68	2401.67	2402.35	≥0.5	PASS
		2440	0.68	2439.67	2440.35	≥0.5	PASS
		2480	0.68	2479.66	2480.35	≥0.5	PASS
BLE_2M	Ant1	2402	1.16	2401.43	2402.59	≥0.5	PASS
		2440	1.16	2439.43	2440.59	≥0.5	PASS
		2480	1.16	2479.43	2480.59	≥0.5	PASS



Unless otherwise agreed in writing, this document is issued by the Company subject to its General Conditions of Service printed overleaf, available on request or accessible at <http://www.sgs.com/en/Terms-and-Conditions.aspx> and, for electronic format documents, subject to Terms and Conditions for Electronic Documents at <http://www.sgs.com/en/Terms-and-Conditions/Terms-e-Documents.aspx>. Attention is drawn to the limitation of liability, indemnification and jurisdiction issues defined therein. Any holder of this document is advised that information contained hereon reflects the Company's findings at the time of its intervention only and within the limits of Client's instructions, if any. The Company's sole responsibility is to its Client and this document does not exonerate parties to a transaction from exercising all their rights and obligations under the transaction documents. This document cannot be reproduced except in full, without prior written approval of the Company. Any unauthorized alteration, forgery or falsification of the content or appearance of this document is unlawful and offenders may be prosecuted to the fullest extent of the law. Unless otherwise stated the results shown in this test report refer only to the sample(s) tested and such sample(s) are retained for 30 days only.
Attention: To check the authenticity of testing/inspection report & certificate, please contact us at telephone: (86-755) 8307 1443, or email: CN.Doccheck@sgs.com

SGS-CSTC Standards Technical Services (Suzhou) Co., Ltd.
 Wireless Laboratory

South of No. 6 Plant, No. 1, Runsheng Road, Suzhou Industrial Park, Suzhou Area, China (Jiangsu) Pilot Free Trade Zone 215000 t (86-512) 62992980 www.sgs.com.cn
 中国·苏州·中国(江苏)自由贸易试验区苏州片区苏州工业园区润胜路1号的6号厂房南楼 邮编: 215000 t (86-512) 62992980 sgs.china@sgs.com

Test Graphs

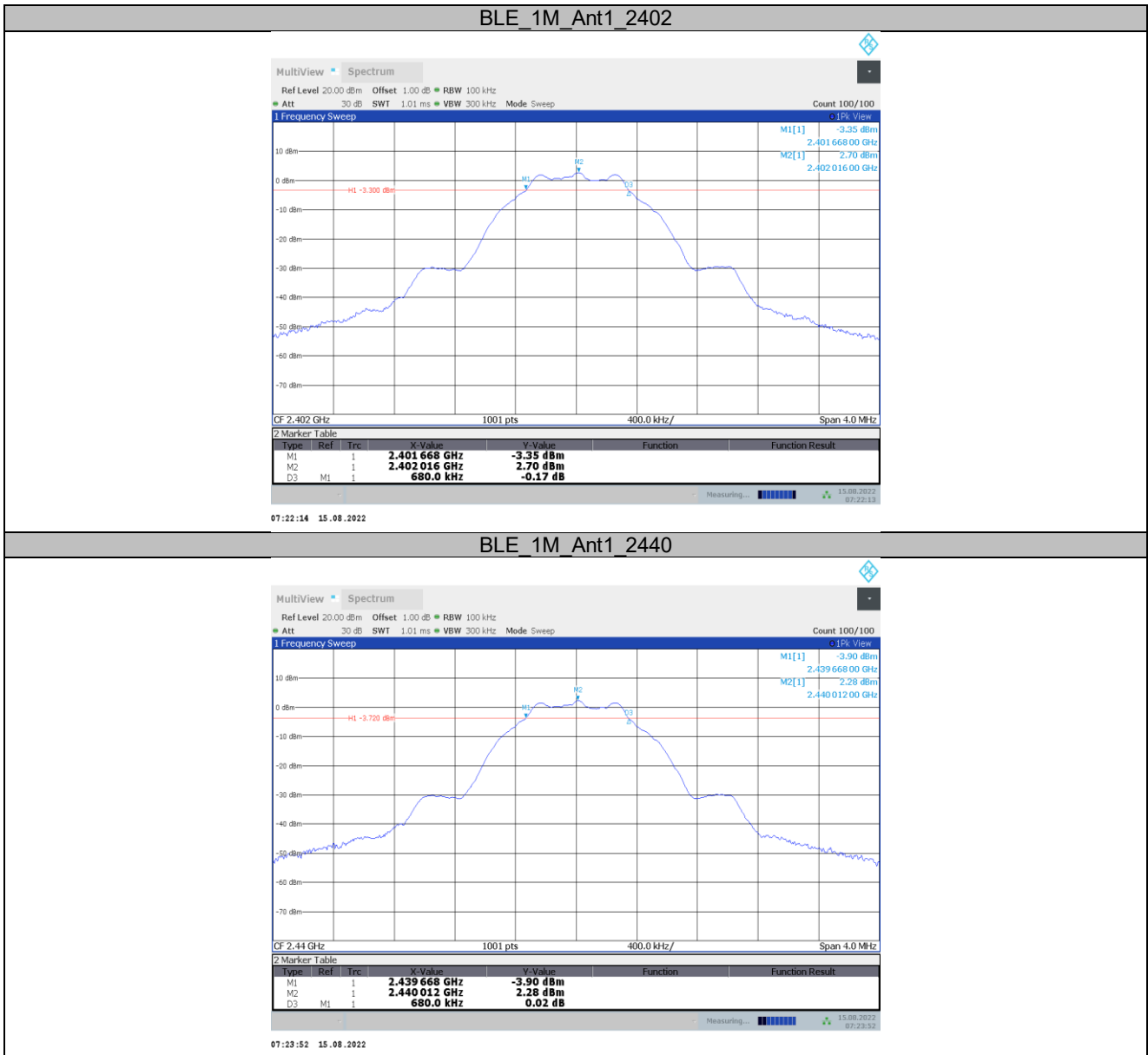

Unless otherwise agreed in writing, this document is issued by the Company subject to its General Conditions of Service printed overleaf, available on request or accessible at <http://www.sgs.com/en/Terms-and-Conditions.aspx> and, for electronic format documents, subject to Terms and Conditions for Electronic Documents at <http://www.sgs.com/en/Terms-and-Conditions/Terms-e-Documents.aspx>. Attention is drawn to the limitation of liability, indemnification and jurisdiction issues defined therein. Any holder of this document is advised that information contained hereon reflects the Company's findings at the time of its intervention only and within the limits of Client's instructions, if any. The Company's sole responsibility is to its Client and this document does not exonerate parties to a transaction from exercising all their rights and obligations under the transaction documents. This document cannot be reproduced except in full, without prior written approval of the Company. Any unauthorized alteration, forgery or falsification of the content or appearance of this document is unlawful and offenders may be prosecuted to the fullest extent of the law. Unless otherwise stated the results shown in this test report refer only to the sample(s) tested and such sample(s) are retained for 30 days only.

Attention: To check the authenticity of testing/inspection report & certificate, please contact us at telephone: (86-755) 8307 1443, or email: CN.Doccheck@sgs.com

South of No. 6 Plant, No. 1, Runsheng Road, Suzhou Industrial Park, Suzhou Area, China (Jiangsu) Pilot Free Trade Zone 215000 t (86-512) 62992980 www.sgs.com.cn
 中国·苏州·中国(江苏)自由贸易试验区苏州片区苏州工业园区润胜路1号的6号厂房南楼 邮编: 215000 t (86-512) 62992980 sgs.china@sgs.com

BLE_1M_Ant1_2480

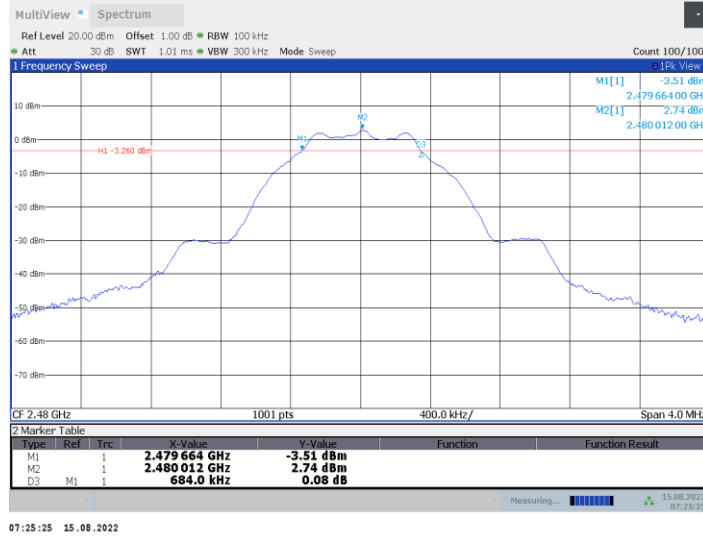

BLE_2M_Ant1_2402

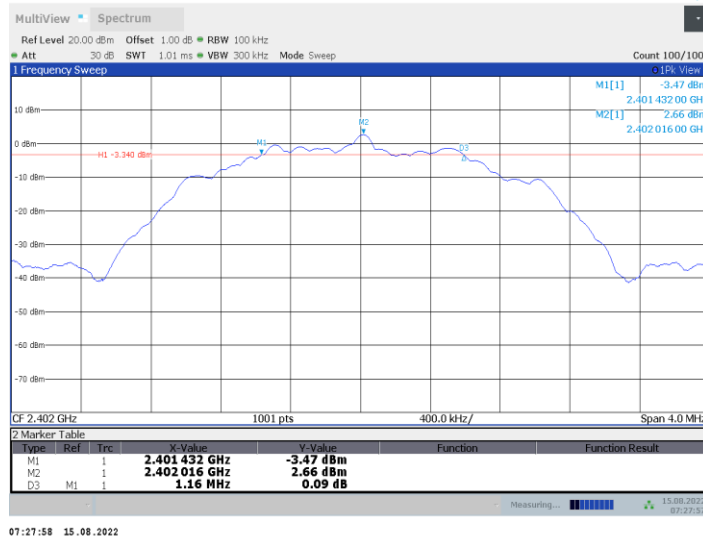

Unless otherwise agreed in writing, this document is issued by the Company subject to its General Conditions of Service printed overleaf, available on request or accessible at <http://www.sgs.com/en/Terms-and-Conditions.aspx> and, for electronic format documents, subject to Terms and Conditions for Electronic Documents at <http://www.sgs.com/en/Terms-and-Conditions/Terms-e-Documents.aspx>. Attention is drawn to the limitation of liability, indemnification and jurisdiction issues defined therein. Any holder of this document is advised that information contained hereon reflects the Company's findings at the time of its intervention only and within the limits of Client's instructions, if any. The Company's sole responsibility is to its Client and this document does not exonerate parties to a transaction from exercising all their rights and obligations under the transaction documents. This document cannot be reproduced except in full, without prior written approval of the Company. Any unauthorized alteration, forgery or falsification of the content or appearance of this document is unlawful and offenders may be prosecuted to the fullest extent of the law. Unless otherwise stated the results shown in this test report refer only to the sample(s) tested and such sample(s) are retained for 30 days only.

Attention: To check the authenticity of testing/inspection report & certificate, please contact us at telephone: (86-755) 8307 1443, or email: CN.Doccheck@sgs.com

BLE_2M_Ant1_2440

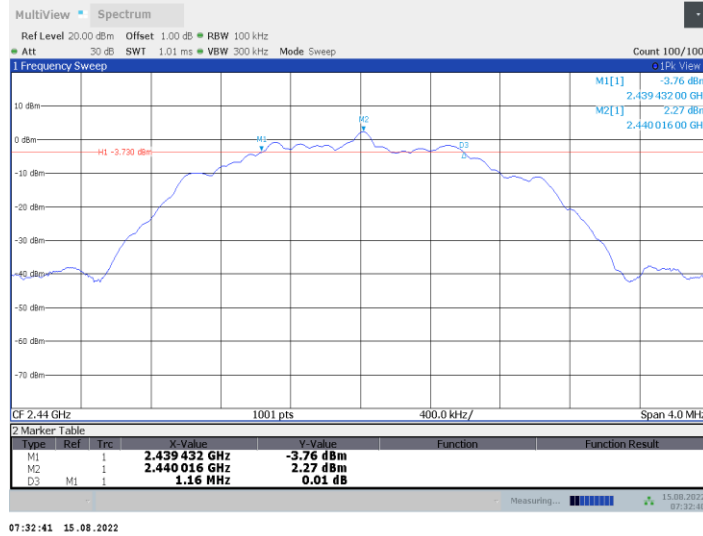

BLE_2M_Ant1_2480

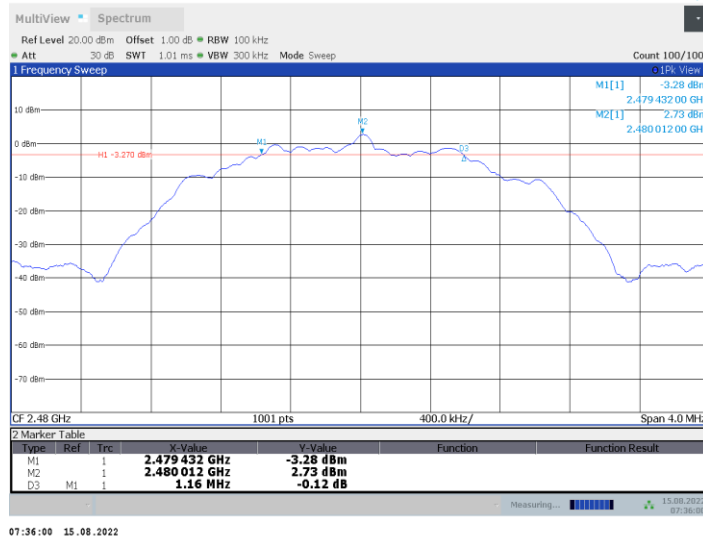

Unless otherwise agreed in writing, this document is issued by the Company subject to its General Conditions of Service printed overleaf, available on request or accessible at <http://www.sgs.com/en/Terms-and-Conditions.aspx> and, for electronic format documents, subject to Terms and Conditions for Electronic Documents at <http://www.sgs.com/en/Terms-and-Conditions/Terms-e-Documents.aspx>. Attention is drawn to the limitation of liability, indemnification and jurisdiction issues defined therein. Any holder of this document is advised that information contained hereon reflects the Company's findings at the time of its intervention only and within the limits of Client's instructions, if any. The Company's sole responsibility is to its Client and this document does not exonerate parties to a transaction from exercising all their rights and obligations under the transaction documents. This document cannot be reproduced except in full, without prior written approval of the Company. Any unauthorized alteration, forgery or falsification of the content or appearance of this document is unlawful and offenders may be prosecuted to the fullest extent of the law. Unless otherwise stated the results shown in this test report refer only to the sample(s) tested and such sample(s) are retained for 30 days only.

Attention: To check the authenticity of testing/inspection report & certificate, please contact us at telephone: (86-755) 8307 1443, or email: CN.Doccheck@sgs.com

South of No. 6 Plant, No. 1, Runsheng Road, Suzhou Industrial Park, Suzhou Area, China (Jiangsu) Pilot Free Trade Zone 215000 t (86-512) 62992980 www.sgs.com.cn
 中国·苏州·中国(江苏)自由贸易试验区苏州片区苏州工业园区润胜路1号的6号厂房南楼 邮编: 215000 t (86-512) 62992980 sgs.china@sgs.com

Report No.: SEWM2207000133RG02

Rev.: 01

Page: 36 of 79

Occupied Channel Bandwidth Test Result

TestMode	Antenna	Frequency[MHz]	OCB [MHz]	FL[MHz]	FH[MHz]	Verdict
BLE_1M	Ant1	2402	1.028	2401.502	2402.530	Reporting only
		2440	1.028	2439.501	2440.529	
		2480	1.028	2479.501	2480.529	
BLE_2M	Ant1	2402	2.045	2401.001	2403.047	
		2440	2.042	2439.002	2441.044	
		2480	2.045	2479.000	2481.045	



Unless otherwise agreed in writing, this document is issued by the Company subject to its General Conditions of Service printed overleaf, available on request or accessible at <http://www.sgs.com/en/Terms-and-Conditions.aspx> and, for electronic format documents, subject to Terms and Conditions for Electronic Documents at <http://www.sgs.com/en/Terms-and-Conditions/Terms-e-Documents.aspx>. Attention is drawn to the limitation of liability, indemnification and jurisdiction issues defined therein. Any holder of this document is advised that information contained hereon reflects the Company's findings at the time of its intervention only and within the limits of Client's instructions, if any. The Company's sole responsibility is to its Client and this document does not exonerate parties to a transaction from exercising all their rights and obligations under the transaction documents. This document cannot be reproduced except in full, without prior written approval of the Company. Any unauthorized alteration, forgery or falsification of the content or appearance of this document is unlawful and offenders may be prosecuted to the fullest extent of the law. Unless otherwise stated the results shown in this test report refer only to the sample(s) tested and such sample(s) are retained for 30 days only.
Attention: To check the authenticity of testing/inspection report & certificate, please contact us at telephone: (86-755) 8307 1443, or email: CN.Doccheck@sgs.com

SGS-CSTC Standards Technical Services (Suzhou) Co., Ltd.
Wireless Laboratory

South of No. 6 Plant, No. 1, Runsheng Road, Suzhou Industrial Park, Suzhou Area, China (Jiangsu) Pilot Free Trade Zone 215000
 中国·苏州·中国(江苏)自由贸易试验区苏州片区苏州工业园区润胜路1号的6号厂房南楼 邮编: 215000

t (86-512) 62992980 www.sgs.com.cn
 t (86-512) 62992980 sgs.china@sgs.com

Test Graphs

BLE_1M_Ant1_2402

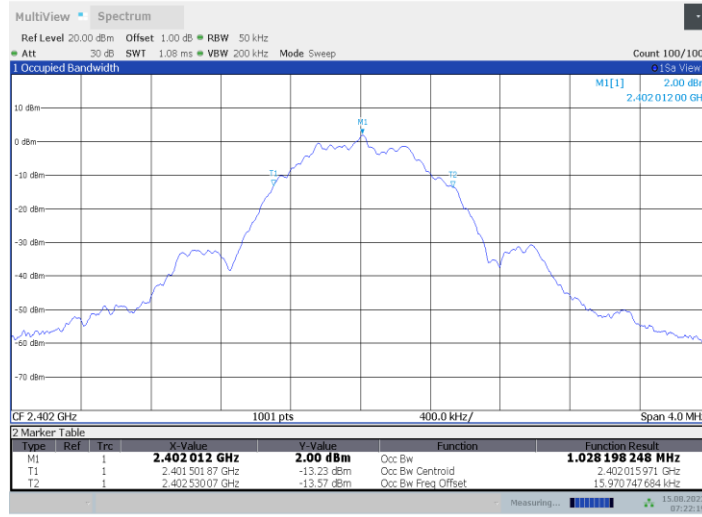

07:22:19 15.08.2022

BLE_1M_Ant1_2440



07:23:58 15.08.2022



Unless otherwise agreed in writing, this document is issued by the Company subject to its General Conditions of Service printed overleaf, available on request or accessible at <http://www.sgs.com/en/Terms-and-Conditions.aspx> and, for electronic format documents, subject to Terms and Conditions for Electronic Documents at <http://www.sgs.com/en/Terms-and-Conditions/Terms-e-Documents.aspx>. Attention is drawn to the limitation of liability, indemnification and jurisdiction issues defined therein. Any holder of this document is advised that information contained hereon reflects the Company's findings at the time of its intervention only and within the limits of Client's instructions, if any. The Company's sole responsibility is to its Client and this document does not exonerate parties to a transaction from exercising all their rights and obligations under the transaction documents. This document cannot be reproduced except in full, without prior written approval of the Company. Any unauthorized alteration, forgery or falsification of the content or appearance of this document is unlawful and offenders may be prosecuted to the fullest extent of the law. Unless otherwise stated the results shown in this test report refer only to the sample(s) tested and such sample(s) are retained for 30 days only.

Attention: To check the authenticity of testing/inspection report & certificate, please contact us at telephone: (86-755) 8307 1443, or email: CN.Doccheck@sgs.com

South of No. 6 Plant, No. 1, Runsheng Road, Suzhou Industrial Park, Suzhou Area, China (Jiangsu) Pilot Free Trade Zone 215000 t (86-512) 62992980 www.sgs.com.cn
 中国·苏州·中国(江苏)自由贸易试验区苏州片区苏州工业园区润胜路1号的6号厂房南楼 邮编: 215000 t (86-512) 62992980 sgs.china@sgs.com

BLE_1M_Ant1_2480

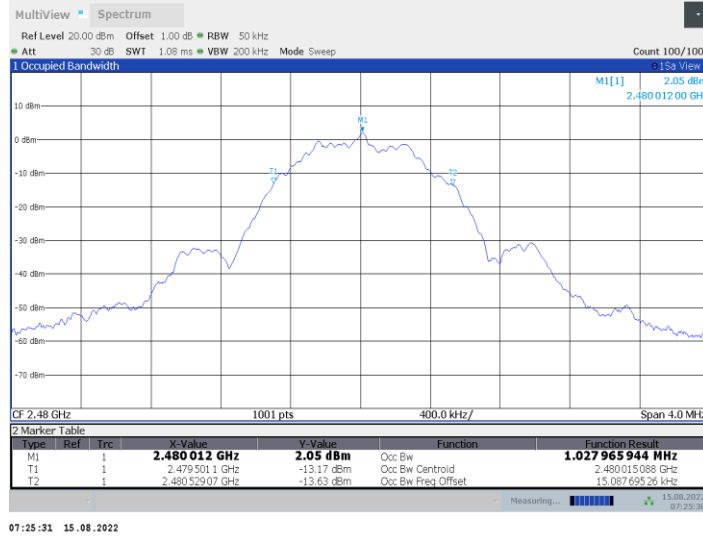

BLE_2M_Ant1_2402



Unless otherwise agreed in writing, this document is issued by the Company subject to its General Conditions of Service printed overleaf, available on request or accessible at <http://www.sgs.com/en/Terms-and-Conditions.aspx> and, for electronic format documents, subject to Terms and Conditions for Electronic Documents at <http://www.sgs.com/en/Terms-and-Conditions/Terms-e-Documents.aspx>. Attention is drawn to the limitation of liability, indemnification and jurisdiction issues defined therein. Any holder of this document is advised that information contained hereon reflects the Company's findings at the time of its intervention only and within the limits of Client's instructions, if any. The Company's sole responsibility is to its Client and this document does not exonerate parties to a transaction from exercising all their rights and obligations under the transaction documents. This document cannot be reproduced except in full, without prior written approval of the Company. Any unauthorized alteration, forgery or falsification of the content or appearance of this document is unlawful and offenders may be prosecuted to the fullest extent of the law. Unless otherwise stated the results shown in this test report refer only to the sample(s) tested and such sample(s) are retained for 30 days only.

Attention: To check the authenticity of testing/inspection report & certificate, please contact us at telephone: (86-755) 8307 1443, or email: CN.Doccheck@sgs.com

South of No. 6 Plant, No. 1, Runsheng Road, Suzhou Industrial Park, Suzhou Area, China (Jiangsu) Pilot Free Trade Zone 215000
 中国·苏州·中国(江苏)自由贸易试验区苏州片区苏州工业园区润胜路1号的6号厂房南楼 邮编: 215000

t (86-512) 62992980 www.sgs.com.cn
 t (86-512) 62992980 sgs.china@sgs.com

BLE_2M_Ant1_2440

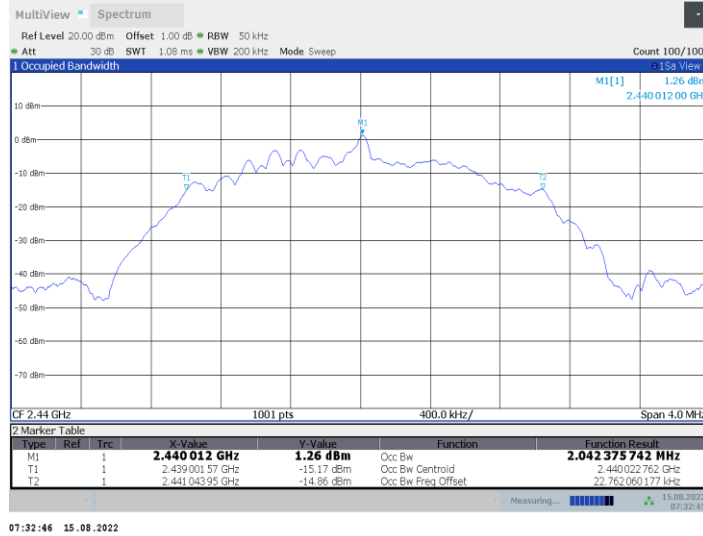

BLE_2M_Ant1_2480



Unless otherwise agreed in writing, this document is issued by the Company subject to its General Conditions of Service printed overleaf, available on request or accessible at <http://www.sgs.com/en/Terms-and-Conditions.aspx> and, for electronic format documents, subject to Terms and Conditions for Electronic Documents at <http://www.sgs.com/en/Terms-and-Conditions/Terms-e-Documents.aspx>. Attention is drawn to the limitation of liability, indemnification and jurisdiction issues defined therein. Any holder of this document is advised that information contained hereon reflects the Company's findings at the time of its intervention only and within the limits of Client's instructions, if any. The Company's sole responsibility is to its Client and this document does not exonerate parties to a transaction from exercising all their rights and obligations under the transaction documents. This document cannot be reproduced except in full, without prior written approval of the Company. Any unauthorized alteration, forgery or falsification of the content or appearance of this document is unlawful and offenders may be prosecuted to the fullest extent of the law. Unless otherwise stated the results shown in this test report refer only to the sample(s) tested and such sample(s) are retained for 30 days only.

Attention: To check the authenticity of testing/inspection report & certificate, please contact us at telephone: (86-755) 8307 1443, or email: CN.Doccheck@sgs.com

South of No. 6 Plant, No. 1, Runsheng Road, Suzhou Industrial Park, Suzhou Area, China (Jiangsu) Pilot Free Trade Zone 215000
 中国·苏州·中国(江苏)自由贸易试验区苏州片区苏州工业园区润胜路1号的6号厂房南楼 邮编: 215000

t (86-512) 62992980 www.sgs.com.cn
 t (86-512) 62992980 sgs.china@sgs.com

Report No.: SEWM2207000133RG02

Rev.: 01

Page: 40 of 79

**Maximum conducted output power
Test Result Peak**

TestMode	Antenna	Frequency[MHz]	Conducted Peak Power[dBm]	Conducted Limit[dBm]	Verdict
BLE_1M	Ant1	2402	2.58	≤30	PASS
		2440	2.35	≤30	PASS
		2480	2.79	≤30	PASS
BLE_2M	Ant1	2402	2.63	≤30	PASS
		2440	2.42	≤30	PASS
		2480	3.02	≤30	PASS



Unless otherwise agreed in writing, this document is issued by the Company subject to its General Conditions of Service printed overleaf, available on request or accessible at <http://www.sgs.com/en/Terms-and-Conditions.aspx> and, for electronic format documents, subject to Terms and Conditions for Electronic Documents at <http://www.sgs.com/en/Terms-and-Conditions/Terms-e-Documents.aspx>. Attention is drawn to the limitation of liability, indemnification and jurisdiction issues defined therein. Any holder of this document is advised that information contained hereon reflects the Company's findings at the time of its intervention only and within the limits of Client's instructions, if any. The Company's sole responsibility is to its Client and this document does not exonerate parties to a transaction from exercising all their rights and obligations under the transaction documents. This document cannot be reproduced except in full, without prior written approval of the Company. Any unauthorized alteration, forgery or falsification of the content or appearance of this document is unlawful and offenders may be prosecuted to the fullest extent of the law. Unless otherwise stated the results shown in this test report refer only to the sample(s) tested and such sample(s) are retained for 30 days only.
Attention: To check the authenticity of testing/inspection report & certificate, please contact us at telephone: (86-755) 8307 1443, or email: CN.Doccheck@sgs.com

SGS-CSTC Standards Technical Services (Suzhou) Co., Ltd.
 Wireless Laboratory

South of No. 6 Plant, No. 1, Runsheng Road, Suzhou Industrial Park, Suzhou Area, China (Jiangsu) Pilot Free Trade Zone 215000 t (86-512) 62992980 www.sgs.com.cn
 中国·苏州·中国(江苏)自由贸易试验区苏州片区苏州工业园区润胜路1号的6号厂房南楼 邮编: 215000 t (86-512) 62992980 sgs.china@sgs.com

Report No.: SEWM2207000133RG02

Rev.: 01

Page: 41 of 79

Maximum power spectral density Test Result

TestMode	Antenna	Frequency[MHz]	Result[dBm/3kHz]	Limit[dBm/3kHz]	Verdict
BLE_1M	Ant1	2402	-12	≤8.00	PASS
		2440	-12.41	≤8.00	PASS
		2480	-12.01	≤8.00	PASS
BLE_2M	Ant1	2402	-15.64	≤8.00	PASS
		2440	-16.09	≤8.00	PASS
		2480	-15.61	≤8.00	PASS



Unless otherwise agreed in writing, this document is issued by the Company subject to its General Conditions of Service printed overleaf, available on request or accessible at <http://www.sgs.com/en/Terms-and-Conditions.aspx> and, for electronic format documents, subject to Terms and Conditions for Electronic Documents at <http://www.sgs.com/en/Terms-and-Conditions/Terms-e-Documents.aspx>. Attention is drawn to the limitation of liability, indemnification and jurisdiction issues defined therein. Any holder of this document is advised that information contained hereon reflects the Company's findings at the time of its intervention only and within the limits of Client's instructions, if any. The Company's sole responsibility is to its Client and this document does not exonerate parties to a transaction from exercising all their rights and obligations under the transaction documents. This document cannot be reproduced except in full, without prior written approval of the Company. Any unauthorized alteration, forgery or falsification of the content or appearance of this document is unlawful and offenders may be prosecuted to the fullest extent of the law. Unless otherwise stated the results shown in this test report refer only to the sample(s) tested and such sample(s) are retained for 30 days only.
Attention: To check the authenticity of testing/inspection report & certificate, please contact us at telephone: (86-755) 8307 1443, or email: CN.Doccheck@sgs.com

SGS-CSTC Standards Technical Services (Suzhou) Co., Ltd.
Wireless Laboratory

South of No. 6 Plant, No. 1, Runsheng Road, Suzhou Industrial Park, Suzhou Area, China (Jiangsu) Pilot Free Trade Zone 215000
中国·苏州·中国(江苏)自由贸易试验区苏州片区苏州工业园区润胜路1号的6号厂房南楼 邮编: 215000

t (86-512) 62992980 www.sgs.com.cn
t (86-512) 62992980 sgs.china@sgs.com

Test Graphs

BLE_1M_Ant1_2402

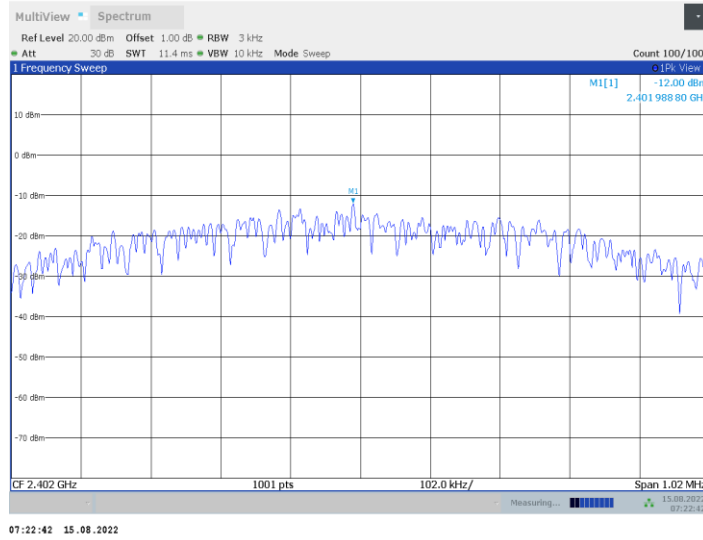

BLE_1M_Ant1_2440

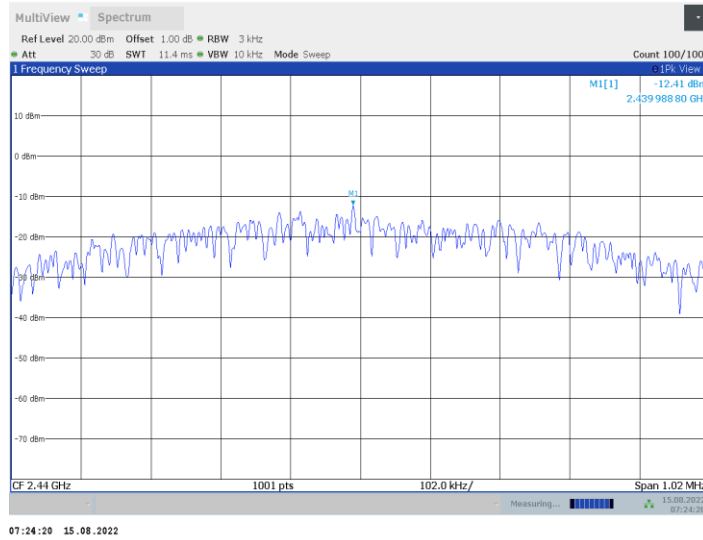

Unless otherwise agreed in writing, this document is issued by the Company subject to its General Conditions of Service printed overleaf, available on request or accessible at <http://www.sgs.com/en/Terms-and-Conditions.aspx> and, for electronic format documents, subject to Terms and Conditions for Electronic Documents at <http://www.sgs.com/en/Terms-and-Conditions/Terms-e-Documents.aspx>. Attention is drawn to the limitation of liability, indemnification and jurisdiction issues defined therein. Any holder of this document is advised that information contained hereon reflects the Company's findings at the time of its intervention only and within the limits of Client's instructions, if any. The Company's sole responsibility is to its Client and this document does not exonerate parties to a transaction from exercising all their rights and obligations under the transaction documents. This document cannot be reproduced except in full, without prior written approval of the Company. Any unauthorized alteration, forgery or falsification of the content or appearance of this document is unlawful and offenders may be prosecuted to the fullest extent of the law. Unless otherwise stated the results shown in this test report refer only to the sample(s) tested and such sample(s) are retained for 30 days only.
Attention: To check the authenticity of testing/inspection report & certificate, please contact us at telephone: (86-755) 8307 1443, or email: CN.Doccheck@sgs.com
 South of No. 6 Plant, No. 1, Runsheng Road, Suzhou Industrial Park, Suzhou Area, China (Jiangsu) Pilot Free Trade Zone 215000 t (86-512) 62992980 www.sgs.com.cn
 中国·苏州·中国(江苏)自由贸易试验区苏州片区苏州工业园区润胜路1号的6号厂房南楼 邮编: 215000 t (86-512) 62992980 sgs.china@sgs.com

BLE_1M_Ant1_2480

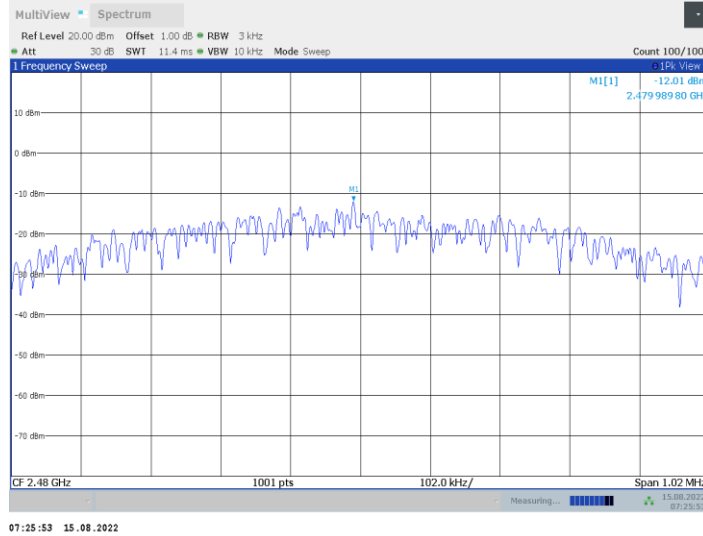

BLE_2M_Ant1_2402

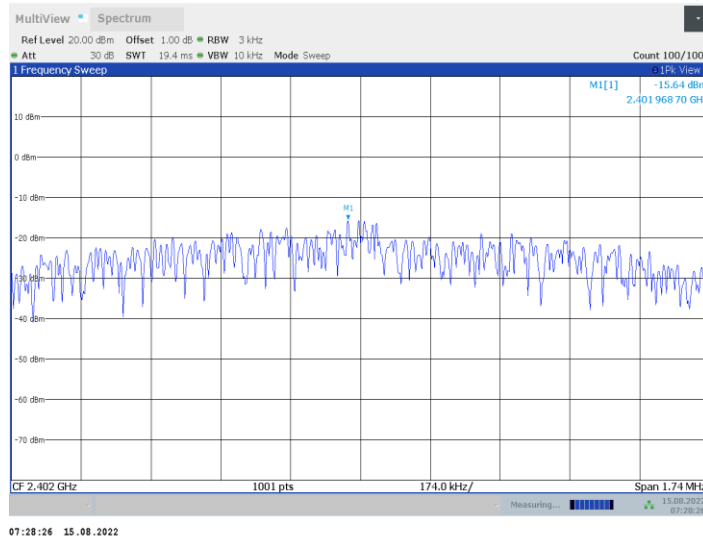

Unless otherwise agreed in writing, this document is issued by the Company subject to its General Conditions of Service printed overleaf, available on request or accessible at <http://www.sgs.com/en/Terms-and-Conditions.aspx> and, for electronic format documents, subject to Terms and Conditions for Electronic Documents at <http://www.sgs.com/en/Terms-and-Conditions/Terms-e-Documents.aspx>. Attention is drawn to the limitation of liability, indemnification and jurisdiction issues defined therein. Any holder of this document is advised that information contained hereon reflects the Company's findings at the time of its intervention only and within the limits of Client's instructions, if any. The Company's sole responsibility is to its Client and this document does not exonerate parties to a transaction from exercising all their rights and obligations under the transaction documents. This document cannot be reproduced except in full, without prior written approval of the Company. Any unauthorized alteration, forgery or falsification of the content or appearance of this document is unlawful and offenders may be prosecuted to the fullest extent of the law. Unless otherwise stated the results shown in this test report refer only to the sample(s) tested and such sample(s) are retained for 30 days only.

Attention: To check the authenticity of testing/inspection report & certificate, please contact us at telephone: (86-755) 8307 1443, or email: CN.Doccheck@sgs.com

South of No. 6 Plant, No. 1, Runsheng Road, Suzhou Industrial Park, Suzhou Area, China (Jiangsu) Pilot Free Trade Zone 215000 t (86-512) 62992980 www.sgs.com.cn
 中国·苏州·中国(江苏)自由贸易试验区苏州片区苏州工业园区润胜路1号的6号厂房南楼 邮编: 215000 t (86-512) 62992980 sgs.china@sgs.com

BLE_2M_Ant1_2440

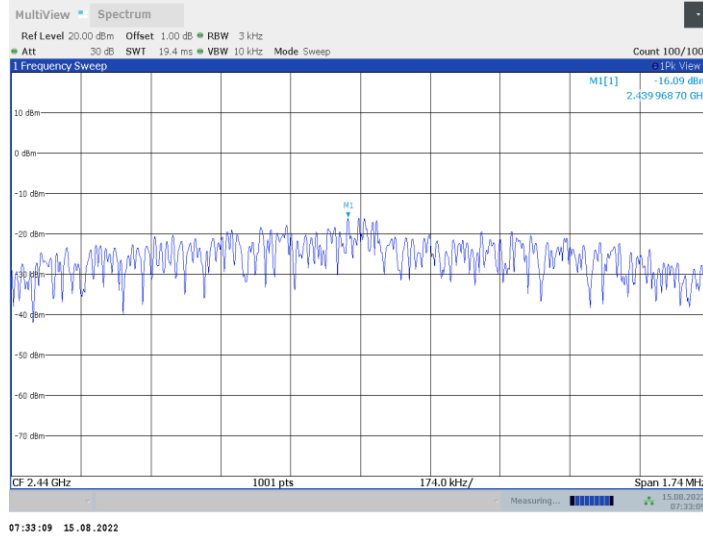

BLE_2M_Ant1_2480

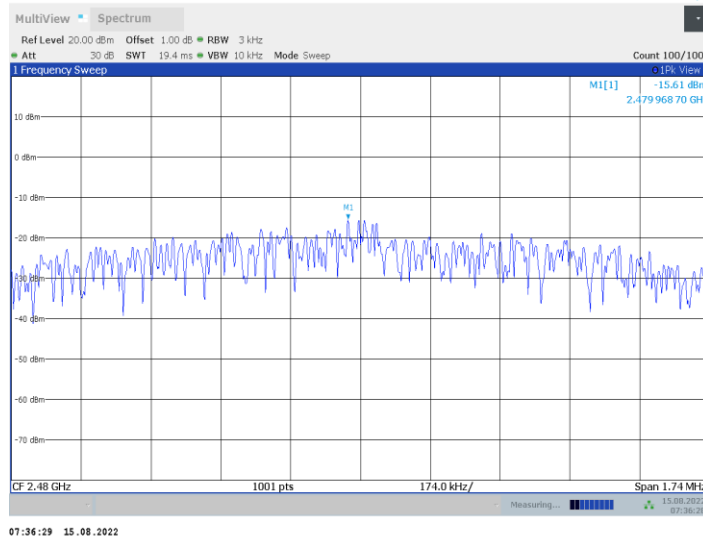

Unless otherwise agreed in writing, this document is issued by the Company subject to its General Conditions of Service printed overleaf, available on request or accessible at <http://www.sgs.com/en/Terms-and-Conditions.aspx> and, for electronic format documents, subject to Terms and Conditions for Electronic Documents at <http://www.sgs.com/en/Terms-and-Conditions/Terms-e-Documents.aspx>. Attention is drawn to the limitation of liability, indemnification and jurisdiction issues defined therein. Any holder of this document is advised that information contained hereon reflects the Company's findings at the time of its intervention only and within the limits of Client's instructions, if any. The Company's sole responsibility is to its Client and this document does not exonerate parties to a transaction from exercising all their rights and obligations under the transaction documents. This document cannot be reproduced except in full, without prior written approval of the Company. Any unauthorized alteration, forgery or falsification of the content or appearance of this document is unlawful and offenders may be prosecuted to the fullest extent of the law. Unless otherwise stated the results shown in this test report refer only to the sample(s) tested and such sample(s) are retained for 30 days only.

Attention: To check the authenticity of testing/inspection report & certificate, please contact us at telephone: (86-755) 8307 1443, or email: CN.Doccheck@sgs.com

Band edge measurements Test Graphs

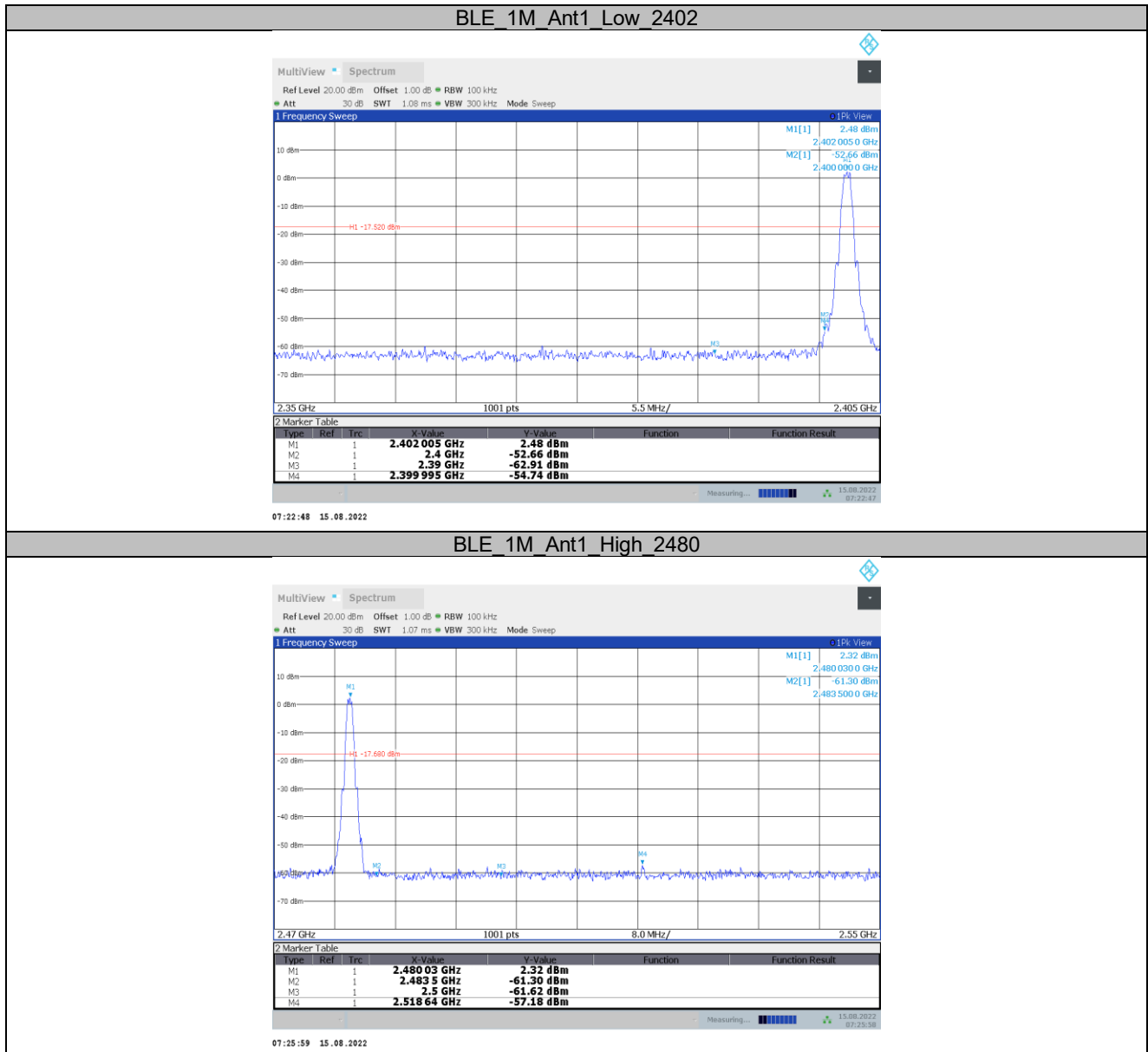

Unless otherwise agreed in writing, this document is issued by the Company subject to its General Conditions of Service printed overleaf, available on request or accessible at <http://www.sgs.com/en/Terms-and-Conditions.aspx> and, for electronic format documents, subject to Terms and Conditions for Electronic Documents at <http://www.sgs.com/en/Terms-and-Conditions/Terms-e-Documents.aspx>. Attention is drawn to the limitation of liability, indemnification and jurisdiction issues defined therein. Any holder of this document is advised that information contained hereon reflects the Company's findings at the time of its intervention only and within the limits of Client's instructions, if any. The Company's sole responsibility is to its Client and this document does not exonerate parties to a transaction from exercising all their rights and obligations under the transaction documents. This document cannot be reproduced except in full, without prior written approval of the Company. Any unauthorized alteration, forgery or falsification of the content or appearance of this document is unlawful and offenders may be prosecuted to the fullest extent of the law. Unless otherwise stated the results shown in this test report refer only to the sample(s) tested and such sample(s) are retained for 30 days only.

Attention: To check the authenticity of testing/inspection report & certificate, please contact us at telephone: (86-755) 8307 1443, or email: CN.Doccheck@sgs.com

South of No. 6 Plant, No. 1, Runsheng Road, Suzhou Industrial Park, Suzhou Area, China (Jiangsu) Pilot Free Trade Zone 215000 t (86-512) 62992980 www.sgs.com.cn
 中国·苏州·中国(江苏)自由贸易试验区苏州片区苏州工业园区润胜路1号的6号厂房南楼 邮编: 215000 t (86-512) 62992980 sgs.china@sgs.com

BLE 2M Ant1 Low 2402

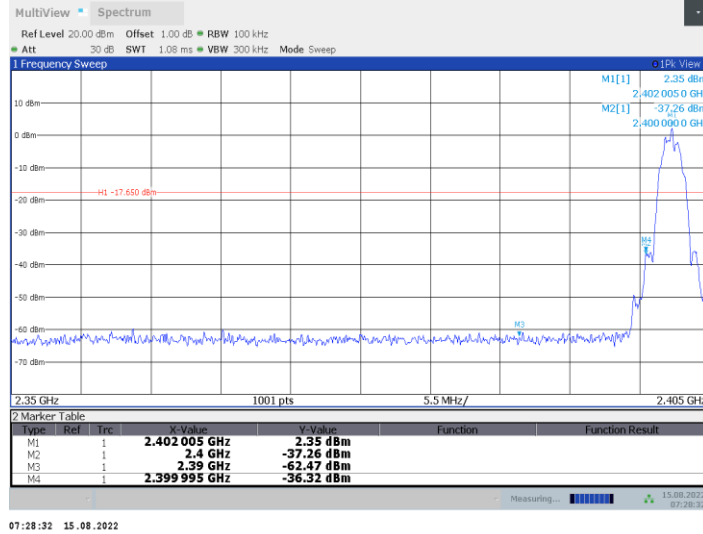

BLE 2M Ant1 High 2480

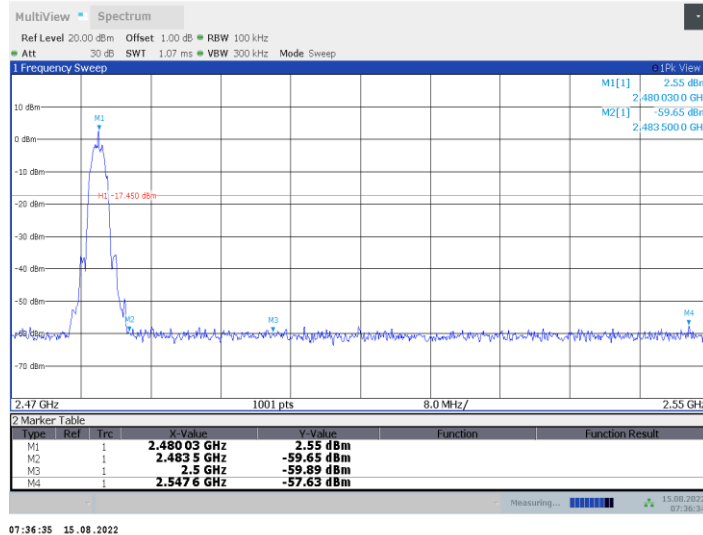

Unless otherwise agreed in writing, this document is issued by the Company subject to its General Conditions of Service printed overleaf, available on request or accessible at <http://www.sgs.com/en/Terms-and-Conditions.aspx> and, for electronic format documents, subject to Terms and Conditions for Electronic Documents at <http://www.sgs.com/en/Terms-and-Conditions/Terms-e-Documents.aspx>. Attention is drawn to the limitation of liability, indemnification and jurisdiction issues defined therein. Any holder of this document is advised that information contained hereon reflects the Company's findings at the time of its intervention only and within the limits of Client's instructions, if any. The Company's sole responsibility is to its Client and this document does not exonerate parties to a transaction from exercising all their rights and obligations under the transaction documents. This document cannot be reproduced except in full, without prior written approval of the Company. Any unauthorized alteration, forgery or falsification of the content or appearance of this document is unlawful and offenders may be prosecuted to the fullest extent of the law. Unless otherwise stated the results shown in this test report refer only to the sample(s) tested and such sample(s) are retained for 30 days only.

Attention: To check the authenticity of testing/inspection report & certificate, please contact us at telephone: (86-755) 8307 1443, or email: CN.Doccheck@sgs.com

Conducted Spurious Emission Test Graphs

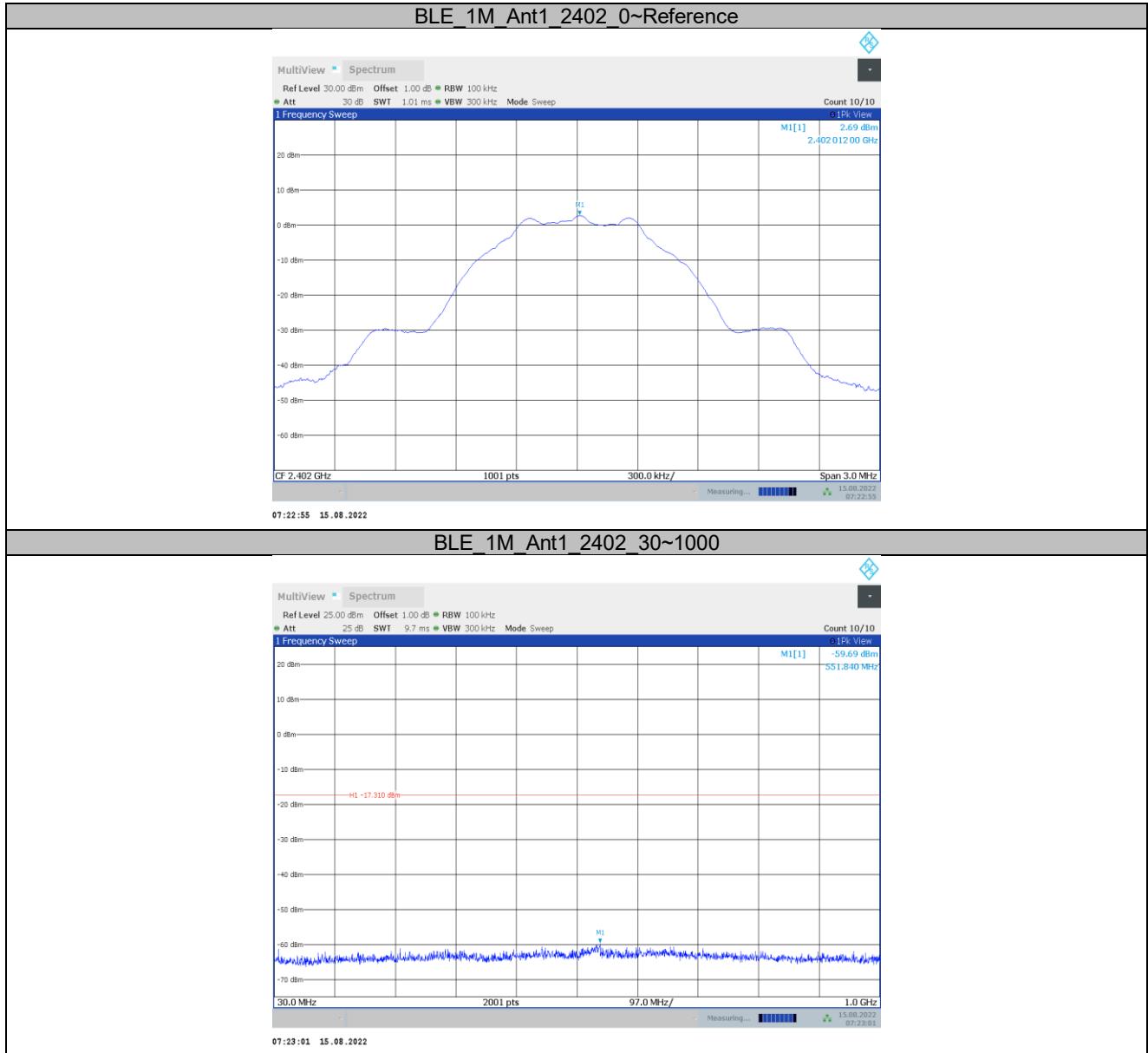

Unless otherwise agreed in writing, this document is issued by the Company subject to its General Conditions of Service printed overleaf, available on request or accessible at <http://www.sgs.com/en/Terms-and-Conditions.aspx> and, for electronic format documents, subject to Terms and Conditions for Electronic Documents at <http://www.sgs.com/en/Terms-and-Conditions/Terms-e-Documents.aspx>. Attention is drawn to the limitation of liability, indemnification and jurisdiction issues defined therein. Any holder of this document is advised that information contained hereon reflects the Company's findings at the time of its intervention only and within the limits of Client's instructions, if any. The Company's sole responsibility is to its Client and this document does not exonerate parties to a transaction from exercising all their rights and obligations under the transaction documents. This document cannot be reproduced except in full, without prior written approval of the Company. Any unauthorized alteration, forgery or falsification of the content or appearance of this document is unlawful and offenders may be prosecuted to the fullest extent of the law. Unless otherwise stated the results shown in this test report refer only to the sample(s) tested and such sample(s) are retained for 30 days only.

Attention: To check the authenticity of testing/inspection report & certificate, please contact us at telephone: (86-755) 8307 1443, or email: CN.Doccheck@sgs.com

BLE_1M_Ant1_2402_1000~26500

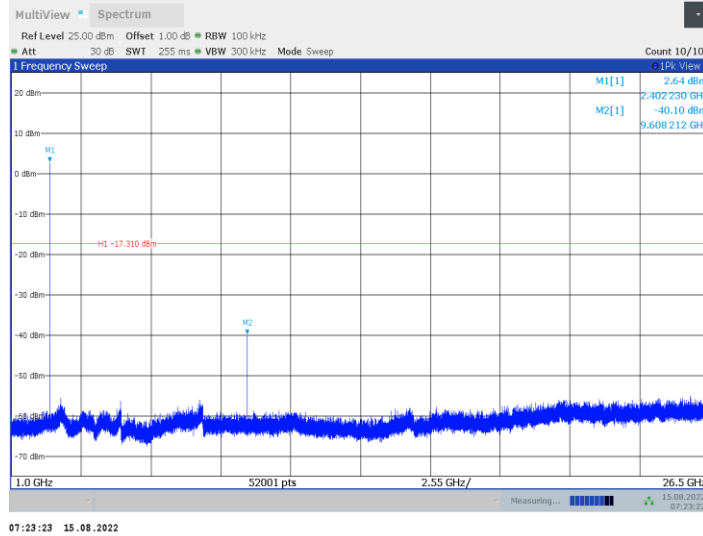

BLE_1M_Ant1_2440_0~Reference

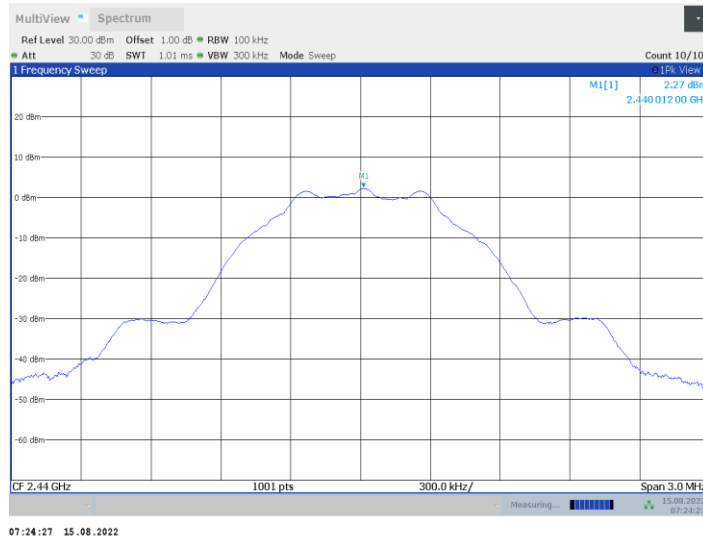

Unless otherwise agreed in writing, this document is issued by the Company subject to its General Conditions of Service printed overleaf, available on request or accessible at <http://www.sgs.com/en/Terms-and-Conditions.aspx> and, for electronic format documents, subject to Terms and Conditions for Electronic Documents at <http://www.sgs.com/en/Terms-and-Conditions/Terms-e-Documents.aspx>. Attention is drawn to the limitation of liability, indemnification and jurisdiction issues defined therein. Any holder of this document is advised that information contained hereon reflects the Company's findings at the time of its intervention only and within the limits of Client's instructions, if any. The Company's sole responsibility is to its Client and this document does not exonerate parties to a transaction from exercising all their rights and obligations under the transaction documents. This document cannot be reproduced except in full, without prior written approval of the Company. Any unauthorized alteration, forgery or falsification of the content or appearance of this document is unlawful and offenders may be prosecuted to the fullest extent of the law. Unless otherwise stated the results shown in this test report refer only to the sample(s) tested and such sample(s) are retained for 30 days only.

Attention: To check the authenticity of testing/inspection report & certificate, please contact us at telephone: (86-755) 8307 1443, or email: CN.Doccheck@sgs.com

BLE_1M_Ant1_2440_30~1000

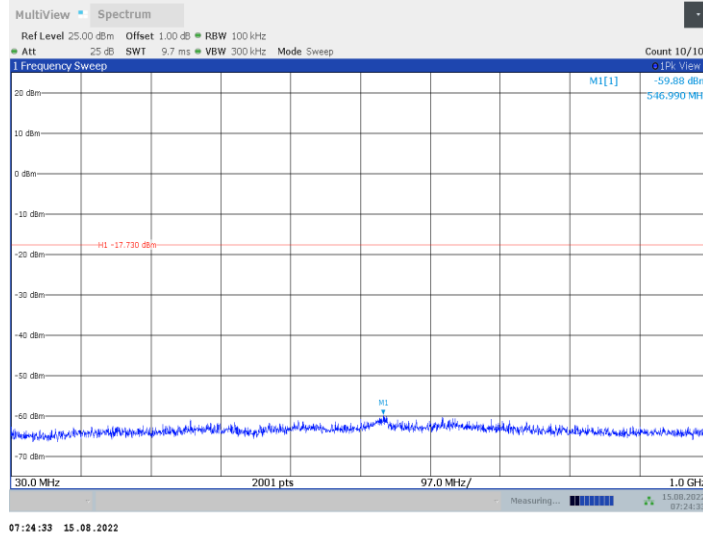

BLE_1M_Ant1_2440_1000~26500

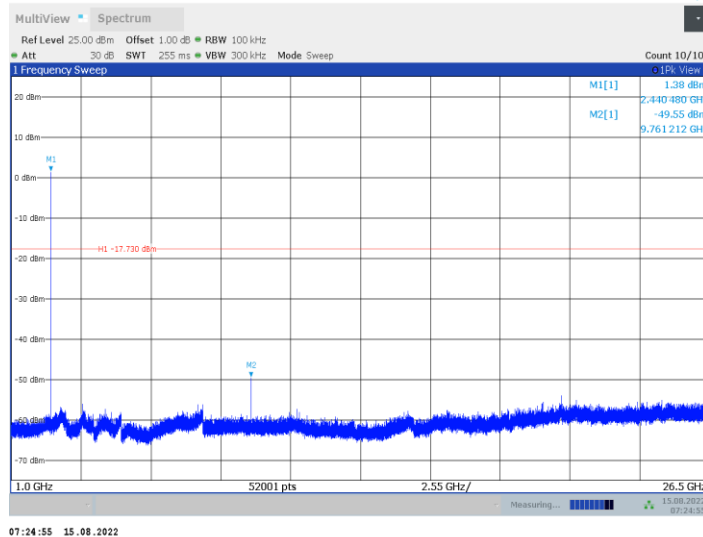

Unless otherwise agreed in writing, this document is issued by the Company subject to its General Conditions of Service printed overleaf, available on request or accessible at <http://www.sgs.com/en/Terms-and-Conditions.aspx> and, for electronic format documents, subject to Terms and Conditions for Electronic Documents at <http://www.sgs.com/en/Terms-and-Conditions/Terms-e-Documents.aspx>. Attention is drawn to the limitation of liability, indemnification and jurisdiction issues defined therein. Any holder of this document is advised that information contained hereon reflects the Company's findings at the time of its intervention only and within the limits of Client's instructions, if any. The Company's sole responsibility is to its Client and this document does not exonerate parties to a transaction from exercising all their rights and obligations under the transaction documents. This document cannot be reproduced except in full, without prior written approval of the Company. Any unauthorized alteration, forgery or falsification of the content or appearance of this document is unlawful and offenders may be prosecuted to the fullest extent of the law. Unless otherwise stated the results shown in this test report refer only to the sample(s) tested and such sample(s) are retained for 30 days only.

Attention: To check the authenticity of testing/inspection report & certificate, please contact us at telephone: (86-755) 8307 1443, or email: CN.Doccheck@sgs.com

South of No. 6 Plant, No. 1, Runsheng Road, Suzhou Industrial Park, Suzhou Area, China (Jiangsu) Pilot Free Trade Zone 215000 t (86-512) 62992980 www.sgs.com.cn
 中国·苏州·中国(江苏)自由贸易试验区苏州片区苏州工业园区润胜路1号的6号厂房南楼 邮编: 215000 t (86-512) 62992980 sgs.china@sgs.com

BLE 1M Ant1 2480 0~Reference

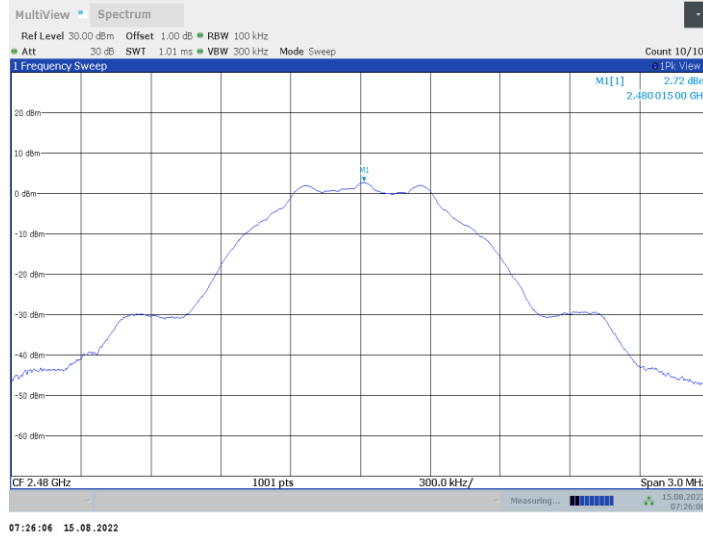

BLE 1M Ant1 2480 30~1000

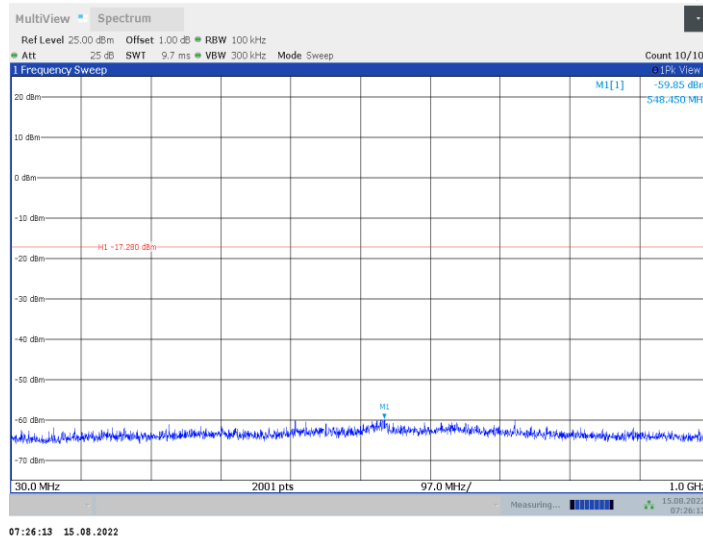

Unless otherwise agreed in writing, this document is issued by the Company subject to its General Conditions of Service printed overleaf, available on request or accessible at <http://www.sgs.com/en/Terms-and-Conditions.aspx> and, for electronic format documents, subject to Terms and Conditions for Electronic Documents at <http://www.sgs.com/en/Terms-and-Conditions/Terms-e-Documents.aspx>. Attention is drawn to the limitation of liability, indemnification and jurisdiction issues defined therein. Any holder of this document is advised that information contained hereon reflects the Company's findings at the time of its intervention only and within the limits of Client's instructions, if any. The Company's sole responsibility is to its Client and this document does not exonerate parties to a transaction from exercising all their rights and obligations under the transaction documents. This document cannot be reproduced except in full, without prior written approval of the Company. Any unauthorized alteration, forgery or falsification of the content or appearance of this document is unlawful and offenders may be prosecuted to the fullest extent of the law. Unless otherwise stated the results shown in this test report refer only to the sample(s) tested and such sample(s) are retained for 30 days only.

Attention: To check the authenticity of testing/inspection report & certificate, please contact us at telephone: (86-755) 8307 1443, or email: CN.Doccheck@sgs.com

BLE_1M_Ant1_2480_1000~26500

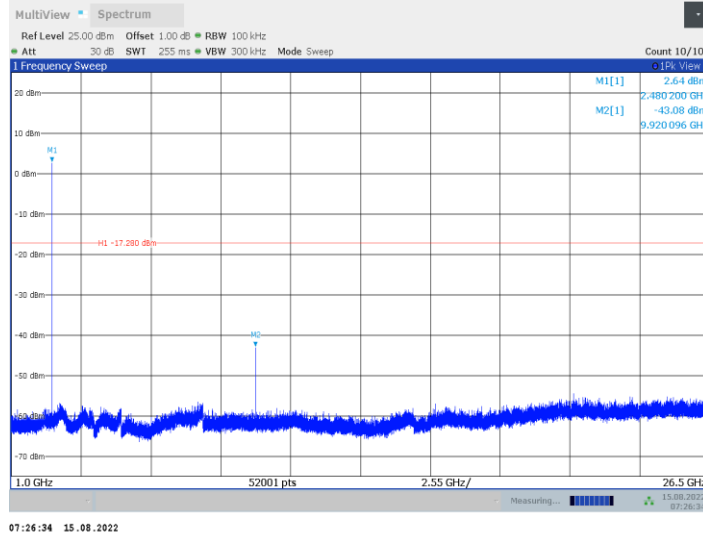

BLE_2M_Ant1_2402_0~Reference

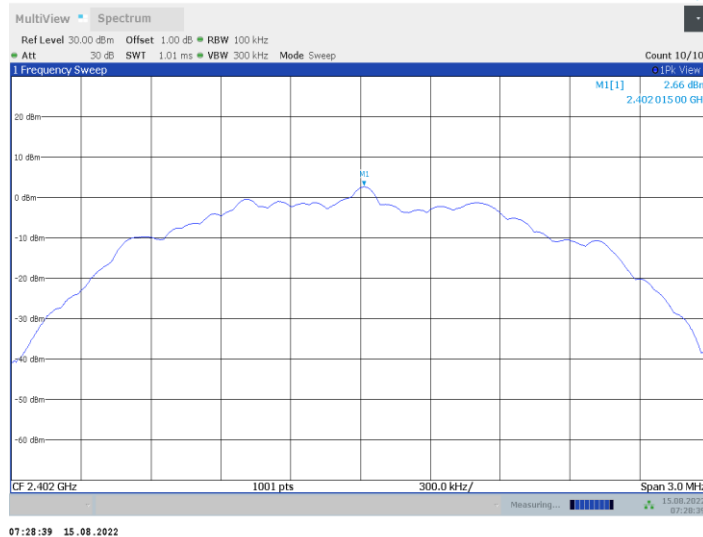

Unless otherwise agreed in writing, this document is issued by the Company subject to its General Conditions of Service printed overleaf, available on request or accessible at <http://www.sgs.com/en/Terms-and-Conditions.aspx> and, for electronic format documents, subject to Terms and Conditions for Electronic Documents at <http://www.sgs.com/en/Terms-and-Conditions/Terms-e-Documents.aspx>. Attention is drawn to the limitation of liability, indemnification and jurisdiction issues defined therein. Any holder of this document is advised that information contained hereon reflects the Company's findings at the time of its intervention only and within the limits of Client's instructions, if any. The Company's sole responsibility is to its Client and this document does not exonerate parties to a transaction from exercising all their rights and obligations under the transaction documents. This document cannot be reproduced except in full, without prior written approval of the Company. Any unauthorized alteration, forgery or falsification of the content or appearance of this document is unlawful and offenders may be prosecuted to the fullest extent of the law. Unless otherwise stated the results shown in this test report refer only to the sample(s) tested and such sample(s) are retained for 30 days only.

Attention: To check the authenticity of testing/inspection report & certificate, please contact us at telephone: (86-755) 8307 1443, or email: CN.Doccheck@sgs.com

BLE_2M_Ant1_2402_30~1000

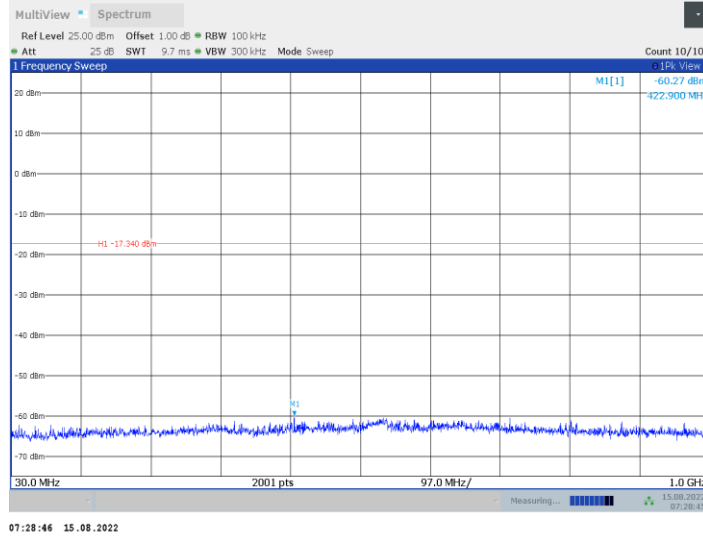

BLE_2M_Ant1_2402_1000~26500

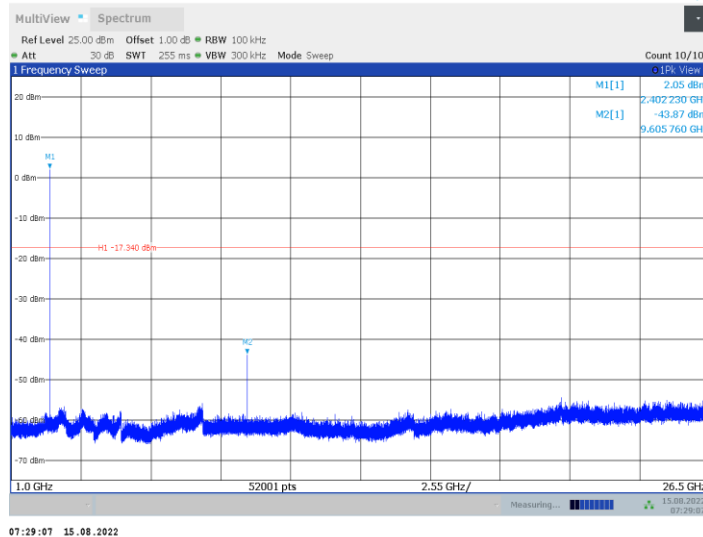

Unless otherwise agreed in writing, this document is issued by the Company subject to its General Conditions of Service printed overleaf, available on request or accessible at <http://www.sgs.com/en/Terms-and-Conditions.aspx> and, for electronic format documents, subject to Terms and Conditions for Electronic Documents at <http://www.sgs.com/en/Terms-and-Conditions/Terms-e-Documents.aspx>. Attention is drawn to the limitation of liability, indemnification and jurisdiction issues defined therein. Any holder of this document is advised that information contained hereon reflects the Company's findings at the time of its intervention only and within the limits of Client's instructions, if any. The Company's sole responsibility is to its Client and this document does not exonerate parties to a transaction from exercising all their rights and obligations under the transaction documents. This document cannot be reproduced except in full, without prior written approval of the Company. Any unauthorized alteration, forgery or falsification of the content or appearance of this document is unlawful and offenders may be prosecuted to the fullest extent of the law. Unless otherwise stated the results shown in this test report refer only to the sample(s) tested and such sample(s) are retained for 30 days only.

Attention: To check the authenticity of testing/inspection report & certificate, please contact us at telephone: (86-755) 8307 1443, or email: CN.Doccheck@sgs.com

SGS-CSTC Standards Technical Services (Suzhou) Co., Ltd.
Wireless Laboratory

South of No. 6 Plant, No. 1, Runsheng Road, Suzhou Industrial Park, Suzhou Area, China (Jiangsu) Pilot Free Trade Zone 215000
中国·苏州·中国(江苏)自由贸易试验区苏州片区苏州工业园区润胜路1号的6号厂房南楼 邮编: 215000

t (86-512) 62992980 www.sgs.com.cn
t (86-512) 62992980 sgs.china@sgs.com

BLE 2M Ant1 2440_0~Reference

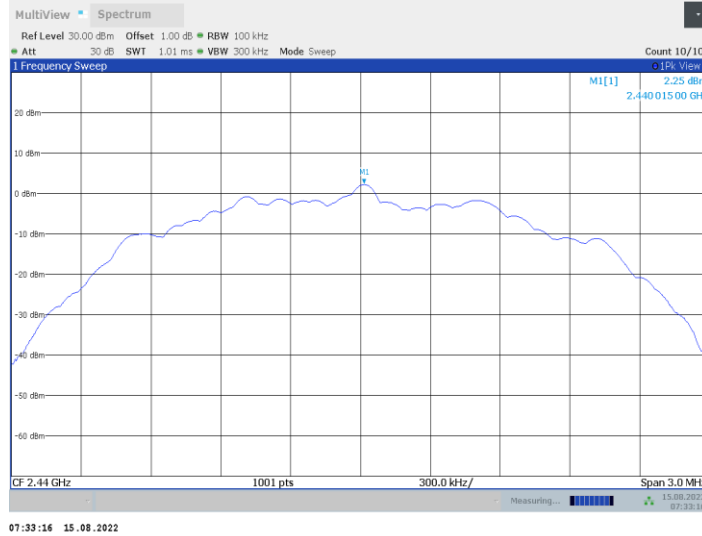

BLE 2M Ant1 2440_30~1000

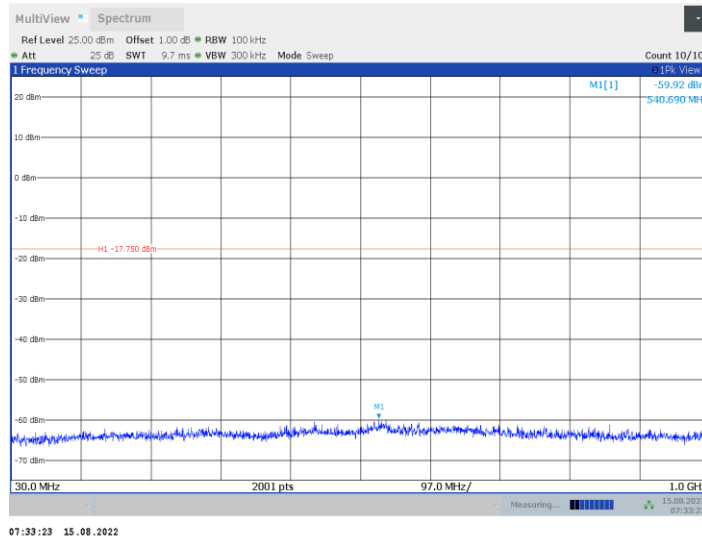

Unless otherwise agreed in writing, this document is issued by the Company subject to its General Conditions of Service printed overleaf, available on request or accessible at <http://www.sgs.com/en/Terms-and-Conditions.aspx> and, for electronic format documents, subject to Terms and Conditions for Electronic Documents at <http://www.sgs.com/en/Terms-and-Conditions/Terms-e-Documents.aspx>. Attention is drawn to the limitation of liability, indemnification and jurisdiction issues defined therein. Any holder of this document is advised that information contained hereon reflects the Company's findings at the time of its intervention only and within the limits of Client's instructions, if any. The Company's sole responsibility is to its Client and this document does not exonerate parties to a transaction from exercising all their rights and obligations under the transaction documents. This document cannot be reproduced except in full, without prior written approval of the Company. Any unauthorized alteration, forgery or falsification of the content or appearance of this document is unlawful and offenders may be prosecuted to the fullest extent of the law. Unless otherwise stated the results shown in this test report refer only to the sample(s) tested and such sample(s) are retained for 30 days only.

Attention: To check the authenticity of testing / inspection report & certificate, please contact us at telephone: (86-755) 8307 1443, or email: CN.Doccheck@sgs.com

BLE 2M Ant1 2440 1000~26500

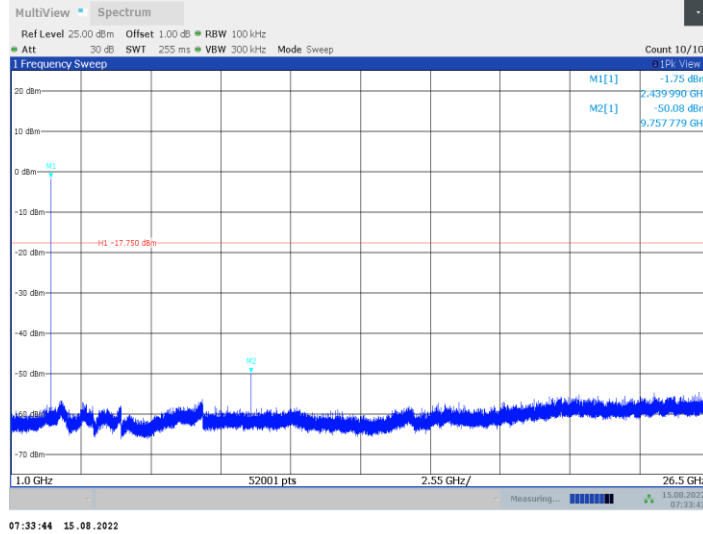

BLE 2M Ant1 2480 0~Reference

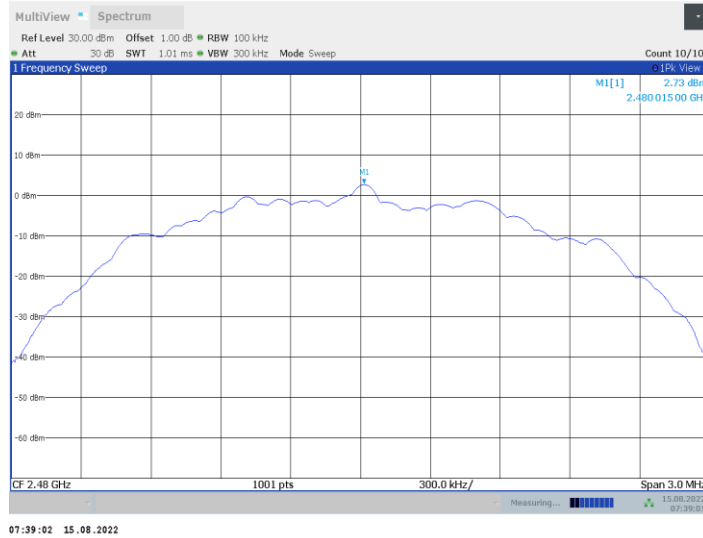

Unless otherwise agreed in writing, this document is issued by the Company subject to its General Conditions of Service printed overleaf, available on request or accessible at <http://www.sgs.com/en/Terms-and-Conditions.aspx> and, for electronic format documents, subject to Terms and Conditions for Electronic Documents at <http://www.sgs.com/en/Terms-and-Conditions/Terms-e-Documents.aspx>. Attention is drawn to the limitation of liability, indemnification and jurisdiction issues defined therein. Any holder of this document is advised that information contained hereon reflects the Company's findings at the time of its intervention only and within the limits of Client's instructions, if any. The Company's sole responsibility is to its Client and this document does not exonerate parties to a transaction from exercising all their rights and obligations under the transaction documents. This document cannot be reproduced except in full, without prior written approval of the Company. Any unauthorized alteration, forgery or falsification of the content or appearance of this document is unlawful and offenders may be prosecuted to the fullest extent of the law. Unless otherwise stated the results shown in this test report refer only to the sample(s) tested and such sample(s) are retained for 30 days only.

Attention: To check the authenticity of testing/inspection report & certificate, please contact us at telephone: (86-755) 8307 1443, or email: CN.Doccheck@sgs.com

BLE_2M_Ant1_2480_30~1000

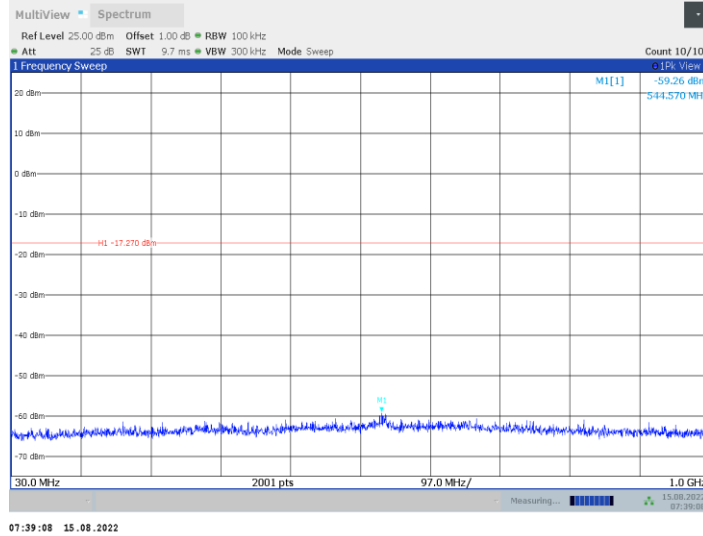

BLE_2M_Ant1_2480_1000~26500

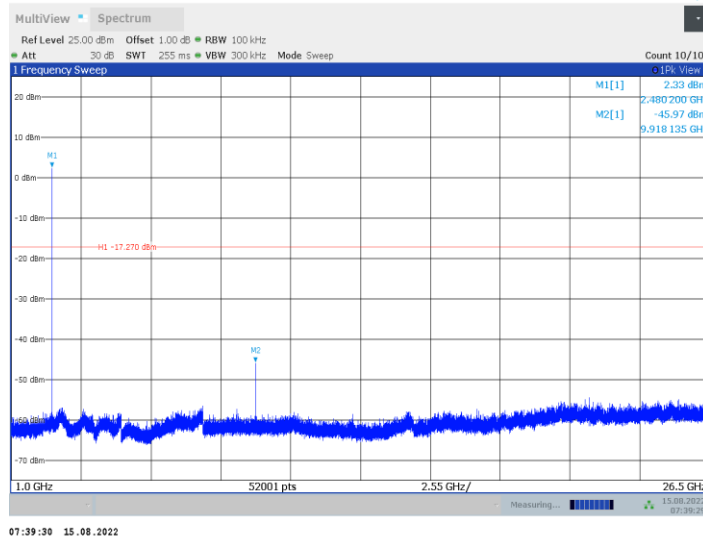

Unless otherwise agreed in writing, this document is issued by the Company subject to its General Conditions of Service printed overleaf, available on request or accessible at <http://www.sgs.com/en/Terms-and-Conditions.aspx> and, for electronic format documents, subject to Terms and Conditions for Electronic Documents at <http://www.sgs.com/en/Terms-and-Conditions/Terms-e-Documents.aspx>. Attention is drawn to the limitation of liability, indemnification and jurisdiction issues defined therein. Any holder of this document is advised that information contained hereon reflects the Company's findings at the time of its intervention only and within the limits of Client's instructions, if any. The Company's sole responsibility is to its Client and this document does not exonerate parties to a transaction from exercising all their rights and obligations under the transaction documents. This document cannot be reproduced except in full, without prior written approval of the Company. Any unauthorized alteration, forgery or falsification of the content or appearance of this document is unlawful and offenders may be prosecuted to the fullest extent of the law. Unless otherwise stated the results shown in this test report refer only to the sample(s) tested and such sample(s) are retained for 30 days only.

Attention: To check the authenticity of testing/inspection report & certificate, please contact us at telephone: (86-755) 83071443, or email: CN.Doccheck@sgs.com

South of No. 6 Plant, No. 1, Runsheng Road, Suzhou Industrial Park, Suzhou Area, China (Jiangsu) Pilot Free Trade Zone 215000 t (86-512) 62992980 www.sgs.com.cn
 中国·苏州·中国(江苏)自由贸易试验区苏州片区苏州工业园区润胜路1号的6号厂房南楼 邮编: 215000 t (86-512) 62992980 sgs.china@sgs.com

Report No.: SEWM2207000133RG02

Rev.: 01

Page: 56 of 79

Duty Cycle Test Result

TestMode	Antenna	Frequency[MHz]	ON Time [ms]	Period [ms]	Duty Cycle [%]	Duty Cycle Factor[dB]
BLE_1M	Ant1	2402	0.39	0.63	61.90	2.08
BLE_2M	Ant1	2402	0.20	0.62	32.26	4.91



Unless otherwise agreed in writing, this document is issued by the Company subject to its General Conditions of Service printed overleaf, available on request or accessible at <http://www.sgs.com/en/Terms-and-Conditions.aspx> and, for electronic format documents, subject to Terms and Conditions for Electronic Documents at <http://www.sgs.com/en/Terms-and-Conditions/Terms-e-Documents.aspx>. Attention is drawn to the limitation of liability, indemnification and jurisdiction issues defined therein. Any holder of this document is advised that information contained hereon reflects the Company's findings at the time of its intervention only and within the limits of Client's instructions, if any. The Company's sole responsibility is to its Client and this document does not exonerate parties to a transaction from exercising all their rights and obligations under the transaction documents. This document cannot be reproduced except in full, without prior written approval of the Company. Any unauthorized alteration, forgery or falsification of the content or appearance of this document is unlawful and offenders may be prosecuted to the fullest extent of the law. Unless otherwise stated the results shown in this test report refer only to the sample(s) tested and such sample(s) are retained for 30 days only.
Attention: To check the authenticity of testing / inspection report & certificate, please contact us at telephone: (86-755) 8307 1443, or email: CN.Doccheck@sgs.com

South of No. 6 Plant, No. 1, Runsheng Road, Suzhou Industrial Park, Suzhou Area, China (Jiangsu) Pilot Free Trade Zone 215000
 中国·苏州·中国(江苏)自由贸易试验区苏州片区苏州工业园区润胜路1号的6号厂房南楼 邮编: 215000

t (86-512) 62992980 www.sgs.com.cn
 s (86-512) 62992980 sgs.china@sgs.com

Test Graphs

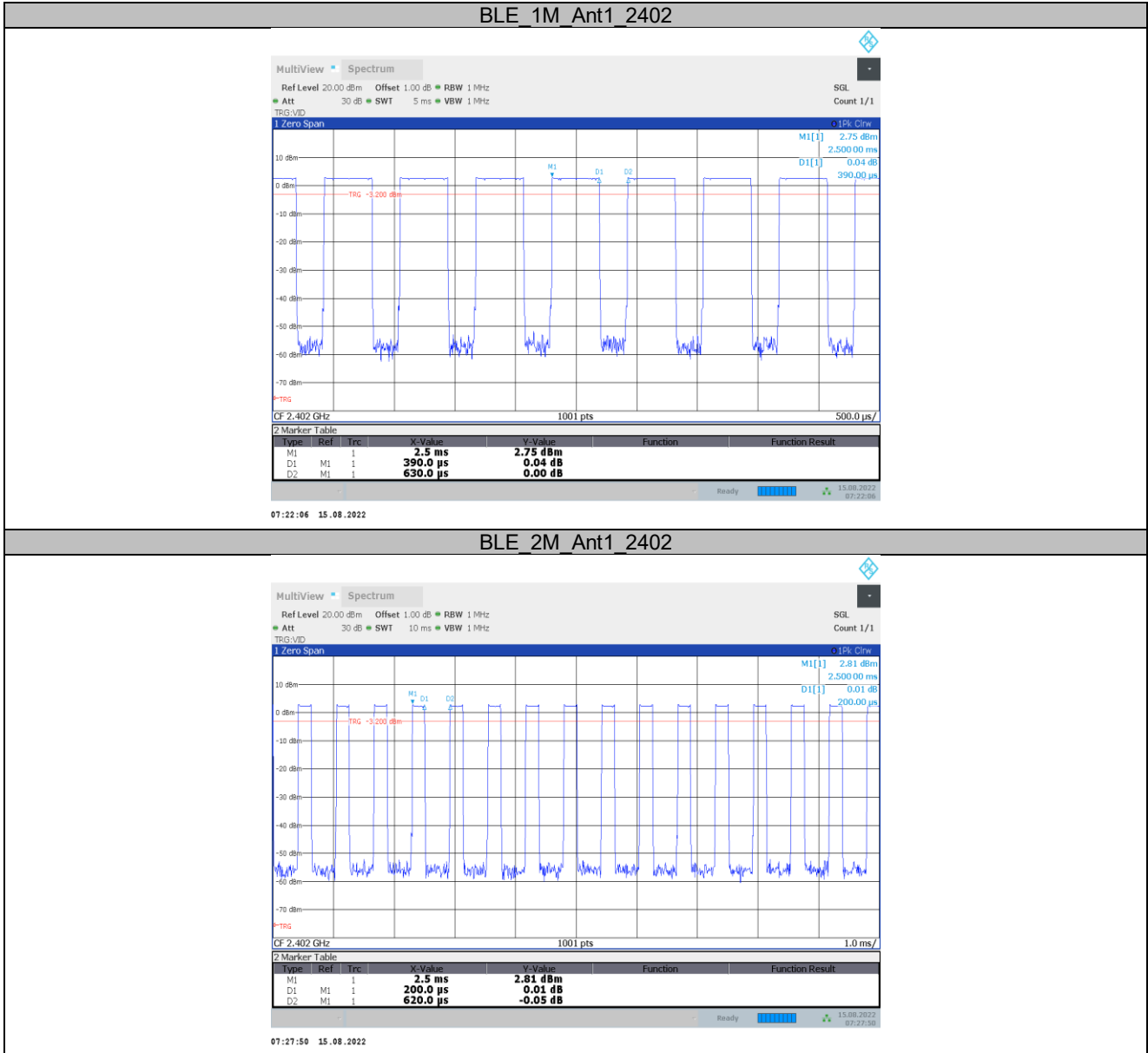

Unless otherwise agreed in writing, this document is issued by the Company subject to its General Conditions of Service printed overleaf, available on request or accessible at <http://www.sgs.com/en/Terms-and-Conditions.aspx> and, for electronic format documents, subject to Terms and Conditions for Electronic Documents at <http://www.sgs.com/en/Terms-and-Conditions/Terms-e-Documents.aspx>. Attention is drawn to the limitation of liability, indemnification and jurisdiction issues defined therein. Any holder of this document is advised that information contained hereon reflects the Company's findings at the time of its intervention only and within the limits of Client's instructions, if any. The Company's sole responsibility is to its Client and this document does not exonerate parties to a transaction from exercising all their rights and obligations under the transaction documents. This document cannot be reproduced except in full, without prior written approval of the Company. Any unauthorized alteration, forgery or falsification of the content or appearance of this document is unlawful and offenders may be prosecuted to the fullest extent of the law. Unless otherwise stated the results shown in this test report refer only to the sample(s) tested and such sample(s) are retained for 30 days only.

Attention: To check the authenticity of testing/inspection report & certificate, please contact us at telephone: (86-755) 8307 1443, or email: CN.Doccheck@sgs.com

South of No. 6 Plant, No. 1, Runsheng Road, Suzhou Industrial Park, Suzhou Area, China (Jiangsu) Pilot Free Trade Zone 215000 t (86-512) 62992980 www.sgs.com.cn
 中国·苏州·中国(江苏)自由贸易试验区苏州片区苏州工业园区润胜路1号的6号厂房南楼 邮编: 215000 t (86-512) 62992980 sgs.china@sgs.com

Radiated Spurious Emissions

Radiated emission below 1GHz

Worst case Mode: BLE 1M_Channel 00

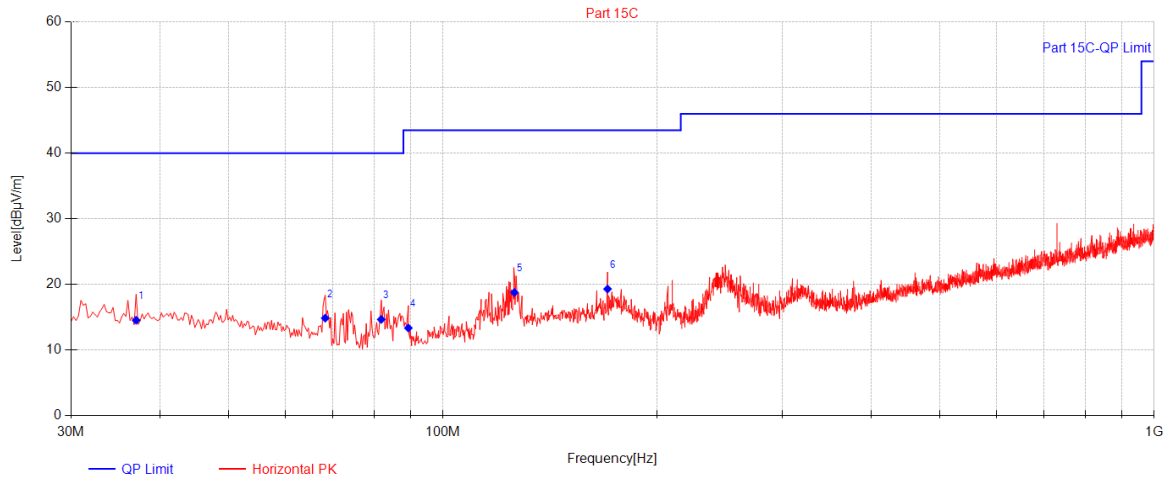

Final Data List										
NO.	Frequency [MHz]	Reading [dBμV]	Factor [dB]	AF [dB/m]	QP Value [dBμV/m]	QP Limit [dBμV/m]	QP Margin [dB]	Height [cm]	Angle [°]	Polarity
1	37.0325	37.26	-36.40	13.67	14.53	40.00	25.47	216	302	Horizontal
2	68.315	40.19	-36.50	11.15	14.84	40.00	25.16	145	250	Horizontal
3	81.895	41.11	-35.78	9.32	14.65	40.00	25.35	236	281	Horizontal
4	89.4125	40.29	-36.38	9.43	13.34	43.50	30.16	291	135	Horizontal
5	126.03	42.03	-35.84	12.57	18.76	43.50	24.74	148	73	Horizontal
6	170.4075	40.01	-35.14	14.42	19.29	43.50	24.21	172	250	Horizontal



Unless otherwise agreed in writing, this document is issued by the Company subject to its General Conditions of Service printed overleaf, available on request or accessible at <http://www.sgs.com/en/Terms-and-Conditions.aspx> and, for electronic format documents, subject to Terms and Conditions for Electronic Documents at <http://www.sgs.com/en/Terms-and-Conditions/Terms-e-Documents.aspx>. Attention is drawn to the limitation of liability, indemnification and jurisdiction issues defined therein. Any holder of this document is advised that information contained hereon reflects the Company's findings at the time of its intervention only and within the limits of Client's instructions, if any. The Company's sole responsibility is to its Client and this document does not exonerate parties to a transaction from exercising all their rights and obligations under the transaction documents. This document cannot be reproduced except in full, without prior written approval of the Company. Any unauthorized alteration, forgery or falsification of the content or appearance of this document is unlawful and offenders may be prosecuted to the fullest extent of the law. Unless otherwise stated the results shown in this test report refer only to the sample(s) tested and such sample(s) are retained for 30 days only.
Attention: To check the authenticity of testing/inspection report & certificate, please contact us at telephone: (86-755) 8307 1443, or email: CN.Doccheck@sgs.com

South of No. 6 Plant, No. 1, Runsheng Road, Suzhou Industrial Park, Suzhou Area, China (Jiangsu) Pilot Free Trade Zone 215000
 中国·苏州·中国(江苏)自由贸易试验区苏州片区苏州工业园区润胜路1号的6号厂房南楼 邮编: 215000

t (86-512) 62992980 www.sgs.com.cn
 t (86-512) 62992980 sgs.china@sgs.com

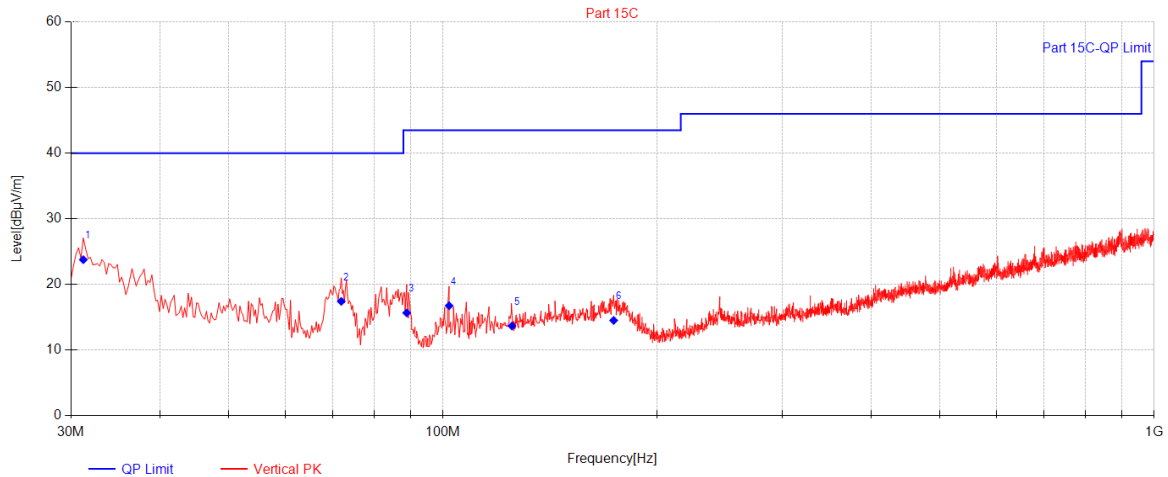

Final Data List										
NO.	Frequency [MHz]	Reading [dBμV]	Factor [dB]	AF [dB/m]	QP Value [dBμV/m]	QP Limit [dBμV/m]	QP Margin [dB]	Height [cm]	Angle [°]	Polarity
1	31.2125	47.15	-36.65	13.26	23.76	40.00	16.24	162	349	Vertical
2	71.9525	43.22	-36.35	10.52	17.40	40.00	22.60	154	266	Vertical
3	88.9275	42.56	-36.34	9.42	15.64	43.50	27.86	185	244	Vertical
4	102.0225	42.23	-35.84	10.35	16.74	43.50	26.76	196	286	Vertical
5	125.06	37.02	-35.89	12.52	13.65	43.50	29.85	147	172	Vertical
6	173.8025	35.16	-35.17	14.51	14.50	43.50	29.00	133	275	Vertical

Remark:

- The field strength is calculated by adding the Antenna Factor, Cable Factor & Preamplifier gain. The basic equation with a sample calculation is as follows:
 $Value = Reading(dB\mu V) + AF(dB/m) + Factor(dB)$
 $AF = Antenna\ Factor(dB/m)$
 $Factor = Cable\ Factor(dB) - Preamplifier\ gain(dB)$
 $Margin = Limit(dB\mu V/m) - Value(dB\mu V/m)$
- All channels have been tested, but only the worst case data displayed in this report.



Transmitter emission Above 1GHz

BLE 1M_Channel 00

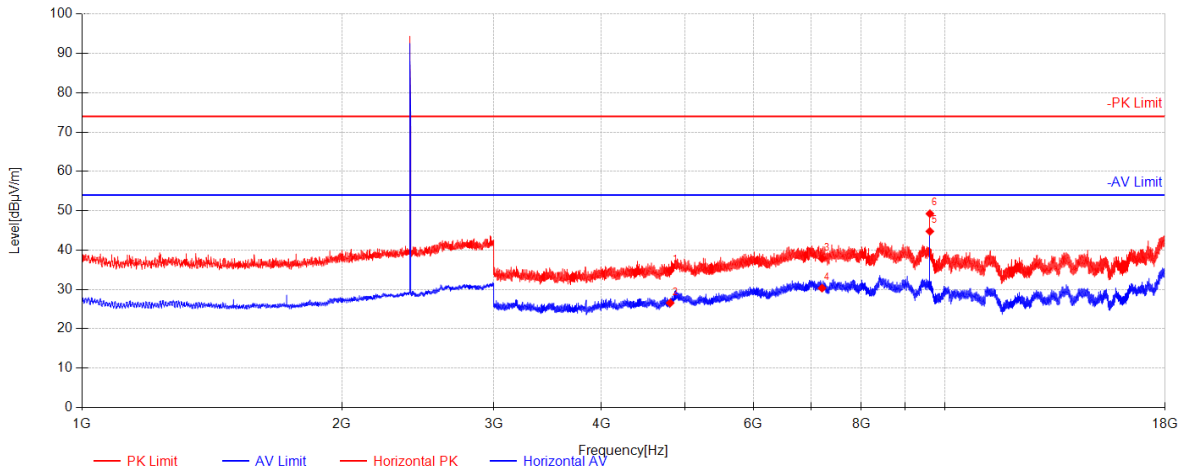

Data List										
NO.	Frequency [MHz]	Reading [dBµV]	AF [dB/m]	Factor [dB]	Level [dBµV/m]	Limit [dBµV/m]	Margin [dB]	Height [cm]	Angle [°]	Polarity
1	4804.0000	47.99	32.33	-45.54	34.78	74.00	39.22	216	164	Horizontal
2	4804.0000	39.78	32.33	-45.54	26.57	54.00	27.43	154	7	Horizontal
3	7206.0000	44.69	36.60	-43.44	37.85	74.00	36.15	133	0	Horizontal
4	7206.0000	37.17	36.60	-43.44	30.33	54.00	23.67	261	220	Horizontal
5	9607.5	45.98	38.43	-39.65	44.76	54.00	9.24	169	1	Horizontal
6	9609	50.47	38.43	-39.65	49.25	74.00	24.75	145	164	Horizontal



Unless otherwise agreed in writing, this document is issued by the Company subject to its General Conditions of Service printed overleaf, available on request or accessible at <http://www.sgs.com/en/Terms-and-Conditions.aspx> and, for electronic format documents, subject to Terms and Conditions for Electronic Documents at <http://www.sgs.com/en/Terms-and-Conditions/Terms-e-Documents.aspx>. Attention is drawn to the limitation of liability, indemnification and jurisdiction issues defined therein. Any holder of this document is advised that information contained hereon reflects the Company's findings at the time of its intervention only and within the limits of Client's instructions, if any. The Company's sole responsibility is to its Client and this document does not exonerate parties to a transaction from exercising all their rights and obligations under the transaction documents. This document cannot be reproduced except in full, without prior written approval of the Company. Any unauthorized alteration, forgery or falsification of the content or appearance of this document is unlawful and offenders may be prosecuted to the fullest extent of the law. Unless otherwise stated the results shown in this test report refer only to the sample(s) tested and such sample(s) are retained for 30 days only.

Attention: To check the authenticity of testing/inspection report & certificate, please contact us at telephone: (86-755) 8307 1443, or email: CN.Doccheck@sgs.com

South of No. 6 Plant, No. 1, Runsheng Road, Suzhou Industrial Park, Suzhou Area, China (Jiangsu) Pilot Free Trade Zone 215000
 中国·苏州·中国(江苏)自由贸易试验区苏州片区苏州工业园区润胜路1号的6号厂房南楼 邮编: 215000

t (86-512) 62992980 www.sgs.com.cn
 t (86-512) 62992980 sgs.china@sgs.com

BLE 1M_Channel 00

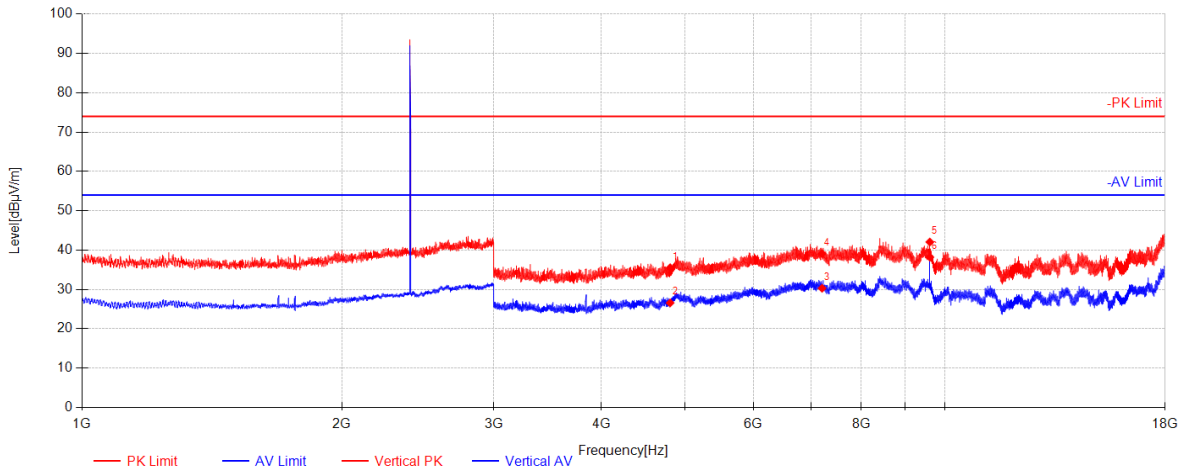

Data List										
NO.	Frequency [MHz]	Reading [dBµV]	AF [dB/m]	Factor [dB]	Level [dBµV/m]	Limit [dBµV/m]	Margin [dB]	Height [cm]	Angle [°]	Polarity
1	4804.0000	48.74	32.33	-45.54	35.53	74.00	38.47	254	356	Vertical
2	4804.0000	39.79	32.33	-45.54	26.58	54.00	27.42	162	191	Vertical
3	7206.0000	37.14	36.60	-43.44	30.30	54.00	23.70	178	136	Vertical
4	7206.0000	45.95	36.60	-43.44	39.11	74.00	34.89	149	275	Vertical
5	9608.0000	43.28	38.43	-39.65	42.06	74.00	31.94	191	332	Vertical
6	9609	39.41	38.43	-39.65	38.19	54.00	15.81	144	332	Vertical



Unless otherwise agreed in writing, this document is issued by the Company subject to its General Conditions of Service printed overleaf, available on request or accessible at <http://www.sgs.com/en/Terms-and-Conditions.aspx> and, for electronic format documents, subject to Terms and Conditions for Electronic Documents at <http://www.sgs.com/en/Terms-and-Conditions/Terms-e-Documents.aspx>. Attention is drawn to the limitation of liability, indemnification and jurisdiction issues defined therein. Any holder of this document is advised that information contained hereon reflects the Company's findings at the time of its intervention only and within the limits of Client's instructions, if any. The Company's sole responsibility is to its Client and this document does not exonerate parties to a transaction from exercising all their rights and obligations under the transaction documents. This document cannot be reproduced except in full, without prior written approval of the Company. Any unauthorized alteration, forgery or falsification of the content or appearance of this document is unlawful and offenders may be prosecuted to the fullest extent of the law. Unless otherwise stated the results shown in this test report refer only to the sample(s) tested and such sample(s) are retained for 30 days only.
Attention: To check the authenticity of testing/inspection report & certificate, please contact us at telephone: (86-755) 8307 1443, or email: CN.Doccheck@sgs.com

South of No. 6 Plant, No. 1, Runsheng Road, Suzhou Industrial Park, Suzhou Area, China (Jiangsu) Pilot Free Trade Zone 215000
 中国·苏州·中国(江苏)自由贸易试验区苏州片区苏州工业园区润胜路1号的6号厂房南楼 邮编: 215000

t (86-512) 62992980 www.sgs.com.cn
 t (86-512) 62992980 sgs.china@sgs.com

BLE 1M_Channel 19

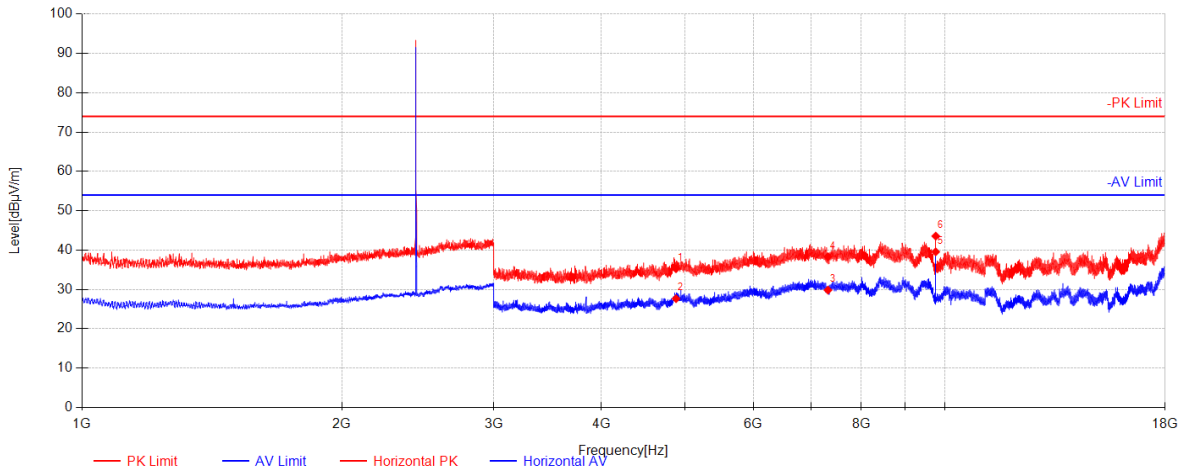

Data List										
NO.	Frequency [MHz]	Reading [dBµV]	AF [dB/m]	Factor [dB]	Level [dBµV/m]	Limit [dBµV/m]	Margin [dB]	Height [cm]	Angle [°]	Polarity
1	4880.0000	48.24	32.54	-45.53	35.25	74.00	38.75	269	135	Horizontal
2	4880.0000	40.64	32.54	-45.53	27.65	54.00	26.35	145	1	Horizontal
3	7320.0000	36.98	36.53	-43.68	29.83	54.00	24.17	195	332	Horizontal
4	7320.0000	45.48	36.53	-43.68	38.33	74.00	35.67	125	1	Horizontal
5	9759.5	40.76	38.26	-39.46	39.56	54.00	14.44	133	0	Horizontal
6	9760.0000	44.76	38.26	-39.46	43.56	74.00	30.44	172	356	Horizontal



Unless otherwise agreed in writing, this document is issued by the Company subject to its General Conditions of Service printed overleaf, available on request or accessible at <http://www.sgs.com/en/Terms-and-Conditions.aspx> and, for electronic format documents, subject to Terms and Conditions for Electronic Documents at <http://www.sgs.com/en/Terms-and-Conditions/Terms-e-Documents.aspx>. Attention is drawn to the limitation of liability, indemnification and jurisdiction issues defined therein. Any holder of this document is advised that information contained hereon reflects the Company's findings at the time of its intervention only and within the limits of Client's instructions, if any. The Company's sole responsibility is to its Client and this document does not exonerate parties to a transaction from exercising all their rights and obligations under the transaction documents. This document cannot be reproduced except in full, without prior written approval of the Company. Any unauthorized alteration, forgery or falsification of the content or appearance of this document is unlawful and offenders may be prosecuted to the fullest extent of the law. Unless otherwise stated the results shown in this test report refer only to the sample(s) tested and such sample(s) are retained for 30 days only.
Attention: To check the authenticity of testing/inspection report & certificate, please contact us at telephone: (86-755) 8307 1443, or email: CN.Doccheck@sgs.com

South of No. 6 Plant, No. 1, Runsheng Road, Suzhou Industrial Park, Suzhou Area, China (Jiangsu) Pilot Free Trade Zone 215000
 中国·苏州·中国(江苏)自由贸易试验区苏州片区苏州工业园区润胜路1号的6号厂房南楼 邮编: 215000

t (86-512) 62992980 www.sgs.com.cn
 t (86-512) 62992980 sgs.china@sgs.com

BLE 1M_Channel 19

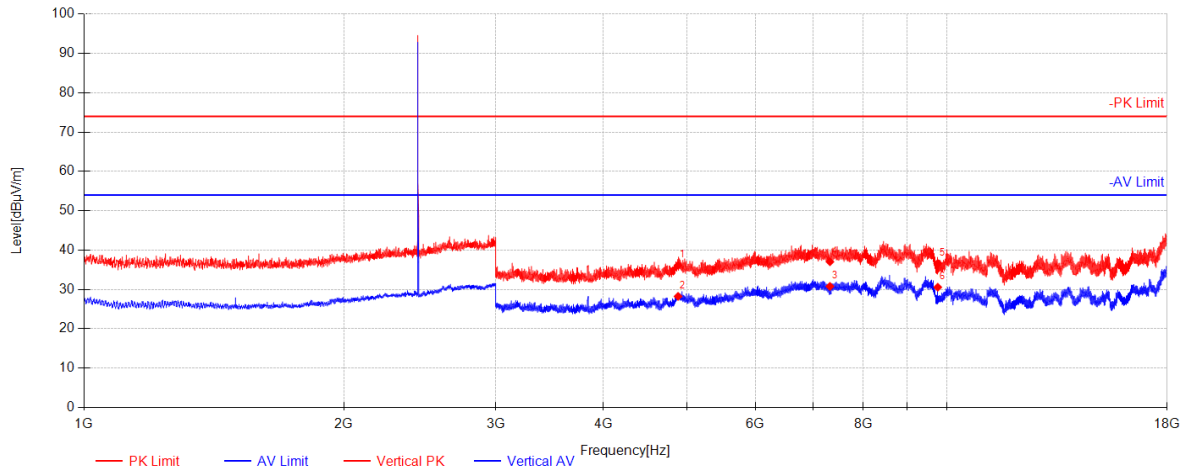

Data List										
NO.	Frequency [MHz]	Reading [dBµV]	AF [dB/m]	Factor [dB]	Level [dBµV/m]	Limit [dBµV/m]	Margin [dB]	Height [cm]	Angle [°]	Polarity
1	4880.0000	49.11	32.54	-45.53	36.12	74.00	37.88	284	1	Vertical
2	4880.0000	41.23	32.54	-45.53	28.24	54.00	25.76	191	195	Vertical
3	7320.0000	37.93	36.53	-43.68	30.78	54.00	23.22	142	7	Vertical
4	7320.0000	44.19	36.53	-43.68	37.04	74.00	36.96	165	250	Vertical
5	9760.0000	37.82	38.26	-39.46	36.62	74.00	37.38	125	332	Vertical
6	9760.0000	31.76	38.26	-39.46	30.56	54.00	23.44	133	332	Vertical



Unless otherwise agreed in writing, this document is issued by the Company subject to its General Conditions of Service printed overleaf, available on request or accessible at <http://www.sgs.com/en/Terms-and-Conditions.aspx> and, for electronic format documents, subject to Terms and Conditions for Electronic Documents at <http://www.sgs.com/en/Terms-and-Conditions/Terms-e-Documents.aspx>. Attention is drawn to the limitation of liability, indemnification and jurisdiction issues defined therein. Any holder of this document is advised that information contained hereon reflects the Company's findings at the time of its intervention only and within the limits of Client's instructions, if any. The Company's sole responsibility is to its Client and this document does not exonerate parties to a transaction from exercising all their rights and obligations under the transaction documents. This document cannot be reproduced except in full, without prior written approval of the Company. Any unauthorized alteration, forgery or falsification of the content or appearance of this document is unlawful and offenders may be prosecuted to the fullest extent of the law. Unless otherwise stated the results shown in this test report refer only to the sample(s) tested and such sample(s) are retained for 30 days only.
Attention: To check the authenticity of testing/inspection report & certificate, please contact us at telephone: (86-755) 8307 1443, or email: CN.Doccheck@sgs.com

South of No. 6 Plant, No. 1, Runsheng Road, Suzhou Industrial Park, Suzhou Area, China (Jiangsu) Pilot Free Trade Zone 215000
 中国·苏州·中国(江苏)自由贸易试验区苏州片区苏州工业园区润胜路1号的6号厂房南楼 邮编: 215000

t (86-512) 62992980 www.sgs.com.cn
 t (86-512) 62992980 sgs.china@sgs.com

BLE 1M_Channel 39

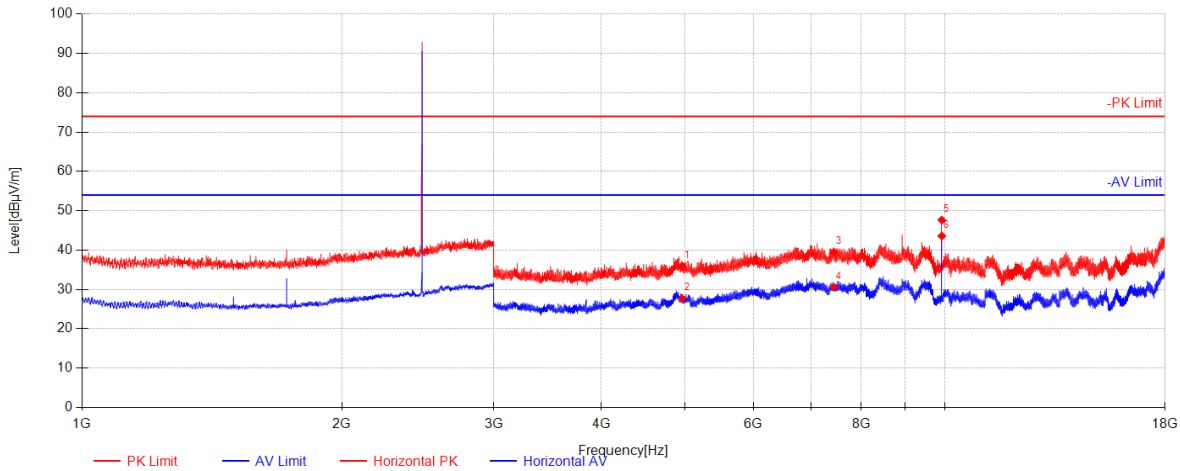

Data List										
NO.	Frequency [MHz]	Reading [dBµV]	AF [dB/m]	Factor [dB]	Level [dBµV/m]	Limit [dBµV/m]	Margin [dB]	Height [cm]	Angle [°]	Polarity
1	4960.0000	48.71	32.77	-45.60	35.88	74.00	38.12	254	0	Horizontal
2	4960.0000	40.52	32.77	-45.60	27.69	54.00	26.31	126	194	Horizontal
3	7440.0000	46.27	36.47	-43.30	39.44	74.00	34.56	261	138	Horizontal
4	7440.0000	37.39	36.47	-43.30	30.56	54.00	23.44	199	356	Horizontal
5	9919	48.59	38.38	-39.31	47.66	74.00	26.34	178	0	Horizontal
6	9919.5	44.52	38.38	-39.31	43.59	54.00	10.41	122	1	Horizontal



Unless otherwise agreed in writing, this document is issued by the Company subject to its General Conditions of Service printed overleaf, available on request or accessible at <http://www.sgs.com/en/Terms-and-Conditions.aspx> and, for electronic format documents, subject to Terms and Conditions for Electronic Documents at <http://www.sgs.com/en/Terms-and-Conditions/Terms-e-Documents.aspx>. Attention is drawn to the limitation of liability, indemnification and jurisdiction issues defined therein. Any holder of this document is advised that information contained hereon reflects the Company's findings at the time of its intervention only and within the limits of Client's instructions, if any. The Company's sole responsibility is to its Client and this document does not exonerate parties to a transaction from exercising all their rights and obligations under the transaction documents. This document cannot be reproduced except in full, without prior written approval of the Company. Any unauthorized alteration, forgery or falsification of the content or appearance of this document is unlawful and offenders may be prosecuted to the fullest extent of the law. Unless otherwise stated the results shown in this test report refer only to the sample(s) tested and such sample(s) are retained for 30 days only.

Attention: To check the authenticity of testing/inspection report & certificate, please contact us at telephone: (86-755) 8307 1443, or email: CN.Doccheck@sgs.com

South of No. 6 Plant, No. 1, Runsheng Road, Suzhou Industrial Park, Suzhou Area, China (Jiangsu) Pilot Free Trade Zone 215000
 中国·苏州·中国(江苏)自由贸易试验区苏州片区苏州工业园区润胜路1号的6号厂房南楼 邮编: 215000

t (86-512) 62992980 www.sgs.com.cn
 t (86-512) 62992980 sgs.china@sgs.com

BLE 1M_Channel 39

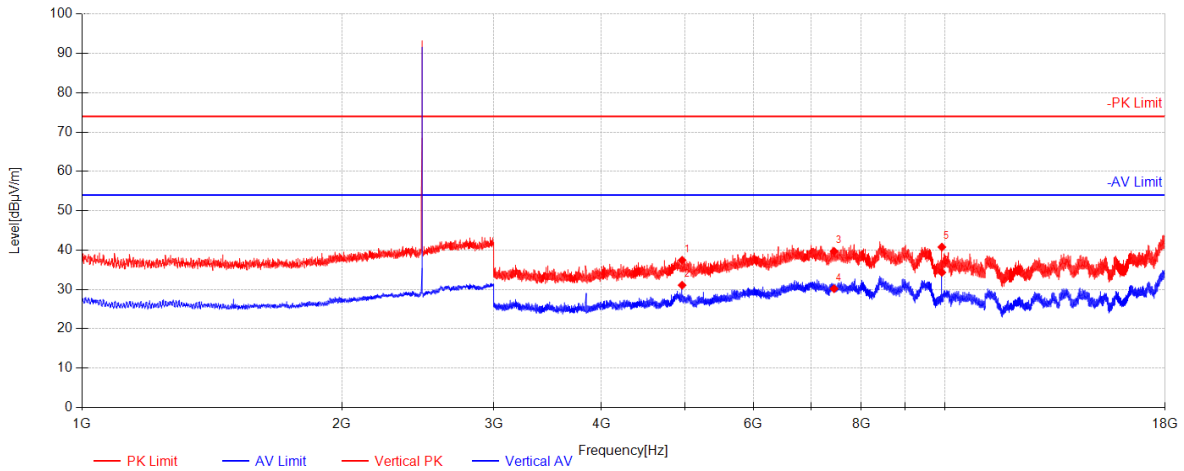

Data List										
NO.	Frequency [MHz]	Reading [dBµV]	AF [dB/m]	Factor [dB]	Level [dBµV/m]	Limit [dBµV/m]	Margin [dB]	Height [cm]	Angle [°]	Polarity
1	4960.0000	50.26	32.77	-45.60	37.43	74.00	36.57	245	193	Vertical
2	4960.0000	43.91	32.77	-45.60	31.08	54.00	22.92	126	221	Vertical
3	7440.0000	46.51	36.47	-43.30	39.68	74.00	34.32	261	222	Vertical
4	7440.0000	37.02	36.47	-43.30	30.19	54.00	23.81	188	277	Vertical
5	9921	41.71	38.38	-39.31	40.78	74.00	33.22	145	24	Vertical
6	9921.5	35.25	38.38	-39.31	34.32	54.00	19.68	190	53	Vertical



Unless otherwise agreed in writing, this document is issued by the Company subject to its General Conditions of Service printed overleaf, available on request or accessible at <http://www.sgs.com/en/Terms-and-Conditions.aspx> and, for electronic format documents, subject to Terms and Conditions for Electronic Documents at <http://www.sgs.com/en/Terms-and-Conditions/Terms-e-Documents.aspx>. Attention is drawn to the limitation of liability, indemnification and jurisdiction issues defined therein. Any holder of this document is advised that information contained hereon reflects the Company's findings at the time of its intervention only and within the limits of Client's instructions, if any. The Company's sole responsibility is to its Client and this document does not exonerate parties to a transaction from exercising all their rights and obligations under the transaction documents. This document cannot be reproduced except in full, without prior written approval of the Company. Any unauthorized alteration, forgery or falsification of the content or appearance of this document is unlawful and offenders may be prosecuted to the fullest extent of the law. Unless otherwise stated the results shown in this test report refer only to the sample(s) tested and such sample(s) are retained for 30 days only.
Attention: To check the authenticity of testing/inspection report & certificate, please contact us at telephone: (86-755) 8307 1443, or email: CN.Doccheck@sgs.com

South of No. 6 Plant, No. 1, Runsheng Road, Suzhou Industrial Park, Suzhou Area, China (Jiangsu) Pilot Free Trade Zone 215000
 中国·苏州·中国(江苏)自由贸易试验区苏州片区苏州工业园区润胜路1号的6号厂房南楼 邮编: 215000

t (86-512) 62992980 www.sgs.com.cn
 t (86-512) 62992980 sgs.china@sgs.com

BLE 2M_Channel 00

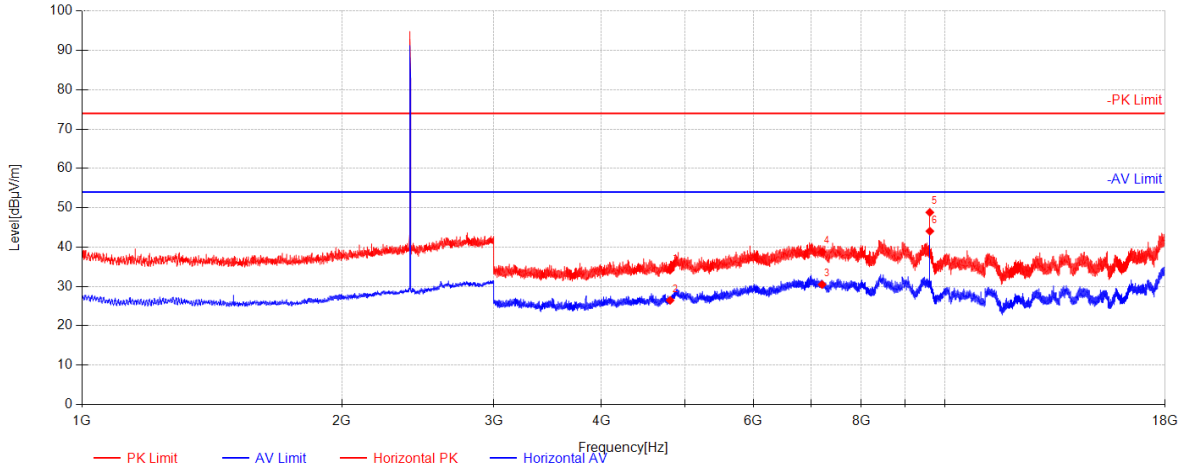

Data List										
NO.	Frequency [MHz]	Reading [dBµV]	AF [dB/m]	Factor [dB]	Level [dBµV/m]	Limit [dBµV/m]	Margin [dB]	Height [cm]	Angle [°]	Polarity
1	4804.0000	47.38	32.33	-45.54	34.17	74.00	39.83	158	278	Horizontal
2	4804.0000	39.69	32.33	-45.54	26.48	54.00	27.52	142	222	Horizontal
3	7206.0000	37.33	36.60	-43.44	30.49	54.00	23.51	261	4	Horizontal
4	7206.0000	45.64	36.60	-43.44	38.80	74.00	35.20	239	360	Horizontal
5	9608.0000	50.04	38.43	-39.65	48.82	74.00	25.18	143	360	Horizontal
6	9608.5	45.27	38.43	-39.65	44.05	54.00	9.95	122	360	Horizontal



Unless otherwise agreed in writing, this document is issued by the Company subject to its General Conditions of Service printed overleaf, available on request or accessible at <http://www.sgs.com/en/Terms-and-Conditions.aspx> and, for electronic format documents, subject to Terms and Conditions for Electronic Documents at <http://www.sgs.com/en/Terms-and-Conditions/Terms-e-Documents.aspx>. Attention is drawn to the limitation of liability, indemnification and jurisdiction issues defined therein. Any holder of this document is advised that information contained hereon reflects the Company's findings at the time of its intervention only and within the limits of Client's instructions, if any. The Company's sole responsibility is to its Client and this document does not exonerate parties to a transaction from exercising all their rights and obligations under the transaction documents. This document cannot be reproduced except in full, without prior written approval of the Company. Any unauthorized alteration, forgery or falsification of the content or appearance of this document is unlawful and offenders may be prosecuted to the fullest extent of the law. Unless otherwise stated the results shown in this test report refer only to the sample(s) tested and such sample(s) are retained for 30 days only.
Attention: To check the authenticity of testing/inspection report & certificate, please contact us at telephone: (86-755) 8307 1443, or email: CN.Doccheck@sgs.com

South of No. 6 Plant, No. 1, Runsheng Road, Suzhou Industrial Park, Suzhou Area, China (Jiangsu) Pilot Free Trade Zone 215000 t (86-512) 62992980 www.sgs.com.cn
 中国·苏州·中国(江苏)自由贸易试验区苏州片区苏州工业园区润胜路1号的6号厂房南楼 邮编: 215000 t (86-512) 62992980 sgs.china@sgs.com

BLE 2M_Channel 00

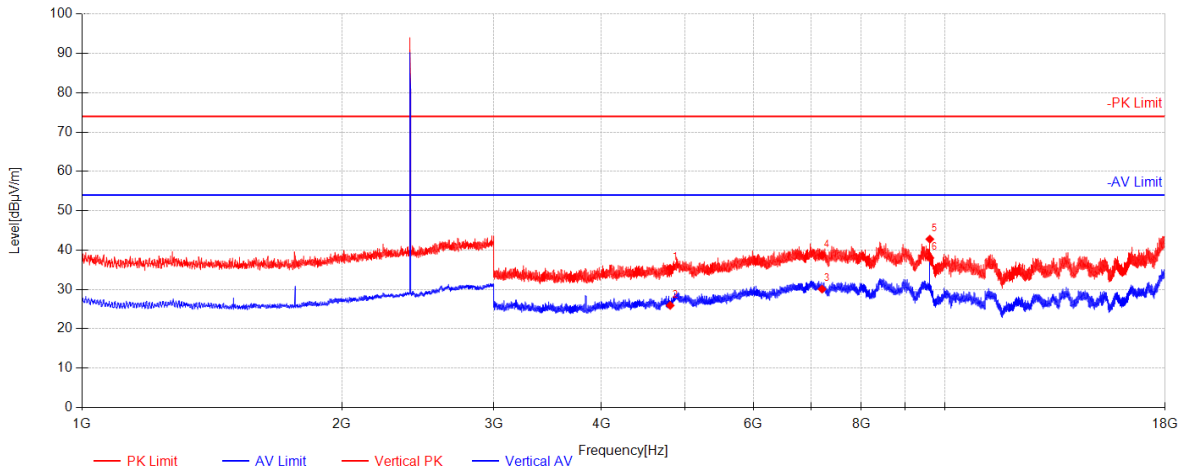

Data List										
NO.	Frequency [MHz]	Reading [dBµV]	AF [dB/m]	Factor [dB]	Level [dBµV/m]	Limit [dBµV/m]	Margin [dB]	Height [cm]	Angle [°]	Polarity
1	4804.0000	48.59	32.33	-45.54	35.38	74.00	38.62	216	195	Vertical
2	4804.0000	39.14	32.33	-45.54	25.93	54.00	28.07	255	55	Vertical
3	7206.0000	36.92	36.60	-43.44	30.08	54.00	23.92	130	279	Vertical
4	7206.0000	45.57	36.60	-43.44	38.73	74.00	35.27	196	166	Vertical
5	9608.0000	44.00	38.43	-39.65	42.78	74.00	31.22	175	55	Vertical
6	9608.5	39.23	38.43	-39.65	38.01	54.00	15.99	148	29	Vertical



Unless otherwise agreed in writing, this document is issued by the Company subject to its General Conditions of Service printed overleaf, available on request or accessible at <http://www.sgs.com/en/Terms-and-Conditions.aspx> and, for electronic format documents, subject to Terms and Conditions for Electronic Documents at <http://www.sgs.com/en/Terms-and-Conditions/Terms-e-Documents.aspx>. Attention is drawn to the limitation of liability, indemnification and jurisdiction issues defined therein. Any holder of this document is advised that information contained hereon reflects the Company's findings at the time of its intervention only and within the limits of Client's instructions, if any. The Company's sole responsibility is to its Client and this document does not exonerate parties to a transaction from exercising all their rights and obligations under the transaction documents. This document cannot be reproduced except in full, without prior written approval of the Company. Any unauthorized alteration, forgery or falsification of the content or appearance of this document is unlawful and offenders may be prosecuted to the fullest extent of the law. Unless otherwise stated the results shown in this test report refer only to the sample(s) tested and such sample(s) are retained for 30 days only.
Attention: To check the authenticity of testing/inspection report & certificate, please contact us at telephone: (86-755) 8307 1443, or email: CN.Doccheck@sgs.com

South of No. 6 Plant, No. 1, Runsheng Road, Suzhou Industrial Park, Suzhou Area, China (Jiangsu) Pilot Free Trade Zone 215000
 中国·苏州·中国(江苏)自由贸易试验区苏州片区苏州工业园区润胜路1号的6号厂房南楼 邮编: 215000

t (86-512) 62992980 www.sgs.com.cn
 t (86-512) 62992980 sgs.china@sgs.com

BLE 2M_Channel 19

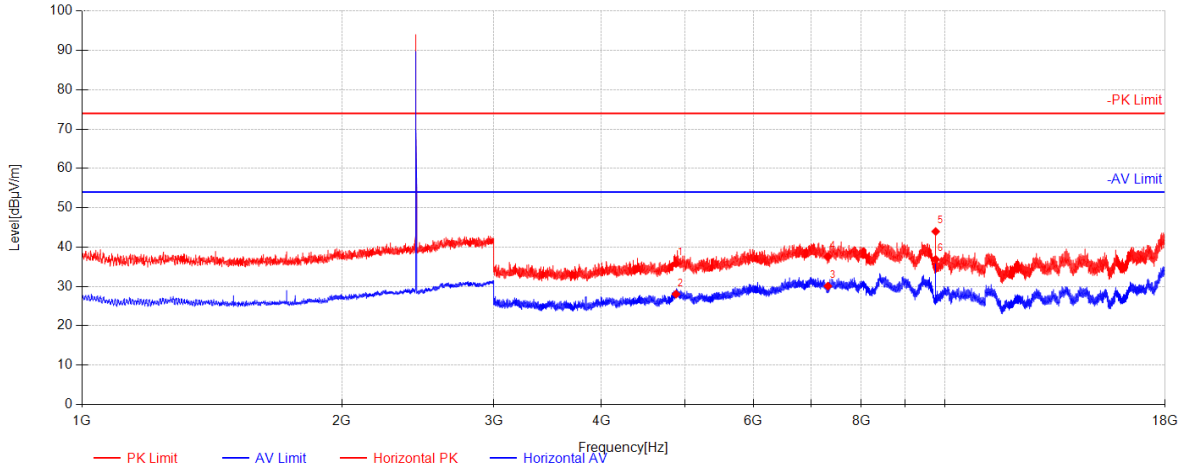

Data List										
NO.	Frequency [MHz]	Reading [dBµV]	AF [dB/m]	Factor [dB]	Level [dBµV/m]	Limit [dBµV/m]	Margin [dB]	Height [cm]	Angle [°]	Polarity
1	4880.0000	48.83	32.54	-45.53	35.84	74.00	38.16	289	56	Horizontal
2	4880.0000	41.03	32.54	-45.53	28.04	54.00	25.96	154	359	Horizontal
3	7320.0000	37.24	36.53	-43.68	30.09	54.00	23.91	175	56	Horizontal
4	7320.0000	44.76	36.53	-43.68	37.61	74.00	36.39	162	56	Horizontal
5	9758	45.16	38.27	-39.46	43.96	74.00	30.04	130	360	Horizontal
6	9758.5	38.08	38.27	-39.46	36.88	54.00	17.12	133	195	Horizontal



Unless otherwise agreed in writing, this document is issued by the Company subject to its General Conditions of Service printed overleaf, available on request or accessible at <http://www.sgs.com/en/Terms-and-Conditions.aspx> and, for electronic format documents, subject to Terms and Conditions for Electronic Documents at <http://www.sgs.com/en/Terms-and-Conditions/Terms-e-Documents.aspx>. Attention is drawn to the limitation of liability, indemnification and jurisdiction issues defined therein. Any holder of this document is advised that information contained hereon reflects the Company's findings at the time of its intervention only and within the limits of Client's instructions, if any. The Company's sole responsibility is to its Client and this document does not exonerate parties to a transaction from exercising all their rights and obligations under the transaction documents. This document cannot be reproduced except in full, without prior written approval of the Company. Any unauthorized alteration, forgery or falsification of the content or appearance of this document is unlawful and offenders may be prosecuted to the fullest extent of the law. Unless otherwise stated the results shown in this test report refer only to the sample(s) tested and such sample(s) are retained for 30 days only.
Attention: To check the authenticity of testing/inspection report & certificate, please contact us at telephone: (86-755) 8307 1443, or email: CN.Doccheck@sgs.com

South of No. 6 Plant, No. 1, Runsheng Road, Suzhou Industrial Park, Suzhou Area, China (Jiangsu) Pilot Free Trade Zone 215000 t (86-512) 62992980 www.sgs.com.cn
 中国·苏州·中国(江苏)自由贸易试验区苏州片区苏州工业园区润胜路1号的6号厂房南楼 邮编: 215000 t (86-512) 62992980 sgs.china@sgs.com

BLE 2M_Channel 19

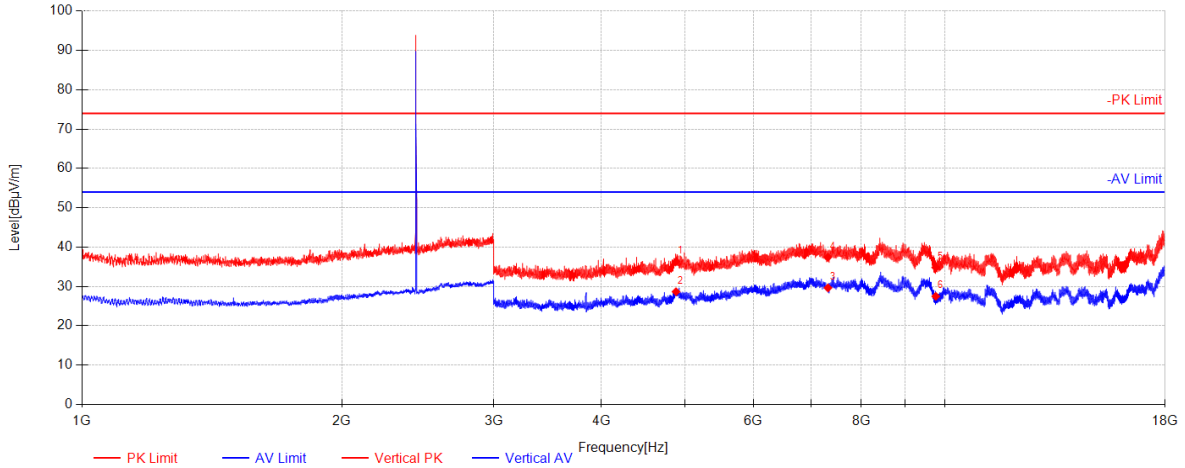

Data List										
NO.	Frequency [MHz]	Reading [dBµV]	AF [dB/m]	Factor [dB]	Level [dBµV/m]	Limit [dBµV/m]	Margin [dB]	Height [cm]	Angle [°]	Polarity
1	4880.0000	49.34	32.54	-45.53	36.35	74.00	37.65	210	305	Vertical
2	4880.0000	41.65	32.54	-45.53	28.66	54.00	25.34	199	54	Vertical
3	7320.0000	36.79	36.53	-43.68	29.64	54.00	24.36	178	307	Vertical
4	7320.0000	44.61	36.53	-43.68	37.46	74.00	36.54	162	360	Vertical
5	9760.0000	36.03	38.26	-39.46	34.83	74.00	39.17	135	360	Vertical
6	9760.0000	28.69	38.26	-39.46	27.49	54.00	26.51	146	26	Vertical



Unless otherwise agreed in writing, this document is issued by the Company subject to its General Conditions of Service printed overleaf, available on request or accessible at <http://www.sgs.com/en/Terms-and-Conditions.aspx> and, for electronic format documents, subject to Terms and Conditions for Electronic Documents at <http://www.sgs.com/en/Terms-and-Conditions/Terms-e-Documents.aspx>. Attention is drawn to the limitation of liability, indemnification and jurisdiction issues defined therein. Any holder of this document is advised that information contained hereon reflects the Company's findings at the time of its intervention only and within the limits of Client's instructions, if any. The Company's sole responsibility is to its Client and this document does not exonerate parties to a transaction from exercising all their rights and obligations under the transaction documents. This document cannot be reproduced except in full, without prior written approval of the Company. Any unauthorized alteration, forgery or falsification of the content or appearance of this document is unlawful and offenders may be prosecuted to the fullest extent of the law. Unless otherwise stated the results shown in this test report refer only to the sample(s) tested and such sample(s) are retained for 30 days only.
Attention: To check the authenticity of testing/inspection report & certificate, please contact us at telephone: (86-755) 8307 1443, or email: CN.Doccheck@sgs.com

South of No. 6 Plant, No. 1, Runsheng Road, Suzhou Industrial Park, Suzhou Area, China (Jiangsu) Pilot Free Trade Zone 215000 t (86-512) 62992980 www.sgs.com.cn
 中国·苏州·中国(江苏)自由贸易试验区苏州片区苏州工业园区润胜路1号的6号厂房南楼 邮编: 215000 t (86-512) 62992980 sgs.china@sgs.com

BLE 2M_Channel 39

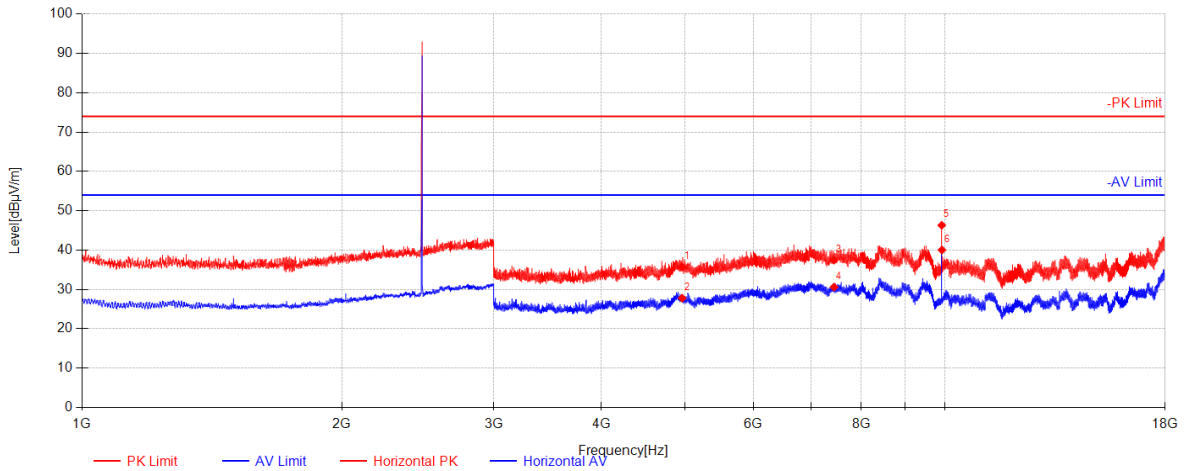

Data List										
NO.	Frequency [MHz]	Reading [dBµV]	AF [dB/m]	Factor [dB]	Level [dBµV/m]	Limit [dBµV/m]	Margin [dB]	Height [cm]	Angle [°]	Polarity
1	4960.0000	48.58	32.77	-45.60	35.75	74.00	38.25	289	3	Horizontal
2	4960.0000	40.63	32.77	-45.60	27.80	54.00	26.20	145	165	Horizontal
3	7440.0000	44.28	36.47	-43.30	37.45	74.00	36.55	266	111	Horizontal
4	7440.0000	37.42	36.47	-43.30	30.59	54.00	23.41	132	305	Horizontal
5	9918	47.24	38.38	-39.31	46.31	74.00	27.69	211	3	Horizontal
6	9922.5	40.96	38.39	-39.31	40.04	54.00	13.96	147	360	Horizontal



Unless otherwise agreed in writing, this document is issued by the Company subject to its General Conditions of Service printed overleaf, available on request or accessible at <http://www.sgs.com/en/Terms-and-Conditions.aspx> and, for electronic format documents, subject to Terms and Conditions for Electronic Documents at <http://www.sgs.com/en/Terms-and-Conditions/Terms-e-Documents.aspx>. Attention is drawn to the limitation of liability, indemnification and jurisdiction issues defined therein. Any holder of this document is advised that information contained hereon reflects the Company's findings at the time of its intervention only and within the limits of Client's instructions, if any. The Company's sole responsibility is to its Client and this document does not exonerate parties to a transaction from exercising all their rights and obligations under the transaction documents. This document cannot be reproduced except in full, without prior written approval of the Company. Any unauthorized alteration, forgery or falsification of the content or appearance of this document is unlawful and offenders may be prosecuted to the fullest extent of the law. Unless otherwise stated the results shown in this test report refer only to the sample(s) tested and such sample(s) are retained for 30 days only.
Attention: To check the authenticity of testing/inspection report & certificate, please contact us at telephone: (86-755) 8307 1443, or email: CN.Doccheck@sgs.com

South of No. 6 Plant, No. 1, Runsheng Road, Suzhou Industrial Park, Suzhou Area, China (Jiangsu) Pilot Free Trade Zone 215000 t (86-512) 62992980 www.sgs.com.cn
 中国·苏州·中国(江苏)自由贸易试验区苏州片区苏州工业园区润胜路1号的6号厂房南楼 邮编: 215000 t (86-512) 62992980 sgs.china@sgs.com

BLE 2M_Channel 39

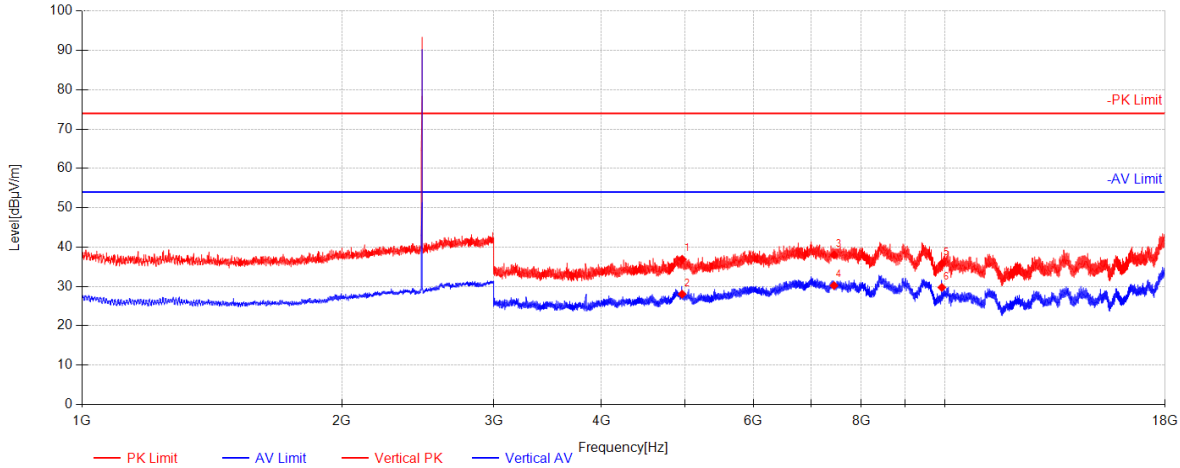

Data List										
NO.	Frequency [MHz]	Reading [dBµV]	AF [dB/m]	Factor [dB]	Level [dBµV/m]	Limit [dBµV/m]	Margin [dB]	Height [cm]	Angle [°]	Polarity
1	4960.0000	49.75	32.77	-45.60	36.92	74.00	37.08	187	195	Vertical
2	4960.0000	40.88	32.77	-45.60	28.05	54.00	25.95	164	140	Vertical
3	7440.0000	44.86	36.47	-43.30	38.03	74.00	35.97	145	114	Vertical
4	7440.0000	37.06	36.47	-43.30	30.23	54.00	23.77	166	82	Vertical
5	9920.0000	36.75	38.38	-39.31	35.82	74.00	38.18	192	306	Vertical
6	9920.0000	30.68	38.38	-39.31	29.75	54.00	24.25	170	56	Vertical

Remark:

- The field strength is calculated by adding the Antenna Factor, Cable Factor & Preamplifier gain. The basic equation with a sample calculation is as follows:
 $Level = Reading(dB\mu V) + AF(dB/m) + Factor(dB)$
 $AF = Antenna\ Factor(dB/m)$
 $Factor = Cable\ Factor(dB) - Preamplifier\ gain(dB)$
 $Margin = Limit(dB\mu V/m) - Level(dB\mu V/m)$
- All channels have been tested, but only the worst case data displayed in this report.



Unless otherwise agreed in writing, this document is issued by the Company subject to its General Conditions of Service printed overleaf, available on request or accessible at <http://www.sgs.com/en/Terms-and-Conditions.aspx> and, for electronic format documents, subject to Terms and Conditions for Electronic Documents at <http://www.sgs.com/en/Terms-and-Conditions/Terms-e-Documents.aspx>. Attention is drawn to the limitation of liability, indemnification and jurisdiction issues defined therein. Any holder of this document is advised that information contained hereon reflects the Company's findings at the time of its intervention only and within the limits of Client's instructions, if any. The Company's sole responsibility is to its Client and this document does not exonerate parties to a transaction from exercising all their rights and obligations under the transaction documents. This document cannot be reproduced except in full, without prior written approval of the Company. Any unauthorized alteration, forgery or falsification of the content or appearance of this document is unlawful and offenders may be prosecuted to the fullest extent of the law. Unless otherwise stated the results shown in this test report refer only to the sample(s) tested and such sample(s) are retained for 30 days only.
Attention: To check the authenticity of testing/inspection report & certificate, please contact us at telephone: (86-755) 8307 1443, or email: CN.Doccheck@sgs.com
 South of No. 6 Plant, No. 1, Runsheng Road, Suzhou Industrial Park, Suzhou Area, China (Jiangsu) Pilot Free Trade Zone 215000 t (86-512) 62992980 www.sgs.com.cn
 中国·苏州·中国(江苏)自由贸易试验区苏州片区苏州工业园区润胜路1号的6号厂房南楼 邮编: 215000 t (86-512) 62992980 sgs.china@sgs.com

Restricted bands around fundamental frequency

BLE 1M_Channel 00

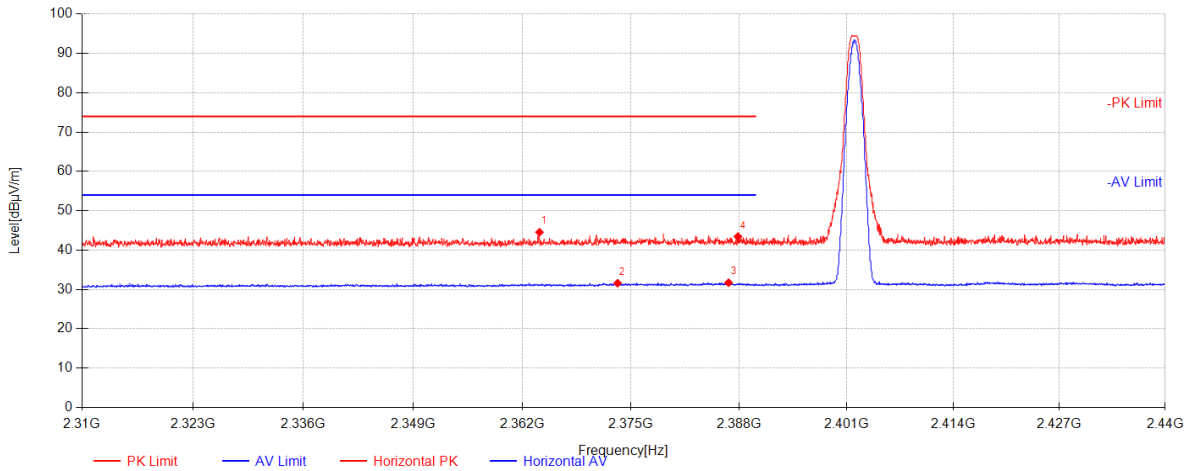

Data List										
NO.	Frequency [MHz]	Reading [dBµV]	AF [dB/m]	Factor [dB]	Level [dBµV/m]	Limit [dBµV/m]	Margin [dB]	Height [cm]	Angle [°]	Polarity
1	2364.0367	40.69	27.42	-23.57	44.54	74.00	29.46	136	264	Horizontal
2	2373.3967	27.75	27.43	-23.57	31.60	54.00	22.40	136	264	Horizontal
3	2386.7433	27.85	27.43	-23.57	31.71	54.00	22.29	136	264	Horizontal
4	2387.87	39.57	27.43	-23.57	43.43	74.00	30.57	136	264	Horizontal



Unless otherwise agreed in writing, this document is issued by the Company subject to its General Conditions of Service printed overleaf, available on request or accessible at <http://www.sgs.com/en/Terms-and-Conditions.aspx> and, for electronic format documents, subject to Terms and Conditions for Electronic Documents at <http://www.sgs.com/en/Terms-and-Conditions/Terms-e-Documents.aspx>. Attention is drawn to the limitation of liability, indemnification and jurisdiction issues defined therein. Any holder of this document is advised that information contained hereon reflects the Company's findings at the time of its intervention only and within the limits of Client's instructions, if any. The Company's sole responsibility is to its Client and this document does not exonerate parties to a transaction from exercising all their rights and obligations under the transaction documents. This document cannot be reproduced except in full, without prior written approval of the Company. Any unauthorized alteration, forgery or falsification of the content or appearance of this document is unlawful and offenders may be prosecuted to the fullest extent of the law. Unless otherwise stated the results shown in this test report refer only to the sample(s) tested and such sample(s) are retained for 30 days only.

Attention: To check the authenticity of testing/inspection report & certificate, please contact us at telephone: (86-755) 8307 1443, or email: CN.Doccheck@sgs.com

South of No. 6 Plant, No. 1, Runsheng Road, Suzhou Industrial Park, Suzhou Area, China (Jiangsu) Pilot Free Trade Zone 215000
 中国·苏州·中国(江苏)自由贸易试验区苏州片区苏州工业园区润胜路1号的6号厂房南楼 邮编: 215000

t (86-512) 62992980 www.sgs.com.cn
 t (86-512) 62992980 sgs.china@sgs.com

BLE 1M_Channel 00

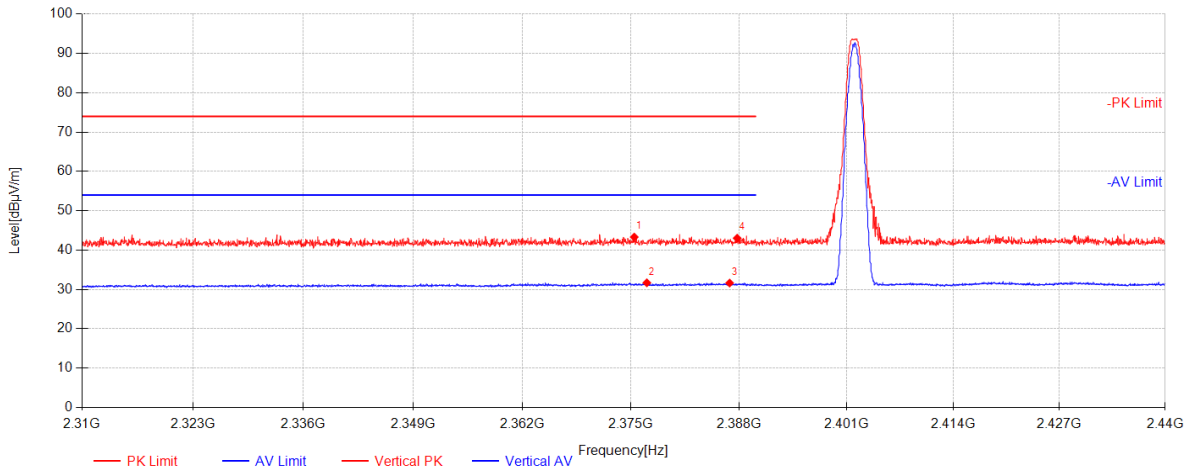

Data List										
NO.	Frequency [MHz]	Reading [dBµV]	AF [dB/m]	Factor [dB]	Level [dBµV/m]	Limit [dBµV/m]	Margin [dB]	Height [cm]	Angle [°]	Polarity
1	2375.39	39.46	27.43	-23.57	43.32	74.00	30.68	266	145	Vertical
2	2376.9067	27.83	27.43	-23.57	31.69	54.00	22.31	266	145	Vertical
3	2386.8733	27.77	27.43	-23.57	31.63	54.00	22.37	266	145	Vertical
4	2387.7833	39.18	27.43	-23.57	43.04	74.00	30.96	266	145	Vertical



Unless otherwise agreed in writing, this document is issued by the Company subject to its General Conditions of Service printed overleaf, available on request or accessible at <http://www.sgs.com/en/Terms-and-Conditions.aspx> and, for electronic format documents, subject to Terms and Conditions for Electronic Documents at <http://www.sgs.com/en/Terms-and-Conditions/Terms-e-Documents.aspx>. Attention is drawn to the limitation of liability, indemnification and jurisdiction issues defined therein. Any holder of this document is advised that information contained hereon reflects the Company's findings at the time of its intervention only and within the limits of Client's instructions, if any. The Company's sole responsibility is to its Client and this document does not exonerate parties to a transaction from exercising all their rights and obligations under the transaction documents. This document cannot be reproduced except in full, without prior written approval of the Company. Any unauthorized alteration, forgery or falsification of the content or appearance of this document is unlawful and offenders may be prosecuted to the fullest extent of the law. Unless otherwise stated the results shown in this test report refer only to the sample(s) tested and such sample(s) are retained for 30 days only.
Attention: To check the authenticity of testing/inspection report & certificate, please contact us at telephone: (86-755) 8307 1443, or email: CN.Doccheck@sgs.com

South of No. 6 Plant, No. 1, Runsheng Road, Suzhou Industrial Park, Suzhou Area, China (Jiangsu) Pilot Free Trade Zone 215000 t (86-512) 62992980 www.sgs.com.cn
 中国·苏州·中国(江苏)自由贸易试验区苏州片区苏州工业园区润胜路1号的6号厂房南楼 邮编: 215000 t (86-512) 62992980 sgs.china@sgs.com

BLE 1M_Channel 39

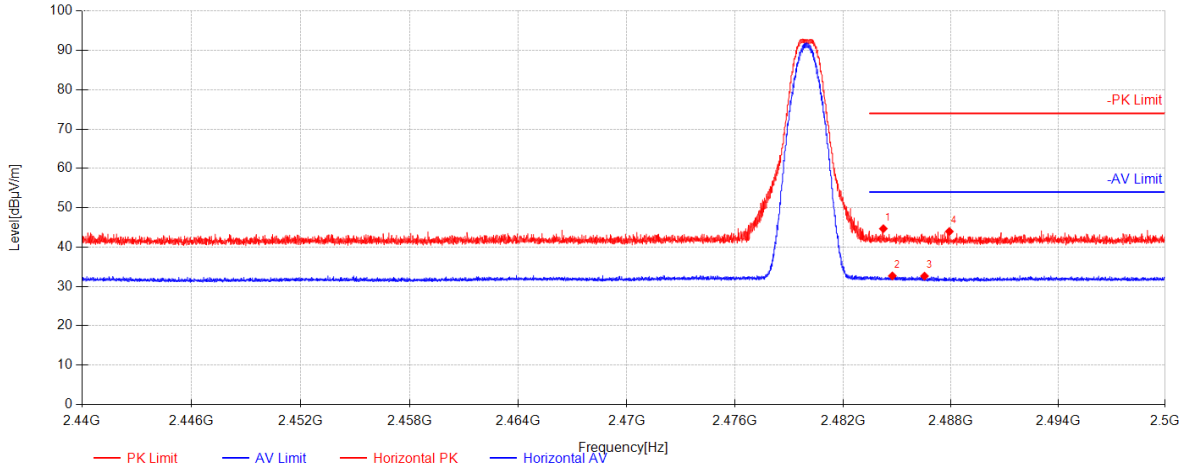

Data List										
NO.	Frequency [MHz]	Reading [dBµV]	AF [dB/m]	Factor [dB]	Level [dBµV/m]	Limit [dBµV/m]	Margin [dB]	Height [cm]	Angle [°]	Polarity
1	2484.25	40.51	27.72	-23.54	44.68	74.00	29.32	211	71	Horizontal
2	2484.7525	28.50	27.72	-23.54	32.68	54.00	21.32	211	71	Horizontal
3	2486.545	28.45	27.73	-23.54	32.63	54.00	21.37	211	71	Horizontal
4	2487.9325	39.79	27.73	-23.54	43.98	74.00	30.02	211	71	Horizontal



Unless otherwise agreed in writing, this document is issued by the Company subject to its General Conditions of Service printed overleaf, available on request or accessible at <http://www.sgs.com/en/Terms-and-Conditions.aspx> and, for electronic format documents, subject to Terms and Conditions for Electronic Documents at <http://www.sgs.com/en/Terms-and-Conditions/Terms-e-Documents.aspx>. Attention is drawn to the limitation of liability, indemnification and jurisdiction issues defined therein. Any holder of this document is advised that information contained hereon reflects the Company's findings at the time of its intervention only and within the limits of Client's instructions, if any. The Company's sole responsibility is to its Client and this document does not exonerate parties to a transaction from exercising all their rights and obligations under the transaction documents. This document cannot be reproduced except in full, without prior written approval of the Company. Any unauthorized alteration, forgery or falsification of the content or appearance of this document is unlawful and offenders may be prosecuted to the fullest extent of the law. Unless otherwise stated the results shown in this test report refer only to the sample(s) tested and such sample(s) are retained for 30 days only.

Attention: To check the authenticity of testing/inspection report & certificate, please contact us at telephone: (86-755) 8307 1443, or email: CN.Doccheck@sgs.com

South of No. 6 Plant, No. 1, Runsheng Road, Suzhou Industrial Park, Suzhou Area, China (Jiangsu) Pilot Free Trade Zone 215000 t (86-512) 62992980 www.sgs.com.cn
 中国·苏州·中国(江苏)自由贸易试验区苏州片区苏州工业园区润胜路1号的6号厂房南楼 邮编: 215000 t (86-512) 62992980 sgs.china@sgs.com

BLE 1M_Channel 39

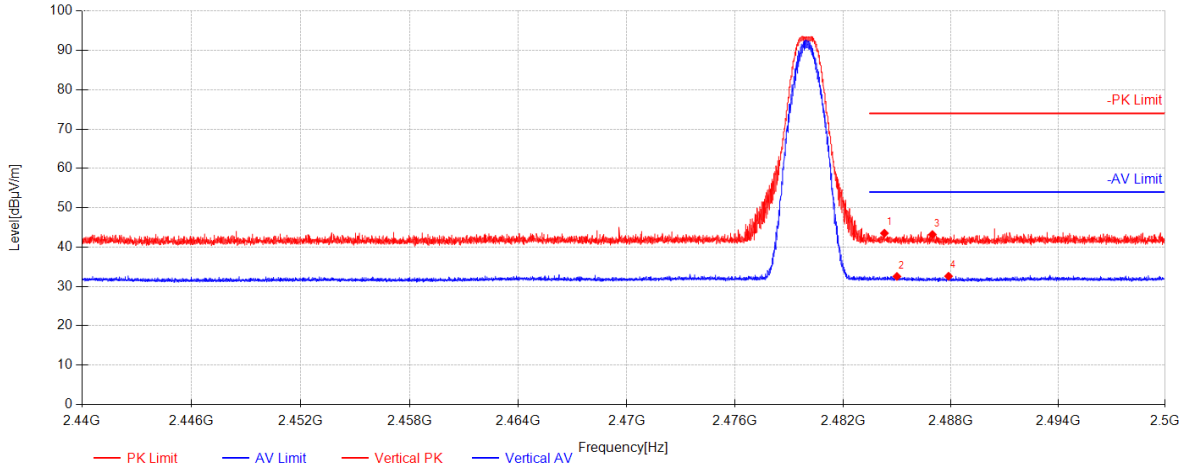

Data List										
NO.	Frequency [MHz]	Reading [dBµV]	AF [dB/m]	Factor [dB]	Level [dBµV/m]	Limit [dBµV/m]	Margin [dB]	Height [cm]	Angle [°]	Polarity
1	2484.31	39.36	27.72	-23.54	43.53	74.00	30.47	196	288	Vertical
2	2485.0075	28.37	27.72	-23.54	32.55	54.00	21.45	196	288	Vertical
3	2486.9875	39.02	27.73	-23.54	43.20	74.00	30.80	196	288	Vertical
4	2487.8875	28.41	27.73	-23.54	32.60	54.00	21.40	196	288	Vertical



Unless otherwise agreed in writing, this document is issued by the Company subject to its General Conditions of Service printed overleaf, available on request or accessible at <http://www.sgs.com/en/Terms-and-Conditions.aspx> and, for electronic format documents, subject to Terms and Conditions for Electronic Documents at <http://www.sgs.com/en/Terms-and-Conditions/Terms-e-Documents.aspx>. Attention is drawn to the limitation of liability, indemnification and jurisdiction issues defined therein. Any holder of this document is advised that information contained hereon reflects the Company's findings at the time of its intervention only and within the limits of Client's instructions, if any. The Company's sole responsibility is to its Client and this document does not exonerate parties to a transaction from exercising all their rights and obligations under the transaction documents. This document cannot be reproduced except in full, without prior written approval of the Company. Any unauthorized alteration, forgery or falsification of the content or appearance of this document is unlawful and offenders may be prosecuted to the fullest extent of the law. Unless otherwise stated the results shown in this test report refer only to the sample(s) tested and such sample(s) are retained for 30 days only.

Attention: To check the authenticity of testing/inspection report & certificate, please contact us at telephone: (86-755) 8307 1443, or email: CN.Doccheck@sgs.com

South of No. 6 Plant, No. 1, Runsheng Road, Suzhou Industrial Park, Suzhou Area, China (Jiangsu) Pilot Free Trade Zone 215000 t (86-512) 62992980 www.sgs.com.cn
 中国·苏州·中国(江苏)自由贸易试验区苏州片区苏州工业园区润胜路1号的6号厂房南楼 邮编: 215000 t (86-512) 62992980 sgs.china@sgs.com

BLE 2M_Channel 00

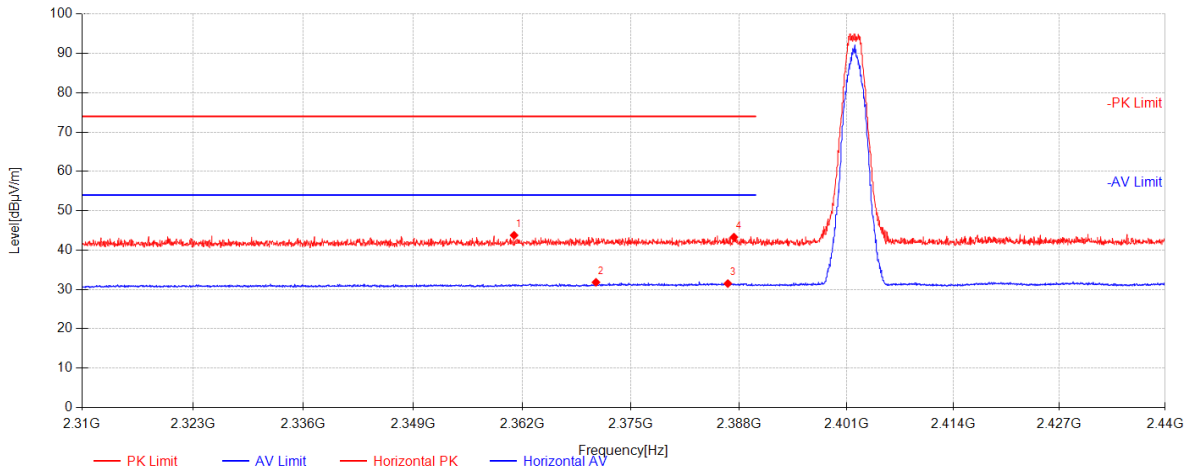

Data List										
NO.	Frequency [MHz]	Reading [dBµV]	AF [dB/m]	Factor [dB]	Level [dBµV/m]	Limit [dBµV/m]	Margin [dB]	Height [cm]	Angle [°]	Polarity
1	2361.0033	39.92	27.42	-23.57	43.77	74.00	30.23	244	183	Horizontal
2	2370.7967	27.97	27.43	-23.57	31.82	54.00	22.18	244	183	Horizontal
3	2386.6567	27.64	27.43	-23.57	31.50	54.00	22.50	244	183	Horizontal
4	2387.3933	39.44	27.43	-23.57	43.30	74.00	30.70	244	183	Horizontal



Unless otherwise agreed in writing, this document is issued by the Company subject to its General Conditions of Service printed overleaf, available on request or accessible at <http://www.sgs.com/en/Terms-and-Conditions.aspx> and, for electronic format documents, subject to Terms and Conditions for Electronic Documents at <http://www.sgs.com/en/Terms-and-Conditions/Terms-e-Documents.aspx>. Attention is drawn to the limitation of liability, indemnification and jurisdiction issues defined therein. Any holder of this document is advised that information contained hereon reflects the Company's findings at the time of its intervention only and within the limits of Client's instructions, if any. The Company's sole responsibility is to its Client and this document does not exonerate parties to a transaction from exercising all their rights and obligations under the transaction documents. This document cannot be reproduced except in full, without prior written approval of the Company. Any unauthorized alteration, forgery or falsification of the content or appearance of this document is unlawful and offenders may be prosecuted to the fullest extent of the law. Unless otherwise stated the results shown in this test report refer only to the sample(s) tested and such sample(s) are retained for 30 days only.
Attention: To check the authenticity of testing/inspection report & certificate, please contact us at telephone: (86-755) 8307 1443, or email: CN.Doccheck@sgs.com

South of No. 6 Plant, No. 1, Runsheng Road, Suzhou Industrial Park, Suzhou Area, China (Jiangsu) Pilot Free Trade Zone 215000 t (86-512) 62992980 www.sgs.com.cn
 中国·苏州·中国(江苏)自由贸易试验区苏州片区苏州工业园区润胜路1号的6号厂房南楼 邮编: 215000 t (86-512) 62992980 sgs.china@sgs.com

BLE 2M_Channel 00

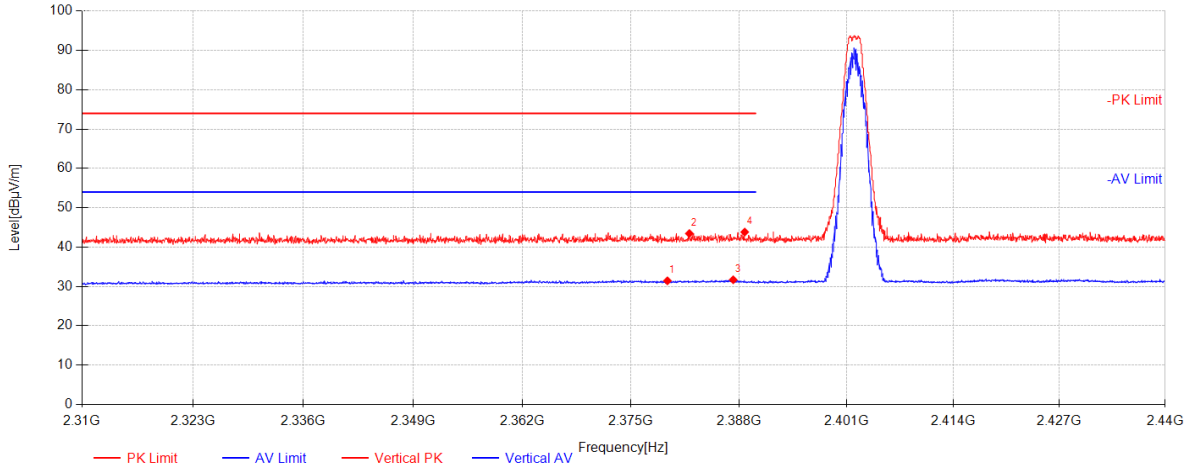

Data List										
NO.	Frequency [MHz]	Reading [dBµV]	AF [dB/m]	Factor [dB]	Level [dBµV/m]	Limit [dBµV/m]	Margin [dB]	Height [cm]	Angle [°]	Polarity
1	2379.3767	27.58	27.43	-23.57	31.44	54.00	22.56	139	44	Vertical
2	2382.02	39.60	27.43	-23.57	43.46	74.00	30.54	139	44	Vertical
3	2387.3067	27.84	27.43	-23.57	31.70	54.00	22.30	139	44	Vertical
4	2388.6933	39.97	27.43	-23.57	43.83	74.00	30.17	139	44	Vertical



Unless otherwise agreed in writing, this document is issued by the Company subject to its General Conditions of Service printed overleaf, available on request or accessible at <http://www.sgs.com/en/Terms-and-Conditions.aspx> and, for electronic format documents, subject to Terms and Conditions for Electronic Documents at <http://www.sgs.com/en/Terms-and-Conditions/Terms-e-Documents.aspx>. Attention is drawn to the limitation of liability, indemnification and jurisdiction issues defined therein. Any holder of this document is advised that information contained hereon reflects the Company's findings at the time of its intervention only and within the limits of Client's instructions, if any. The Company's sole responsibility is to its Client and this document does not exonerate parties to a transaction from exercising all their rights and obligations under the transaction documents. This document cannot be reproduced except in full, without prior written approval of the Company. Any unauthorized alteration, forgery or falsification of the content or appearance of this document is unlawful and offenders may be prosecuted to the fullest extent of the law. Unless otherwise stated the results shown in this test report refer only to the sample(s) tested and such sample(s) are retained for 30 days only.
Attention: To check the authenticity of testing /inspection report & certificate, please contact us at telephone: (86-755) 8307 1443, or email: CN.Doccheck@sgs.com

South of No. 6 Plant, No. 1, Runsheng Road, Suzhou Industrial Park, Suzhou Area, China (Jiangsu) Pilot Free Trade Zone 215000 t (86-512) 62992980 www.sgs.com.cn
 中国·苏州·中国(江苏)自由贸易试验区苏州片区苏州工业园区润胜路1号的6号厂房南楼 邮编: 215000 t (86-512) 62992980 sgs.china@sgs.com

BLE 2M_Channel 39

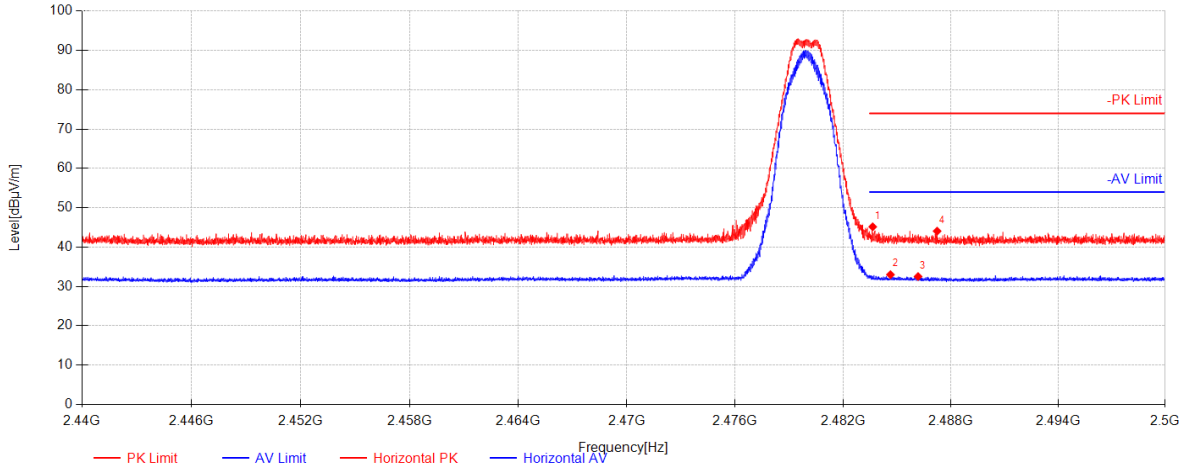

Data List										
NO.	Frequency [MHz]	Reading [dBµV]	AF [dB/m]	Factor [dB]	Level [dBµV/m]	Limit [dBµV/m]	Margin [dB]	Height [cm]	Angle [°]	Polarity
1	2483.6575	41.00	27.72	-23.54	45.17	74.00	28.83	254	87	Horizontal
2	2484.6475	28.83	27.72	-23.54	33.00	54.00	21.00	254	87	Horizontal
3	2486.185	28.34	27.72	-23.54	32.52	54.00	21.48	254	87	Horizontal
4	2487.25	39.88	27.73	-23.54	44.06	74.00	29.94	254	87	Horizontal



Unless otherwise agreed in writing, this document is issued by the Company subject to its General Conditions of Service printed overleaf, available on request or accessible at <http://www.sgs.com/en/Terms-and-Conditions.aspx> and, for electronic format documents, subject to Terms and Conditions for Electronic Documents at <http://www.sgs.com/en/Terms-and-Conditions/Terms-e-Documents.aspx>. Attention is drawn to the limitation of liability, indemnification and jurisdiction issues defined therein. Any holder of this document is advised that information contained hereon reflects the Company's findings at the time of its intervention only and within the limits of Client's instructions, if any. The Company's sole responsibility is to its Client and this document does not exonerate parties to a transaction from exercising all their rights and obligations under the transaction documents. This document cannot be reproduced except in full, without prior written approval of the Company. Any unauthorized alteration, forgery or falsification of the content or appearance of this document is unlawful and offenders may be prosecuted to the fullest extent of the law. Unless otherwise stated the results shown in this test report refer only to the sample(s) tested and such sample(s) are retained for 30 days only.

Attention: To check the authenticity of testing/inspection report & certificate, please contact us at telephone: (86-755) 8307 1443, or email: CN.Doccheck@sgs.com

South of No. 6 Plant, No. 1, Runsheng Road, Suzhou Industrial Park, Suzhou Area, China (Jiangsu) Pilot Free Trade Zone 215000 t (86-512) 62992980 www.sgs.com.cn
 中国·苏州·中国(江苏)自由贸易试验区苏州片区苏州工业园区润胜路1号的6号厂房南楼 邮编: 215000 t (86-512) 62992980 sgs.china@sgs.com

BLE 2M_Channel 39

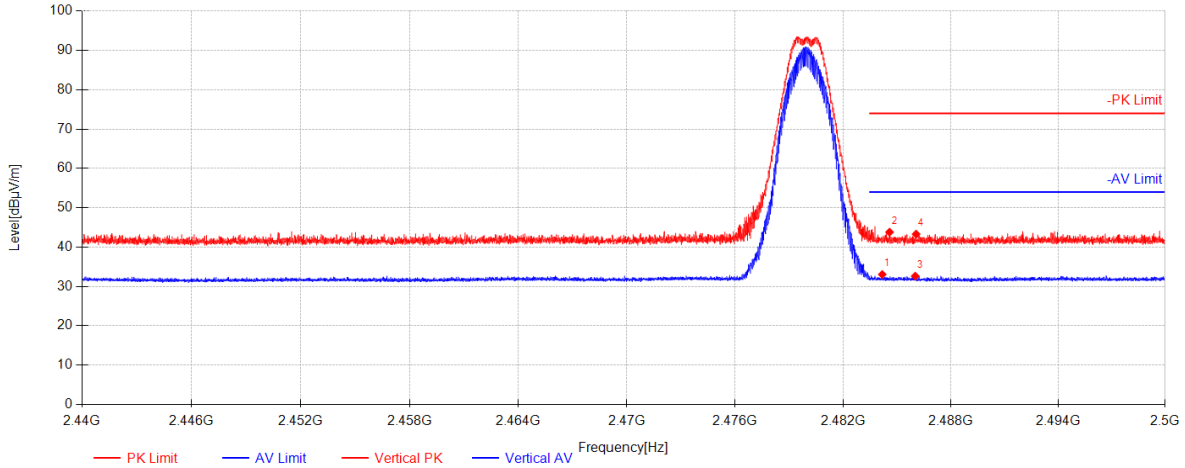

Data List										
NO.	Frequency [MHz]	Reading [dBµV]	AF [dB/m]	Factor [dB]	Level [dBµV/m]	Limit [dBµV/m]	Margin [dB]	Height [cm]	Angle [°]	Polarity
1	2484.19	28.88	27.72	-23.54	33.05	54.00	20.95	186	334	Vertical
2	2484.595	39.64	27.72	-23.54	43.81	74.00	30.19	186	334	Vertical
3	2486.0275	28.44	27.72	-23.54	32.62	54.00	21.38	186	334	Vertical
4	2486.08	39.12	27.72	-23.54	43.30	74.00	30.70	186	334	Vertical

Remark:

1) The field strength is calculated by adding the Antenna Factor, Cable Factor & Preamplifier gain. The basic equation with a sample calculation is as follows:

$$\text{Level} = \text{Reading}(\text{dB}\mu\text{V}) + \text{AF}(\text{dB}/\text{m}) + \text{Factor}(\text{dB}):$$

$$\text{AF} = \text{Antenna Factor}(\text{dB}/\text{m})$$

$$\text{Factor} = \text{Cable Factor}(\text{dB}) - \text{Preamplifier gain}(\text{dB})$$

$$\text{Margin} = \text{Limit}(\text{dB}\mu\text{V}/\text{m}) - \text{Level}(\text{dB}\mu\text{V}/\text{m})$$

---End of Report---



Unless otherwise agreed in writing, this document is issued by the Company subject to its General Conditions of Service printed overleaf, available on request or accessible at <http://www.sgs.com/en/Terms-and-Conditions.aspx> and, for electronic format documents, subject to Terms and Conditions for Electronic Documents at <http://www.sgs.com/en/Terms-and-Conditions/Terms-e-Documents.aspx>. Attention is drawn to the limitation of liability, indemnification and jurisdiction issues defined therein. Any holder of this document is advised that information contained hereon reflects the Company's findings at the time of its intervention only and within the limits of Client's instructions, if any. The Company's sole responsibility is to its Client and this document does not exonerate parties to a transaction from exercising all their rights and obligations under the transaction documents. This document cannot be reproduced except in full, without prior written approval of the Company. Any unauthorized alteration, forgery or falsification of the content or appearance of this document is unlawful and offenders may be prosecuted to the fullest extent of the law. Unless otherwise stated the results shown in this test report refer only to the sample(s) tested and such sample(s) are retained for 30 days only.
Attention: To check the authenticity of testing/inspection report & certificate, please contact us at telephone: (86-755) 8307 1443, or email: CN.Doccheck@sgs.com

South of No. 6 Plant, No. 1, Runsheng Road, Suzhou Industrial Park, Suzhou Area, China (Jiangsu) Pilot Free Trade Zone 215000
 中国·苏州·中国(江苏)自由贸易试验区苏州片区苏州工业园区润胜路1号的6号厂房南楼 邮编: 215000

t (86-512) 62992980 www.sgs.com.cn
 t (86-512) 62992980 sgs.china@sgs.com