



RF MEASUREMENT REPORT

FCC ID: XMR2022RG520NNA

Application: Quectel Wireless Solutions Co., Ltd

Product: 5G Sub-6 GHz LGA Module

Model No.: RG520N-NA

Brand Name: Quectel

FCC Rule Part(s): Part 96

Result: Complies

Test Date: 2022-09-27 ~ 2022-10-15

Reviewed By:

Sunny Sun

Approved By:

Robin Wu



The test results relate only to the samples tested.

This equipment has been shown to be capable of compliance with the applicable technical standards as indicated in the measurement report and was tested in accordance with the measurement procedures specified in ANSI C63.26-2015. Test results reported herein relate only to the item(s) tested.

The test report shall not be reproduced except in full without the written approval of MRT Technology (Suzhou) Co., Ltd.

Revision History

Report No.	Version	Description	Issue Date	Note
2209RSU052-U1	Rev. 01	Initial Report	2022-10-23	Valid

CONTENTS

Description	Page
1. General Information.....	5
1.1. Applicant	5
1.2. Manufacturer	5
1.3. Testing Facility	5
1.4. Product Information.....	6
1.5. Radio Specification	6
1.6. Description of Available Antennas.....	6
1.7. Test Methodology	7
1.8. Device Capabilities	7
2. Test Configuration	8
2.1. Test System Connection Diagram.....	8
2.2. Test Environment Condition	8
3. Measuring Instrument	9
4. Decision Rules and Measurement Uncertainty.....	11
4.1. Decision Rules	11
4.2. Measurement Uncertainty.....	11
5. Test Result.....	12
5.1. Summary.....	12
5.2. Occupied Bandwidth Measurement.....	13
5.2.1. Test Limit	13
5.2.2. Test Procedure.....	13
5.2.3. Test Setting	13
5.2.4. Test Setup	13
5.2.5. Test Result	13
5.3. Frequency Stability Measurement	14
5.3.1. Test Limit	14
5.3.2. Test Procedure.....	14
5.3.3. Test Setting	14
5.3.4. Test Setup	15
5.3.5. Test Result	15
5.4. Equivalent Isotropically Radiated Power Measurement	16
5.4.1. Test Limit	16
5.4.2. Test Procedure.....	16
5.4.3. Test Setting	16

5.4.4.	Test Setup	17
5.4.5.	Test Result	17
5.5.	Band Edge Measurement	18
5.5.1.	Test Limit	18
5.5.2.	Test Procedure	18
5.5.3.	Test Setting	18
5.5.4.	Test Setup	19
5.5.5.	Test Result	19
5.6.	Conducted Spurious Emissions Measurement.....	20
5.6.1.	Test Limit	20
5.6.2.	Test Procedure	20
5.6.3.	Test Setting	20
5.6.4.	Test Setup	21
5.6.5.	Test Result	21
5.7.	Radiated Spurious Emissions Measurement.....	22
5.7.1.	Test Limit	22
5.7.2.	Test Procedure	22
5.7.3.	Test Setting	22
5.7.4.	Test Setup	23
5.7.5.	Test Result	24
5.8.	End User Device Additional Requirement (CBSD Protocol) Measurement.....	25
5.8.1.	Test Limit	25
5.8.2.	Test Procedure	25
5.8.3.	Test Setting	25
5.8.4.	Test Result	25
Appendix A - Test Result		26
A.1	Occupied Bandwidth Test Result.....	26
A.2	Frequency Stability Test Result	38
A.3	Equivalent Isotropically Radiated Power Test Result	39
A.4	Band Edge Test Result	81
A.5	Conducted Spurious Emissions Test Result	102
A.6	Radiated Spurious Emissions Test Result	114
A.7	End User Device Additional Requirement (CBSD Protocol) Test Result	117
Appendix B - Test Setup Photograph		119
Appendix C - EUT Photograph		120

1. General Information

1.1. Applicant

Quectel Wireless Solutions Company Limited

Building 5, Shanghai Business Park Phase III (Area B), No.1016 Tianlin Road, Minhang District, Shanghai, China 200233

1.2. Manufacturer

Quectel Wireless Solutions Company Limited

Building 5, Shanghai Business Park Phase III (Area B), No.1016 Tianlin Road, Minhang District, Shanghai, China 200233

1.3. Testing Facility

<input checked="" type="checkbox"/>	<p>Test Site - MRT Suzhou Laboratory</p> <p>Laboratory Location (Suzhou - Wuzhong) D8 Building, No.2 Tian'edang Rd., Wuzhong Economic Development Zone, Suzhou, China</p> <p>Laboratory Location (Suzhou - SIP) 4b Building, Liando U Valley, No.200 Xingpu Rd., Shengpu Town, Suzhou Industrial Park, China</p> <p>Laboratory Accreditations</p> <p>A2LA: 3628.01 CNAS: L10551</p> <p>FCC: CN1166 ISED: CN0001</p> <p>VCCI: <input type="checkbox"/>R-20025 <input type="checkbox"/>G-20034 <input type="checkbox"/>C-20020 <input type="checkbox"/>T-20020</p> <p> <input type="checkbox"/>R-20141 <input type="checkbox"/>G-20134 <input type="checkbox"/>C-20103 <input type="checkbox"/>T-20104</p>
<input type="checkbox"/>	<p>Test Site - MRT Shenzhen Laboratory</p> <p>Laboratory Location (Shenzhen) 1G, Building A, Junxiangda Building, Zhongshanyuan Road West, Nanshan District, Shenzhen, China</p> <p>Laboratory Accreditations</p> <p>A2LA: 3628.02 CNAS: L10551</p> <p>FCC: CN1284 ISED: CN0105</p>
<input type="checkbox"/>	<p>Test Site - MRT Taiwan Laboratory</p> <p>Laboratory Location (Taiwan) No. 38, Fuxing 2nd Rd., Guishan Dist., Taoyuan City 333, Taiwan (R.O.C.)</p> <p>Laboratory Accreditations</p> <p>TAF: L3261-190725</p> <p>FCC: 291082, TW3261 ISED: TW3261</p>

1.4. Product Information

Product Name	5G Sub-6 GHz LGA Module
Model No.	RG520N-NA
Brand Name	Quectel
IMEI	863109050013080
E-UTRA Specification	
Single Band:	Band 2, 4, 5, 7, 12, 13, 14, 17, 25, 26, 30, 38, 41, 48, 66, 71
Intra-Band:	CA_2C, CA_5B, CA_7C, CA_38C, CA_41C, CA_48C, CA_66B, CA_66C
5G NR Specification	
NR SA Band	n2, n5, n7, n12, n13, n14, n25, n26, n30, n38, n41, n48, n66, n71, n77, n78
NR SA UL MIMO Band	n38, n41, n48, n77, n78
NR NSA Band	n2, n5, n7, n12, n14, n25, n30, n38, n41, n48, n66, n71, n77, n78
HPUE Band	n38, n41, n77, n78 (SA & UL MIMO)
Supply Voltage	3.3 ~ 4.4Vdc, typical 3.8Vdc
Operating Temperature:	-30 ~ 75 °C
Remark: The information of EUT was provided by the manufacturer, and the accuracy of the information shall be the responsibility of the manufacturer.	

1.5. Radio Specification under Testing

TDD Tx & Rx Frequency Range	n48: 3550 ~ 3700 MHz
SCS for NR cell	30kHz
Support Bandwidth	10MHz, 20MHz, 30MHz, 40MHz
Modulation	UL up to 256QAM, DL up to 256QAM
Device Type	End User Device

1.6. Description of Available Antennas

Technology	Frequency Range (MHz)	Antenna Type	MaxPeak Gain (dBi)
n48	3550 ~ 3700	Dipole	0.58

Note: The typical antennas use to calculate the ERP (EIRP).

1.7. Test Methodology

According to the specifications of the manufacturer, the EUT must comply with the requirements of the following standards:

- ANSI C63.26:2015
- FCC CFR 47 Part Part 96
- FCC KDB 971168 D01 v03r01: Power Meas License Digital Systems
- FCC KDB 971168 D02 v02r01: Misc Rev Approv License Devices
- FCC KDB 412172 D01 v01r01: Determining ERP and EIRP
- WINNF-TS-0122 V1.0.2: Test and Certification for Citizens Broadband Radio Service (CBRS); Conformance and Performance Test Technical Specification; CBS/D/DP as Unit Under Test (UUT)

1.8. Device Capabilities

This device contains 5G NR SA & EN-DC the following capabilities:

PI/2 BPSK modulation applied for 5G NR band frequencies and has the same tune up power as QPSK modulations.

The DFT-s-OFDM and CP-OFDM waveforms were investigated, and DFT-s-OFDM was found to be the worst case.

UL MIMO mode only support CP-OFDM.

The worst-case scenario for all measurements is based on an engineering evaluation and QPSK was observed as the worst one and set for all conducted and radiated. Output power measurements were measured on PI/2 BPSK, QPSK, 16QAM, 64QAM, 256QAM, and BPSK modulations.

For EN-DC mode, 5G NR FR1 bands are tested in this report (Output Power, Conducted Band Edge, Radiated Spurious Emissions), all the other RF bands are tested in the other reports separately.

2. Test Configuration

2.1. Test System Connection Diagram

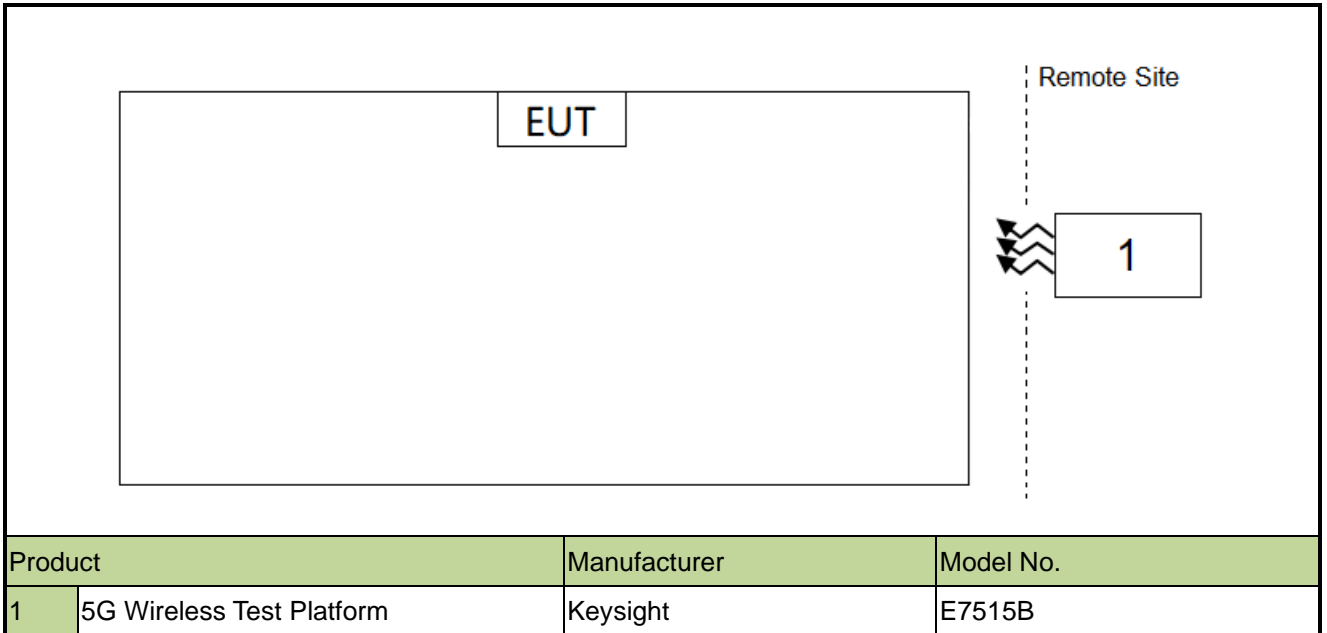

2.2. Test Environment Condition

Ambient Temperature	15 ~ 35°C
Relative Humidity	20% ~ 75%RH

3. Measuring Instrument

Instrument	Manufacturer	Model No.	Asset No.	Cali. Interval	Cali. Due Date	Test Site
Signal Generator	Keysight	E8257D	MRTSUE06453	1 year	2023-06-01	SIP-SR1
Thermohygrometer	testo	622	MRTSUE06629	1 year	2023-01-06	SIP-SR1
5G Wireless Test Platform	Keysight	E7515B	MRTSUE06903	1 year	2022-11-23	SIP-SR1
Signal Generator	Keysight	E8257D	MRTSUE06904	1 year	2022-11-23	SIP-SR1
DC POWER MODULE	Keysight	N6743B	MRTSUE06905	N/A	N/A	SIP-SR1
DC POWER MODULE	Keysight	N6743B	MRTSUE06906	N/A	N/A	SIP-SR1
Low-Profile Modular Power System Mainframe	Keysight	N6700C	MRTSUE06907	N/A	N/A	SIP-SR1
FR1 Switching Unit	Keysight	C8880A	MRTSUE06908	N/A	N/A	SIP-SR1
Signal Analyzer	Keysight	N9021B	MRTSUE06915	1 year	2022-12-29	SIP-SR1
Temperature Chamber	BAOYT	BYG-80CL	MRTSUE06932	1 year	2023-02-27	SIP-SR1
Shielding Room	MIX-BEP	SIP-SR1	MRTSUE06948	N/A	N/A	SIP-SR1
TRILOG Antenna	Schwarzbeck	VULB 9162	MRTSUE06022	1 year	2023-05-20	WZ-AC2
Loop Antenna	Schwarzbeck	FMZB 1519	MRTSUE06025	1 year	2022-10-28	WZ-AC1/WZ-AC2
EMI Test Receiver	Agilent	N9038A	MRTSUE06125	1 year	2023-06-04	WZ-AC2
Thermohygrometer	Mingle	ETH529	MRTSUE06170	1 year	2022-12-01	WZ-AC2
Horn Antenna	Schwarzbeck	BBHA 9120D	MRTSUE06171	1 year	2022-10-21	WZ-AC2
Preamplifier	Schwarzbeck	BBV 9718	MRTSUE06176	1 year	2022-11-12	WZ-AC2
Anechoic Chamber	RIKEN	WZ-AC2	MRTSUE06213	1 year	2023-04-21	WZ-AC2
Horn Antenna	ETS	3117	MRTSUE06257	1 year	2023-09-18	WZ-AC1/WZ-AC2
Horn Antenna	Schwarzbeck	BBHA 9170	MRTSUE06597	1 year	2022-12-01	WZ-AC1/WZ-AC2
Preamplifier	EMCI	EMC184045SE	MRTSUE06640	1 year	2023-01-13	WZ-AC1/WZ-AC2
Preamplifier	EMCI	EMC051845SE	MRTSUE06987	1 year	2023-09-08	WZ-AC1/WZ-AC2
Thermohygrometer	testo	608-H1	MRTSUE11038	1 year	2022-11-11	WZ-AC2
Directional Coupler	ar	DC7200A	MRTSUE06147	N/A	N/A	SIP
Directional Coupler	ar	DC6080A	MRTSUE06148	N/A	N/A	SIP
Directional Coupler	narda	4226-10	MRTSUE06564	1 year	2022-10-11	SIP
Directional Coupler	PULSAR	CS10-23-436/20	MRTSUE06846	1 year	2023-06-02	SIP
Directional Coupler	PULSAR	CS10-23-436/20	MRTSUE06848	1 year	2023-06-02	SIP
Attenuator	MVE	MVE2213	MRTSUE11055	1 year	2023-06-09	SIP
Attenuator	MVE	MVE2213	MRTSUE11056	1 year	2023-06-09	SIP
Attenuator	MVE	MVE2213	MRTSUE11057	1 year	2023-06-09	SIP
Attenuator	MVE	MVE2213	MRTSUE11058	1 year	2023-06-09	SIP
Attenuator	MVE	MVE2213	MRTSUE11059	1 year	2023-06-09	SIP
Attenuator	MVE	MVE2213	MRTSUE11060	1 year	2023-06-09	SIP

Software	Version	Manufacturer	Function	Date	Location
EMI V3	V 3.0.0	QuieTek	EMI Test Software	2010.01	EMC-WZ
Controller_MF 7802	1.02	MF	RE Antenna & Turntable	2015-07-05	EMC-WZ-AC2

4. Decision Rules and Measurement Uncertainty

4.1. Decision Rules

The Decision Rule is based on Simple Acceptance in accordance with ISO Guide 98-4: 2012 Clause 8.2. (Measurement uncertainty is not taken into account when stating conformity with a specified requirement.)

4.2. Measurement Uncertainty

Where relevant, the following test uncertainty levels have been estimated for tests performed on the EUT as specified in CISPR 16-4-2. This uncertainty represents an expanded uncertainty expressed at approximately the 95% confidence level using a coverage factor of $k = 2$.

Radiated Spurious Emissions
Measurement Uncertainty for a Level of Confidence of 95% ($U=2Uc(y)$): Horizontal: 9kHz ~ 300MHz: 5.04dB 300MHz ~ 1GHz: 4.95dB 1GHz ~ 40GHz: 6.40dB Vertical: 9kHz ~ 300MHz: 5.24dB 300MHz ~ 1GHz: 6.03dB 1GHz ~ 40GHz: 6.40dB
Conducted Spurious Emissions
Measuring Uncertainty for a Level of Confidence of 95% ($U=2Uc(y)$): 0.78dB
Output Power
Measuring Uncertainty for a Level of Confidence of 95% ($U=2Uc(y)$): 1.13dB
Occupied Bandwidth
Measuring Uncertainty for a Level of Confidence of 95% ($U=2Uc(y)$): 0.28%
Frequency Stability
Measuring Uncertainty for a Level of Confidence of 95% ($U=2Uc(y)$): 76.2Hz

5. Test Result

5.1. Summary

FCC Part Section(s)	Test Description	Test Condition	Verdict
2.1049	Occupied Bandwidth	Conducted	Pass
2.1055	Frequency Stability		Pass
96.41(b)	Equivalent Isotropic Radiated Power		Pass
2.1051 96.41(e)	Spurious Emissions; Band Edge Emissions		Pass
2.1053, 96.41(e)	Spurious Emissions	Radiated	Pass
96.47	End User Device Additional Requirements (CBSD Protocol)		Pass

Notes:

- 1) The analyzer plots shown in this section were all taken with a correction table loaded into the analyzer. The correction table was used to account for the losses of the cables and attenuators used as part of the system to connect the EUT to the analyzer at all frequencies of interest.
- 2) Pre-Scan has been conducted to determine the worst-case mode from all possible combinations between available modulations the worst-case was found.
- 3) All supported modulation types were evaluated. The worst-case emission of modulation was selected. Therefore, the Frequency Stability, Band Edge, Radiated & Conducted Spurious Emission were presented worst case in the test report.

5.2. Occupied Bandwidth Measurement

5.2.1. Test Limit

The occupied bandwidth, that is the frequency bandwidth such that, below its lower and above its upper frequency limits, the mean powers radiated are each equal to 0.5 percent of the total mean power radiated by a given emission shall be measured.

5.2.2. Test Procedure

ANSI C63.26-2015 - Section 5.4

5.2.3. Test Setting

1. Set center frequency to the nominal EUT channel center frequency
2. RBW = The nominal RBW shall be in the range of 1% to 5% of the anticipated OBW
3. $VBW \geq 3 \times RBW$
4. Detector = Peak
5. Trace mode = max hold
6. Sweep = auto couple
7. Allow the trace to stabilize
8. Use the 99% power bandwidth function of the instrument and report the measured bandwidth.

5.2.4. Test Setup

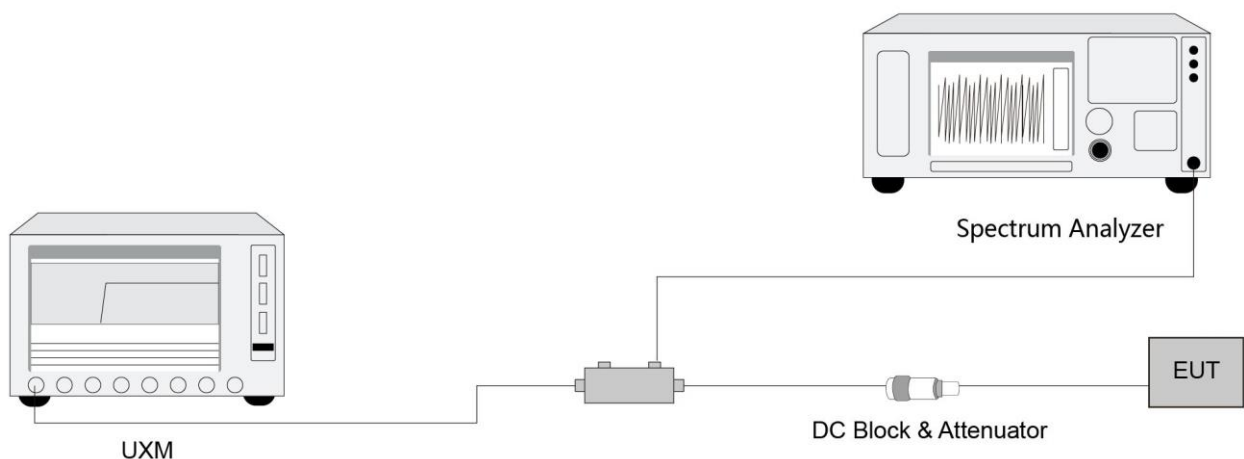

5.2.5. Test Result

Refer to Appendix A.1.

5.3. Frequency Stability Measurement

5.3.1. Test Limit

The frequency stability shall be measured by variation of ambient temperature and variation of primary supply voltage to ensure that the fundamental emission stays within the authorized frequency block. The frequency stability of the transmitter shall be maintained within $\pm 0.00025\%$ ($\pm 2.5\text{ppm}$) of the center frequency.

5.3.2. Test Procedure

ANSI C63.26-2015 - Section 5.6

5.3.3. Test Setting

Frequency Stability Under Temperature Variations:

The equipment under test was connected to an external AC or DC power supply and input rated voltage. RF output was connected to a frequency counter or spectrum analyzer via feed through attenuators. The EUT was placed inside the temperature chamber. Set the spectrum analyzer RBW low enough to obtain the desired frequency resolution and measure EUT 20°C operating frequency as reference frequency. Turn EUT off and set the chamber temperature to highest. After the temperature stabilized for approximately 30 minutes recorded the frequency. Repeat step measure with 10°C decreased per stage until the lowest temperature reached.

Frequency Stability Under Voltage Variations:

Set chamber temperature to 20°C. Use a variable AC power supply / DC power source to power the EUT and set the voltage to rated voltage. Set the spectrum analyzer RBW low enough to obtain the desired frequency resolution and recorded the frequency.

Reduce the input voltage to specify extreme voltage variation ($\pm 15\%$) and endpoint, record the maximum frequency change.

5.3.4. Test Setup

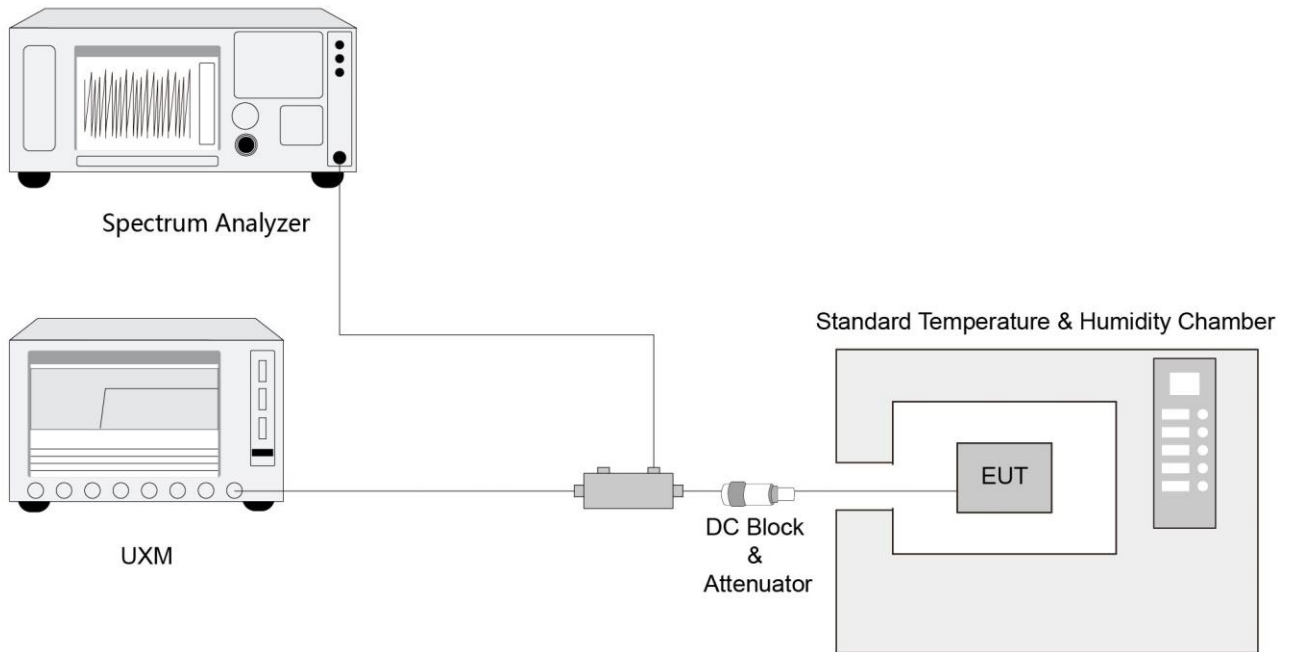

5.3.5. Test Result

Refer to Appendix A.2.

5.4. Equivalent Isotropically Radiated Power Measurement

5.4.1. Test Limit

The maximum effective isotropic radiated power (EIRP) End User Device is 23dBm/10MHz

5.4.2. Test Procedure

ANSI C63.26-2015 - Section 5.2.4.4.2 & 5.2.5.5

5.4.3. Test Setting

When the fundamental condition for average power measurements cannot be realized (i.e., the EUT can not be configured to transmit at full-power on a continuous basis (i.e., duty cycle < 98%) and the instrumentation cannot be configured to measure only during active full-power transmissions), then the following procedure can be used if the EUT duty cycle is constant (i.e., duty cycle variations are less than or equal to $\pm 2\%$).

- a) Set span to 2 × to 3 × the OBW.
- b) Set RBW = 1% to 5% of the OBW.
- c) Set VBW $\geq 3 \times$ RBW.
- d) Set number of measurement points in sweep $\geq 2 \times$ span / RBW.
- e) Sweep time:
 - 1) Set = auto-couple, or
 - 2) Set $\geq [10 \times (\text{number of points in sweep}) \times (\text{transmission symbol period})]$ for single sweep (automation-compatible) measurement.
- f) Detector = power averaging (rms).
- g) Set sweep trigger to “free run.”
- h) Trace average at least 100 traces in power averaging (rms) mode if sweep is set to auto-couple. To accurately determine the average power over the on and off time of the transmitter, it can be necessary to increase the number of traces to be averaged above 100, or if using a manually configured sweep time, increase the sweep time.
- i) Using the marker function to identify the maximum PSD.
- j) Add $10 \log (1/\text{duty cycle})$ to the measured power level to compute the average power during continuous transmission. For example, add $[10 \log (1/0.25)] = 6 \text{ dB}$ if the duty cycle is a constant 25%.

The relevant equation for determining the maximum ERP or EIRP from the measured RF output power is given in Equation (1) as follows:

$$\text{ERP or EIRP} = P_{\text{Meas}} + G_T \tag{1}$$

where

ERP or EIRP effective radiated power or equivalent isotropically radiated power, respectively (expressed in the same units as P_{Meas} , e.g., dBm or dBW)

P_{Meas} measured transmitter output power or PSD, in dBm or dBW

G_T gain of the transmitting antenna, in dBd (ERP) or dBi (EIRP)

For devices utilizing multiple antennas, see 6.4 for guidance with respect to determining the effective array transmit antenna gain term to be used in the above equation.

5.4.4. Test Setup

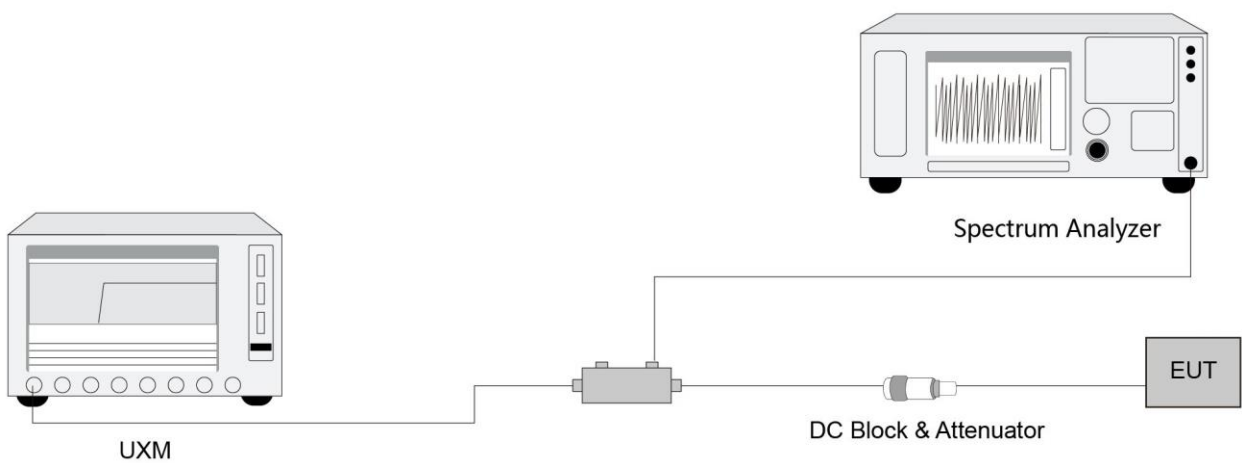

5.4.5. Test Result

Refer to Appendix A.3.

5.5. Band Edge Measurement

5.5.1. Test Limit

All out of band emissions are measured with a spectrum analyzer connected to the antenna terminal of the EUT while the EUT is operating at its maximum duty cycle, at maximum power, and at the appropriate frequencies. All data rates were investigated to determine the worst-case configuration. All modes of operation were investigated, and the worst-case configuration results are reported in this section.

The conducted power of any emission outside the fundamental emission (whether in or outside of the authorized band) shall not exceed -13 dBm/MHz within 0-10 megahertz above the upper SAS-assigned channel edge and within 0-10 megahertz below the lower SAS-assigned channel edge. At all frequencies greater than 10 megahertz above the upper SAS assigned channel edge and less than 10 MHz below the lower SAS assigned channel edge, the conducted power of any emission shall not exceed -25 dBm/MHz. The conducted power of any emissions below 3530 MHz or above 3720 MHz shall not exceed -40 dBm/MHz.

5.5.2. Test Procedure

ANSI C63.26-2015 - Section 5.7

5.5.3. Test Setting

1. Set the analyzer frequency to low, middle, high channel.
2. $RBW \geq$ The nominal RBW shall be in the range of 1% of the anticipated OBW (in the 1MHz band immediately outside and adjacent to the band edge). For improvement of the accuracy in the measurement of the average power of a noise-like emission, a RBW narrower than the specified reference bandwidth can be used (generally limited to no less than 1% of the OBW), provided that a subsequent integration is performed over the full required measurement bandwidth. This integration should be performed using the spectrum analyzer's band power functions.
3. $VBW \geq 3*RBW$
4. Sweep time = auto
5. Detector = power averaging (rms)
6. Set sweep trigger to "free run."
7. User gate triggered such that the analyzer only sweeps when the device is transmitting at full power
8. Trace average at least 100 traces in power averaging (rms) mode if sweep is set to auto-couple. To accurately determine the average power over the on and off time of the transmitter, it can be necessary to increase the number of traces to be averaged above 100, or if using a manually configured sweep time,

increase the sweep time.

9. Used power integration when using a measurement bandwidth smaller than the specified bandwidth.

5.5.4. Test Setup

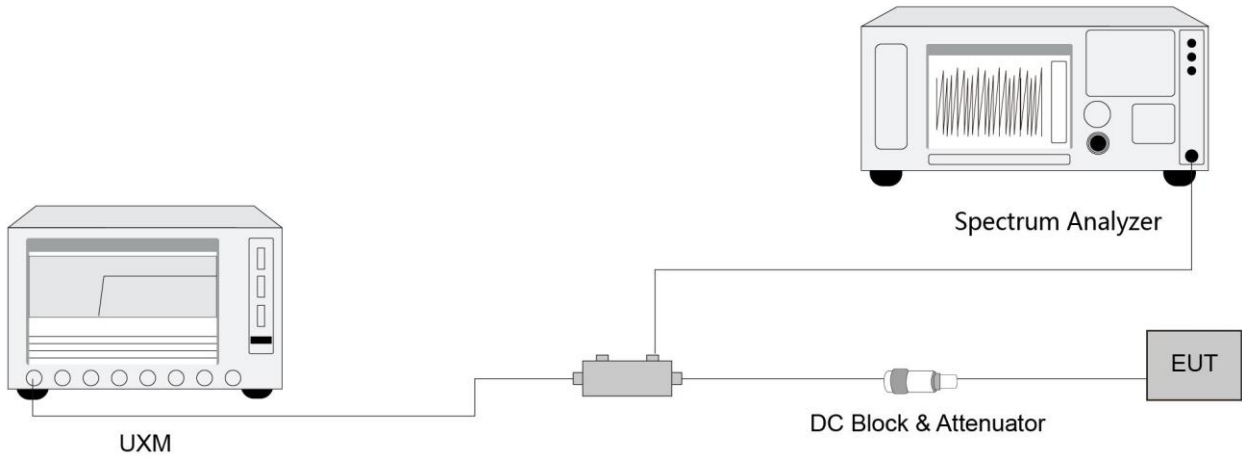

5.5.5. Test Result

Refer to Appendix A.4.

5.6. Conducted Spurious Emissions Measurement

5.6.1. Test Limit

The level of the carrier and the various conducted spurious and harmonic frequencies is measured by means of a calibrated spectrum analyzer. The spectrum is scanned from the lowest frequency generated in the equipment up to a frequency including its 10th harmonic. All out of band emissions are measured with a spectrum analyzer connected to the antenna terminal of the EUT while the EUT is operating at its maximum duty cycle, at maximum power, and at the appropriate frequencies. All data rates were investigated to determine the worst-case configuration. All modes of operation were investigated, and the worst-case configuration results are reported in this section.

The conducted power of any emissions below 3530MHz or above 3720MHz shall not exceed -40dBm/MHz.

5.6.2. Test Procedure

ANSI C63.26-2015 - Section 5.7

5.6.3. Test Setting

1. Set the analyzer frequency to low, mid, high channel.
2. RBW = 1MHz
3. VBW \geq 3*RBW
4. Sweep time = auto
5. Detector = power averaging (rms)
6. Set sweep trigger to "free run."
7. User gate triggered such that the analyzer only sweeps when the device is transmitting at full power.
8. Trace average at least 100 traces in power averaging (rms) mode if sweep is set to auto-couple. To accurately determine the average power over the on and off time of the transmitter, it can be necessary to increase the number of traces to be averaged above 100, or if using a manually configured sweep time, increase the sweep time.

5.6.4. Test Setup

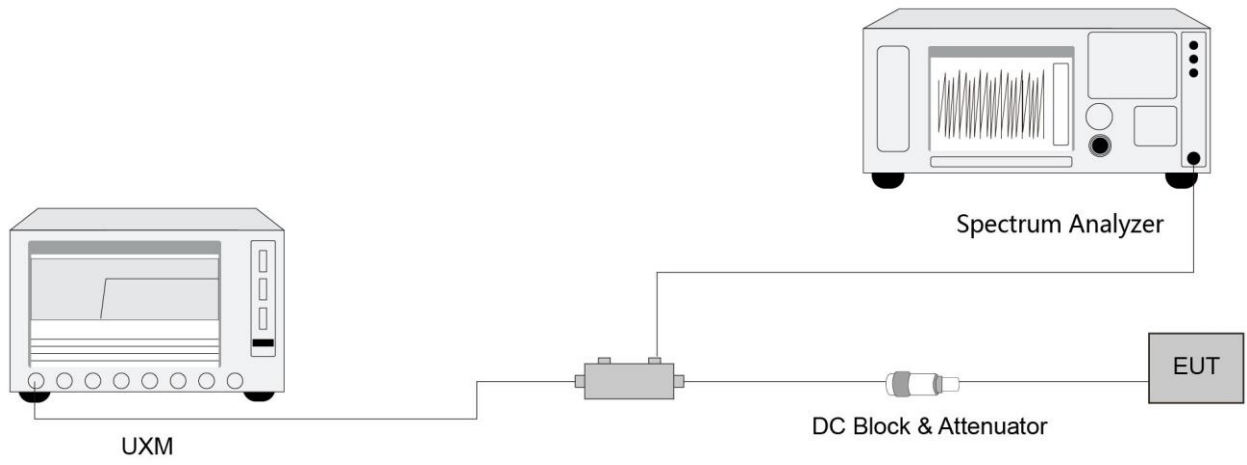

5.6.5. Test Result

Refer to Appendix A.5.

5.7. Radiated Spurious Emissions Measurement

5.7.1. Test Limit

Out of band emissions: The power of any emissions below 3530 MHz or above 3720 MHz shall not exceed -40dBm/MHz.

E (dB μ V/m) = EIRP (dBm) - 20 log D + 104.8; where D is the measurement distance in meters. The emission limit equal to 55.3dB μ V/m.

5.7.2. Test Procedure

ANSI C63.26-2015 - Section 5.2.7 & 5.5

5.7.3. Test Setting

1. RBW = 1MHz
2. VBW \geq 3*RBW
3. Sweep time \geq 10 \times (number of points in sweep) \times (transmission symbol period)
4. Detector = Peak
5. Trace mode = max hold
6. The trace was allowed to stabilize

5.7.4. Test Setup

Below 1GHz Test Setup:

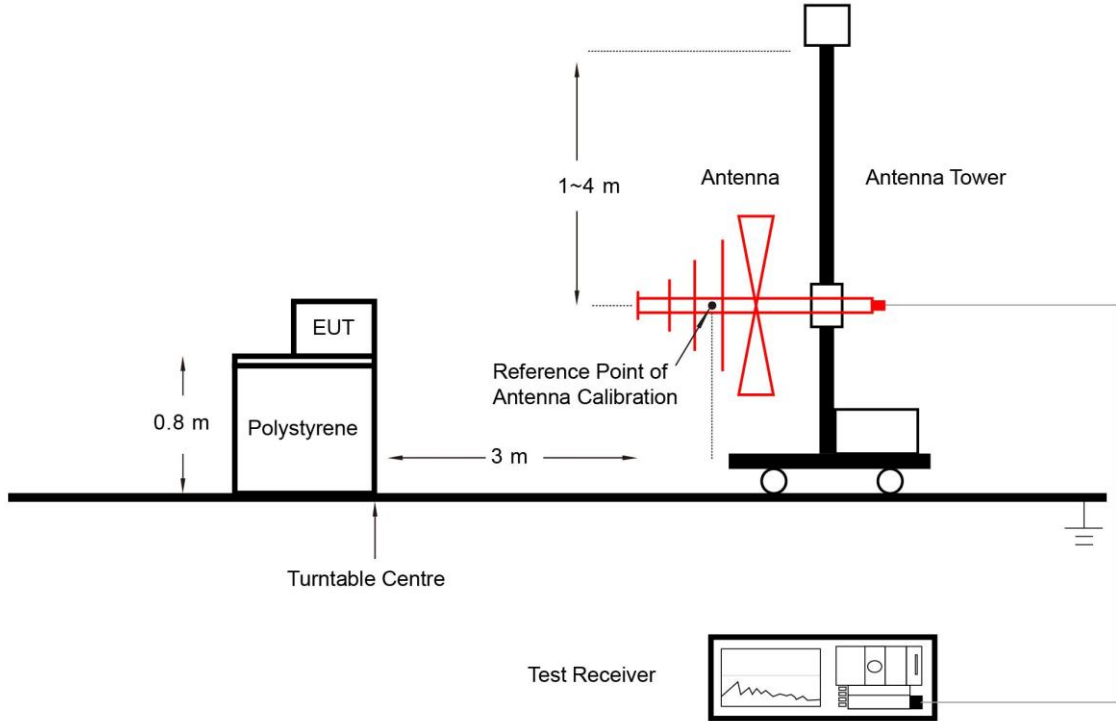

Above 1GHz Test Setup:

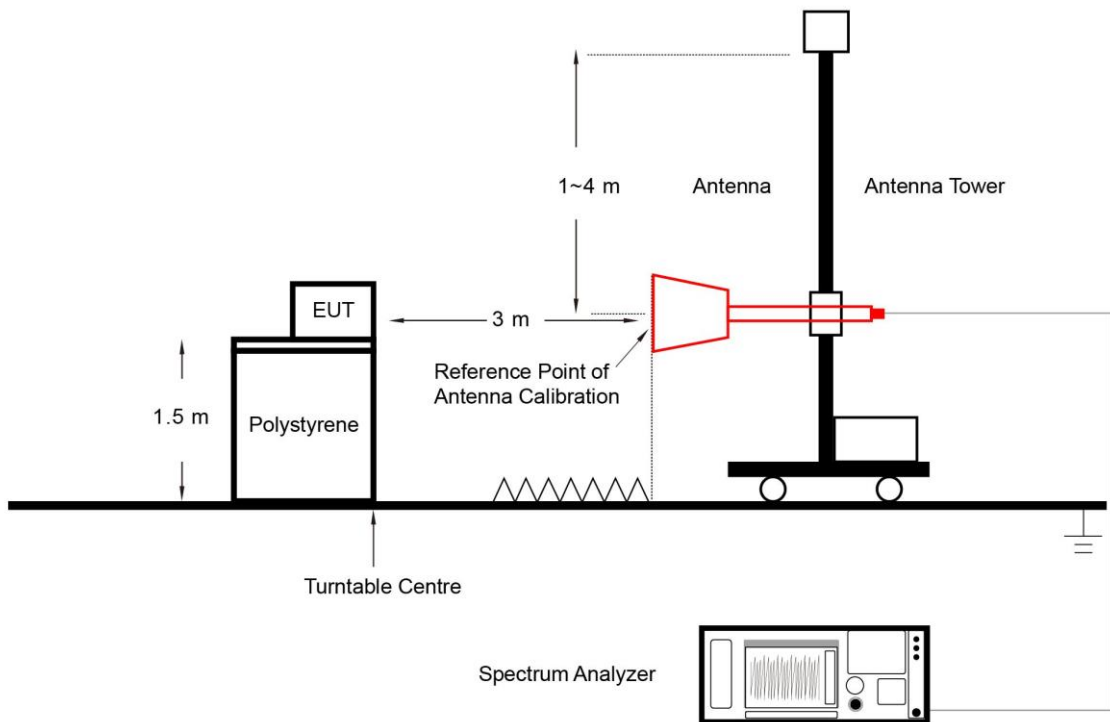

5.7.5. Test Result

Refer to Appendix A.6.

5.8. End User Device Additional Requirement (CBSD Protocol) Measurement

5.8.1. Test Limit

End User Devices may operate only if they can positively receive and decode an authorization signal transmitted by aCBSD, including the frequencies and power limits for their operation.

An End User Device must discontinue operations, change frequencies, or change its operational power level within 10 seconds of receiving instructions from its associated CBSD

5.8.2. Test Procedure

KDB 940660 D01 v02, WINNF-TS-0122 V1.0.2

5.8.3. Test Setting

The EUT was connected via an RF cable to a certified CBSD (Nokia Solutions and Networks, OY. FCC ID: 2AD8UAZQCRH1) and spectrum analyzer. The following procedure is performed by applying WINNF-TS-0122 CBRS CBSD Test Specification.

Step 1:

- a. Setup WINNF.PT.C.HBT.1 with 3570 ~ 3590MHz and power level at 24 dBm/MHz.
- b. Enable Micro RRU from EPC Manage Tool.
- c. Check EUT Tx frequency and power.
- d. Disable Micro RRU from EPC Manage Tool and check EUT stop transmission within 10s.

Step 2:

- a. Setup WINNF.PT.C.HBT.1 with 3670 ~ 3690MHz and power level at 17 dBm/MHz.
- b. Enable Micro RRU from EPC Manage Tool.
- c. Check EUT Tx frequency and power.
- d. Disable Micro RRU from EPC Manage Tool and check EUT stop transmission within 10s.

5.8.4. Test Result

Refer to Appendix A.7.

Appendix A - Test Result

A.1 Occupied Bandwidth Test Result

Test Site	SIP-SR1	Test Engineer	Candy Luo
Test Date	2022-09-26	Test Band	n48_SA

Modulation	Frequency (MHz)	Bandwidth (MHz)	99% Bandwidth (MHz)
QPSK	3624.99	10	8.58
		20	17.81
		30	26.65
		40	35.71
16QAM	3624.99	10	8.62
		20	17.78
		30	26.73
		40	35.71
64QAM	3624.99	10	8.61
		20	17.78
		30	26.60
		40	35.75
256QAM	3624.99	10	8.58
		20	17.74
		30	26.77
		40	35.72

99% Bandwidth - QPSK

10MHz Channel Bandwidth

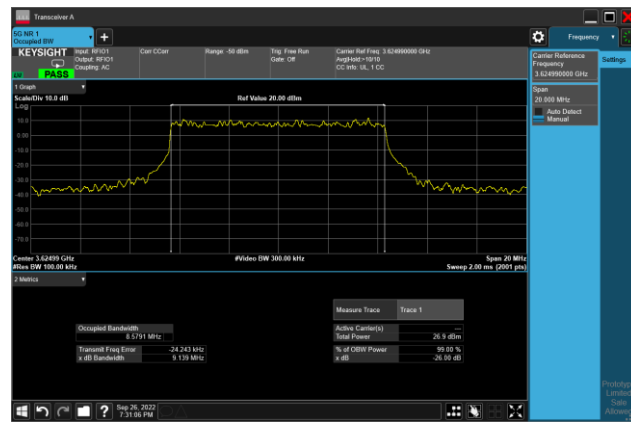

20MHz Channel Bandwidth

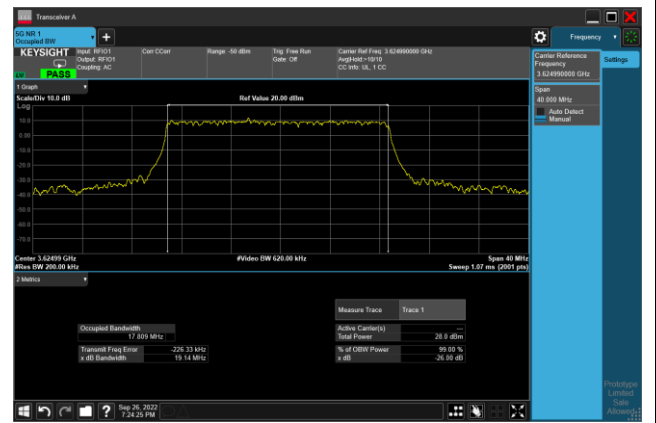

30MHz Channel Bandwidth

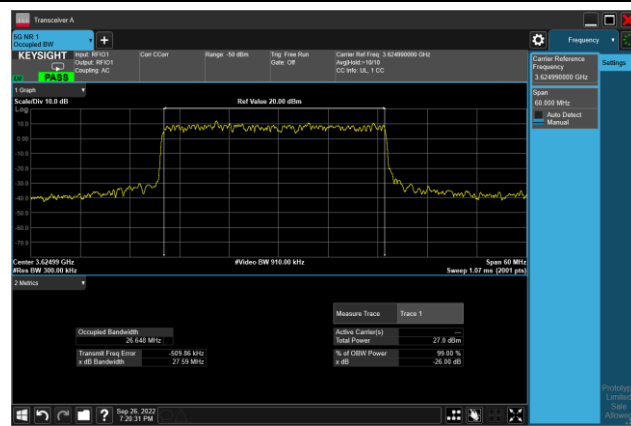

40MHz Channel Bandwidth



99% Bandwidth - 16QAM

10MHz Channel Bandwidth

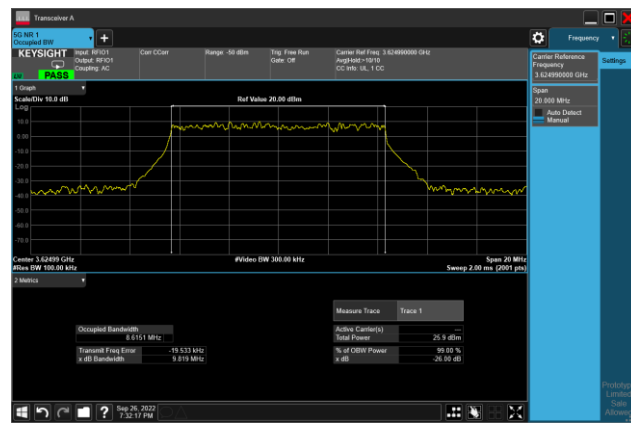

20MHz Channel Bandwidth

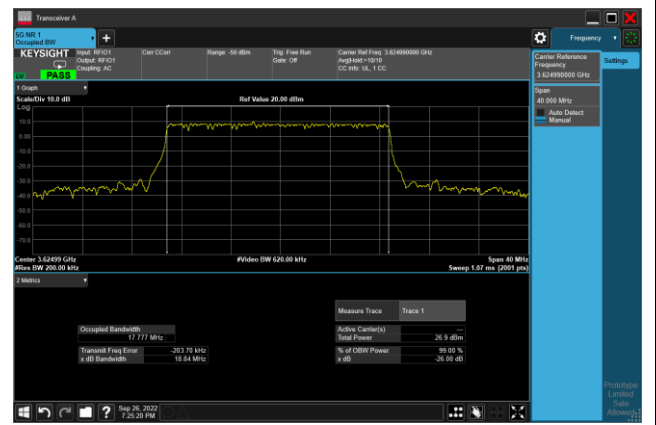

30MHz Channel Bandwidth

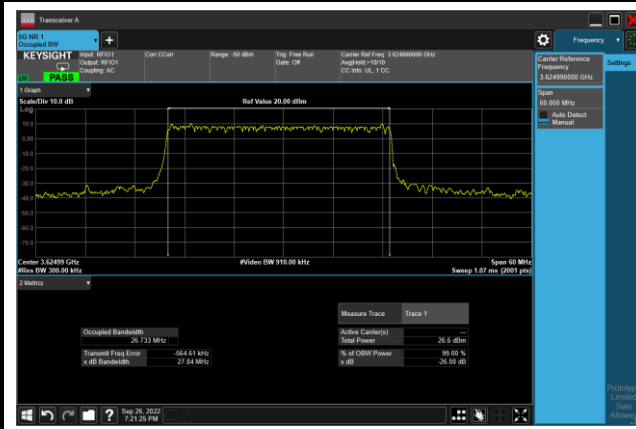

40MHz Channel Bandwidth

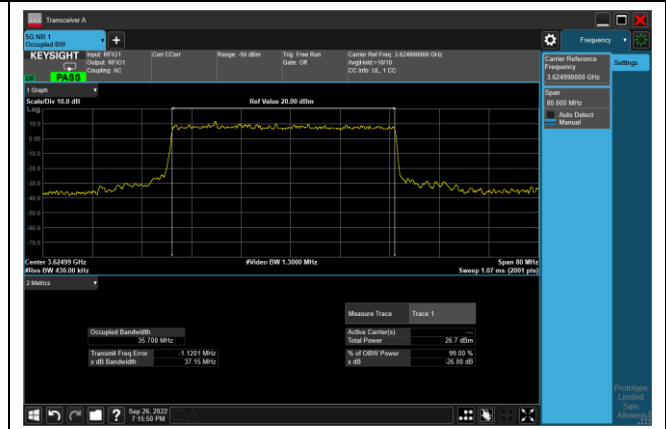

99% Bandwidth - 64QAM

10MHz Channel Bandwidth

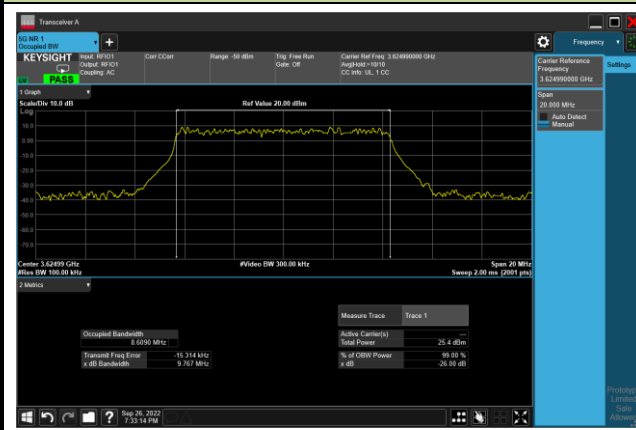

20MHz Channel Bandwidth

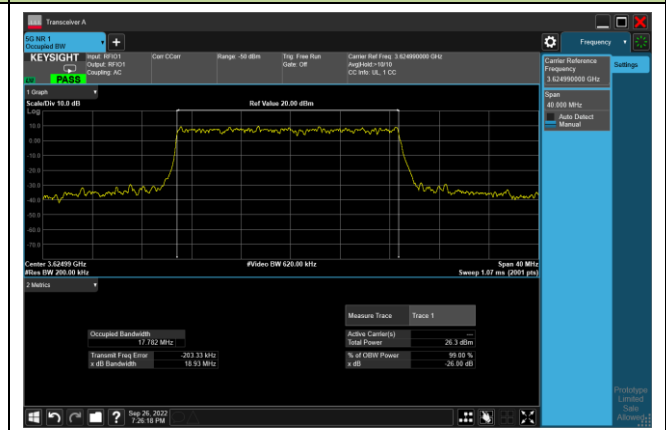

30MHz Channel Bandwidth



40MHz Channel Bandwidth

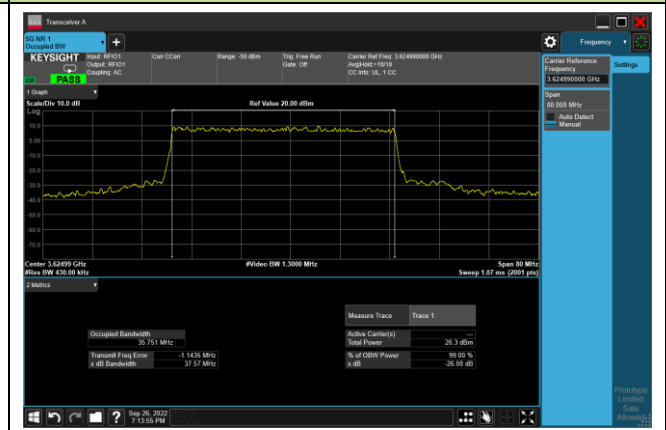

99% Bandwidth - 256QAM

10MHz Channel Bandwidth

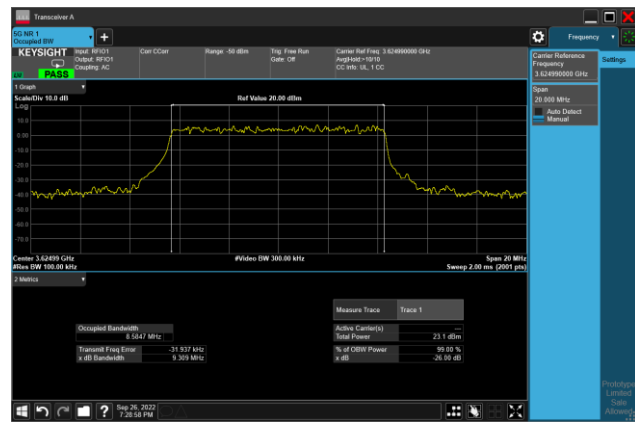

20MHz Channel Bandwidth



30MHz Channel Bandwidth



40MHz Channel Bandwidth



Test Site	SIP-SR1	Test Engineer	Candy Luo
Test Date	2022-09-26	Test Band	n48_UL MIMO (Port 0)

Modulation	Frequency (MHz)	Bandwidth (MHz)	99% Bandwidth (MHz)
QPSK	3624.99	10	8.61
		20	18.17
		30	27.69
		40	37.81
16QAM	3624.99	10	8.57
		20	18.25
		30	27.87
		40	37.81
64QAM	3624.99	10	8.55
		20	18.13
		30	27.87
		40	37.78
256QAM	3624.99	10	8.58
		20	18.18
		30	27.67
		40	37.77

99% Bandwidth - QPSK

10MHz Channel Bandwidth

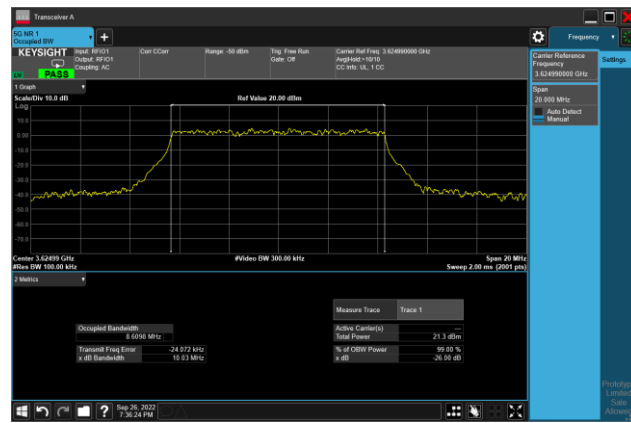

20MHz Channel Bandwidth

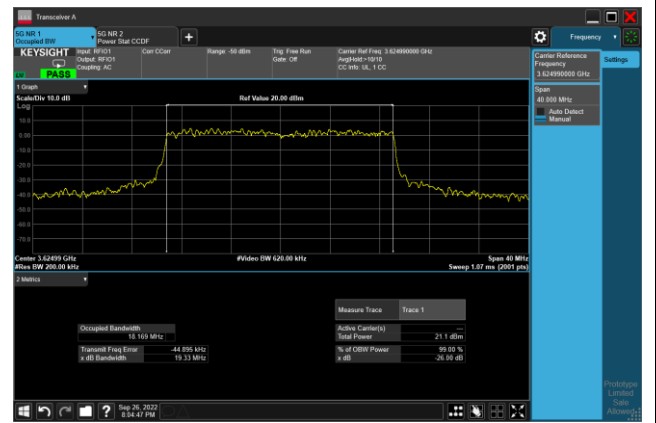

30MHz Channel Bandwidth

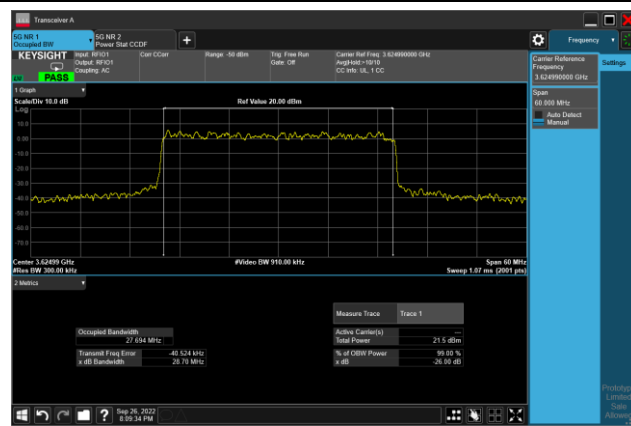

40MHz Channel Bandwidth



99% Bandwidth - 16QAM

10MHz Channel Bandwidth



20MHz Channel Bandwidth

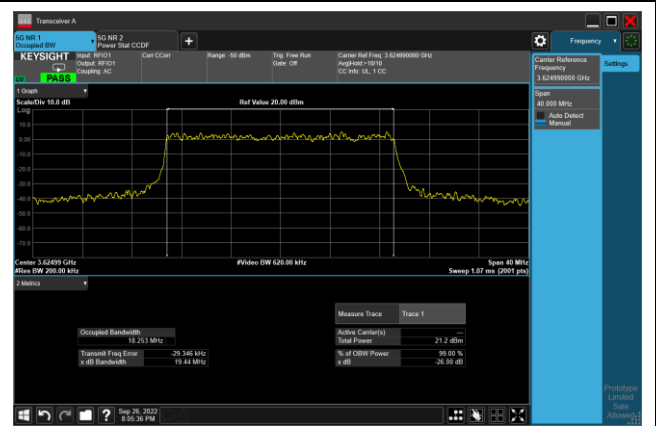



99% Bandwidth - 64QAM

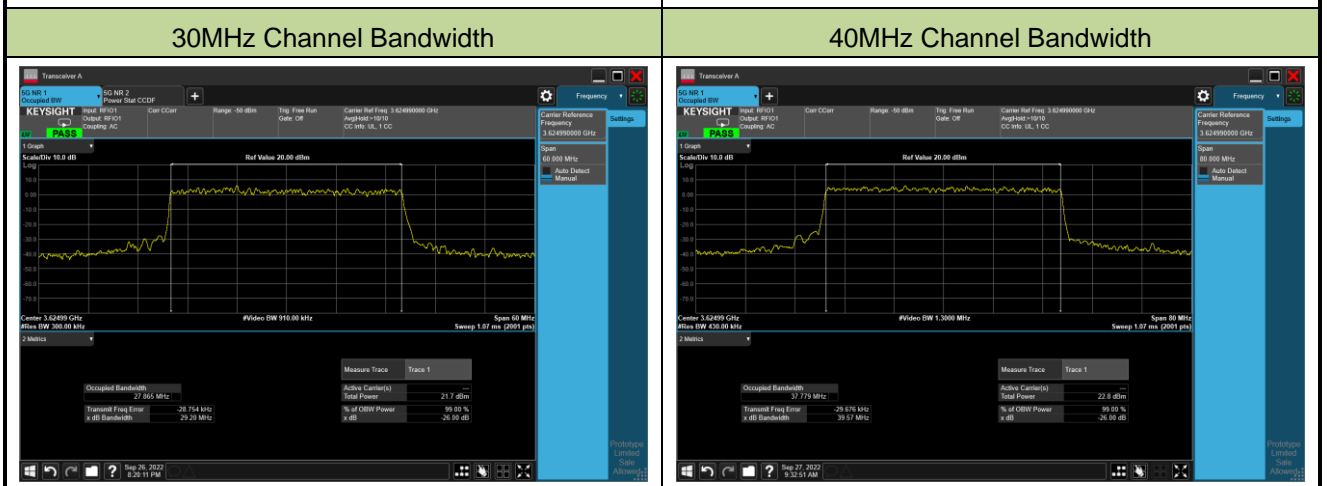
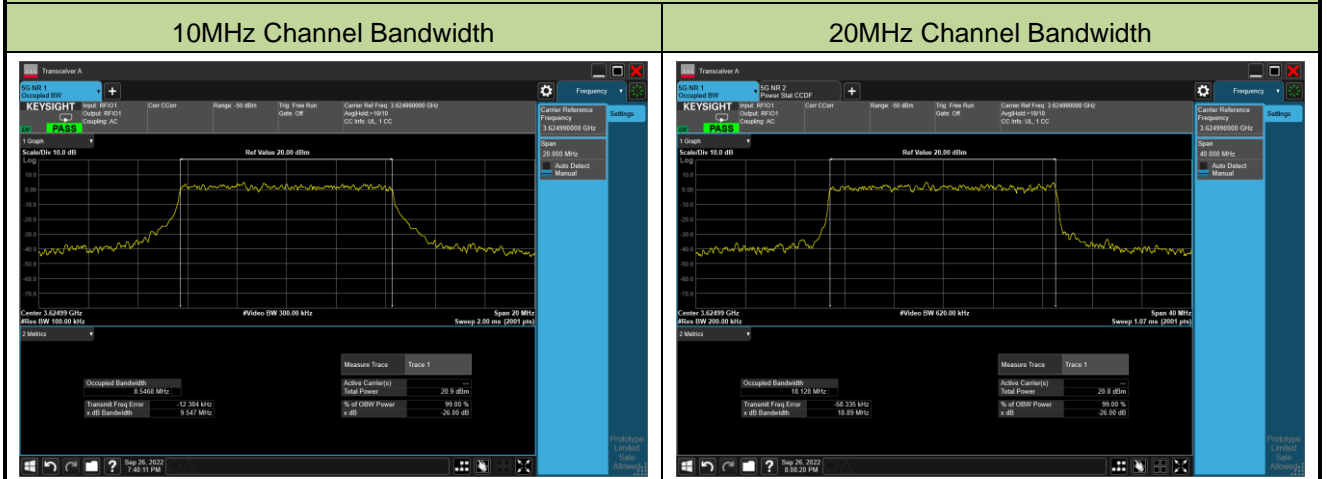

99% Bandwidth - 256QAM

10MHz Channel Bandwidth

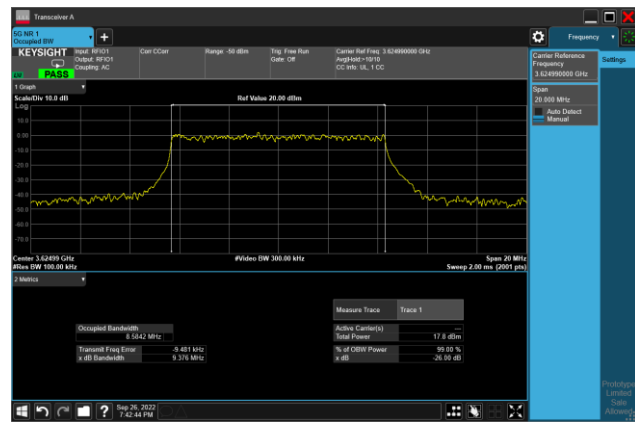

20MHz Channel Bandwidth

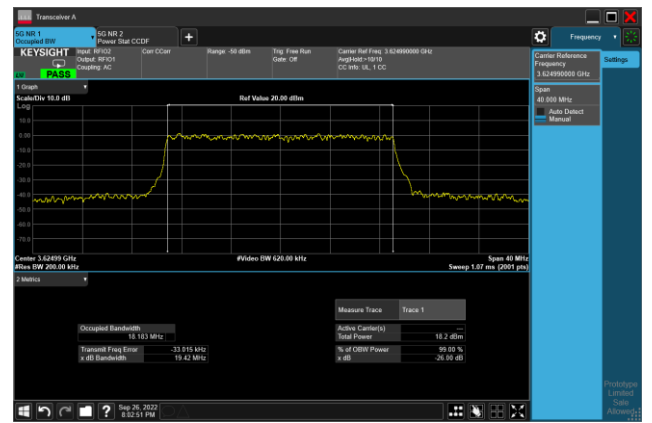

30MHz Channel Bandwidth



40MHz Channel Bandwidth

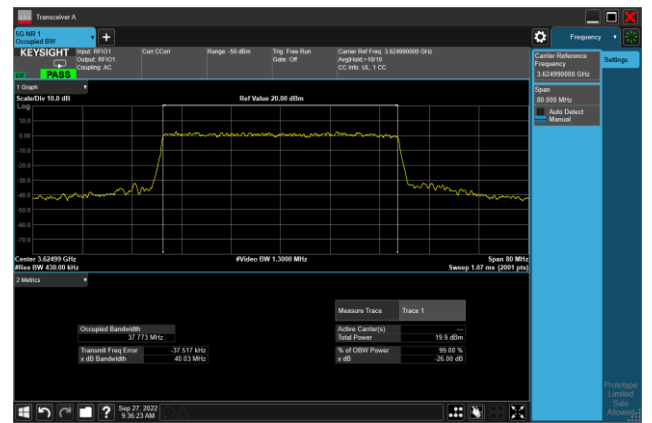

Test Site	SIP-SR1	Test Engineer	Candy Luo
Test Date	2022-09-26	Test Band	n48_UL MIMO (Port 3)

Modulation	Frequency (MHz)	Bandwidth (MHz)	99% Bandwidth (MHz)
QPSK	3624.99	10	8.63
		20	18.20
		30	27.70
		40	37.76
16QAM	3624.99	10	8.60
		20	18.23
		30	27.90
		40	37.79
64QAM	3624.99	10	8.56
		20	18.21
		30	27.84
		40	37.69
256QAM	3624.99	10	8.58
		20	13.13
		30	27.82
		40	37.85

99% Bandwidth - QPSK

10MHz Channel Bandwidth

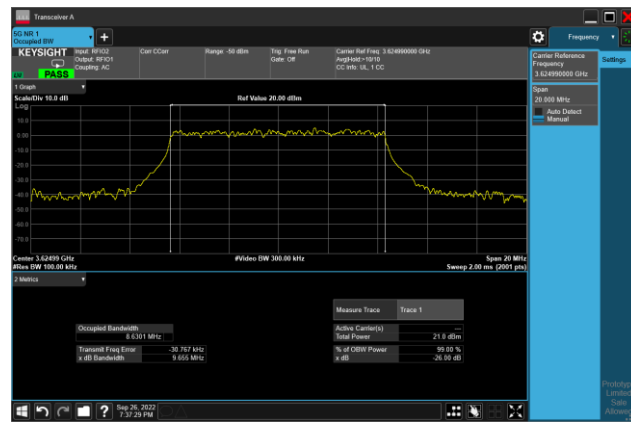

20MHz Channel Bandwidth

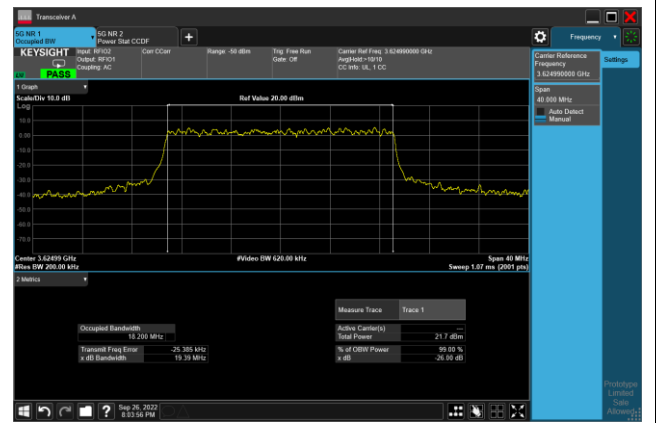

30MHz Channel Bandwidth

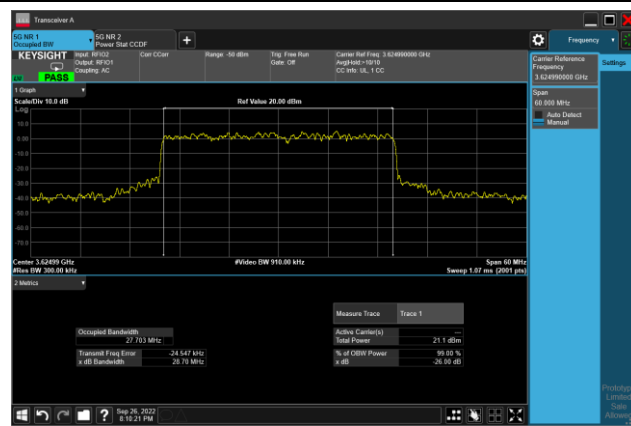

40MHz Channel Bandwidth

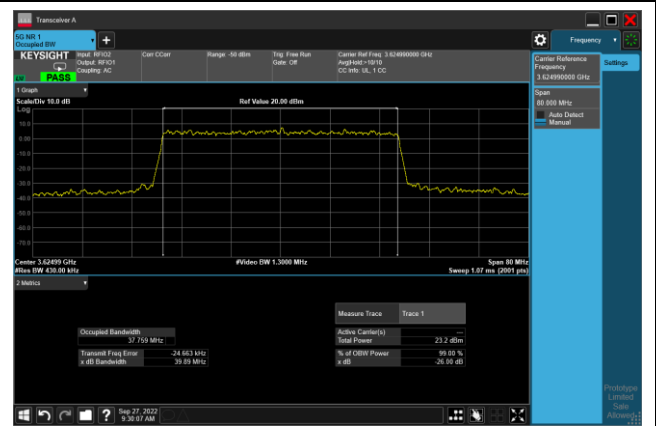

99% Bandwidth - 16QAM

10MHz Channel Bandwidth

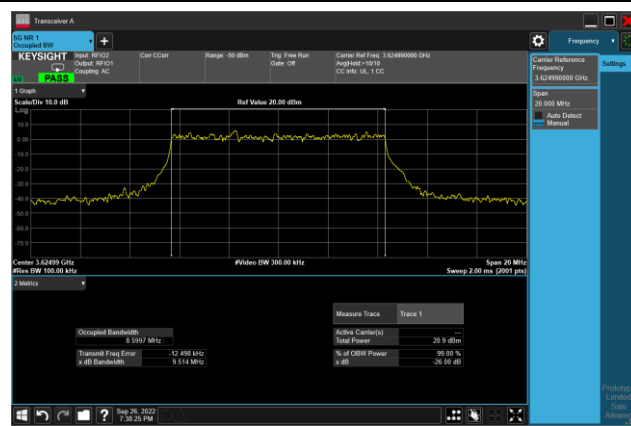

20MHz Channel Bandwidth

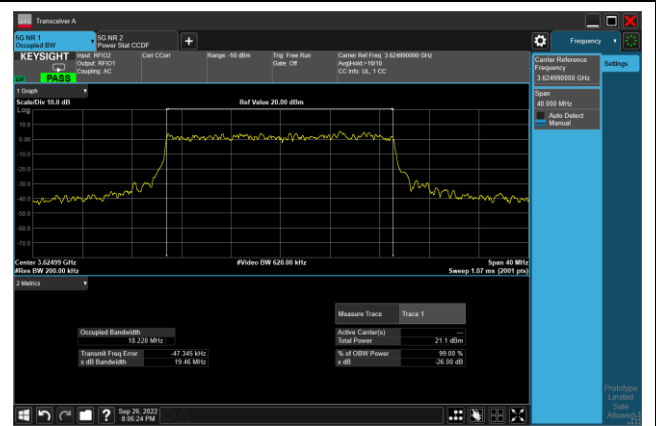



99% Bandwidth - 64QAM

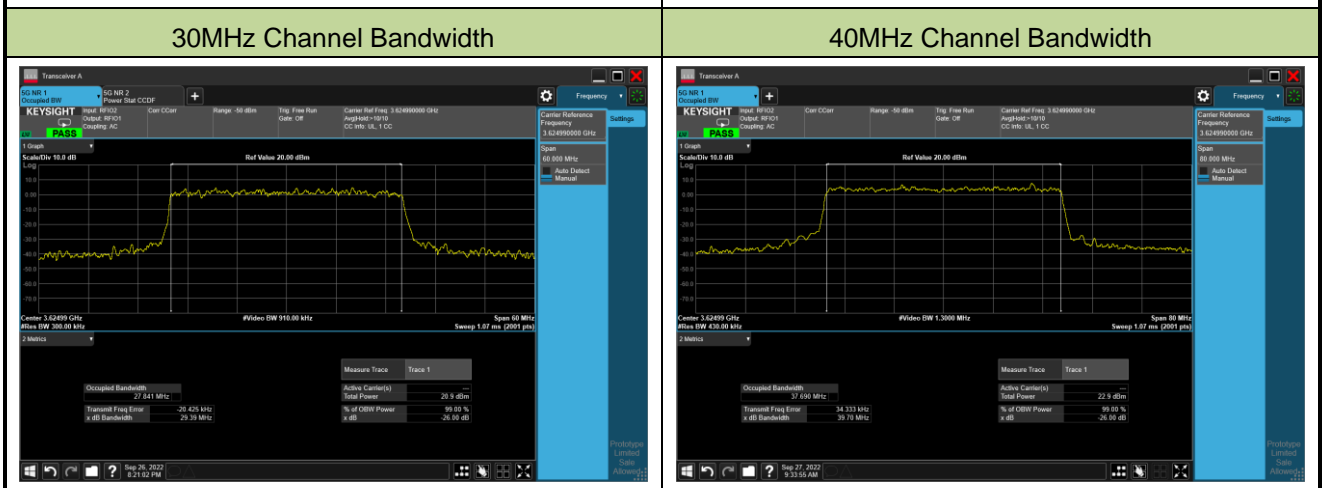
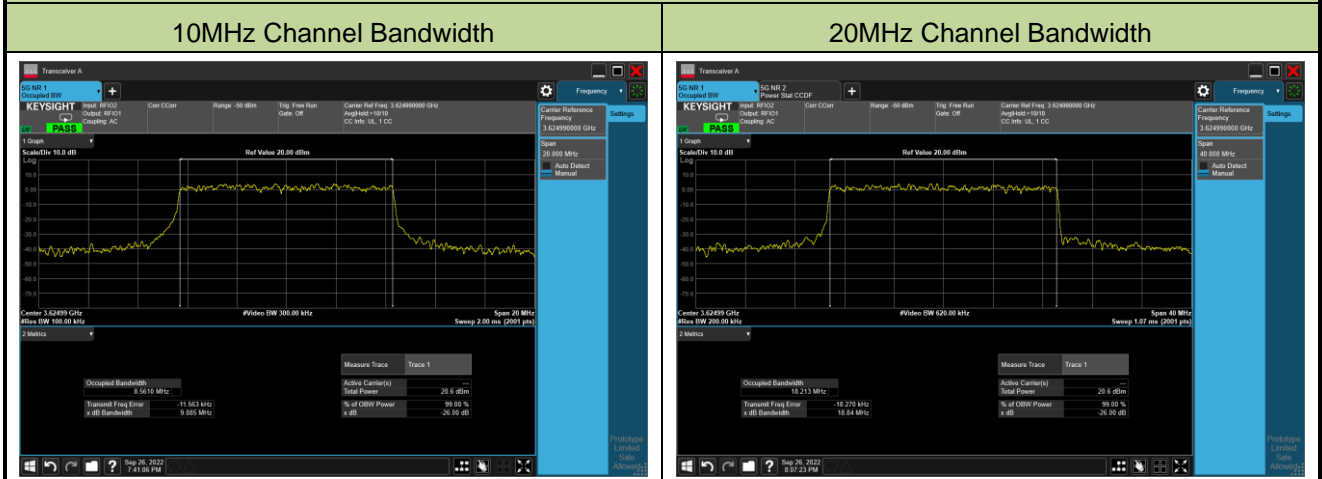

99% Bandwidth - 256QAM

10MHz Channel Bandwidth



20MHz Channel Bandwidth

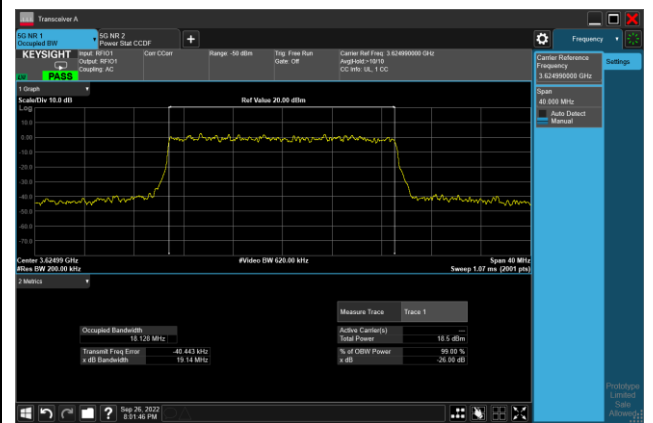

30MHz Channel Bandwidth

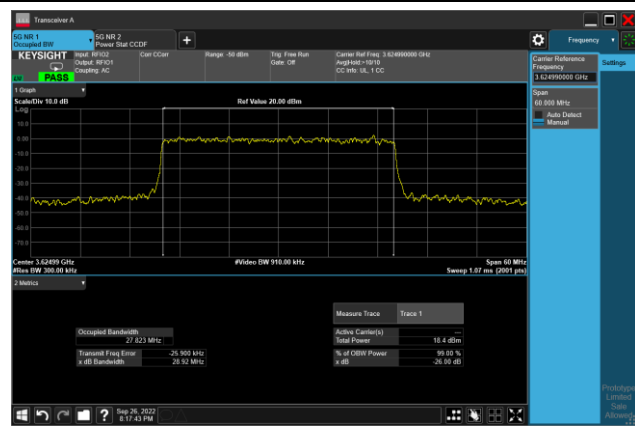

40MHz Channel Bandwidth

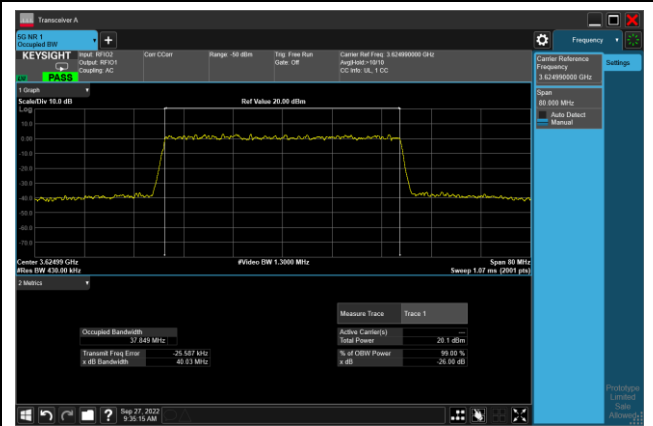

A.2 Frequency Stability Test Result

Test Site	SIP-SR1	Test Engineer	Candy Luo
Test Date	2022-09-30	Test Band	n48_SA

Power (Vdc)	Temp. (°C)	Frequency Tolerance (ppm)
3.8	- 30	0.0005
	- 20	-0.0006
	- 10	0.0012
	0	-0.0005
	+ 10	-0.0010
	+ 20 (Ref)	0.0000
	+ 30	-0.0004
	+ 40	0.0000
	+ 50	0.0002
4.3	+ 20	-0.0006
3.3	+ 20	-0.0023

A.3 Equivalent Isotropically Radiated Power Test Result

Test Site	SIP-SR1	Test Engineer	Candy Luo
Test Date	2022-10-10 ~ 2022-10-11	Test Band	n48_SA

Frequency (MHz)	Channel Bandwidth (MHz)	RB Size	RB Offset	Output Power (dBm/10MHz)	EIRP (dBm/10MHz)	Limit (dBm/10MHz)
DFT-s OFDM PI/2 BPSK						
3555	10	12	6	21.13	21.71	<23.00
		1	1	21.56	22.14	<23.00
		1	22	21.63	22.21	<23.00
		24	0	20.73	21.31	<23.00
		1	23	21.09	21.67	<23.00
		1	0	21.13	21.71	<23.00
3624.99	10	12	6	21.14	21.72	<23.00
		1	1	21.59	22.17	<23.00
		1	22	21.55	22.13	<23.00
		24	0	20.74	21.32	<23.00
		1	23	21.01	21.59	<23.00
		1	0	21.05	21.63	<23.00
3694.98	10	12	6	21.18	21.76	<23.00
		1	1	21.55	22.13	<23.00
		1	22	21.57	22.15	<23.00
		24	0	20.76	21.34	<23.00
		1	23	21.02	21.60	<23.00
		1	0	21.09	21.67	<23.00
3560.01	20	25	12	21.45	22.03	<23.00
		1	1	20.95	21.53	<23.00
		1	49	21.00	21.58	<23.00
		50	0	18.20	18.78	<23.00
		1	50	20.50	21.08	<23.00
		1	0	20.41	20.99	<23.00

Note: The EIRP (dBm/10MHz) = Output Power (dBm/10MHz) + Antenna Gain (dBi)

Frequency (MHz)	Channel Bandwidth (MHz)	RB Size	RB Offset	Output Power (dBm/10MHz)	EIRP (dBm/10MHz)	Limit (dBm/10MHz)
DFT-s OFDM PI/2 BPSK						
3624.99	20	25	12	21.39	21.97	<23.00
		1	1	20.94	21.52	<23.00
		1	49	20.86	21.44	<23.00
		50	0	18.17	18.75	<23.00
		1	50	20.37	20.95	<23.00
		1	0	20.44	21.02	<23.00
3690	20	25	12	21.38	21.96	<23.00
		1	1	20.85	21.43	<23.00
		1	49	20.90	21.48	<23.00
		50	0	18.15	18.73	<23.00
		1	50	20.43	21.01	<23.00
		1	0	19.65	20.23	<23.00
3565.02	30	36	18	20.52	21.10	<23.00
		1	1	21.75	22.33	<23.00
		1	76	21.75	22.33	<23.00
		75	0	16.59	17.17	<23.00
		1	77	21.24	21.82	<23.00
		1	0	21.25	21.83	<23.00
3624.99	30	36	18	20.49	21.07	<23.00
		1	1	22.28	22.86	<23.00
		1	76	21.65	22.23	<23.00
		75	0	16.55	17.13	<23.00
		1	77	21.14	21.72	<23.00
		1	0	21.29	21.87	<23.00
3684.99	30	36	18	20.46	21.04	<23.00
		1	1	22.14	22.72	<23.00
		1	76	22.12	22.70	<23.00
		75	0	16.50	17.08	<23.00
		1	77	21.11	21.69	<23.00
		1	0	21.65	22.23	<23.00
Note: The EIRP (dBm/10MHz) = Output Power (dBm/10MHz) + Antenna Gain (dBi)						

Frequency (MHz)	Channel Bandwidth (MHz)	RB Size	RB Offset	Output Power (dBm/10MHz)	EIRP (dBm/10MHz)	Limit (dBm/10MHz)
DFT-s OFDM PI/2 BPSK						
3570	40	50	25	19.05	19.63	<23.00
		1	1	22.14	22.72	<23.00
		1	104	21.83	22.41	<23.00
		100	0	15.96	16.54	<23.00
		1	105	21.84	22.42	<23.00
		1	0	21.23	21.81	<23.00
3624.99	40	50	25	18.92	19.50	<23.00
		1	1	22.30	22.88	<23.00
		1	104	21.73	22.31	<23.00
		100	0	15.97	16.55	<23.00
		1	105	21.23	21.81	<23.00
		1	0	21.78	22.36	<23.00
3679.98	40	50	25	18.96	19.54	<23.00
		1	1	22.14	22.72	<23.00
		1	104	21.66	22.24	<23.00
		100	0	16.04	16.62	<23.00
		1	105	21.19	21.77	<23.00
		1	0	21.68	22.26	<23.00
Note: The EIRP (dBm/10MHz) = Output Power (dBm/10MHz) + Antenna Gain (dBi)						

Frequency (MHz)	Channel Bandwidth (MHz)	RB Size	RB Offset	Output Power (dBm/10MHz)	EIRP (dBm/10MHz)	Limit (dBm/10MHz)
DFT-s OFDM QPSK						
3555	10	12	6	21.22	21.80	<23.00
		1	1	21.45	22.03	<23.00
		1	22	21.48	22.06	<23.00
		24	0	20.31	20.89	<23.00
		1	23	20.41	20.99	<23.00
		1	0	20.60	21.18	<23.00
3624.99	10	12	6	21.07	21.65	<23.00
		1	1	21.47	22.05	<23.00
		1	22	21.65	22.23	<23.00
		24	0	20.24	20.82	<23.00
		1	23	19.76	20.34	<23.00
		1	0	19.80	20.38	<23.00
3694.98	10	12	6	21.17	21.75	<23.00
		1	1	21.47	22.05	<23.00
		1	22	21.52	22.10	<23.00
		24	0	20.27	20.85	<23.00
		1	23	20.41	20.99	<23.00
		1	0	20.64	21.22	<23.00
3560.01	20	25	12	21.40	21.98	<23.00
		1	1	19.43	20.01	<23.00
		1	49	19.47	20.05	<23.00
		50	0	17.53	18.11	<23.00
		1	50	21.80	22.38	<23.00
		1	0	21.73	22.31	<23.00
Note: The EIRP (dBm/10MHz) = Output Power (dBm/10MHz) + Antenna Gain (dBi)						

Frequency (MHz)	Channel Bandwidth (MHz)	RB Size	RB Offset	Output Power (dBm/10MHz)	EIRP (dBm/10MHz)	Limit (dBm/10MHz)
DFT-s OFDM QPSK						
3624.99	20	25	12	21.38	21.96	<23.00
		1	1	19.43	20.01	<23.00
		1	49	19.49	20.07	<23.00
		50	0	17.79	18.37	<23.00
		1	50	21.61	22.19	<23.00
		1	0	21.71	22.29	<23.00
3690	20	25	12	21.35	21.93	<23.00
		1	1	18.91	19.49	<23.00
		1	49	18.98	19.56	<23.00
		50	0	17.67	18.25	<23.00
		1	50	17.31	17.89	<23.00
		1	0	18.83	19.41	<23.00
3565.02	30	36	18	20.54	21.12	<23.00
		1	1	22.36	22.94	<23.00
		1	76	22.38	22.96	<23.00
		75	0	16.08	16.66	<23.00
		1	77	20.57	21.15	<23.00
		1	0	20.39	20.97	<23.00
3624.99	30	36	18	20.35	20.93	<23.00
		1	1	21.52	22.10	<23.00
		1	76	22.25	22.83	<23.00
		75	0	16.05	16.63	<23.00
		1	77	20.50	21.08	<23.00
		1	0	20.63	21.21	<23.00
3684.99	30	36	18	20.21	20.79	<23.00
		1	1	21.14	21.72	<23.00
		1	76	21.26	21.84	<23.00
		75	0	16.02	16.60	<23.00
		1	77	20.35	20.93	<23.00
		1	0	19.88	20.46	<23.00
Note: The EIRP (dBm/10MHz) = Output Power (dBm/10MHz) + Antenna Gain (dBi)						

Frequency (MHz)	Channel Bandwidth (MHz)	RB Size	RB Offset	Output Power (dBm/10MHz)	EIRP (dBm/10MHz)	Limit (dBm/10MHz)
DFT-s OFDM QPSK						
3570	40	50	25	18.80	19.38	<23.00
		1	1	20.40	20.98	<23.00
		1	104	21.55	22.13	<23.00
		100	0	14.60	15.18	<23.00
		1	105	18.50	19.08	<23.00
		1	0	19.94	20.52	<23.00
3624.99	40	50	25	18.76	19.34	<23.00
		1	1	20.41	20.99	<23.00
		1	104	21.50	22.08	<23.00
		100	0	14.54	15.12	<23.00
		1	105	19.88	20.46	<23.00
		1	0	18.53	19.11	<23.00
3679.98	40	50	25	18.71	19.29	<23.00
		1	1	20.35	20.93	<23.00
		1	104	21.33	21.91	<23.00
		100	0	14.63	15.21	<23.00
		1	105	19.77	20.35	<23.00
		1	0	18.40	18.98	<23.00
Note: The EIRP (dBm/10MHz) = Output Power (dBm/10MHz) + Antenna Gain (dBi)						

Frequency (MHz)	Channel Bandwidth (MHz)	RB Size	RB Offset	Output Power (dBm/10MHz)	EIRP (dBm/10MHz)	Limit (dBm/10MHz)
DFT-s OFDM 16QAM						
3555	10	12	6	19.89	20.47	<23.00
		1	1	21.81	22.39	<23.00
		1	22	20.39	20.97	<23.00
		24	0	18.98	19.56	<23.00
		1	23	19.02	19.60	<23.00
		1	0	21.05	21.63	<23.00
3624.99	10	12	6	20.46	21.04	<23.00
		1	1	21.85	22.43	<23.00
		1	22	21.80	22.38	<23.00
		24	0	18.95	19.53	<23.00
		1	23	20.45	21.03	<23.00
		1	0	20.50	21.08	<23.00
3694.98	10	12	6	19.93	20.51	<23.00
		1	1	20.30	20.88	<23.00
		1	22	21.71	22.29	<23.00
		24	0	18.97	19.55	<23.00
		1	23	21.31	21.89	<23.00
		1	0	21.01	21.59	<23.00
3560.01	20	25	12	21.00	21.58	<23.00
		1	1	18.41	18.99	<23.00
		1	49	18.43	19.01	<23.00
		50	0	17.01	17.59	<23.00
		1	50	18.54	19.12	<23.00
		1	0	18.46	19.04	<23.00
Note: The EIRP (dBm/10MHz) = Output Power (dBm/10MHz) + Antenna Gain (dBi)						

Frequency (MHz)	Channel Bandwidth (MHz)	RB Size	RB Offset	Output Power (dBm/10MHz)	EIRP (dBm/10MHz)	Limit (dBm/10MHz)
DFT-s OFDM 16QAM						
3624.99	20	25	12	20.90	21.48	<23.00
		1	1	18.50	19.08	<23.00
		1	49	18.30	18.88	<23.00
		50	0	16.71	17.29	<23.00
		1	50	18.60	19.18	<23.00
		1	0	18.53	19.11	<23.00
3690	20	25	12	20.93	21.51	<23.00
		1	1	18.85	19.43	<23.00
		1	49	20.58	21.16	<23.00
		50	0	16.84	17.42	<23.00
		1	50	18.48	19.06	<23.00
		1	0	19.40	19.98	<23.00
3565.02	30	36	18	19.72	20.30	<23.00
		1	1	21.92	22.50	<23.00
		1	76	20.83	21.41	<23.00
		75	0	15.68	16.26	<23.00
		1	77	21.93	22.51	<23.00
		1	0	22.15	22.73	<23.00
3624.99	30	36	18	19.58	20.16	<23.00
		1	1	21.93	22.51	<23.00
		1	76	20.82	21.40	<23.00
		75	0	15.54	16.12	<23.00
		1	77	21.69	22.27	<23.00
		1	0	21.85	22.43	<23.00
3684.99	30	36	18	19.37	19.95	<23.00
		1	1	21.64	22.22	<23.00
		1	76	21.59	22.17	<23.00
		75	0	15.50	16.08	<23.00
		1	77	21.61	22.19	<23.00
		1	0	22.04	22.62	<23.00
Note: The EIRP (dBm/10MHz) = Output Power (dBm/10MHz) + Antenna Gain (dBi)						

Frequency (MHz)	Channel Bandwidth (MHz)	RB Size	RB Offset	Output Power (dBm/10MHz)	EIRP (dBm/10MHz)	Limit (dBm/10MHz)
DFT-s OFDM 16QAM						
3570	40	50	25	17.65	18.23	<23.00
		1	1	21.15	21.73	<23.00
		1	104	20.76	21.34	<23.00
		100	0	14.27	14.85	<23.00
		1	105	19.84	20.42	<23.00
		1	0	19.80	20.38	<23.00
3624.99	40	50	25	17.56	18.14	<23.00
		1	1	21.21	21.79	<23.00
		1	104	20.63	21.21	<23.00
		100	0	14.17	14.75	<23.00
		1	105	19.90	20.48	<23.00
		1	0	20.06	20.64	<23.00
3679.98	40	50	25	18.18	18.76	<23.00
		1	1	21.09	21.67	<23.00
		1	104	20.67	21.25	<23.00
		100	0	14.23	14.81	<23.00
		1	105	19.96	20.54	<23.00
		1	0	19.63	20.21	<23.00

Note: The EIRP (dBm/10MHz) = Output Power (dBm/10MHz) + Antenna Gain (dBi)

Frequency (MHz)	Channel Bandwidth (MHz)	RB Size	RB Offset	Output Power (dBm/10MHz)	EIRP (dBm/10MHz)	Limit (dBm/10MHz)
DFT-s OFDM 64QAM						
3555	10	12	6	18.75	19.33	<23.00
		1	1	18.61	19.19	<23.00
		1	22	17.60	18.18	<23.00
		24	0	18.95	19.53	<23.00
		1	23	18.59	19.17	<23.00
		1	0	18.60	19.18	<23.00
3624.99	10	12	6	18.70	19.28	<23.00
		1	1	18.62	19.20	<23.00
		1	22	18.61	19.19	<23.00
		24	0	19.03	19.61	<23.00
		1	23	18.58	19.16	<23.00
		1	0	18.66	19.24	<23.00
3694.98	10	12	6	18.80	19.38	<23.00
		1	1	17.61	18.19	<23.00
		1	22	18.62	19.20	<23.00
		24	0	18.89	19.47	<23.00
		1	23	17.61	18.19	<23.00
		1	0	18.61	19.19	<23.00
3560.01	20	25	12	18.73	19.31	<23.00
		1	1	14.32	14.90	<23.00
		1	49	14.47	15.05	<23.00
		50	0	16.43	17.01	<23.00
		1	50	14.50	15.08	<23.00
		1	0	14.34	14.92	<23.00
Note: The EIRP (dBm/10MHz) = Output Power (dBm/10MHz) + Antenna Gain (dBi)						

Frequency (MHz)	Channel Bandwidth (MHz)	RB Size	RB Offset	Output Power (dBm/10MHz)	EIRP (dBm/10MHz)	Limit (dBm/10MHz)
DFT-s OFDM 64QAM						
3624.99	20	25	12	18.67	19.25	<23.00
		1	1	14.38	14.96	<23.00
		1	49	14.47	15.05	<23.00
		50	0	16.62	17.20	<23.00
		1	50	14.34	14.92	<23.00
		1	0	14.35	14.93	<23.00
3690	20	25	12	19.06	19.64	<23.00
		1	1	15.71	16.29	<23.00
		1	49	16.26	16.84	<23.00
		50	0	16.53	17.11	<23.00
		1	50	16.29	16.87	<23.00
		1	0	15.73	16.31	<23.00
3565.02	30	36	18	18.23	18.81	<23.00
		1	1	19.58	20.16	<23.00
		1	76	19.90	20.48	<23.00
		75	0	13.79	14.37	<23.00
		1	77	19.84	20.42	<23.00
		1	0	19.55	20.13	<23.00
3624.99	30	36	18	18.14	18.72	<23.00
		1	1	19.48	20.06	<23.00
		1	76	19.70	20.28	<23.00
		75	0	13.75	14.33	<23.00
		1	77	19.74	20.32	<23.00
		1	0	20.59	21.17	<23.00
3684.99	30	36	18	17.98	18.56	<23.00
		1	1	19.70	20.28	<23.00
		1	76	19.36	19.94	<23.00
		75	0	13.71	14.29	<23.00
		1	77	19.82	20.40	<23.00
		1	0	19.50	20.08	<23.00
Note: The EIRP (dBm/10MHz) = Output Power (dBm/10MHz) + Antenna Gain (dBi)						

Frequency (MHz)	Channel Bandwidth (MHz)	RB Size	RB Offset	Output Power (dBm/10MHz)	EIRP (dBm/10MHz)	Limit (dBm/10MHz)
DFT-s OFDM 64QAM						
3570	40	50	25	16.81	17.39	<23.00
		1	1	19.86	20.44	<23.00
		1	104	20.36	20.94	<23.00
		100	0	13.72	14.30	<23.00
		1	105	20.04	20.62	<23.00
		1	0	20.28	20.86	<23.00
3624.99	40	50	25	16.75	17.33	<23.00
		1	1	19.96	20.54	<23.00
		1	104	20.30	20.88	<23.00
		100	0	13.64	14.22	<23.00
		1	105	20.34	20.92	<23.00
		1	0	19.95	20.53	<23.00
3679.98	40	50	25	16.74	17.32	<23.00
		1	1	19.88	20.46	<23.00
		1	104	20.25	20.83	<23.00
		100	0	13.66	14.24	<23.00
		1	105	20.28	20.86	<23.00
		1	0	19.86	20.44	<23.00

Note: The EIRP (dBm/10MHz) = Output Power (dBm/10MHz) + Antenna Gain (dBi)

Frequency (MHz)	Channel Bandwidth (MHz)	RB Size	RB Offset	Output Power (dBm/10MHz)	EIRP (dBm/10MHz)	Limit (dBm/10MHz)
DFT-s OFDM 256QAM						
3555	10	12	6	16.35	16.93	<23.00
		1	1	16.40	16.98	<23.00
		1	22	16.47	17.05	<23.00
		24	0	17.11	17.69	<23.00
		1	23	17.76	18.34	<23.00
		1	0	16.43	17.01	<23.00
3624.99	10	12	6	16.58	17.16	<23.00
		1	1	17.21	17.79	<23.00
		1	22	17.05	17.63	<23.00
		24	0	16.97	17.55	<23.00
		1	23	17.15	17.73	<23.00
		1	0	17.21	17.79	<23.00
3694.98	10	12	6	16.35	16.93	<23.00
		1	1	17.73	18.31	<23.00
		1	22	17.77	18.35	<23.00
		24	0	17.08	17.66	<23.00
		1	23	16.42	17.00	<23.00
		1	0	16.44	17.02	<23.00
3560.01	20	25	12	17.01	17.59	<23.00
		1	1	19.56	20.14	<23.00
		1	49	19.70	20.28	<23.00
		50	0	14.10	14.68	<23.00
		1	50	19.60	20.18	<23.00
		1	0	19.53	20.11	<23.00
Note: The EIRP (dBm/10MHz) = Output Power (dBm/10MHz) + Antenna Gain (dBi)						

Frequency (MHz)	Channel Bandwidth (MHz)	RB Size	RB Offset	Output Power (dBm/10MHz)	EIRP (dBm/10MHz)	Limit (dBm/10MHz)
DFT-s OFDM 256QAM						
3624.99	20	25	12	16.79	17.37	<23.00
		1	1	19.56	20.14	<23.00
		1	49	19.43	20.01	<23.00
		50	0	14.36	14.94	<23.00
		1	50	19.46	20.04	<23.00
		1	0	19.52	20.10	<23.00
3690	20	25	12	16.92	17.50	<23.00
		1	1	19.12	19.70	<23.00
		1	49	18.56	19.14	<23.00
		50	0	14.27	14.85	<23.00
		1	50	18.51	19.09	<23.00
		1	0	18.47	19.05	<23.00
3565.02	30	36	18	16.48	17.06	<23.00
		1	1	17.74	18.32	<23.00
		1	76	17.05	17.63	<23.00
		75	0	13.06	13.64	<23.00
		1	77	16.89	17.47	<23.00
		1	0	16.92	17.50	<23.00
3624.99	30	36	18	16.25	16.83	<23.00
		1	1	17.80	18.38	<23.00
		1	76	16.90	17.48	<23.00
		75	0	13.01	13.59	<23.00
		1	77	16.87	17.45	<23.00
		1	0	17.02	17.60	<23.00
3684.99	30	36	18	16.43	17.01	<23.00
		1	1	18.21	18.79	<23.00
		1	76	18.20	18.78	<23.00
		75	0	12.95	13.53	<23.00
		1	77	18.46	19.04	<23.00
		1	0	18.27	18.85	<23.00
Note: The EIRP (dBm/10MHz) = Output Power (dBm/10MHz) + Antenna Gain (dBi)						

Frequency (MHz)	Channel Bandwidth (MHz)	RB Size	RB Offset	Output Power (dBm/10MHz)	EIRP (dBm/10MHz)	Limit (dBm/10MHz)
DFT-s OFDM 256QAM						
3570	40	50	25	14.15	14.73	<23.00
		1	1	19.69	20.27	<23.00
		1	104	19.67	20.25	<23.00
		100	0	11.15	11.73	<23.00
		1	105	19.83	20.41	<23.00
		1	0	19.57	20.15	<23.00
3624.99	40	50	25	14.06	14.64	<23.00
		1	1	19.79	20.37	<23.00
		1	104	19.70	20.28	<23.00
		100	0	11.06	11.64	<23.00
		1	105	19.67	20.25	<23.00
		1	0	19.87	20.45	<23.00
3679.98	40	50	25	14.05	14.63	<23.00
		1	1	19.67	20.25	<23.00
		1	104	19.48	20.06	<23.00
		100	0	11.21	11.79	<23.00
		1	105	19.51	20.09	<23.00
		1	0	19.53	20.11	<23.00
Note: The EIRP (dBm/10MHz) = Output Power (dBm/10MHz) + Antenna Gain (dBi)						

Test Site	SIP-SR1	Test Engineer	Candy Luo
Test Date	2022-10-10 ~ 2022-10-11	Test Band	n48_ENDC

Frequency (MHz)	Channel Bandwidth (MHz)	RB Size	RB Offset	Output Power (dBm/10MHz)	EIRP (dBm/10MHz)	Limit (dBm/10MHz)
DFT-s OFDM PI/2 BPSK						
3555	10	12	6	20.94	21.52	<23.00
		1	1	20.53	21.11	<23.00
		1	22	20.63	21.21	<23.00
		24	0	21.03	21.61	<23.00
		1	23	19.56	20.14	<23.00
		1	0	19.31	19.89	<23.00
3624.99	10	12	6	20.58	21.16	<23.00
		1	1	20.54	21.12	<23.00
		1	22	20.52	21.10	<23.00
		24	0	20.55	21.13	<23.00
		1	23	19.34	19.92	<23.00
		1	0	19.55	20.13	<23.00
3694.98	10	12	6	20.30	20.88	<23.00
		1	1	19.95	20.53	<23.00
		1	22	20.44	21.02	<23.00
		24	0	20.34	20.92	<23.00
		1	23	19.30	19.88	<23.00
		1	0	19.43	20.01	<23.00
3560.01	20	25	12	20.58	21.16	<23.00
		1	1	21.04	21.62	<23.00
		1	49	20.69	21.27	<23.00
		50	0	18.02	18.60	<23.00
		1	50	19.49	20.07	<23.00
		1	0	18.88	19.46	<23.00

Note: The EIRP (dBm/10MHz) = Output Power (dBm/10MHz) + Antenna Gain (dBi)

Frequency (MHz)	Channel Bandwidth (MHz)	RB Size	RB Offset	Output Power (dBm/10MHz)	EIRP (dBm/10MHz)	Limit (dBm/10MHz)
DFT-s OFDM PI/2 BPSK						
3624.99	20	25	12	20.62	21.20	<23.00
		1	1	19.92	20.50	<23.00
		1	49	19.89	20.47	<23.00
		50	0	17.97	18.55	<23.00
		1	50	19.19	19.77	<23.00
		1	0	19.72	20.30	<23.00
3690	20	25	12	20.42	21.00	<23.00
		1	1	20.56	21.14	<23.00
		1	49	19.70	20.28	<23.00
		50	0	17.83	18.41	<23.00
		1	50	19.73	20.31	<23.00
		1	0	19.37	19.95	<23.00
3565.02	30	36	18	19.52	20.10	<23.00
		1	1	20.71	21.29	<23.00
		1	76	20.57	21.15	<23.00
		75	0	16.26	16.84	<23.00
		1	77	19.67	20.25	<23.00
		1	0	19.54	20.12	<23.00
3624.99	30	36	18	17.88	18.46	<23.00
		1	1	20.03	20.61	<23.00
		1	76	20.12	20.70	<23.00
		75	0	16.25	16.83	<23.00
		1	77	19.51	20.09	<23.00
		1	0	19.18	19.76	<23.00
3684.99	30	36	18	19.16	19.74	<23.00
		1	1	19.68	20.26	<23.00
		1	76	19.78	20.36	<23.00
		75	0	15.92	16.50	<23.00
		1	77	19.29	19.87	<23.00
		1	0	19.09	19.67	<23.00
Note: The EIRP (dBm/10MHz) = Output Power (dBm/10MHz) + Antenna Gain (dBi)						

Frequency (MHz)	Channel Bandwidth (MHz)	RB Size	RB Offset	Output Power (dBm/10MHz)	EIRP (dBm/10MHz)	Limit (dBm/10MHz)
DFT-s OFDM PI/2 BPSK						
3570	40	50	25	17.98	18.56	<23.00
		1	1	20.53	21.11	<23.00
		1	104	20.48	21.06	<23.00
		100	0	15.45	16.03	<23.00
		1	105	19.61	20.19	<23.00
		1	0	19.66	20.24	<23.00
3624.99	40	50	25	18.07	18.65	<23.00
		1	1	20.41	20.99	<23.00
		1	104	20.53	21.11	<23.00
		100	0	15.41	15.99	<23.00
		1	105	19.92	20.50	<23.00
		1	0	19.51	20.09	<23.00
3679.98	40	50	25	17.65	18.23	<23.00
		1	1	20.02	20.60	<23.00
		1	104	20.14	20.72	<23.00
		100	0	15.06	15.64	<23.00
		1	105	19.29	19.87	<23.00
		1	0	19.23	19.81	<23.00
Note: The EIRP (dBm/10MHz) = Output Power (dBm/10MHz) + Antenna Gain (dBi)						

Frequency (MHz)	Channel Bandwidth (MHz)	RB Size	RB Offset	Output Power (dBm/10MHz)	EIRP (dBm/10MHz)	Limit (dBm/10MHz)
DFT-s OFDM QPSK						
3555	10	12	6	20.92	21.50	<23.00
		1	1	18.97	19.55	<23.00
		1	22	21.66	22.24	<23.00
		24	0	20.98	21.56	<23.00
		1	23	20.35	20.93	<23.00
		1	0	19.20	19.78	<23.00
3624.99	10	12	6	20.56	21.14	<23.00
		1	1	20.23	20.81	<23.00
		1	22	20.40	20.98	<23.00
		24	0	20.50	21.08	<23.00
		1	23	18.41	18.99	<23.00
		1	0	18.34	18.92	<23.00
3694.98	10	12	6	20.24	20.82	<23.00
		1	1	19.60	20.18	<23.00
		1	22	20.10	20.68	<23.00
		24	0	20.34	20.92	<23.00
		1	23	18.47	19.05	<23.00
		1	0	19.14	19.72	<23.00
3560.01	20	25	12	20.67	21.25	<23.00
		1	1	20.32	20.90	<23.00
		1	49	19.97	20.55	<23.00
		50	0	18.11	18.69	<23.00
		1	50	19.07	19.65	<23.00
		1	0	19.40	19.98	<23.00
Note: The EIRP (dBm/10MHz) = Output Power (dBm/10MHz) + Antenna Gain (dBi)						

Frequency (MHz)	Channel Bandwidth (MHz)	RB Size	RB Offset	Output Power (dBm/10MHz)	EIRP (dBm/10MHz)	Limit (dBm/10MHz)
DFT-s OFDM QPSK						
3624.99	20	25	12	20.57	21.15	<23.00
		1	1	20.12	20.70	<23.00
		1	49	20.01	20.59	<23.00
		50	0	18.05	18.63	<23.00
		1	50	19.57	20.15	<23.00
		1	0	19.14	19.72	<23.00
3690	20	25	12	20.40	20.98	<23.00
		1	1	20.36	20.94	<23.00
		1	49	19.82	20.40	<23.00
		50	0	17.92	18.50	<23.00
		1	50	19.27	19.85	<23.00
		1	0	18.75	19.33	<23.00
3565.02	30	36	18	19.30	19.88	<23.00
		1	1	20.90	21.48	<23.00
		1	76	20.55	21.13	<23.00
		75	0	16.20	16.78	<23.00
		1	77	19.65	20.23	<23.00
		1	0	19.48	20.06	<23.00
3624.99	30	36	18	19.52	20.10	<23.00
		1	1	21.18	21.76	<23.00
		1	76	20.65	21.23	<23.00
		75	0	16.25	16.83	<23.00
		1	77	19.57	20.15	<23.00
		1	0	19.23	19.81	<23.00
3684.99	30	36	18	18.92	19.50	<23.00
		1	1	19.94	20.52	<23.00
		1	76	19.81	20.39	<23.00
		75	0	15.94	16.52	<23.00
		1	77	19.95	20.53	<23.00
		1	0	19.50	20.08	<23.00
Note: The EIRP (dBm/10MHz) = Output Power (dBm/10MHz) + Antenna Gain (dBi)						

Frequency (MHz)	Channel Bandwidth (MHz)	RB Size	RB Offset	Output Power (dBm/10MHz)	EIRP (dBm/10MHz)	Limit (dBm/10MHz)
DFT-s OFDM QPSK						
3570	40	50	25	18.04	18.62	<23.00
		1	1	20.84	21.42	<23.00
		1	104	20.45	21.03	<23.00
		100	0	15.09	15.67	<23.00
		1	105	19.56	20.14	<23.00
		1	0	19.94	20.52	<23.00
3624.99	40	50	25	18.18	18.76	<23.00
		1	1	20.92	21.50	<23.00
		1	104	20.33	20.91	<23.00
		100	0	15.01	15.59	<23.00
		1	105	20.08	20.66	<23.00
		1	0	19.44	20.02	<23.00
3679.98	40	50	25	17.65	18.23	<23.00
		1	1	19.81	20.39	<23.00
		1	104	19.98	20.56	<23.00
		100	0	14.60	15.18	<23.00
		1	105	19.10	19.68	<23.00
		1	0	19.12	19.70	<23.00

Note: The EIRP (dBm/10MHz) = Output Power (dBm/10MHz) + Antenna Gain (dBi)

Frequency (MHz)	Channel Bandwidth (MHz)	RB Size	RB Offset	Output Power (dBm/10MHz)	EIRP (dBm/10MHz)	Limit (dBm/10MHz)
DFT-s OFDM 16QAM						
3555	10	12	6	21.01	21.59	<23.00
		1	1	21.46	22.04	<23.00
		1	22	21.53	22.11	<23.00
		24	0	21.14	21.72	<23.00
		1	23	19.58	20.16	<23.00
		1	0	20.57	21.15	<23.00
3624.99	10	12	6	20.58	21.16	<23.00
		1	1	21.80	22.38	<23.00
		1	22	21.90	22.48	<23.00
		24	0	20.37	20.95	<23.00
		1	23	20.20	20.78	<23.00
		1	0	20.16	20.74	<23.00
3694.98	10	12	6	20.47	21.05	<23.00
		1	1	20.12	20.70	<23.00
		1	22	20.26	20.84	<23.00
		24	0	20.22	20.80	<23.00
		1	23	20.14	20.72	<23.00
		1	0	20.00	20.58	<23.00
3560.01	20	25	12	20.68	21.26	<23.00
		1	1	19.86	20.44	<23.00
		1	49	19.81	20.39	<23.00
		50	0	18.05	18.63	<23.00
		1	50	20.06	20.64	<23.00
		1	0	20.09	20.67	<23.00
Note: The EIRP (dBm/10MHz) = Output Power (dBm/10MHz) + Antenna Gain (dBi)						

Frequency (MHz)	Channel Bandwidth (MHz)	RB Size	RB Offset	Output Power (dBm/10MHz)	EIRP (dBm/10MHz)	Limit (dBm/10MHz)
DFT-s OFDM 16QAM						
3624.99	20	25	12	20.77	21.35	<23.00
		1	1	19.61	20.19	<23.00
		1	49	19.47	20.05	<23.00
		50	0	17.85	18.43	<23.00
		1	50	18.98	19.56	<23.00
		1	0	18.85	19.43	<23.00
3690	20	25	12	20.35	20.93	<23.00
		1	1	19.33	19.91	<23.00
		1	49	19.36	19.94	<23.00
		50	0	17.62	18.20	<23.00
		1	50	19.77	20.35	<23.00
		1	0	18.68	19.26	<23.00
3565.02	30	36	18	19.48	20.06	<23.00
		1	1	20.66	21.24	<23.00
		1	76	20.86	21.44	<23.00
		75	0	16.03	16.61	<23.00
		1	77	19.48	20.06	<23.00
		1	0	20.04	20.62	<23.00
3624.99	30	36	18	19.83	20.41	<23.00
		1	1	20.74	21.32	<23.00
		1	76	20.72	21.30	<23.00
		75	0	16.01	16.59	<23.00
		1	77	19.71	20.29	<23.00
		1	0	20.21	20.79	<23.00
3684.99	30	36	18	19.23	19.81	<23.00
		1	1	20.36	20.94	<23.00
		1	76	20.39	20.97	<23.00
		75	0	15.65	16.23	<23.00
		1	77	19.00	19.58	<23.00
		1	0	19.12	19.70	<23.00
Note: The EIRP (dBm/10MHz) = Output Power (dBm/10MHz) + Antenna Gain (dBi)						

Frequency (MHz)	Channel Bandwidth (MHz)	RB Size	RB Offset	Output Power (dBm/10MHz)	EIRP (dBm/10MHz)	Limit (dBm/10MHz)
DFT-s OFDM 16QAM						
3570	40	50	25	18.08	18.66	<23.00
		1	1	20.00	20.58	<23.00
		1	104	20.05	20.63	<23.00
		100	0	14.82	15.40	<23.00
		1	105	19.78	20.36	<23.00
		1	0	19.65	20.23	<23.00
3624.99	40	50	25	17.99	18.57	<23.00
		1	1	20.11	20.69	<23.00
		1	104	20.21	20.79	<23.00
		100	0	14.78	15.36	<23.00
		1	105	19.50	20.08	<23.00
		1	0	19.70	20.28	<23.00
3679.98	40	50	25	17.81	18.39	<23.00
		1	1	20.37	20.95	<23.00
		1	104	19.77	20.35	<23.00
		100	0	14.38	14.96	<23.00
		1	105	19.39	19.97	<23.00
		1	0	19.40	19.98	<23.00
Note: The EIRP (dBm/10MHz) = Output Power (dBm/10MHz) + Antenna Gain (dBi)						

Frequency (MHz)	Channel Bandwidth (MHz)	RB Size	RB Offset	Output Power (dBm/10MHz)	EIRP (dBm/10MHz)	Limit (dBm/10MHz)
DFT-s OFDM 64QAM						
3555	10	12	6	20.77	21.35	<23.00
		1	1	20.45	21.03	<23.00
		1	22	20.43	21.01	<23.00
		24	0	21.05	21.63	<23.00
		1	23	19.62	20.20	<23.00
		1	0	19.62	20.20	<23.00
3624.99	10	12	6	20.62	21.20	<23.00
		1	1	20.93	21.51	<23.00
		1	22	20.97	21.55	<23.00
		24	0	20.70	21.28	<23.00
		1	23	20.12	20.70	<23.00
		1	0	20.08	20.66	<23.00
3694.98	10	12	6	20.57	21.15	<23.00
		1	1	20.46	21.04	<23.00
		1	22	20.55	21.13	<23.00
		24	0	20.47	21.05	<23.00
		1	23	19.22	19.80	<23.00
		1	0	19.19	19.77	<23.00
3560.01	20	25	12	20.62	21.20	<23.00
		1	1	21.28	21.86	<23.00
		1	49	21.37	21.95	<23.00
		50	0	18.00	18.58	<23.00
		1	50	20.15	20.73	<23.00
		1	0	20.23	20.81	<23.00
Note: The EIRP (dBm/10MHz) = Output Power (dBm/10MHz) + Antenna Gain (dBi)						

Frequency (MHz)	Channel Bandwidth (MHz)	RB Size	RB Offset	Output Power (dBm/10MHz)	EIRP (dBm/10MHz)	Limit (dBm/10MHz)
DFT-s OFDM 64QAM						
3624.99	20	25	12	20.68	21.26	<23.00
		1	1	21.38	21.96	<23.00
		1	49	21.33	21.91	<23.00
		50	0	18.12	18.70	<23.00
		1	50	18.83	19.41	<23.00
		1	0	18.86	19.44	<23.00
3690	20	25	12	20.46	21.04	<23.00
		1	1	21.20	21.78	<23.00
		1	49	21.11	21.69	<23.00
		50	0	18.01	18.59	<23.00
		1	50	18.82	19.40	<23.00
		1	0	18.64	19.22	<23.00
3565.02	30	36	18	19.70	20.28	<23.00
		1	1	19.85	20.43	<23.00
		1	76	2.00	2.58	<23.00
		75	0	16.56	17.14	<23.00
		1	77	18.72	19.30	<23.00
		1	0	18.74	19.32	<23.00
3624.99	30	36	18	19.62	20.20	<23.00
		1	1	20.07	20.65	<23.00
		1	76	20.03	20.61	<23.00
		75	0	16.60	17.18	<23.00
		1	77	18.80	19.38	<23.00
		1	0	18.84	19.42	<23.00
3684.99	30	36	18	19.18	19.76	<23.00
		1	1	19.80	20.38	<23.00
		1	76	19.75	20.33	<23.00
		75	0	16.22	16.80	<23.00
		1	77	18.46	19.04	<23.00
		1	0	18.55	19.13	<23.00

Note: The EIRP (dBm/10MHz) = Output Power (dBm/10MHz) + Antenna Gain (dBi)

Frequency (MHz)	Channel Bandwidth (MHz)	RB Size	RB Offset	Output Power (dBm/10MHz)	EIRP (dBm/10MHz)	Limit (dBm/10MHz)
DFT-s OFDM 64QAM						
3570	40	50	25	18.55	19.13	<23.00
		1	1	21.36	21.94	<23.00
		1	104	21.59	22.17	<23.00
		100	0	15.17	15.75	<23.00
		1	105	19.44	20.02	<23.00
		1	0	19.40	19.98	<23.00
3624.99	40	50	25	18.62	19.20	<23.00
		1	1	21.46	22.04	<23.00
		1	104	21.57	22.15	<23.00
		100	0	15.11	15.69	<23.00
		1	105	19.65	20.23	<23.00
		1	0	19.42	20.00	<23.00
3679.98	40	50	25	18.22	18.80	<23.00
		1	1	21.21	21.79	<23.00
		1	104	21.12	21.70	<23.00
		100	0	14.73	15.31	<23.00
		1	105	19.15	19.73	<23.00
		1	0	19.21	19.79	<23.00

Note: The EIRP (dBm/10MHz) = Output Power (dBm/10MHz) + Antenna Gain (dBi)

Frequency (MHz)	Channel Bandwidth (MHz)	RB Size	RB Offset	Output Power (dBm/10MHz)	EIRP (dBm/10MHz)	Limit (dBm/10MHz)
DFT-s OFDM 256QAM						
3555	10	12	6	18.89	19.47	<23.00
		1	1	17.56	18.14	<23.00
		1	22	17.52	18.10	<23.00
		24	0	19.10	19.68	<23.00
		1	23	17.30	17.88	<23.00
		1	0	17.24	17.82	<23.00
3624.99	10	12	6	18.52	19.10	<23.00
		1	1	18.50	19.08	<23.00
		1	22	18.60	19.18	<23.00
		24	0	18.58	19.16	<23.00
		1	23	18.41	18.99	<23.00
		1	0	18.32	18.90	<23.00
3694.98	10	12	6	18.30	18.88	<23.00
		1	1	18.25	18.83	<23.00
		1	22	19.03	19.61	<23.00
		24	0	18.21	18.79	<23.00
		1	23	18.37	18.95	<23.00
		1	0	18.26	18.84	<23.00
3560.01	20	25	12	18.70	19.28	<23.00
		1	1	17.88	18.46	<23.00
		1	49	17.95	18.53	<23.00
		50	0	16.54	17.12	<23.00
		1	50	18.01	18.59	<23.00
		1	0	17.76	18.34	<23.00
Note: The EIRP (dBm/10MHz) = Output Power (dBm/10MHz) + Antenna Gain (dBi)						

Frequency (MHz)	Channel Bandwidth (MHz)	RB Size	RB Offset	Output Power (dBm/10MHz)	EIRP (dBm/10MHz)	Limit (dBm/10MHz)
DFT-s OFDM 256QAM						
3624.99	20	25	12	18.74	19.32	<23.00
		1	1	17.89	18.47	<23.00
		1	49	18.05	18.63	<23.00
		50	0	16.60	17.18	<23.00
		1	50	17.93	18.51	<23.00
		1	0	18.19	18.77	<23.00
3690	20	25	12	18.55	19.13	<23.00
		1	1	17.93	18.51	<23.00
		1	49	17.99	18.57	<23.00
		50	0	16.47	17.05	<23.00
		1	50	17.88	18.46	<23.00
		1	0	17.74	18.32	<23.00
3565.02	30	36	18	17.95	18.53	<23.00
		1	1	18.85	19.43	<23.00
		1	76	18.86	19.44	<23.00
		75	0	14.09	14.67	<23.00
		1	77	18.82	19.40	<23.00
		1	0	18.58	19.16	<23.00
3624.99	30	36	18	17.85	18.43	<23.00
		1	1	18.31	18.89	<23.00
		1	76	18.35	18.93	<23.00
		75	0	14.21	14.79	<23.00
		1	77	18.35	18.93	<23.00
		1	0	18.35	18.93	<23.00
3684.99	30	36	18	17.51	18.09	<23.00
		1	1	18.04	18.62	<23.00
		1	76	18.23	18.81	<23.00
		75	0	13.89	14.47	<23.00
		1	77	18.11	18.69	<23.00
		1	0	18.01	18.59	<23.00
Note: The EIRP (dBm/10MHz) = Output Power (dBm/10MHz) + Antenna Gain (dBi)						

Frequency (MHz)	Channel Bandwidth (MHz)	RB Size	RB Offset	Output Power (dBm/10MHz)	EIRP (dBm/10MHz)	Limit (dBm/10MHz)
DFT-s OFDM 256QAM						
3570	40	50	25	16.47	17.05	<23.00
		1	1	18.00	18.58	<23.00
		1	104	18.13	18.71	<23.00
		100	0	13.29	13.87	<23.00
		1	105	18.25	18.83	<23.00
		1	0	17.94	18.52	<23.00
3624.99	40	50	25	16.44	17.02	<23.00
		1	1	18.15	18.73	<23.00
		1	104	18.20	18.78	<23.00
		100	0	13.28	13.86	<23.00
		1	105	18.27	18.85	<23.00
		1	0	18.19	18.77	<23.00
3679.98	40	50	25	16.09	16.67	<23.00
		1	1	17.90	18.48	<23.00
		1	104	17.80	18.38	<23.00
		100	0	12.90	13.48	<23.00
		1	105	17.92	18.50	<23.00
		1	0	17.85	18.43	<23.00
Note: The EIRP (dBm/10MHz) = Output Power (dBm/10MHz) + Antenna Gain (dBi)						

Test Site	SIP-SR1	Test Engineer	Candy Luo
Test Date	2022-10-10 ~ 2022-10-11	Test Band	n48_UL MIMO

Frequency (MHz)	Channel Bandwidth (MHz)	RB Size	RB Offset	Output Power (dBm)		Total Power (dBm)	EIRP (dBm)	Limit (dBm)
				Port 0	Port 3			
CP OFDM QPSK								
3555	10	12	6	16.85	16.23	19.56	20.14	<23.00
		1	1	16.96	17.79	20.41	20.99	<23.00
		1	22	17.12	17.45	20.30	20.88	<23.00
		24	0	15.36	14.87	18.13	18.71	<23.00
		1	23	14.57	16.09	18.41	18.99	<23.00
		1	0	15.00	15.88	18.47	19.05	<23.00
3624.99	10	12	6	17.07	16.59	19.85	20.43	<23.00
		1	1	16.57	17.56	20.10	20.68	<23.00
		1	22	17.76	17.23	20.51	21.09	<23.00
		24	0	15.75	15.40	18.59	19.17	<23.00
		1	23	16.15	16.21	19.19	19.77	<23.00
		1	0	14.85	16.14	18.55	19.13	<23.00
3694.98	10	12	6	16.53	16.78	19.67	20.25	<23.00
		1	1	16.76	17.06	19.92	20.50	<23.00
		1	22	18.80	18.33	21.58	22.16	<23.00
		24	0	15.23	15.57	18.41	18.99	<23.00
		1	23	13.83	15.65	17.84	18.42	<23.00
		1	0	14.02	15.28	17.71	18.29	<23.00
3560.01	20	25	12	16.81	16.63	19.73	20.31	<23.00
		1	1	15.75	16.67	19.24	19.82	<23.00
		1	49	16.71	16.61	19.67	20.25	<23.00
		51	0	13.06	12.67	15.88	16.46	<23.00
		1	50	15.69	16.25	18.99	19.57	<23.00
		1	0	15.54	16.59	19.11	19.69	<23.00

Note 1: Total Power (dBm) = $10 \cdot \log\{10^{(\text{Port 0 Output Power} / 10)} + 10^{(\text{Port 1 Output Power} / 10)}\}$

Note 2: The EIRP (dBm/10MHz) = Output Power (dBm/10MHz) + Antenna Gain (dBi)

Frequency (MHz)	Channel Bandwidth (MHz)	RB Size	RB Offset	Output Power (dBm)		Total Power (dBm)	EIRP (dBm)	Limit (dBm)
				Port 0	Port 3			
CP OFDM QPSK								
3624.99	20	25	12	16.78	15.95	19.40	19.98	<23.00
		1	1	15.18	17.40	19.44	20.02	<23.00
		1	49	17.28	16.95	20.13	20.71	<23.00
		51	0	12.58	12.56	15.58	16.16	<23.00
		1	50	15.36	16.41	18.93	19.51	<23.00
		1	0	15.34	16.12	18.76	19.34	<23.00
3690	20	25	12	16.61	16.32	19.48	20.06	<23.00
		1	1	15.71	17.18	19.52	20.10	<23.00
		1	49	15.92	17.02	19.52	20.10	<23.00
		51	0	12.70	12.84	15.78	16.36	<23.00
		1	50	15.20	16.39	18.85	19.43	<23.00
		1	0	15.68	16.76	19.26	19.84	<23.00
3565.02	30	36	18	15.49	15.51	18.51	19.09	<23.00
		1	1	17.53	17.55	20.55	21.13	<23.00
		1	76	17.51	17.58	20.56	21.14	<23.00
		78	0	11.03	11.41	14.23	14.81	<23.00
		1	77	15.51	16.69	19.15	19.73	<23.00
		1	0	15.57	16.60	19.13	19.71	<23.00
3624.99	30	39	19	15.68	15.77	18.74	19.32	<23.00
		1	1	17.41	17.19	20.31	20.89	<23.00
		1	76	17.34	17.43	20.40	20.98	<23.00
		78	0	10.82	11.48	14.17	14.75	<23.00
		1	77	15.64	16.73	19.23	19.81	<23.00
		1	0	15.72	16.59	19.19	19.77	<23.00
3684.99	30	39	19	15.79	16.07	18.94	19.52	<23.00
		1	1	17.58	17.74	20.67	21.25	<23.00
		1	76	16.65	16.49	19.58	20.16	<23.00
		78	0	10.65	11.61	14.17	14.75	<23.00
		1	77	14.81	17.53	19.39	19.97	<23.00
		1	0	14.95	17.65	19.52	20.10	<23.00
Note 1: Total Power (dBm) = $10 \cdot \log\{10^{(\text{Port 0 Output Power} / 10)} + 10^{(\text{Port 1 Output Power} / 10)}\}$ Note 2: The EIRP (dBm/10MHz) = Output Power (dBm/10MHz) + Antenna Gain (dBi)								

Frequency (MHz)	Channel Bandwidth (MHz)	RB Size	RB Offset	Output Power (dBm)		Total Power (dBm)	EIRP (dBm)	Limit (dBm)
				Port 0	Port 3			
CP OFDM QPSK								
3570	40	53	26	14.74	14.42	17.59	18.17	<23.00
		1	1	15.36	18.94	20.52	21.10	<23.00
		1	104	15.78	19.07	20.74	21.32	<23.00
		106	0	9.57	10.82	13.25	13.83	<23.00
		1	105	15.28	19.09	20.60	21.18	<23.00
		1	0	15.00	18.92	20.40	20.98	<23.00
3624.99	40	53	26	14.59	14.56	17.59	18.17	<23.00
		1	1	11.36	20.15	20.69	21.27	<23.00
		1	104	11.07	20.06	20.58	21.16	<23.00
		106	0	9.51	11.12	13.40	13.98	<23.00
		1	105	12.67	18.35	19.39	19.97	<23.00
		1	0	16.44	18.95	20.88	21.46	<23.00
3679.98	40	53	26	14.56	14.86	17.72	18.30	<23.00
		1	1	14.87	19.57	20.84	21.42	<23.00
		1	104	14.04	19.52	20.60	21.18	<23.00
		106	0	9.07	11.30	13.34	13.92	<23.00
		1	105	14.65	19.18	20.49	21.07	<23.00
		1	0	14.72	19.11	20.46	21.04	<23.00
Note 1: Total Power (dBm) = $10 \cdot \log\{10^{(\text{Port 0 Output Power} / 10)} + 10^{(\text{Port 1 Output Power} / 10)}\}$ Note 2: The EIRP (dBm/10MHz) = Output Power (dBm/10MHz) + Antenna Gain (dBi)								

Frequency (MHz)	Channel Bandwidth (MHz)	RB Size	RB Offset	Output Power (dBm)		Total Power (dBm)	EIRP (dBm)	Limit (dBm)
				Port 0	Port 3			
CP OFDM 16QAM								
3555	10	12	6	16.50	16.36	19.44	20.02	<23.00
		1	1	15.71	17.77	19.87	20.45	<23.00
		1	22	15.36	17.51	19.58	20.16	<23.00
		24	0	15.35	14.80	18.09	18.67	<23.00
		1	23	13.52	17.90	19.25	19.83	<23.00
		1	0	12.80	17.96	19.12	19.70	<23.00
3624.99	10	12	6	16.40	16.32	19.37	19.95	<23.00
		1	1	15.57	17.70	19.77	20.35	<23.00
		1	22	15.86	17.04	19.50	20.08	<23.00
		24	0	15.30	15.01	18.17	18.75	<23.00
		1	23	12.54	17.83	18.96	19.54	<23.00
		1	0	12.65	17.65	18.84	19.42	<23.00
3694.98	10	12	6	16.41	16.85	19.65	20.23	<23.00
		1	1	13.17	16.82	18.38	18.96	<23.00
		1	22	15.11	18.06	19.84	20.42	<23.00
		24	0	15.19	15.26	18.24	18.82	<23.00
		1	23	13.21	17.00	18.52	19.10	<23.00
		1	0	13.24	16.77	18.36	18.94	<23.00
3560.01	20	25	12	16.91	16.77	19.85	20.43	<23.00
		1	1	17.65	16.02	19.92	20.50	<23.00
		1	49	17.46	15.21	19.49	20.07	<23.00
		51	0	12.78	12.94	15.87	16.45	<23.00
		1	50	16.24	14.99	18.67	19.25	<23.00
		1	0	16.16	14.60	18.46	19.04	<23.00
Note 1: Total Power (dBm) = $10 \cdot \log\{10^{(\text{Port 0 Output Power} / 10)} + 10^{(\text{Port 1 Output Power} / 10)}\}$ Note 2: The EIRP (dBm/10MHz) = Output Power (dBm/10MHz) + Antenna Gain (dBi)								

Frequency (MHz)	Channel Bandwidth (MHz)	RB Size	RB Offset	Output Power (dBm)		Total Power (dBm)	EIRP (dBm)	Limit (dBm)
				Port 0	Port 3			
CP OFDM 16QAM								
3624.99	20	25	12	15.98	16.12	19.06	19.64	<23.00
		1	1	17.59	15.78	19.79	20.37	<23.00
		1	49	17.69	16.13	19.99	20.57	<23.00
		51	0	12.75	12.51	15.64	16.22	<23.00
		1	50	16.40	15.03	18.78	19.36	<23.00
		1	0	16.10	14.96	18.58	19.16	<23.00
3690	20	25	12	16.08	16.62	19.37	19.95	<23.00
		1	1	17.54	16.39	20.01	20.59	<23.00
		1	49	17.45	15.54	19.61	20.19	<23.00
		51	0	12.67	13.01	15.85	16.43	<23.00
		1	50	16.23	14.36	18.41	18.99	<23.00
		1	0	16.37	14.90	18.71	19.29	<23.00
3565.02	30	36	18	15.34	15.11	18.24	18.82	<23.00
		1	1	16.87	16.32	19.61	20.19	<23.00
		1	76	16.94	16.43	19.70	20.28	<23.00
		78	0	11.76	10.52	14.19	14.77	<23.00
		1	77	15.94	15.74	18.85	19.43	<23.00
		1	0	15.73	15.83	18.79	19.37	<23.00
3624.99	30	39	19	15.24	15.07	18.17	18.75	<23.00
		1	1	16.86	16.12	19.52	20.10	<23.00
		1	76	16.62	15.62	19.16	19.74	<23.00
		78	0	11.64	10.55	14.14	14.72	<23.00
		1	77	15.80	15.97	18.90	19.48	<23.00
		1	0	16.05	15.79	18.93	19.51	<23.00
3684.99	30	39	19	15.16	15.23	18.21	18.79	<23.00
		1	1	16.73	16.70	19.73	20.31	<23.00
		1	76	16.63	16.53	19.59	20.17	<23.00
		78	0	10.90	10.63	13.78	14.36	<23.00
		1	77	15.94	16.42	19.20	19.78	<23.00
		1	0	16.07	16.09	19.09	19.67	<23.00
Note 1: Total Power (dBm) = $10 \cdot \log\{10^{(\text{Port 0 Output Power} / 10)} + 10^{(\text{Port 1 Output Power} / 10)}\}$ Note 2: The EIRP (dBm/10MHz) = Output Power (dBm/10MHz) + Antenna Gain (dBi)								

Frequency (MHz)	Channel Bandwidth (MHz)	RB Size	RB Offset	Output Power (dBm)		Total Power (dBm)	EIRP (dBm)	Limit (dBm)
				Port 0	Port 3			
CP OFDM 16QAM								
3570	40	53	26	13.62	13.77	16.71	17.29	<23.00
		1	1	16.57	17.48	20.06	20.64	<23.00
		1	104	16.47	17.97	20.29	20.87	<23.00
		106	0	9.85	10.02	12.95	13.53	<23.00
		1	105	15.43	16.56	19.04	19.62	<23.00
		1	0	15.15	16.51	18.89	19.47	<23.00
3624.99	40	53	26	13.39	13.64	16.53	17.11	<23.00
		1	1	16.34	17.50	19.97	20.55	<23.00
		1	104	16.38	17.91	20.22	20.80	<23.00
		106	0	9.65	10.04	12.86	13.44	<23.00
		1	105	14.76	19.05	20.42	21.00	<23.00
		1	0	14.79	18.61	20.12	20.70	<23.00
3679.98	40	53	26	13.18	14.40	16.84	17.42	<23.00
		1	1	17.39	18.40	20.93	21.51	<23.00
		1	104	17.34	18.45	20.94	21.52	<23.00
		106	0	9.75	10.54	13.17	13.75	<23.00
		1	105	16.15	17.42	19.84	20.42	<23.00
		1	0	15.99	17.52	19.83	20.41	<23.00
Note 1: Total Power (dBm) = $10 \cdot \log\{10^{(\text{Port 0 Output Power} / 10)} + 10^{(\text{Port 1 Output Power} / 10)}\}$ Note 2: The EIRP (dBm/10MHz) = Output Power (dBm/10MHz) + Antenna Gain (dBi)								

Frequency (MHz)	Channel Bandwidth (MHz)	RB Size	RB Offset	Output Power (dBm)		Total Power (dBm)	EIRP (dBm)	Limit (dBm)
				Port 0	Port 3			
CP OFDM 64QAM								
3555	10	12	6	14.90	14.98	17.95	18.53	<23.00
		1	1	14.98	13.53	17.33	17.91	<23.00
		1	22	13.55	14.04	16.81	17.39	<23.00
		24	0	15.15	14.79	17.98	18.56	<23.00
		1	23	14.43	14.63	17.54	18.12	<23.00
		1	0	13.49	14.90	17.26	17.84	<23.00
3624.99	10	12	6	14.88	14.65	17.78	18.36	<23.00
		1	1	14.60	13.51	17.10	17.68	<23.00
		1	22	14.29	13.53	16.94	17.52	<23.00
		24	0	15.17	15.03	18.11	18.69	<23.00
		1	23	13.84	13.63	16.75	17.33	<23.00
		1	0	14.01	13.73	16.88	17.46	<23.00
3694.98	10	12	6	14.48	15.27	17.90	18.48	<23.00
		1	1	14.17	15.16	17.70	18.28	<23.00
		1	22	14.04	13.99	17.03	17.61	<23.00
		24	0	15.15	15.27	18.22	18.80	<23.00
		1	23	13.98	15.56	17.85	18.43	<23.00
		1	0	14.19	14.93	17.59	18.17	<23.00
3560.01	20	25	12	14.66	14.60	17.64	18.22	<23.00
		1	1	16.11	14.37	18.34	18.92	<23.00
		1	49	15.38	14.44	17.95	18.53	<23.00
		51	0	12.90	12.67	15.80	16.38	<23.00
		1	50	16.04	14.32	18.27	18.85	<23.00
		1	0	15.07	14.60	17.85	18.43	<23.00
Note 1: Total Power (dBm) = $10 \cdot \log\{10^{(\text{Port 0 Output Power} / 10)} + 10^{(\text{Port 1 Output Power} / 10)}\}$ Note 2: The EIRP (dBm/10MHz) = Output Power (dBm/10MHz) + Antenna Gain (dBi)								

Frequency (MHz)	Channel Bandwidth (MHz)	RB Size	RB Offset	Output Power (dBm)		Total Power (dBm)	EIRP (dBm)	Limit (dBm)
				Port 0	Port 3			
CP OFDM 64QAM								
3624.99	20	25	12	14.55	14.21	17.39	17.97	<23.00
		1	1	14.42	14.46	17.45	18.03	<23.00
		1	49	16.37	14.58	18.58	19.16	<23.00
		51	0	12.30	12.41	15.37	15.95	<23.00
		1	50	15.62	14.36	18.05	18.63	<23.00
		1	0	16.62	14.50	18.70	19.28	<23.00
3690	20	25	12	14.62	14.85	17.75	18.33	<23.00
		1	1	16.21	14.84	18.59	19.17	<23.00
		1	49	15.14	14.47	17.83	18.41	<23.00
		51	0	12.18	12.97	15.60	16.18	<23.00
		1	50	15.00	14.04	17.56	18.14	<23.00
		1	0	14.67	14.66	17.68	18.26	<23.00
3565.02	30	36	18	14.00	13.48	16.76	17.34	<23.00
		1	1	15.24	15.03	18.15	18.73	<23.00
		1	76	14.98	15.18	18.09	18.67	<23.00
		78	0	10.41	10.75	13.59	14.17	<23.00
		1	77	14.93	15.31	18.13	18.71	<23.00
		1	0	14.87	15.12	18.01	18.59	<23.00
3624.99	30	39	19	13.92	13.47	16.71	17.29	<23.00
		1	1	15.26	15.03	18.16	18.74	<23.00
		1	76	14.78	15.24	18.03	18.61	<23.00
		78	0	10.38	10.89	13.65	14.23	<23.00
		1	77	14.90	15.23	18.08	18.66	<23.00
		1	0	14.96	15.04	18.01	18.59	<23.00
3684.99	30	39	19	14.01	13.72	16.88	17.46	<23.00
		1	1	14.76	15.60	18.21	18.79	<23.00
		1	76	14.90	15.44	18.19	18.77	<23.00
		78	0	10.75	11.08	13.93	14.51	<23.00
		1	77	14.83	15.89	18.40	18.98	<23.00
		1	0	14.89	15.42	18.17	18.75	<23.00
Note 1: Total Power (dBm) = $10 \cdot \log\{10^{(\text{Port 0 Output Power} / 10)} + 10^{(\text{Port 1 Output Power} / 10)}\}$ Note 2: The EIRP (dBm/10MHz) = Output Power (dBm/10MHz) + Antenna Gain (dBi)								

Frequency (MHz)	Channel Bandwidth (MHz)	RB Size	RB Offset	Output Power (dBm)		Total Power (dBm)	EIRP (dBm)	Limit (dBm)
				Port 0	Port 3			
CP OFDM 64QAM								
3570	40	53	26	12.53	13.14	15.86	16.44	<23.00
		1	1	14.63	13.81	17.25	17.83	<23.00
		1	104	13.87	14.33	17.12	17.70	<23.00
		106	0	8.84	9.35	12.11	12.69	<23.00
		1	105	14.49	14.81	17.66	18.24	<23.00
		1	0	13.63	14.60	17.15	17.73	<23.00
3624.99	40	53	26	12.40	13.00	15.72	16.30	<23.00
		1	1	14.35	13.93	17.16	17.74	<23.00
		1	104	14.06	14.44	17.26	17.84	<23.00
		106	0	8.92	9.32	12.13	12.71	<23.00
		1	105	14.11	12.12	16.24	16.82	<23.00
		1	0	12.18	13.39	15.84	16.42	<23.00
3679.98	40	53	26	12.09	13.30	15.75	16.33	<23.00
		1	1	13.96	15.02	17.53	18.11	<23.00
		1	104	13.92	13.96	16.95	17.53	<23.00
		106	0	8.59	9.64	12.16	12.74	<23.00
		1	105	14.01	15.01	17.55	18.13	<23.00
		1	0	13.90	15.12	17.56	18.14	<23.00
Note 1: Total Power (dBm) = $10 \cdot \log\{10^{(\text{Port 0 Output Power} / 10)} + 10^{(\text{Port 1 Output Power} / 10)}\}$ Note 2: The EIRP (dBm/10MHz) = Output Power (dBm/10MHz) + Antenna Gain (dBi)								

Frequency (MHz)	Channel Bandwidth (MHz)	RB Size	RB Offset	Output Power (dBm)		Total Power (dBm)	EIRP (dBm)	Limit (dBm)
				Port 0	Port 3			
CP OFDM 256QAM								
3555	10	12	6	11.59	12.29	14.96	15.54	<23.00
		1	1	11.48	11.01	14.26	14.84	<23.00
		1	22	11.53	11.02	14.29	14.87	<23.00
		24	0	11.98	12.03	15.02	15.60	<23.00
		1	23	11.02	10.12	13.60	14.18	<23.00
		1	0	10.94	11.16	14.06	14.64	<23.00
3624.99	10	12	6	11.75	12.57	15.19	15.77	<23.00
		1	1	11.41	11.56	14.50	15.08	<23.00
		1	22	12.12	11.48	14.82	15.40	<23.00
		24	0	12.10	11.85	14.99	15.57	<23.00
		1	23	12.22	12.19	15.22	15.80	<23.00
		1	0	11.44	12.05	14.77	15.35	<23.00
3694.98	10	12	6	11.38	12.78	15.15	15.73	<23.00
		1	1	11.39	12.53	15.01	15.59	<23.00
		1	22	11.76	11.10	14.45	15.03	<23.00
		24	0	11.90	12.53	15.24	15.82	<23.00
		1	23	11.40	12.12	14.79	15.37	<23.00
		1	0	11.38	12.49	14.98	15.56	<23.00
3560.01	20	25	12	11.99	11.81	14.91	15.49	<23.00
		1	1	11.41	10.50	13.99	14.57	<23.00
		1	49	11.00	11.29	14.16	14.74	<23.00
		51	0	9.66	9.34	12.51	13.09	<23.00
		1	50	11.62	9.53	13.71	14.29	<23.00
		1	0	11.38	10.77	14.10	14.68	<23.00
Note 1: Total Power (dBm) = $10 \cdot \log\{10^{(\text{Port 0 Output Power} / 10)} + 10^{(\text{Port 1 Output Power} / 10)}\}$ Note 2: The EIRP (dBm/10MHz) = Output Power (dBm/10MHz) + Antenna Gain (dBi)								

Frequency (MHz)	Channel Bandwidth (MHz)	RB Size	RB Offset	Output Power (dBm)		Total Power (dBm)	EIRP (dBm)	Limit (dBm)
				Port 0	Port 3			
CP OFDM 256QAM								
3624.99	20	25	12	11.63	11.38	14.52	15.10	<23.00
		1	1	12.22	10.26	14.36	14.94	<23.00
		1	49	11.08	11.02	14.06	14.64	<23.00
		51	0	9.36	9.17	12.28	12.86	<23.00
		1	50	12.01	10.26	14.23	14.81	<23.00
		1	0	12.00	9.91	14.09	14.67	<23.00
3690	20	25	12	11.74	11.84	14.80	15.38	<23.00
		1	1	11.48	10.04	13.83	14.41	<23.00
		1	49	11.37	10.08	13.78	14.36	<23.00
		51	0	9.43	9.59	12.52	13.10	<23.00
		1	50	10.78	10.67	13.74	14.32	<23.00
		1	0	11.37	11.21	14.30	14.88	<23.00
3565.02	30	36	18	10.89	10.88	13.90	14.48	<23.00
		1	1	11.10	12.12	14.65	15.23	<23.00
		1	76	11.08	11.98	14.56	15.14	<23.00
		78	0	7.76	8.01	10.90	11.48	<23.00
		1	77	11.05	11.93	14.52	15.10	<23.00
		1	0	10.80	12.07	14.49	15.07	<23.00
3624.99	30	39	19	10.82	10.95	13.90	14.48	<23.00
		1	1	10.82	12.00	14.46	15.04	<23.00
		1	76	10.71	12.34	14.61	15.19	<23.00
		78	0	7.74	7.91	10.84	11.42	<23.00
		1	77	10.89	11.90	14.43	15.01	<23.00
		1	0	11.03	12.25	14.69	15.27	<23.00
3684.99	30	39	19	10.80	11.19	14.01	14.59	<23.00
		1	1	10.84	12.18	14.57	15.15	<23.00
		1	76	10.55	12.20	14.46	15.04	<23.00
		78	0	7.27	7.50	10.40	10.98	<23.00
		1	77	10.55	12.95	14.92	15.50	<23.00
		1	0	10.94	12.32	14.69	15.27	<23.00
Note 1: Total Power (dBm) = $10 \cdot \log\{10^{(\text{Port 0 Output Power} / 10)} + 10^{(\text{Port 1 Output Power} / 10)}\}$ Note 2: The EIRP (dBm/10MHz) = Output Power (dBm/10MHz) + Antenna Gain (dBi)								

Frequency (MHz)	Channel Bandwidth (MHz)	RB Size	RB Offset	Output Power (dBm)		Total Power (dBm)	EIRP (dBm)	Limit (dBm)
				Port 0	Port 3			
CP OFDM 256QAM								
3570	40	53	26	9.56	9.60	12.59	13.17	<23.00
		1	1	10.75	10.70	13.74	14.32	<23.00
		1	104	11.15	10.01	13.63	14.21	<23.00
		106	0	6.09	6.62	9.37	9.95	<23.00
		1	105	10.98	11.66	14.34	14.92	<23.00
		1	0	10.60	10.63	13.63	14.21	<23.00
3624.99	40	53	26	9.29	9.51	12.41	12.99	<23.00
		1	1	10.83	11.39	14.13	14.71	<23.00
		1	104	11.07	11.21	14.15	14.73	<23.00
		106	0	6.07	6.37	9.23	9.81	<23.00
		1	105	10.66	11.25	13.98	14.56	<23.00
		1	0	8.57	8.16	11.38	11.96	<23.00
3679.98	40	53	26	9.58	9.75	12.68	13.26	<23.00
		1	1	10.42	11.28	13.88	14.46	<23.00
		1	104	10.34	11.49	13.96	14.54	<23.00
		106	0	5.75	6.51	9.16	9.74	<23.00
		1	105	10.37	11.38	13.91	14.49	<23.00
		1	0	10.46	11.24	13.88	14.46	<23.00
Note 1: Total Power (dBm) = $10 \cdot \log\{10^{(\text{Port 0 Output Power} / 10)} + 10^{(\text{Port 1 Output Power} / 10)}\}$ Note 2: The EIRP (dBm/10MHz) = Output Power (dBm/10MHz) + Antenna Gain (dBi)								

A.4 Band Edge Test Result

Test Site	SIP-SR1	Test Engineer	Candy Luo
Test Date	2022-10-09 ~ 2022-10-09	Test Band	n48_SA

10MHz Channel Bandwidth - 1RB

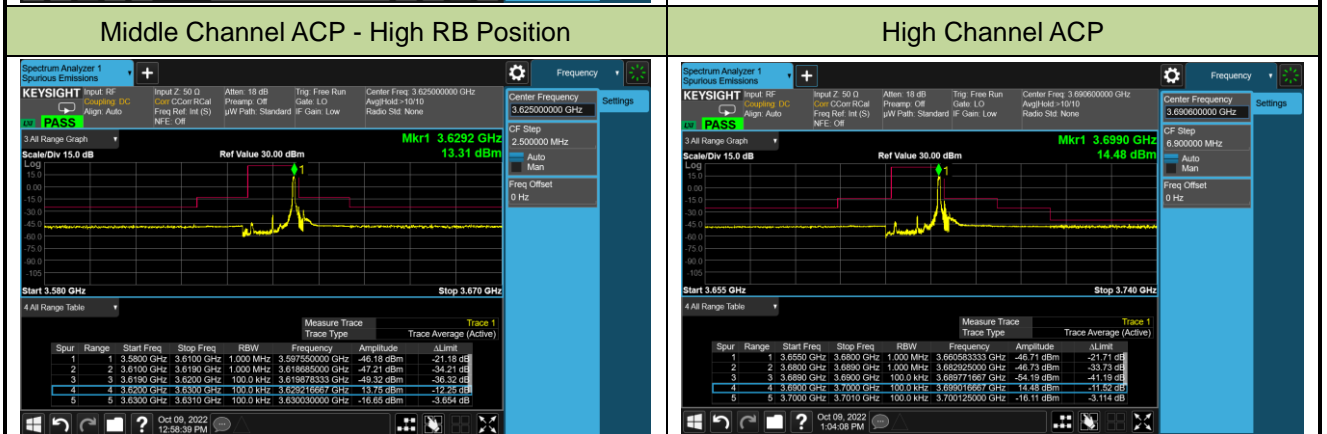
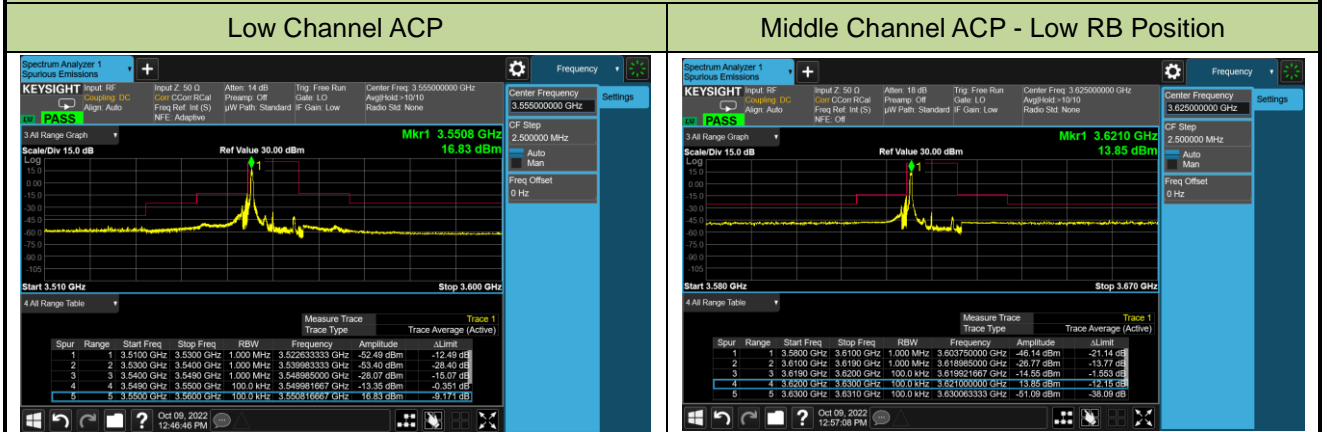

20MHz Channel Bandwidth - 1RB

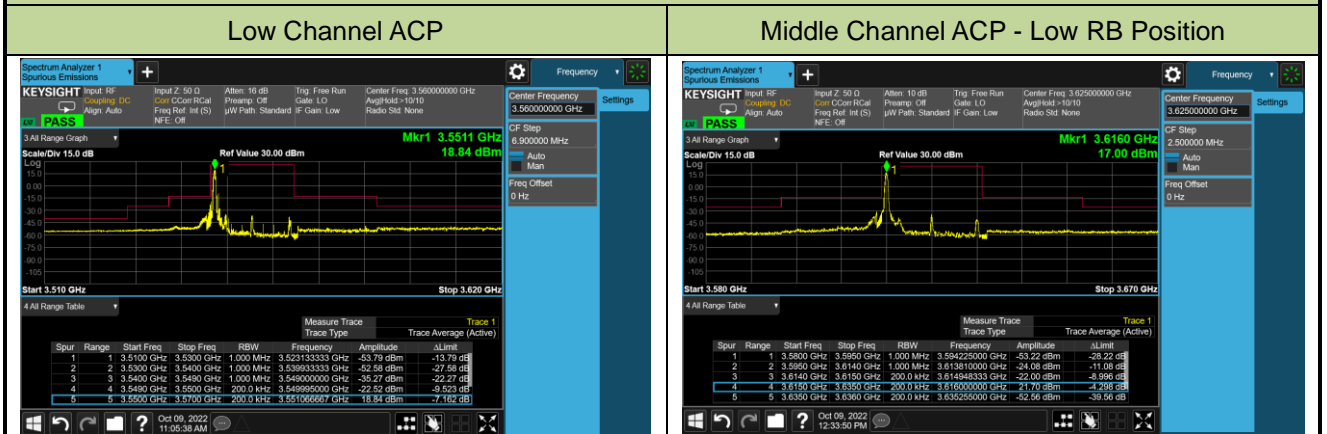

Middle Channel ACP - High RB Position

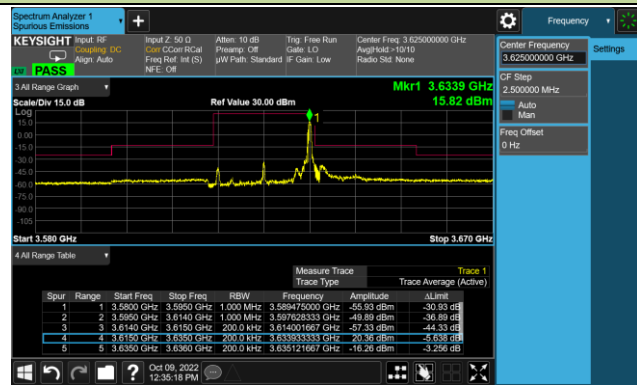

High Channel ACP

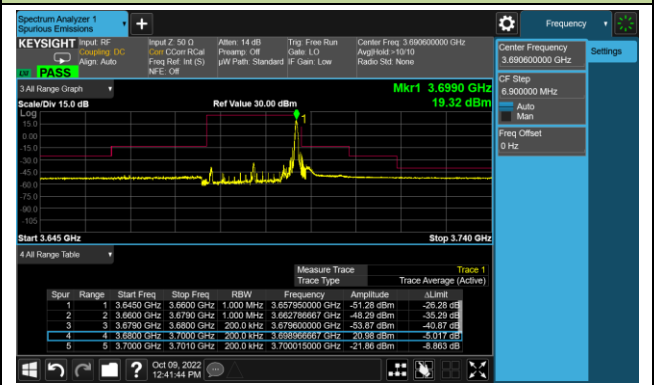

30MHz Channel Bandwidth - 1RB

Low Channel ACP

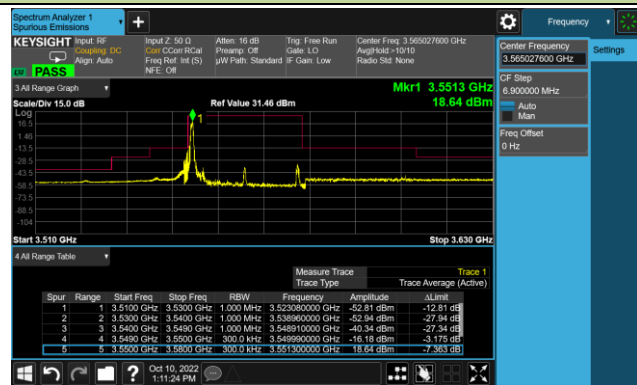

Middle Channel ACP - Low RB Position

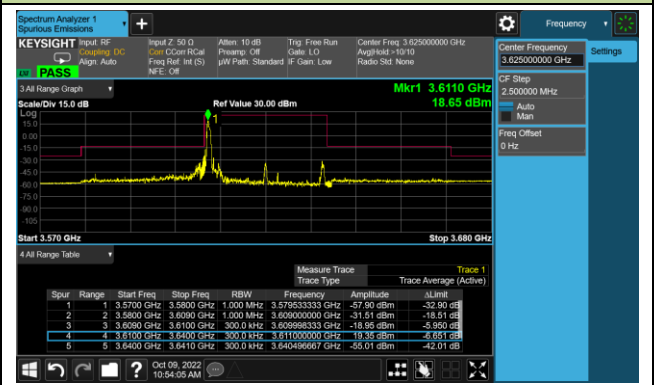

Middle Channel ACP - High RB Position

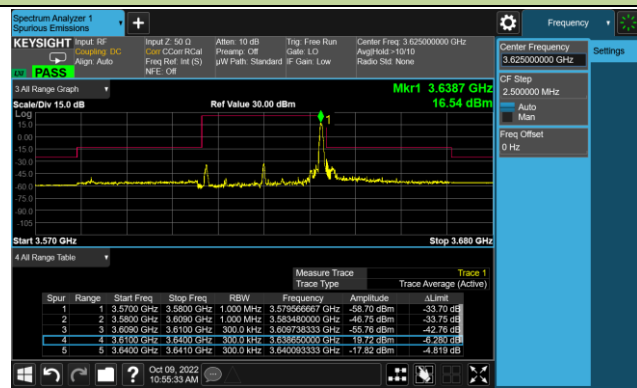

High Channel ACP

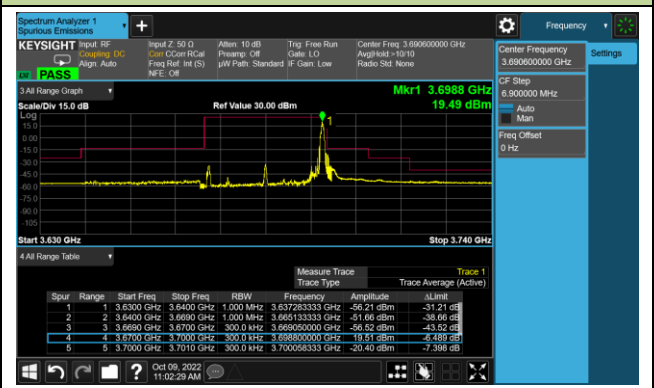

40MHz Channel Bandwidth - 1RB

Low Channel ACP

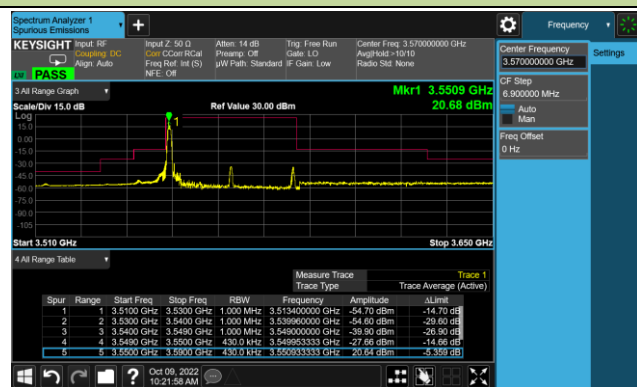

Middle Channel ACP - Low RB Position

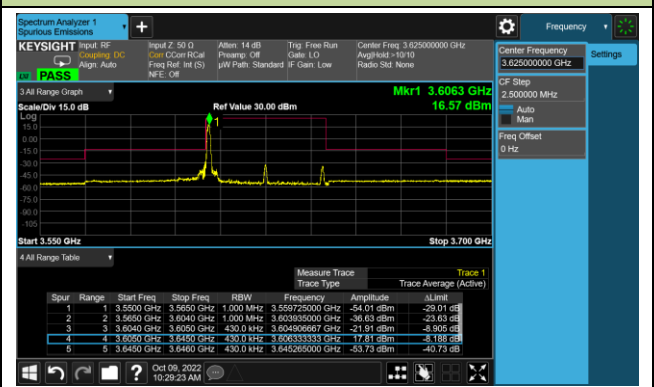

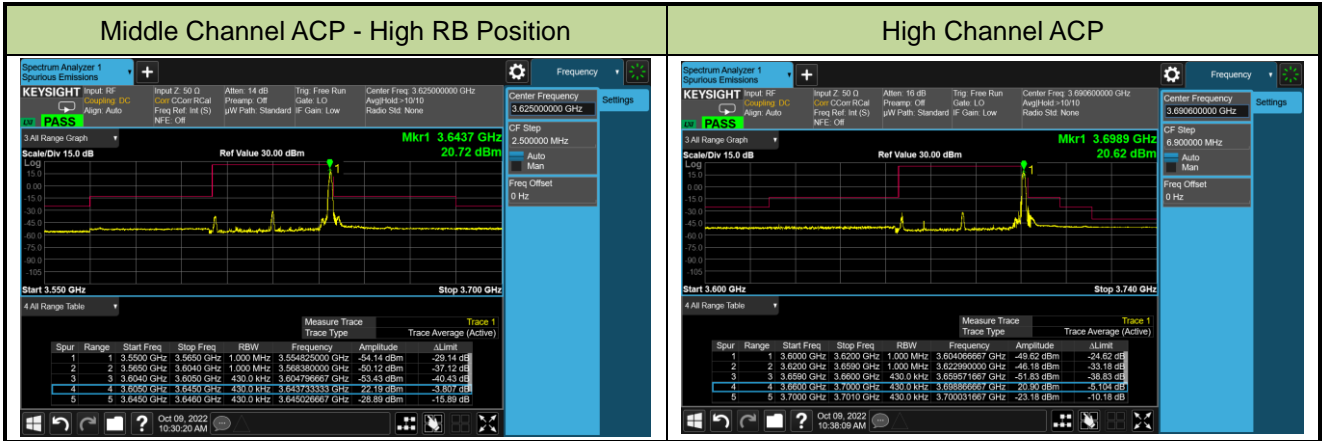

10MHz Channel Bandwidth - Full RB

Low Channel ACP

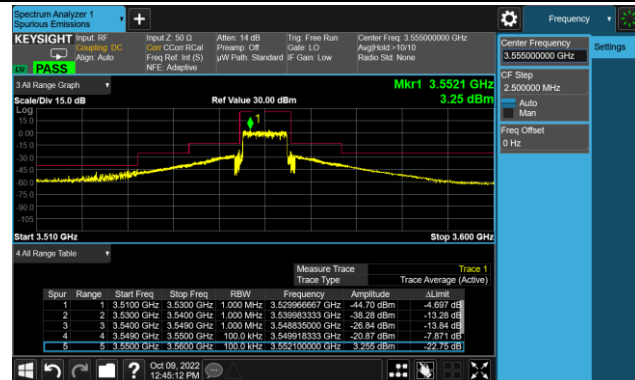

Middle Channel ACP

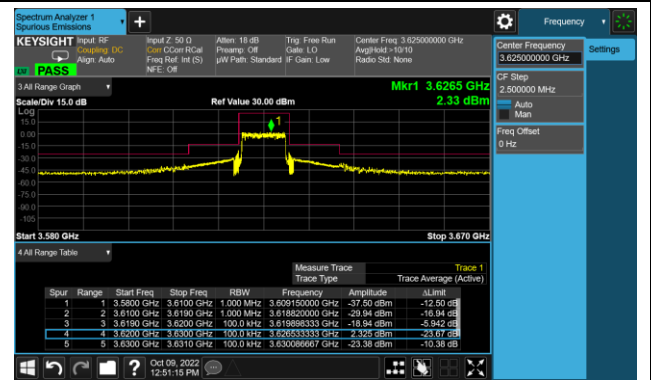

High Channel ACP

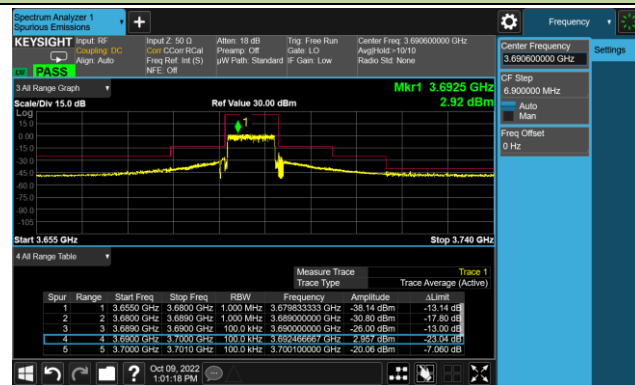

20MHz Channel Bandwidth - Full RB

Low Channel ACP

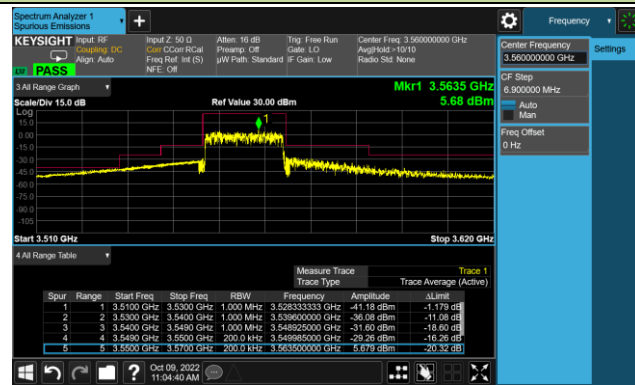

Middle Channel ACP

