

RF MEASUREMENT REPORT

FCC ID: XMR2022EM060KGL
Applicant: Quectel Wireless Solutions Co., Ltd
Product: LTE-A Cat 6 M.2 Module
Model No.: EM060K-GL
Brand Name: Quectel
FCC Rule(s): Part 27
Result: Complies
Received Date: 2023-09-22
Test Date: 2023-09-25 ~ 2023-10-12

Reviewed By:

Sunny Sun

Approved By:

Robin Wu



The test results relate only to the samples tested.

This equipment has been shown to be capable of compliance with the applicable technical standards as indicated in the measurement report and was tested in accordance with the measurement procedures specified in ANSI C63.26-2015. Test results reported herein relate only to the item(s) tested.

The test report shall not be reproduced except in full without the written approval of MRT Technology (Suzhou) Co., Ltd.

Revision History

Report No.	Version	Description	Issue Date	Note
2309RSU052-U7	V01	Initial Report	2023-10-26	Valid

Note: This report is prepared for FCC Class II permissive supplement to FCC ID: XMR2022EM060KGL adding LTE Band 42/43 and related data.

CONTENTS

Description	Page
1. General Information.....	5
1.1. Applicant	5
1.2. Manufacturer	5
1.3. Testing Facility	5
1.4. Product Information.....	6
1.5. Radio Specification under Testing.....	6
1.6. Description of Available Antennas.....	7
1.7. Test Methodology	7
2. Test Configuration	8
2.1. Test System Connection Diagram.....	8
2.2. Test Environment Condition	8
3. Measuring Instrument	9
4. Decision Rules and Measurement Uncertainty.....	10
4.1. Decision Rules	10
4.2. Measurement Uncertainty.....	10
5. Test Result.....	11
5.1. Summary.....	11
5.2. Occupied Bandwidth Measurement.....	12
5.2.1. Test Limit	12
5.2.2. Test Procedure.....	12
5.2.3. Test Setting	12
5.2.4. Test Setup	12
5.2.5. Test Result	12
5.3. Frequency Stability Measurement	13
5.3.1. Test Limit	13
5.3.2. Test Procedure.....	13
5.3.3. Test Setting	13
5.3.4. Test Setup	14
5.3.5. Test Result	14
5.4. Equivalent Isotropically Radiated Power Measurement	15
5.4.1. Test Limit	15
5.4.2. Test Procedure.....	15
5.4.3. Test Setting	16
5.4.4. Test Setup	16

5.4.5.	Test Result	16
5.5.	Peak to Average Ratio Measurement	17
5.5.1.	Test Limit	17
5.5.2.	Test Procedure	17
5.5.3.	Test Setting	17
5.5.4.	Test Setup	17
5.5.5.	Test Result	17
5.6.	Band Edge Measurement	18
5.6.1.	Test Limit	18
5.6.2.	Test Procedure	18
5.6.3.	Test Setting	19
5.6.4.	Test Setup	19
5.6.5.	Test Result	19
5.7.	Conducted Spurious Emissions Measurement.....	20
5.7.1.	Test Limit	20
5.7.2.	Test Procedure	20
5.7.3.	Test Setting	20
5.7.4.	Test Setup	21
5.7.5.	Test Result	21
5.8.	Radiated Spurious Emissions Measurement.....	22
5.8.1.	Test Limit	22
5.8.2.	Test Procedure	22
5.8.3.	Test Setting	22
5.8.4.	Test Setup	23
5.8.5.	Test Result	23
Appendix A - Test Result		24
A.1	Occupied Bandwidth Test Result	24
A.2	Frequency Stability Test Result.....	30
A.3	Equivalent Isotropically Radited Power Test Result.....	32
A.4	Peak to Average Radio Test Result	40
A.5	Band Edge Test Result	42
A.6	Conducted Spurious Emissions Test Result	50
A.7	Radiated Spurious Emissions Test Result	60
Appendix B - Test Setup Photograph		62
Appendix C - EUT Photograph		63

1.4. Product Information

Product Name	LTE-A Cat 6 M.2 Module
Model No.	EM060K-GL
Brand Name	Quectel
IMEI	Conducted sample: 867228050091049 Radiated sample: 857228050091213
3GPP Specification	WCDMA Band II/IV/V LTE FDD Band 2, 4, 5, 7, 12, 13, 14, 17, 25, 26, 30, 66, 71 LTE TDD Band 38, 41, 42, 43, 46, 48
GNSS Specification	GPS, GLONASS, Bei Dou, Galileo
Temperature Operating Range	-25 ~ 75 °C
Power Supply Rating	3.135 ~ 4.4Vdc, typical 3.7Vdc
Remark: The information of EUT was provided by the manufacturer, and the accuracy of the information shall be the responsibility of the manufacturer.	

1.5. Radio Specification under Testing

E-UTRA Specification	
TX Frequency Range	LTE Band 42: 3450 ~ 3550MHz, LTE Band 43: 3700 ~ 3800MHz
RX Frequency Range	LTE Band 42: 3450 ~ 3550MHz, LTE Band 43: 3700 ~ 3800MHz
Modulation	UL up to 16QAM & DL up to 64QAM
Power Class	3

1.6. Description of Available Antennas

Technology	Frequency Range (MHz)	Antenna Type	Max Peak Gain (dBi)
LTE Band 2	1850 ~ 1910	Dipole PIFA	0.25
LTE Band 4	1710 ~ 1755		1.47
LTE Band 5	824 ~ 849		1.10
LTE Band 7	2500 ~ 2570		2.40
LTE Band 12	699 ~ 716		1.30
LTE Band 13	777 ~ 787		1.30
LTE Band 14	788 ~ 798		1.30
LTE Band 17	704 ~ 716		1.30
LTE Band 25	1850 ~ 1915		0.25
LTE Band 26	814 ~ 849		1.30
LTE Band 30	2305 ~ 2315		-3.00
LTE Band 38	2570 ~ 2620		2.40
LTE Band 41	2496 ~ 2690		2.40
LTE Band 42	3450 ~ 3550		-1.80
LTE Band 43	3700 ~ 3800		0.60
LTE Band 48	3550 ~ 3700		0.60
LTE Band 66	1710 ~ 1780		1.47
LTE Band 71	663 ~ 698		1.22

Note 1: All antenna information (Antenna type and Peak Gain) is provided by the manufacturer.

Note 2: The typical antennas used to calculate the ERP (EIRP).

1.7. Test Methodology

According to the specifications of the manufacturer, the EUT must comply with the requirements of the following standards:

- ANSI C63.26:2015
- FCC CFR 47 Part 2, Part 27
- FCC KDB 971168 D01 v03r01: Power Meas License Digital Systems
- FCC KDB 971168 D02 v02r01: Misc Rev Approv License Devices
- FCC KDB 412172 D01 v01r01: Determining ERP and EIRP

2. Test Configuration

2.1. Test System Connection Diagram

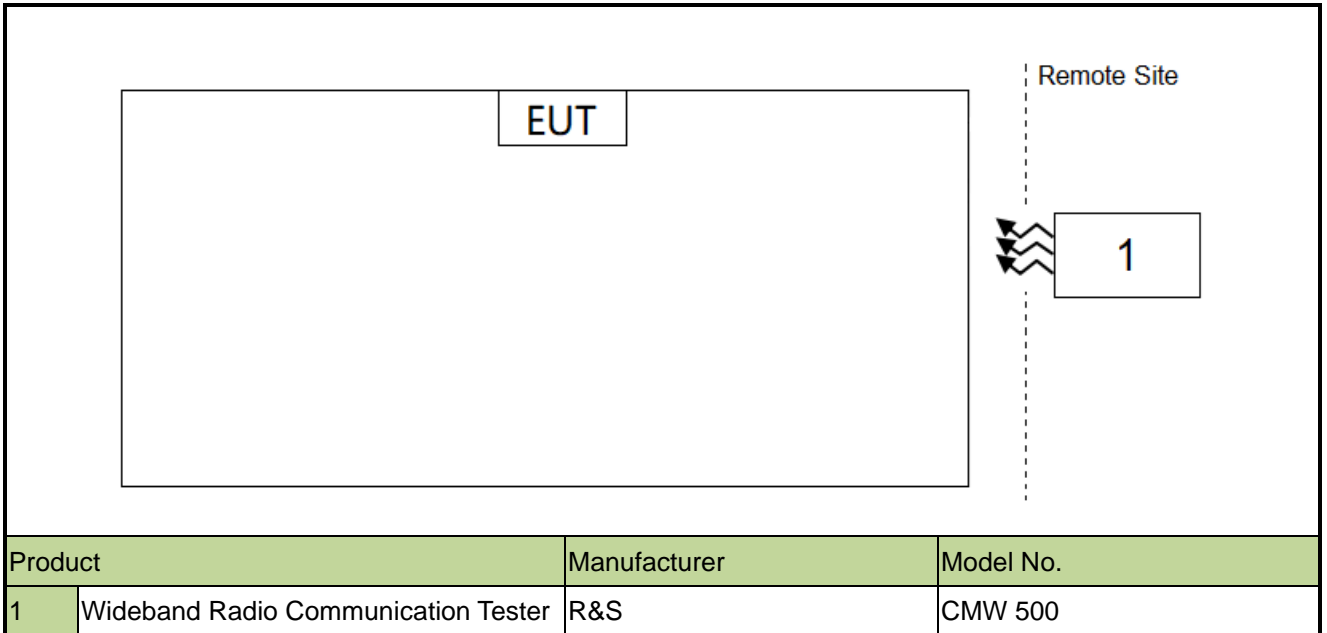

2.2. Test Environment Condition

Ambient Temperature	15 ~ 35°C
Relative Humidity	20% ~ 75%RH

3. Measuring Instrument

Instrument	Manufacturer	Model No.	Asset No.	Cali. Interval	Cali. Due Date	Test Site
TRILOG Antenna	Schwarzbeck	VULB 9162	MRTSUE06022	1 year	2024-05-15	WZ-AC2
Loop Antenna	Schwarzbeck	FMZB 1519	MRTSUE06025	1 year	2024-09-17	WZ-AC2
EMI Test Receiver	Agilent	N9038A	MRTSUE06125	1 year	2024-05-23	WZ-AC2
Thermohygrometer	Mingle	ETH529	MRTSUE06170	1 year	2023-11-27	WZ-AC2
Horn Antenna	Schwarzbeck	BBHA 9120D	MRTSUE06171	1 year	2023-10-13	WZ-AC2
Preamplifier	Schwarzbeck	BBV 9718	MRTSUE06176	1 year	2024-05-07	WZ-AC2
Anechoic Chamber	RIKEN	WZ-AC2	MRTSUE06213	1 year	2024-04-20	WZ-AC2
Horn Antenna	ETS	3117	MRTSUE06257	1 year	2024-09-23	WZ-AC2
Horn Antenna	Schwarzbeck	BBHA 9170	MRTSUE06597	1 year	2023-11-05	WZ-AC2
Preamplifier	EMCI	EMC184045SE	MRTSUE06640	1 year	2024-01-12	WZ-AC2
Preamplifier	EMCI	EMC051845SE	MRTSUE06987	1 year	2024-09-07	WZ-AC2
Thermohygrometer	testo	608-H1	MRTSUE11038	1 year	2023-11-01	WZ-AC2
Communication Tester	R&S	CMW500	MRTSUE06243	1 year	2024-09-27	SIP-SR1
Communication Tester	R&S	CMW500	MRTSUE06243	1 year	2023-10-08	SIP-SR1
Thermohygrometer	testo	622	MRTSUE06629	1 year	2024-01-03	SIP-SR1
Communication Tester	R&S	CMW500	MRTSUE06881	1 year	2024-05-23	SIP-SR1
DC POWER MODULE	Keysight	N6743B	MRTSUE06905	N/A	N/A	SIP-SR1
DC POWER MODULE	Keysight	N6743B	MRTSUE06906	N/A	N/A	SIP-SR1
Signal Analyzer	Keysight	N9021B	MRTSUE06915	1 year	2023-12-28	SIP-SR1
Temperature Chamber	BAOYT	BYG-80CL	MRTSUE06932	1 year	2024-02-12	SIP-SR1
Shielding Room	MIX-BEP	SIP-SR1	MRTSUE06948	N/A	N/A	SIP-SR1

Software	Version	Function
EMI Software	V3.0.0	EMI Test Software
Controller_MF 7802	2.03C	RE Antenna & Turntable

4. Decision Rules and Measurement Uncertainty

4.1. Decision Rules

The Decision Rule is based on Simple Acceptance in accordance with ISO Guide 98-4: 2012 Clause 8.2. (Measurement uncertainty is not taken into account when stating conformity with a specified requirement.)

4.2. Measurement Uncertainty

Where relevant, the following test uncertainty levels have been estimated for tests performed on the EUT as specified in CISPR 16-4-2. This uncertainty represents an expanded uncertainty expressed at approximately the 95% confidence level using a coverage factor of $k = 2$.

Radiated Spurious Emissions	
The maximum measurement uncertainty is evaluated as:	
Coaxial:	9kHz~30MHz: 2.59dB
Coplanar:	9kHz~30MHz: 2.60dB
Horizontal:	30MHz~200MHz: 3.85dB
	200MHz~1GHz: 4.36dB
	1GHz~40GHz: 4.98dB
Vertical:	30MHz~200MHz: 4.06dB
	200MHz~1GHz: 5.28dB
	1GHz~40GHz: 4.91dB
Conducted Spurious Emissions	
Measuring Uncertainty for a Level of Confidence of 95% ($U=2Uc(y)$):	
2.3dB	
Output Power	
Measuring Uncertainty for a Level of Confidence of 95% ($U=2Uc(y)$):	
1.5dB	
Occupied Bandwidth	
Measuring Uncertainty for a Level of Confidence of 95% ($U=2Uc(y)$):	
3.2%	
Frequency Stability	
Measuring Uncertainty for a Level of Confidence of 95% ($U=2Uc(y)$):	
79.9Hz	

5. Test Result

5.1. Summary

FCC Part Section(s)	Test Description	Test Condition	Test Result
2.1049	Occupied Bandwidth	Conducted	Pass
2.1055, 27.54	Frequency Stability		Pass
27.50(j)(3)(k)(3)	Equivalent Isotropic Radiated Power		Pass
27.50(j)(4)(k)(4)	Peak to Average Ratio		Pass
2.1051, 27.53(i)(n)	Band Edge		Pass
2.1051, 27.53(i)(n)	Spurious Emission		Pass
2.1051, 27.53(i)(n)	Spurious Emissions	Radiated	Pass

Notes:

- 1) The analyzer plots shown in this section were all taken with a correction table loaded into the analyzer. The correction table was used to account for the losses of the cables and attenuators used as part of the system to connect the EUT to the analyzer at all frequencies of interest.
- 2) All supported modulation types were evaluated. The worst-case emission of modulation was selected. Therefore, the Frequency Stability, Peak to Average Ratio, Channel Band Edge, Conducted Spurious Emission, Radiated Spurious Emission were presented the worst-case in the test report.
- 3) For radiated emission tests, every axis (X, Y, Z) was also verified. The test results shown in the following sections represent the worst-case emissions.

5.2. Occupied Bandwidth Measurement

5.2.1. Test Limit

The occupied bandwidth, that is the frequency bandwidth such that, below its lower and above its upper frequency limits, the mean powers radiated are each equal to 0.5 percent of the total mean power radiated by a given emission shall be measured.

5.2.2. Test Procedure

ANSI C63.26-2015 - Section 5.4

5.2.3. Test Setting

1. Set center frequency to the nominal EUT channel center frequency
2. RBW = The nominal RBW shall be in the range of 1% to 5% of the anticipated OBW
3. VBW $\geq 3 \times$ RBW
4. Detector = Peak
5. Trace mode = max hold
6. Sweep = auto couple
7. Allow the trace to stabilize
8. Use the 99% power bandwidth function of the instrument and report the measured bandwidth.

5.2.4. Test Setup

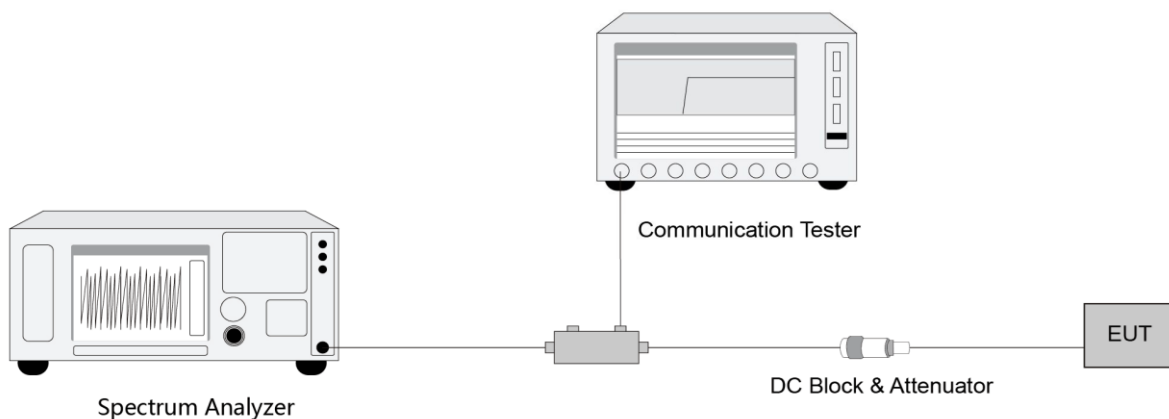

5.2.5. Test Result

Refer to Appendix A.1.

5.3. Frequency Stability Measurement

5.3.1. Test Limit

The frequency stability shall be measured by variation of ambient temperature and variation of primary supply voltage to ensure that the fundamental emission stays within the authorized frequency block. The frequency stability of the transmitter shall be maintained within $\pm 0.00025\%$ ($\pm 2.5\text{ppm}$) of the center frequency.

5.3.2. Test Procedure

ANSI C63.26-2015 - Section 5.4 & 5.6

5.3.3. Test Setting

1. Use the occupied bandwidth function of the instrument and record the low edge for low channel occupancy bandwidth and the high edge for high channel occupancy bandwidth.
2. Change the temperature of equipment and repeat Steps 1.
3. Change the Voltage of equipment and repeat Steps 1.
4. Use the frequency error function of the instrument and record the frequency error.
5. Change the temperature of equipment and repeat Steps 4.
6. Change the Voltage of equipment and repeat Steps 4.

Frequency Stability Under Temperature Variations:

The equipment under test was connected to an external AC or DC power supply and input rated voltage. RF output was connected to a frequency counter or spectrum analyzer via feed through attenuators. The EUT was placed inside the temperature chamber. Set the spectrum analyzer RBW low enough to obtain the desired frequency resolution and measure EUT 20°C operating frequency as reference frequency. Turn EUT off and set the chamber temperature to highest. After the temperature stabilized for approximately 30 minutes recorded the frequency. Repeat step measure with 10°C decreased per stage until the lowest temperature reached.

Frequency Stability Under Voltage Variations:

Set chamber temperature to 20°C. Use a variable AC power supply / DC power source to power the EUT and set the voltage to rated voltage. Set the spectrum analyzer RBW low enough to obtain the desired frequency resolution and recorded the frequency.

Reduce the input voltage to specify extreme voltage variation ($\pm 15\%$) and endpoint, record the maximum frequency change.

5.3.4. Test Setup

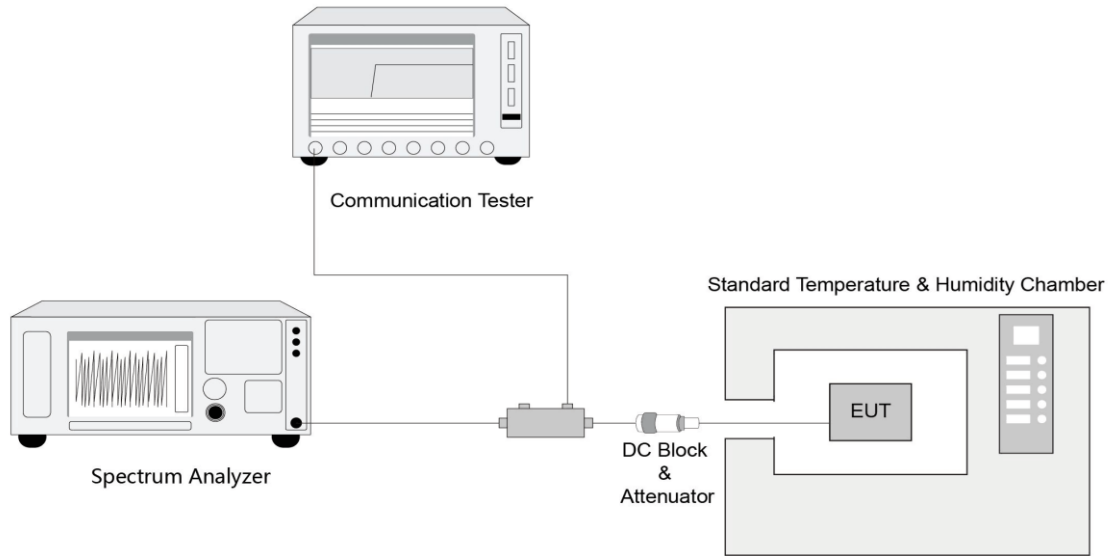

5.3.5. Test Result

Refer to Appendix A.2.

5.4. Equivalent Isotropically Radiated Power Measurement

5.4.1. Test Limit

Band 42:

Mobile devices are limited to 1Watt (30 dBm) EIRP. Mobile devices operating in these bands must employ a means for limiting power to the minimum necessary for successful communications.

Band 43:

Mobile and portable stations are limited to 1 Watt EIRP. Mobile and portable stations operating in these bands must employ a means for limiting power to the minimum necessary for successful communications.

5.4.2. Test Procedure

ANSI C63.26-2015 - Section 5.2

5.4.3. Test Setting

Average power measurements were performed only when the EUT was transmitting at its maximum power control level using a broadband power meter with a pulse sensor. The power meter implemented triggering and gating capabilities which were set up such that power measurements were recorded only during the ON time of the transmitter.

The relevant equation for determining the maximum ERP or EIRP from the measured RF output power is given in Equation (1) as follows:

$$\text{ERP or EIRP} = P_{\text{Meas}} + G_T$$

where

ERP or EIRP effective radiated power or equivalent isotropically radiated power, respectively (expressed in the same units as P_{Meas} , e.g., dBm or dBW)

P_{Meas} measured transmitter output power or PSD, in dBm or dBW

G_T gain of the transmitting antenna, in dBd (ERP) or dBi (EIRP)

$$\text{ERP} = \text{EIRP} - 2.15$$

5.4.4. Test Setup

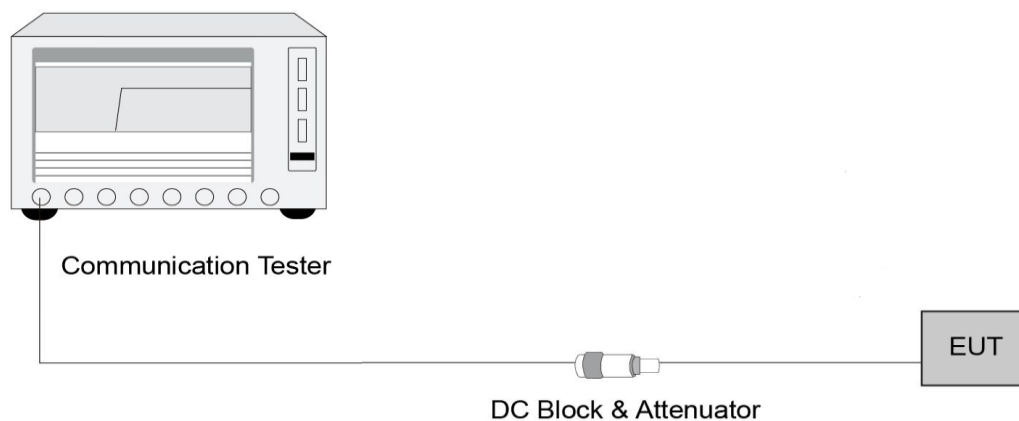

5.4.5. Test Result

Refer to Appendix A.3.

5.5. Peak to Average Ratio Measurement

5.5.1. Test Limit

A peak to average ratio measurement is performed at the conducted port of the EUT. The spectrum analyzers Complementary Cumulative Distribution Function (CCDF) measurement profile is used to determine the largest deviation between the average and the peak power of the EUT in a given bandwidth. The CCDF curve shows how much time the peak waveform spends at or above a given average power level. The percent of time the signal spends at or above the level defines the probability for that particular power level.

5.5.2. Test Procedure

ANSI C63.26-2015 - Section 5.2.3.4 (CCDF).

5.5.3. Test Setting

1. Set the resolution / measurement bandwidth \geq signal's occupied bandwidth
2. Set the number of counts to a value that stabilizes the measured CCDF curve
3. Record the maximum PARR level associated with a probability of 0.1%

5.5.4. Test Setup

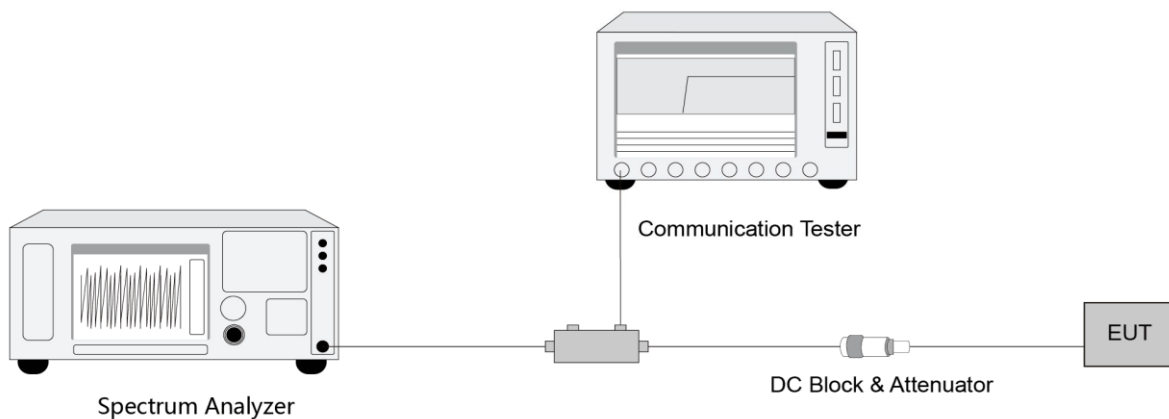

5.5.5. Test Result

Refer to Appendix A.4

5.6. Band Edge Measurement

5.6.1. Test Limit

27.53 (i)

For mobile operations in the 3700–3980 MHz band, the conducted power of any emission outside the licensee's authorized bandwidth shall not exceed -13 dBm/MHz. In the 1 megahertz bands immediately outside and adjacent to the licensee's frequency block, the minimum resolution bandwidth for the measurement shall be either one percent of the emission bandwidth of the fundamental emission of the transmitter or 350 kHz. In the bands between 1 and 5 MHz removed from the licensee's frequency block, the minimum resolution bandwidth for the measurement shall be 500 kHz.

27.53 (n)

For mobile operations in the 3450–3550 MHz band, the conducted power of any emission outside the licensee's authorized bandwidth shall not exceed -13 dBm/MHz. In the 1 megahertz bands immediately outside and adjacent to the licensee's frequency block, a resolution bandwidth of at least one percent of the emission bandwidth of the fundamental emission of the transmitter may be employed, but limited to a maximum of 200 kHz. In the bands between 1 and 5 MHz removed from the licensee's frequency block, the minimum resolution bandwidth for the measurement shall be 500 kHz.

5.6.2. Test Procedure

ANSI C63.26-2015 - Section 5.7

5.6.3. Test Setting

1. Set the analyzer frequency to low or high channel
2. $RBW \geq$ The nominal RBW shall be in the range of 1% of the anticipated OBW (in the 1MHz band immediately outside and adjacent to the band edge). For improvement of the accuracy in the measurement of the average power of a noise-like emission, a RBW narrower than the specified reference bandwidth can be used (generally limited to no less than 1% of the OBW), provided that a subsequent integration is performed over the full required measurement bandwidth. This integration should be performed using the spectrum analyzer's band power functions.
3. $VBW \geq 3 \cdot RBW$
4. Sweep time = auto
5. Detector = power averaging (rms)
6. Set sweep trigger to "free run."
7. User gate triggered such that the analyzer only sweeps when the device is transmitting at full power
8. Trace average at least 100 traces in power averaging (rms) mode if sweep is set to auto-couple. To accurately determine the average power over the on and off time of the transmitter, it can be necessary to increase the number of traces to be averaged above 100, or if using a manually configured sweep time, increase the sweep time.

5.6.4. Test Setup

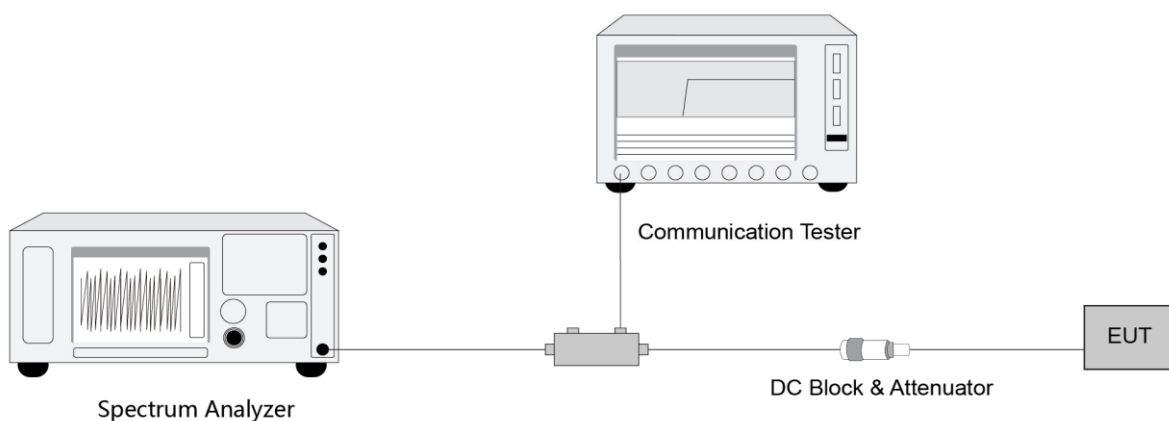

5.6.5. Test Result

Refer to Appendix A.5.

5.7. Conducted Spurious Emissions Measurement

5.7.1. Test Limit

The level of the carrier and the various conducted spurious and harmonic frequencies is measured by means of a calibrated spectrum analyzer. The spectrum is scanned from the lowest frequency generated in the equipment up to a frequency including its 10th harmonic. All out of band emissions are measured with a spectrum analyzer connected to the antenna terminal of the EUT while the EUT is operating at its maximum duty cycle, at maximum power, and at the appropriate frequencies. All data rates were investigated to determine the worst-case configuration. All modes of operation were investigated and the worst-case configuration results are reported in this section.

The power of any emission outside of the authorized operating frequency ranges must be attenuated below the transmitting power (P) by a factor of at least $43 + 10 \log(P)$ dB.

5.7.2. Test Procedure

ANSI C63.26-2015 - Section 5.7

5.7.3. Test Setting

1. Set the analyzer frequency to low, mid, high channel.
2. RBW = 1MHz
3. VBW $\geq 3 \cdot$ RBW
4. Sweep time = auto
5. Detector = power averaging (rms)
6. Set sweep trigger to "free run."
7. User gate triggered such that the analyzer only sweeps when the device is transmitting at full power.
8. Trace average at least 100 traces in power averaging (rms) mode if sweep is set to auto-couple. To accurately determine the average power over the on and off time of the transmitter, it can be necessary to increase the number of traces to be averaged above 100, or if using a manually configured sweep time, increase the sweep time.

5.7.4. Test Setup

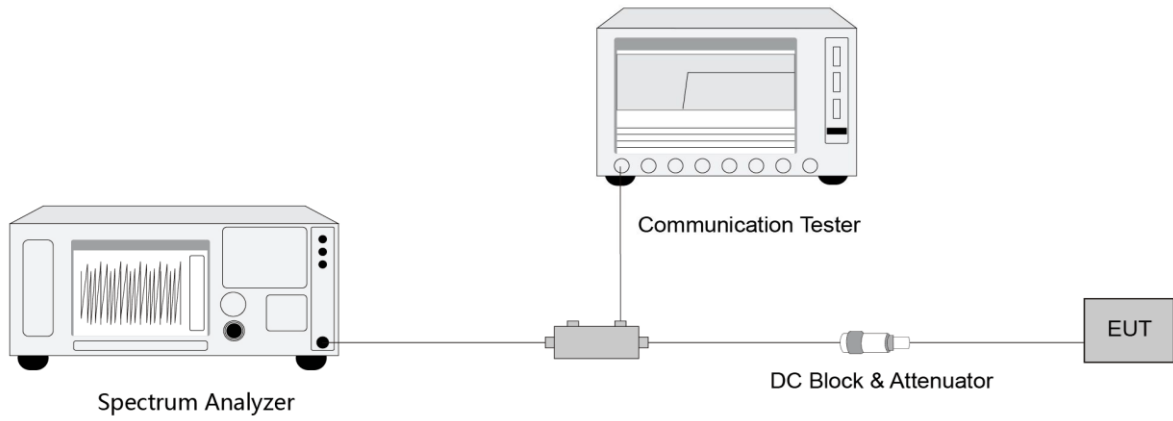

5.7.5. Test Result

Refer to Appendix A.6

5.8. Radiated Spurious Emissions Measurement

5.8.1. Test Limit

The power of any emission outside of the authorized operating frequency ranges must be attenuated below the transmitting power (P) by a factor of at least $43 + 10 \log(P)$ dB. The emission limit equal to -13dBm.

E (dB μ V/m) = EIRP (dBm) - 20 log D + 104.8; where D is the measurement distance in meters. The emission limit equal to 82.3dB μ V/m or 55.3dB μ V/m.

5.8.2. Test Procedure

ANSI C63.26-2015 - Section 5.2.7 & 5.5

5.8.3. Test Setting

1. RBW = 1MHz
2. VBW \geq 3*RBW
3. Sweep time \geq 10 \times (number of points in sweep) \times (transmission symbol period)
4. Detector = Peak
5. Trace mode = max hold
6. The trace was allowed to stabilize

5.8.4. Test Setup

Below 1GHz Test Setup:

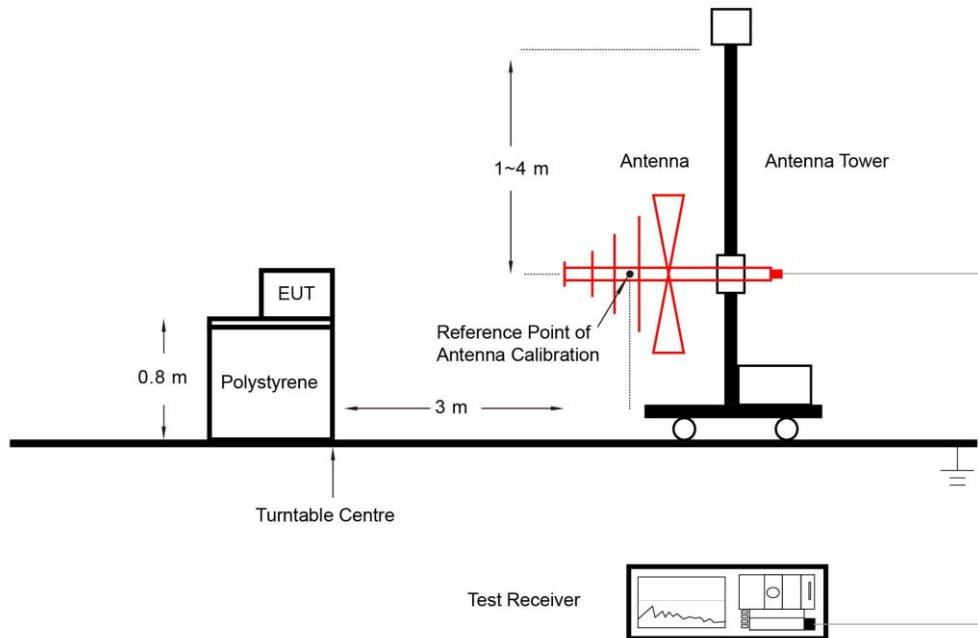

Above 1GHz Test Setup:

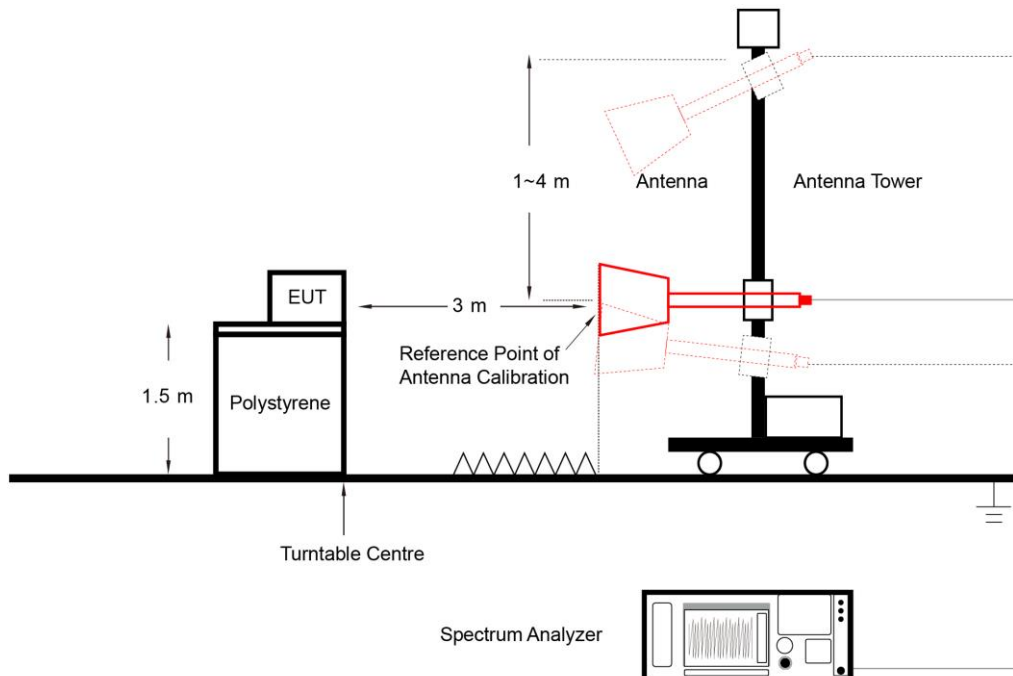

5.8.5. Test Result

Refer to Appendix A.7.

Appendix A - Test Result

A.1 Occupied Bandwidth Test Result

Test Site	SIP-SR1	Test Engineer	Yoniter Yang
Test Date	2023-10-08	Test Band	Band 42

Modulation	Bandwidth (MHz)	Frequency (MHz)	99% Bandwidth (MHz)
QPSK	5	3500.00	4.47
	10		8.94
	15		13.40
	20		17.88
16QAM	5		4.46
	10		8.95
	15		13.42
	20		17.87

99% Bandwidth - QPSK

5MHz Channel Bandwidth



10MHz Channel Bandwidth

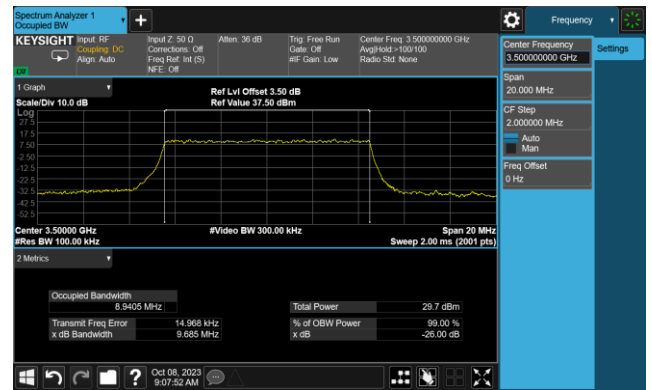

15MHz Channel Bandwidth



20MHz Channel Bandwidth

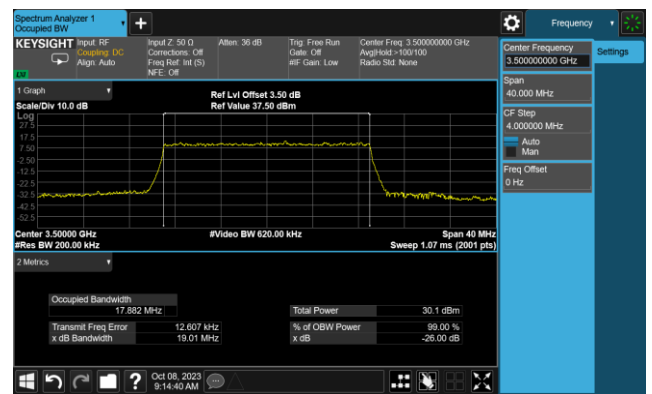

99% Bandwidth - 16QAM

5MHz Channel Bandwidth

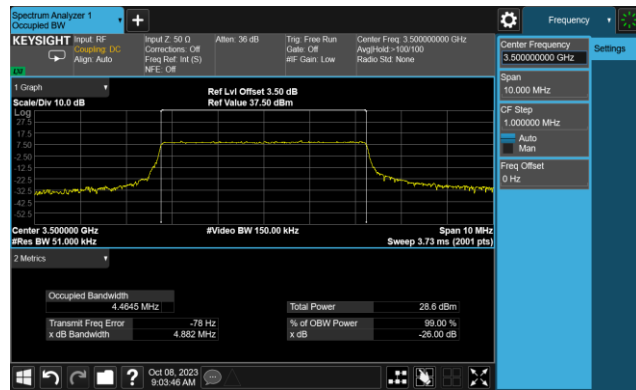

10MHz Channel Bandwidth

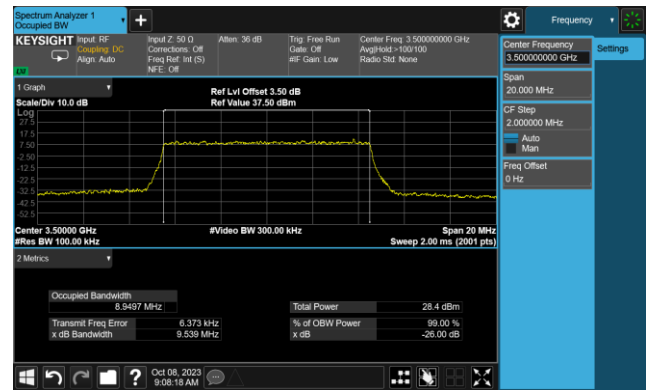

15MHz Channel Bandwidth

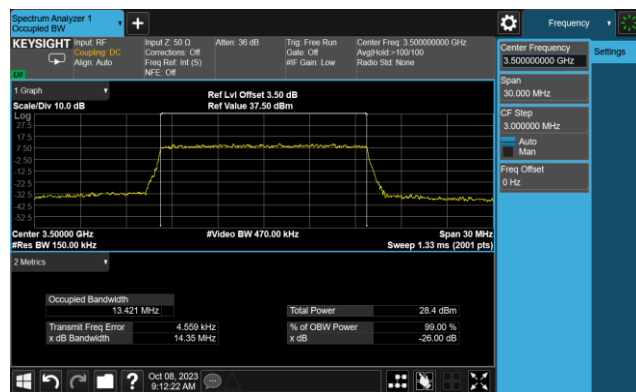

20MHz Channel Bandwidth

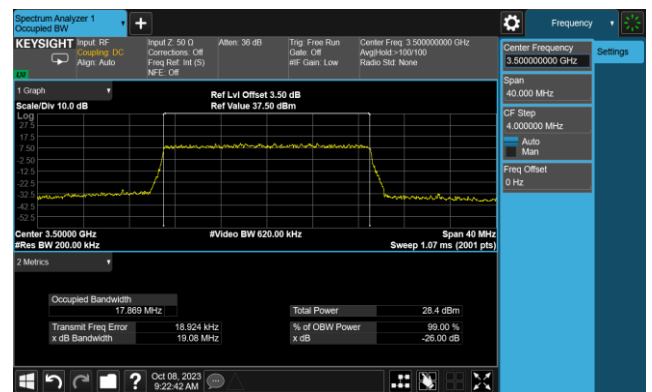

Test Site	SIP-SR1	Test Engineer	Yoniter Yang
Test Date	2023-10-08	Test Band	Band 43

Modulation	Bandwidth (MHz)	Frequency (MHz)	99% Bandwidth (MHz)
QPSK	5	3750.00	4.48
	10		8.96
	15		13.43
	20		17.81
16QAM	5		4.45
	10		8.94
	15		13.41
	20		17.90

99% Bandwidth - QPSK

5MHz Channel Bandwidth

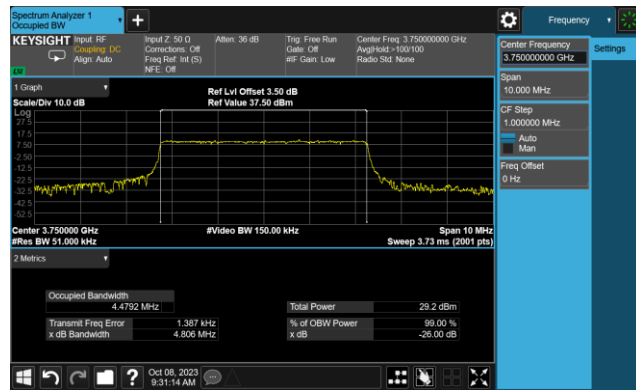

10MHz Channel Bandwidth

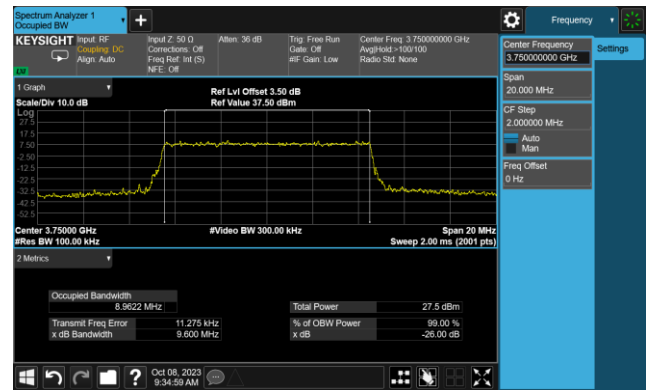

15MHz Channel Bandwidth

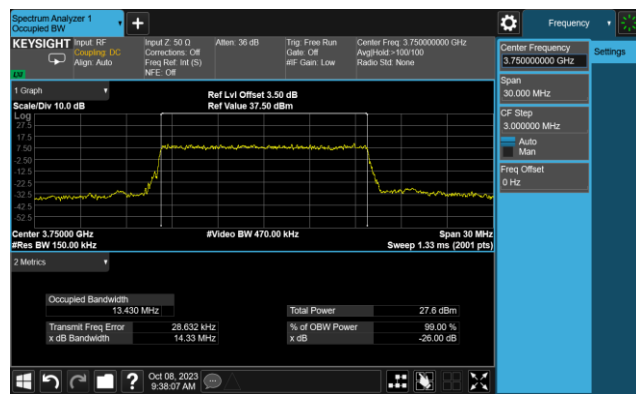

20MHz Channel Bandwidth

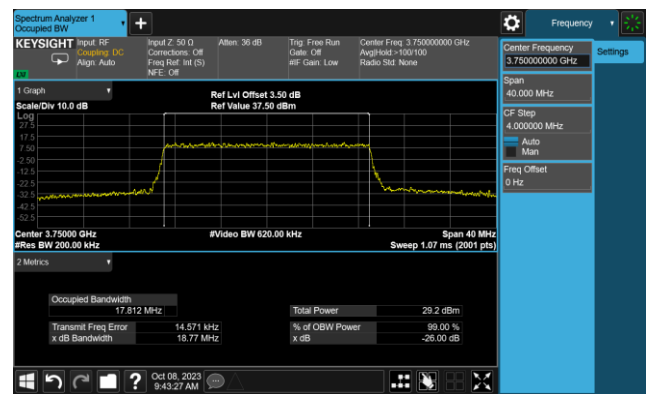

99% Bandwidth - 16QAM

5MHz Channel Bandwidth

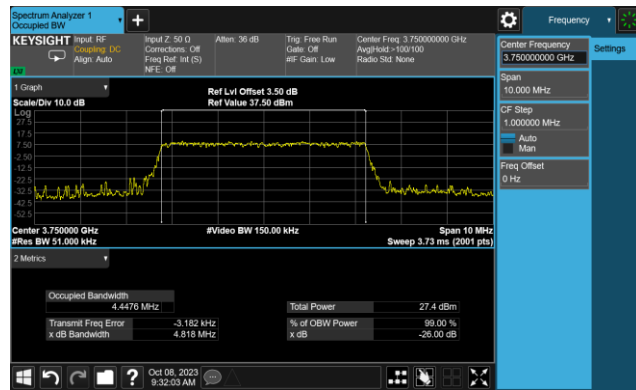

10MHz Channel Bandwidth

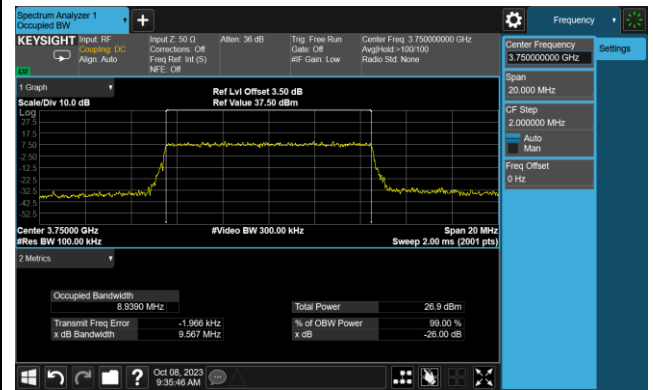

15MHz Channel Bandwidth

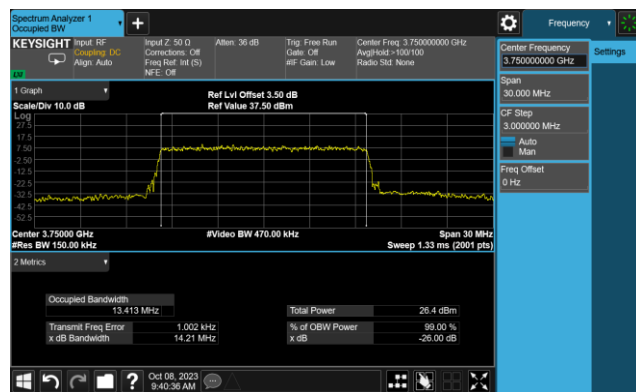

20MHz Channel Bandwidth

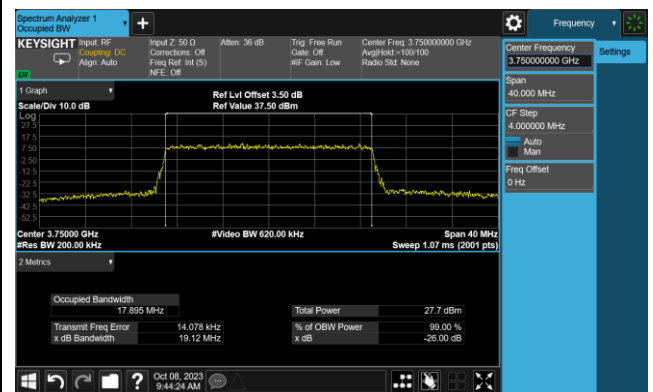

A.2 Frequency Stability Test Result

Test Site	SIP-TR1	Test Engineer	Yoniter Yang
Test Date	2023-10-09 ~ 2023-10-12	Test Band	LTE Band 42

Voltage	Temp (°C)	Frequency Range (MHz)		Frequency stability (ppm)	Within Authorized Frequency Block
		3450	3550		
		f _L	f _H		
Normal	+ 20 (Ref)	3451.0979	3548.9499	0.0000	Pass
	+ 50	3451.0979	3548.9499	0.0000	Pass
	+ 40	3451.0979	3548.9499	0.0011	Pass
	+ 30	3451.0979	3548.9499	0.0012	Pass
	+ 10	3451.0979	3548.9499	0.0007	Pass
	0	3451.0979	3548.9499	0.0014	Pass
	- 10	3451.0979	3548.9499	0.0080	Pass
	- 20	3451.0979	3548.9499	0.0021	Pass
- 30	3451.0979	3548.9499	0.0017	Pass	
15%	+ 20	3451.0979	3548.9499	0.0009	Pass
-15%	+ 20	3451.0979	3548.9499	0.0002	Pass

Test Site	SIP-TR1	Test Engineer	Yoniter Yang
Test Date	2023-10-09 ~ 2023-10-12	Test Band	LTE Band 43

Voltage	Temp (°C)	Frequency Range (MHz)		Frequency stability (ppm)	Within Authorized Frequency Block
		3700	3800		
		f _L	f _H		
Normal	+ 20 (Ref)	3701.0691	3798.9371	0.0000	Pass
	+ 50	3701.0691	3798.9371	0.0004	Pass
	+ 40	3701.0691	3798.9371	0.0007	Pass
	+ 30	3701.0691	3798.9371	-0.0001	Pass
	+ 10	3701.0691	3798.9371	0.0006	Pass
	0	3701.0691	3798.9371	-0.0001	Pass
	- 10	3701.0691	3798.9371	-0.0007	Pass
	- 20	3701.0691	3798.9371	-0.0004	Pass
- 30	3701.0691	3798.9371	0.0005	Pass	
15%	+ 20	3701.0691	3798.9371	0.0001	Pass
-15%	+ 20	3701.0691	3798.9371	0.0009	Pass

A.3 Equivalent Isotropically Radited Power Test Result

Test Site	SIP-SR1	Test Engineer	Yoniter Yang
Test Date	2023-09-25 ~ 2023-10-10	Test Band	LTE Band 42

Channel Bandwidth (MHz)	Frequency (MHz)	RB Size	RB Offset	Output Power (dBm)	EIRP (dBm)	Limit (dBm)
QPSK						
5	3452.50	1	0	21.42	19.62	< 30.00
	3500.00			21.31	19.51	< 30.00
	3547.50			21.42	19.62	< 30.00
5	3452.50	1	12	21.43	19.63	< 30.00
	3500.00			21.33	19.53	< 30.00
	3547.50			21.44	19.64	< 30.00
5	3452.50	1	24	21.39	19.59	< 30.00
	3500.00			21.28	19.48	< 30.00
	3547.50			21.39	19.59	< 30.00
5	3452.50	25	0	20.38	18.58	< 30.00
	3500.00			20.29	18.49	< 30.00
	3547.50			20.41	18.61	< 30.00
10	3455.00	1	0	21.44	19.64	< 30.00
	3500.00			21.33	19.53	< 30.00
	3545.00			21.29	19.49	< 30.00
10	3455.00	1	24	21.41	19.61	< 30.00
	3500.00			21.29	19.49	< 30.00
	3545.00			21.31	19.51	< 30.00
10	3455.00	1	49	21.43	19.63	< 30.00
	3500.00			21.29	19.49	< 30.00
	3545.00			21.38	19.58	< 30.00
10	3455.00	50	0	20.45	18.65	< 30.00
	3500.00			20.31	18.51	< 30.00
	3545.00			20.37	18.57	< 30.00

Note: The ERP (dBm) = Output Power (dBm) + Antenna Gain (dBi)

Channel Bandwidth (MHz)	Frequency (MHz)	RB Size	RB Offset	Output Power (dBm)	EIRP (dBm)	Limit (dBm)
QPSK						
15	3457.50	1	0	21.39	19.59	< 30.00
	3500.00			21.32	19.52	< 30.00
	3542.50			21.28	19.48	< 30.00
15	3457.50	1	37	21.38	19.58	< 30.00
	3500.00			21.29	19.49	< 30.00
	3542.50			21.31	19.51	< 30.00
15	3457.50	1	74	21.45	19.65	< 30.00
	3500.00			21.33	19.53	< 30.00
	3542.50			21.39	19.59	< 30.00
15	3457.50	75	0	20.42	18.62	< 30.00
	3500.00			20.34	18.54	< 30.00
	3542.50			20.41	18.61	< 30.00
20	3460.00	1	0	21.39	19.59	< 30.00
	3500.00			21.38	19.58	< 30.00
	3540.00			21.29	19.49	< 30.00
20	3460.00	1	49	21.33	19.53	< 30.00
	3500.00			21.32	19.52	< 30.00
	3540.00			21.31	19.51	< 30.00
20	3460.00	1	99	21.38	19.58	< 30.00
	3500.00			21.41	19.61	< 30.00
	3540.00			21.46	19.66	< 30.00
20	3460.00	100	0	20.39	18.59	< 30.00
	3500.00			20.36	18.56	< 30.00
	3540.00			20.35	18.55	< 30.00

Note: The ERP (dBm) = Output Power (dBm) + Antenna Gain (dBi)

Channel Bandwidth (MHz)	Frequency (MHz)	RB Size	RB Offset	Output Power (dBm)	EIRP (dBm)	Limit (dBm)
16QAM						
5	3452.50	1	0	20.63	18.83	< 30.00
	3500.00			20.69	18.89	< 30.00
	3547.50			20.53	18.73	< 30.00
5	3452.50	1	12	20.64	18.84	< 30.00
	3500.00			20.73	18.93	< 30.00
	3547.50			20.60	18.80	< 30.00
5	3452.50	1	24	20.57	18.77	< 30.00
	3500.00			20.68	18.88	< 30.00
	3547.50			20.51	18.71	< 30.00
5	3452.50	25	0	19.62	17.82	< 30.00
	3500.00			19.39	17.59	< 30.00
	3547.50			19.54	17.74	< 30.00
10	3455.00	1	0	20.46	18.66	< 30.00
	3500.00			20.53	18.73	< 30.00
	3545.00			20.65	18.85	< 30.00
10	3455.00	1	24	20.48	18.68	< 30.00
	3500.00			20.48	18.68	< 30.00
	3545.00			20.66	18.86	< 30.00
10	3455.00	1	49	20.51	18.71	< 30.00
	3500.00			20.50	18.70	< 30.00
	3545.00			20.75	18.95	< 30.00
10	3455.00	50	0	19.57	17.77	< 30.00
	3500.00			19.44	17.64	< 30.00
	3545.00			19.52	17.72	< 30.00

Note: The ERP (dBm) = Output Power (dBm) + Antenna Gain (dBi)

Channel Bandwidth (MHz)	Frequency (MHz)	RB Size	RB Offset	Output Power (dBm)	EIRP (dBm)	Limit (dBm)
16QAM						
15	3457.50	1	0	20.77	18.97	< 30.00
	3500.00			20.60	18.80	< 30.00
	3542.50			20.35	18.55	< 30.00
15	3457.50	1	37	20.75	18.95	< 30.00
	3500.00			20.55	18.75	< 30.00
	3542.50			20.41	18.61	< 30.00
15	3457.50	1	74	20.83	19.03	< 30.00
	3500.00			20.60	18.80	< 30.00
	3542.50			20.52	18.72	< 30.00
15	3457.50	75	0	19.61	17.81	< 30.00
	3500.00			19.37	17.57	< 30.00
	3542.50			19.50	17.70	< 30.00
20	3460.00	1	0	20.53	18.73	< 30.00
	3500.00			20.76	18.96	< 30.00
	3540.00			20.45	18.65	< 30.00
20	3460.00	1	49	20.52	18.72	< 30.00
	3500.00			20.65	18.85	< 30.00
	3540.00			20.51	18.71	< 30.00
20	3460.00	1	99	20.57	18.77	< 30.00
	3500.00			20.76	18.96	< 30.00
	3540.00			20.65	18.85	< 30.00
20	3460.00	100	0	19.60	17.80	< 30.00
	3500.00			19.51	17.71	< 30.00
	3540.00			19.52	17.72	< 30.00

Note: The ERP (dBm) = Output Power (dBm) + Antenna Gain (dBi)

Test Site	SIP-SR1	Test Engineer	Yoniter Yang
Test Date	2023-09-25 ~ 2023-10-10	Test Band	LTE Band 43

Channel Bandwidth (MHz)	Frequency (MHz)	RB Size	RB Offset	Output Power (dBm)	EIRP (dBm)	Limit (dBm)
QPSK						
5	3702.50	1	0	21.29	21.89	< 30.00
	3750.00			21.45	22.05	< 30.00
	3797.50			21.32	21.92	< 30.00
5	3702.50	1	12	21.32	21.92	< 30.00
	3750.00			21.56	22.16	< 30.00
	3797.50			21.34	21.94	< 30.00
5	3702.50	1	24	21.25	21.85	< 30.00
	3750.00			21.48	22.08	< 30.00
	3797.50			21.28	21.88	< 30.00
5	3702.50	25	0	20.27	20.87	< 30.00
	3750.00			20.39	20.99	< 30.00
	3797.50			20.28	20.88	< 30.00
10	3705.00	1	0	21.28	21.88	< 30.00
	3750.00			21.39	21.99	< 30.00
	3795.00			21.38	21.98	< 30.00
10	3705.00	1	24	21.29	21.89	< 30.00
	3750.00			21.47	22.07	< 30.00
	3795.00			21.32	21.92	< 30.00
10	3705.00	1	49	21.26	21.86	< 30.00
	3750.00			21.43	22.03	< 30.00
	3795.00			21.34	21.94	< 30.00
10	3705.00	50	0	20.29	20.89	< 30.00
	3750.00			20.41	21.01	< 30.00
	3795.00			20.35	20.95	< 30.00

Note: The ERP (dBm) = Output Power (dBm) + Antenna Gain (dBi)

Channel Bandwidth (MHz)	Frequency (MHz)	RB Size	RB Offset	Output Power (dBm)	EIRP (dBm)	Limit (dBm)
QPSK						
15	3707.50	1	0	21.32	21.92	< 30.00
	3750.00			21.37	21.97	< 30.00
	3792.50			21.34	21.94	< 30.00
15	3707.50	1	37	21.26	21.86	< 30.00
	3750.00			21.44	22.04	< 30.00
	3792.50			21.32	21.92	< 30.00
15	3707.50	1	74	21.31	21.91	< 30.00
	3750.00			21.48	22.08	< 30.00
	3792.50			21.35	21.95	< 30.00
15	3707.50	75	0	20.29	20.89	< 30.00
	3750.00			20.38	20.98	< 30.00
	3792.50			20.30	20.90	< 30.00
20	3710.00	1	0	21.34	21.94	< 30.00
	3750.00			21.43	22.03	< 30.00
	3790.00			21.37	21.97	< 30.00
20	3710.00	1	49	21.29	21.89	< 30.00
	3750.00			21.46	22.06	< 30.00
	3790.00			21.28	21.88	< 30.00
20	3710.00	1	99	21.38	21.98	< 30.00
	3750.00			21.50	22.10	< 30.00
	3790.00			21.30	21.90	< 30.00
20	3710.00	100	0	20.29	20.89	< 30.00
	3750.00			20.44	21.04	< 30.00
	3790.00			20.37	20.97	< 30.00

Note: The ERP (dBm) = Output Power (dBm) + Antenna Gain (dBi)

Channel Bandwidth (MHz)	Frequency (MHz)	RB Size	RB Offset	Output Power (dBm)	EIRP (dBm)	Limit (dBm)
16QAM						
5	3702.50	1	0	20.49	21.09	< 30.00
	3750.00			20.39	20.99	< 30.00
	3797.50			20.29	20.89	< 30.00
5	3702.50	1	12	20.51	21.11	< 30.00
	3750.00			20.52	21.12	< 30.00
	3797.50			20.35	20.95	< 30.00
5	3702.50	1	24	20.45	21.05	< 30.00
	3750.00			20.48	21.08	< 30.00
	3797.50			20.23	20.83	< 30.00
5	3702.50	25	0	19.21	19.81	< 30.00
	3750.00			19.39	19.99	< 30.00
	3797.50			19.25	19.85	< 30.00
10	3705.00	1	0	20.29	20.89	< 30.00
	3750.00			20.54	21.14	< 30.00
	3795.00			20.18	20.78	< 30.00
10	3705.00	1	24	20.26	20.86	< 30.00
	3750.00			20.59	21.19	< 30.00
	3795.00			20.11	20.71	< 30.00
10	3705.00	1	49	20.30	20.90	< 30.00
	3750.00			20.61	21.21	< 30.00
	3795.00			20.13	20.73	< 30.00
10	3705.00	50	0	19.23	19.83	< 30.00
	3750.00			19.35	19.95	< 30.00
	3795.00			19.29	19.89	< 30.00

Note: The ERP (dBm) = Output Power (dBm) + Antenna Gain (dBi)

Channel Bandwidth (MHz)	Frequency (MHz)	RB Size	RB Offset	Output Power (dBm)	EIRP (dBm)	Limit (dBm)
16QAM						
15	3707.50	1	0	20.49	21.09	< 30.00
	3750.00			20.53	21.13	< 30.00
	3792.50			20.72	21.32	< 30.00
15	3707.50	1	37	20.47	21.07	< 30.00
	3750.00			20.60	21.20	< 30.00
	3792.50			20.62	21.22	< 30.00
15	3707.50	1	74	20.57	21.17	< 30.00
	3750.00			20.64	21.24	< 30.00
	3792.50			20.72	21.32	< 30.00
15	3707.50	75	0	19.29	19.89	< 30.00
	3750.00			19.62	20.22	< 30.00
	3792.50			19.51	20.11	< 30.00
20	3710.00	1	0	20.61	21.21	< 30.00
	3750.00			20.64	21.24	< 30.00
	3790.00			20.49	21.09	< 30.00
20	3710.00	1	49	20.56	21.16	< 30.00
	3750.00			20.73	21.33	< 30.00
	3790.00			20.43	21.03	< 30.00
20	3710.00	1	99	20.65	21.25	< 30.00
	3750.00			20.77	21.37	< 30.00
	3790.00			20.39	20.99	< 30.00
20	3710.00	100	0	19.31	19.91	< 30.00
	3750.00			19.61	20.21	< 30.00
	3790.00			19.52	20.12	< 30.00

Note: The ERP (dBm) = Output Power (dBm) + Antenna Gain (dBi)

A.4 Peak to Average Radio Test Result

Test Site	SIP-SR1	Test Engineer	Yoniter Yang
Test Date	2023-10-08	Test Band	Band 42

Channel Bandwidth (MHz)	Frequency (MHz)	Peak to Average Ratio (dB)	Limit (dB)	Result
QPSK				
20	3500.00	5.40	≤ 13.00	Pass
16QAM				
20	3500.00	6.21	≤ 13.00	Pass

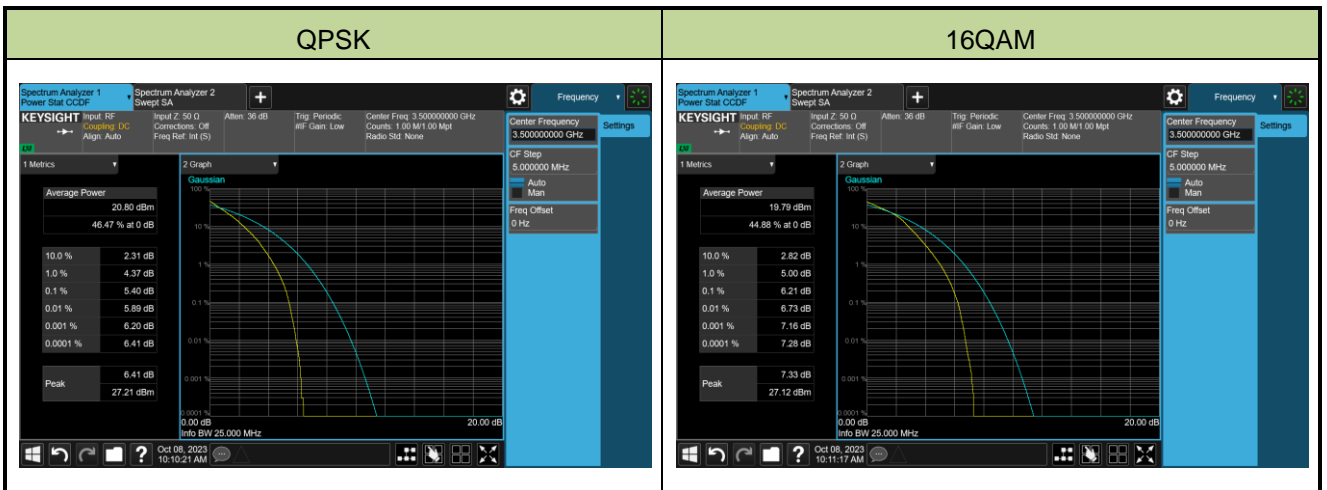

Test Site	SIP-SR1	Test Engineer	Yoniter Yang
Test Date	2023-10-08	Test Band	Band 43

Frequency (MHz)	Channel Bandwidth (MHz)	Peak to Average Ratio (dB)	Limit (dB)	Result
QPSK				
20	3750.00	5.52	≤ 13.00	Pass
16QAM				
20	3750.00	6.38	≤ 13.00	Pass

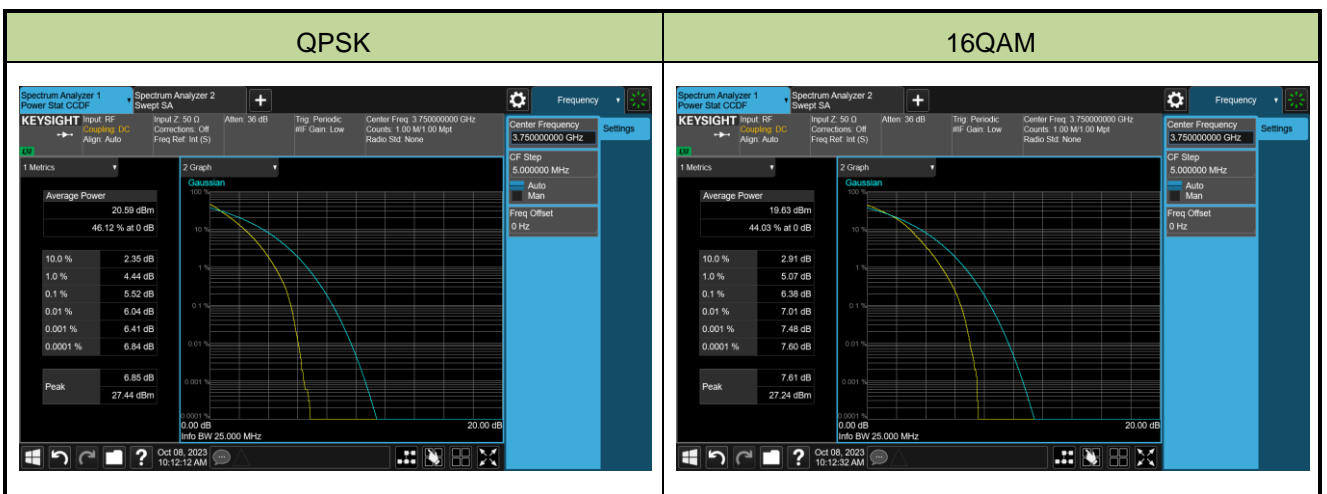

A.5 Band Edge Test Result

Test Site	SIP-SR1	Test Engineer	Yoniter Yang
Test Date	2023-10-11	Test Band	LTE Band 42

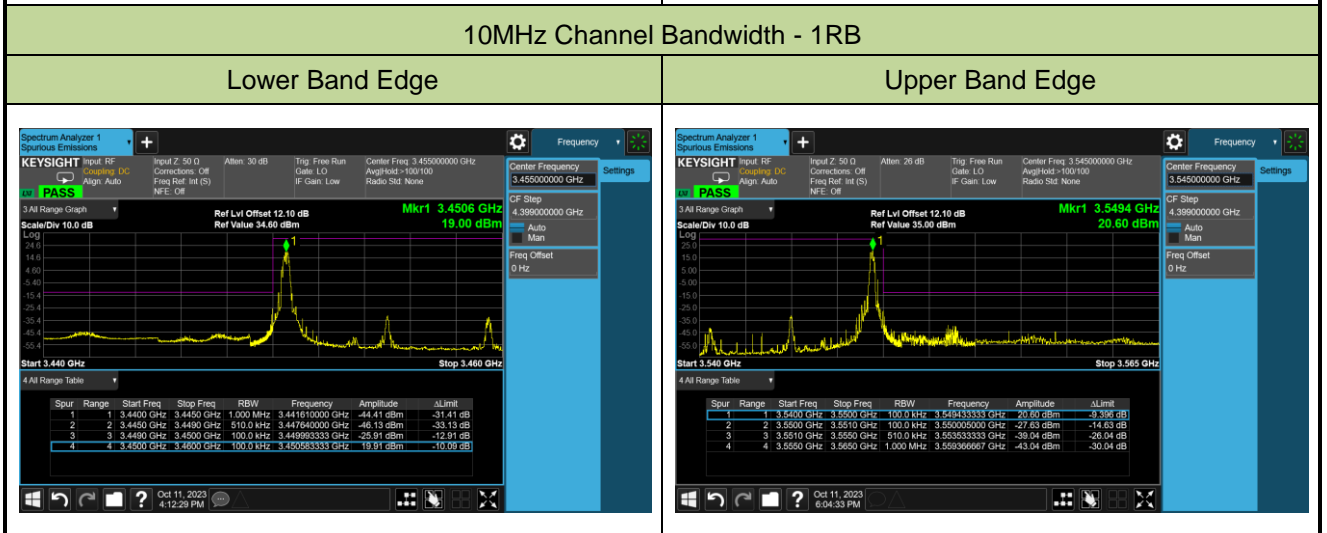
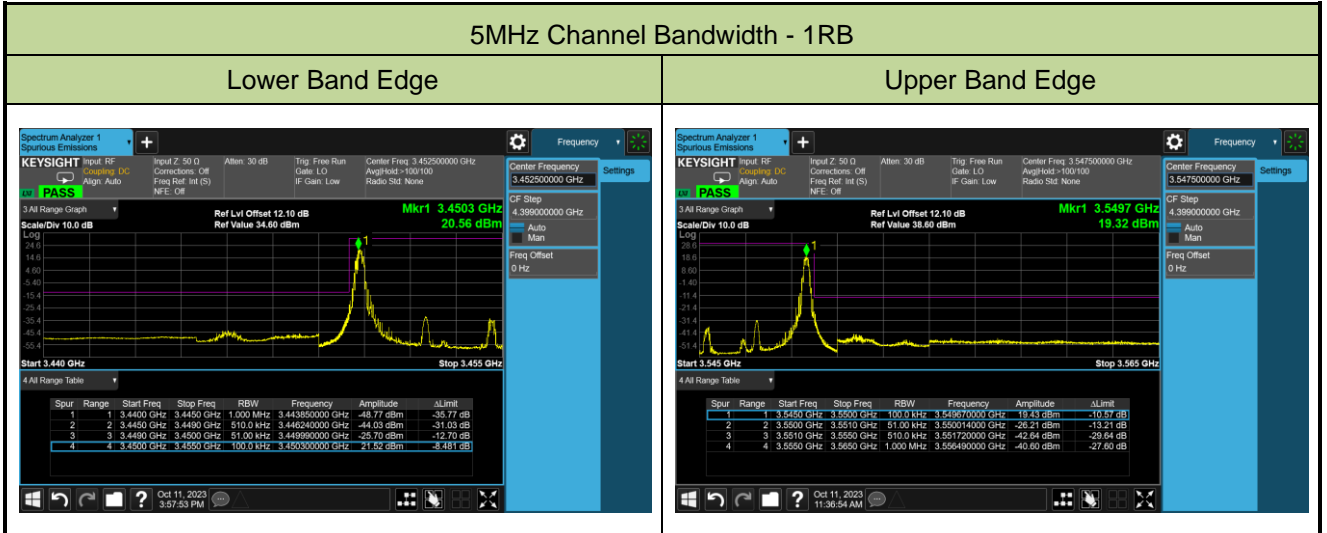

15MHz Channel Bandwidth - 1RB

Lower Band Edge

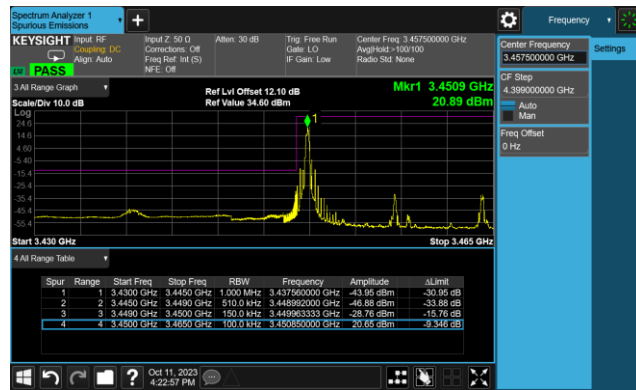

Upper Band Edge

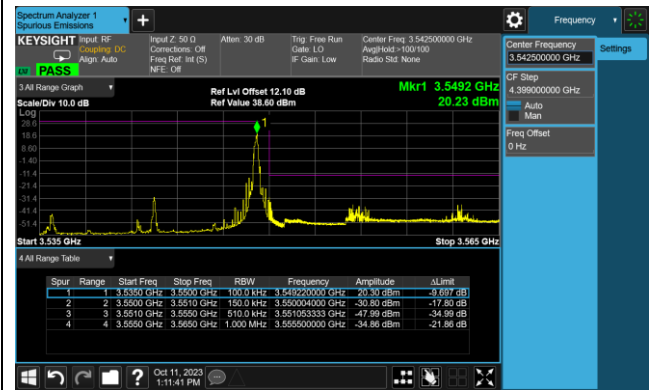

20MHz Channel Bandwidth - 1RB

Lower Band Edge

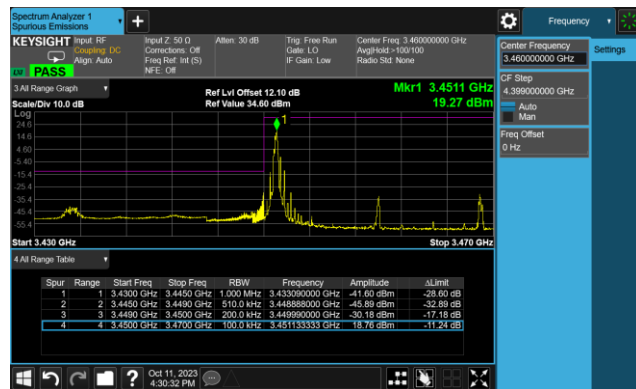

Upper Band Edge

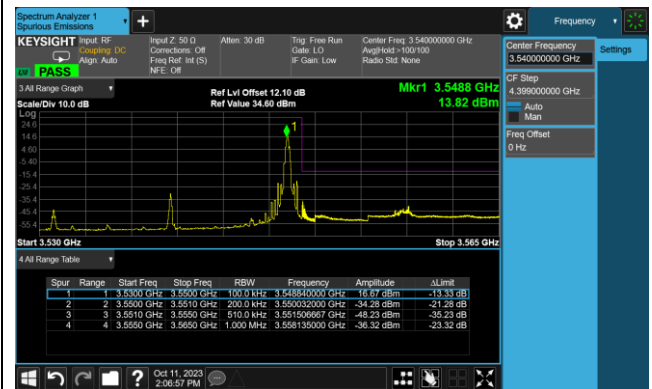

5MHz Channel Bandwidth - Full RB

Lower Band Edge

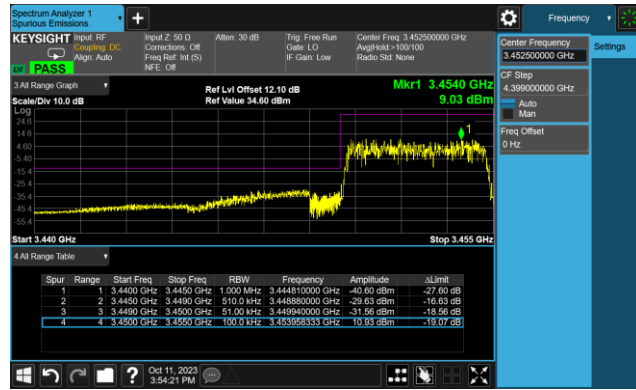

Upper Band Edge

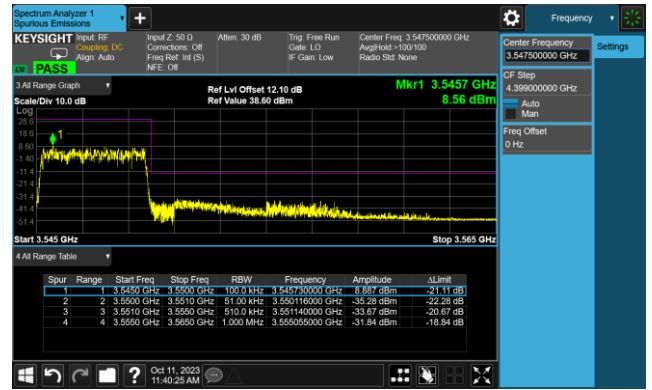

10MHz Channel Bandwidth - Full RB

Lower Band Edge

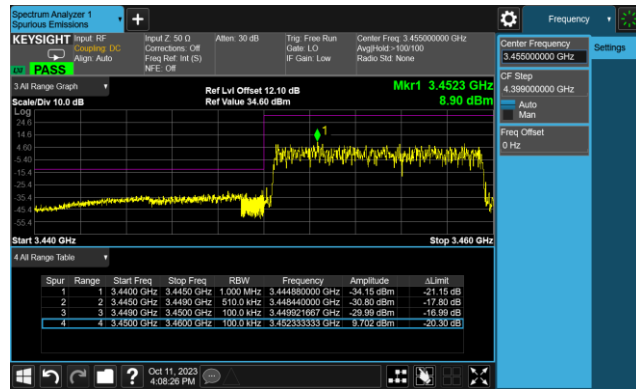

Upper Band Edge

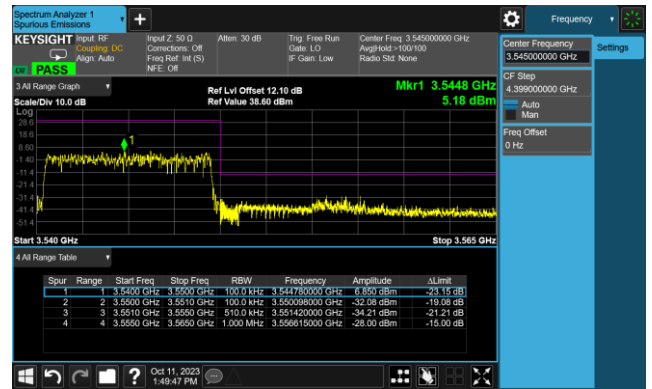

15MHz Channel Bandwidth - Full RB

Lower Band Edge

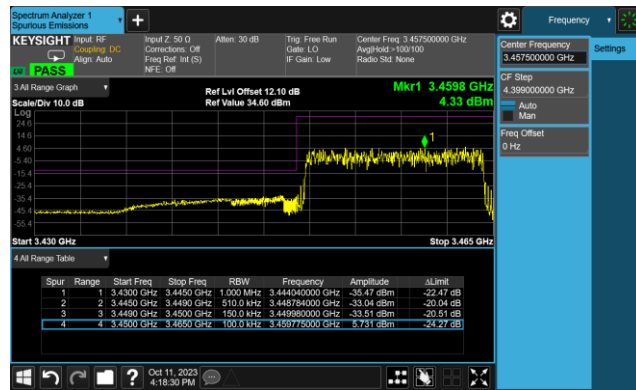

Upper Band Edge

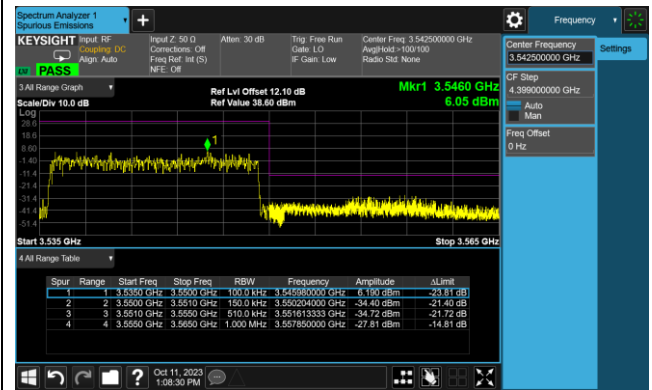

20MHz Channel Bandwidth - Full RB

Lower Band Edge

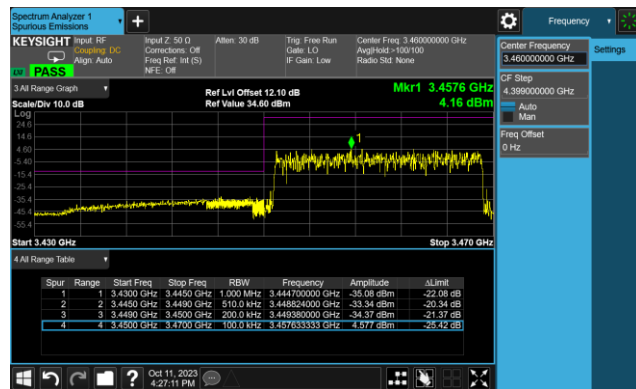

Upper Band Edge

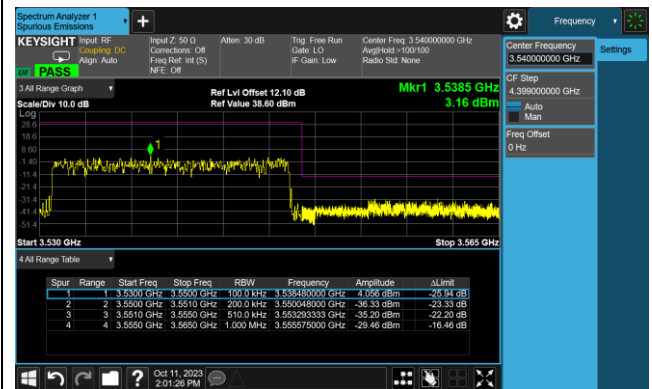

Test Site	SIP-SR1	Test Engineer	Yoniter Yang
Test Date	2023-10-11	Test Band	LTE Band 43

