

RF TEST REPORT

Applicant Quectel Wireless Solutions Co., Ltd.
FCC ID XMR2022BG952AGL
Product LTE Cat M1 & Cat NB2 Module
Brand Quectel
Model BG952A-GL
Report No. R2301A0030-R8
Issue Date July 17, 2023

TA Technology (Shanghai) Co., Ltd. tested the above equipment in accordance with the requirements in **FCC CFR47 Part 2 (2022)/ FCC CFR 47 Part 22H (2022)**. The test results show that the equipment tested is capable of demonstrating compliance with the requirements as documented in this report.

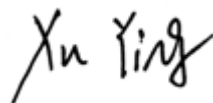

Prepared by: Xu Ying

Approved by: Xu Kai

TA Technology (Shanghai) Co., Ltd.

Building 3, No.145, Jintang Rd, Pudong Shanghai, P.R.China

TEL: +86-021-50791141/2/3

FAX: +86-021-50791141/2/3-8000

TABLE OF CONTENT

| | |
|---|----|
| 1. Test Laboratory | 5 |
| 1.1. Notes of the Test Report | 5 |
| 1.2. Test Facility | 5 |
| 1.3. Testing Location | 5 |
| 2. General Description of Equipment Under Test | 6 |
| 2.1. Applicant and Manufacturer Information | 6 |
| 2.2. General Information | 6 |
| 3. Applied Standards | 7 |
| 4. Test Configuration | 8 |
| 5. Test Case | 9 |
| 5.1. RF Power Output and Effective Radiated Power | 9 |
| 5.2. Occupied Bandwidth | 10 |
| 5.3. Band Edge Compliance | 11 |
| 5.4. Peak-to-Average Power Ratio (PAPR) | 12 |
| 5.5. Frequency Stability | 13 |
| 5.6. Spurious Emissions at Antenna Terminals | 15 |
| 5.7. Radiated Spurious Emission | 16 |
| 6. Test Result | 19 |
| 6.1. RF Power Output and Effective Radiated Power | 19 |
| 6.2. Occupied Bandwidth | 20 |
| 6.3. Band Edge Compliance | 23 |
| 6.4. Peak-to-Average Power Ratio (PAPR) | 29 |
| 6.5. Frequency Stability | 30 |
| 6.6. Spurious Emissions at Antenna Terminals | 32 |
| 6.7. Radiated Spurious Emission | 34 |
| 7. Main Test Instruments | 36 |
| ANNEX A: The EUT Appearance | 37 |
| ANNEX B: Test Setup Photos | 38 |
| ANNEX C: Product Change Description (Variant1) | 39 |
| ANNEX D: Product Change Description (Variant2) | 40 |

Summary of Measurement Results

| No. | Test Case | Clause in FCC rules | Verdict |
|-----|--|----------------------------------|---------|
| 1 | RF Power Output and Effective Radiated Power | 2.1046 22.913(a)(5) | PASS |
| 2 | Occupied Bandwidth | 2.1049 | PASS |
| 3 | Band Edge Compliance | 2.1051 / 22.917(a) | PASS |
| 4 | Peak-to-Average Power Ratio | 22.913(d) KDB 971168 D01(5.7) | PASS |
| 5 | Frequency Stability | 2.1055 / 22.355 | PASS |
| 6 | Spurious Emissions at Antenna Terminals | 2.1051 / 22.917(a) | PASS |
| 7 | Radiated Spurious Emission | 2.1053 / 22.917 (a) | PASS |

Date of Testing: July 21, 2021 ~ August 5, 2021

Date of Sample Received: July 20, 2021

Note: PASS: The EUT complies with the essential requirements in the standard.

FAIL: The EUT does not comply with the essential requirements in the standard.

All indications of Pass/Fail in this report are opinions expressed by TA Technology (Shanghai) Co., Ltd. based on interpretations and/or observations of test results. Measurement Uncertainties were not taken into account and are published for informational purposes only.

BG952A-GL (Report No.: R2301A0030-R8) is a variant model (Variant 2) of BG950A-GL (Report No.: R2206A0479-R8). BG952A-GL supports from Cat NB1 (3GPP R13) to Cat NB2 (3GPP R14) only by FW updating, the hardware remains the same.

The detailed product change description please refers to following table:

| Module | BG952A-GL (Cat NB1) | BG952A-GL (Cat NB2) |
|------------------|---|---|
| Category | Cat M1 & NB1 | Cat M1 & NB2 |
| Frequency Bands | Cat M1 Band 2/4/5/12/13/25/26/66 Cat NB1 Band 2/4/5/12/13/17/25/66 | Cat M1 Band 2/4/5/12/13/25/26/66 Cat NB2 Band 2/4/5/12/13/17/25/66 |
| Software Version | BG952AGLAAR01A03 | BG952AGLAAR02A01 |
| Product Name | LTE Cat M1 & Cat NB1 Module | LTE Cat M1 & Cat NB2 Module |
| Others | The same | |

There is only verified RF Power Output, Band Edge Compliance and Spurious Emissions at Antenna Terminals, and did not worsen, so they were not recorded in the report.

Powers of new variant are varied due to measurement uncertainty, and sample tolerance of the acceptance range.

The detailed product change description please refers to the *Difference Declaration Letter (Variant 2)*.

BG952A-GL (Report No.: R2206A0479-R8) is a variant model (Variant 1) of BG950A-GL (Report No.: R2107A0607-R8). Test values duplicated from Original for variant. The powers of new variant are varied due to measurement uncertainty, and sample tolerance of the acceptance range.

The detailed product change description please refers to following table:

| Module | BG950A-GL | BG952A-GL |
|------------------|------------------|-----------------------------|
| QuecOpen® | N/A | Supported |
| Hardware Version | R1.3 | R1.5 |
| Software Version | BG950AGLAAR01A01 | BG952AGLAAR01A03 |
| Product Name | LTE Module | LTE Cat M1 & Cat NB1 Module |
| Others | The same | |

The detailed product change description please refers to the *Difference Declaration Letter (Variant 1)*.

1. Test Laboratory

1.1. Notes of the Test Report

This report shall not be reproduced in full or partial, without the written approval of **TA Technology (Shanghai) Co., Ltd.** The results documented in this report apply only to the tested sample, under the conditions and modes of operation as described herein. Measurement Uncertainties were not taken into account and are published for informational purposes only. This report is written to support regulatory compliance of the applicable standards stated above.

1.2. Test Facility

FCC (Designation number: CN1179, Test Firm Registration Number: 446626)

TA Technology (Shanghai) Co., Ltd. has been listed on the US Federal Communications Commission list of test facilities recognized to perform measurements.

A2LA (Certificate Number: 3857.01)

TA Technology (Shanghai) Co., Ltd. has been listed by American Association for Laboratory Accreditation to perform measurement.

1.3. Testing Location

Company: TA Technology (Shanghai) Co., Ltd.
Address: Building 3, No.145, Jintang Rd, Pudong Shanghai, P.R.China
City: Shanghai
Post code: 201201
Country: P. R. China
Contact: Xu Kai
Telephone: +86-021-50791141/2/3
Fax: +86-021-50791141/2/3-8000
Website: <http://www.ta-shanghai.com>
E-mail: xukai@ta-shanghai.com

2. General Description of Equipment Under Test

2.1. Applicant and Manufacturer Information

| | |
|----------------------|--|
| Applicant | Quectel Wireless Solutions Co., Ltd. |
| Applicant address | Building 5, Shanghai Business Park Phase III (Area B), No.1016 Tianlin Road, Minhang District, Shanghai, China, 200233 |
| Manufacturer | Quectel Wireless Solutions Co., Ltd. |
| Manufacturer address | Building 5, Shanghai Business Park Phase III (Area B), No.1016 Tianlin Road, Minhang District, Shanghai, China, 200233 |

2.2. General Information

| EUT Description | | | |
|--|---------------------------------|-----------------|------------|
| Model | BG952A-GL | | |
| IMEI | Original | 869410050002659 | |
| Hardware Version | R1.5 | | |
| Software Version | BG952AGLAAR02A01 | | |
| Power Supply | External power supply | | |
| Antenna Type | External Antenna | | |
| Antenna Gain | Mode | Frequency (MHz) | Gain (dBi) |
| | LTE-M Band 5 | 820 | 2.53 |
| | | 830 | 2.13 |
| | | 840 | 1.89 |
| | 850 | 2.29 | |
| Test Mode(s) | LTE-M Band 5; | | |
| Test Modulation | QPSK, 16QAM; | | |
| LTE-M Category | M1 | | |
| Maximum E.R.P. | LTE-M Band 5 | 24.32dBm | |
| Rated Power Supply Voltage | 3.3V | | |
| Operating Voltage | Minimum: 2.2V Maximum: 4.35V | | |
| Operating Temperature | Lowest: -35°C Highest: +75°C | | |
| Testing Temperature | Lowest: -30°C Highest: +50°C | | |
| Frequency Range(s) | Band | Tx (MHz) | Rx (MHz) |
| | LTE-M Band 5 | 824 ~ 849 | 869 ~ 894 |
| Note: 1. The EUT is sent from the applicant to TA and the information of the EUT is declared by the applicant. | | | |

3. Applied Standards

According to the specifications of the manufacturer, it must comply with the requirements of the following standards:

Test standards:

FCC CFR 47 Part 22H (2022)

FCC CFR47 Part 2 (2022)

Reference standard:

ANSI C63.26-2015

KDB 971168 D01 Power Meas License Digital Systems v03r01

4. Test Configuration

Radiated measurements are performed by rotating the EUT in three different orthogonal test planes. EUT polarization (horizontal and vertical). Receiver antenna polarization (horizontal and vertical), the worst emission was found in position (horizontal polarization, vertical polarization) and the worst case was recorded.

All mode and data rates and positions and RB size and modulations were investigated.

Subsequently, only the worst case emissions are reported.

The following testing in LTE-M is set based on the maximum RF Output Power.

Test modes are chosen as the worst case configuration below for LTE-M Band 5.

| Test items | Bandwidth (MHz) | | | | Modulation | | RB | | | Test Channel | | |
|--|---|---|---|----|------------|-------|----|-----|------|--------------|---|---|
| | 1.4 | 3 | 5 | 10 | QPSK | 16QAM | 1 | 50% | 100% | L | M | H |
| RF power output and Effective Radiated power | O | O | O | O | O | O | O | O | O | O | O | O |
| Occupied Bandwidth | O | O | O | O | O | O | - | - | O | - | O | - |
| Band Edge Compliance | O | O | O | O | O | O | O | - | O | O | - | O |
| Peak-to-Average Power Ratio | O | O | O | O | O | O | - | - | O | - | O | - |
| Frequency Stability | O | O | O | O | O | O | O | - | - | - | O | - |
| Spurious Emissions at Antenna Terminals | O | O | O | O | O | - | O | - | - | O | O | O |
| Radiated Spurious Emission | O | - | O | O | O | - | O | - | - | - | O | - |
| Note | 1. The mark "O" means that this configuration is chosen for testing. 2. The mark "-" means that this configuration is not testing. | | | | | | | | | | | |

5. Test Case

5.1. RF Power Output and Effective Radiated Power

Ambient Condition

| Temperature | Relative humidity | Pressure |
|-------------|-------------------|----------|
| 23°C ~25°C | 45%~50% | 101.5kPa |

Methods of Measurement

During the process of the testing, The EUT was connected to the Base Station Simulator with a known loss. The EUT is controlled by the Base Station Simulator test set to ensure max power transmission with proper modulation.

ERP can then be calculated as follows:

$EIRP \text{ (dBm)} = \text{Output Power (dBm)} + \text{Antenna Gain (dBi)}$

$EIRP \text{ (dBm)} = ERP \text{ (dBm)} + 2.15 \text{ (dB)}$.

Test Setup

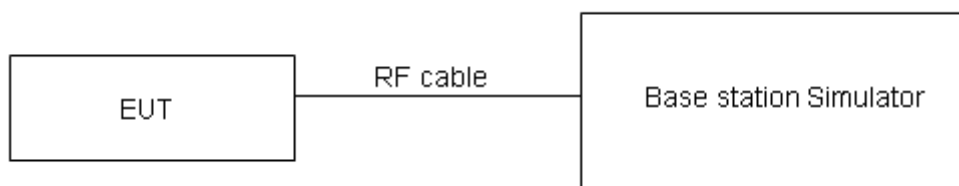

Limits

No specific RF power output requirements in part 2.1046.

Rule Part 22.913(a)(5) specifies that "Mobile/portable stations are limited to 7 watts ERP".

| | |
|-------|--------------------------------|
| Limit | $\leq 7 \text{ W}$ (38.45 dBm) |
|-------|--------------------------------|

Measurement Uncertainty

The assessed measurement uncertainty to ensure 95% confidence level for the normal distribution is with the coverage factor $k = 2$, $U = 0.4 \text{ dB}$ for RF power output, $k = 2$, $U = 1.19 \text{ dB}$ for ERP.

Test Results

Refer to the section 6.1 of this report for test data.

5.2. Occupied Bandwidth

Ambient Condition

| Temperature | Relative humidity | Pressure |
|-------------|-------------------|----------|
| 23°C ~25°C | 45%~50% | 101.5kPa |

Method of Measurement

The EUT was connected to Spectrum Analyzer and Base Station Simulator via power Splitter. The occupied bandwidth is measured using spectrum analyzer.

RBW is set to $\geq 1\%$ EBW, VBW is set to 3x RBW.

99% power and -26dBc occupied bandwidths are recorded. Spectrum analyzer plots are included on the following pages.

Test Setup

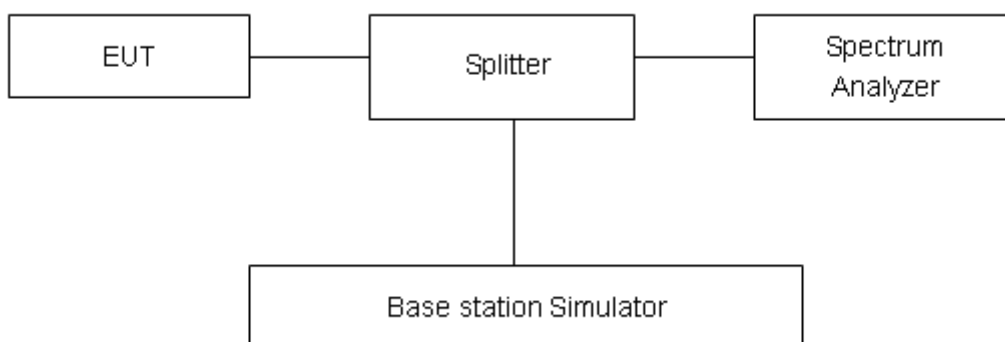

Limits

No specific occupied bandwidth requirements in part 2.1049.

Measurement Uncertainty

The assessed measurement uncertainty to ensure 95% confidence level for the normal distribution is with the coverage factor $k = 2$, $U = 624\text{Hz}$.

Test Results

Refer to the section 6.2 of this report for test data.

5.3. Band Edge Compliance

Ambient Condition

| Temperature | Relative humidity | Pressure |
|-------------|-------------------|----------|
| 23°C ~25°C | 45%~50% | 101.5kPa |

Method of Measurement

The EUT was connected to Spectrum Analyzer and Base Station Simulator via power Splitter. The band edge of the lowest and highest channels were measured. The average detector is used. RBW is set to $\geq 1\%EBW$, VBW is set to 3x RBW.

Spectrum analyzer plots are included on the following pages.

Test Setup

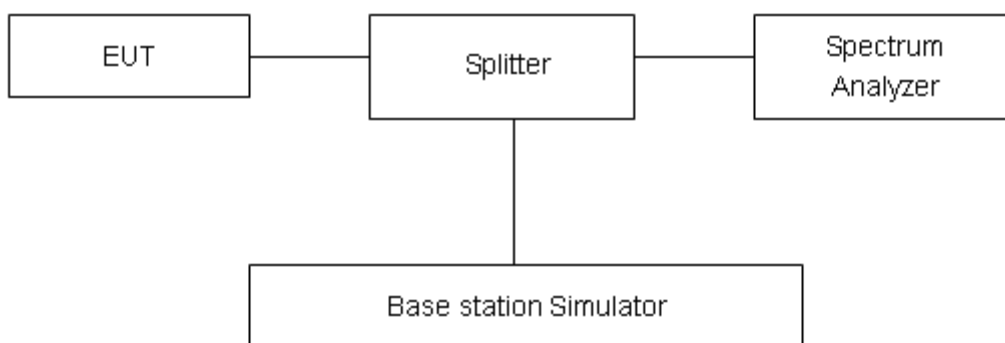

Limits

Rule Part 22.917(a) specifies that “The power of any emission outside of the authorized operating frequency ranges must be attenuated below the transmitting power (P) by a factor of at least 43 + 10 log(P) dB.”

| | |
|-------|---------|
| Limit | -13 dBm |
|-------|---------|

Measurement Uncertainty

The assessed measurement uncertainty to ensure 95% confidence level for the normal distribution is with the coverage factor $k = 1.96$, $U=0.684dB$.

Test Results

Refer to the section 6.3 of this report for test data.

5.4. Peak-to-Average Power Ratio (PAPR)

Ambient Condition

| Temperature | Relative humidity | Pressure |
|-------------|-------------------|----------|
| 23°C ~25°C | 45%~50% | 101.5kPa |

Methods of Measurement

Measure the total peak power and record as P_{Pk} . And measure the total average power and record as P_{Avg} . Both the peak and average power levels must be expressed in the same logarithmic units (e.g., dBm). Determine the PAPR from:

$$PAPR (dB) = P_{Pk} (dBm) - P_{Avg} (dBm).$$

Test Setup

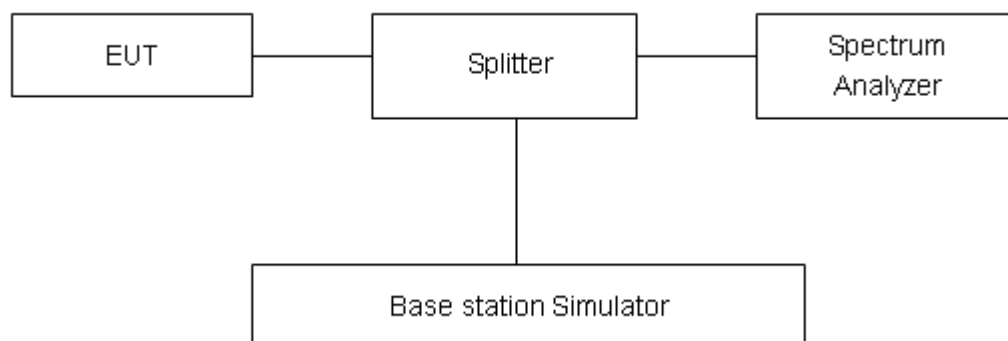

Limits

According to the Sec. 22.913(d), The peak-to-average ratio (PAR) of the transmission must not exceed 13 dB.

Measurement Uncertainty

The assessed measurement uncertainty to ensure 95% confidence level for the normal distribution is with the coverage factor $k = 2$, $U = 0.4$ dB.

Test Results

Refer to the section 6.4 of this report for test data.

5.5. Frequency Stability

Ambient Condition

| Temperature | Relative humidity | Pressure |
|-------------|-------------------|----------|
| 23°C ~25°C | 45%~50% | 101.5kPa |

Method of Measurement

Frequency Stability (Temperature Variation)

The temperature inside the climate chamber is varied from -30°C to +50°C in 10°C step size,

(1) With all power removed, the temperature was decreased to 0°C and permitted to stabilize for three hours.

(2) Measure the carrier frequency with the test equipment in a “call mode”. These measurements should be made within 1 minute of powering up the mobile station, to prevent significant self warming.

(3) Repeat the above measurements at 10°C increments from -30°C to +50°C. Allow at least 1.5 hours at each temperature, un-powered, before making measurements.

Frequency Stability (Voltage Variation)

The frequency stability shall be measured with variation of primary supply voltage as follows:

Primary Supply Voltage: The primary supply voltage is varied from 85% to 115% of the nominal value for non hand-carried battery and AC powered equipment. For hand-carried, battery-powered equipment, primary supply voltage is reduced to the battery operating end point which shall be specified by the manufacturer.

This transceiver is specified to operate with an input voltage of between 2.2V and 4.35 V, with a nominal voltage of 3.3V.

Test Setup

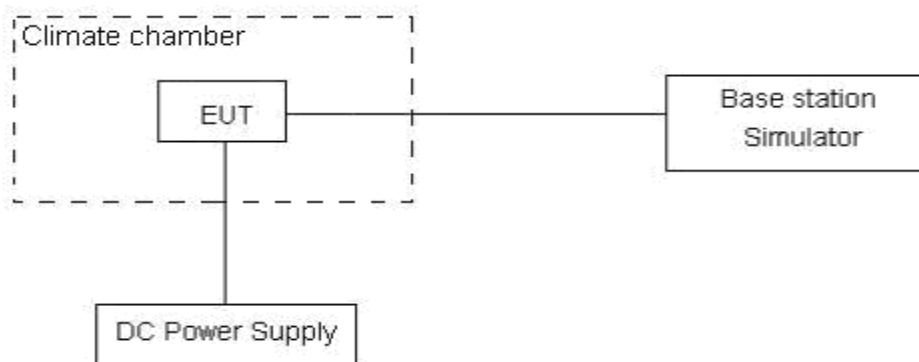

Limits

According to the Sec. 22.355, the frequency stability of the carrier shall be accurate to within 2.5 ppm of the received frequency for mobile stations.

| | |
|--------|-----------|
| Limits | ≤ 2.5 ppm |
|--------|-----------|

Measurement Uncertainty

The assessed measurement uncertainty to ensure 99.75% confidence level for the normal distribution is with the coverage factor $k = 3$, $U = 0.01\text{ppm}$.

Test Results

Refer to the section 6.5 of this report for test data.

5.6. Spurious Emissions at Antenna Terminals

Ambient Condition

| Temperature | Relative humidity | Pressure |
|-------------|-------------------|----------|
| 23°C ~25°C | 45%~50% | 101.5kPa |

Method of Measurement

The EUT was connected to Spectrum Analyzer and Base Station Simulator via power Splitter. The measurement is carried out using a spectrum analyzer. The spectrum analyzer scans from 9kHz to the 10th harmonic of the carrier.

The peak detector is used.

RBW is set to 1 kHz (0.009MHz~ 0.15 MHz),

RBW is set to 10 kHz (0.15 MHz~ 30 MHz)

RBW is set to 100 kHz (30MHz~1000 MHz)

RBW is set to 1000 kHz (above 1000MHz)

Sweep is set to ATUO.

The modulation mode and RB allocation refer to section 5.1, using the maximum output power configuration.

Test Setup

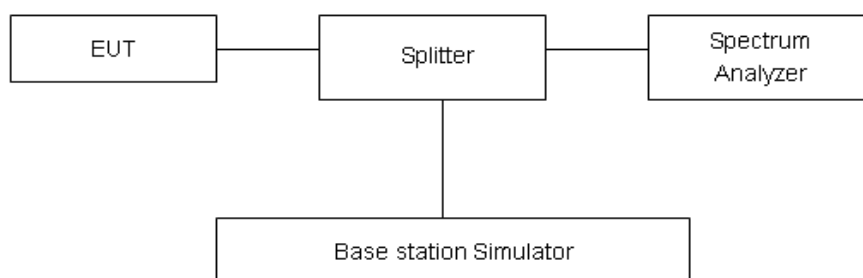

Limits

Rule Part 22.917(a) specifies that “The power of any emission outside of the authorized operating frequency ranges must be attenuated below the transmitting power (P) by a factor of at least $43 + 10 \log (P)$ dB.”

| | |
|-------|---------|
| Limit | -13 dBm |
|-------|---------|

Measurement Uncertainty

The assessed measurement uncertainty to ensure 99.75% confidence level for the normal distribution is with the coverage factor $k = 1.96$.

| Frequency | Uncertainty |
|------------|-------------|
| 9kHz-1GHz | 0.684 dB |
| 1GHz-30GHz | 1.407 dB |

Test Results

Refer to the section 6.6 of this report for test data.

5.7. Radiated Spurious Emission

Ambient Condition

| Temperature | Relative humidity | Pressure |
|-------------|-------------------|----------|
| 23°C ~25°C | 45%~50% | 101.5kPa |

Method of Measurement

- The testing follows FCC KDB 971168 v03r01 Section 5.8 and ANSI C63.26-2015.
- Below 1GHz: The EUT is placed on a turntable 0.8 meters above the ground in the chamber, 3 meter away from the antenna. The maximal emission value is acquired by adjusting the antenna height, polarisation and turntable azimuth. Normally, the height range of antenna is 1 m to 4 m, the azimuth range of turntable is 0° to 360°, and the receive antenna has two polarizations Vertical (V) and Horizontal (H). Above 1GHz: (Note: the FCC's permission to use 1.5m as an alternative per TCBC Conf call of Dec. 2, 2014.) The EUT is placed on a turntable 1.5 meters above the ground in the chamber, 3 meter away from the antenna. The maximal emission value is acquired by adjusting the antenna height, polarisation and turntable azimuth. Normally, the height range of antenna is 1 m to 4 m, the azimuth range of turntable is 0° to 360°, and the receive antenna has two polarizations Vertical (V) and Horizontal (H).
- A loop antenna, A log-periodic antenna or horn antenna shall be substituted in place of the EUT. The log-periodic antenna will be driven by a signal generator and the level will be adjusted till the same power value on the spectrum analyzer or receiver. The level of the spurious emissions can be calculated through the level of the signal generator, cable loss, the gain of the substitution antenna and the reading of the spectrum analyzer or receiver.
- The EUT is then put into continuously transmitting mode at its maximum power level during the test. Set Test Receiver or Spectrum RBW=100kHz, VBW=300kHz, and the maximum value of the receiver should be recorded as (Pr).
- The EUT shall be replaced by a substitution antenna. In the chamber, an substitution antenna for the frequency band of interest is placed at the reference point of the chamber. An RF Signal source for the frequency band of interest is connected to the substitution antenna with a cable that has been constructed to not interfere with the radiation pattern of the antenna. A power (PMea) is applied to the input of the substitution antenna, and adjust the level of the signal generator output until the value of the receiver reach the previously recorded (Pr). The power of signal source (PMea) is recorded. The test should be performed by rotating the test item and adjusting the receiving antenna polarization.
- A amplifier should be connected to the Signal Source output port. And the cable should be connect between the Amplifier and the Substitution Antenna. The cable loss (Pcl) ,the Substitution Antenna Gain (Ga) and the Amplifier Gain (PAg) should be recorded after test.
- The measurement results are obtained as described below:
 Power (EIRP) = PMea - PAg - Pcl + Ga
 The measurement results are amend as described below:
 Power (EIRP) = PMea - Pcl + Ga
- This value is EIRP since the measurement is calibrated using an antenna of known gain (2.15 dB) and known input power. ERP can be calculated from EIRP by subtracting the gain of the dipole, ERP = EIRP-2.15dB.

The modulation mode and RB allocation refer to section 5.1, using the maximum output power configuration.

Test Setup

9KHz~ 30MHz

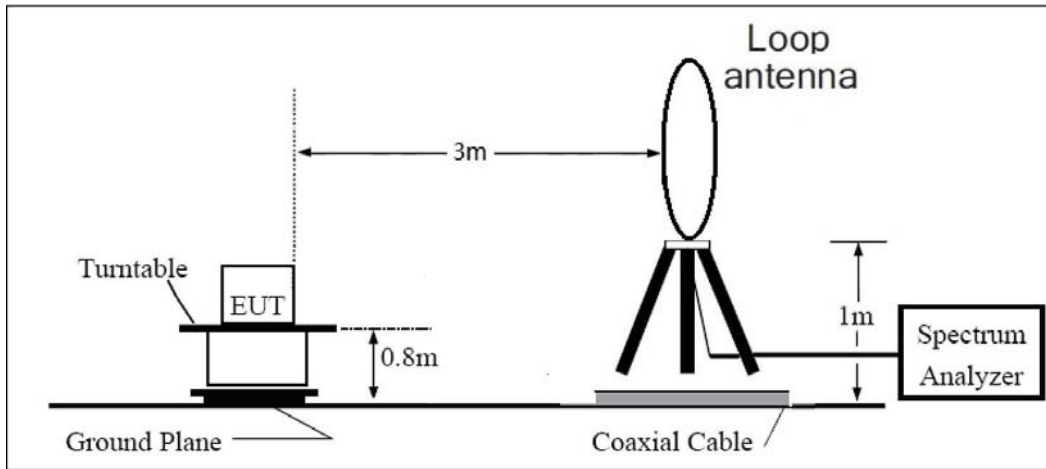

30MHz~ 1GHz

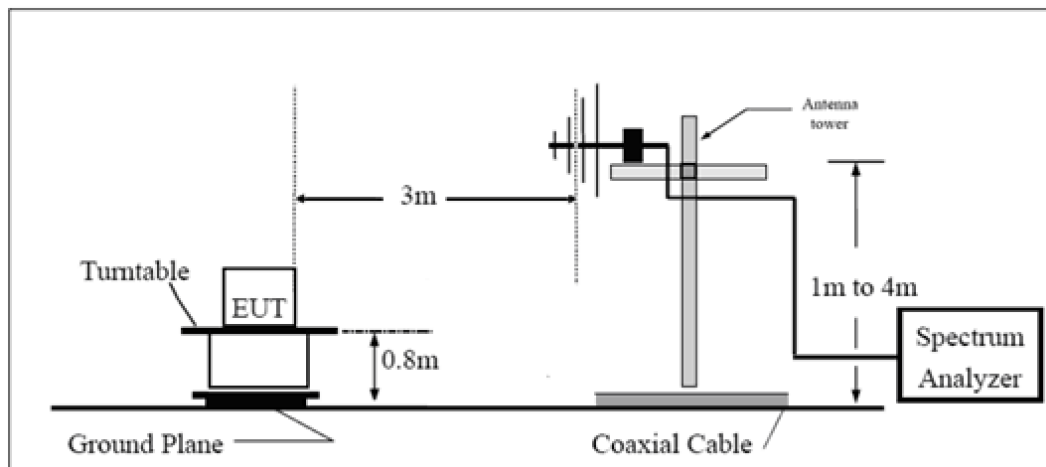

Above 1GHz

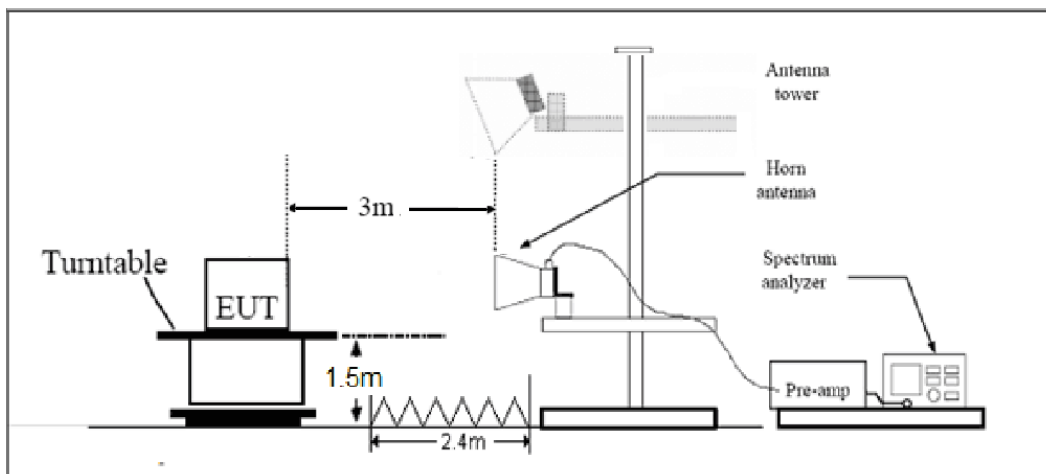

Note: Area side: 2.4mX3.6m

Limits

Rule Part 22.917(a) specifies that “The power of any emission outside of the authorized operating frequency ranges must be attenuated below the transmitting power (P) by a factor of at least $43 + 10 \log (P)$ Db.”

| | |
|-------|---------|
| Limit | -13 dBm |
|-------|---------|

Measurement Uncertainty

The assessed measurement uncertainty to ensure 95% confidence level for the normal distribution is with the coverage factor $k = 1.96$, $U = 3.55$ Db.

Test Results

Refer to the section 6.7 of this report for test data.

6. Test Result

6.1. RF Power Output and Effective Radiated Power

| LTE-M Band 5 | Channel/ Frequency(MHz) | Index | RB# | | Maximum Output Power (dBm) | | ERP (dBm) | |
|-----------------|----------------------------|-------|----------|-------|-------------------------------|-------|-----------|-------|
| | | | RB start | | QPSK | 16QAM | QPSK | 16QAM |
| | | | QPSK | 16QAM | | | | |
| 1.4MHz | 20407/824.7 | 0 | 1#0 | 1#0 | 23.94 | 22.83 | 24.32 | 23.21 |
| | | 0 | 6#0 | 5#0 | 22.54 | 22.15 | 22.92 | 22.53 |
| | 20525/836.5 | 0 | 1#0 | 1#0 | 23.91 | 22.74 | 23.65 | 22.48 |
| | | 0 | 6#0 | 5#0 | 22.51 | 22.01 | 22.25 | 21.75 |
| | 20643/848.3 | 0 | 1#5 | 1#5 | 23.82 | 22.84 | 23.96 | 22.98 |
| | | 0 | 6#0 | 5#0 | 22.39 | 22.03 | 22.53 | 22.17 |
| 3MHz | 20415/825.5 | 0 | 1#0 | 1#0 | 23.73 | 23.25 | 23.71 | 23.23 |
| | | 0 | 6#0 | 5#0 | 22.35 | 22.12 | 22.33 | 22.10 |
| | 20525/836.5 | 0 | 1#0 | 1#0 | 23.65 | 23.22 | 23.39 | 22.96 |
| | | 0 | 6#0 | 5#0 | 22.33 | 22.09 | 22.07 | 21.83 |
| | 20635/847.5 | 1 | 1#5 | 1#5 | 23.76 | 23.05 | 23.90 | 23.19 |
| | | 0 | 6#0 | 5#0 | 22.25 | 22.03 | 22.39 | 22.17 |
| 5MHz | 20425/826.5 | 3 | 1#0 | 1#0 | 22.80 | 23.22 | 22.78 | 23.20 |
| | | 0 | 6#0 | 5#0 | 23.33 | 22.08 | 23.31 | 22.06 |
| | 20525/836.5 | 0 | 1#0 | 1#0 | 23.03 | 21.67 | 22.77 | 21.41 |
| | | 0 | 6#0 | 5#0 | 23.33 | 21.99 | 23.07 | 21.73 |
| | 20625/846.5 | 0 | 1#5 | 1#5 | 23.70 | 23.98 | 23.84 | 24.12 |
| | | 0 | 6#0 | 5#0 | 23.36 | 21.97 | 23.50 | 22.11 |
| 10MHz | 20450/829 | 3 | 1#0 | 1#0 | 22.82 | 23.24 | 22.80 | 23.22 |
| | | 0 | 4#0 | 4#0 | 23.09 | 23.11 | 23.07 | 23.09 |
| | 20525/836.5 | 0 | 1#0 | 1#0 | 22.98 | 23.45 | 22.72 | 23.19 |
| | | 0 | 4#0 | 4#0 | 23.25 | 23.04 | 22.99 | 22.78 |
| | 20600/844 | 4 | 1#5 | 1#5 | 23.73 | 23.04 | 23.47 | 22.78 |
| | | 7 | 4#2 | 4#2 | 23.77 | 22.15 | 23.51 | 21.89 |

6.2. Occupied Bandwidth

| Mode | Bandwidth | Modulation | Channel/ Frequency(MHz) | Bandwidth(MHz) | |
|--------|-----------|------------|----------------------------|----------------|--------|
| | | | | 99% Power | -26dBc |
| Band 5 | 1.4MHz | QPSK | 20525/836.5 | 1.102 | 1.314 |
| | | 16QAM | 20525/836.5 | 0.954 | 1.298 |
| | 3MHz | QPSK | 20525/836.5 | 1.111 | 1.389 |
| | | 16QAM | 20525/836.5 | 0.963 | 1.303 |
| | 5MHz | QPSK | 20525/836.5 | 1.101 | 1.325 |
| | | 16QAM | 20525/836.5 | 0.971 | 1.316 |
| | 10MHz | QPSK | 20525/836.5 | 1.104 | 1.330 |
| | | 16QAM | 20525/836.5 | 0.990 | 1.318 |

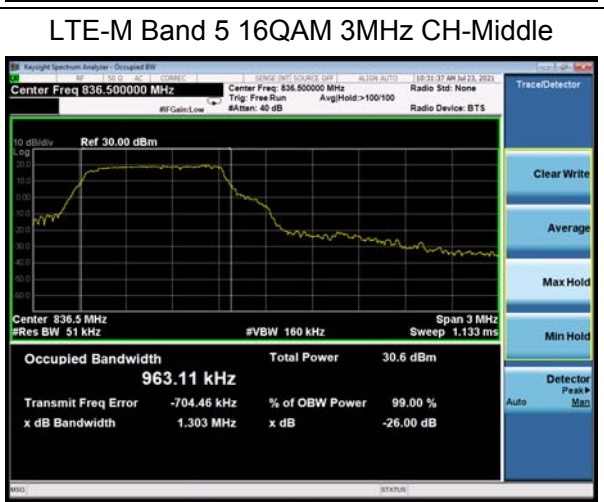
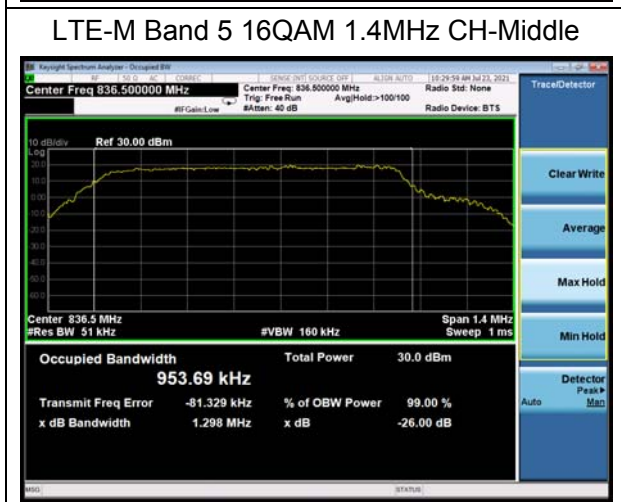
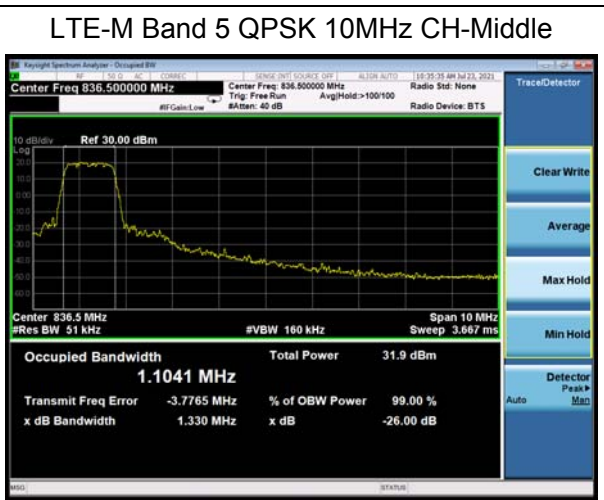
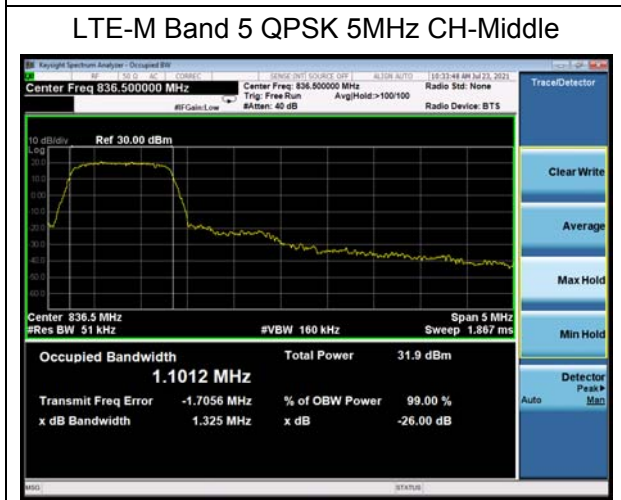
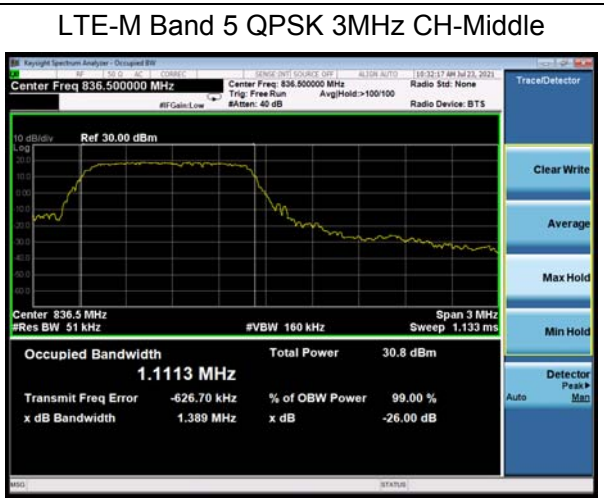
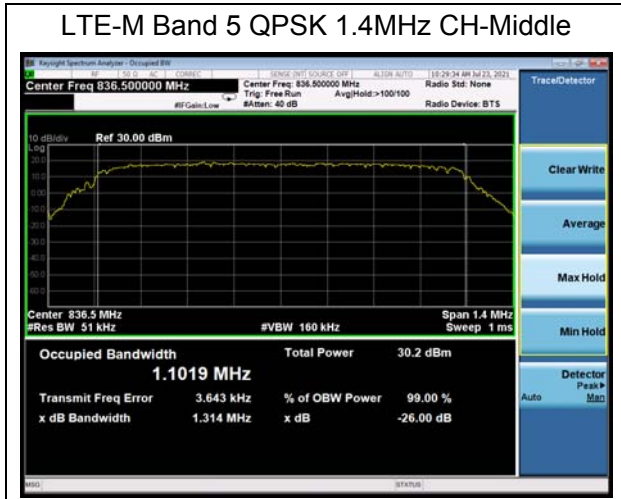

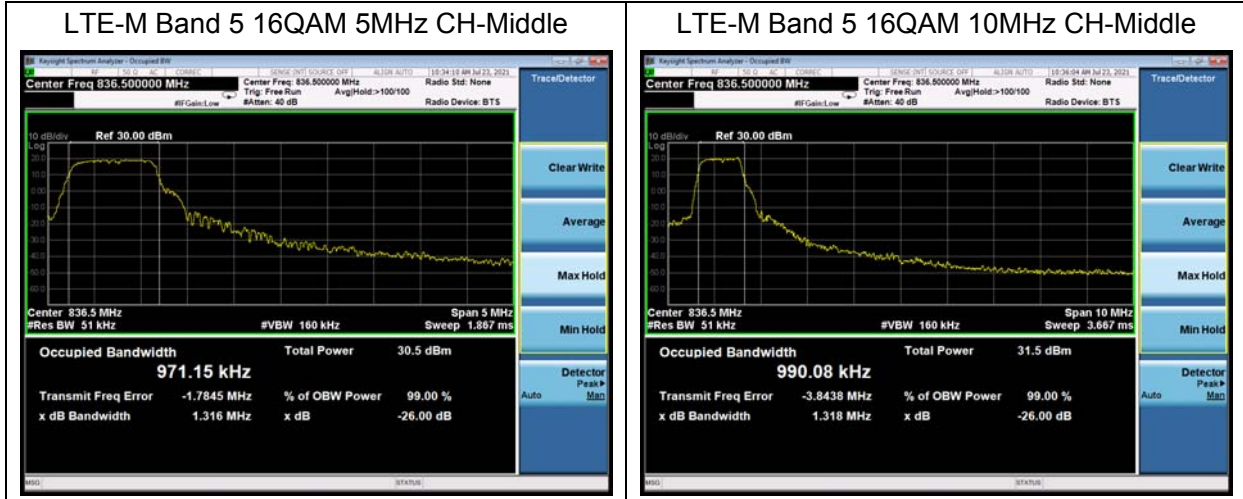

6.3. Band Edge Compliance

LTE-M Band 5 QPSK 1.4MHz CH-Low 1RB



LTE-M Band 5 QPSK 1.4MHz CH-High 1RB

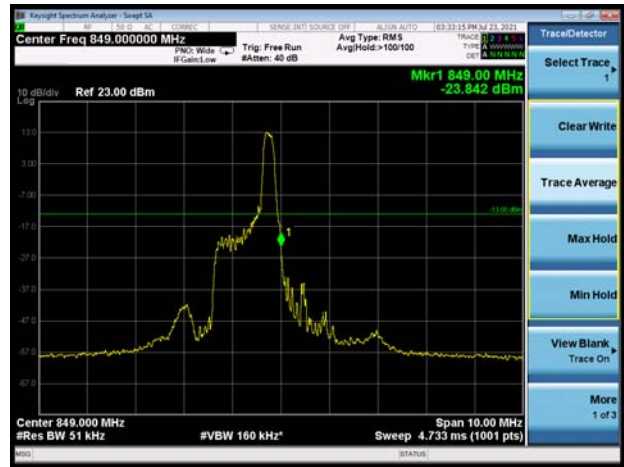

LTE-M Band 5 QPSK 1.4MHz CH-Low 100%RB

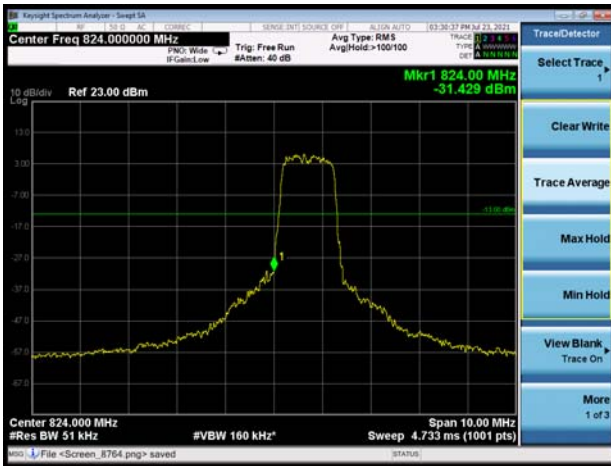

LTE-M Band 5 QPSK 1.4MHz CH-High 100%RB

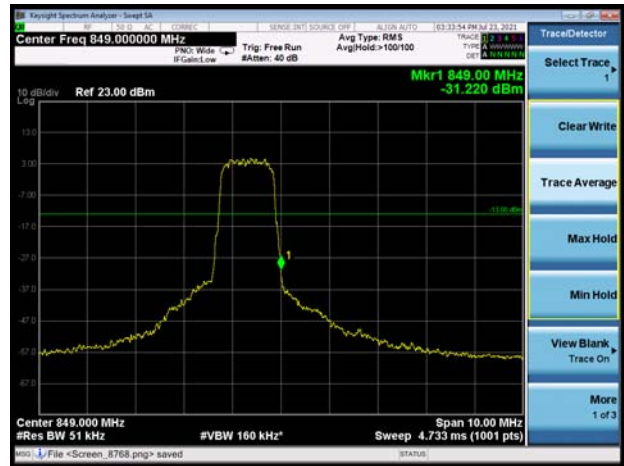

LTE-M Band 5 QPSK 3MHz CH-Low 1RB



LTE-M Band 5 QPSK 3MHz CH-High 1RB

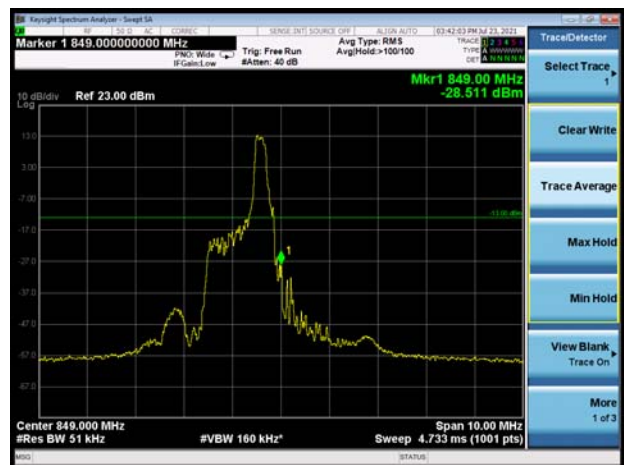

LTE-M Band 5 QPSK 3MHz CH-Low 100%RB

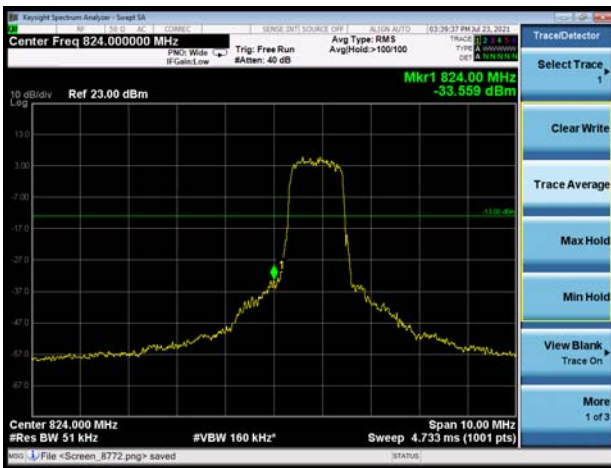

LTE-M Band 5 QPSK 3MHz CH-High 100%RB

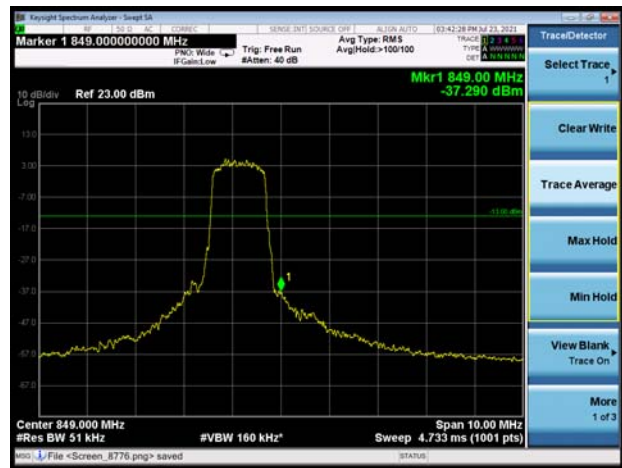

LTE-M Band 5 QPSK 5MHz CH-Low 1RB



LTE-M Band 5 QPSK 5MHz CH-High 1RB



LTE-M Band 5 QPSK 5MHz CH-Low 100%RB

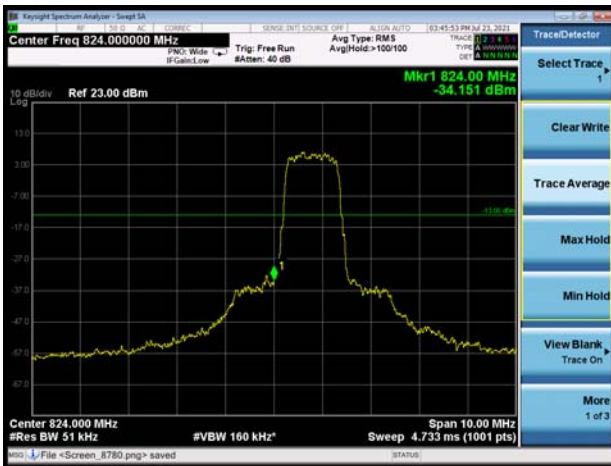

LTE-M Band 5 QPSK 5MHz CH-High 100%RB



LTE-M Band 5 QPSK 10MHz CH-Low 1RB



LTE-M Band 5 QPSK 10MHz CH-High 1RB



LTE-M Band 5 QPSK 10MHz CH-Low 100%RB



LTE-M Band 5 QPSK 10MHz CH-High 100%RB

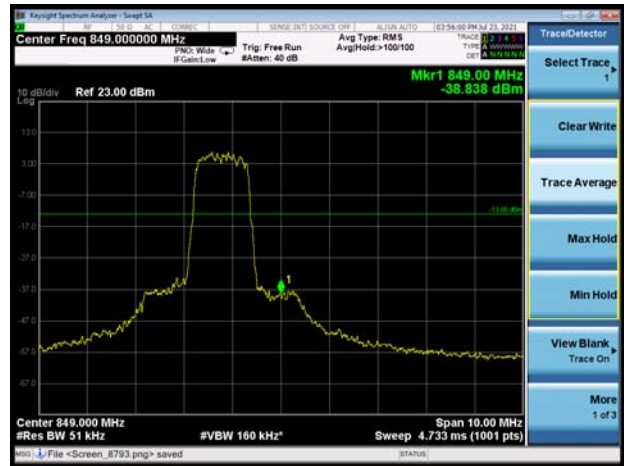

LTE-M Band 5 16QAM 1.4MHz CH-Low 1RB



LTE-M Band 5 16QAM 1.4MHz CH-High 1RB



LTE-M Band 5 16QAM 1.4MHz CH-Low 100%RB

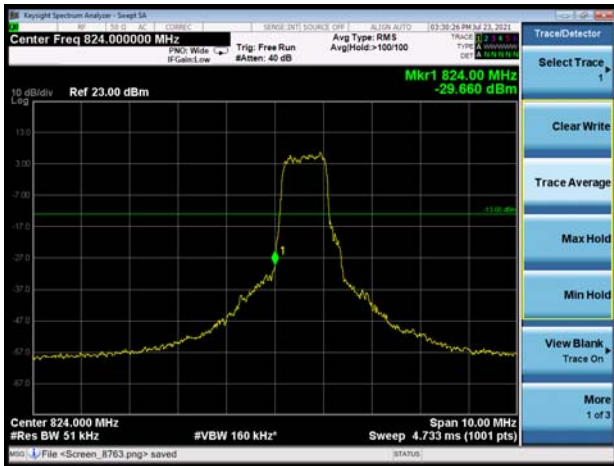

LTE-M Band 5 16QAM 1.4MHz CH-High 100%RB

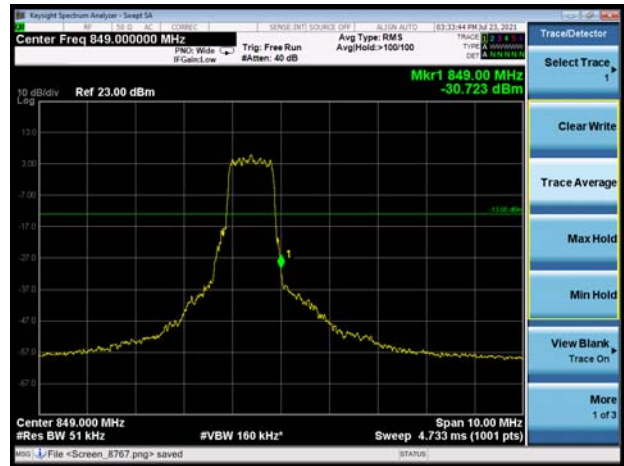

LTE-M Band 5 16QAM 3MHz CH-Low 1RB



LTE-M Band 5 16QAM 3MHz CH-High 1RB



LTE-M Band 5 16QAM 3MHz CH-Low 100%RB

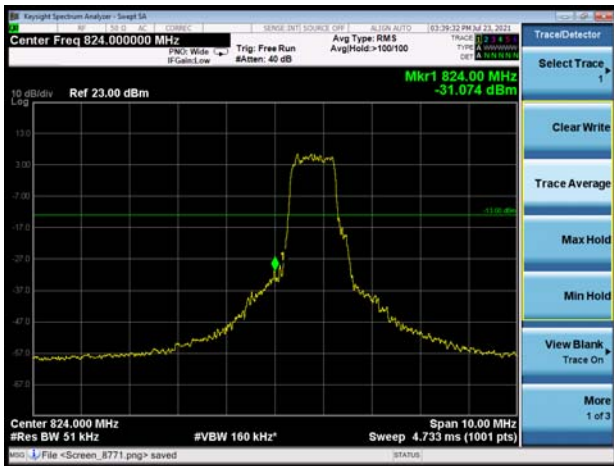

LTE-M Band 5 16QAM 3MHz CH-High 100%RB

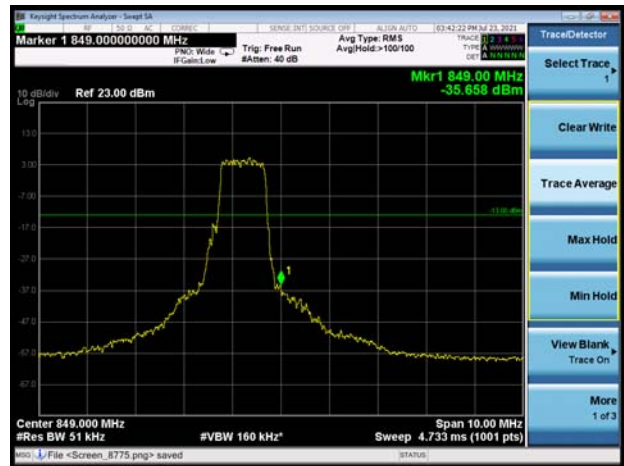

LTE-M Band 5 16QAM 5MHz CH-Low 1RB



LTE-M Band 5 16QAM 5MHz CH-High 1RB



LTE-M Band 5 16QAM 5MHz CH-Low 100%RB

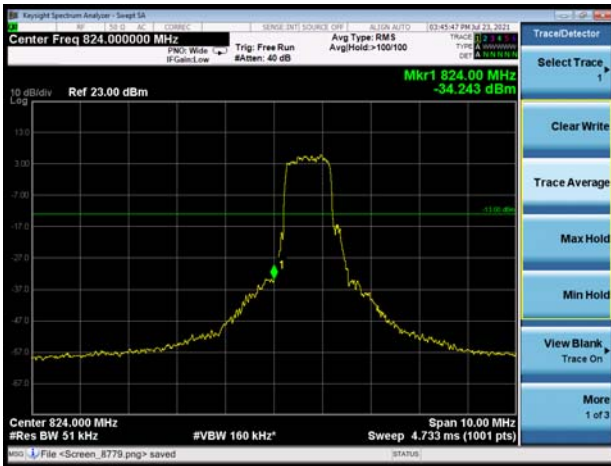

LTE-M Band 5 16QAM 5MHz CH-High 100%RB

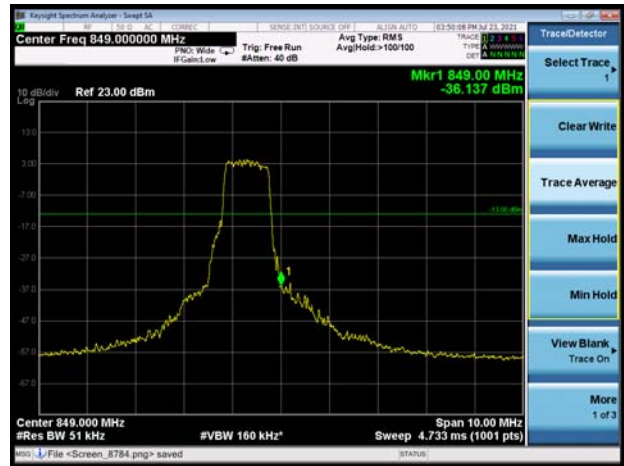

LTE-M Band 5 16QAM 10MHz CH-Low 1RB



LTE-M Band 5 16QAM 10MHz CH-High 1RB



LTE-M Band 5 16QAM 10MHz CH-Low 100%RB

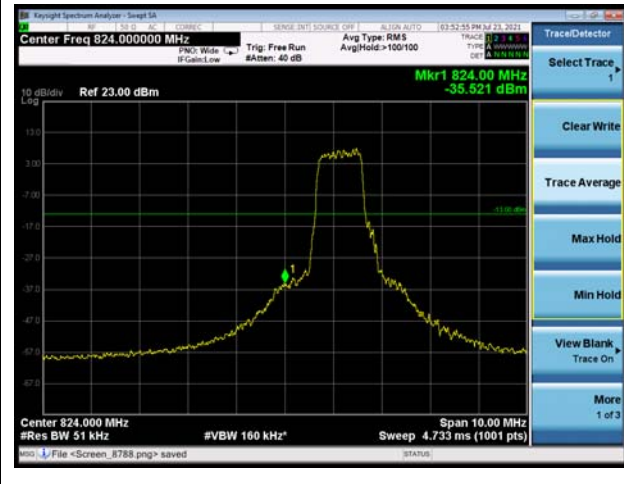

LTE-M Band 5 16QAM 10MHz CH-High 100%RB

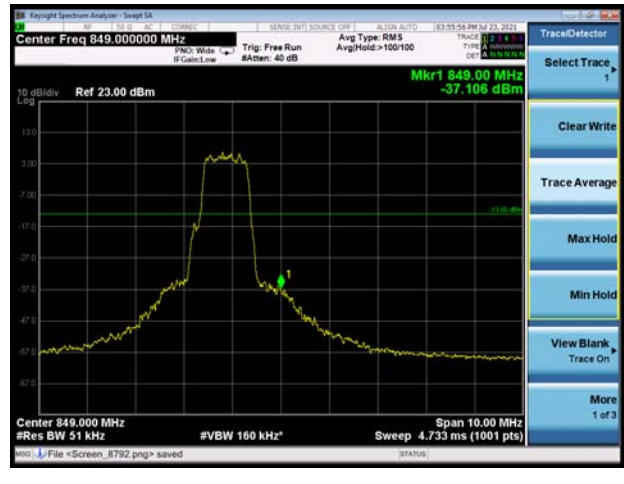

6.4. Peak-to-Average Power Ratio (PAPR)

| Mode | Bandwidth | Modulation | Channel/ Frequency (MHz) | Peak-to-Average Power Ratio (PAPR) | | | Limit (dB) | Conclusion |
|-------|-----------|------------|--------------------------------|---------------------------------------|--------------|--------------|---------------|------------|
| | | | | Peak (dBm) | Avg (dBm) | PAPR (dB) | | |
| Band5 | 1.4MHz | QPSK | 20525/836.5 | 26.87 | 16.43 | 10.44 | ≤13 | PASS |
| | | 16QAM | 20525/836.5 | 27.64 | 17.29 | 10.35 | ≤13 | PASS |
| | 3MHz | QPSK | 20525/836.5 | 26.81 | 16.90 | 9.91 | ≤13 | PASS |
| | | 16QAM | 20525/836.5 | 27.39 | 16.01 | 11.38 | ≤13 | PASS |
| | 5MHz | QPSK | 20525/836.5 | 27.78 | 18.28 | 9.50 | ≤13 | PASS |
| | | 16QAM | 20525/836.5 | 27.77 | 16.94 | 10.83 | ≤13 | PASS |
| | 10MHz | QPSK | 20525/836.5 | 27.86 | 18.24 | 9.62 | ≤13 | PASS |
| | | 16QAM | 20525/836.5 | 28.56 | 17.98 | 10.58 | ≤13 | PASS |

6.5. Frequency Stability

| LTE-M band5 | | | | | | |
|-----------------|---------|-----------------|-----------------|---------------------------|---------------------------|---------|
| Condition | | Freq.Error (Hz) | Freq.Error (Hz) | Frequency Stability (ppm) | Frequency Stability (ppm) | Verdict |
| BANDWIDTH | 1.4MHz | | | | | |
| Temperature | Voltage | 16QAM | QPSK | 16QAM | QPSK | |
| Normal (25°C) | Normal | 3.78 | 7.72 | 0.00452 | 0.00923 | PASS |
| Extreme (50°C) | | 13.02 | 4.66 | 0.01557 | 0.00557 | PASS |
| Extreme (40°C) | | 14.93 | 15.07 | 0.01785 | 0.01801 | PASS |
| Extreme (30°C) | | 4.83 | 9.67 | 0.00577 | 0.01156 | PASS |
| Extreme (20°C) | | 11.73 | 12.53 | 0.01403 | 0.01498 | PASS |
| Extreme (10°C) | | 17.11 | 1.13 | 0.02046 | 0.00135 | PASS |
| Extreme (0°C) | | 12.90 | 12.95 | 0.01542 | 0.01548 | PASS |
| Extreme (-10°C) | | 4.54 | 7.94 | 0.00543 | 0.00949 | PASS |
| Extreme (-20°C) | | 8.80 | 1.86 | 0.01052 | 0.00223 | PASS |
| Extreme (-30°C) | | 4.45 | 2.77 | 0.00532 | 0.00332 | PASS |
| 25°C | LV | 4.54 | 12.66 | 0.00543 | 0.01514 | PASS |
| | HV | 1.57 | 9.42 | 0.00188 | 0.01126 | PASS |
| Condition | | Freq.Error (Hz) | Freq.Error (Hz) | Frequency Stability (ppm) | Frequency Stability (ppm) | Verdict |
| BANDWIDTH | 3MHz | | | | | |
| Temperature | Voltage | 16QAM | QPSK | 16QAM | QPSK | |
| Normal (25°C) | Normal | 13.00 | 8.05 | 0.01554 | 0.00963 | PASS |
| Extreme (50°C) | | 12.45 | 8.72 | 0.01488 | 0.01043 | PASS |
| Extreme (40°C) | | 17.71 | 11.06 | 0.02117 | 0.01322 | PASS |
| Extreme (30°C) | | 12.63 | 16.34 | 0.01510 | 0.01954 | PASS |
| Extreme (20°C) | | 12.40 | 13.64 | 0.01482 | 0.01631 | PASS |
| Extreme (10°C) | | 12.98 | 11.42 | 0.01552 | 0.01365 | PASS |
| Extreme (0°C) | | 1.89 | 7.14 | 0.00226 | 0.00854 | PASS |
| Extreme (-10°C) | | 8.70 | 12.20 | 0.01040 | 0.01459 | PASS |
| Extreme (-20°C) | | 6.96 | 12.15 | 0.00832 | 0.01453 | PASS |
| Extreme (-30°C) | | 6.31 | 1.33 | 0.00754 | 0.00158 | PASS |
| 25°C | LV | 9.09 | 1.84 | 0.01087 | 0.00220 | PASS |
| | HV | 12.01 | 7.20 | 0.01435 | 0.00860 | PASS |
| Condition | | Freq.Error (Hz) | Freq.Error (Hz) | Frequency Stability (ppm) | Frequency Stability (ppm) | Verdict |
| BANDWIDTH | 5MHz | | | | | |
| Temperature | Voltage | 16QAM | QPSK | 16QAM | QPSK | |
| Normal (25°C) | Normal | 6.20 | 6.09 | 0.00741 | 0.00728 | PASS |
| Extreme (50°C) | | 13.83 | 1.16 | 0.01653 | 0.00139 | PASS |
| Extreme (40°C) | | 4.60 | 1.43 | 0.00550 | 0.00171 | PASS |

| | | | | | | |
|-----------------|---------|-----------------|-----------------|---------------------------|---------------------------|---------|
| Extreme (30°C) | | 10.17 | 5.50 | 0.01216 | 0.00657 | PASS |
| Extreme (20°C) | | 12.96 | 6.32 | 0.01550 | 0.00755 | PASS |
| Extreme (10°C) | | 15.56 | 6.65 | 0.01860 | 0.00796 | PASS |
| Extreme (0°C) | | 9.96 | 12.76 | 0.01191 | 0.01525 | PASS |
| Extreme (-10°C) | | 14.22 | 10.11 | 0.01700 | 0.01209 | PASS |
| Extreme (-20°C) | | 6.02 | 7.66 | 0.00720 | 0.00916 | PASS |
| Extreme (-30°C) | | 7.38 | 7.20 | 0.00882 | 0.00860 | PASS |
| 25°C | LV | 5.24 | 17.88 | 0.00626 | 0.02138 | PASS |
| | HV | 2.78 | 13.95 | 0.00332 | 0.01668 | PASS |
| Condition | | Freq.Error (Hz) | Freq.Error (Hz) | Frequency Stability (ppm) | Frequency Stability (ppm) | Verdict |
| BANDWIDTH | 10MHz | | | | | |
| Temperature | Voltage | 16QAM | QPSK | 16QAM | QPSK | |
| Normal (25°C) | Normal | 2.88 | 2.81 | 0.00345 | 0.00336 | PASS |
| Extreme (50°C) | | 5.45 | 1.88 | 0.00651 | 0.00225 | PASS |
| Extreme (40°C) | | 15.63 | 10.06 | 0.01869 | 0.01203 | PASS |
| Extreme (30°C) | | 7.89 | 15.22 | 0.00944 | 0.01819 | PASS |
| Extreme (20°C) | | 3.31 | 3.75 | 0.00395 | 0.00448 | PASS |
| Extreme (10°C) | | 8.93 | 7.69 | 0.01067 | 0.00920 | PASS |
| Extreme (0°C) | | 1.39 | 15.53 | 0.00166 | 0.01857 | PASS |
| Extreme (-10°C) | | 9.97 | 14.79 | 0.01192 | 0.01768 | PASS |
| Extreme (-20°C) | | 13.09 | 8.60 | 0.01565 | 0.01028 | PASS |
| Extreme (-30°C) | | 9.94 | 3.69 | 0.01188 | 0.00441 | PASS |
| 25°C | LV | 13.85 | 10.06 | 0.01656 | 0.01203 | PASS |
| | HV | 2.96 | 10.95 | 0.00354 | 0.01309 | PASS |

6.6. Spurious Emissions at Antenna Terminals

Sweep the whole frequency band through the range from 9kHz to the 10th harmonic of the carrier, the emissions more than 20 dB below the limit are not reported.

The signal beyond the limit is carrier.

LTE-M Band 5 1.4MHz CH-Low 9kHz~30GHz

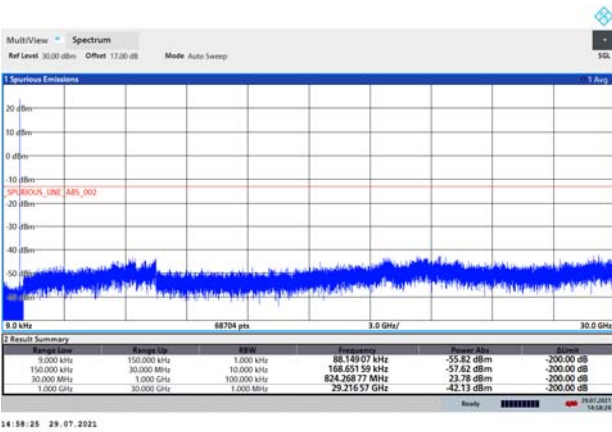

LTE-M Band 5 3MHz CH-Low 9kHz~30GHz

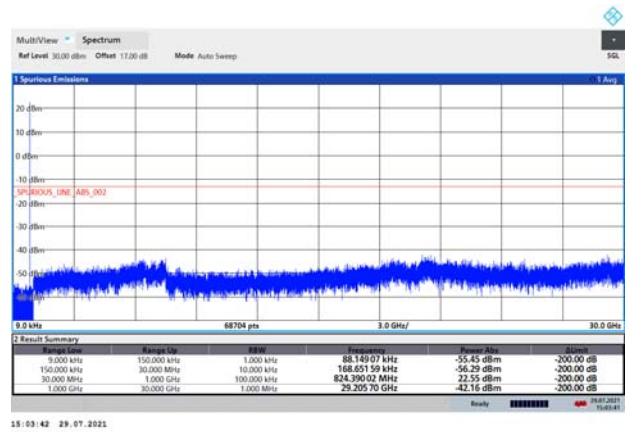

LTE-M Band 5 1.4MHz CH-Middle 9kHz~30GHz

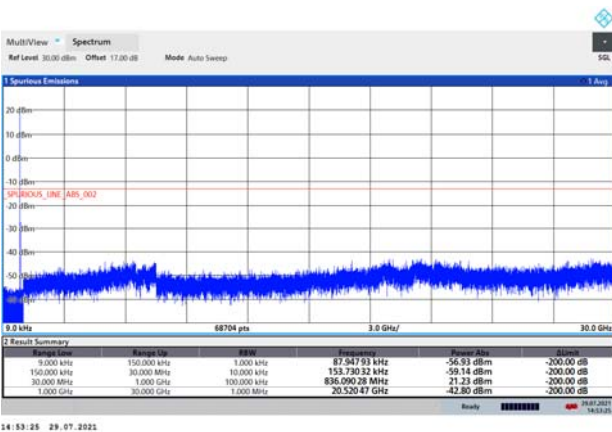

LTE-M Band 5 3MHz CH-Middle 9kHz~30GHz

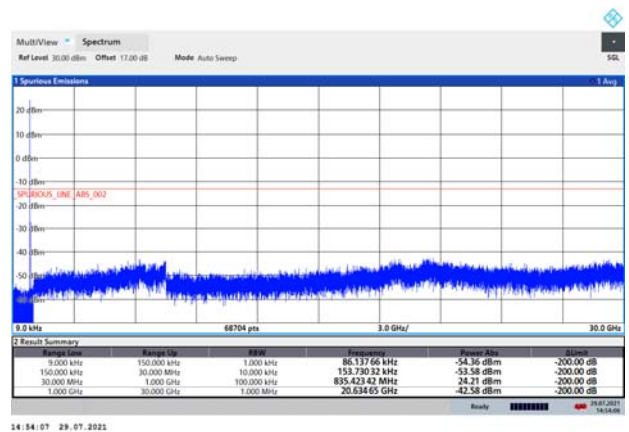

LTE-M Band 5 1.4MHz CH-High 9kHz~30GHz

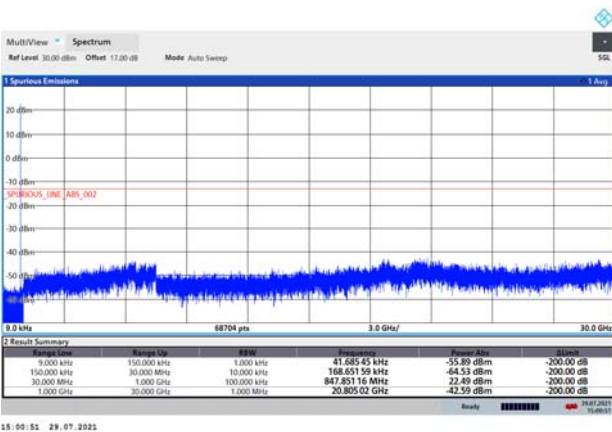

LTE-M Band 5 3MHz CH-High 9kHz~30GHz

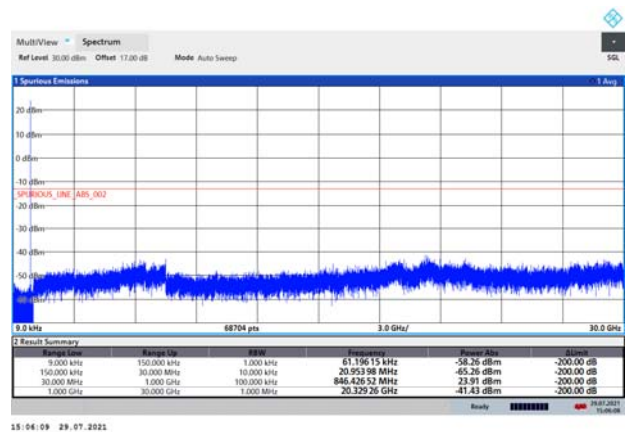

LTE-M Band 5 5MHz CH-Low 9kHz~30GHz

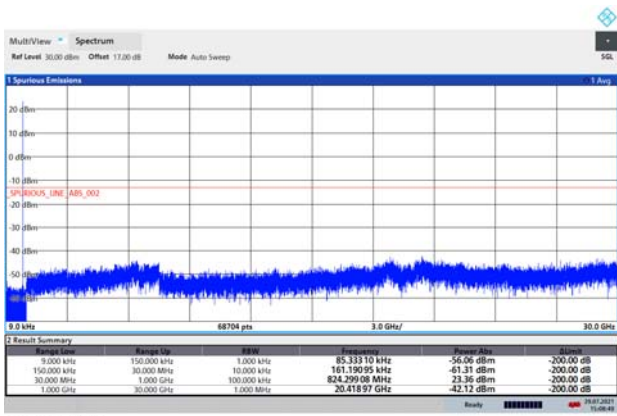

15:08:50 29.07.2021

LTE-M Band 5 10MHz CH-Low 9kHz~30GHz

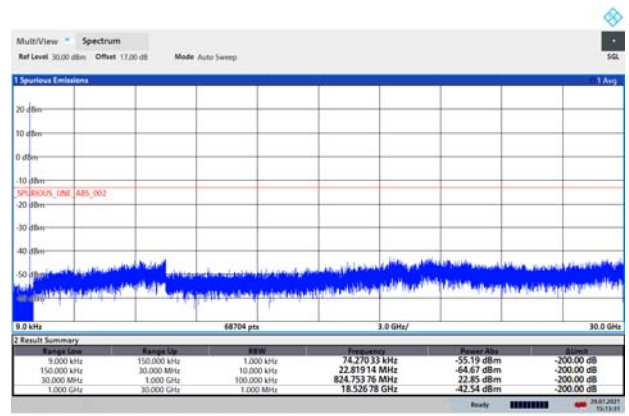

15:13:32 29.07.2021

LTE-M Band 5 5MHz CH-Middle 9kHz~30GHz

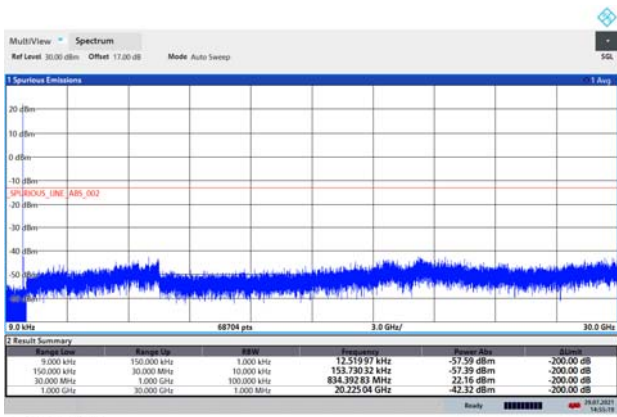

14:55:19 29.07.2021

LTE-M Band 5 10MHz CH-Middle 9kHz~30GHz

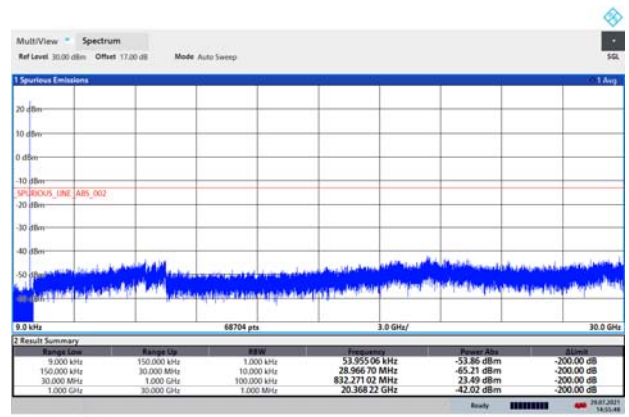

14:55:48 29.07.2021

LTE-M Band 5 5MHz CH-High 9kHz~30GHz

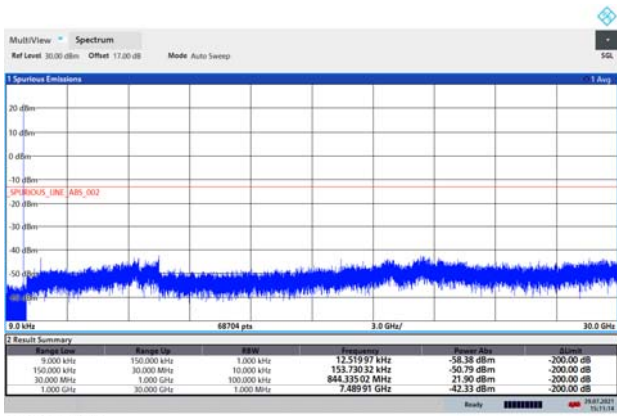

15:11:18 29.07.2021

LTE-M Band 5 10MHz CH-High 9kHz~30GHz

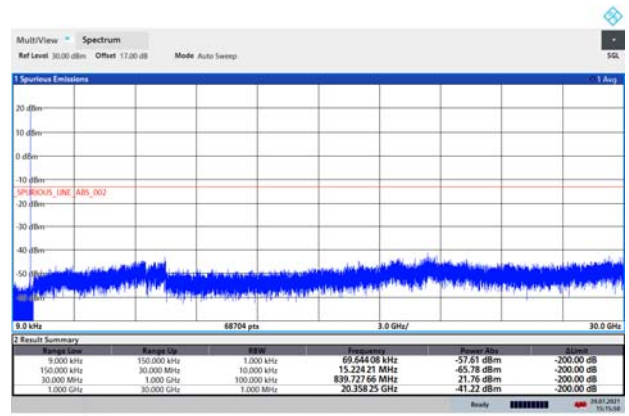

15:15:50 29.07.2021

6.7. Radiated Spurious Emission

Sweep the whole frequency band through the range from 9kHz to the 10th harmonic of the carrier, the emissions below the noise floor will not be recorded in the report.

LTE-M Band 5 1.4MHz CH-Middle

| Harmonic | Frequency (MHz) | SG (dBm) | Cable Loss (dB) | Gain (dBi) | Antenna Polarization | ERP Level (dBm) | Limit (dBm) | Margin (dB) | Azimuth (deg) |
|----------|-----------------|----------|-----------------|------------|----------------------|-----------------|-------------|-------------|---------------|
| 2 | 1673.00 | -61.61 | 1.70 | 8.70 | Horizontal | -56.76 | -13.00 | 43.76 | 180 |
| 3 | 2509.50 | -60.61 | 2.30 | 12.00 | Horizontal | -53.06 | -13.00 | 40.06 | 0 |
| 4 | 3346.00 | -64.79 | 2.70 | 12.70 | Horizontal | -56.94 | -13.00 | 43.94 | 45 |
| 5 | 4182.50 | -50.16 | 3.00 | 12.50 | Horizontal | -42.81 | -13.00 | 29.81 | 315 |
| 6 | 5019.00 | -43.45 | 3.40 | 12.50 | Horizontal | -36.50 | -13.00 | 23.50 | 90 |
| 7 | 5855.50 | -51.08 | 3.40 | 12.80 | Horizontal | -43.83 | -13.00 | 30.83 | 0 |
| 8 | 6692.00 | -58.85 | 4.10 | 11.50 | Horizontal | -53.60 | -13.00 | 40.60 | 45 |
| 9 | 7528.50 | -57.22 | 4.20 | 12.20 | Horizontal | -51.37 | -13.00 | 38.37 | 180 |
| 10 | 8365.00 | -54.95 | 4.30 | 12.50 | Horizontal | -48.90 | -13.00 | 35.90 | 0 |

Note: 1.The other Spurious RF Radiated emissions level is no more than noise floor.
2.The worst emission was found in the antenna is Horizontal position.

LTE-M Band 5 5MHz CH-Middle

| Harmonic | Frequency (MHz) | SG (dBm) | Cable Loss (dB) | Gain (dBi) | Antenna Polarization | ERP Level (dBm) | Limit (dBm) | Margin (dB) | Azimuth (deg) |
|----------|-----------------|----------|-----------------|------------|----------------------|-----------------|-------------|-------------|---------------|
| 2 | 1668.60 | -61.24 | 1.70 | 8.70 | Horizontal | -56.39 | -13.00 | 43.39 | 315 |
| 3 | 2503.30 | -60.70 | 2.30 | 12.00 | Horizontal | -53.15 | -13.00 | 40.15 | 90 |
| 4 | 3337.50 | -64.06 | 2.70 | 12.70 | Horizontal | -56.21 | -13.00 | 43.21 | 180 |
| 5 | 4171.88 | -51.00 | 3.00 | 12.50 | Horizontal | -43.65 | -13.00 | 30.65 | 45 |
| 6 | 5006.25 | -42.40 | 3.40 | 12.50 | Horizontal | -35.45 | -13.00 | 22.45 | 180 |
| 7 | 5840.63 | -51.12 | 3.40 | 12.80 | Horizontal | -43.87 | -13.00 | 30.87 | 180 |
| 8 | 6675.00 | -59.41 | 4.10 | 11.50 | Horizontal | -54.16 | -13.00 | 41.16 | 0 |
| 9 | 7509.38 | -55.03 | 4.20 | 12.20 | Horizontal | -49.18 | -13.00 | 36.18 | 45 |
| 10 | 8343.75 | -56.07 | 4.30 | 12.50 | Horizontal | -50.02 | -13.00 | 37.02 | 90 |

Note: 1.The other Spurious RF Radiated emissions level is no more than noise floor.
2.The worst emission was found in the antenna is Horizontal position.

LTE-M Band 5 10MHz CH-Middle

| Harmonic | Frequency (MHz) | SG (dBm) | Cable Loss (dB) | Gain (dBi) | Antenna Polarization | ERP Level (dBm) | Limit (dBm) | Margin (dB) | Azimuth (deg) |
|----------|-----------------|----------|-----------------|------------|----------------------|-----------------|-------------|-------------|---------------|
| 2 | 1664.40 | -61.16 | 1.70 | 8.70 | Horizontal | -56.31 | -13.00 | 43.31 | 0 |
| 3 | 2496.60 | -57.85 | 2.30 | 12.00 | Horizontal | -50.30 | -13.00 | 37.30 | 180 |
| 4 | 3346.00 | -64.06 | 2.70 | 12.70 | Horizontal | -56.21 | -13.00 | 43.21 | 0 |
| 5 | 4182.50 | -51.27 | 3.00 | 12.50 | Horizontal | -43.92 | -13.00 | 30.92 | 180 |
| 6 | 5019.00 | -43.66 | 3.40 | 12.50 | Horizontal | -36.71 | -13.00 | 23.71 | 45 |
| 7 | 5855.50 | -51.23 | 3.40 | 12.80 | Horizontal | -43.98 | -13.00 | 30.98 | 90 |
| 8 | 6692.00 | -58.70 | 4.10 | 11.50 | Horizontal | -53.45 | -13.00 | 40.45 | 90 |
| 9 | 7528.50 | -55.13 | 4.20 | 12.20 | Horizontal | -49.28 | -13.00 | 36.28 | 45 |
| 10 | 8365.00 | -55.71 | 4.30 | 12.50 | Horizontal | -49.66 | -13.00 | 36.66 | 315 |

Note: 1.The other Spurious RF Radiated emissions level is no more than noise floor.

2.The worst emission was found in the antenna is Horizontal position.

7. Main Test Instruments

| Name | Manufacturer | Type | Serial Number | Calibration Date | Expiration Date |
|--------------------------------------|--------------|--------------|--------------------|------------------|-----------------|
| Base Station Simulator | R&S | CMW500 | 113645 | 2021-05-15 | 2022-05-14 |
| Climate Chamber | Weiss | VT4002 | 58226119450 010 | 2021-05-15 | 2022-05-14 |
| Power Splitter | Hua Xiang | SHX-GF2-2-13 | 10120101 | / | / |
| Spectrum Analyzer | Key sight | N9010A | MY50210259 | 2020-05-18 | 2022-05-14 |
| Universal Radio Communication Tester | Key sight | E5515C | MY48367192 | 2021-05-15 | 2022-05-14 |
| Signal Analyzer | R&S | FSV3030 | 101411 | 2020-12-13 | 2021-12-12 |
| Loop Antenna | SCHWARZBECK | FMZB1519 | 1519-047 | 2020-04-02 | 2023-04-01 |
| TRILOG Broadband Antenna | SCHWARZBECK | VULB 9163 | 391 | 2019-12-16 | 2021-12-15 |
| Horn Antenna | R&S | HF907 | 102723 | 2018-08-11 | 2021-08-10 |
| Signal generator | R&S | SMB 100A | 180235 | 2021-05-15 | 2022-05-14 |
| Climatic Chamber | ESPEC | SU-242 | 93000506 | 2020-12-13 | 2021-12-12 |
| Preamplifier | R&S | SCU18 | 102327 | 2021-05-15 | 2022-05-14 |
| MOB COMMS DC SUPPLY | Keysight | 66319D | MY43004105 | 2021-05-15 | 2022-05-14 |
| Software | R&S | EMC32 | 9.26.0 | / | / |

ANNEX A: The EUT Appearance

The EUT Appearance is submitted separately.

ANNEX B: Test Setup Photos

The Test Setup Photos is submitted separately.

ANNEX C: Product Change Description (Variant 1)

The Product Change Description are submitted separately.

ANNEX D: Product Change Description (Variant 2)

The Product Change Description are submitted separately.

***** END OF REPORT *****