



# RF TEST REPORT

**Applicant**      Quectel Wireless Solutions Co., Ltd.  
**FCC ID**          XMR2022BG952AGL  
**Product**        LTE Cat M1 & Cat NB1 Module  
**Brand**            Quectel  
**Model**            BG952A-GL  
**Report No.**      R2206A0479-R8  
**Issue Date**      June 22, 2022

TA Technology (Shanghai) Co., Ltd. tested the above equipment in accordance with the requirements in **FCC CFR47 Part 2 (2021)/ FCC CFR 47 Part 22H (2021)**. The test results show that the equipment tested is capable of demonstrating compliance with the requirements as documented in this report.

Prepared by: Peng Tao

Approved by: Kai Xu

---

**TA Technology (Shanghai) Co., Ltd.**

No.145, Jintang Rd, Tangzhen Industry Park, Pudong Shanghai, China

TEL: +86-021-50791141/2/3

FAX: +86-021-50791141/2/3-8000



## TABLE OF CONTENT

1. Test Laboratory .....	4
1.1. Notes of the Test Report .....	4
1.2. Test facility .....	4
1.3. Testing Location .....	4
2. General Description of Equipment under Test.....	5
2.1. Applicant and Manufacturer Information .....	5
2.2. General Information.....	5
3. Applied Standards .....	6
4. Test Configuration.....	7
5. Test Case Results.....	8
5.1. RF Power Output and Effective Radiated Power Ambient condition .....	8
5.2. Occupied Bandwidth .....	10
5.3. Band Edge Compliance.....	14
5.4. Peak-to-Average Power Ratio (PAPR) .....	21
5.5. Frequency Stability.....	23
5.6. Spurious Emissions at Antenna Terminals .....	26
5.7. Radiates Spurious Emission .....	29
6. Main Test Instruments .....	34
ANNEX A: The EUT Appearance .....	35
ANNEX B: Test Setup Photos .....	36
<b>ANNEX C: Product Change Description .....</b>	<b>37</b>

### Summary of measurement results

No.	Test Case	Clause in FCC rules	Verdict
1	RF Power Output and Effective Radiated Power	2.1046 22.913(a)(5)	PASS
2	Occupied Bandwidth	2.1049	PASS
3	Band Edge Compliance	2.1051 / 22.917(a)	PASS
4	Peak-to-Average Power Ratio	22.913(d)/ KDB 971168 D01(5.7)	PASS
5	Frequency Stability	2.1055 / 22.355	PASS
6	Spurious Emissions at Antenna Terminals	2.1051 / 22.917(a)	PASS
7	Radiates Spurious Emission	2.1053 / 22.917 (a)	PASS

Date of Testing: July 21, 2021 ~ August 5, 2021

Date of Sample Received: July 20, 2021

Note: PASS: The EUT complies with the essential requirements in the standard.

FAIL: The EUT does not comply with the essential requirements in the standard.

All indications of Pass/Fail in this report are opinions expressed by TA Technology (Shanghai) Co., Ltd. based on interpretations and/or observations of test results. Measurement Uncertainties were not taken into account and are published for informational purposes only.

**BG952A-GL (Report No.: R2206A0479-R8) is a variant model of BG950A-GL (Report No.: R2107A0607-R8). Test values duplicated from Original for variant. The power of new variant are varied due to measurement uncertainty, and sample tolerance of the acceptance range. The detailed product change description please refers to following table:**

Module	BG950A-GL	BG952A-GL
QuecOpen®	N/A	Supported
Hardware Version	R1.3	R1.5
Software Version	BG950AGLAAR01A01	BG952AGLAAR01A03
Product Name	LTE Module	LTE Cat M1 & Cat NB1 Module
Others	The same	

**The detailed product change description please refers to the Difference Declaration Letter.**



## 1. Test Laboratory

### 1.1. Notes of the Test Report

This report shall not be reproduced in full or partial, without the written approval of **TA technology (shanghai) co., Ltd.** The results documented in this report apply only to the tested sample, under the conditions and modes of operation as described herein. Measurement Uncertainties were not taken into account and are published for informational purposes only. This report is written to support regulatory compliance of the applicable standards stated above.

### 1.2. Test facility

#### **FCC (Designation number: CN1179, Test Firm Registration Number: 446626)**

TA Technology (Shanghai) Co., Ltd. has been listed on the US Federal Communications Commission list of test facilities recognized to perform measurements.

#### **A2LA (Certificate Number: 3857.01)**

TA Technology (Shanghai) Co., Ltd. has been listed by American Association for Laboratory Accreditation to perform measurement.

### 1.3. Testing Location

Company: TA Technology (Shanghai) Co., Ltd.  
Address: No.145, Jintang Rd, Tangzhen Industry Park, Pudong  
City: Shanghai  
Post code: 201201  
Country: P. R. China  
Contact: Xu Kai  
Telephone: +86-021-50791141/2/3  
Fax: +86-021-50791141/2/3-8000  
Website: <http://www.ta-shanghai.com>  
E-mail: [xukai@ta-shanghai.com](mailto:xukai@ta-shanghai.com)

## 2. General Description of Equipment under Test

### 2.1. Applicant and Manufacturer Information

Applicant	Quectel Wireless Solutions Co., Ltd.
Applicant address	Building 5, Shanghai Business Park Phase III (Area B), No.1016 Tianlin Road, Minhang District, Shanghai, China, 200233
Manufacturer	Quectel Wireless Solutions Co., Ltd.
Manufacturer address	Building 5, Shanghai Business Park Phase III (Area B), No.1016 Tianlin Road, Minhang District, Shanghai, China, 200233

### 2.2. General Information

EUT Description			
Model	BG952A-GL		
IMEI	869410050002659		
Hardware Version	R1.5		
Software Version	BG952AGLAAR01A03		
Power Supply	External power supply		
Antenna Type	External Antenna		
Antenna Gain	Mode	Frequency (MHz)	Gain (dBi)
	LTE Band 5;	820	2.53
		830	2.13
		840	1.89
850		2.29	
Test Mode(s)	LTE Band 5		
Test Modulation	QPSK ,16QAM;		
LTE Category	M1		
Maximum E.R.P.	LTE Band 5:	24.32dBm	
Rated Power Supply Voltage	3.3V		
Operating Voltage	Minimum: 2.2V    Maximum: 4.35V		
Operating Temperature	Lowest: -35°C    Highest: +75°C		
Extreme Temperature	Lowest: -35°C    Highest: +75°C		
Frequency Range(s)	Band	Tx (MHz)	Rx (MHz)
	LTE Band 5	824 ~ 849	869 ~ 894
Note: 1. The EUT is sent from the applicant to TA and the information of the EUT is declared by the applicant.			



### 3. Applied Standards

According to the specifications of the manufacturer, it must comply with the requirements of the following standards:

**Test standards:**

**FCC CFR 47 Part 22H (2021)**

**ANSI C63.26-2015**

**Reference standard:**

**FCC CFR47 Part 2 (2021)**

**KDB 971168 D01 Power Meas License Digital Systems v03r01**

### 4. Test Configuration

Radiated measurements are performed by rotating the EUT in three different orthogonal test planes. EUT stand-up position (Z axis), lie-down position (X, Y axis). Receiver antenna polarization (horizontal and vertical), the worst emission was found in position (X, Y axis, vertical polarization) and the worst case was recorded.

All mode and data rates and positions and RB size and modulations were investigated.

Subsequently, only the worst case emissions are reported.

The following testing in LTE is set based on the maximum RF Output Power.

Test modes are chosen as the worst case configuration below for LTE Band 5

Test items	Modes	Bandwidth (MHz)					Modulation		RB			Test Channel			
		1.4	3	5	10	15	QPSK	16QAM	1	50%	100%	L	M	H	
RF power output and Effective Radiated power	LTE 5	O	O	O	O	-	O	O	O	O	O	O	O	O	O
Occupied Bandwidth	LTE 5	O	O	O	O	-	O	O	-	-	O	O	O	O	
Band Edge Compliance	LTE 5	O	O	O	O	-	O	O	O	-	O	O	-	O	
Peak-to-Average Power Ratio	LTE 5	O	O	O	O	-	O	O	-	-	O	O	O	O	
Frequency Stability	LTE 5	O	O	O	O	-	O	O	O	-	-	-	O	-	
Spurious Emissions at Antenna Terminals	LTE 5	O	O	O	O	-	O	-	O	-	-	O	O	O	
Radiates Spurious Emission	LTE 5	O	-	O	O	-	O	-	O	-	-	-	O	-	
Note	1. The mark "O" means that this configuration is chosen for testing. 2. The mark "-" means that this configuration is not testing.														

## 5. Test Case Results

### 5.1. RF Power Output and Effective Radiated Power Ambient condition

Temperature	Relative humidity	Pressure
23°C ~25°C	45%~50%	101.5kPa

#### Methods of Measurement

During the process of the testing, The EUT was connected to the Base Station Simulator with a known loss. The EUT is controlled by the Base Station Simulator test set to ensure max power transmission with proper modulation.

ERP can then be calculated as follows:

$$\text{EIRP (dBm)} = \text{Output Power (dBm)} - \text{Losses (dB)} + \text{Antenna Gain (dBi)}$$

where:dBd refers to gain relative to an ideal dipole.

$$\text{EIRP (dBm)} = \text{ERP (dBm)} + 2.15 \text{ (dB)}$$

#### Test Setup

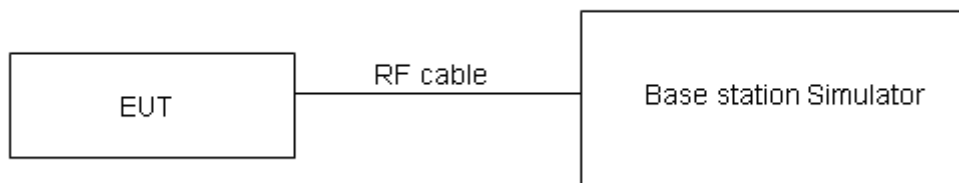

#### Limits

No specific RF power output requirements in part 2.1046.

Rule Part 22.913(a)(5) specifies that "Mobile/portable stations are limited to 7 watts ERP".

Limit	≤ 7 W (38.45 dBm)
-------	-------------------

#### Measurement Uncertainty

The assessed measurement uncertainty to ensure 95% confidence level for the normal distribution is with the coverage factor  $k = 2$ ,  $U = 0.4 \text{ dB}$  for RF power output,  $k = 2$ ,  $U = 1.19 \text{ dB}$  for ERP.





## Test Results

LTE Band 5	Channel/ Frequency(MHz)	Index	RB# RB start		Maximum Output Power (dBm)		ERP (dBm)	
			QPSK	16QAM	QPSK	16QAM	QPSK	16QAM
1.4MHz	20407/824.7	0	1#0	1#0	23.94	22.83	24.32	23.21
		0	6#0	5#0	22.54	22.15	22.92	22.53
	20525/836.5	0	1#0	1#0	23.91	22.74	23.65	22.48
		0	6#0	5#0	22.51	22.01	22.25	21.75
	20643/848.3	0	1#5	1#5	23.82	22.84	23.96	22.98
		0	6#0	5#0	22.39	22.03	22.53	22.17
3MHz	20415/825.5	0	1#0	1#0	23.73	23.25	23.71	23.23
		0	6#0	5#0	22.35	22.12	22.33	22.10
	20525/836.5	0	1#0	1#0	23.65	23.22	23.39	22.96
		0	6#0	5#0	22.33	22.09	22.07	21.83
	20635/847.5	1	1#5	1#5	23.76	23.05	23.90	23.19
		0	6#0	5#0	22.25	22.03	22.39	22.17
5MHz	20425/826.5	3	1#0	1#0	22.80	23.22	22.78	23.20
		0	6#0	5#0	23.33	22.08	23.31	22.06
	20525/836.5	0	1#0	1#0	23.03	21.67	22.77	21.41
		0	6#0	5#0	23.33	21.99	23.07	21.73
	20625/846.5	0	1#5	1#5	23.70	23.98	23.84	24.12
		0	6#0	5#0	23.36	21.97	23.50	22.11
10MHz	20450/829	3	1#0	1#0	22.82	23.24	22.80	23.22
		0	4#0	4#0	23.09	23.11	23.07	23.09
	20525/836.5	0	1#0	1#0	22.98	23.45	22.72	23.19
		0	4#0	4#0	23.25	23.04	22.99	22.78
	20600/844	4	1#5	1#5	23.73	23.04	23.47	22.78
		7	4#2	4#2	23.77	22.15	23.51	21.89

## 5.2. Occupied Bandwidth

### Ambient condition

Temperature	Relative humidity	Pressure
23°C ~25°C	45%~50%	101.5kPa

### Method of Measurement

The EUT was connected to Spectrum Analyzer and Base Station Simulator via power Splitter. The occupied bandwidth is measured using spectrum analyzer.

RBW is set to 51kHz, VBW is set to 160kHz for LTE Band 5

99% power and -26dBc occupied bandwidths are recorded. Spectrum analyzer plots are included on the following pages.

### Test Setup

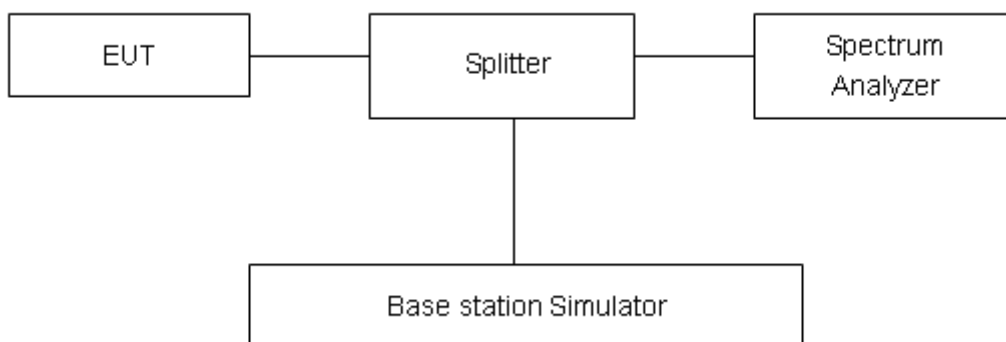

### Limits

No specific occupied bandwidth requirements in part 2.1049.

### Measurement Uncertainty

The assessed measurement uncertainty to ensure 95% confidence level for the normal distribution is with the coverage factor  $k = 2$ ,  $U = 624\text{Hz}$ .

**Test Result**

Mode	Bandwidth	Modulation	Channel/ Frequency(MHz)	Bandwidth(MHz)	
				99% Power	-26dBc
Band 5	1.4MHz	QPSK	20525/836.5	1.102	1.314
		16QAM	20525/836.5	0.954	1.298
	3MHz	QPSK	20525/836.5	1.111	1.389
		16QAM	20525/836.5	0.963	1.303
	5MHz	QPSK	20525/836.5	1.101	1.325
		16QAM	20525/836.5	0.971	1.316
	10MHz	QPSK	20525/836.5	1.104	1.330
		16QAM	20525/836.5	0.990	1.318



LTE Band 5 QPSK 1.4MHz CH-Middle



LTE Band 5 QPSK 3MHz CH-Middle



LTE Band 5 QPSK 5MHz CH-Middle



LTE Band 5 QPSK 10MHz CH-Middle

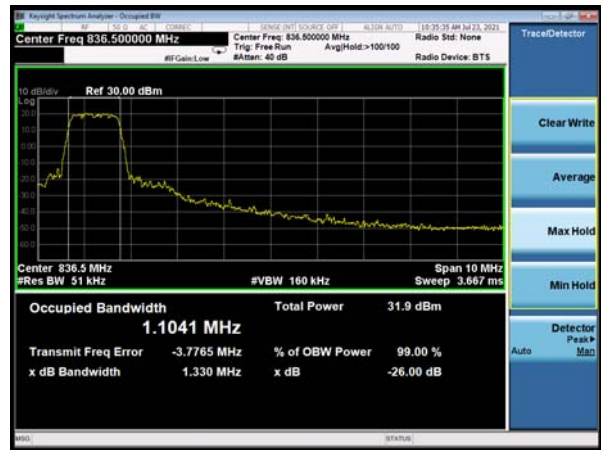

LTE Band 5 16QAM 1.4MHz CH-Middle



LTE Band 5 16QAM 3MHz CH-Middle



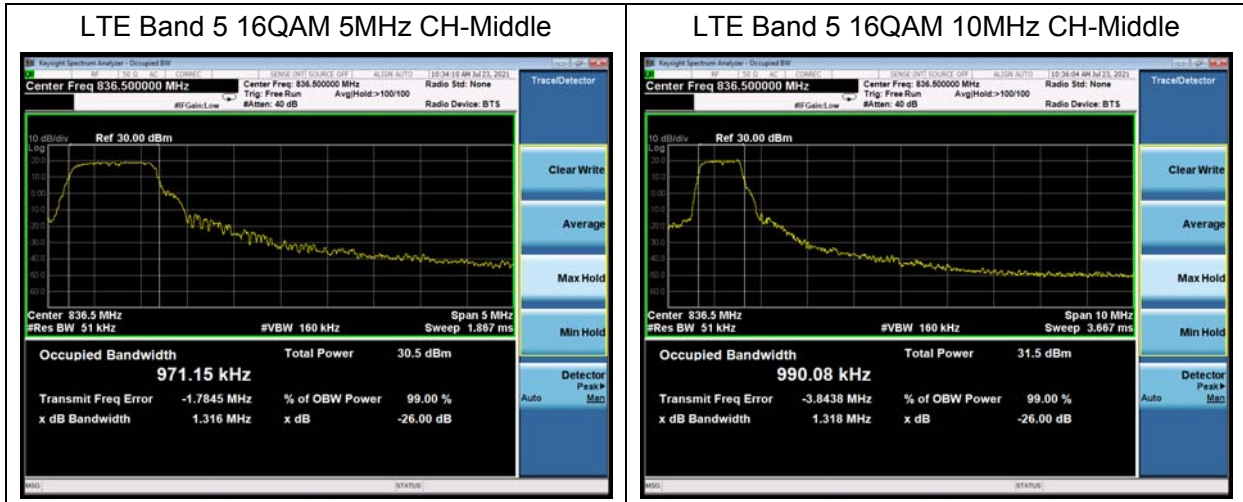

### 5.3. Band Edge Compliance

#### Ambient condition

Temperature	Relative humidity	Pressure
23°C ~25°C	45%~50%	101.5kPa

#### Method of Measurement

The EUT was connected to Spectrum Analyzer and Base Station Simulator via power Splitter. The band edge of the lowest and highest channels were measured. The average detector is used. RBW is set to 51kHz, VBW is set to 160kHz for LTE Band 5,

Spectrum analyzer plots are included on the following pages.

#### Test Setup

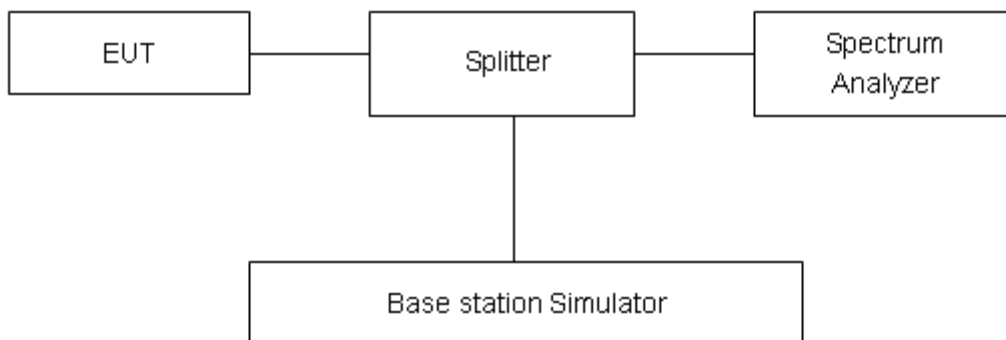

#### Limits

Rule Part 22.917(a) specifies that “The power of any emission outside of the authorized operating frequency ranges must be attenuated below the transmitting power (P) by a factor of at least 43 + 10 log(P) dB.”

Limit	-13 dBm
-------	---------

#### Measurement Uncertainty

The assessed measurement uncertainty to ensure 95% confidence level for the normal distribution is with the coverage factor  $k = 1.96$ ,  $U=0.684$ dB.



Test Result:

LTE Band 5 QPSK 1.4MHz CH-Low 1RB

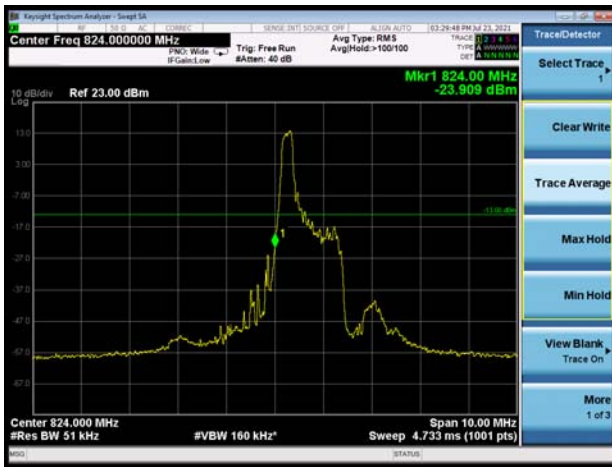

LTE Band 5 QPSK 1.4MHz CH-High 1RB



LTE Band 5 QPSK 1.4MHz CH-Low 100%RB

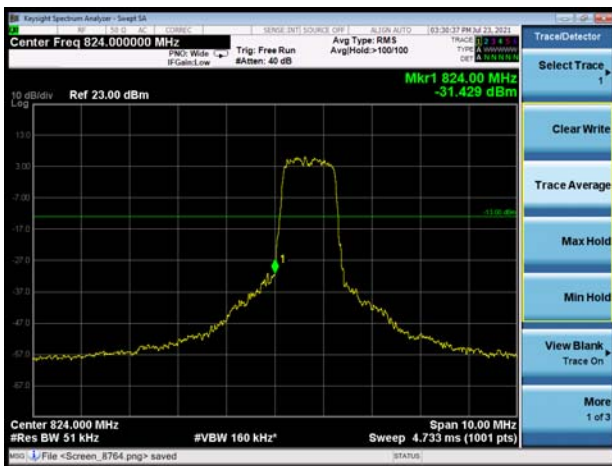

LTE Band 5 QPSK 1.4MHz CH-High 100%RB

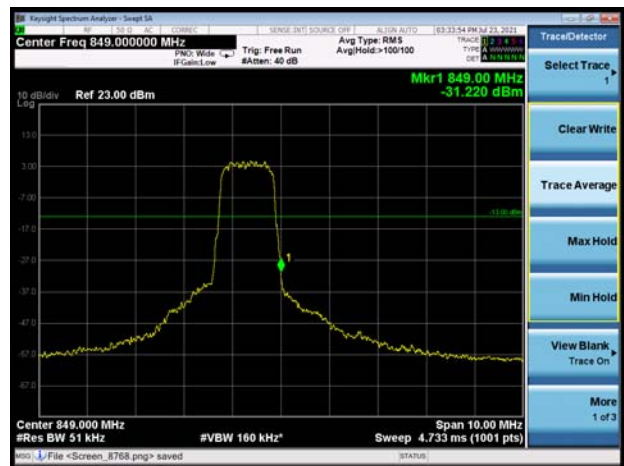

LTE Band 5 QPSK 3MHz CH-Low 1RB



LTE Band 5 QPSK 3MHz CH-High 1RB



LTE Band 5 QPSK 3MHz CH-Low 100%RB

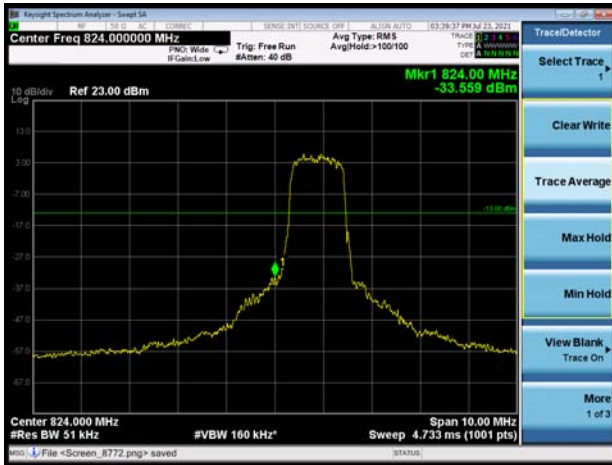

LTE Band 5 QPSK 3MHz CH-High 100%RB

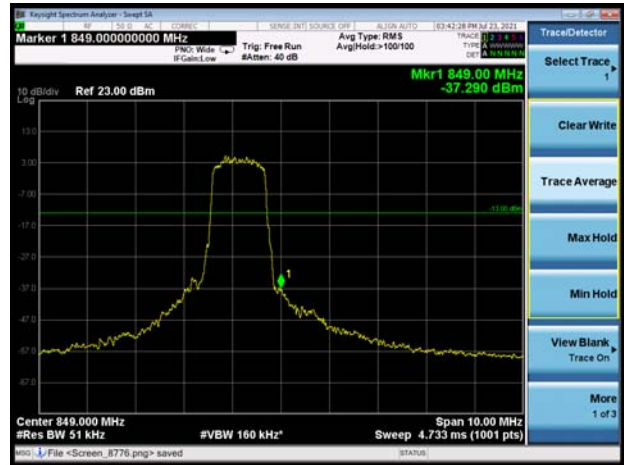

LTE Band 5 QPSK 5MHz CH-Low 1RB



LTE Band 5 QPSK 5MHz CH-High 1RB



LTE Band 5 QPSK 5MHz CH-Low 100%RB

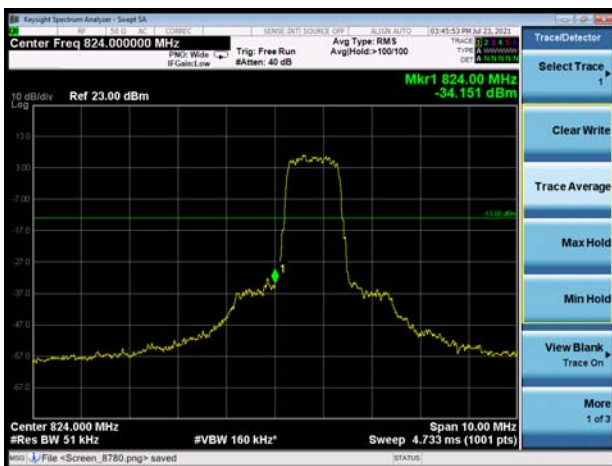

LTE Band 5 QPSK 5MHz CH-High 100%RB

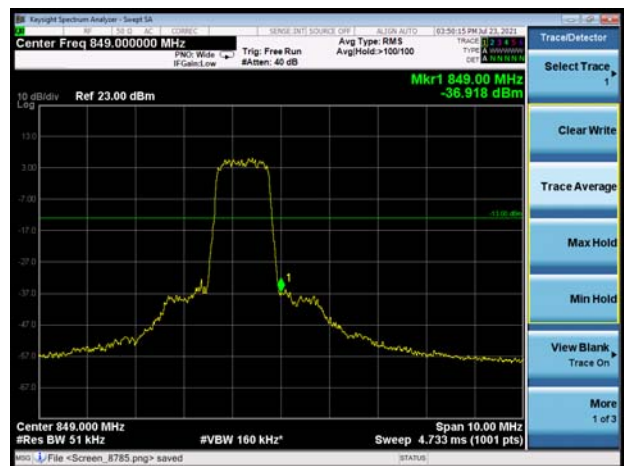



LTE Band 5 QPSK 10MHz CH-Low 1RB



LTE Band 5 QPSK 10MHz CH-High 1RB



LTE Band 5 QPSK 10MHz CH-Low 100%RB



LTE Band 5 QPSK 10MHz CH-High 100%RB

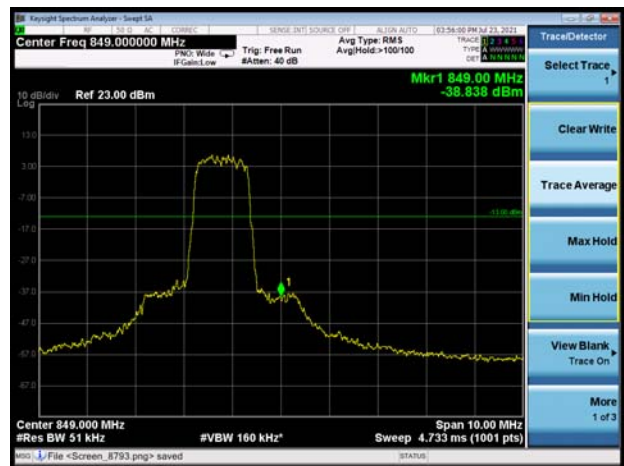

LTE Band 5 16QAM 1.4MHz CH-Low 1RB

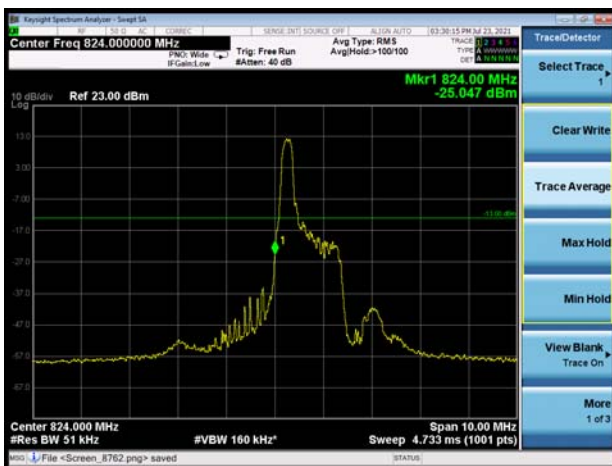

LTE Band 5 16QAM 1.4MHz CH-High 1RB



LTE Band 5 16QAM 1.4MHz CH-Low 100%RB

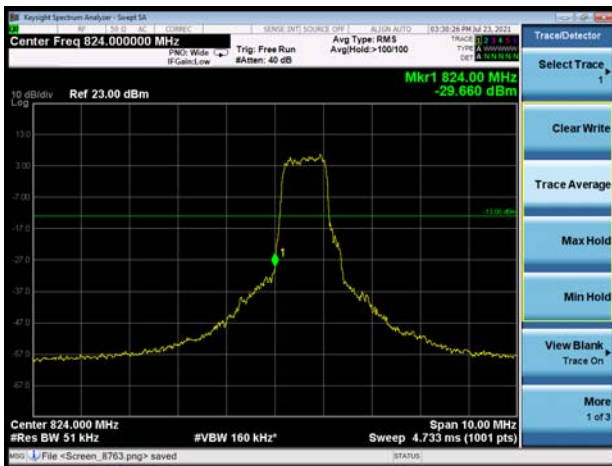

LTE Band 5 16QAM 1.4MHz CH-High 100%RB

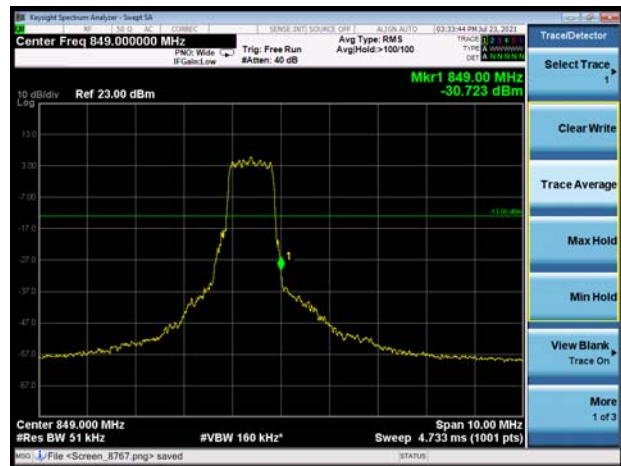

LTE Band 5 16QAM 3MHz CH-Low 1RB



LTE Band 5 16QAM 3MHz CH-High 1RB



LTE Band 5 16QAM 3MHz CH-Low 100%RB

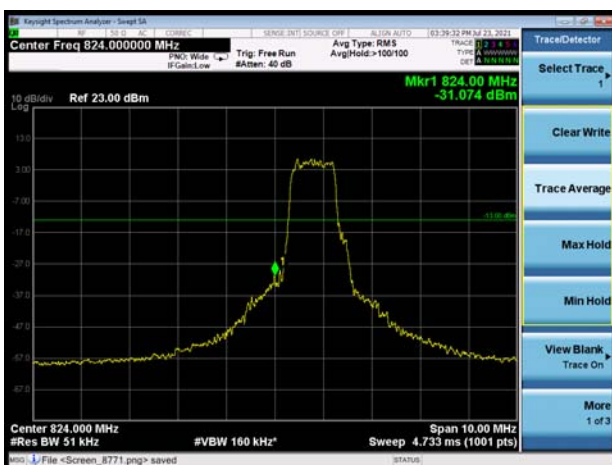

LTE Band 5 16QAM 3MHz CH-High 100%RB

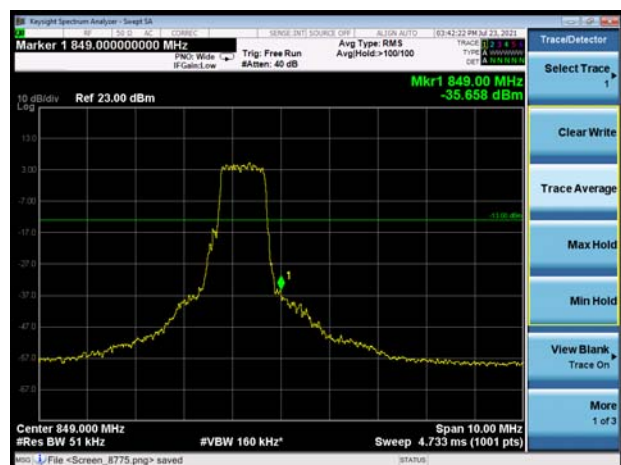

LTE Band 5 16QAM 5MHz CH-Low 1RB



LTE Band 5 16QAM 5MHz CH-High 1RB



LTE Band 5 16QAM 5MHz CH-Low 100%RB

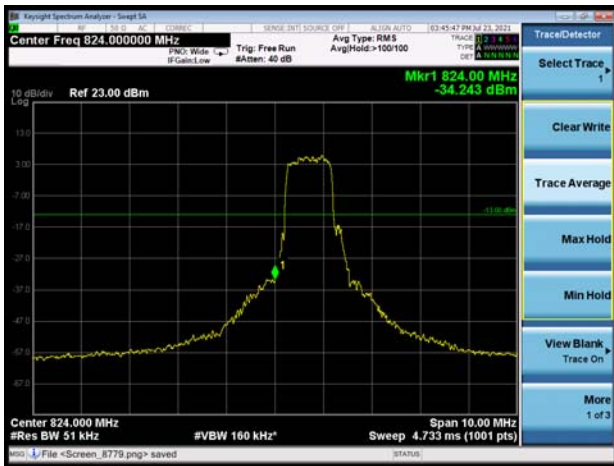

LTE Band 5 16QAM 5MHz CH-High 100%RB

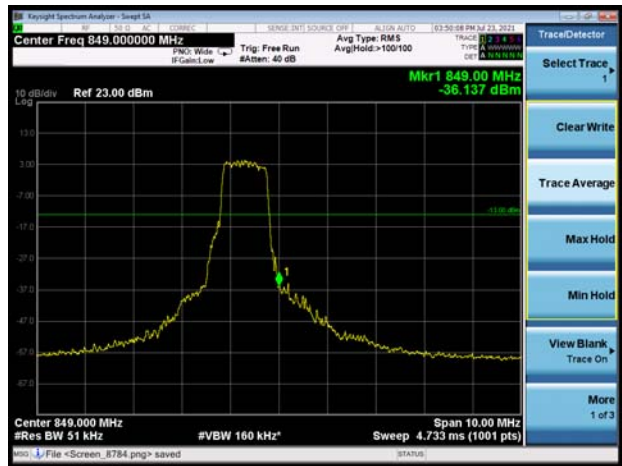

LTE Band 5 16QAM 10MHz CH-Low 1RB

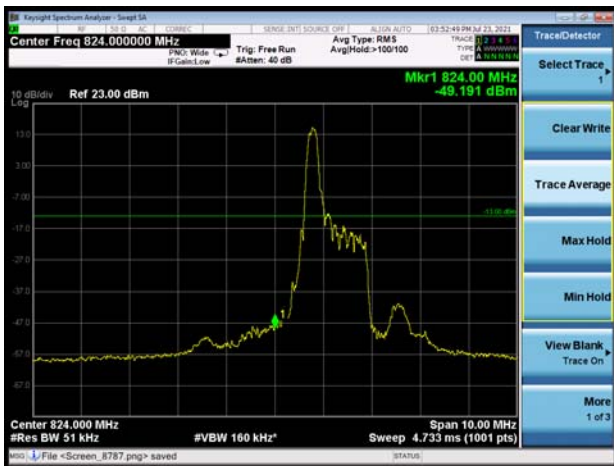

LTE Band 5 16QAM 10MHz CH-High 1RB





LTE Band 5 16QAM 10MHz CH-Low 100%RB

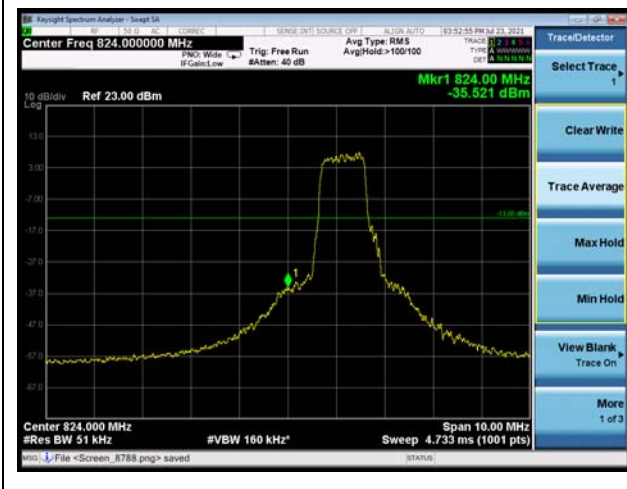

LTE Band 5 16QAM 10MHz CH-High 100%RB



## 5.4. Peak-to-Average Power Ratio (PAPR)

### Ambient condition

Temperature	Relative humidity	Pressure
23°C ~25°C	45%~50%	101.5kPa

### Methods of Measurement

Measure the total peak power and record as  $P_{Pk}$ . And measure the total average power and record as  $P_{Avg}$ . Both the peak and average power levels must be expressed in the same logarithmic units (e.g., dBm). Determine the PAPR from:

$$PAPR (dB) = P_{Pk} (dBm) - P_{Avg} (dBm).$$

### Test Setup

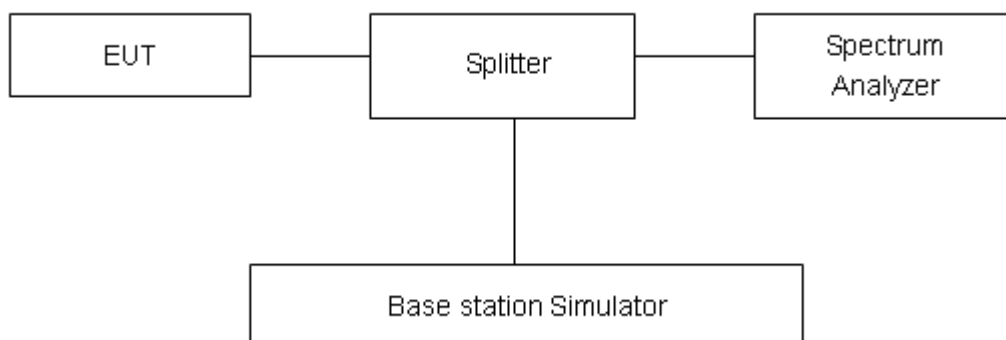

### Limits

According to the Sec. 22.913(d), The peak-to-average ratio (PAR) of the transmission must not exceed 13 dB.

### Measurement Uncertainty

The assessed measurement uncertainty to ensure 95% confidence level for the normal distribution is with the coverage factor  $k = 2$ ,  $U = 0.4$  dB.



## Test Results

Mode	Bandwidth	Modulation	Channel/ Frequency (MHz)	Peak-to-Average Power Ratio (PAPR)			Limit (dB)	Conclusion
				Peak (dBm)	Avg (dBm)	PAPR (dB)		
Band5	1.4MHz	QPSK	20525/836.5	26.87	16.43	10.44	≤13	PASS
		16QAM	20525/836.5	27.64	17.29	10.35	≤13	PASS
	3MHz	QPSK	20525/836.5	26.81	16.90	9.91	≤13	PASS
		16QAM	20525/836.5	27.39	16.01	11.38	≤13	PASS
	5MHz	QPSK	20525/836.5	27.78	18.28	9.50	≤13	PASS
		16QAM	20525/836.5	27.77	16.94	10.83	≤13	PASS
	10MHz	QPSK	20525/836.5	27.86	18.24	9.62	≤13	PASS
		16QAM	20525/836.5	28.56	17.98	10.58	≤13	PASS

## 5.5. Frequency Stability

### Ambient condition

Temperature	Relative humidity	Pressure
23°C ~25°C	45%~50%	101.5kPa

### Method of Measurement

#### Frequency Stability (Temperature Variation)

The temperature inside the climate chamber is varied from -35°C to +75°C in 10°C step size,

(1) With all power removed, the temperature was decreased to 0°C and permitted to stabilize for three hours.

(2) Measure the carrier frequency with the test equipment in a “call mode”. These measurements should be made within 1 minute of powering up the mobile station, to prevent significant self warming.

(3) Repeat the above measurements at 10°C increments from -35°C to +75° Allow at least 1.5 hours at each temperature, un-powered, before making measurements.

#### Frequency Stability (Voltage Variation)

The frequency stability shall be measured with variation of primary supply voltage as follows:

**Primary Supply Voltage:** The primary supply voltage is varied from 85% to 115% of the nominal value for non hand-carried battery and AC powered equipment. For hand-carried, battery-powered equipment, primary supply voltage is reduced to the battery operating end point which shall be specified by the manufacturer.

This transceiver is specified to operate with an input voltage of between 2.2V and 4.35 V, with a nominal voltage of 3.3V.

### Test setup

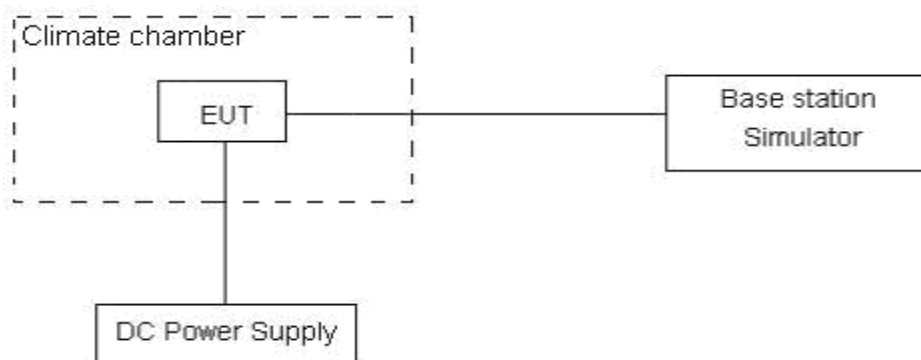

### Limits

According to the Sec. 22.355, the frequency stability of the carrier shall be accurate to within 2.5 ppm of the received frequency for mobile stations.

Limits	≤ 2.5 ppm
--------	-----------

### Measurement Uncertainty

The assessed measurement uncertainty to ensure 99.75% confidence level for the normal distribution is with the coverage factor  $k = 3$ ,  $U = 0.01\text{ppm}$ .





## Test Result

LTE band5						
Condition		Freq.Error (Hz)	Freq.Error (Hz)	Frequency Stability (ppm)	Frequency Stability (ppm)	Verdict
BANDWIDTH	1.4MHz					
Temperature	Voltage	16QAM	QPSK	16QAM	QPSK	
Normal (25°C)	Normal	3.78	7.72	0.00452	0.00923	PASS
Extreme (75°C)		8.45	14.15	0.01011	0.01692	PASS
Extreme (70°C)		10.35	7.62	0.01237	0.00911	PASS
Extreme (60°C)		16.31	5.99	0.01950	0.00716	PASS
Extreme (50°C)		13.02	4.66	0.01557	0.00557	PASS
Extreme (40°C)		14.93	15.07	0.01785	0.01801	PASS
Extreme (30°C)		4.83	9.67	0.00577	0.01156	PASS
Extreme (20°C)		11.73	12.53	0.01403	0.01498	PASS
Extreme (10°C)		17.11	1.13	0.02046	0.00135	PASS
Extreme (0°C)		12.90	12.95	0.01542	0.01548	PASS
Extreme (-10°C)		4.54	7.94	0.00543	0.00949	PASS
Extreme (-20°C)		8.80	1.86	0.01052	0.00223	PASS
Extreme (-30°C)		4.45	2.77	0.00532	0.00332	PASS
Extreme (-35°C)			3.56	8.08	0.00425	0.00965
25°C	LV	4.54	12.66	0.00543	0.01514	PASS
	HV	1.57	9.42	0.00188	0.01126	PASS
Condition		Freq.Error (Hz)	Freq.Error (Hz)	Frequency Stability (ppm)	Frequency Stability (ppm)	Verdict
BANDWIDTH	3MHz					
Temperature	Voltage	16QAM	QPSK	16QAM	QPSK	
Normal (25°C)	Normal	13.00	8.05	0.01554	0.00963	PASS
Extreme (75°C)		5.60	15.27	0.00669	0.01826	PASS
Extreme (70°C)		8.73	7.78	0.01044	0.00930	PASS
Extreme (60°C)		8.14	5.75	0.00973	0.00688	PASS
Extreme (50°C)		12.45	8.72	0.01488	0.01043	PASS
Extreme (40°C)		17.71	11.06	0.02117	0.01322	PASS
Extreme (30°C)		12.63	16.34	0.01510	0.01954	PASS
Extreme (20°C)		12.40	13.64	0.01482	0.01631	PASS
Extreme (10°C)		12.98	11.42	0.01552	0.01365	PASS
Extreme (0°C)		1.89	7.14	0.00226	0.00854	PASS
Extreme (-10°C)		8.70	12.20	0.01040	0.01459	PASS
Extreme (-20°C)		6.96	12.15	0.00832	0.01453	PASS
Extreme (-30°C)		6.31	1.33	0.00754	0.00158	PASS
Extreme (-35°C)		7.58	4.74	0.00906	0.00567	PASS
25°C	LV	9.09	1.84	0.01087	0.00220	PASS





Condition		Freq.Error (Hz)	Freq.Error (Hz)	Frequency Stability (ppm)	Frequency Stability (ppm)	Verdict
BANDWIDTH	5MHz					
Temperature	Voltage	16QAM	QPSK	16QAM	QPSK	
Normal (25°C)	Normal	6.20	6.09	0.00741	0.00728	PASS
Extreme (75°C)		7.73	11.48	0.00924	0.01373	PASS
Extreme (70°C)		2.85	9.00	0.00341	0.01076	PASS
Extreme (60°C)		10.42	14.53	0.01246	0.01737	PASS
Extreme (50°C)		13.83	1.16	0.01653	0.00139	PASS
Extreme (40°C)		4.60	1.43	0.00550	0.00171	PASS
Extreme (30°C)		10.17	5.50	0.01216	0.00657	PASS
Extreme (20°C)		12.96	6.32	0.01550	0.00755	PASS
Extreme (10°C)		15.56	6.65	0.01860	0.00796	PASS
Extreme (0°C)		9.96	12.76	0.01191	0.01525	PASS
Extreme (-10°C)		14.22	10.11	0.01700	0.01209	PASS
Extreme (-20°C)		6.02	7.66	0.00720	0.00916	PASS
Extreme (-30°C)		7.38	7.20	0.00882	0.00860	PASS
Extreme (-35°C)		14.01	9.74	0.01675	0.01165	PASS
25°C	LV	5.24	17.88	0.00626	0.02138	PASS
	HV	2.78	13.95	0.00332	0.01668	PASS
Condition		Freq.Error (Hz)	Freq.Error (Hz)	Frequency Stability (ppm)	Frequency Stability (ppm)	Verdict
BANDWIDTH	10MHz					
Temperature	Voltage	16QAM	QPSK	16QAM	QPSK	
Normal (25°C)	Normal	2.88	2.81	0.00345	0.00336	PASS
Extreme (75°C)		9.66	3.73	0.01155	0.00446	PASS
Extreme (70°C)		11.53	2.24	0.01378	0.00268	PASS
Extreme (60°C)		15.50	12.10	0.01853	0.01447	PASS
Extreme (50°C)		5.45	1.88	0.00651	0.00225	PASS
Extreme (40°C)		15.63	10.06	0.01869	0.01203	PASS
Extreme (30°C)		7.89	15.22	0.00944	0.01819	PASS
Extreme (20°C)		3.31	3.75	0.00395	0.00448	PASS
Extreme (10°C)		8.93	7.69	0.01067	0.00920	PASS
Extreme (0°C)		1.39	15.53	0.00166	0.01857	PASS
Extreme (-10°C)		9.97	14.79	0.01192	0.01768	PASS
Extreme (-20°C)		13.09	8.60	0.01565	0.01028	PASS
Extreme (-30°C)		9.94	3.69	0.01188	0.00441	PASS
Extreme (-35°C)		5.82	8.84	0.00696	0.01057	PASS
25°C	LV	13.85	10.06	0.01656	0.01203	PASS
	HV	2.96	10.95	0.00354	0.01309	PASS

## 5.6. Spurious Emissions at Antenna Terminals

### Ambient condition

Temperature	Relative humidity	Pressure
23°C ~25°C	45%~50%	101.5kPa

### Method of Measurement

The EUT was connected to Spectrum Analyzer and Base Station Simulator via power Splitter. The measurement is carried out using a spectrum analyzer. The spectrum analyzer scans from 9kHz to the 10th harmonic of the carrier.

The peak detector is used. RBW are set to 100 kHz and VBW are set to 300 kHz for below 1G, RBW are set to 1MHz and VBW are set to 3MHz for above 1G, Sweep is set to ATUO.

RBW is set to 1 kHz (0.009MHz~ 0.15 MHz),

RBW is set to 10 kHz (0.15 MHz~ 30 MHz)

RBW is set to 100 kHz (30MHz~1000 MHz)

RBW is set to 1000 kHz (above 1000MHz)

The modulation mode and RB allocation refer to section 5.1, using the maximum output power configuration.

### Test setup

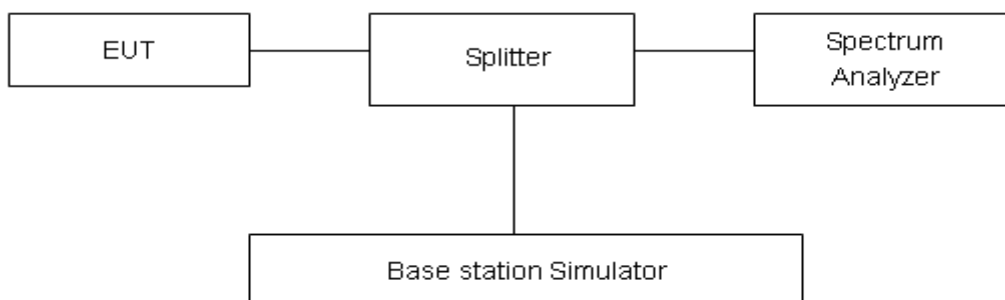

### Limits

Rule Part 22.917(a) specifies that “The power of any emission outside of the authorized operating frequency ranges must be attenuated below the transmitting power (P) by a factor of at least 43 + 10 log (P) dB.”

Limit	-13 dBm
-------	---------

### Measurement Uncertainty

The assessed measurement uncertainty to ensure 99.75% confidence level for the normal distribution is with the coverage factor  $k = 1.96$ .

Frequency	Uncertainty
9kHz-1GHz	0.684 dB
1GHz-18GHz	1.407 dB



### Test Result

Sweep the whole frequency band through the range from 9kHz to the 10th harmonic of the carrier, the emissions more than 20 dB below the limit are not reported.

The signal beyond the limit is carrier.

#### LTE Band 5 1.4MHz CH-Low 9kHz~30GHz

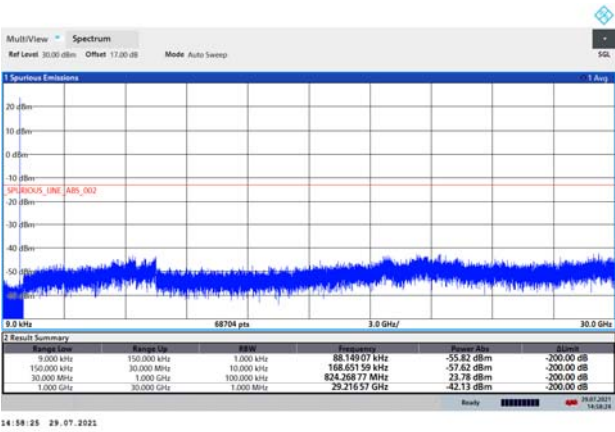

#### LTE Band 5 3MHz CH-Low 9kHz~30GHz

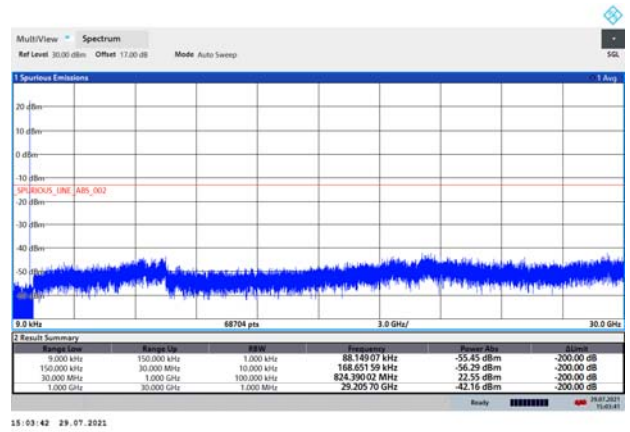

#### LTE Band 5 1.4MHz CH-Middle 9kHz~30GHz

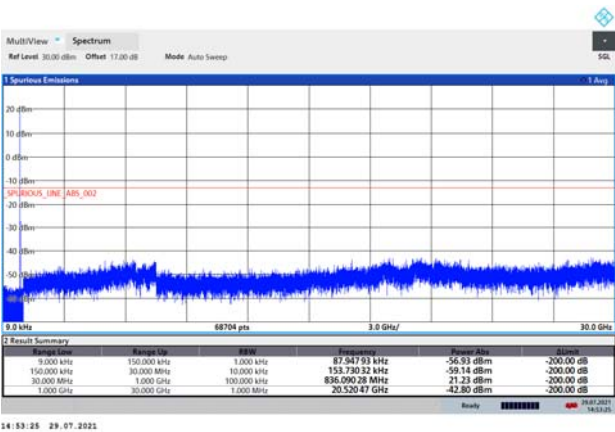

#### LTE Band 5 3MHz CH-Middle 9kHz~30GHz

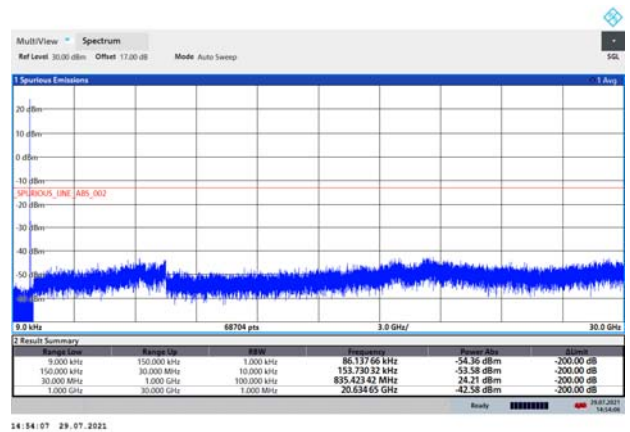

#### LTE Band 5 1.4MHz CH-High 9kHz~30GHz

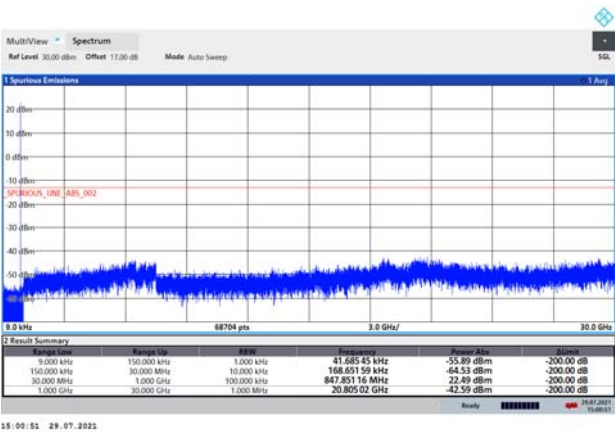

#### LTE Band 5 3MHz CH-High 9kHz~30GHz

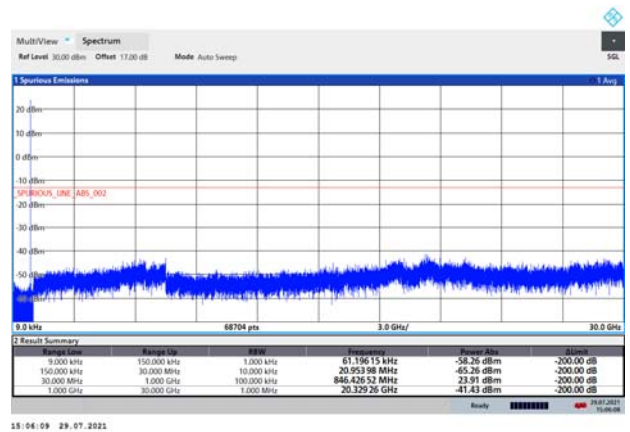



### LTE Band 5 5MHz CH-Low 9kHz~30GHz

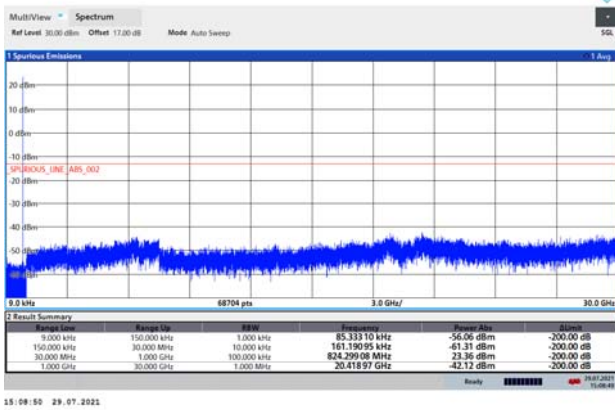

### LTE Band 5 10MHz CH-Low 9kHz~30GHz

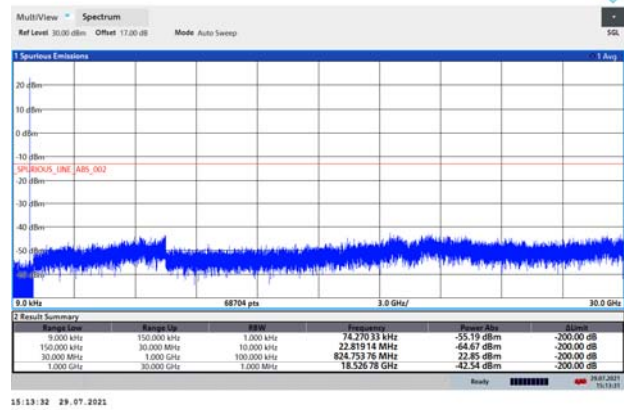

### LTE Band 5 5MHz CH-Middle 9kHz~30GHz

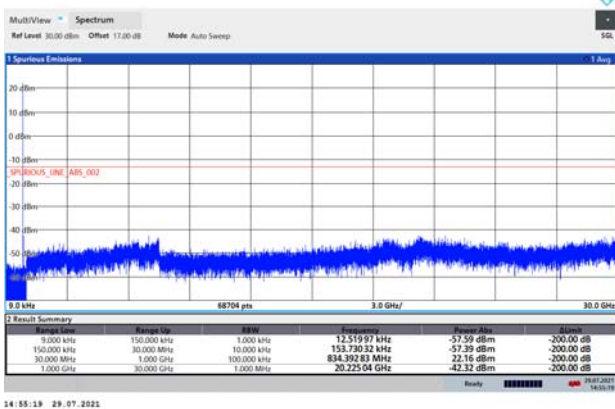

### LTE Band 5 10MHz CH-Middle 9kHz~30GHz

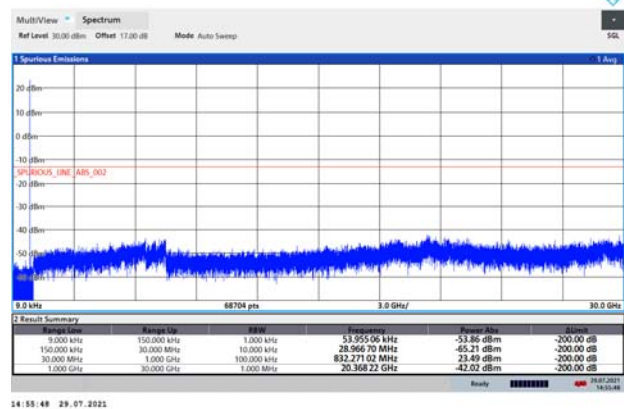

### LTE Band 5 5MHz CH-High 9kHz~30GHz

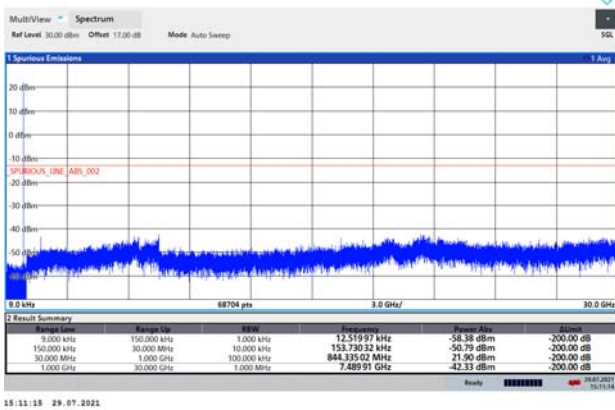

### LTE Band 5 10MHz CH-High 9kHz~30GHz

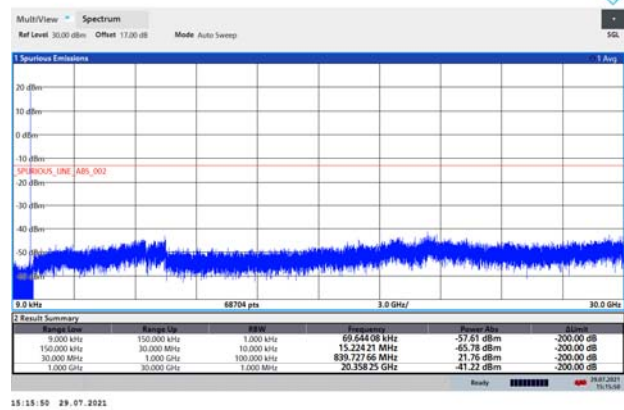

## 5.7. Radiates Spurious Emission

### Ambient condition

Temperature	Relative humidity	Pressure
23°C ~25°C	45%~50%	101.5kPa

### Method of Measurement

1. The testing follows FCC KDB 971168 v03r01 Section 5.8 and ANSI C63.26 (2015).
2. Below 1GHz: The EUT is placed on a turntable 0.8 meters above the ground in the chamber, 3 meter away from the antenna. The maximal emission value is acquired by adjusting the antenna height, polarisation and turntable azimuth. Normally, the height range of antenna is 1 m to 4 m, the azimuth range of turntable is 0° to 360°, and the receive antenna has two polarizations Vertical (V) and Horizontal (H). Above 1GHz: (Note: the FCC's permission to use 1.5m as an alternative per TCBC Conf call of Dec. 2, 2014.) The EUT is placed on a turntable 1.5 meters above the ground in the chamber, 3 meter away from the antenna. The maximal emission value is acquired by adjusting the antenna height, polarisation and turntable azimuth. Normally, the height range of antenna is 1 m to 4 m, the azimuth range of turntable is 0° to 360°, and the receive antenna has two polarizations Vertical (V) and Horizontal (H).
3. A loop antenna, A log-periodic antenna or horn antenna shall be substituted in place of the EUT. The log-periodic antenna will be driven by a signal generator and the level will be adjusted till the same power value on the spectrum analyzer or receiver. The level of the spurious emissions can be calculated through the level of the signal generator, cable loss, the gain of the substitution antenna and the reading of the spectrum analyzer or receiver.
4. The EUT is then put into continuously transmitting mode at its maximum power level during the test. Set Test Receiver or Spectrum RBW=100kHz,VBW=300kHz, and the maximum value of the receiver should be recorded as (Pr).
5. The EUT shall be replaced by a substitution antenna. In the chamber, an substitution antenna for the frequency band of interest is placed at the reference point of the chamber. An RF Signal source for the frequency band of interest is connected to the substitution antenna with a cable that has been constructed to not interfere with the radiation pattern of the antenna. A power (PMea) is applied to the input of the substitution antenna, and adjust the level of the signal generator output until the value of the receiver reach the previously recorded (Pr). The power of signal source (PMea) is recorded. The test should be performed by rotating the test item and adjusting the receiving antenna polarization.
6. A amplifier should be connected to the Signal Source output port. And the cable should be connect between the Amplifier and the Substitution Antenna. The cable loss (Pcl), the Substitution Antenna Gain (Ga) and the Amplifier Gain (PAg) should be recorded after test.
7. The measurement results are obtained as described below:  
Power(EIRP)=PMea- PAg - Pcl + Ga  
The measurement results are amend as described below:  
Power(EIRP)=PMea- Pcl + Ga
8. This value is EIRP since the measurement is calibrated using an antenna of known gain (2.15 dBi) and known input power. ERP can be calculated from EIRP by subtracting the gain of the dipole, ERP

= EIRP-2.15dBi.

The modulation mode and RB allocation refer to section 5.1, using the maximum output power configuration.

**Test setup**

**9KHz ~ 30MHz**

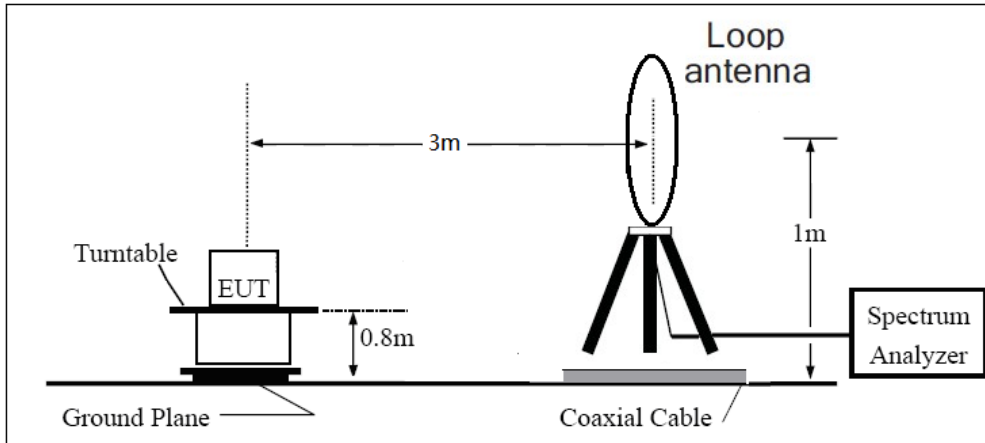

**30MHz ~ 1GHz**

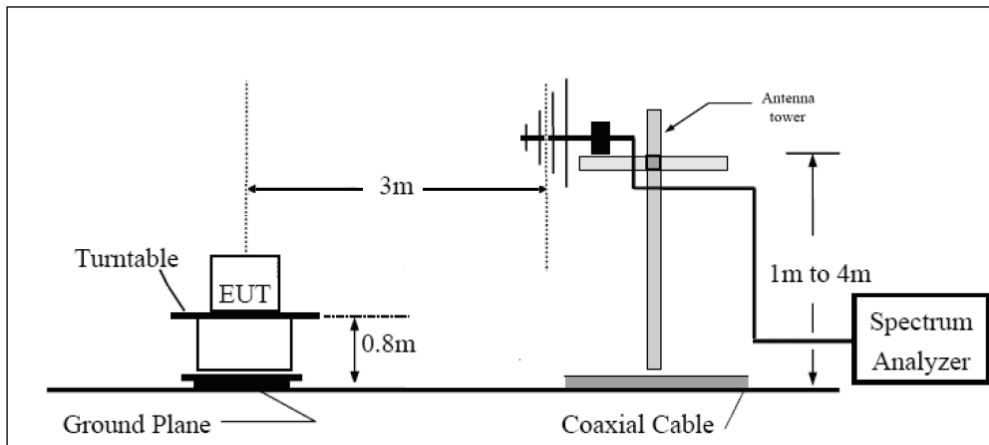

**Above 1GHz**

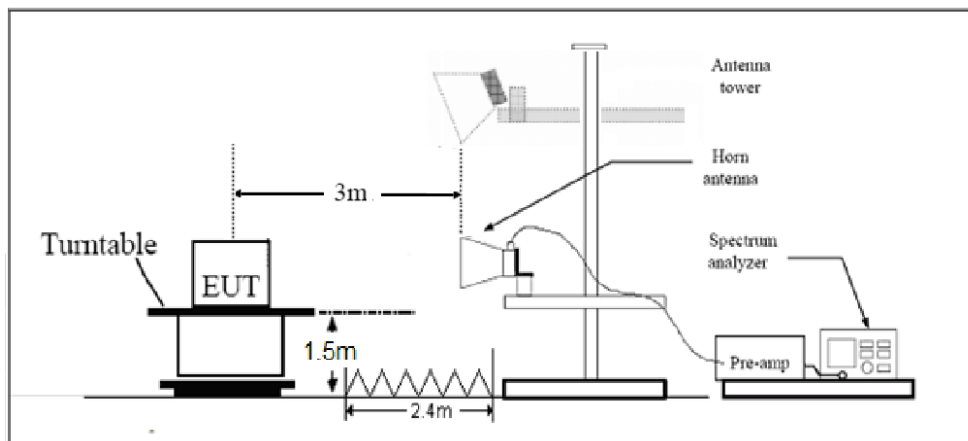

Note: Area side:2.4mX3.6m



### Limits

Rule Part 22.917(a) specifies that “The power of any emission outside of the authorized operating frequency ranges must be attenuated below the transmitting power (P) by a factor of at least  $43 + 10 \log (P)$  dB.”

Limit	-13 dBm
-------	---------

### Measurement Uncertainty

The assessed measurement uncertainty to ensure 95% confidence level for the normal distribution is with the coverage factor  $k = 1.96$ ,  $U = 3.55$  dB.

**Test Result**

Sweep the whole frequency band through the range from 9kHz to the 10th harmonic of the carrier, the emissions below the noise floor will not be recorded in the report.

## LTE Band 5 1.4MHz CH-Middle

Harmonic	Frequency (MHz)	SG (dBm)	Cable Loss (dB)	Gain (dBi)	Antenna Polarization	ERP Level (dBm)	Limit (dBm)	Margin (dB)	Azimuth (deg)
2	1673.00	-61.61	1.70	8.70	Horizontal	-56.76	-13.00	43.76	180
3	2509.50	-60.61	2.30	12.00	Horizontal	-53.06	-13.00	40.06	0
4	3346.00	-64.79	2.70	12.70	Horizontal	-56.94	-13.00	43.94	45
5	4182.50	-50.16	3.00	12.50	Horizontal	-42.81	-13.00	29.81	315
6	5019.00	-43.45	3.40	12.50	Horizontal	-36.50	-13.00	23.50	90
7	5855.50	-51.08	3.40	12.80	Horizontal	-43.83	-13.00	30.83	0
8	6692.00	-58.85	4.10	11.50	Horizontal	-53.60	-13.00	40.60	45
9	7528.50	-57.22	4.20	12.20	Horizontal	-51.37	-13.00	38.37	180
10	8365.00	-54.95	4.30	12.50	Horizontal	-48.90	-13.00	35.90	0

Note: 1.The other Spurious RF Radiated emissions level is no more than noise floor.  
2.The worst emission was found in the antenna is Horizontal position.

## LTE Band 5 5MHz CH-Middle

Harmonic	Frequency (MHz)	SG (dBm)	Cable Loss (dB)	Gain (dBi)	Antenna Polarization	ERP Level (dBm)	Limit (dBm)	Margin (dB)	Azimuth (deg)
2	1668.60	-61.24	1.70	8.70	Horizontal	-56.39	-13.00	43.39	315
3	2503.30	-60.70	2.30	12.00	Horizontal	-53.15	-13.00	40.15	90
4	3337.50	-64.06	2.70	12.70	Horizontal	-56.21	-13.00	43.21	180
5	4171.88	-51.00	3.00	12.50	Horizontal	-43.65	-13.00	30.65	45
6	5006.25	-42.40	3.40	12.50	Horizontal	-35.45	-13.00	22.45	180
7	5840.63	-51.12	3.40	12.80	Horizontal	-43.87	-13.00	30.87	180
8	6675.00	-59.41	4.10	11.50	Horizontal	-54.16	-13.00	41.16	0
9	7509.38	-55.03	4.20	12.20	Horizontal	-49.18	-13.00	36.18	45
10	8343.75	-56.07	4.30	12.50	Horizontal	-50.02	-13.00	37.02	90

Note: 1.The other Spurious RF Radiated emissions level is no more than noise floor.  
2.The worst emission was found in the antenna is Horizontal position.



LTE Band 5 10MHz CH-Middle

Harmonic	Frequency (MHz)	SG (dBm)	Cable Loss (dB)	Gain (dBi)	Antenna Polarization	ERP Level (dBm)	Limit (dBm)	Margin (dB)	Azimuth (deg)
2	1664.40	-61.16	1.70	8.70	Horizontal	-56.31	-13.00	43.31	0
3	2496.60	-57.85	2.30	12.00	Horizontal	-50.30	-13.00	37.30	180
4	3346.00	-64.06	2.70	12.70	Horizontal	-56.21	-13.00	43.21	0
5	4182.50	-51.27	3.00	12.50	Horizontal	-43.92	-13.00	30.92	180
6	5019.00	-43.66	3.40	12.50	Horizontal	-36.71	-13.00	23.71	45
7	5855.50	-51.23	3.40	12.80	Horizontal	-43.98	-13.00	30.98	90
8	6692.00	-58.70	4.10	11.50	Horizontal	-53.45	-13.00	40.45	90
9	7528.50	-55.13	4.20	12.20	Horizontal	-49.28	-13.00	36.28	45
10	8365.00	-55.71	4.30	12.50	Horizontal	-49.66	-13.00	36.66	315

Note: 1.The other Spurious RF Radiated emissions level is no more than noise floor.

2.The worst emission was found in the antenna is Horizontal position.

## 6. Main Test Instruments

Name	Manufacturer	Type	Serial Number	Calibration Date	Expiration Date
Base Station Simulator	R&S	CMW500	113645	2021-05-15	2022-05-14
Climate Chamber	Weiss	VT4002	58226119450 010	2021-05-15	2022-05-14
Power Splitter	Hua Xiang	SHX-GF2-2-13	10120101	/	/
Spectrum Analyzer	Key sight	N9010A	MY50210259	2020-05-18	2022-05-14
Universal Radio Communication Tester	Key sight	E5515C	MY48367192	2021-05-15	2022-05-14
Signal Analyzer	R&S	FSV3030	101411	2020-12-13	2021-12-12
Loop Antenna	SCHWARZBECK	FMZB1519	1519-047	2020-04-02	2023-04-01
TRILOG Broadband Antenna	SCHWARZBECK	VULB 9163	391	2019-12-16	2021-12-15
Horn Antenna	R&S	HF907	102723	2018-08-11	2021-08-10
Horn Antenna	ETS-Lindgren	3160-09	00102643	2018-06-20	2023-06-19
Signal generator	R&S	SMB 100A	180235	2021-05-15	2022-05-14
Climatic Chamber	ESPEC	SU-242	93000506	2020-12-13	2021-12-12
Preamplifier	R&S	SCU18	102327	2021-05-15	2022-05-14
MOB COMMS DC SUPPLY	Keysight	66319D	MY43004105	2021-05-15	2022-05-14
Software	R&S	EMC32	9.26.0	/	/

\*\*\*\*\*END OF REPORT \*\*\*\*\*



## **ANNEX A: The EUT Appearance**

The EUT Appearance are submitted separately.



## **ANNEX B: Test Setup Photos**

The Test Setup Photos are submitted separately.



## **ANNEX C: Product Change Description**

The Product Change Description are submitted separately.