



RF TEST REPORT

Applicant Quectel Wireless Solutions Co., Ltd.
FCC ID XMR2022BG952AGL
Product LTE Cat M1 & Cat NB1 Module
Brand Quectel
Model BG952A-GL
Report No. R2206A0479-R5
Issue Date June 22, 2022

TA Technology (Shanghai) Co., Ltd. tested the above equipment in accordance with the requirements in **FCC CFR47 Part 2 (2021)/ FCC CFR 47 Part 24E (2021)**. The test results show that the equipment tested is capable of demonstrating compliance with the requirements as documented in this report.

Prepared by: Peng Tao

Approved by: Kai Xu

TA Technology (Shanghai) Co., Ltd.

No.145, Jintang Rd, Tangzhen Industry Park, Pudong Shanghai, China

TEL: +86-021-50791141/2/3

FAX: +86-021-50791141/2/3-8000



TABLE OF CONTENT

1. Test Laboratory	4
1.1. Notes of the test report	4
1.2. Test facility	4
1.3. Testing Location	4
2. General Description of Equipment under Test	5
2.1. Applicant and Manufacturer Information	5
2.2. General information	5
3. Applied Standards	6
4. Test Configuration	7
5. Test Case Results	8
5.1. RF Power Output and Effective Isotropic Radiated Power	8
5.2. Occupied Bandwidth	11
5.3. Band Edge Compliance	17
5.4. Peak-to-Average Power Ratio (PAPR)	35
5.5. Frequency Stability	37
5.6. Spurious Emissions at Antenna Terminals	45
5.7. Radiates Spurious Emission	52
6. Main Test Instruments	58
ANNEX A: The EUT Appearance	59
ANNEX B: Test Setup Photos	60
ANNEX C: Product Change Description	61

Summary of measurement results

No.	Test Case	Clause in FCC rules	Verdict
1	RF Power Output and Effective Isotropic Radiated Power	2.1046 24.232(c)	PASS
2	Occupied Bandwidth	2.1049	PASS
3	Band Edge Compliance	2.1051 /24.238(a)	PASS
4	Peak-to-Average Power Ratio	24.232/KDB 971168 D01(5.7)	PASS
5	Frequency Stability	2.1055 / 24.235	PASS
6	Spurious Emissions at Antenna Terminals	2.1051 / 24.238(a)	PASS
7	Radiates Spurious Emission	2.1053 / 24.238(a)	PASS
Date of Testing: July 21, 2021 ~ August 5, 2021			
Date of Sample Received: July 20, 2021			
<p>Note: PASS: The EUT complies with the essential requirements in the standard. FAIL: The EUT does not comply with the essential requirements in the standard. All indications of Pass/Fail in this report are opinions expressed by TA Technology (Shanghai) Co., Ltd. based on interpretations and/or observations of test results. Measurement Uncertainties were not taken into account and are published for informational purposes only.</p>			

BG952A-GL (Report No.: R2206A0479-R5) is a variant model of BG950A-GL (Report No.: R2107A0607-R5V1). Test values duplicated from Original for variant. The power of new variant are varied due to measurement uncertainty, and sample tolerance of the acceptance range. The detailed product change description please refers to following table:

Module	BG950A-GL	BG952A-GL
QuecOpen®	N/A	Supported
Hardware Version	R1.3	R1.5
Software Version	BG950AGLAAR01A01	BG952AGLAAR01A03
Product Name	LTE Module	LTE Cat M1 & Cat NB1 Module
Others	The same	

The detailed product change description please refers to the Difference Declaration Letter.



1. Test Laboratory

1.1. Notes of the test report

This report shall not be reproduced in full or partial, without the written approval of **TA technology (shanghai) co., Ltd.** The results documented in this report apply only to the tested sample, under the conditions and modes of operation as described herein. Measurement Uncertainties were not taken into account and are published for informational purposes only. This report is written to support regulatory compliance of the applicable standards stated above.

1.2. Test facility

FCC (Designation number: CN1179, Test Firm Registration Number: 446626)

TA Technology (Shanghai) Co., Ltd. has been listed on the US Federal Communications Commission list of test facilities recognized to perform measurements.

A2LA (Certificate Number: 3857.01)

TA Technology (Shanghai) Co., Ltd. has been listed by American Association for Laboratory Accreditation to perform measurement.

1.3. Testing Location

Company: TA Technology (Shanghai) Co., Ltd.
Address: No.145, Jintang Rd, Tangzhen Industry Park, Pudong
City: Shanghai
Post code: 201201
Country: P. R. China
Contact: Xu Kai
Telephone: +86-021-50791141/2/3
Fax: +86-021-50791141/2/3-8000
Website: <http://www.ta-shanghai.com>
E-mail: xukai@ta-shanghai.com

2. General Description of Equipment under Test

2.1. Applicant and Manufacturer Information

Applicant	Quectel Wireless Solutions Co., Ltd.
Applicant address	Building 5, Shanghai Business Park Phase III (Area B), No.1016 Tianlin Road, Minhang District, Shanghai, China, 200233
Manufacturer	Quectel Wireless Solutions Co., Ltd.
Manufacturer address	Building 5, Shanghai Business Park Phase III (Area B), No.1016 Tianlin Road, Minhang District, Shanghai, China, 200233

2.2. General information

EUT Description			
Model	BG952A-GL		
IMEI	869410050002659		
Hardware Version	R1.5		
Software Version	BG952AGLAAR01A03		
Power Supply	External power supply		
Antenna Type	External Antenna		
Antenna Gain	Mode	Frequency (MHz)	Gain (dBi)
	LTE Band 2/25	1840	1.36
		1860	1.25
		1880	1.38
		1900	1.59
		1920	1.36
Test Mode(s)	LTE Band 2/25;		
Test Modulation	QPSK, 16QAM		
LTE Category	M1		
Maximum E.I.R.P	LTE Band 2:	25.52dBm	
	LTE Band 25:	25.54dBm	
Rated Power Supply Voltage	3.3V		
Operating Voltage	Minimum: 2.2V Maximum: 4.35V		
Operating Temperature	Lowest: -35°C Highest: +75°C		
Extreme Temperature	Lowest: -35°C Highest: +75°C		
Frequency Range(s)	Band	Tx (MHz)	Rx (MHz)
	LTE Band 2	1850 ~ 1910	1930 ~ 1990
	LTE Band 25	1850 ~ 1915	1930 ~ 1995
Note: 1. The EUT is sent from the applicant to TA and the information of the EUT is declared by the applicant.			

3. Applied Standards

According to the specifications of the manufacturer, it must comply with the requirements of the following standards:

Test standards:

FCC CFR 47 Part 24E (2021)

ANSI C63.26-2015

Reference standard:

FCC CFR47 Part 2 (2021)

KDB 971168 D01 Power Meas License Digital Systems v03r01

4. Test Configuration

Radiated measurements are performed by rotating the EUT in three different orthogonal test planes. EUT stand-up position (Z axis), lie-down position (X, Y axis). Receiver antenna polarization (horizontal and vertical), the worst emission was found in position (X, Y axis, horizontal polarization) and the worst case was recorded.

All mode and data rates and positions and RB size and modulations were investigated.

Subsequently, only the worst case emissions are reported.

The following testing in LTE is set based on the maximum RF Output Power.

Test modes are chosen to be reported as the worst case configuration below for LTE Band 2/25:

Test items	Bandwidth (MHz)						Modulation		RB			Test Channel		
	1.4	3	5	10	15	20	QPSK	16QAM	1	50%	100%	L	M	H
RF Power Output and Effective Isotropic Radiated Power	O	O	O	O	O	O	O	O	O	O	O	O	O	O
Occupied Bandwidth	O	O	O	O	O	O	O	O	-	-	O	O	O	O
Band Edge Compliance	O	O	O	O	O	O	O	O	O	-	O	O	-	O
Peak-to-Average Power Ratio	O	O	O	O	O	O	O	O	-	-	O	O	O	O
Frequency Stability	O	O	O	O	O	O	O	O	O	-	-	-	O	-
Spurious Emissions at Antenna Terminals	O	O	O	O	O	O	O	-	O	-	-	O	O	O
Radiates Spurious Emission	O	-	O	-	-	O	O	-	O	-	-	-	O	-
Note	1. The mark "O" means that this configuration is chosen for testing. 2. The mark "-" means that this configuration is not testing.													

5. Test Case Results

5.1.RF Power Output and Effective Isotropic Radiated Power

Ambient condition

Temperature	Relative humidity	Pressure
23°C ~25°C	45%~50%	101.5kPa

Methods of Measurement

During the process of the testing, The EUT was connected to the Base Station Simulator with a known loss. The EUT is controlled by the Base Station Simulator test set to ensure max power transmission with proper modulation.

ERP can then be calculated as follows:

$$\text{EIRP (dBm)} = \text{Output Power (dBm)} - \text{Losses (dB)} + \text{Antenna Gain (dBi)}$$

where:dBd refers to gain relative to an ideal dipole.

$$\text{EIRP (dBm)} = \text{ERP (dBm)} + 2.15 \text{ (dB.)}$$

Test Setup

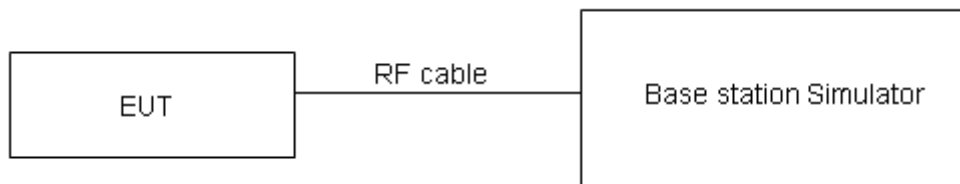

Limits

No specific RF power output requirements in part 2.1046.

Rule Part 24.232(c) Mobile and portable stations are limited to 2 watts EIRP.

Rule Part 24.232(e) Peak transmit power must be measured over any interval of continuous transmission using instrumentation calibrated in terms of an rms-equivalent voltage.

Limit	$\leq 2 \text{ W}$ (33 dBm)
-------	-----------------------------

Measurement Uncertainty

The assessed measurement uncertainty to ensure 95% confidence level for the normal distribution is with the coverage factor $k = 2$, $U = 0.4 \text{ dB}$ for RF power output, $k = 2$, $U = 1.19 \text{ dB}$ for EIRP.



Test Results

LTE Band 2	Channel/ Frequency(MHz)	Index	RB#		Maximum Output Power (dBm)		EIRP (dBm)	
			RBstart		QPSK	16QAM	QPSK	16QAM
			QPSK	16QAM				
1.4MHz	18607/1850.7	0	1#0	1#0	23.50	22.63	24.75	23.88
		0	6#0	5#0	22.57	22.18	23.82	23.43
	18900/1880	0	1#0	1#0	23.88	22.35	25.26	23.73
		0	6#0	5#0	23.39	21.91	24.77	23.29
	19193/1909.3	0	1#5	1#5	23.78	22.46	25.37	24.05
		0	6#0	5#0	22.16	21.88	23.75	23.47
3MHz	18615/1851.5	0	1#0	1#0	23.40	22.77	24.65	24.02
		0	6#0	5#0	22.34	22.15	23.59	23.40
	18900/1880	0	1#0	1#0	23.34	22.74	24.72	24.12
		0	6#0	5#0	22.11	21.94	23.49	23.32
	19185/1908.5	1	1#5	1#5	23.91	22.57	25.50	24.16
		0	6#0	5#0	21.90	22.06	23.49	23.65
5MHz	18625/1852.5	3	1#0	1#0	23.86	23.80	25.11	25.05
		0	6#0	5#0	23.24	21.88	24.49	23.13
	18900/1880	0	1#0	1#0	23.31	23.93	24.69	25.31
		0	6#0	5#0	23.15	21.91	24.53	23.29
	19175/1907.5	0	1#5	1#5	23.68	23.56	25.27	25.15
		0	6#0	5#0	22.93	21.54	24.52	23.13
10MHz	18650/1855	3	1#0	1#0	23.83	23.86	25.08	25.11
		0	4#0	4#0	23.81	22.89	25.06	24.14
	18900/1880	0	1#0	1#0	23.91	23.60	25.29	24.98
		0	4#0	4#0	23.02	22.95	24.40	24.33
	19150/1905	4	1#5	1#5	23.69	23.60	25.28	25.19
		7	4#2	4#2	23.44	21.64	25.03	23.23
15MHz	18675/1857.5	3	1#0	1#0	23.81	23.82	25.06	25.07
		0	6#0	5#0	23.65	23.83	24.90	25.08
	18900/1880	0	1#0	1#0	23.88	23.65	25.26	25.03
		0	6#0	5#0	23.54	23.77	24.92	25.15
	19125/1902.5	8	1#5	1#5	23.69	23.60	25.28	25.19
		11	6#0	5#0	23.93	23.55	25.52	25.14
20MHz	18700/1860	3	1#0	1#0	23.85	23.82	25.10	25.07
		0	6#0	5#0	23.58	23.81	24.83	25.06
	18900/1880	0	1#0	1#0	23.89	23.71	25.27	25.09
		0	6#0	5#0	23.58	23.85	24.96	25.23
	19100/1900	12	1#5	1#5	23.68	23.59	25.27	25.18
		15	6#0	5#0	23.65	23.56	25.24	25.15



LTE Band 25	Channel/ Frequency(MHz)	Index	RB#		Maximum Output Power (dBm)		EIRP (dBm)	
			RBstart		QPSK	16QAM	QPSK	16QAM
1.4MHz	26047/1850.7	0	1#0	1#0	23.84	22.68	25.09	23.93
		0	6#0	5#0	23.15	22.02	24.40	23.27
	26365/1882.5	0	1#0	1#0	23.65	22.52	25.03	23.90
		0	6#0	5#0	23.23	21.77	24.61	23.15
	26683/1914.3	0	1#5	1#5	23.60	22.25	24.96	23.61
		0	6#0	5#0	22.02	21.59	23.38	22.95
3MHz	26055/1851.5	0	1#0	1#0	23.99	23.04	25.24	24.29
		0	6#0	5#0	22.25	22.00	23.50	23.25
	26365/1882.5	0	1#0	1#0	23.71	22.72	25.09	24.10
		0	6#0	5#0	21.90	21.75	23.28	23.13
	26675/1913.5	1	1#5	1#5	23.74	22.65	25.10	24.01
		0	6#0	5#0	21.93	21.71	23.29	23.07
5MHz	26065/1852.5	3	1#0	1#0	23.88	23.84	25.13	25.09
		0	6#0	5#0	23.23	21.91	24.48	23.16
	26365/1882.5	0	1#0	1#0	23.68	23.71	25.06	25.09
		0	6#0	5#0	22.85	21.70	24.23	23.08
	26665/1912.5	0	1#5	1#5	23.69	23.58	25.05	24.94
		0	6#0	5#0	22.92	21.62	24.28	22.98
10MHz	26090/1855	3	1#0	1#0	23.88	23.86	25.13	25.11
		0	4#0	4#0	23.74	22.93	24.99	24.18
	26365/1882.5	0	1#0	1#0	23.57	23.71	24.95	25.09
		0	4#0	4#0	23.91	22.95	25.29	24.33
	26640/1910	4	1#5	1#5	23.63	23.56	24.99	24.92
		7	4#2	4#2	23.46	21.56	24.82	22.92
15MHz	26115/1857.5	3	1#0	1#0	23.87	23.86	25.12	25.11
		0	6#0	5#0	23.95	23.88	25.20	25.13
	26365/1882.5	0	1#0	1#0	23.75	23.71	25.13	25.09
		0	6#0	5#0	23.90	23.79	25.28	25.17
	26615/1907.5	8	1#5	1#5	23.71	23.56	25.30	25.15
		11	6#0	5#0	23.95	23.63	25.54	25.22
20MHz	26140/1860	3	1#0	1#0	23.90	23.86	25.15	25.11
		0	6#0	5#0	23.63	23.84	24.88	25.09
	26365/1882.5	0	1#0	1#0	23.77	23.58	25.15	24.96
		0	6#0	5#0	23.92	23.79	25.30	25.17
	26590/1905	12	1#5	1#5	23.69	23.60	25.28	25.19
		15	6#0	5#0	23.88	23.64	25.47	25.23

5.2.Occupied Bandwidth

Ambient condition

Temperature	Relative humidity	Pressure
23°C ~25°C	45%~50%	101.5kPa

Method of Measurement

The EUT was connected to Spectrum Analyzer and Base Station Simulator via power Splitter. The occupied bandwidth is measured using spectrum analyzer.

RBW is set to 51kHz, VBW is set to 160kHz for LTE Band 2/25.

99% power and -26dBc occupied bandwidths are recorded. Spectrum analyzer plots are included on the following pages.

Test Setup

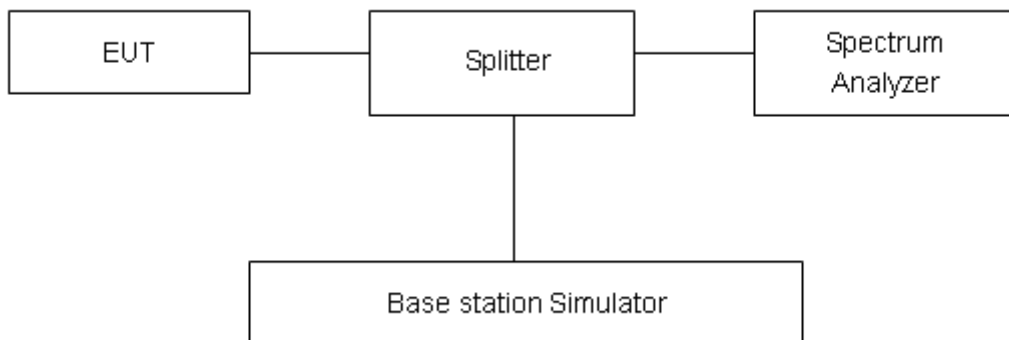

Limits

No specific occupied bandwidth requirements in part 2.1049.

Measurement Uncertainty

The assessed measurement uncertainty to ensure 95% confidence level for the normal distribution is with the coverage factor $k = 2$, $U = 624\text{Hz}$.

Test Result

Mode	Bandwidth	Modulation	Channel/ Frequency(MHz)	Bandwidth(MHz)	
				99% Power	-26dBc
LTE Band 2	1.4MHz	QPSK	18900/1880	1.112	1.343
		16QAM	18900/1880	0.956	1.310
	3MHz	QPSK	18900/1880	1.115	1.339
		16QAM	18900/1880	0.976	1.306
	5MHz	QPSK	18900/1880	1.107	1.342
		16QAM	18900/1880	0.989	1.379
	10MHz	QPSK	18900/1880	1.111	1.337
		16QAM	18900/1880	1.004	1.419
	15MHz	QPSK	18900/1880	1.121	1.374
		16QAM	18900/1880	0.978	1.345
	20MHz	QPSK	18900/1880	1.119	1.358
		16QAM	18900/1880	0.986	1.337

Mode	Bandwidth	Modulation	Channel/ Frequency(MHz)	Bandwidth(MHz)	
				99% Power	-26dBc
LTE Band 25	1.4MHz	QPSK	26365/1882.5	1.104	1.321
		16QAM	20175/1732.5	0.951	1.289
	3MHz	QPSK	20175/1732.5	1.108	1.340
		16QAM	20175/1732.5	0.965	1.309
	5MHz	QPSK	20175/1732.5	1.102	1.352
		16QAM	20175/1732.5	0.975	1.304
	10MHz	QPSK	20175/1732.5	1.109	1.342
		16QAM	20175/1732.5	1.013	1.350
	15MHz	QPSK	20175/1732.5	1.120	1.375
		16QAM	20175/1732.5	0.989	1.356
	20MHz	QPSK	20175/1732.5	1.121	1.368
		16QAM	20175/1732.5	0.995	1.337



LTE Band 2 1.4MHz QPSK CH-Middle



LTE Band 2 3MHz QPSK CH-Middle



LTE Band 2 5MHz QPSK CH-Middle



LTE Band 2 10MHz QPSK CH-Middle



LTE Band 2 15MHz QPSK CH-Middle



LTE Band 2 20MHz QPSK CH-Middle



LTE Band 2 1.4MHz 16QAM CH-Middle



LTE Band 2 3MHz 16QAM CH-Middle



LTE Band 2 5MHz 16QAM CH-Middle



LTE Band 2 10MHz 16QAM CH-Middle



LTE Band 2 15MHz 16QAM CH-Middle



LTE Band 2 20MHz 16QAM CH-Middle



LTE Band 25 1.4MHz QPSK CH-Middle



LTE Band 25 3MHz QPSK CH-Middle



LTE Band 25 5MHz QPSK CH-Middle



LTE Band 25 10MHz QPSK CH-Middle



LTE Band 25 15MHz QPSK CH-Middle



LTE Band 25 20MHz QPSK CH-Middle





LTE Band 25 1.4MHz 16QAM CH-Middle



LTE Band 25 3MHz 16QAM CH-Middle



LTE Band 25 5MHz 16QAM CH-Middle



LTE Band 25 10MHz 16QAM CH-Middle



LTE Band 25 15MHz 16QAM CH-Middle

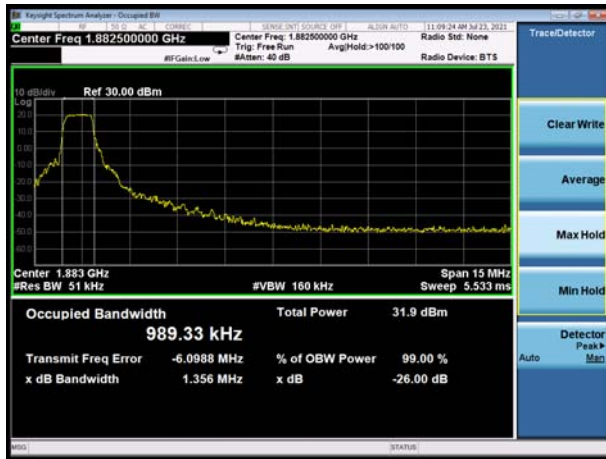

LTE Band 25 20MHz 16QAM CH-Middle



5.3. Band Edge Compliance

Ambient condition

Temperature	Relative humidity	Pressure
23°C ~25°C	45%~50%	101.5kPa

Method of Measurement

The EUT was connected to Spectrum Analyzer and Base Station Simulator via power Splitter. The band edge of the lowest and highest channels were measured. The Average detector is used and RBW is set to 51kHz,VBW is set to 160kHz for LTE Band 2/25.

Spectrum analyzer plots are included on the following pages.

Test Setup

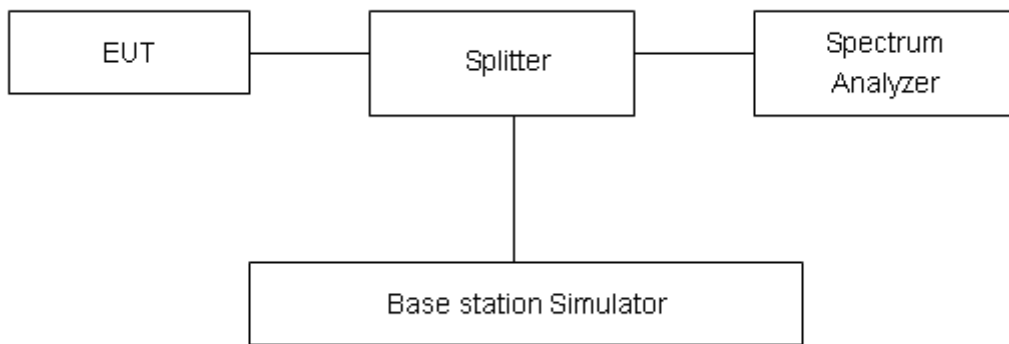

Limits

Rule Part 24.238(a) specifies that “on any frequency outside a licensee’s frequency block, the power of any emission shall be attenuated below the transmitter power (P) by at least $43 + 10 \log_{10} (P)$ dB.”

Limit	-13 dBm
-------	---------

Measurement Uncertainty

The assessed measurement uncertainty to ensure 95% confidence level for the normal distribution is with the coverage factor $k = 1.96$, $U=0.684$ dB.



Test Result:

LTE Band 2 1.4MHz QPSK 1RB CH-Low

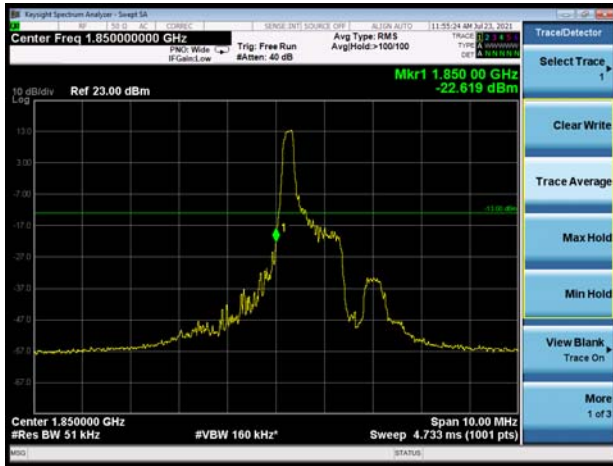

LTE Band 2 1.4MHz QPSK 1RB CH-High



LTE Band 2 1.4MHz QPSK 100%RB CH-Low

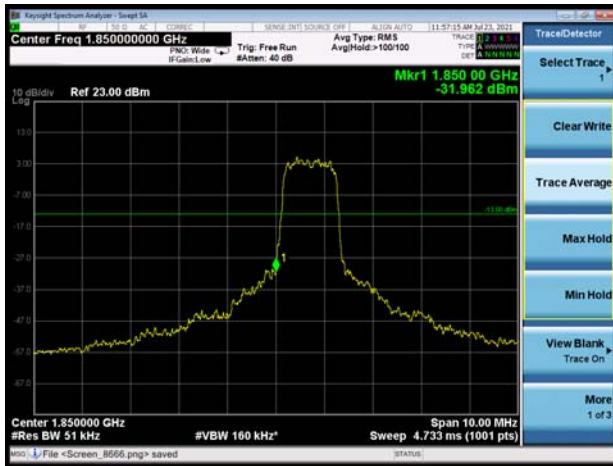

LTE Band 2 1.4MHz QPSK 100%RB CH-High



LTE Band 2 3MHz QPSK 1RB CH-Low



LTE Band 2 3MHz QPSK 1RB CH-High



LTE Band 2 3MHz QPSK 100%RB CH-Low

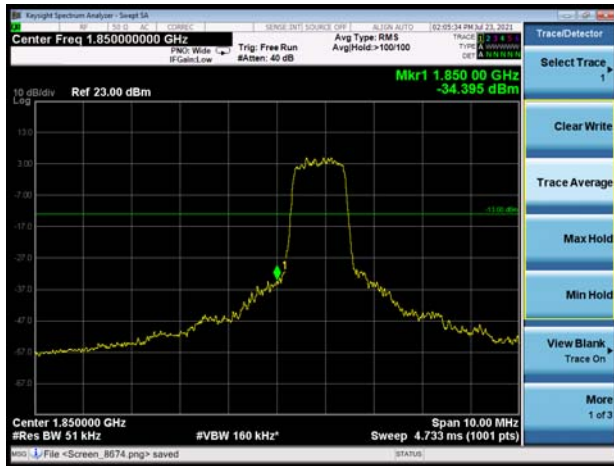

LTE Band 2 3MHz QPSK 100%RB CH-High

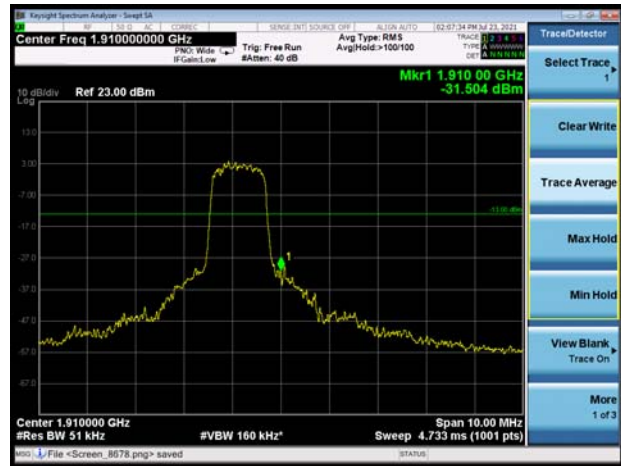

LTE Band 2 5MHz QPSK 1RB CH-Low



LTE Band 2 5MHz QPSK 1RB CH-High



LTE Band 2 5MHz QPSK 100%RB CH-Low

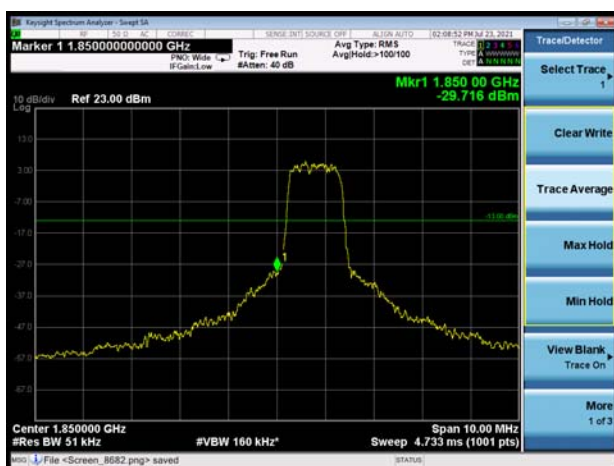

LTE Band 2 5MHz QPSK 100%RB CH-High

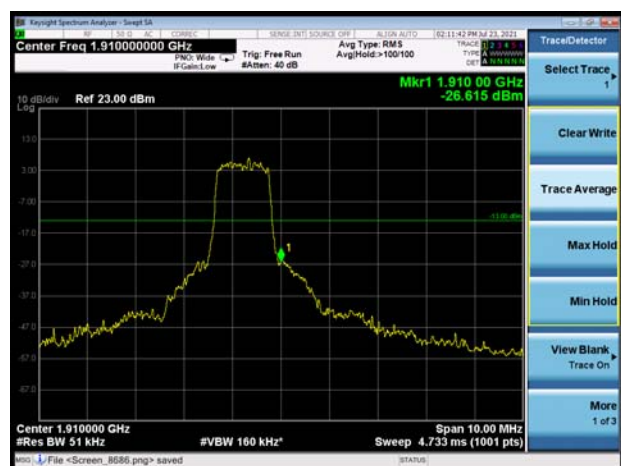

LTE Band 2 10MHz QPSK 1RB CH-Low



LTE Band 2 10MHz QPSK 1RB CH-High



LTE Band 2 10MHz QPSK 100%RB CH-Low



LTE Band 2 10MHz QPSK 100%RB CH-High



LTE Band 2 15MHz QPSK 1RB CH-Low

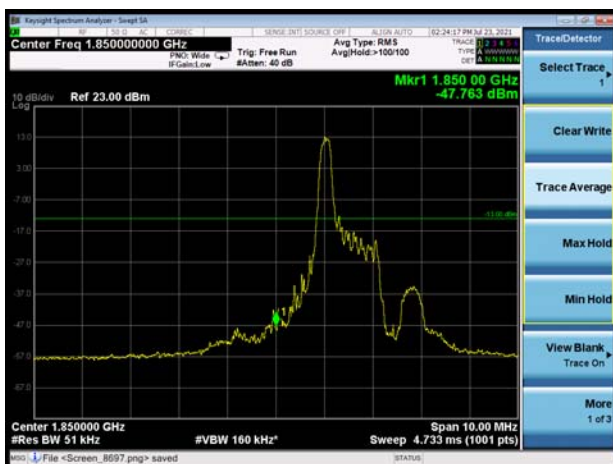

LTE Band 2 15MHz QPSK 1RB CH-High

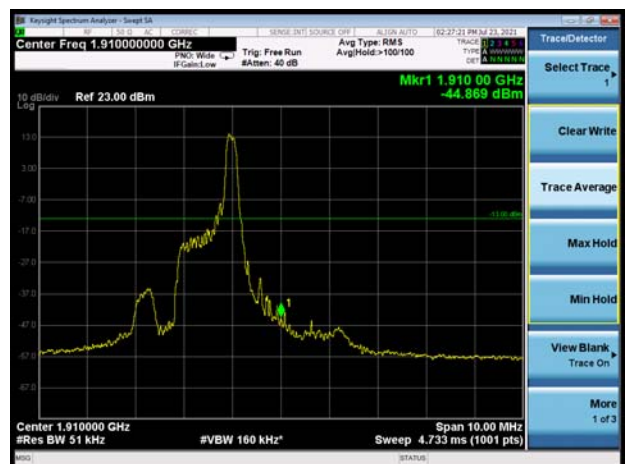

LTE Band 2 15MHz QPSK 100%RB CH-Low

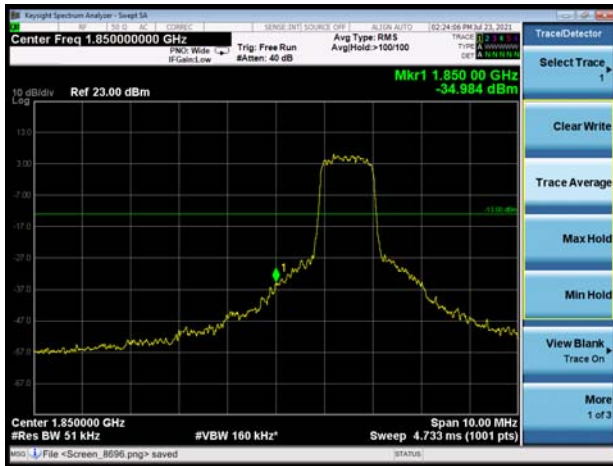

LTE Band 2 15MHz QPSK 100%RB CH-High



LTE Band 2 20MHz QPSK 1RB CH-Low



LTE Band 2 20MHz QPSK 1RB CH-High



LTE Band 2 20MHz QPSK 100%RB CH-Low

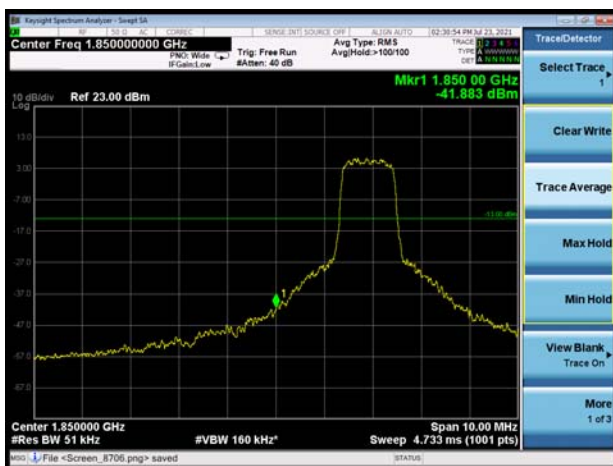

LTE Band 2 20MHz QPSK 100%RB CH-High



LTE Band 2 1.4MHz 16QAM 1RB CH-Low

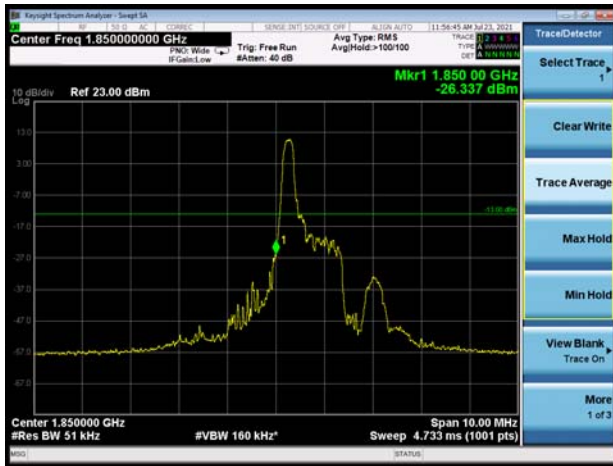

LTE Band 2 1.4MHz 16QAM 1RB CH-High



LTE Band 2 1.4MHz 16QAM 100%RB CH-Low

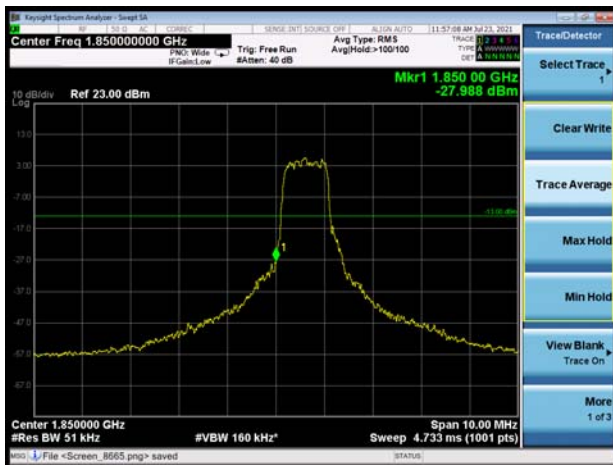

LTE Band 2 1.4MHz 16QAM 100%RB CH-High

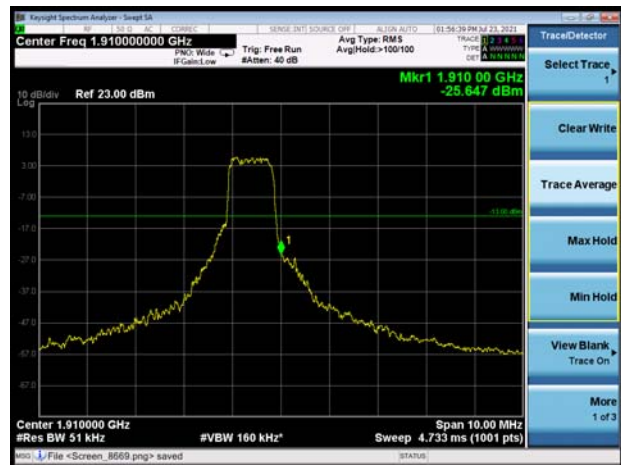

LTE Band 2 3MHz 16QAM 1RB CH-Low



LTE Band 2 3MHz 16QAM 1RB CH-High

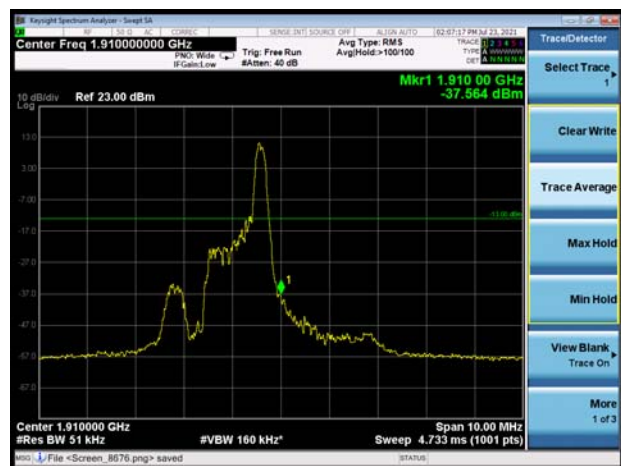

LTE Band 2 3MHz 16QAM 100%RB CH-Low

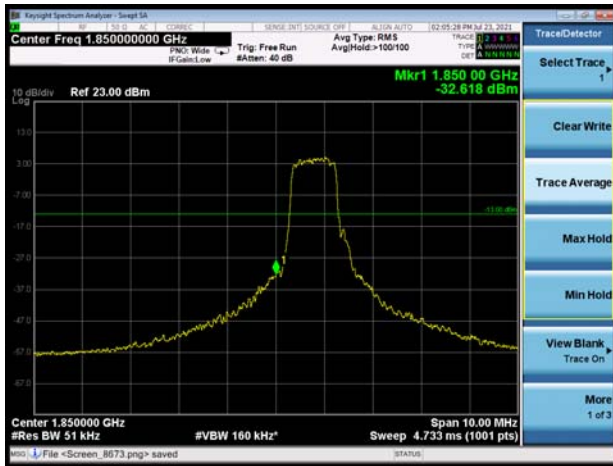

LTE Band 2 3MHz 16QAM 100%RB CH-High

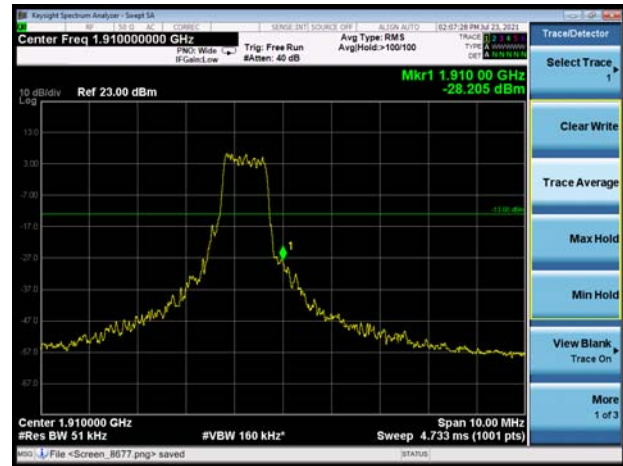

LTE Band 2 5MHz 16QAM 1RB CH-Low



LTE Band 2 5MHz 16QAM 1RB CH-High



LTE Band 2 5MHz 16QAM 100%RB CH-Low

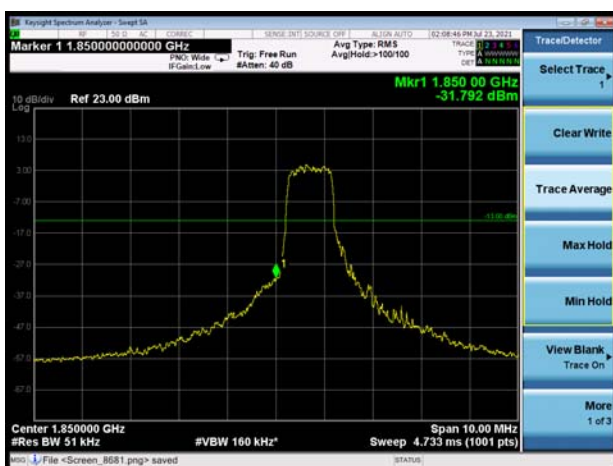

LTE Band 2 5MHz 16QAM 100%RB CH-High

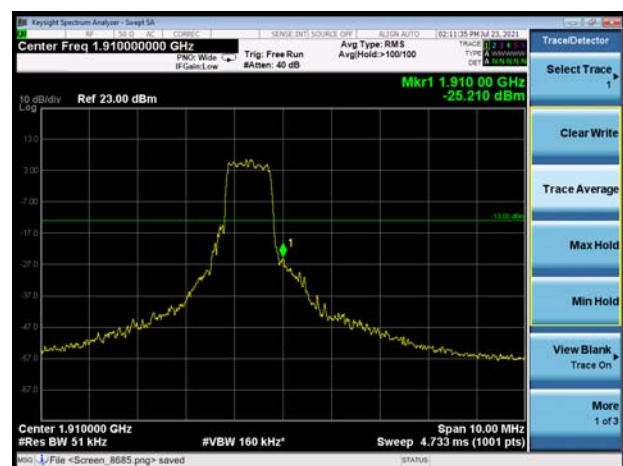

LTE Band 2 10MHz 16QAM 1RB CH-Low



LTE Band 2 10MHz 16QAM 1RB CH-High



LTE Band 2 10MHz 16QAM 100%RB CH-Low



LTE Band 2 10MHz 16QAM 100%RB CH-High



LTE Band 2 15MHz 16QAM 1RB CH-Low



LTE Band 2 15MHz 16QAM 1RB CH-High

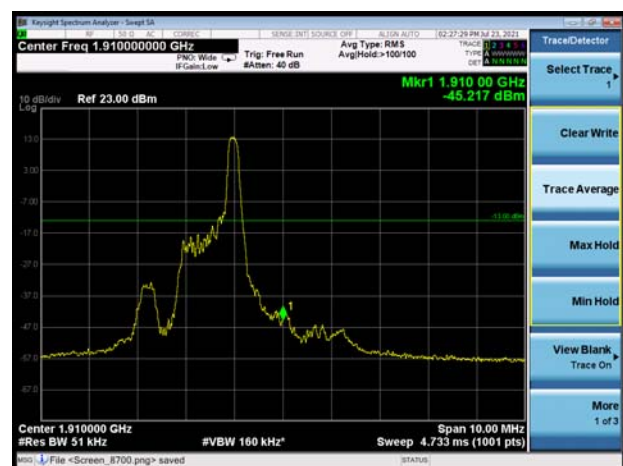

LTE Band 2 15MHz 16QAM 100%RB CH-Low

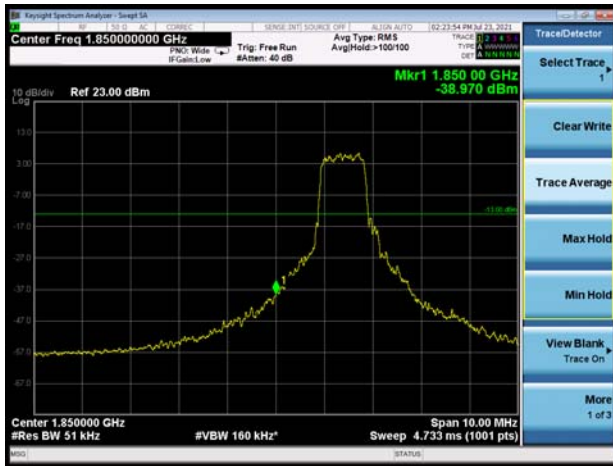

LTE Band 2 15MHz 16QAM 100%RB CH-High

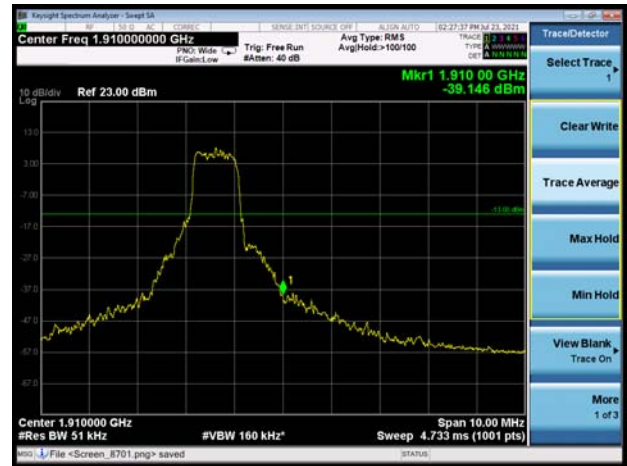

LTE Band 2 20MHz 16QAM 1RB CH-Low



LTE Band 2 20MHz 16QAM 1RB CH-High



LTE Band 2 20MHz 16QAM 100%RB CH-Low

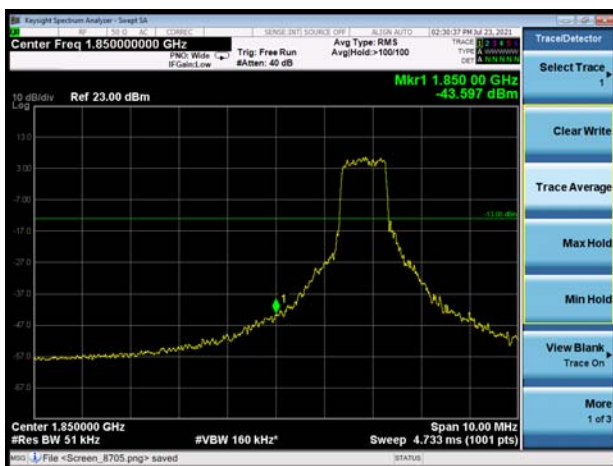

LTE Band 2 20MHz 16QAM 100%RB CH-High

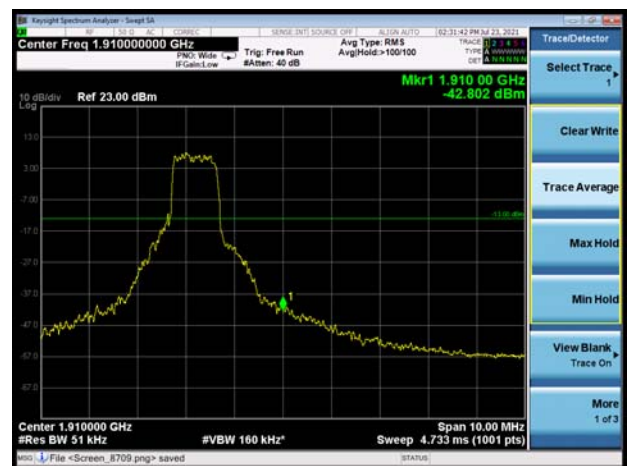



LTE Band 25 1.4MHz QPSK 1RB CH-Low

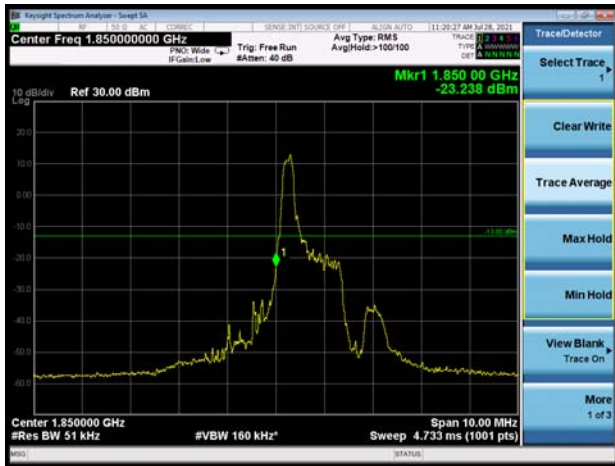

LTE Band 25 1.4MHz QPSK 1RB CH-High



LTE Band 25 1.4MHz QPSK 100%RB CH-Low

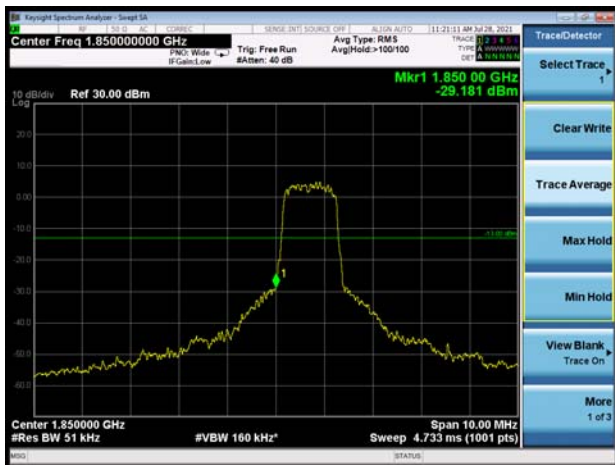

LTE Band 25 1.4MHz QPSK 100%RB CH-High

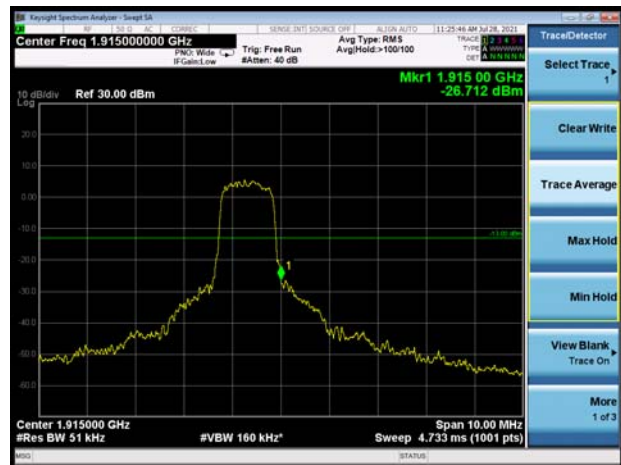

LTE Band 25 3MHz QPSK 1RB CH-Low

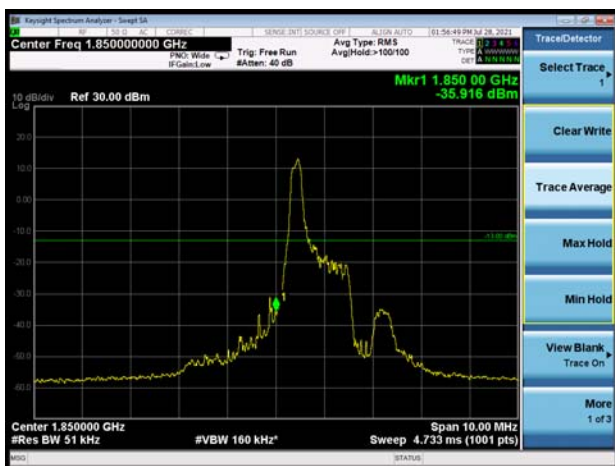

LTE Band 25 3MHz QPSK 1RB CH-High





LTE Band 25 3MHz QPSK 100%RB CH-Low

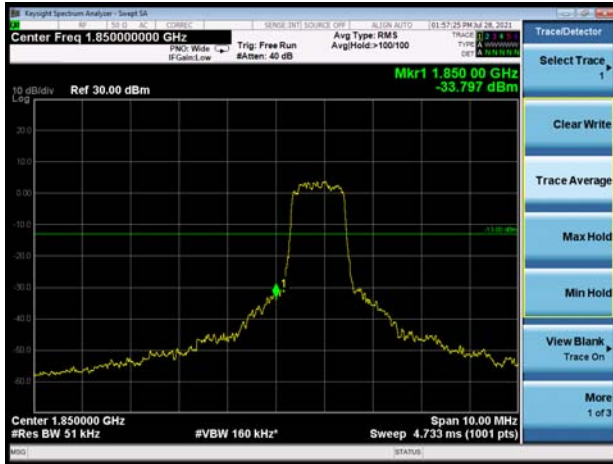

LTE Band 25 3MHz QPSK 100%RB CH-High

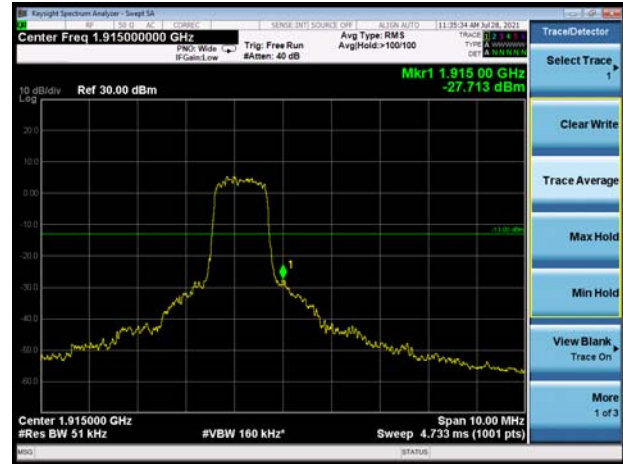

LTE Band 25 5MHz QPSK 1RB CH-Low



LTE Band 25 5MHz QPSK 1RB CH-High



LTE Band 25 5MHz QPSK 100%RB CH-Low

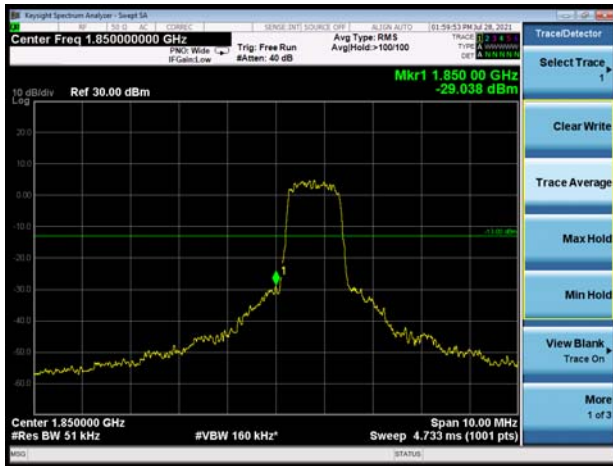

LTE Band 25 5MHz QPSK 100%RB CH-High

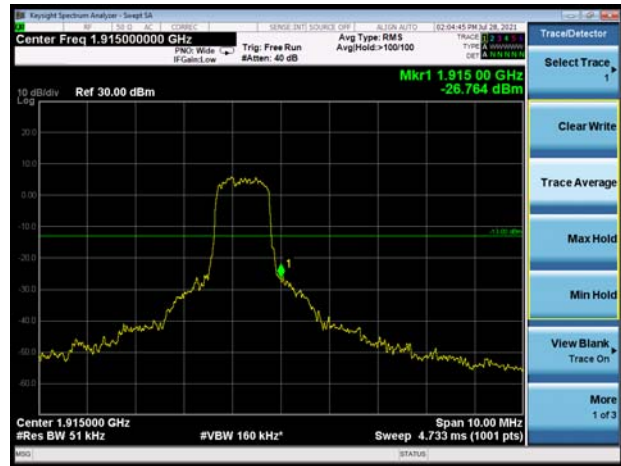

LTE Band 25 10MHz QPSK 1RB CH-Low



LTE Band 25 10MHz QPSK 1RB CH-High



LTE Band 25 10MHz QPSK 100%RB CH-Low

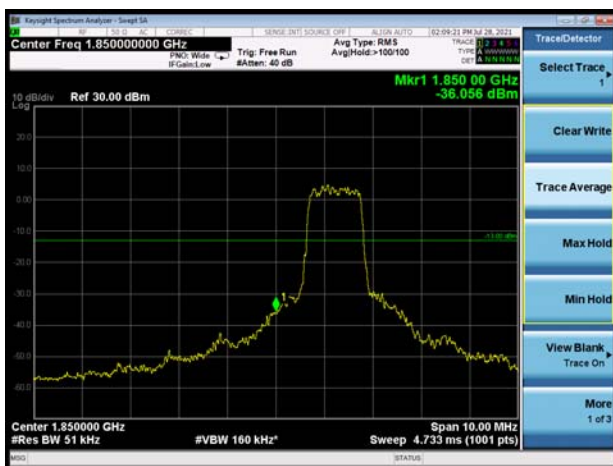

LTE Band 25 10MHz QPSK 100%RB CH-High

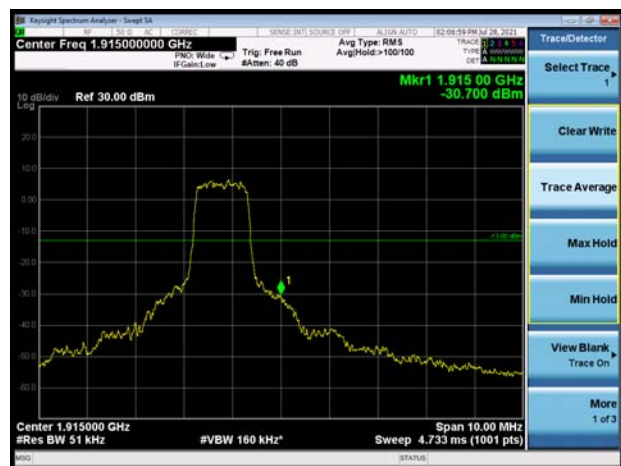

LTE Band 25 15MHz QPSK 1RB CH-Low

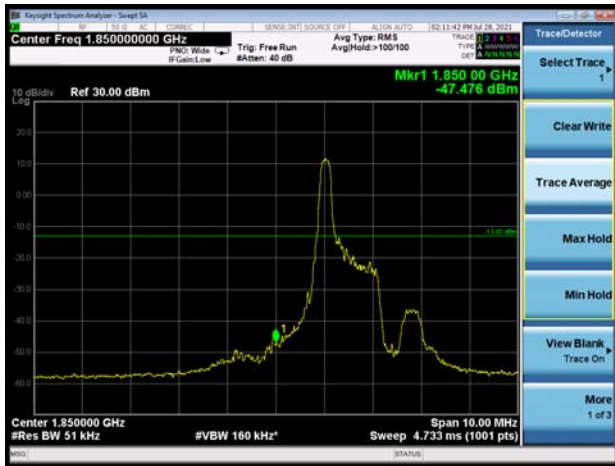

LTE Band 25 15MHz QPSK 1RB CH-High



LTE Band 25 15MHz QPSK 100%RB CH-Low

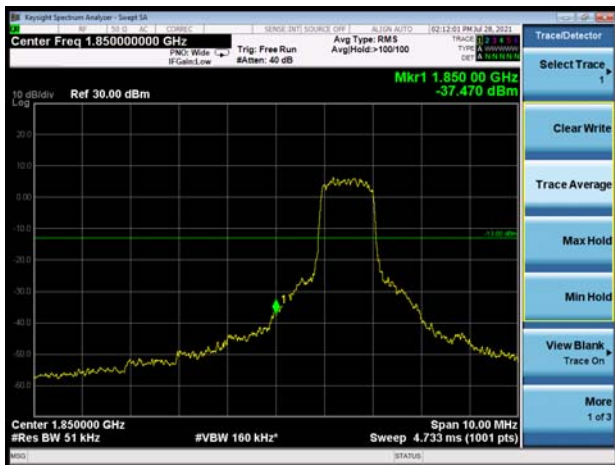

LTE Band 25 15MHz QPSK 100%RB CH-High

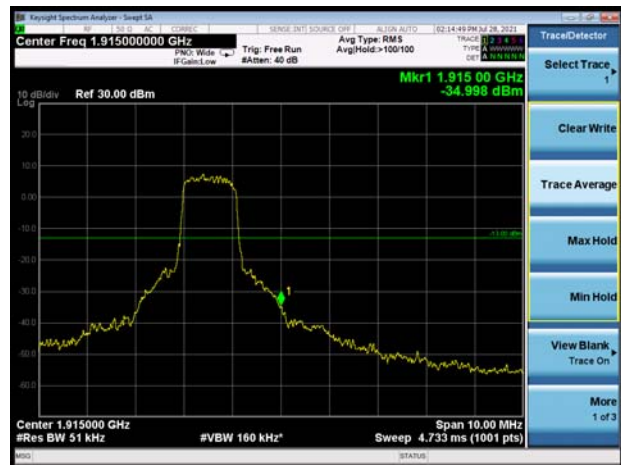

LTE Band 25 20MHz QPSK 1RB CH-Low



LTE Band 25 20MHz QPSK 1RB CH-High





LTE Band 25 20MHz QPSK 100%RB CH-Low

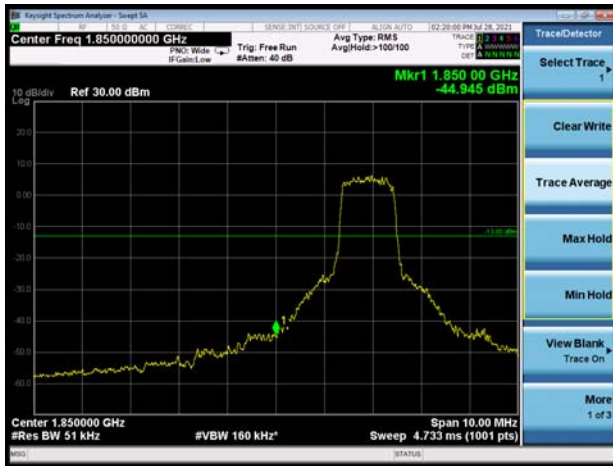

LTE Band 25 20MHz QPSK 100%RB CH-High



LTE Band 25 1.4MHz 16QAM 1RB CH-Low



LTE Band 25 1.4MHz 16QAM 1RB CH-High



LTE Band 25 1.4MHz 16QAM 100%RB CH-Low

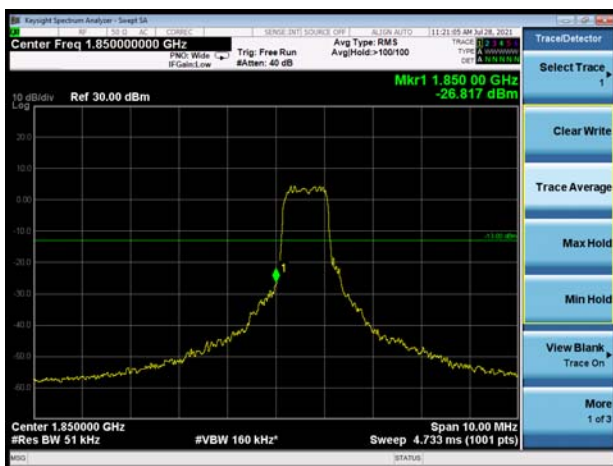

LTE Band 25 1.4MHz 16QAM 100%RB CH-High

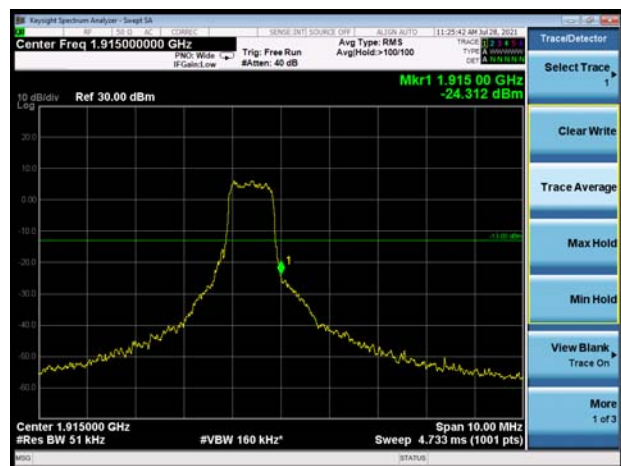



LTE Band 25 3MHz 16QAM 1RB CH-Low



LTE Band 25 3MHz 16QAM 1RB CH-High



LTE Band 25 3MHz 16QAM 100%RB CH-Low

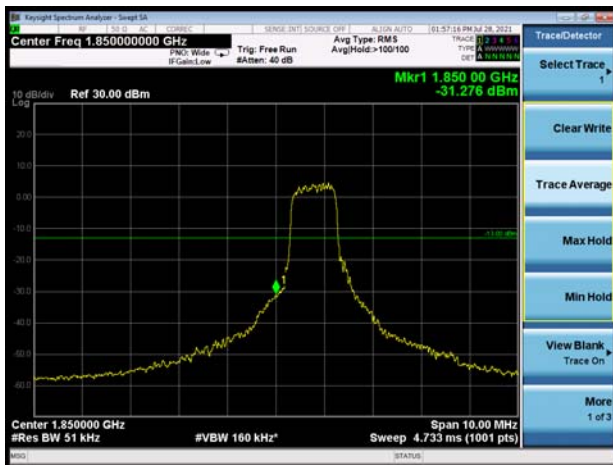

LTE Band 25 3MHz 16QAM 100%RB CH-High

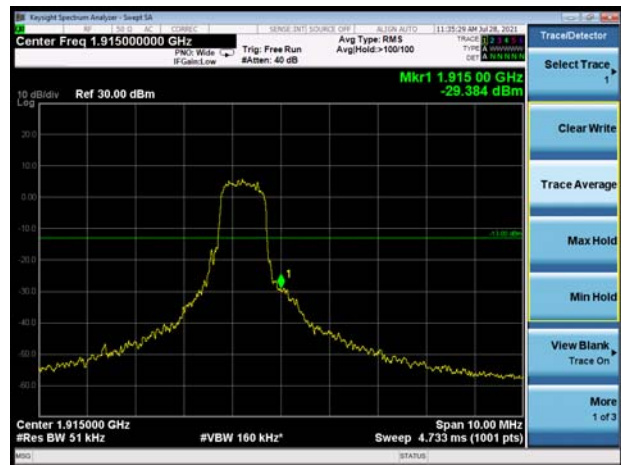

LTE Band 25 5MHz 16QAM 1RB CH-Low

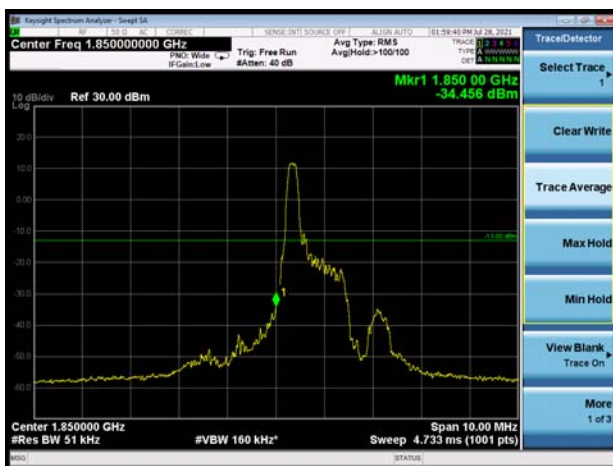

LTE Band 25 5MHz 16QAM 1RB CH-High





LTE Band 25 5MHz 16QAM 100%RB CH-Low

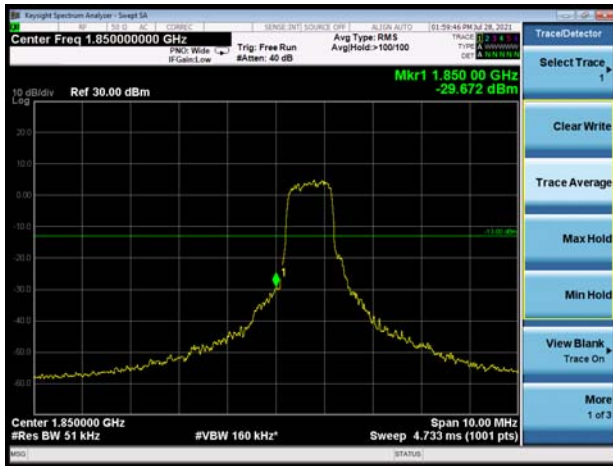

LTE Band 25 5MHz 16QAM 100%RB CH-High

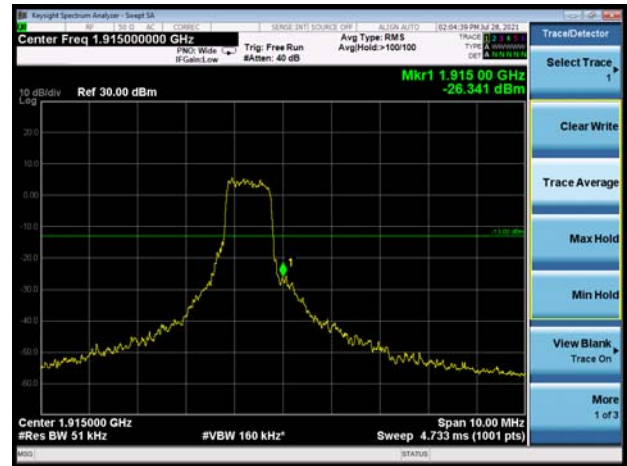

LTE Band 25 10MHz 16QAM 1RB CH-Low



LTE Band 25 10MHz 16QAM 1RB CH-High



LTE Band 25 10MHz 16QAM 100%RB CH-Low

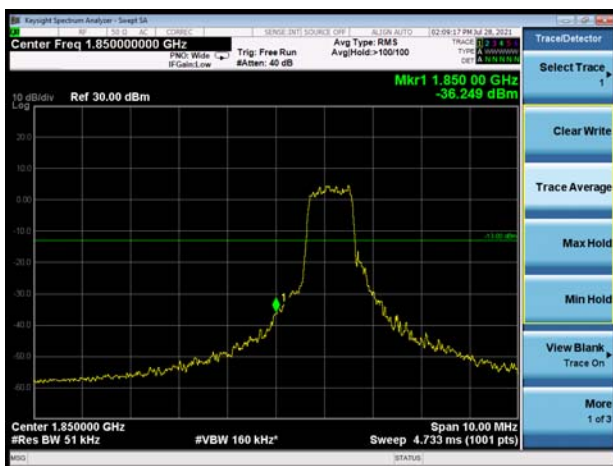

LTE Band 25 10MHz 16QAM 100%RB CH-High

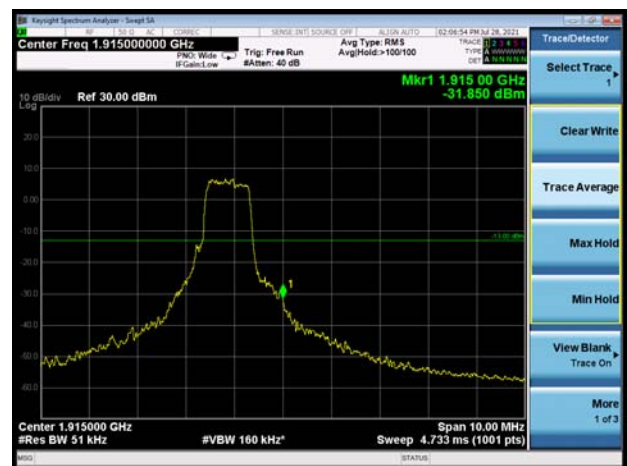

LTE Band 25 15MHz 16QAM 1RB CH-Low



LTE Band 25 15MHz 16QAM 1RB CH-High

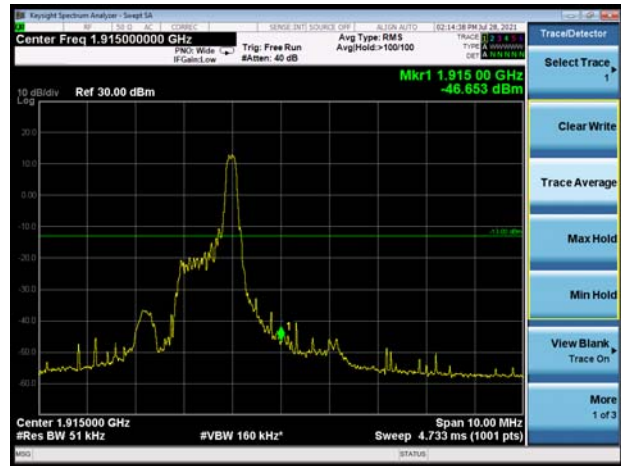

LTE Band 25 15MHz 16QAM 100%RB CH-Low

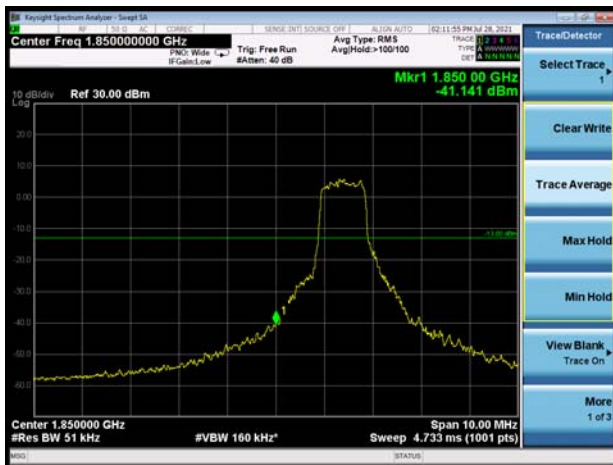

LTE Band 25 15MHz 16QAM 100%RB CH-High

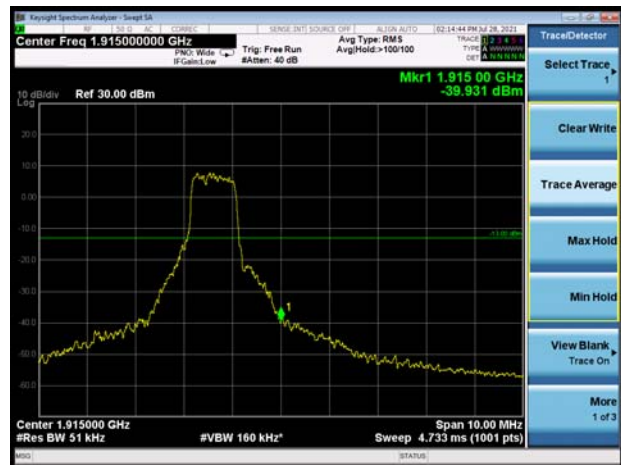

LTE Band 25 20MHz 16QAM 1RB CH-Low



LTE Band 25 20MHz 16QAM 1RB CH-High

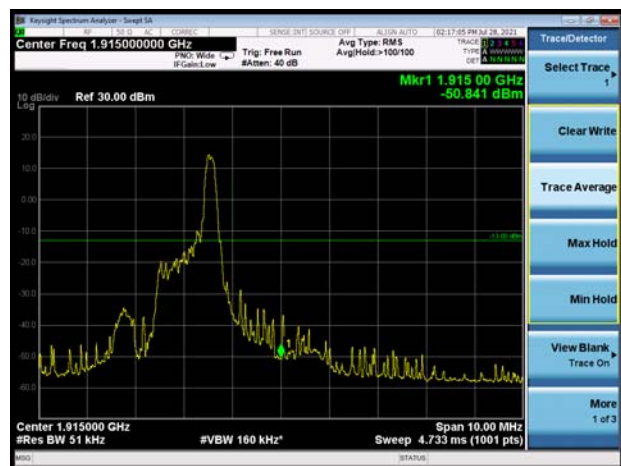



LTE Band 25 20MHz 16QAM 100%RB CH-Low

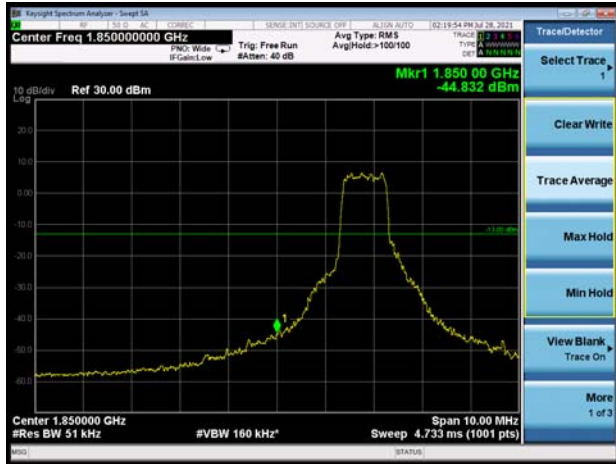

LTE Band 25 20MHz 16QAM 100%RB CH-High

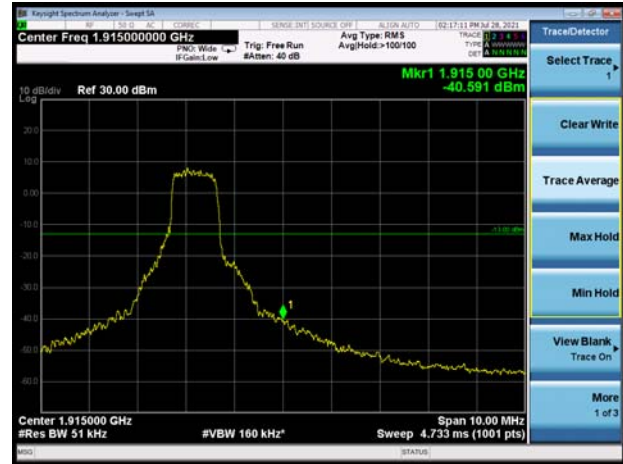

5.4. Peak-to-Average Power Ratio (PAPR)

Ambient condition

Temperature	Relative humidity	Pressure
23°C ~25°C	45%~50%	101.5kPa

Methods of Measurement

Measure the total peak power and record as PPK. And measure the total average power and record as PAvg. Both the peak and average power levels must be expressed in the same logarithmic units (e.g., dBm). Determine the PAPR from:

$$PAPR (dB) = PPK (dBm) - PAvg (dBm).$$

Test Setup

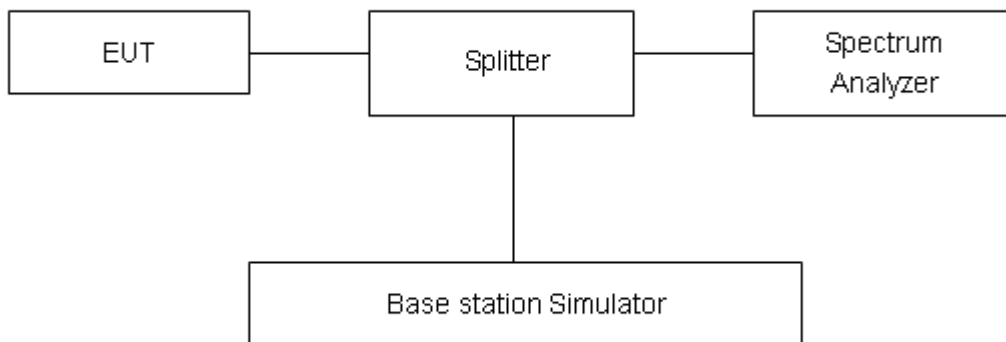

Limits

In measuring transmissions in this band using an average power technique, the peak-to-average ratio (PAR) of the transmission may not exceed 13 dB in 24.232(d).

Measurement Uncertainty

The assessed measurement uncertainty to ensure 95% confidence level for the normal distribution is with the coverage factor $k = 2$, $U = 0.4$ dB.

Test Results

Mode	Bandwidth	Modulation	Channel/ Frequency (MHz)	Peak-to-Average Power Ratio (PAPR)			Limit (dB)	Conclusion
				Peak (dBm)	Avg (dBm)	PAPR (dB)		
LTE Band 2	1.4MHz	QPSK	18900/1880	25.55	15.98	9.57	≤13	PASS
		16QAM	18900/1880	26.57	16.79	9.78	≤13	PASS
	3MHz	QPSK	18900/1880	25.76	15.79	9.97	≤13	PASS
		16QAM	18900/1880	26.35	15.09	11.26	≤13	PASS
	5MHz	QPSK	18900/1880	26.73	17.15	9.58	≤13	PASS
		16QAM	18900/1880	26.54	15.33	11.21	≤13	PASS
	10MHz	QPSK	18900/1880	26.61	17.55	9.06	≤13	PASS
		16QAM	18900/1880	27.18	17.43	9.75	≤13	PASS
	15MHz	QPSK	18900/1880	27.18	17.98	9.20	≤13	PASS
		16QAM	18900/1880	27.46	18.47	8.99	≤13	PASS
	20MHz	QPSK	18900/1880	27.18	17.90	9.28	≤13	PASS
		16QAM	18900/1880	27.50	18.17	9.33	≤13	PASS

Mode	Bandwidth	Modulation	Channel/ Frequency (MHz)	Peak-to-Average Power Ratio (PAPR)			Limit (dB)	Conclusion
				Peak (dBm)	Avg (dBm)	PAPR (dB)		
LTE Band 25	1.4MHz	QPSK	26365/1882.5	25.99	16.18	9.81	≤13	PASS
		16QAM	20175/1732.5	26.37	15.03	11.34	≤13	PASS
	3MHz	QPSK	20175/1732.5	25.79	16.31	9.48	≤13	PASS
		16QAM	20175/1732.5	26.68	17.17	9.51	≤13	PASS
	5MHz	QPSK	20175/1732.5	26.71	17.56	9.15	≤13	PASS
		16QAM	20175/1732.5	26.70	16.65	10.05	≤13	PASS
	10MHz	QPSK	20175/1732.5	26.60	17.52	9.08	≤13	PASS
		16QAM	20175/1732.5	26.91	16.34	10.57	≤13	PASS
	15MHz	QPSK	20175/1732.5	26.94	18.37	8.57	≤13	PASS
		16QAM	20175/1732.5	27.20	17.67	9.53	≤13	PASS
	20MHz	QPSK	20175/1732.5	26.92	17.95	8.97	≤13	PASS
		16QAM	20175/1732.5	27.22	17.48	9.74	≤13	PASS

5.5. Frequency Stability

Ambient condition

Temperature	Relative humidity	Pressure
23°C ~25°C	45%~50%	101.5kPa

Method of Measurement

Frequency Stability (Temperature Variation)

The temperature inside the climate chamber is varied from -35°C to +75°C in 10°C step size,

(1) With all power removed, the temperature was decreased to 0°C and permitted to stabilize for three hours.

(2) Measure the carrier frequency with the test equipment in a “call mode”. These measurements should be made within 1 minute of powering up the mobile station, to prevent significant self warming.

(3) Repeat the above measurements at 10°C increments from -35°C to +75°C. Allow at least 1.5 hours at each temperature, un-powered, before making measurements.

Frequency Stability (Voltage Variation)

The frequency stability shall be measured with variation of primary supply voltage as follows:

Primary Supply Voltage: The primary supply voltage is varied from 85% to 115% of the nominal value for non hand-carried battery and AC powered equipment. For hand-carried, battery-powered equipment, primary supply voltage is reduced to the battery operating end point which shall be specified by the manufacturer.

This transceiver is specified to operate with an input voltage of between 2.2V and 4.35 V, with a nominal voltage of 3.3V.

Test setup

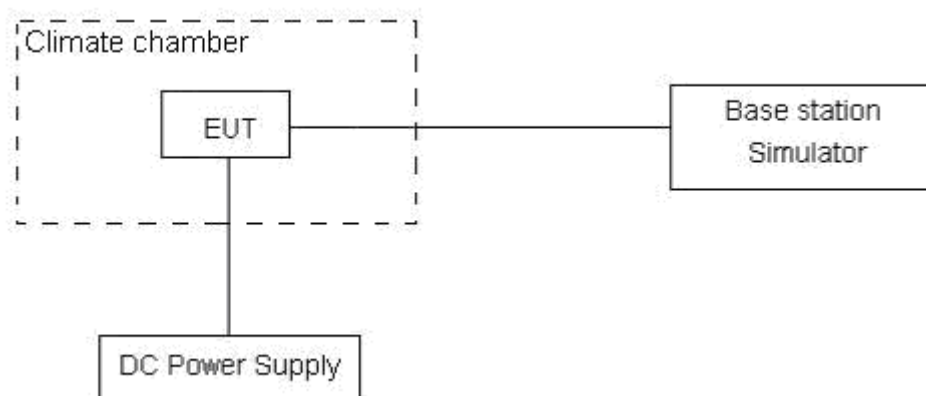

**Limits**

The frequency stability shall be sufficient to ensure that the fundamental emission stays within the authorized frequency block

Measurement Uncertainty

The assessed measurement uncertainty to ensure 99.75% confidence level for the normal distribution is with the coverage factor $k = 3$, $U = 0.01\text{ppm}$.

Test Result

LTE Band 2						
Condition		Freq.Error (Hz)	Freq.Error (Hz)	Frequency Stability (ppm)	Frequency Stability (ppm)	Verdict
BANDWIDTH	1.4MHz					
Temperature	Voltage	16QAM	QPSK	16QAM	QPSK	
Normal (25°C)	Normal	11.11	1.38	0.00591	0.00074	PASS
Extreme (75°C)		13.35	5.26	0.00710	0.00280	PASS
Extreme (70°C)		12.54	8.83	0.00667	0.00469	PASS
Extreme (60°C)		16.86	8.51	0.00897	0.00452	PASS
Extreme (50°C)		3.37	8.20	0.00179	0.00436	PASS
Extreme (40°C)		16.21	13.01	0.00862	0.00692	PASS
Extreme (30°C)		7.18	10.14	0.00382	0.00539	PASS
Extreme (20°C)		8.85	7.24	0.00471	0.00385	PASS
Extreme (10°C)		12.33	10.31	0.00656	0.00549	PASS
Extreme (0°C)		5.73	4.97	0.00305	0.00265	PASS
Extreme (-10°C)		10.35	2.37	0.00550	0.00126	PASS
Extreme (-20°C)		1.85	13.91	0.00099	0.00740	PASS
Extreme (-30°C)		3.36	1.17	0.00179	0.00062	PASS
Extreme (-35°C)			17.51	11.30	0.00932	0.00601
25°C	LV	1.55	15.31	0.00083	0.00814	PASS
	HV	3.24	16.66	0.00172	0.00886	PASS
Condition		Freq.Error (Hz)	Freq.Error (Hz)	Frequency Stability (ppm)	Frequency Stability (ppm)	Verdict
BANDWIDTH	3MHz					
Temperature	Voltage	16QAM	QPSK	16QAM	QPSK	
Normal (25°C)	Normal	6.69	17.66	0.00356	0.00940	PASS
Extreme (75°C)		1.06	7.56	0.00056	0.00402	PASS
Extreme (70°C)		7.45	10.06	0.00396	0.00535	PASS
Extreme (60°C)		7.17	14.20	0.00381	0.00755	PASS
Extreme (50°C)		6.16	14.85	0.00328	0.00790	PASS
Extreme (40°C)		14.73	17.30	0.00784	0.00920	PASS
Extreme (30°C)		8.25	14.17	0.00439	0.00754	PASS
Extreme (20°C)		4.17	3.42	0.00222	0.00182	PASS
Extreme (10°C)		9.40	15.42	0.00500	0.00820	PASS
Extreme (0°C)		4.47	13.80	0.00238	0.00734	PASS
Extreme (-10°C)		8.53	2.46	0.00454	0.00131	PASS
Extreme (-20°C)		8.98	7.17	0.00478	0.00381	PASS
Extreme (-30°C)		1.98	7.94	0.00106	0.00422	PASS
Extreme (-35°C)			14.81	10.95	0.00788	0.00583
25°C	LV	2.77	16.42	0.00147	0.00873	PASS



Condition		Freq.Error (Hz)	Freq.Error (Hz)	Frequency Stability (ppm)	Frequency Stability (ppm)	Verdict
BANDWIDTH	5MHz					
Temperature	Voltage	16QAM	QPSK	16QAM	QPSK	
Normal (25°C)	Normal	6.95	10.77	0.00370	0.00573	PASS
Extreme (75°C)		2.25	6.43	0.00120	0.00342	PASS
Extreme (70°C)		17.14	7.49	0.00912	0.00398	PASS
Extreme (60°C)		16.87	16.23	0.00897	0.00863	PASS
Extreme (50°C)		5.21	11.36	0.00277	0.00604	PASS
Extreme (40°C)		14.92	4.72	0.00794	0.00251	PASS
Extreme (30°C)		10.28	3.55	0.00547	0.00189	PASS
Extreme (20°C)		7.74	6.35	0.00412	0.00338	PASS
Extreme (10°C)		2.71	16.90	0.00144	0.00899	PASS
Extreme (0°C)		12.38	2.38	0.00659	0.00127	PASS
Extreme (-10°C)		1.35	8.11	0.00072	0.00431	PASS
Extreme (-20°C)		14.31	5.50	0.00761	0.00292	PASS
Extreme (-30°C)		11.52	12.71	0.00613	0.00676	PASS
Extreme (-35°C)		11.76	6.49	0.00625	0.00345	PASS
25°C		LV	10.30	5.90	0.00548	0.00314
	HV	8.92	13.48	0.00475	0.00717	PASS
Condition		Freq.Error (Hz)	Freq.Error (Hz)	Frequency Stability (ppm)	Frequency Stability (ppm)	Verdict
BANDWIDTH	10MHz					
Temperature	Voltage	16QAM	QPSK	16QAM	QPSK	
Normal (25°C)	Normal	2.68	1.64	0.00143	0.00087	PASS
Extreme (75°C)		6.60	13.52	0.00351	0.00719	PASS
Extreme (70°C)		7.94	15.01	0.00422	0.00798	PASS
Extreme (60°C)		4.51	9.47	0.00240	0.00504	PASS
Extreme (50°C)		5.24	6.28	0.00279	0.00334	PASS
Extreme (40°C)		11.65	6.58	0.00620	0.00350	PASS
Extreme (30°C)		13.55	17.65	0.00721	0.00939	PASS
Extreme (20°C)		5.24	8.81	0.00279	0.00469	PASS
Extreme (10°C)		12.90	11.15	0.00686	0.00593	PASS
Extreme (0°C)		15.24	13.00	0.00811	0.00691	PASS
Extreme (-10°C)		2.24	16.51	0.00119	0.00878	PASS
Extreme (-20°C)		8.30	13.52	0.00442	0.00719	PASS
Extreme (-30°C)		6.77	10.69	0.00360	0.00569	PASS
Extreme (-35°C)		11.88	1.25	0.00632	0.00066	PASS
25°C		LV	2.72	3.32	0.00145	0.00176
	HV	13.43	10.04	0.00714	0.00534	PASS
Condition		Freq.Error	Freq.Error	Frequency	Frequency	Verdict



BANDWIDTH		15MHz	(Hz)	(Hz)	Stability (ppm)	Stability (ppm)	
Temperature	Voltage	16QAM	QPSK	16QAM	QPSK		
Normal (25°C)	Normal	7.75	10.23	0.00412	0.00544	PASS	
Extreme (75°C)		12.59	2.72	0.00670	0.00145	PASS	
Extreme (70°C)		14.00	2.39	0.00745	0.00127	PASS	
Extreme (60°C)		17.84	2.02	0.00949	0.00107	PASS	
Extreme (50°C)		10.63	14.67	0.00566	0.00780	PASS	
Extreme (40°C)		14.68	5.78	0.00781	0.00308	PASS	
Extreme (30°C)		7.20	1.01	0.00383	0.00054	PASS	
Extreme (20°C)		6.84	11.59	0.00364	0.00617	PASS	
Extreme (10°C)		6.34	13.59	0.00337	0.00723	PASS	
Extreme (0°C)		13.91	15.23	0.00740	0.00810	PASS	
Extreme (-10°C)		7.68	3.29	0.00409	0.00175	PASS	
Extreme (-20°C)		3.36	1.49	0.00178	0.00079	PASS	
Extreme (-30°C)		5.42	8.46	0.00288	0.00450	PASS	
Extreme (-35°C)		12.83	9.71	0.00683	0.00516	PASS	
25°C		LV	10.46	12.63	0.00557	0.00672	PASS
	HV	3.51	4.15	0.00187	0.00221	PASS	
Condition		Freq.Error (Hz)	Freq.Error (Hz)	Frequency Stability (ppm)	Frequency Stability (ppm)	Verdict	
BANDWIDTH	20MHz	16QAM	QPSK	16QAM	QPSK		
Normal (25°C)	Normal	4.13	14.77	0.00220	0.00786	PASS	
Extreme (75°C)		8.28	5.85	0.00441	0.00311	PASS	
Extreme (70°C)		7.64	4.98	0.00406	0.00265	PASS	
Extreme (60°C)		3.77	5.36	0.00200	0.00285	PASS	
Extreme (50°C)		8.92	13.23	0.00475	0.00704	PASS	
Extreme (40°C)		7.28	17.73	0.00387	0.00943	PASS	
Extreme (30°C)		5.59	3.26	0.00298	0.00173	PASS	
Extreme (20°C)		3.86	5.41	0.00205	0.00288	PASS	
Extreme (10°C)		12.07	9.35	0.00642	0.00497	PASS	
Extreme (0°C)		5.04	17.68	0.00268	0.00941	PASS	
Extreme (-10°C)		3.26	6.53	0.00173	0.00347	PASS	
Extreme (-20°C)		8.80	17.29	0.00468	0.00920	PASS	
Extreme (-30°C)		2.85	8.06	0.00151	0.00429	PASS	
Extreme (-35°C)		7.02	8.22	0.00374	0.00437	PASS	
25°C		LV	4.39	7.32	0.00233	0.00389	PASS
	HV	13.51	7.54	0.00719	0.00401	PASS	



LTE Band 25						
Condition		Freq.Error (Hz)	Freq.Error (Hz)	Frequency Stability (ppm)	Frequency Stability (ppm)	Verdict
BANDWIDTH	1.4MHz					
Temperature	Voltage	16QAM	QPSK	16QAM	QPSK	
Normal (25°C)	Normal	8.49	15.74	0.00451	0.00836	PASS
Extreme (75°C)		8.45	14.44	0.00449	0.00767	PASS
Extreme (70°C)		8.82	15.84	0.00468	0.00841	PASS
Extreme (60°C)		2.76	2.54	0.00147	0.00135	PASS
Extreme (50°C)		12.08	4.45	0.00642	0.00237	PASS
Extreme (40°C)		7.37	5.40	0.00391	0.00287	PASS
Extreme (30°C)		9.31	8.10	0.00494	0.00430	PASS
Extreme (20°C)		11.22	11.35	0.00596	0.00603	PASS
Extreme (10°C)		17.06	8.99	0.00906	0.00478	PASS
Extreme (0°C)		5.46	15.78	0.00290	0.00838	PASS
Extreme (-10°C)		12.38	13.35	0.00658	0.00709	PASS
Extreme (-20°C)		12.31	3.82	0.00654	0.00203	PASS
Extreme (-30°C)		14.36	7.49	0.00763	0.00398	PASS
Extreme (-35°C)		14.31	12.96	0.00760	0.00688	PASS
25°C	LV	11.91	17.98	0.00632	0.00955	PASS
	HV	8.36	2.86	0.00444	0.00152	PASS
Condition		Freq.Error (Hz)	Freq.Error (Hz)	Frequency Stability (ppm)	Frequency Stability (ppm)	Verdict
BANDWIDTH	3MHz					
Temperature	Voltage	16QAM	QPSK	16QAM	QPSK	
Normal (25°C)	Normal	15.07	16.68	0.00801	0.00886	PASS
Extreme (75°C)		4.16	9.98	0.00221	0.00530	PASS
Extreme (70°C)		16.24	11.75	0.00862	0.00624	PASS
Extreme (60°C)		17.33	13.27	0.00921	0.00705	PASS
Extreme (50°C)		14.50	8.45	0.00770	0.00449	PASS
Extreme (40°C)		9.74	11.63	0.00518	0.00618	PASS
Extreme (30°C)		12.04	5.85	0.00639	0.00311	PASS
Extreme (20°C)		3.27	17.73	0.00174	0.00942	PASS
Extreme (10°C)		1.14	4.55	0.00060	0.00242	PASS
Extreme (0°C)		14.96	10.39	0.00795	0.00552	PASS
Extreme (-10°C)		8.99	6.43	0.00477	0.00341	PASS
Extreme (-20°C)		12.09	1.27	0.00642	0.00067	PASS
Extreme (-30°C)		10.79	2.76	0.00573	0.00147	PASS
Extreme (-35°C)		7.31	1.30	0.00388	0.00069	PASS
25°C	LV	7.47	6.11	0.00397	0.00325	PASS
	HV	10.55	5.33	0.00560	0.00283	PASS



Condition		Freq.Error (Hz)	Freq.Error (Hz)	Frequency Stability (ppm)	Frequency Stability (ppm)	Verdict
BANDWIDTH	5MHz					
Temperature	Voltage	16QAM	QPSK	16QAM	QPSK	
Normal (25°C)	Normal	17.07	11.46	0.00907	0.00609	PASS
Extreme (75°C)		12.11	10.39	0.00644	0.00552	PASS
Extreme (70°C)		11.66	11.91	0.00620	0.00633	PASS
Extreme (60°C)		1.62	12.42	0.00086	0.00660	PASS
Extreme (50°C)		8.94	14.68	0.00475	0.00780	PASS
Extreme (40°C)		13.47	1.02	0.00715	0.00054	PASS
Extreme (30°C)		5.65	1.91	0.00300	0.00101	PASS
Extreme (20°C)		7.14	10.21	0.00379	0.00542	PASS
Extreme (10°C)		5.62	16.54	0.00299	0.00879	PASS
Extreme (0°C)		9.49	2.73	0.00504	0.00145	PASS
Extreme (-10°C)		16.48	10.72	0.00876	0.00570	PASS
Extreme (-20°C)		3.87	10.83	0.00206	0.00575	PASS
Extreme (-30°C)		11.94	6.93	0.00634	0.00368	PASS
Extreme (-35°C)		14.10	17.54	0.00749	0.00932	PASS
25°C	LV	6.24	9.74	0.00331	0.00518	PASS
	HV	7.76	5.38	0.00412	0.00286	PASS
Condition		Freq.Error (Hz)	Freq.Error (Hz)	Frequency Stability (ppm)	Frequency Stability (ppm)	Verdict
BANDWIDTH	10MHz					
Temperature	Voltage	16QAM	QPSK	16QAM	QPSK	
Normal (25°C)	Normal	2.44	8.67	0.00130	0.00460	PASS
Extreme (75°C)		5.94	3.72	0.00315	0.00198	PASS
Extreme (70°C)		3.00	3.01	0.00159	0.00160	PASS
Extreme (60°C)		14.97	2.65	0.00795	0.00141	PASS
Extreme (50°C)		6.82	5.65	0.00362	0.00300	PASS
Extreme (40°C)		11.41	3.40	0.00606	0.00181	PASS
Extreme (30°C)		2.67	6.16	0.00142	0.00327	PASS
Extreme (20°C)		9.60	15.85	0.00510	0.00842	PASS
Extreme (10°C)		9.50	2.72	0.00505	0.00145	PASS
Extreme (0°C)		16.47	13.20	0.00875	0.00701	PASS
Extreme (-10°C)		17.71	7.30	0.00941	0.00388	PASS
Extreme (-20°C)		4.35	8.98	0.00231	0.00477	PASS
Extreme (-30°C)		15.88	3.92	0.00844	0.00208	PASS
Extreme (-35°C)		16.24	11.71	0.00863	0.00622	PASS
25°C	LV	11.77	13.59	0.00625	0.00722	PASS
	HV	1.02	3.72	0.00054	0.00198	PASS
Condition		Freq.Error (Hz)	Freq.Error (Hz)	Frequency Stability	Frequency Stability	Verdict



BANDWIDTH	15MHz			(ppm)	(ppm)	
Temperature	Voltage	16QAM	QPSK	16QAM	QPSK	
Normal (25°C)	Normal	9.10	10.78	0.00483	0.00573	PASS
Extreme (75°C)		7.75	11.68	0.00412	0.00620	PASS
Extreme (70°C)		7.13	17.37	0.00379	0.00923	PASS
Extreme (60°C)		9.14	15.67	0.00486	0.00833	PASS
Extreme (50°C)		5.63	17.77	0.00299	0.00944	PASS
Extreme (40°C)		15.63	6.97	0.00830	0.00370	PASS
Extreme (30°C)		11.22	4.43	0.00596	0.00235	PASS
Extreme (20°C)		12.46	15.13	0.00662	0.00804	PASS
Extreme (10°C)		12.41	10.08	0.00659	0.00536	PASS
Extreme (0°C)		9.10	5.13	0.00483	0.00272	PASS
Extreme (-10°C)		11.83	17.30	0.00629	0.00919	PASS
Extreme (-20°C)		15.06	9.17	0.00800	0.00487	PASS
Extreme (-30°C)		13.33	5.66	0.00708	0.00301	PASS
Extreme (-35°C)		6.60	2.65	0.00350	0.00141	PASS
25°C	LV	7.21	14.90	0.00383	0.00792	PASS
	HV	6.36	5.56	0.00338	0.00295	PASS
Condition		Freq.Error (Hz)	Freq.Error (Hz)	Frequency Stability (ppm)	Frequency Stability (ppm)	Verdict
BANDWIDTH	20MHz					
Temperature	Voltage	16QAM	QPSK	16QAM	QPSK	
Normal (25°C)		11.35	4.96	0.00603	0.00263	PASS
Extreme (75°C)		14.36	8.10	0.00763	0.00430	PASS
Extreme (70°C)		15.55	11.21	0.00826	0.00596	PASS
Extreme (60°C)	Normal	3.64	17.65	0.00193	0.00938	PASS
Extreme (50°C)		16.36	4.04	0.00869	0.00215	PASS
Extreme (40°C)		13.97	10.83	0.00742	0.00575	PASS
Extreme (30°C)		16.49	15.35	0.00876	0.00816	PASS
Extreme (20°C)		13.26	9.71	0.00704	0.00516	PASS
Extreme (10°C)		7.93	8.05	0.00421	0.00428	PASS
Extreme (0°C)		16.56	15.51	0.00880	0.00824	PASS
Extreme (-10°C)		6.90	3.15	0.00366	0.00167	PASS
Extreme (-20°C)		13.29	11.60	0.00706	0.00616	PASS
Extreme (-30°C)		11.15	10.76	0.00592	0.00572	PASS
Extreme (-35°C)	12.75	6.71	0.00677	0.00356	PASS	
25°C	LV	14.10	3.85	0.00749	0.00204	PASS
	HV	4.98	15.94	0.00265	0.00847	PASS

5.6. Spurious Emissions at Antenna Terminals

Ambient condition

Temperature	Relative humidity	Pressure
23°C ~25°C	45%~50%	101.5kPa

Method of Measurement

The EUT was connected to Spectrum Analyzer and Base Station Simulator via power Splitter. The measurement is carried out using a spectrum analyzer. The spectrum analyzer scans from 9kHz to the 10th harmonic of the carrier. The peak detector is used.

RBW is set to 100kHz, VBW is set to 300kHz for 30MHz~1GHz

RBW is set to 1MHz, VBW is set to 3MHz for above 1GHz, Sweep is set to ATUO.

RBW is set to 1 kHz (0.009MHz~ 0.15 MHz),

RBW is set to 10 kHz (0.15 MHz~ 30 MHz)

RBW is set to 100 kHz (30MHz~1000 MHz)

RBW is set to 1000 kHz (above 1000MHz)

The modulation mode and RB allocation refer to section 5.1, using the maximum output power configuration.

Test setup

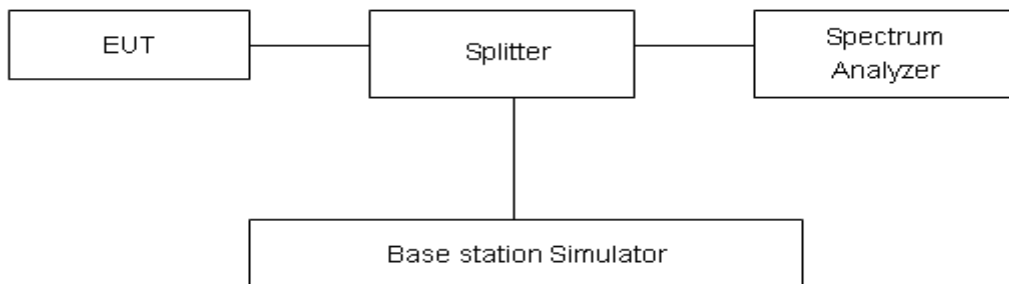

Limits

Rule Part 24.238(a) specifies that “on any frequency outside a licensee’s frequency block, the power of any emission shall be attenuated below the transmitter power (P) by at least 43 + 10 log₁₀ (P) dB.”

Limit	-13 dBm

Measurement Uncertainty

The assessed measurement uncertainty to ensure 99.75% confidence level for the normal distribution is with the coverage factor $k = 1.96$.

Frequency	Uncertainty
9kHz-1GHz	0.684 dB
1GHz-20GHz	1.407 dB



Test Result

Sweep the whole frequency band through the range from 9kHz to the 10th harmonic of the carrier, the emissions more than 20 dB below the limit are not reported.

The signal beyond the limit is carrier.

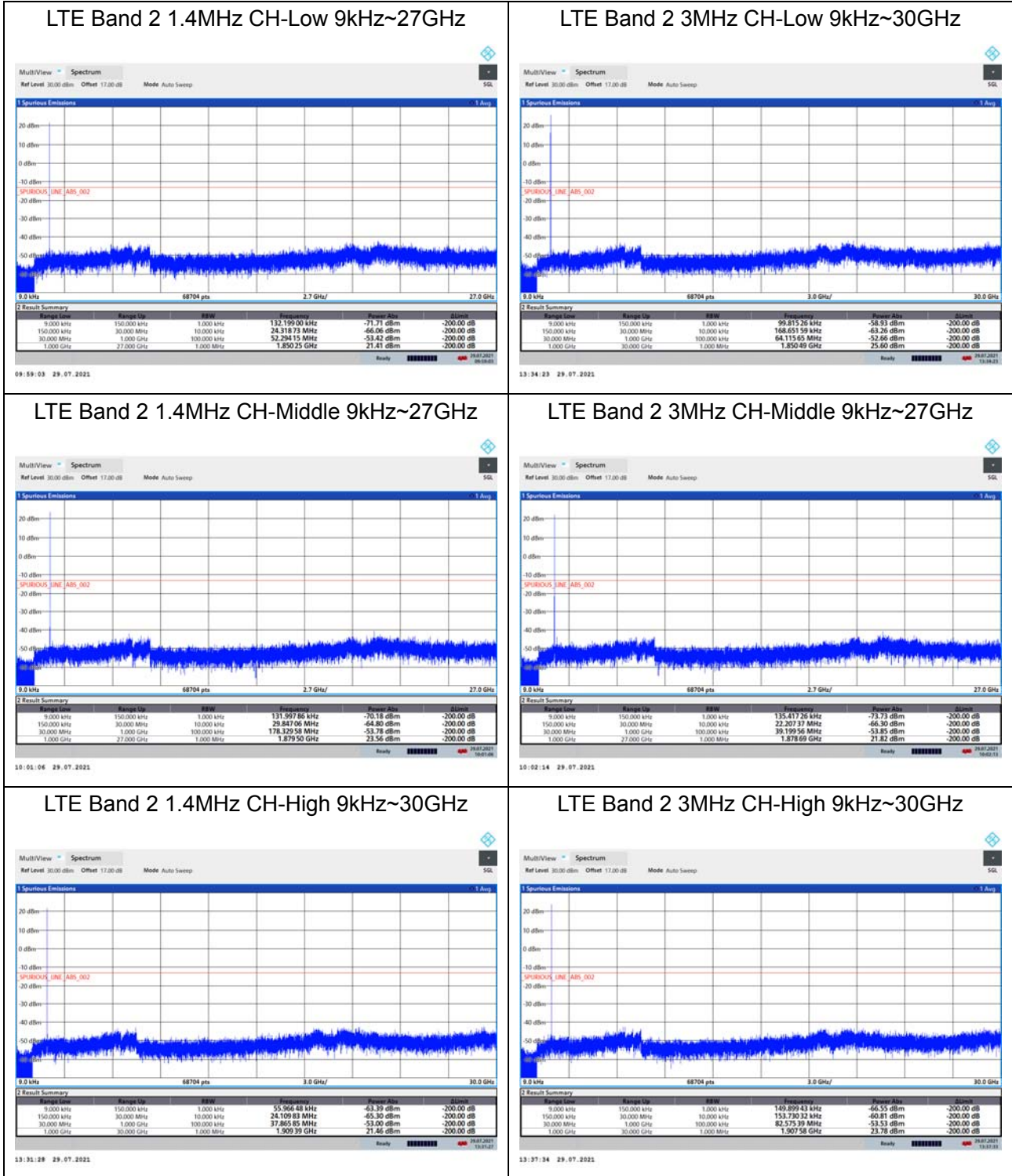



LTE Band 2 5MHz CH-Low 9kHz~30GHz

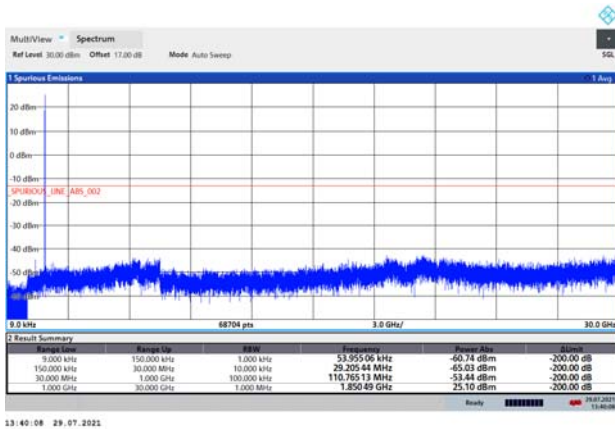

13:40:08 29.07.2021

LTE Band 2 10MHz CH-Low 9kHz~30GHz

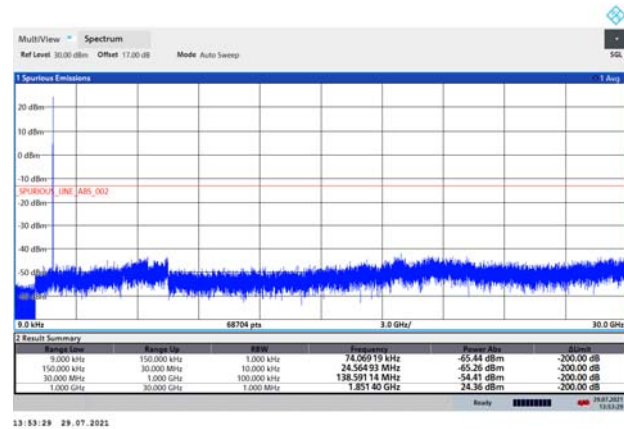

13:53:29 29.07.2021

LTE Band 2 5MHz CH-Middle 9kHz~17GHz

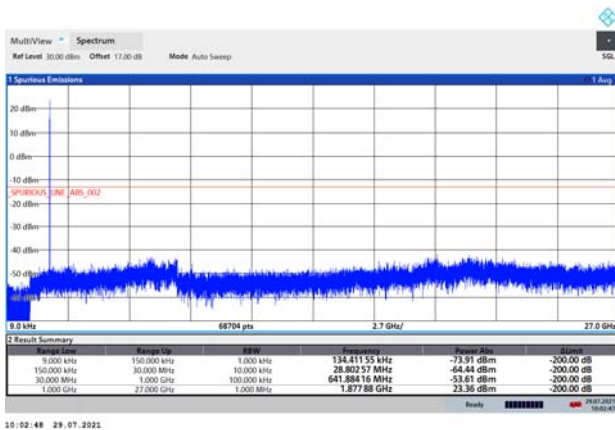

10:02:48 29.07.2021

LTE Band 2 10MHz CH-Middle 9kHz~30GHz

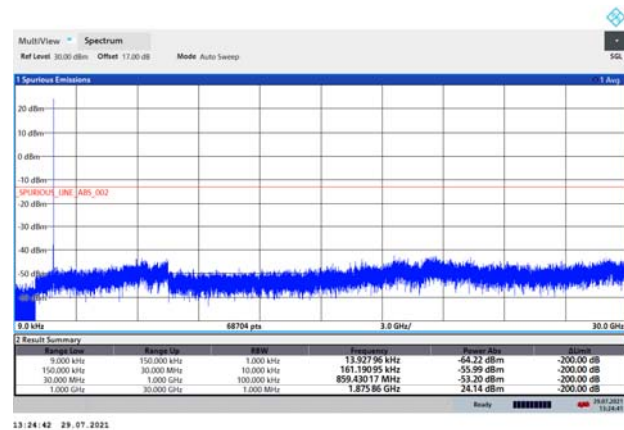

13:24:42 29.07.2021

LTE Band 2 5MHz CH-High 9kHz~30GHz

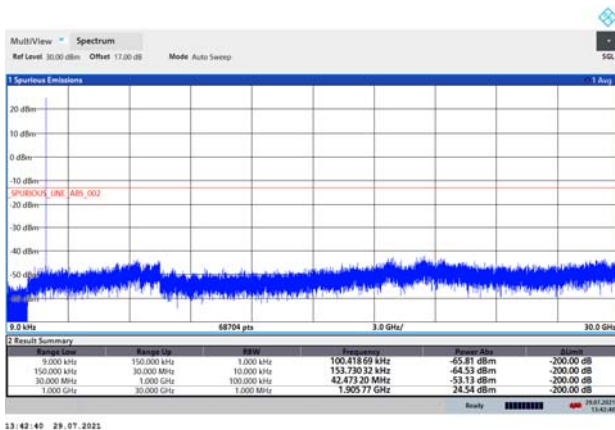

13:42:40 29.07.2021

LTE Band 2 10MHz CH-High 9kHz~30GHz

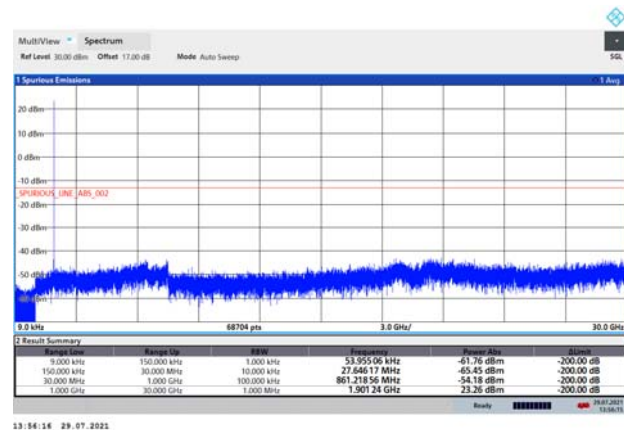

13:54:16 29.07.2021



LTE Band 2 15MHz CH-Low 9kHz~30GHz

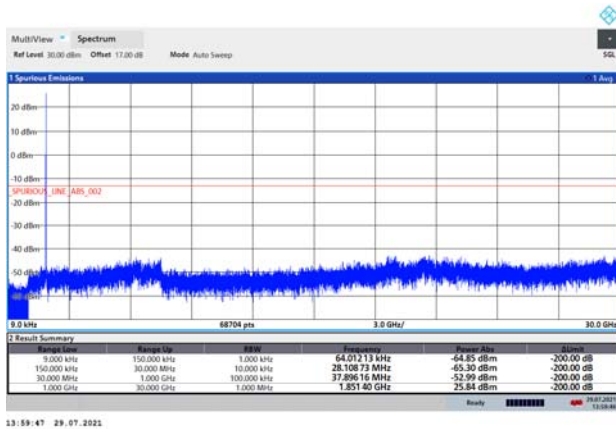

LTE Band 2 20MHz CH-Low 9kHz~30GHz

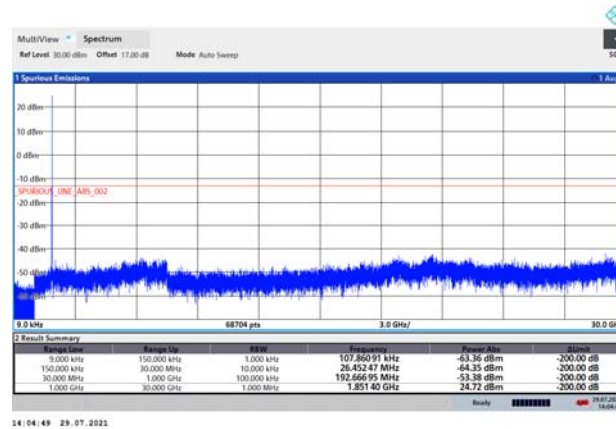

LTE Band 2 15MHz CH-Middle 9kHz~30GHz

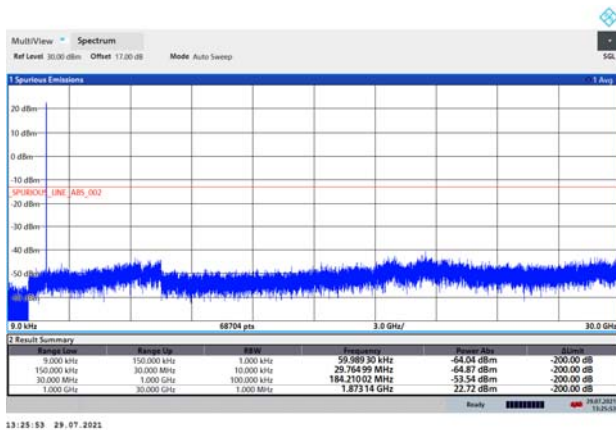

LTE Band 2 20MHz CH-Middle 9kHz~30GHz

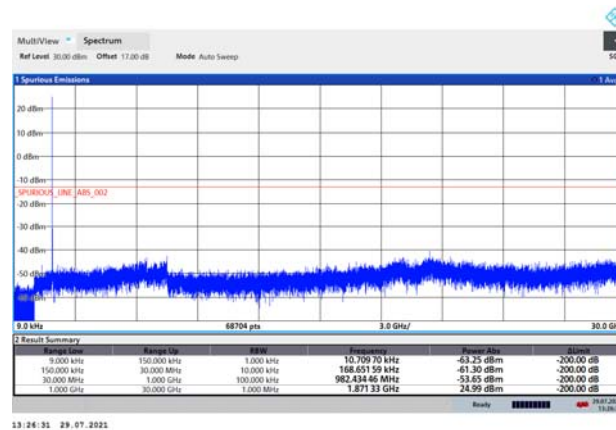

LTE Band 2 15MHz CH-High 9kHz~30GHz

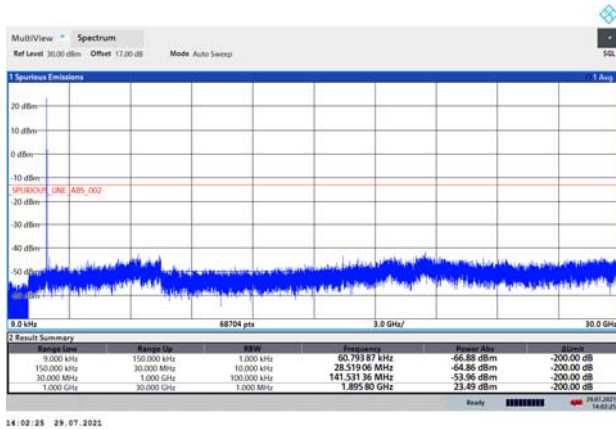

LTE Band 2 20MHz CH-High 9kHz~30GHz

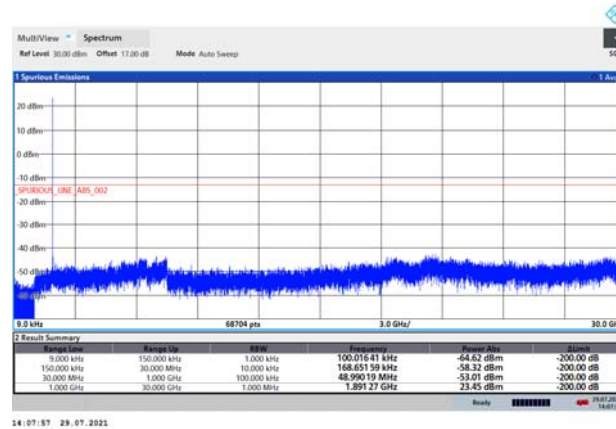



LTE Band 25 1.4MHz CH-Low 9kHz~30GHz

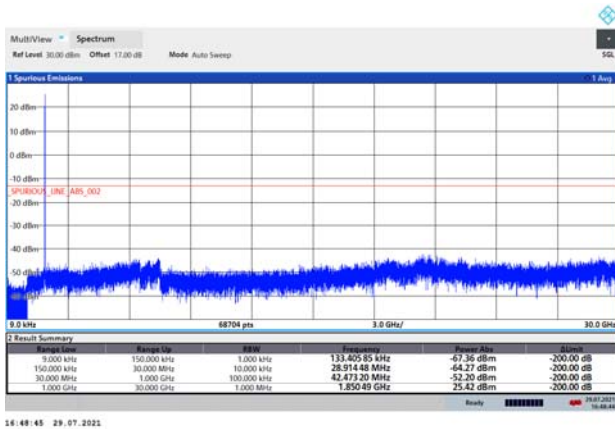

LTE Band 25 3MHz CH-Low 9kHz~30GHz

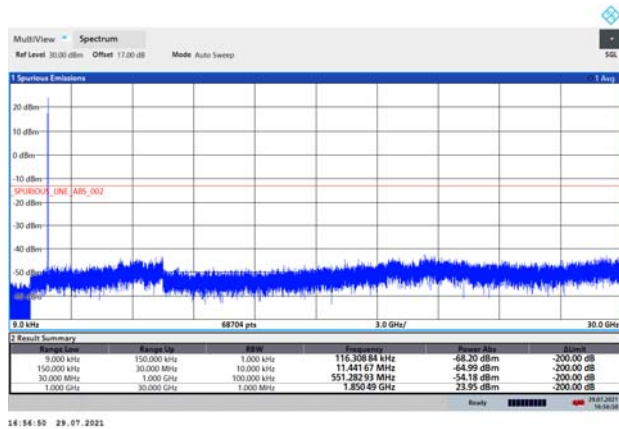

LTE Band 25 1.4MHz CH-Middle 9kHz~30GHz

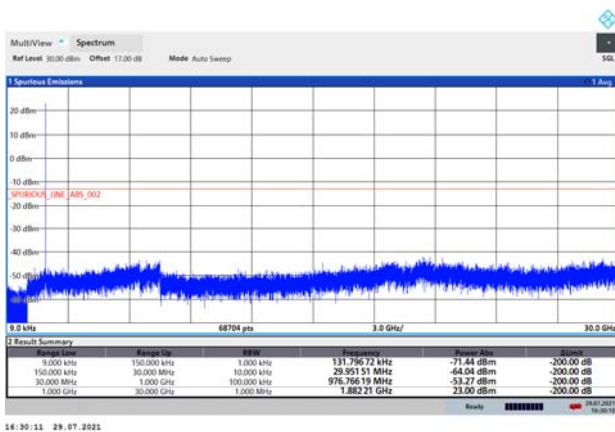

LTE Band 25 3MHz CH-Middle 9kHz~30GHz

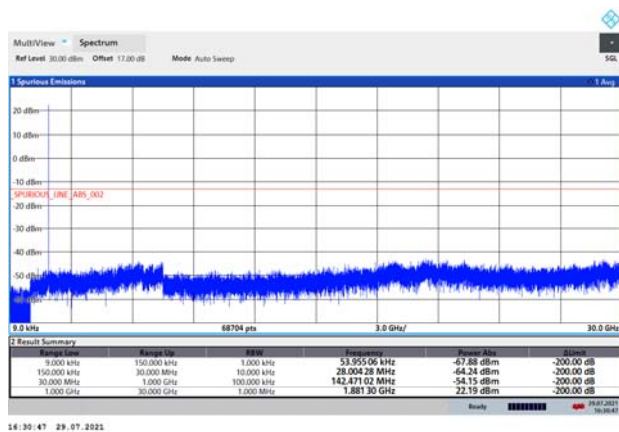

LTE Band 25 1.4MHz CH-High 9kHz~30GHz

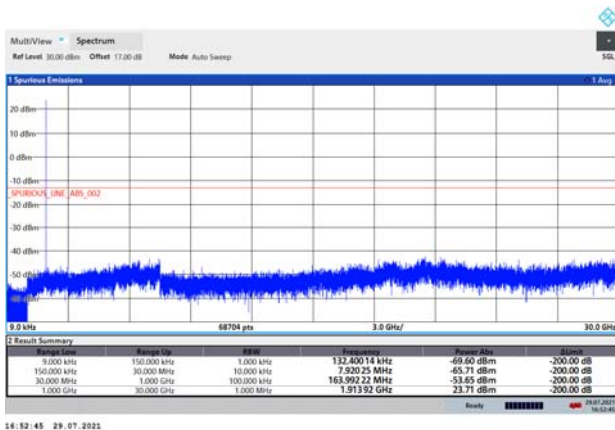

LTE Band 25 3MHz CH-High 9kHz~30GHz

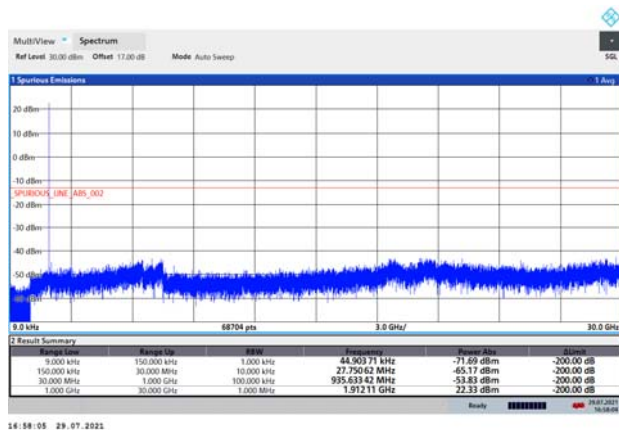



LTE Band 25 5MHz CH-Low 9kHz~30GHz

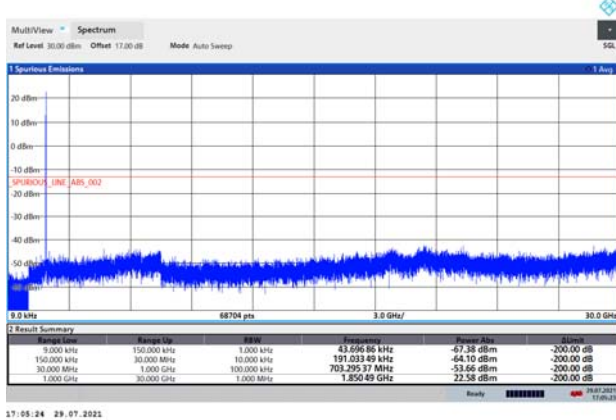

LTE Band 25 10MHz CH-Low 9kHz~30GHz

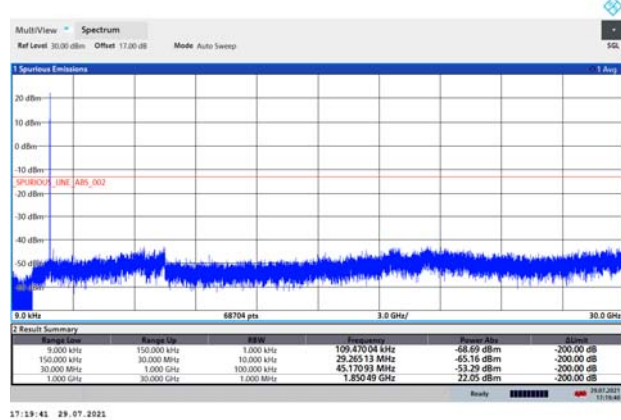

LTE Band 25 5MHz CH-Middle 9kHz~30GHz

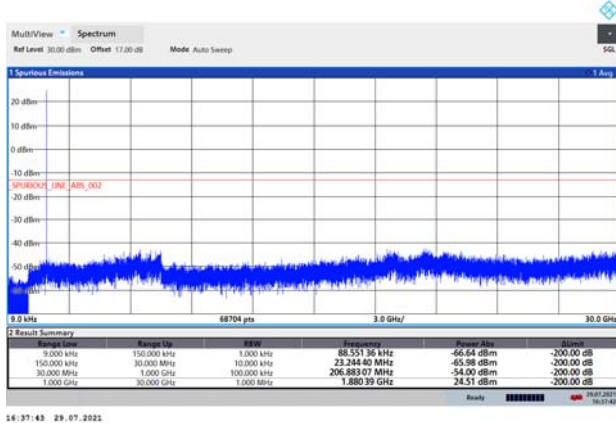

LTE Band 25 10MHz CH-Middle 9kHz~30GHz

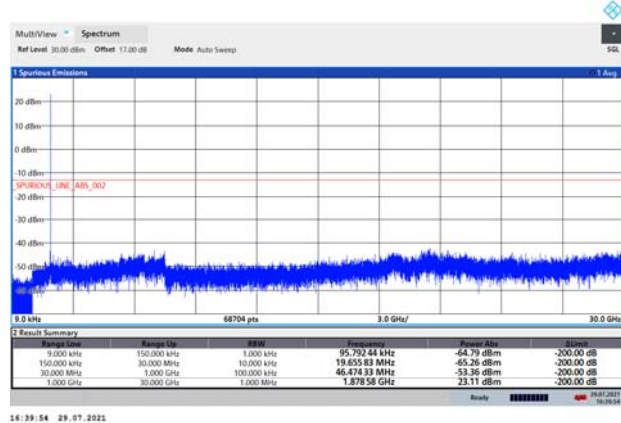

LTE Band 25 5MHz CH-High 9kHz~30GHz

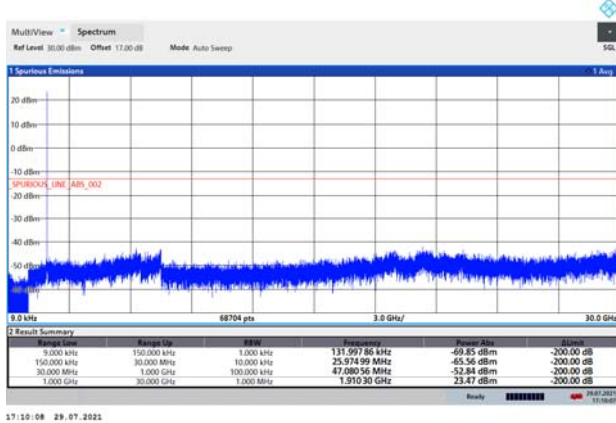

LTE Band 25 10MHz CH-High 9kHz~30GHz

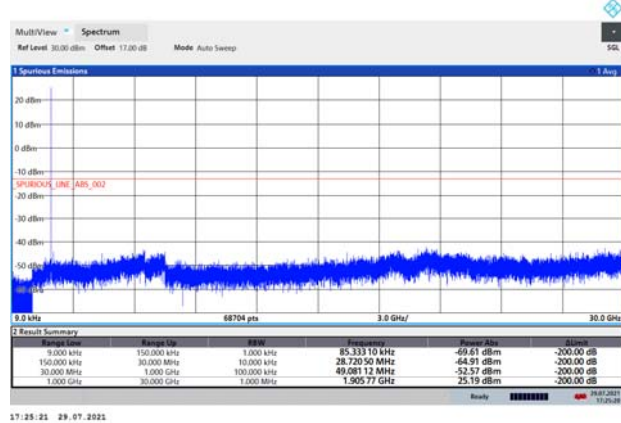



LTE Band 25 15MHz CH-Low 9kHz~30GHz

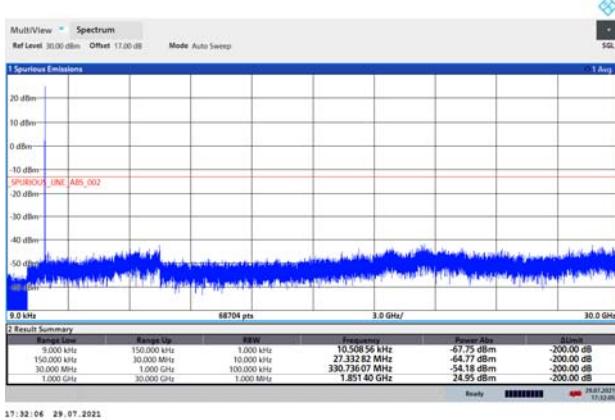

LTE Band 25 20MHz CH-Low 9kHz~30GHz

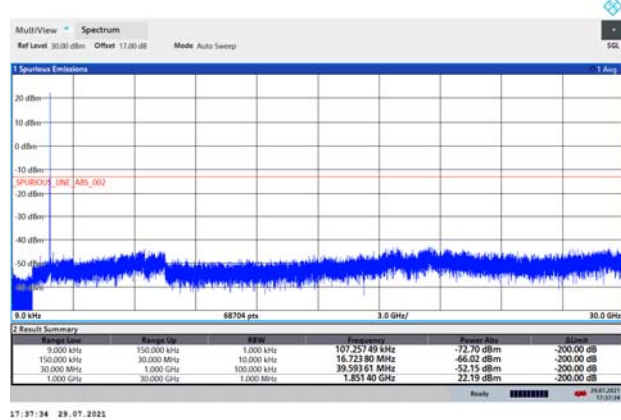

LTE Band 25 15MHz CH-Middle 9kHz~30GHz

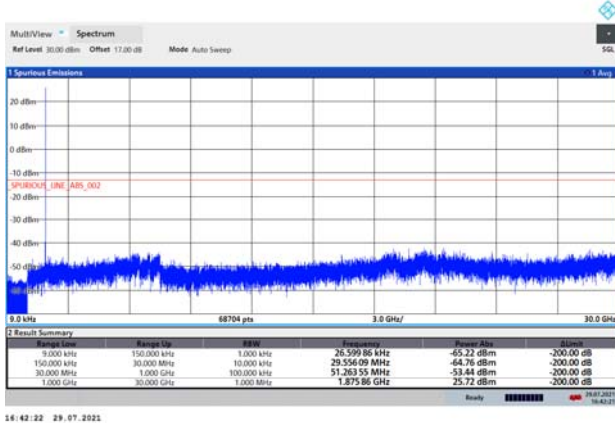

LTE Band 25 20MHz CH-Middle 9kHz~30GHz

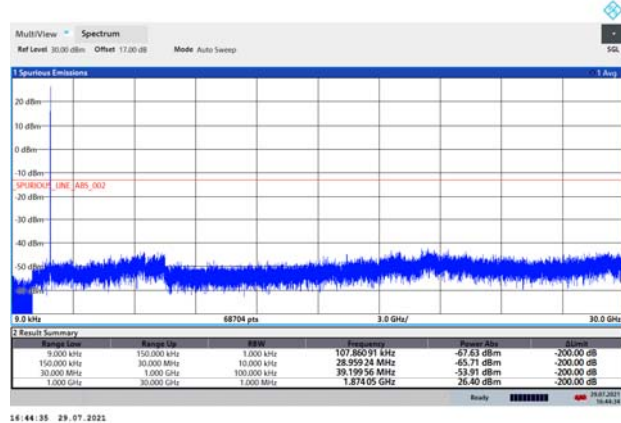

LTE Band 25 15MHz CH-High 9kHz~30GHz

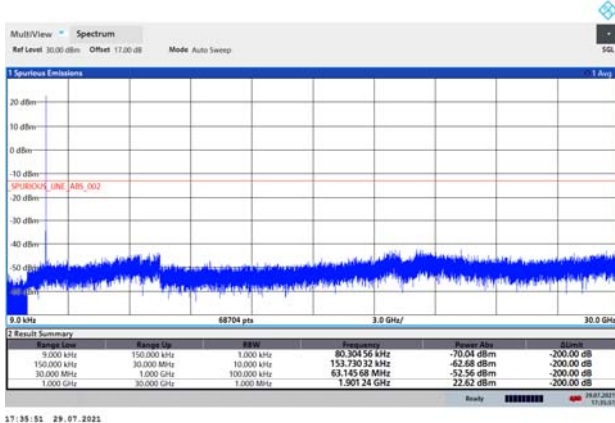

LTE Band 25 20MHz CH-High 9kHz~30GHz

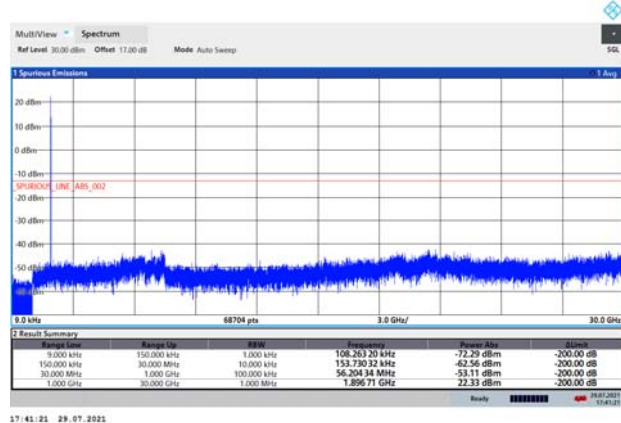

5.7. Radiates Spurious Emission

Ambient condition

Temperature	Relative humidity	Pressure
23°C ~25°C	45%~50%	101.5kPa

Method of Measurement

1. The testing follows FCC KDB 971168 v03r01 Section 5.8 and ANSI C63.26 (2015).
2. Below 1GHz: The EUT is placed on a turntable 0.8 meters above the ground in the chamber, 3 meter away from the antenna. The maximal emission value is acquired by adjusting the antenna height, polarisation and turntable azimuth. Normally, the height range of antenna is 1 m to 4 m, the azimuth range of turntable is 0° to 360°, and the receive antenna has two polarizations Vertical (V) and Horizontal (H). Above 1GHz: (Note: the FCC's permission to use 1.5m as an alternative per TCBC Conf call of Dec. 2, 2014.) The EUT is placed on a turntable 1.5 meters above the ground in the chamber, 3 meter away from the antenna. The maximal emission value is acquired by adjusting the antenna height, polarisation and turntable azimuth. Normally, the height range of antenna is 1 m to 4 m, the azimuth range of turntable is 0° to 360°, and the receive antenna has two polarizations Vertical (V) and Horizontal (H).
3. A loop antenna, A log-periodic antenna or horn antenna shall be substituted in place of the EUT. The log-periodic antenna will be driven by a signal generator and the level will be adjusted till the same power value on the spectrum analyzer or receiver. The level of the spurious emissions can be calculated through the level of the signal generator, cable loss, the gain of the substitution antenna and the reading of the spectrum analyzer or receiver.
4. The EUT is then put into continuously transmitting mode at its maximum power level during the test. Set Test Receiver or Spectrum RBW=1MHz, VBW=3MHz, and the maximum value of the receiver should be recorded as (Pr).
5. The EUT shall be replaced by a substitution antenna. In the chamber, an substitution antenna for the frequency band of interest is placed at the reference point of the chamber. An RF Signal source for the frequency band of interest is connected to the substitution antenna with a cable that has been constructed to not interfere with the radiation pattern of the antenna. A power (PMea) is applied to the input of the substitution antenna, and adjust the level of the signal generator output until the value of the receiver reach the previously recorded (Pr). The power of signal source (PMea) is recorded. The test should be performed by rotating the test item and adjusting the receiving antenna polarization.
6. A amplifier should be connected to the Signal Source output port. And the cable should be connect between the Amplifier and the Substitution Antenna. The cable loss (Pcl) ,the Substitution Antenna Gain (Ga) and the Amplifier Gain (PAg) should be recorded after test.
7. The measurement results are obtained as described below:
$$\text{Power(EIRP)} = \text{PMea} - \text{PAg} - \text{Pcl} + \text{Ga}$$

The measurement results are amend as described below:
$$\text{Power(EIRP)} = \text{PMea} - \text{Pcl} + \text{Ga}$$
8. This value is EIRP since the measurement is calibrated using an antenna of known gain (2.15 dBi) and known input power. ERP can be calculated from EIRP by subtracting the gain of the dipole, ERP

= EIRP-2.15dBi.

The modulation mode and RB allocation refer to section 5.1, using the maximum output power configuration.

Test setup

9KHz ~ 30MHz

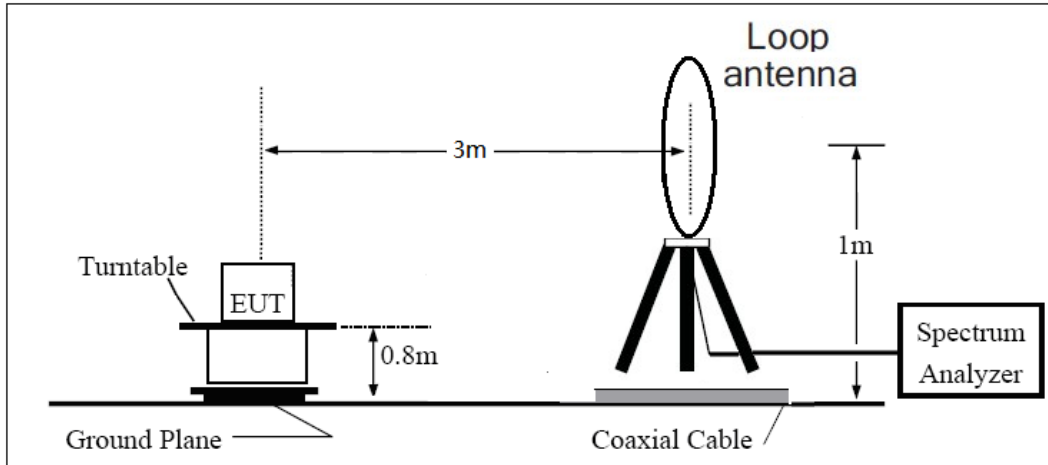

30MHz ~ 1GHz

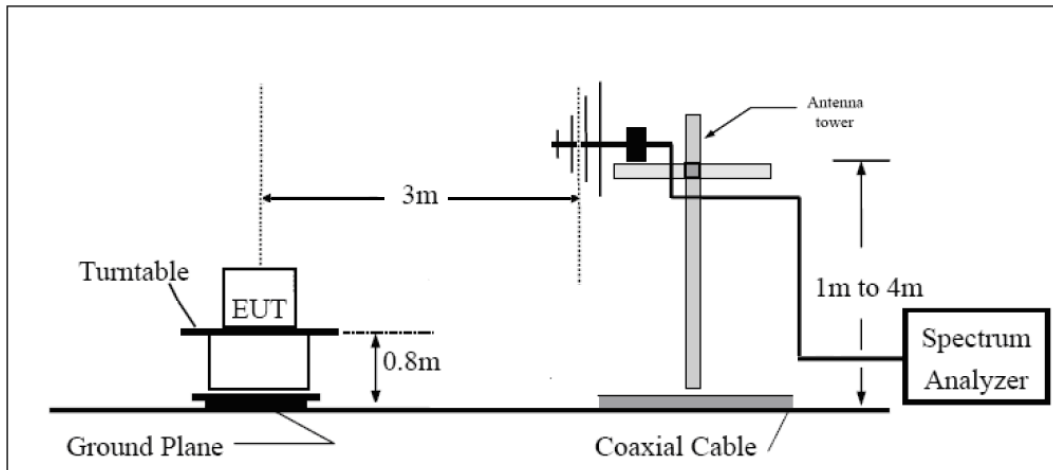

Above 1GHz

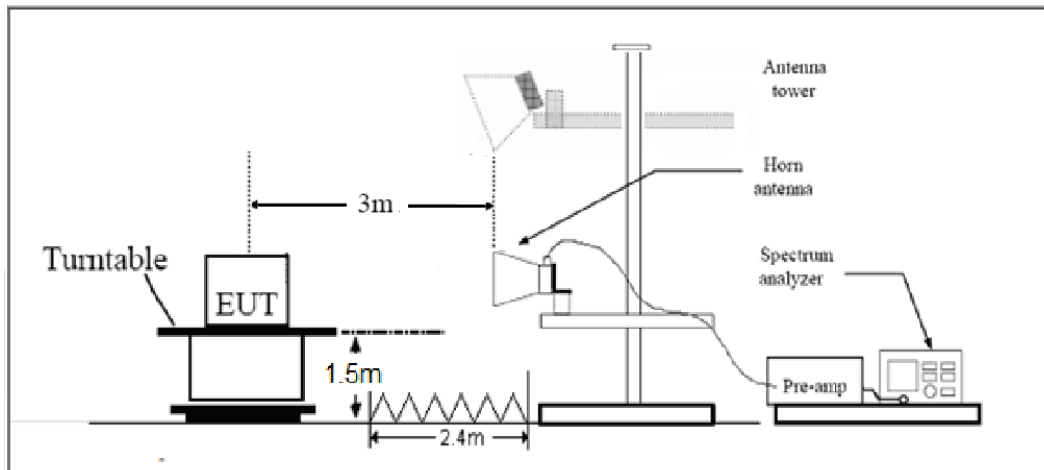

Note: Area side: 2.4mX3.6m

Limits

Rule Part 24.238(a) specifies that “on any frequency outside a licensee's frequency block, the power of any emission shall be attenuated below the transmitter power (P) by at least $43 + 10 \log_{10} (P)$ dB.”

Limit	-13 dBm
-------	---------

Measurement Uncertainty

The assessed measurement uncertainty to ensure 95% confidence level for the normal distribution is with the coverage factor $k = 1.96$, $U = 3.55$ dB.

Test Result

Sweep the whole frequency band through the range from 9kHz to the 10th harmonic of the carrier, the emissions below the noise floor will not be recorded in the report.

LTE Band 2 1.4MHz CH-Middle

Harmonic	Frequency (MHz)	SG (dBm)	Cable Loss (dB)	Gain (dBi)	Antenna Polarization	EIRP Level (dBm)	Limit (dBm)	Margin (dB)	Azimuth (deg)
2	3759.00	-60.69	2.60	12.50	Horizontal	-50.79	-13.00	37.79	45
3	5638.88	-40.95	3.30	12.50	Horizontal	-31.75	-13.00	18.75	90
4	7520.00	-50.77	4.20	12.20	Horizontal	-42.77	-13.00	29.77	135
5	9400.00	-52.14	4.30	11.10	Horizontal	-45.34	-13.00	32.34	90
6	11280.00	-47.00	5.90	11.90	Horizontal	-41.00	-13.00	28.00	180
7	13160.00	-50.46	5.70	14.00	Horizontal	-42.16	-13.00	29.16	90
8	15040.00	-46.30	5.80	13.10	Horizontal	-39.00	-13.00	26.00	45
9	16920.00	-47.72	6.10	14.60	Horizontal	-39.22	-13.00	26.22	270
10	18800.00	/	/	/	/	/	/	/	/

Note: 1.The other Spurious RF Radiated emissions level is no more than noise floor.
 2. The worst emission was found in the antenna is Horizontal position.

LTE Band 2 5MHz CH-Middle

Harmonic	Frequency (MHz)	SG (dBm)	Cable Loss (dB)	Gain (dBi)	Antenna Polarization	EIRP Level (dBm)	Limit (dBm)	Margin (dB)	Azimuth (deg)
2	3755.63	-63.03	2.60	12.50	Horizontal	-53.13	-13.00	40.13	180
3	5633.63	-43.52	3.30	12.50	Horizontal	-34.32	-13.00	21.32	45
4	7520.00	-49.23	4.20	12.20	Horizontal	-41.23	-13.00	28.23	45
5	9400.00	-52.03	4.30	11.10	Horizontal	-45.23	-13.00	32.23	90
6	11280.00	-49.85	5.90	11.90	Horizontal	-43.85	-13.00	30.85	225
7	13160.00	-50.34	5.70	14.00	Horizontal	-42.04	-13.00	29.04	180
8	15040.00	-46.56	5.80	13.10	Horizontal	-39.26	-13.00	26.26	180
9	16920.00	-48.57	6.10	14.60	Horizontal	-40.07	-13.00	27.07	180
10	18800.00	/	/	/	/	/	/	/	/

Note: 1.The other Spurious RF Radiated emissions level is no more than noise floor.
 2. The worst emission was found in the antenna is Horizontal position.

LTE Band 2 20MHz CH-Middle

Harmonic	Frequency (MHz)	SG (dBm)	Cable Loss (dB)	Gain (dBi)	Antenna Polarization	EIRP Level (dBm)	Limit (dBm)	Margin (dB)	Azimuth (deg)
2	3742.13	-61.65	2.60	12.50	Horizontal	-51.75	-13.00	38.75	270
3	5613.38	-44.47	3.30	12.50	Horizontal	-35.27	-13.00	22.27	180
4	7484.63	-48.24	4.20	12.20	Horizontal	-40.24	-13.00	27.24	0
5	9400.00	-51.62	4.30	11.10	Horizontal	-44.82	-13.00	31.82	45
6	11280.00	-50.31	5.90	11.90	Horizontal	-44.31	-13.00	31.31	90
7	13160.00	-51.20	5.70	14.00	Horizontal	-42.90	-13.00	29.90	180
8	15040.00	-48.09	5.80	13.10	Horizontal	-40.79	-13.00	27.79	180
9	16920.00	-45.98	6.10	14.60	Horizontal	-37.48	-13.00	24.48	0
10	18800.00	/	/	/	/	/	/	/	/

Note: 1.The other Spurious RF Radiated emissions level is no more than noise floor.
 2. The worst emission was found in the antenna is Horizontal position.

LTE Band 25 1.4MHz CH-Middle

Harmonic	Frequency (MHz)	SG (dBm)	Cable Loss (dB)	Gain (dBi)	Antenna Polarization	EIRP Level (dBm)	Limit (dBm)	Margin (dB)	Azimuth (deg)
2	3765.00	-56.27	2.60	12.50	Horizontal	-46.37	-13.00	33.37	90
3	5647.50	-47.48	3.30	12.50	Horizontal	-38.28	-13.00	25.28	180
4	7530.00	-52.68	4.20	12.20	Horizontal	-44.68	-13.00	31.68	0
5	9412.50	-55.50	4.30	11.10	Horizontal	-48.70	-13.00	35.70	135
6	11295.00	-49.59	5.90	11.90	Horizontal	-43.59	-13.00	30.59	180
7	13177.50	-51.62	5.70	14.00	Horizontal	-43.32	-13.00	30.32	45
8	15060.00	-48.28	5.80	13.10	Horizontal	-40.98	-13.00	27.98	0
9	16942.50	-52.02	6.10	14.60	Horizontal	-43.52	-13.00	30.52	135
10	18825.00	/	/	/	/	/	/	/	/

Note: 1.The other Spurious RF Radiated emissions level is no more than noise floor.
 2. The worst emission was found in the antenna is Horizontal position.



LTE Band 25 5MHz CH-Middle

Harmonic	Frequency (MHz)	SG (dBm)	Cable Loss (dB)	Gain (dBi)	Antenna Polarization	EIRP Level (dBm)	Limit (dBm)	Margin (dB)	Azimuth (deg)
2	3765.00	-58.07	2.60	12.50	Horizontal	-48.17	-13.00	35.17	0
3	5647.50	-47.39	3.30	12.50	Horizontal	-38.19	-13.00	25.19	45
4	7530.00	-49.88	4.20	12.20	Horizontal	-41.88	-13.00	28.88	225
5	9412.50	-53.15	4.30	11.10	Horizontal	-46.35	-13.00	33.35	45
6	11295.00	-48.35	5.90	11.90	Horizontal	-42.35	-13.00	29.35	90
7	13177.50	-52.51	5.70	14.00	Horizontal	-44.21	-13.00	31.21	45
8	15060.00	-47.36	5.80	13.10	Horizontal	-40.06	-13.00	27.06	90
9	16942.50	-49.57	6.10	14.60	Horizontal	-41.07	-13.00	28.07	180
10	18825.00	/	/	/	/	/	/	/	/

Note: 1. The other Spurious RF Radiated emissions level is no more than noise floor.

2. The worst emission was found in the antenna is Horizontal position.

LTE Band 25 20MHz CH-Middle

Harmonic	Frequency (MHz)	SG (dBm)	Cable Loss (dB)	Gain (dBi)	Antenna Polarization	EIRP Level (dBm)	Limit (dBm)	Margin (dB)	Azimuth (deg)
2	3748.13	-57.91	2.60	12.50	Horizontal	-48.01	-13.00	35.01	0
3	5622.00	-46.74	3.30	12.50	Horizontal	-37.54	-13.00	24.54	0
4	7496.00	-50.28	4.20	12.20	Horizontal	-42.28	-13.00	29.28	315
5	9370.00	-51.08	4.30	11.10	Horizontal	-44.28	-13.00	31.28	315
6	11244.00	-50.24	5.90	11.90	Horizontal	-44.24	-13.00	31.24	180
7	13118.00	-52.10	5.70	14.00	Horizontal	-43.80	-13.00	30.80	45
8	14992.00	-47.94	5.80	13.10	Horizontal	-40.64	-13.00	27.64	90
9	16866.00	-49.59	6.10	14.60	Horizontal	-41.09	-13.00	28.09	270
10	18740.00	/	/	/	/	/	/	/	/

Note: 1. The other Spurious RF Radiated emissions level is no more than noise floor.

2. The worst emission was found in the antenna is Horizontal position.

6. Main Test Instruments

Name	Manufacturer	Type	Serial Number	Calibration Date	Expiration Date
Base Station Simulator	R&S	CMU200	118133	2021-05-15	2022-05-14
Base Station Simulator	R&S	CMW500	113824	2021-05-15	2022-05-14
Climate Chamber	Weiss	VT4002	58226119450010	2021-05-15	2022-05-14
Power Splitter	Hua Xiang	SHX-GF2-2-13	10120101	/	/
Spectrum Analyzer	Key sight	N9010A	MY50210259	2021-05-15	2022-05-14
Universal Radio Communication Tester	Key sight	E5515C	MY48367192	2021-5-15	2022-5-14
Signal Analyzer	R&S	FSV3030	101411	2020-12-13	2021-12-12
Loop Antenna	SCHWARZBECK	FMZB1519	1519-047	2020-04-02	2023-04-01
TRILOG Broadband Antenna	SCHWARZBECK	VULB 9163	391	2019-12-16	2022-12-15
Horn Antenna	R&S	HF907	102723	2020-08-11	2023-08-10
Signal generator	R&S	SMB 100A	102594	2021-05-15	2022-05-14
Climatic Chamber	ESPEC	SU-242	93000506	2020-12-13	2021-12-12
MOB COMMS DC SUPPLY	Keysight	66319D	MY43004105	2021-06-09	2021-12-08
RF Cable	Agilent	SMA 15cm	0001	2021-06-09	2021-12-08
Software	R&S	EMC32	9.26.0	/	/

*****END OF REPORT *****



ANNEX A: The EUT Appearance

The EUT Appearance are submitted separately.



ANNEX B: Test Setup Photos

The Test Setup Photos are submitted separately.



ANNEX C: Product Change Description

The Product Change Description are submitted separately.