



RF TEST REPORT

Applicant Quectel Wireless Solutions Co., Ltd.
FCC ID XMR2022BG952AGL
Product LTE Cat M1 & Cat NB1 Module
Brand Quectel
Model BG952A-GL
Report No. R2206A0479-R2
Issue Date June 22, 2022

TA Technology (Shanghai) Co., Ltd. tested the above equipment in accordance with the requirements in **FCC CFR47 Part 2 (2021)/ FCC CFR 47 Part 24E (2021)**. The test results show that the equipment tested is capable of demonstrating compliance with the requirements as documented in this report.

Prepared by: Peng Tao

Approved by: Kai Xu

TA Technology (Shanghai) Co., Ltd.

No.145, Jintang Rd, Tangzhen Industry Park, Pudong Shanghai, China

TEL: +86-021-50791141/2/3

FAX: +86-021-50791141/2/3-8000



TABLE OF CONTENT

1. Test Laboratory	4
1.1. Notes of the test report	4
1.2. Test facility	4
1.3. Testing Location	4
2. General Description of Equipment under Test	5
2.1. Applicant and Manufacturer Information	5
2.2. General information	5
3. Applied Standards	7
4. Test Configuration	8
5. Test Case Results	9
5.1. RF Power Output and Effective Isotropic Radiated Power	9
5.2. Occupied Bandwidth	11
5.3. Band Edge Compliance	19
5.4. Peak-to-Average Power Ratio (PAPR)	24
5.5. Frequency Stability	26
5.6. Spurious Emissions at Antenna Terminals	31
5.7. Radiates Spurious Emission	33
6. Main Test Instruments	39
ANNEX A: The EUT Appearance	40
ANNEX B: Test Setup Photos	41
ANNEX C: Product Change Description	42

Summary of measurement results

No.	Test Case	Clause in FCC rules	Verdict
1	RF Power Output and Effective Isotropic Radiated Power	2.1046 24.232(c)	PASS
2	Occupied Bandwidth	2.1049	PASS
3	Band Edge Compliance	2.1051 /24.238(a)	PASS
4	Peak-to-Average Power Ratio	24.232/KDB 971168 D01(5.7)	PASS
5	Frequency Stability	2.1055 / 24.235	PASS
6	Spurious Emissions at Antenna Terminals	2.1051 / 24.238(a)	PASS
7	Radiates Spurious Emission	2.1053 / 24.238(a)	PASS
Date of Testing: July 21, 2021 ~ August 5, 2021			
Date of Sample Received: July 20, 2021			
Note: PASS: The EUT complies with the essential requirements in the standard. FAIL: The EUT does not comply with the essential requirements in the standard. All indications of Pass/Fail in this report are opinions expressed by TA Technology (Shanghai) Co., Ltd. based on interpretations and/or observations of test results. Measurement Uncertainties were not taken into account and are published for informational purposes only.			

BG952A-GL (Report No.: R2206A0479-R2) is a variant model of BG950A-GL (Report No.: R2107A0607-R2). Test values duplicated from Original for variant. The power of new variant are varied due to measurement uncertainty, and sample tolerance of the acceptance range. The detailed product change description please refers to following table:

Module	BG950A-GL	BG952A-GL
QuecOpen®	N/A	Supported
Hardware Version	R1.3	R1.5
Software Version	BG950AGLAAR01A01	BG952AGLAAR01A03
Product Name	LTE Module	LTE Cat M1 & Cat NB1 Module
Others	The same	

The detailed product change description please refers to the Difference Declaration Letter.



1. Test Laboratory

1.1. Notes of the test report

This report shall not be reproduced in full or partial, without the written approval of **TA technology (shanghai) co., Ltd.** The results documented in this report apply only to the tested sample, under the conditions and modes of operation as described herein. Measurement Uncertainties were not taken into account and are published for informational purposes only. This report is written to support regulatory compliance of the applicable standards stated above.

1.2. Test facility

FCC (Designation number: CN1179, Test Firm Registration Number: 446626)

TA Technology (Shanghai) Co., Ltd. has been listed on the US Federal Communications Commission list of test facilities recognized to perform measurements.

A2LA (Certificate Number: 3857.01)

TA Technology (Shanghai) Co., Ltd. has been listed by American Association for Laboratory Accreditation to perform measurement.

1.3. Testing Location

Company: TA Technology (Shanghai) Co., Ltd.
Address: No.145, Jintang Rd, Tangzhen Industry Park, Pudong
City: Shanghai
Post code: 201201
Country: P. R. China
Contact: Xu Kai
Telephone: +86-021-50791141/2/3
Fax: +86-021-50791141/2/3-8000
Website: <http://www.ta-shanghai.com>
E-mail: xukai@ta-shanghai.com

2. General Description of Equipment under Test

2.1. Applicant and Manufacturer Information

Applicant	Quectel Wireless Solutions Co., Ltd.
Applicant address	Building 5, Shanghai Business Park Phase III (Area B), No.1016 Tianlin Road, Minhang District, Shanghai, China, 200233
Manufacturer	Quectel Wireless Solutions Co., Ltd.
Manufacturer address	Building 5, Shanghai Business Park Phase III (Area B), No.1016 Tianlin Road, Minhang District, Shanghai, China, 200233

2.2. General information

EUT Description			
Model	BG952A-GL		
IMEI	869410050002659		
Hardware Version	R1.5		
Software Version	BG952AGLAAR01A03		
Power Supply	External power supply		
Antenna Type	External Antenna		
Antenna Gain	Band	Frequency (MHz)	Gain (dBi)
	NB-IoT Band 2/25	1840	1.36
		1860	1.25
		1880	1.38
		1900	1.59
1920		1.36	
Test Mode(s)	NB-IoT Band 2/25;		
Test Modulation:	BPSK, QPSK		
Category	NB1		
Deployment:	standalone, in-band, guard-band		
Sub-carrier spacing:	3.75KHz, 15KHz		
Ntones:	single-tone, multi-tone		
Maximum E.I.R.P	NB-IoT Band 2:	25.04dBm	
	NB-IoT Band 25:	24.95dBm	
Rated Power Supply Voltage	3.3V		
Operating Voltage	Minimum: 2.2V Maximum: 4.35V		
Operating Temperature	Lowest: -35°C Highest: +75°C		
Extreme Temperature	Lowest: -35°C Highest: +75°C		
Frequency Range(s)	Band	Tx (MHz)	Rx (MHz)
	NB-IoT Band 2:	1850 ~ 1910	1930 ~ 1990
	NB-IoT Band 25:	1850 ~ 1915	1930 ~ 1995



Note: 1. The EUT is sent from the applicant to TA and the information of the EUT is declared by the applicant.

3. Applied Standards

According to the specifications of the manufacturer, it must comply with the requirements of the following standards:

Test standards:

FCC CFR 47 Part 24E (2021)

ANSI C63.26-2015

Reference standard:

FCC CFR47 Part 2 (2021)

KDB 971168 D01 Power Meas License Digital Systems v03r01

4. Test Configuration

Radiated measurements are performed by rotating the EUT in three different orthogonal test planes. EUT stand-up position (Z axis), lie-down position (X, Y axis). Receiver antenna polarization (horizontal and vertical), the worst emission was found in position (Z axis, vertical polarization) and the worst case was recorded.

All modes as Subcarrier Spacing, modulations, Channel were investigated.

Subsequently, only the worst case emissions are reported.

The following testing in NB-IoT is set based on the maximum RF Output Power.

The following testing in different mode is set to detail in the following table:

Test modes are chosen to be reported as the worst case configuration below for NB-IoT Band 2/25

Test items	Mode	Deployment mode	Subcarrier Spacing (kHz)		Modulation		Test Channel		
		Stand-alone	3.75	15	BPSK	QPSK	L	M	H
RF Power Output and Effective Isotropic Radiated Power	NB-IoT B2	O	O	O	O	O	O	O	O
	NB-IoT B25	O	O	O	O	O	O	O	O
Occupied Bandwidth	NB-IoT B2	O	O	O	O	O	O	O	O
	NB-IoT B25	O	O	O	O	O	O	O	O
Band Edge Compliance	NB-IoT B2	O	O	O	O	O	O	-	O
	NB-IoT B25	O	O	O	O	O	O	-	O
Peak-to-Average Power Ratio	NB-IoT B2	O	O	O	O	O	-	O	-
	NB-IoT B25	O	O	O	O	O	-	O	-
Frequency Stability	NB-IoT B2	O	O	O	O	O	O	O	O
	NB-IoT B25	O	O	O	O	O	O	O	O
Spurious Emissions at Antenna Terminals	NB-IoT B2	O	-	O	-	O	O	O	O
	NB-IoT B25	O	-	O	-	O	O	O	O
Radiates Spurious Emission	NB-IoT B2	O	-	O	-	O	-	O	-
	NB-IoT B25	O	-	O	-	O	-	O	-
<p>Note</p> <p>1. The mark "O" means that this configuration is chosen for testing.</p> <p>2. The mark "-" means that this configuration is not testing.</p>									

5. Test Case Results

5.1.RF Power Output and Effective Isotropic Radiated Power

Ambient condition

Temperature	Relative humidity	Pressure
23°C ~25°C	45%~50%	101.5kPa

Methods of Measurement

During the process of the testing, The EUT was connected to the Base Station Simulator with a known loss. The EUT is controlled by the Base Station Simulator test set to ensure max power transmission with proper modulation.

ERP can then be calculated as follows:

$$\text{EIRP (dBm)} = \text{Output Power (dBm)} - \text{Losses (dB)} + \text{Antenna Gain (dBi)}$$

where:dBd refers to gain relative to an ideal dipole.

$$\text{EIRP (dBm)} = \text{ERP (dBm)} + 2.15 \text{ (dB.)}$$

Test Setup

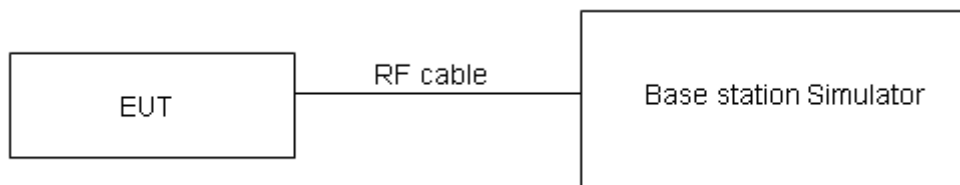

Limits

No specific RF power output requirements in part 2.1046.

Rule Part 24.232(c) Mobile and portable stations are limited to 2 watts EIRP.

Rule Part 24.232(e) Peak transmit power must be measured over any interval of continuous transmission using instrumentation calibrated in terms of an rms-equivalent voltage.

Limit	$\leq 2 \text{ W}$ (33 dBm)
-------	-----------------------------

Measurement Uncertainty

The assessed measurement uncertainty to ensure 95% confidence level for the normal distribution is with the coverage factor $k = 2$, $U = 0.4 \text{ dB}$ for RF power output, $k = 2$, $U = 1.19 \text{ dB}$ for EIRP.

Test Results

Mode	Modulation	Sub-carrier spacing (KHz)	Ntones	Maximum Output Power (dBm) for low/middle/high channel			EIRP (dBm)		
				18602 /1850.2MHz	18900 /1880.0MHz	19198 /1909.8MHz	18602 /1850.2MHz	18900 /1880.0MHz	19198 /1909.8MHz
NB-IoT Band 2	BPSK	3.75	1@0	23.28	23.19	23.10	24.53	24.57	24.69
			1@47	23.26	23.25	23.08	24.51	24.63	24.67
		15	1@0	23.43	23.47	23.45	24.68	24.85	25.04
			1@11	23.45	23.38	23.35	24.70	24.76	24.94
	QPSK	3.75	1@0	23.27	23.20	23.11	24.52	24.58	24.70
			1@47	23.26	23.24	23.14	24.51	24.62	24.73
		15	1@0	23.57	23.38	23.42	24.82	24.76	25.01
			1@11	23.42	23.47	23.41	24.67	24.85	25.00
		15	12@0	21.09	21.03	21.02	22.34	22.41	22.61

Mode	Modulation	Sub-carrier spacing (KHz)	Ntones	Maximum Output Power (dBm) for low/middle/high channel			EIRP (dBm)		
				26042 /1850.2MHz	26365 /1882.5MHz	26688 /1914.8MHz	26042 /1850.2MHz	26365 /1882.5MHz	26688 /1914.8MHz
NB-IoT Band 25	BPSK	3.75	1@0	23.31	23.18	23.13	24.56	24.56	24.49
			1@47	23.30	23.16	23.11	24.55	24.54	24.47
		15	1@0	23.66	23.51	23.55	24.91	24.89	24.91
			1@11	23.61	23.46	23.47	24.86	24.84	24.83
	QPSK	3.75	1@0	23.31	21.20	23.12	24.56	22.58	24.48
			1@47	23.27	23.20	23.11	24.52	24.58	24.47
		15	1@0	23.59	23.42	23.54	24.84	24.80	24.90
			1@11	23.54	23.48	23.59	24.79	24.86	24.95
		15	12@0	21.13	21.12	21.09	22.38	22.50	22.45

5.2.Occupied Bandwidth

Ambient condition

Temperature	Relative humidity	Pressure
23°C ~25°C	45%~50%	101.5kPa

Method of Measurement

The EUT was connected to Spectrum Analyzer and Base Station Simulator via power Splitter. The occupied bandwidth is measured using spectrum analyzer.

RBW is set to 2kHz, VBW is set to 6.2kHz for NB-IoT Band 2/25.

99% power and -26dBc occupied bandwidths are recorded. Spectrum analyzer plots are included on the following pages.

Test Setup

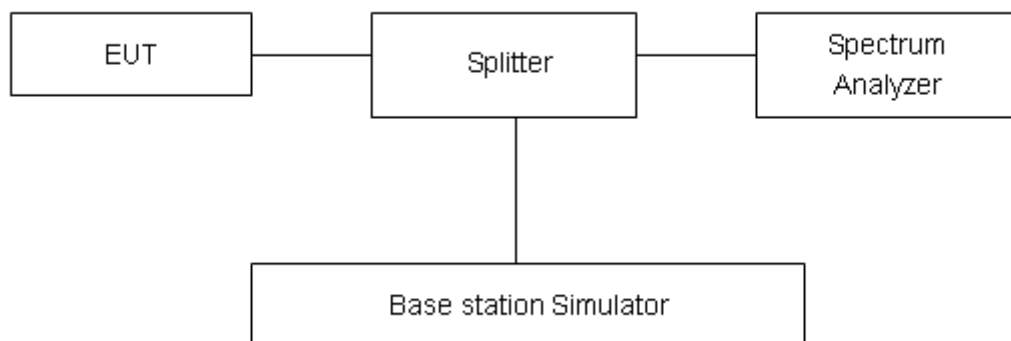

Limits

No specific occupied bandwidth requirements in part 2.1049.

Measurement Uncertainty

The assessed measurement uncertainty to ensure 95% confidence level for the normal distribution is with the coverage factor $k = 2$, $U = 624\text{Hz}$.

Test Result

Mode	Modulation	Sub-carrier spacing (KHz)	Ntones	Bandwidth(KHz) for low/mid/high channel					
				18602/1850.2 MHz		18900/1880.0 MHz		19198/1909.8 MHz	
				99% Power	-26dBc	99% Power	-26dBc	99% Power	-26dBc
Band 2 Standalone	BPSK	3.75	1@0	39.39	37.62	39.33	37.85	39.18	38.29
	QPSK	3.75	1@0	42.92	42.19	43.52	42.00	44.98	42.39
	BPSK	15	1@0	71.72	89.26	72.13	87.57	73.33	89.84
	QPSK	15	1@0	73.50	101.10	73.25	91.35	74.31	101.50
	QPSK	15	12@0	187.16	249.90	185.08	262.80	192.29	280.30
Mode	Modulation	Sub-carrier spacing (KHz)	Ntones	Bandwidth(KHz) for low/mid/high channel					
				26042/1850.2 MHz		26365/1882.5 MHz		26688/1914.8 MHz	
				99% Power	-26dBc	99% Power	-26dBc	99% Power	-26dBc
Band 25 Standalone	BPSK	3.75	1@0	39.79	37.89	39.61	38.28	39.03	37.72
	QPSK	3.75	1@0	42.82	41.78	42.64	38.93	41.59	40.53
	BPSK	15	1@0	72.57	88.89	75.86	90.03	72.38	95.99
	QPSK	15	1@0	74.59	101.50	82.09	116.50	78.51	90.39
	QPSK	15	12@0	187.00	263.80	185.11	265.30	187.35	267.70

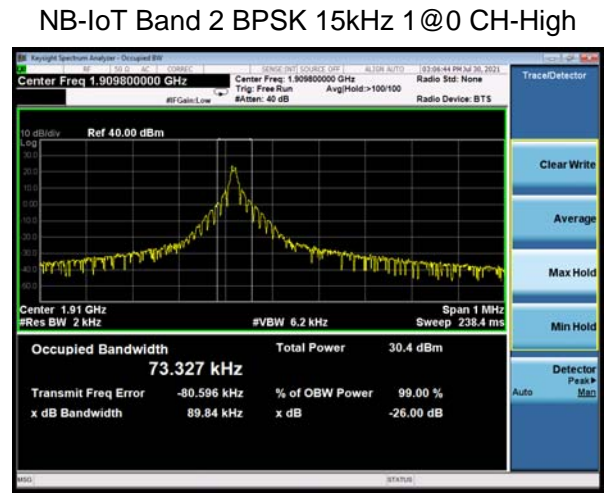
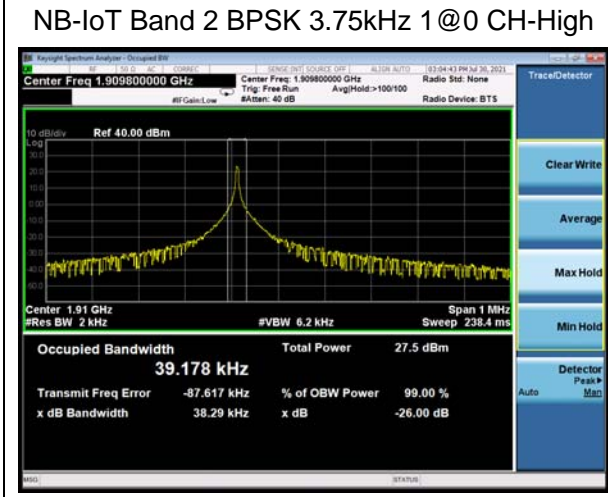
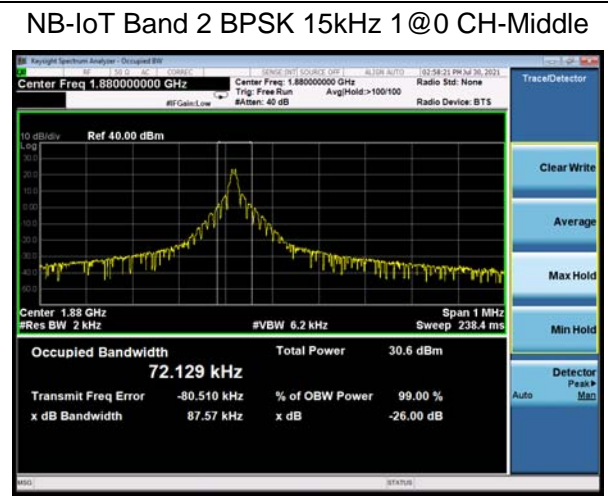
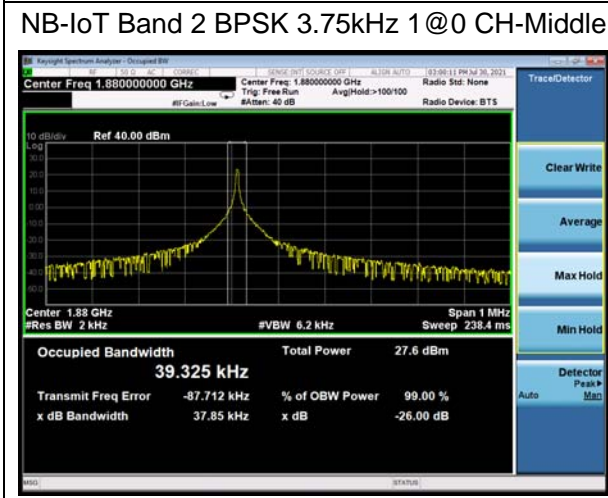
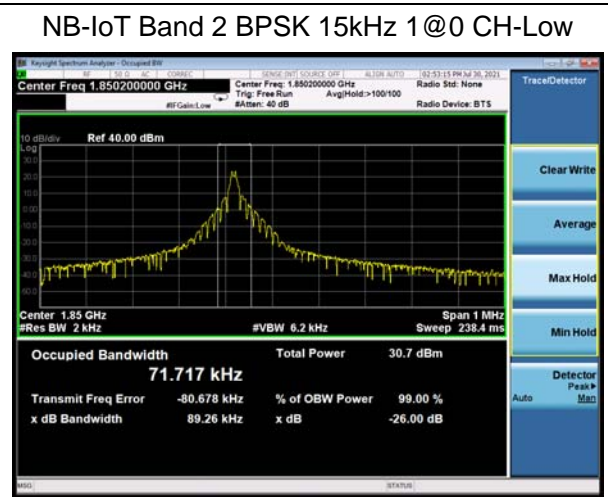
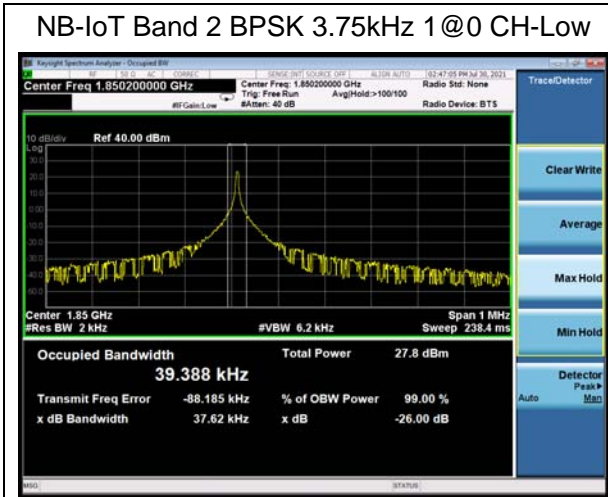

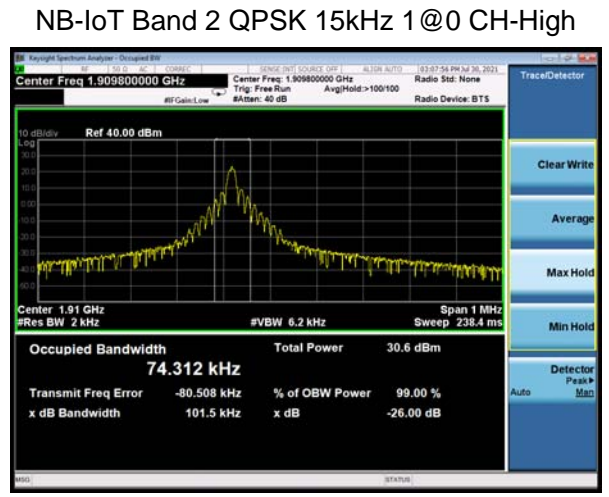
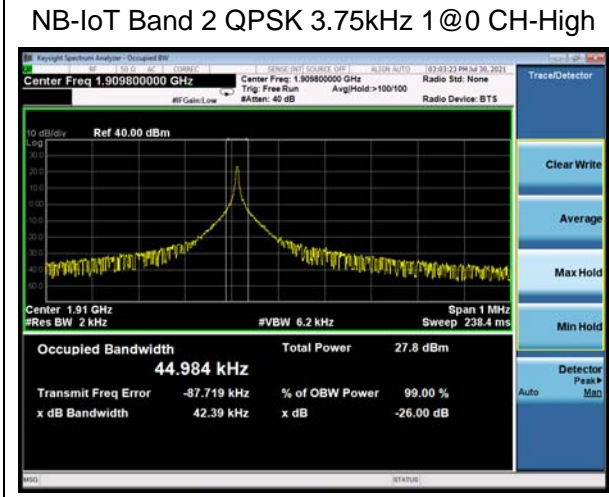
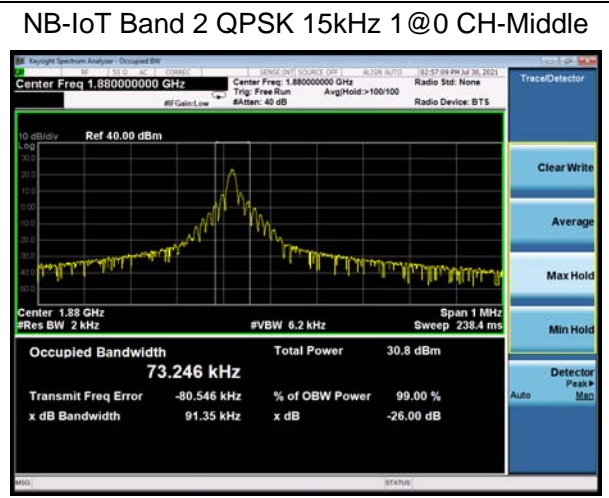
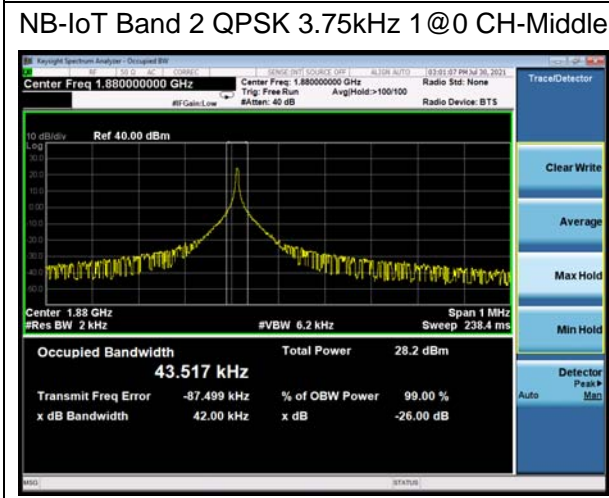
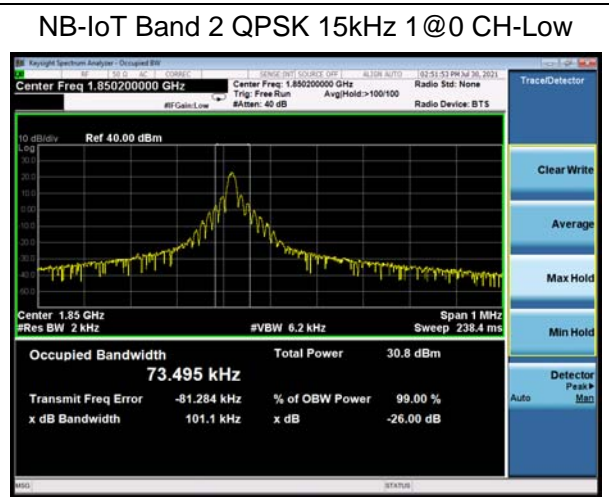
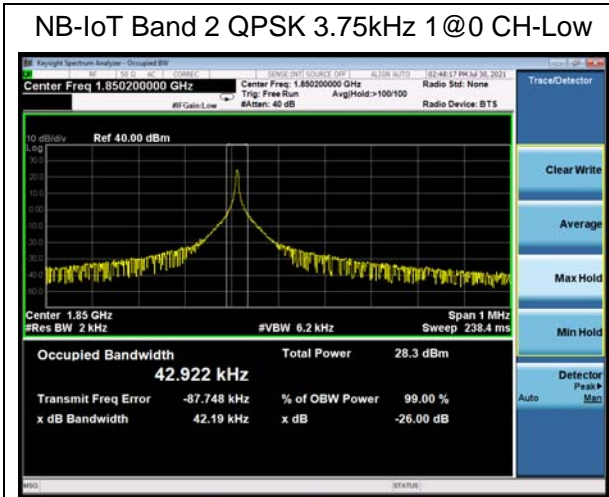

NB-IoT Band 2 QPSK 15kHz 12@0 CH-Low



NB-IoT Band 2 QPSK 15kHz 12@0 CH-Middle



NB-IoT Band 2 QPSK 15kHz 12@0 CH-High



NB-IoT Band 25 BPSK 3.75kHz 1@0 CH-Low

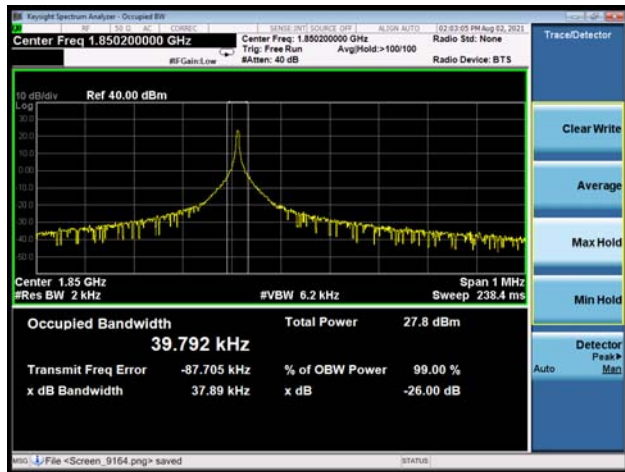

NB-IoT Band 25 BPSK 15kHz 1@0 CH-Low



NB-IoT Band 25 BPSK 3.75kHz 1@0 CH-Middle



NB-IoT Band 25 BPSK 15kHz 1@0 CH-Middle

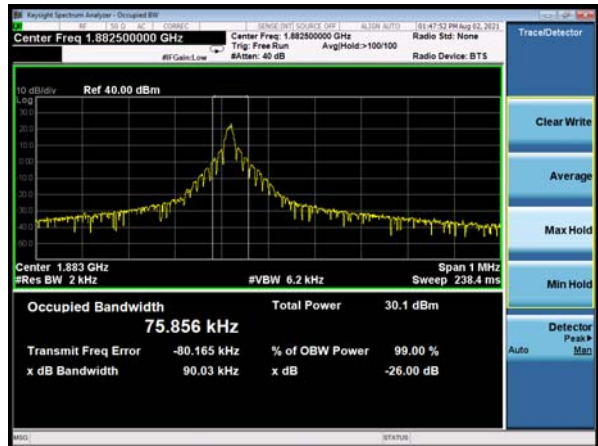

NB-IoT Band 25 BPSK 3.75kHz 1@0 CH-High



NB-IoT Band 25 BPSK 15kHz 1@0 CH-High



NB-IoT Band 25 QPSK 3.75kHz 1@0 CH-Low

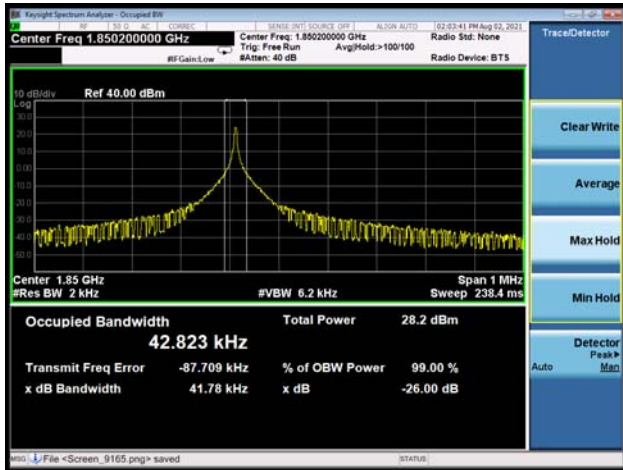

NB-IoT Band 25 QPSK 15kHz 1@0 CH-Low



NB-IoT Band 25 QPSK 3.75kHz 1@0 CH-Middle



NB-IoT Band 25 QPSK 15kHz 1@0 CH-Middle



NB-IoT Band 25 QPSK 3.75kHz 1@0 CH-High



NB-IoT Band 25 QPSK 15kHz 1@0 CH-High



NB-IoT Band 25 QPSK 15kHz 12@0 CH-Low



NB-IoT Band 25 QPSK 15kHz 12@0 CH-Middle

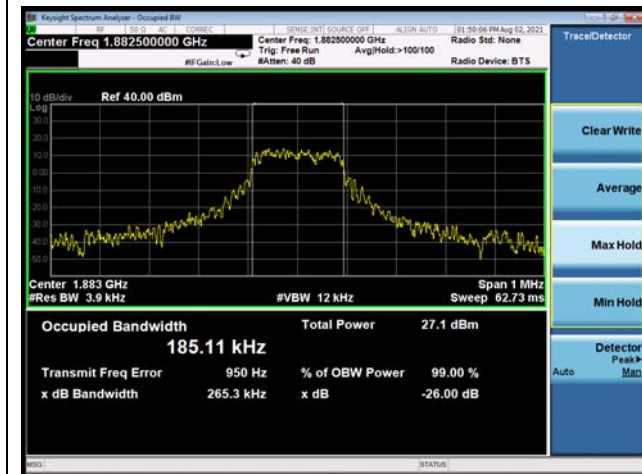

NB-IoT Band 25 QPSK 15kHz 12@0 CH-High

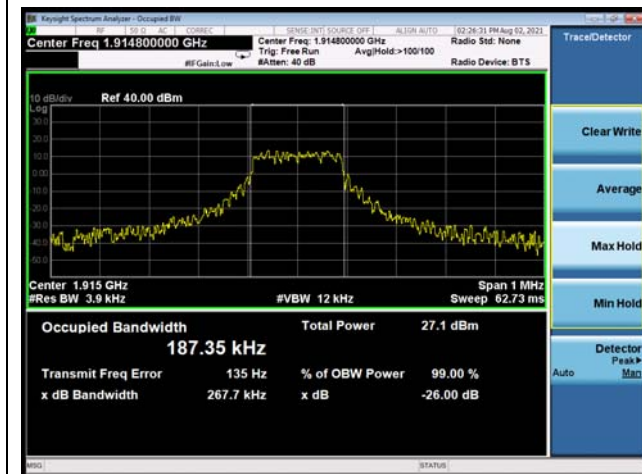

5.3. Band Edge Compliance

Ambient condition

Temperature	Relative humidity	Pressure
23°C ~25°C	45%~50%	101.5kPa

Method of Measurement

The EUT was connected to Spectrum Analyzer and Base Station Simulator via power Splitter. The band edge of the lowest and highest channels were measured. The Average detector is used and RBW is set to $\geq 1\%EBW$, VBW is set to 3x RBW.

Spectrum analyzer plots are included on the following pages.

Test Setup

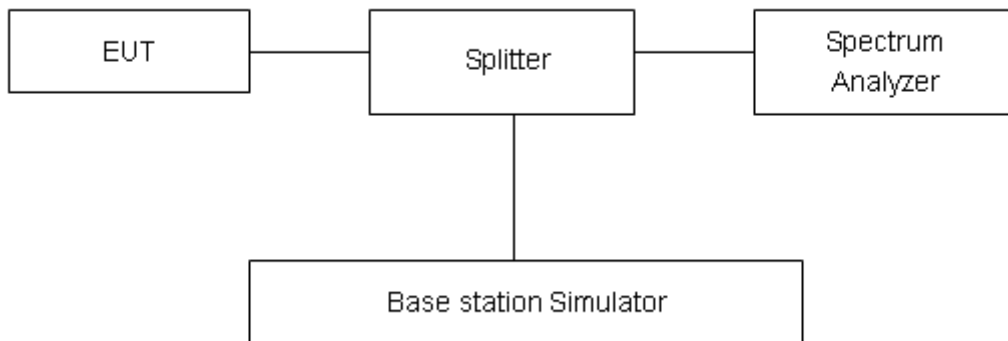

Limits

Rule Part 24.238(a) specifies that “on any frequency outside a licensee's frequency block, the power of any emission shall be attenuated below the transmitter power (P) by at least $43 + 10 \log_{10} (P)$ dB.”

Limit	-13 dBm
-------	---------

Measurement Uncertainty

The assessed measurement uncertainty to ensure 95% confidence level for the normal distribution is with the coverage factor $k = 1.96$, $U=0.684dB$.

Test Result:

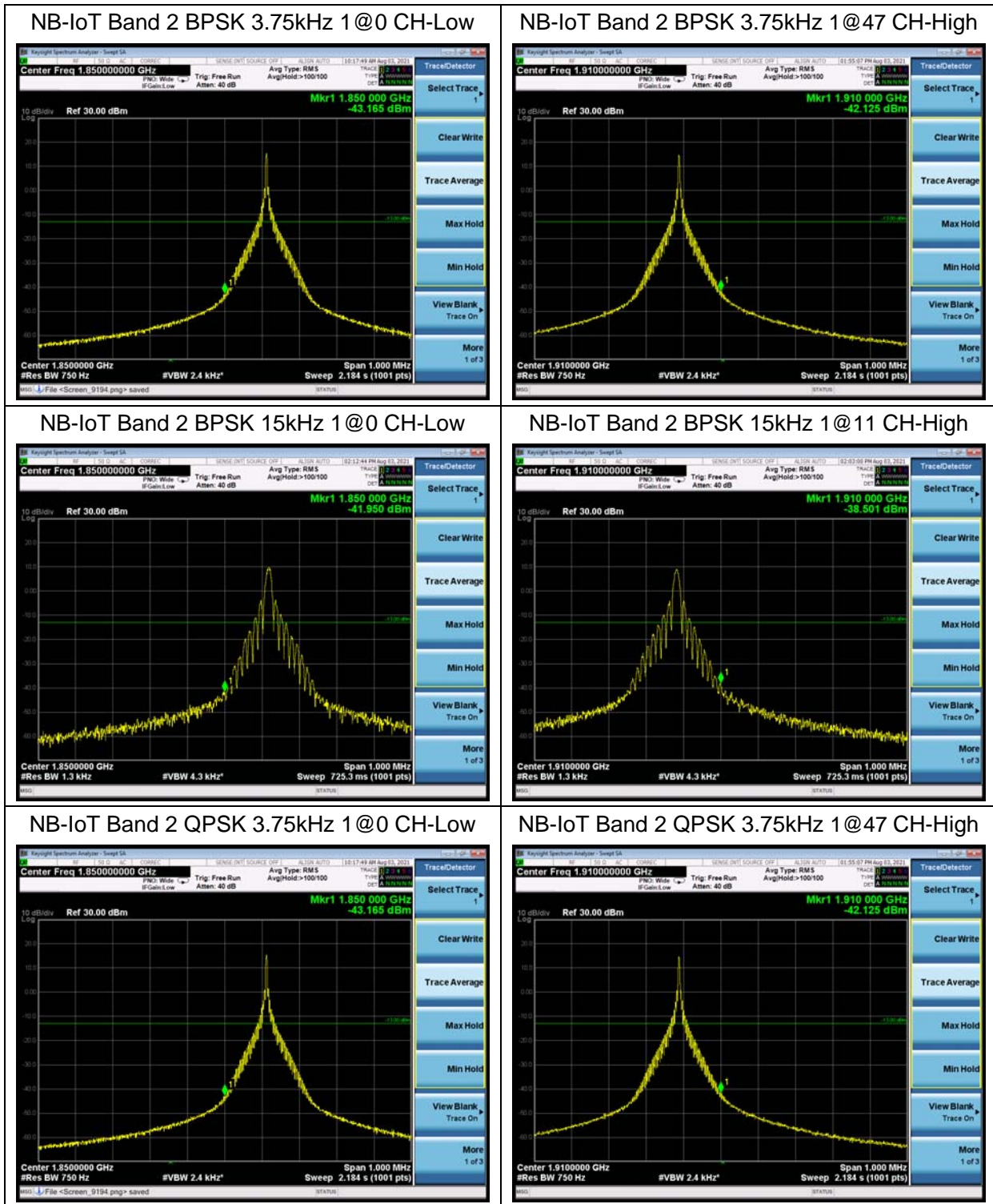

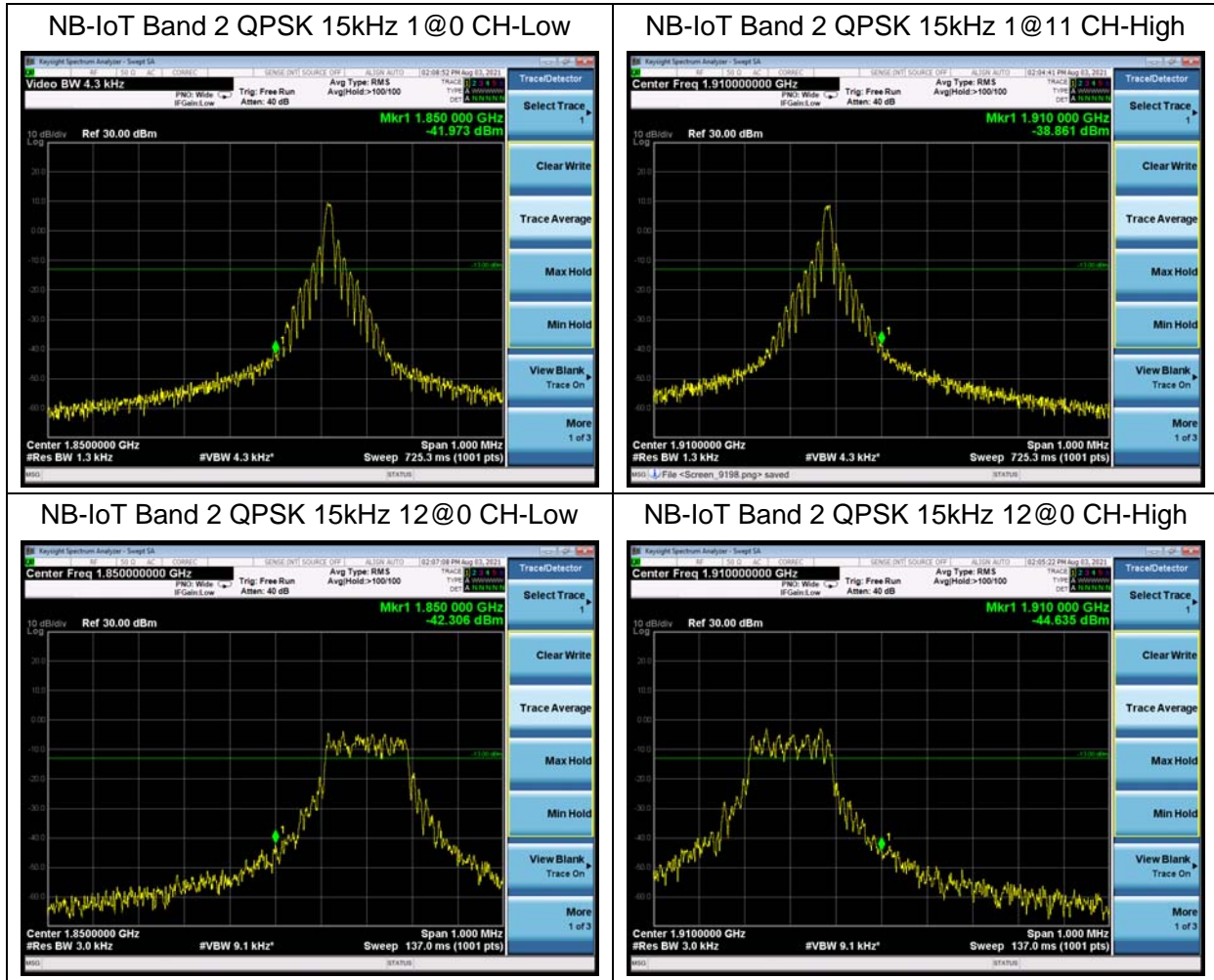

NB-IoT Band 25 BPSK 3.75kHz 1@0 CH-Low

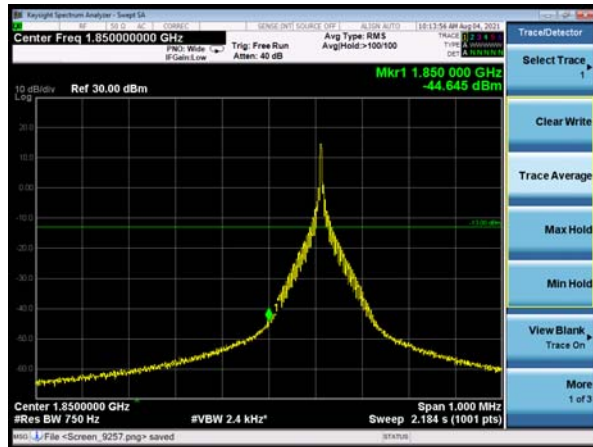

NB-IoT Band 25 BPSK 3.75kHz 1@47 CH-High

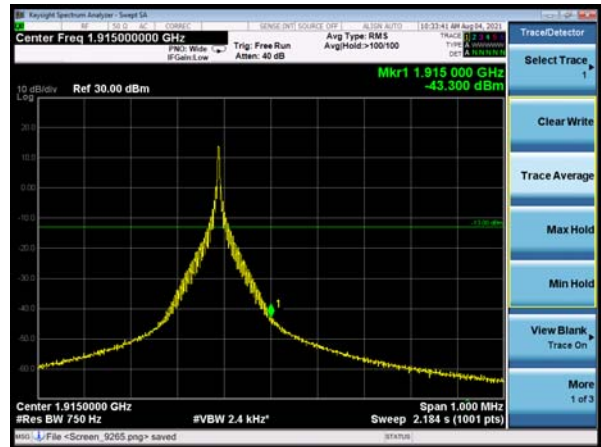

NB-IoT Band 25 BPSK 15kHz 1@0 CH-Low

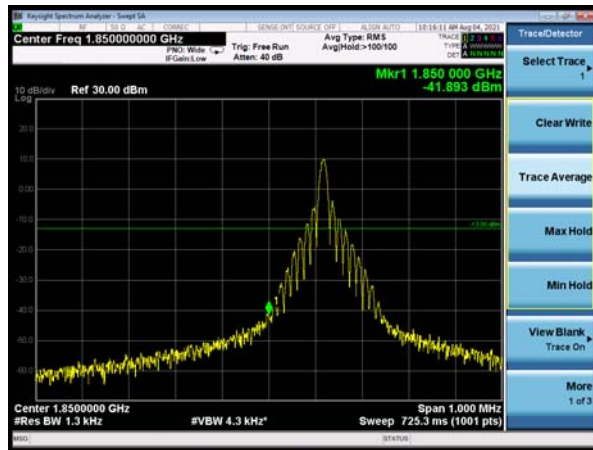

NB-IoT Band 25 BPSK 15kHz 1@11 CH-High

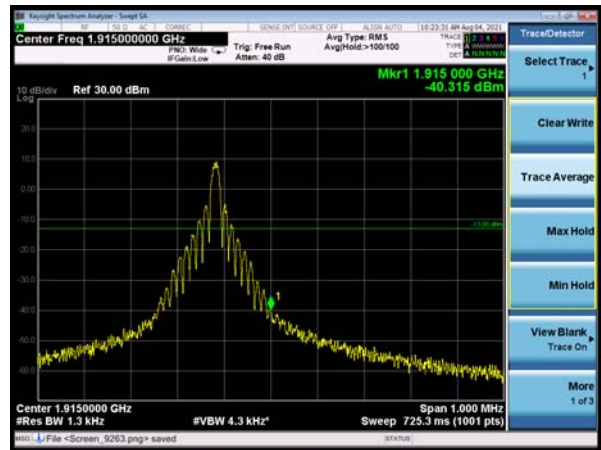

NB-IoT Band 25 QPSK 3.75kHz 1@0 CH-Low

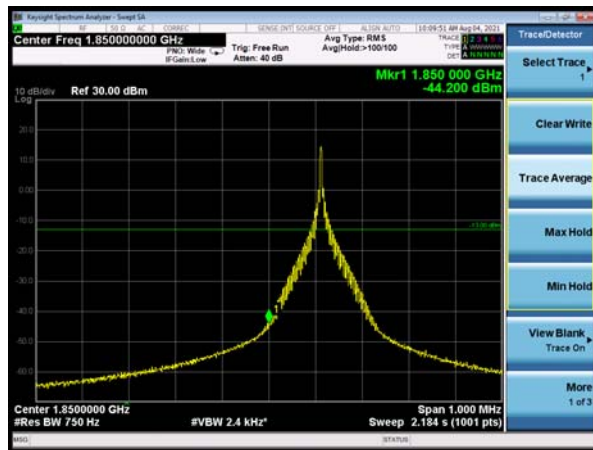

NB-IoT Band 25 QPSK 3.75kHz 1@47 CH-High

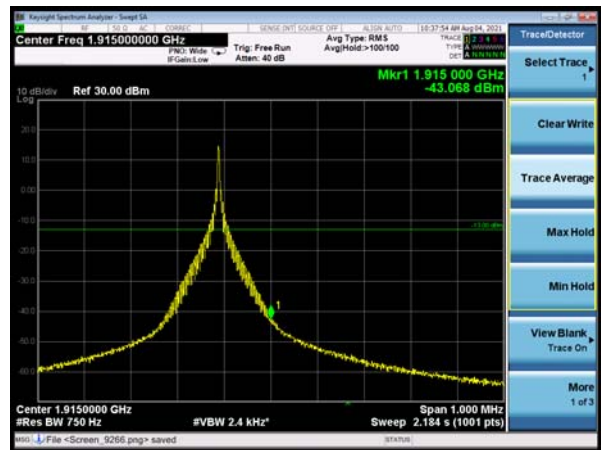

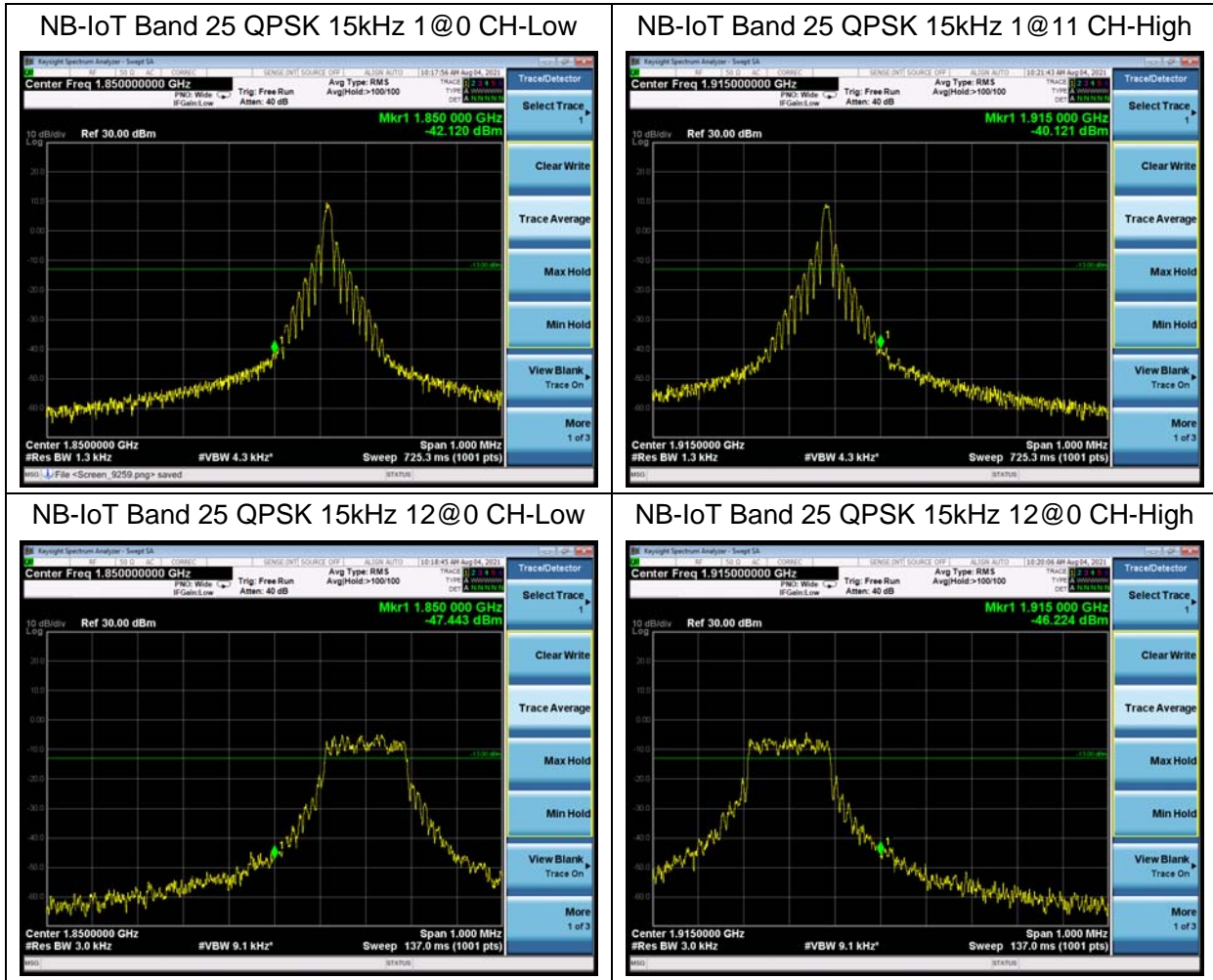

5.4. Peak-to-Average Power Ratio (PAPR)

Ambient condition

Temperature	Relative humidity	Pressure
23°C ~25°C	45%~50%	101.5kPa

Methods of Measurement

Measure the total peak power and record as PPk. And measure the total average power and record as PAvg. Both the peak and average power levels must be expressed in the same logarithmic units (e.g., dBm). Determine the PAPR from:

$$PAPR (dB) = PPk (dBm) - PAvg (dBm).$$

Test Setup

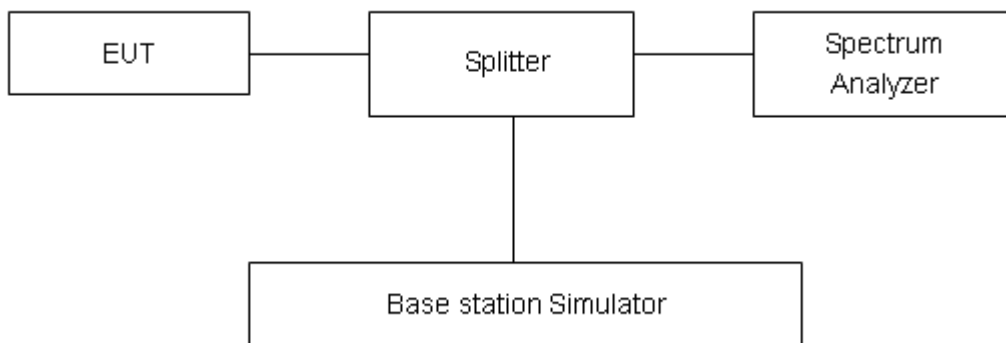

Limits

In measuring transmissions in this band using an average power technique, the peak-to-average ratio (PAR) of the transmission may not exceed 13 dB in 24.232(d).

Measurement Uncertainty

The assessed measurement uncertainty to ensure 95% confidence level for the normal distribution is with the coverage factor $k = 2$, $U = 0.4$ dB.

**Test Results**

Mode	Modulation	Sub-carrier spacing (KHz)	Channel/ Frequency(MHz)	Peak-to-Average Power Ratio (PAPR)		
				Peak(dBm)	Avg(dBm)	PAPR(dB)
Band 2 Standalone	BPSK	3.75	18900/1880.0	24.50	21.74	2.76
	QPSK	3.75	18900/1880.0	24.67	21.79	2.88
	BPSK	15	18900/1880.0	25.14	19.26	5.88
	QPSK	15	18900/1880.0	25.16	19.02	6.14
Mode	Modulation	Sub-carrier spacing (KHz)	Channel/ Frequency(MHz)	Peak-to-Average Power Ratio (PAPR)		
				Peak(dBm)	Avg(dBm)	PAPR(dB)
Band 25 Standalone	BPSK	3.75	26365/1882.5	24.62	21.83	2.79
	QPSK	3.75	26365/1882.5	24.76	21.86	2.90
	BPSK	15	26365/1882.5	25.06	18.92	6.14
	QPSK	15	26365/1882.5	24.99	18.95	6.04

5.5. Frequency Stability

Ambient condition

Temperature	Relative humidity	Pressure
23°C ~25°C	45%~50%	101.5kPa

Method of Measurement

Frequency Stability (Temperature Variation)

The temperature inside the climate chamber is varied from -35°C to +75°C in 10°C step size,

(1) With all power removed, the temperature was decreased to 0°C and permitted to stabilize for three hours.

(2) Measure the carrier frequency with the test equipment in a “call mode”. These measurements should be made within 1 minute of powering up the mobile station, to prevent significant self warming.

(3) Repeat the above measurements at 10°C increments from -35°C to +75°C. Allow at least 1.5 hours at each temperature, un-powered, before making measurements.

Frequency Stability (Voltage Variation)

The frequency stability shall be measured with variation of primary supply voltage as follows:

Primary Supply Voltage: The primary supply voltage is varied from 85% to 115% of the nominal value for non hand-carried battery and AC powered equipment. For hand-carried, battery-powered equipment, primary supply voltage is reduced to the battery operating end point which shall be specified by the manufacturer.

This transceiver is specified to operate with an input voltage of between 2.2V and 4.35 V, with a nominal voltage of 3.3V.

Test setup

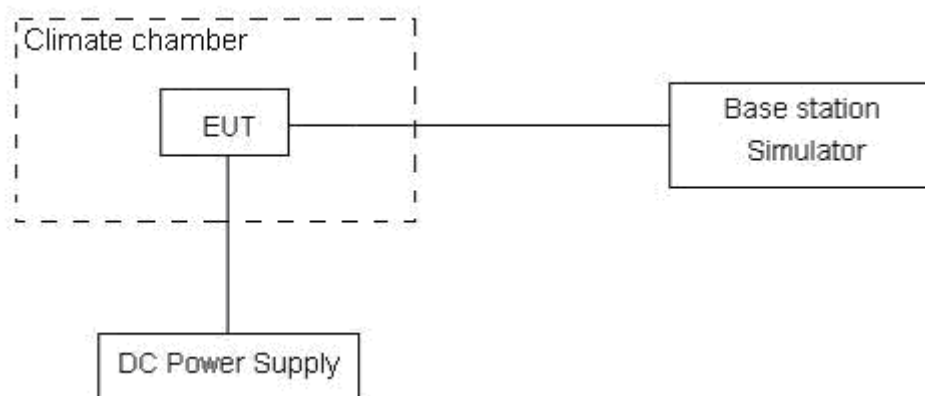

Limits

The frequency stability shall be sufficient to ensure that the fundamental emission stays within the authorized frequency block



Measurement Uncertainty

The assessed measurement uncertainty to ensure 99.75% confidence level for the normal distribution is with the coverage factor $k = 3$, $U = 0.01\text{ppm}$.



Test Result

NB-IoT Band 2						
Condition		Freq.Error (Hz)	Freq.Error (Hz)	Frequency Stability(ppm)	Frequency Stability(ppm)	Verdict
Sub-carrier spacing (KHz)	3.75					
Temperature	Voltage	BPSK	QPSK	BPSK	QPSK	
Normal (25°C)	Normal	4.22	6.77	0.00224	0.00360	PASS
Extreme (75°C)		8.19	10.52	0.00436	0.00560	PASS
Extreme (70°C)		15.70	2.67	0.00835	0.00142	PASS
Extreme (60°C)		1.45	13.59	0.00077	0.00723	PASS
Extreme (50°C)		16.45	8.36	0.00875	0.00444	PASS
Extreme (40°C)		5.61	17.68	0.00298	0.00940	PASS
Extreme (30°C)		15.19	4.75	0.00808	0.00253	PASS
Extreme (20°C)		9.21	9.81	0.00490	0.00522	PASS
Extreme (10°C)		9.50	12.61	0.00506	0.00671	PASS
Extreme (0°C)		9.71	9.73	0.00517	0.00517	PASS
Extreme (-10°C)		6.96	16.80	0.00370	0.00894	PASS
Extreme (-20°C)		12.77	15.00	0.00679	0.00798	PASS
Extreme (-30°C)		12.21	3.08	0.00649	0.00164	PASS
Extreme (-35°C)		5.80	6.47	0.00309	0.00344	PASS
25°C	LV	16.80	6.54	0.00893	0.00348	PASS
	HV	10.29	11.10	0.00548	0.00590	PASS
Condition		Freq.Error (Hz)	Freq.Error (Hz)	Frequency Stability(ppm)	Frequency Stability(ppm)	Verdict
Sub-carrier spacing (KHz)	15					
Temperature	Voltage	BPSK	QPSK	BPSK	QPSK	
Normal (25°C)	Normal	2.44	15.74	0.00130	0.00837	PASS
Extreme (75°C)		15.00	10.21	0.00798	0.00543	PASS
Extreme (70°C)		11.86	15.50	0.00631	0.00824	PASS
Extreme (60°C)		16.29	3.98	0.00867	0.00212	PASS
Extreme (50°C)		1.03	9.55	0.00055	0.00508	PASS
Extreme (40°C)		7.36	8.16	0.00391	0.00434	PASS
Extreme (30°C)		5.52	15.89	0.00293	0.00845	PASS
Extreme (20°C)		14.75	13.03	0.00784	0.00693	PASS
Extreme (10°C)		14.67	13.18	0.00780	0.00701	PASS
Extreme (0°C)		15.25	8.00	0.00811	0.00425	PASS
Extreme (-10°C)		12.15	12.40	0.00646	0.00660	PASS
Extreme (-20°C)		8.11	1.39	0.00431	0.00074	PASS
Extreme (-30°C)		9.46	11.08	0.00503	0.00590	PASS



Extreme (-35°C)		15.14	7.74	0.00805	0.00412	PASS
25°C	LV	17.39	13.56	0.00925	0.00721	PASS
	HV	10.28	12.10	0.00547	0.00643	PASS

NB-IoT Band 25						
Condition		Freq.Error (Hz)	Freq.Error (Hz)	Frequency Stability(ppm)	Frequency Stability(ppm)	Verdict
Sub-carrier spacing (KHz)	3.75					
Temperature	Voltage	BPSK	QPSK	BPSK	QPSK	
Normal (25°C)	Normal	17.23	5.68	0.00915	0.00302	PASS
Extreme (75°C)		15.04	2.07	0.00799	0.00110	PASS
Extreme (70°C)		11.97	4.14	0.00636	0.00220	PASS
Extreme (60°C)		1.59	10.95	0.00084	0.00582	PASS
Extreme (50°C)		15.28	8.85	0.00812	0.00470	PASS
Extreme (40°C)		13.77	5.06	0.00731	0.00269	PASS
Extreme (30°C)		16.33	16.37	0.00868	0.00869	PASS
Extreme (20°C)		14.15	9.43	0.00752	0.00501	PASS
Extreme (10°C)		9.46	4.81	0.00503	0.00255	PASS
Extreme (0°C)		12.63	9.12	0.00671	0.00485	PASS
Extreme (-10°C)		10.57	2.38	0.00562	0.00126	PASS
Extreme (-20°C)		2.57	11.00	0.00136	0.00584	PASS
Extreme (-30°C)		3.18	12.64	0.00169	0.00671	PASS
Extreme (-35°C)		13.88	11.57	0.00737	0.00615	PASS
25°C	LV	3.66	9.55	0.00194	0.00507	PASS
	HV	15.32	8.87	0.00814	0.00471	PASS
Condition		Freq.Error (Hz)	Freq.Error (Hz)	Frequency Stability(ppm)	Frequency Stability(ppm)	Verdict
Sub-carrier spacing (KHz)	15					
Temperature	Voltage	BPSK	QPSK	BPSK	QPSK	
Normal (25°C)	Normal	3.54	11.00	0.00188	0.00584	PASS
Extreme (75°C)		15.81	5.75	0.00840	0.00306	PASS
Extreme (70°C)		12.42	5.40	0.00660	0.00287	PASS
Extreme (60°C)		1.47	7.51	0.00078	0.00399	PASS
Extreme (50°C)		9.80	16.17	0.00521	0.00859	PASS
Extreme (40°C)		2.44	7.00	0.00129	0.00372	PASS
Extreme (30°C)		9.98	10.16	0.00530	0.00540	PASS
Extreme (20°C)		14.95	17.28	0.00794	0.00918	PASS
Extreme (10°C)		12.76	16.46	0.00678	0.00874	PASS
Extreme (0°C)		9.64	8.08	0.00512	0.00429	PASS



Extreme (-10°C)		7.01	8.21	0.00373	0.00436	PASS
Extreme (-20°C)		8.00	1.83	0.00425	0.00097	PASS
Extreme (-30°C)		13.71	7.61	0.00728	0.00404	PASS
Extreme (-35°C)		10.77	10.74	0.00572	0.00571	PASS
25°C	LV	10.98	2.99	0.00583	0.00159	PASS
	HV	16.62	17.51	0.00883	0.00930	PASS

5.6.Spurious Emissions at Antenna Terminals

Ambient condition

Temperature	Relative humidity	Pressure
23°C ~25°C	45%~50%	101.5kPa

Method of Measurement

The EUT was connected to Spectrum Analyzer and Base Station Simulator via power Splitter. The measurement is carried out using a spectrum analyzer. The spectrum analyzer scans from 9kHz to the 10th harmonic of the carrier. The peak detector is used.

RBW is set to 100kHz, VBW is set to 300kHz for 30MHz~1GHz

RBW is set to 1MHz, VBW is set to 3MHz for above 1GHz, Sweep is set to ATUO.

RBW is set to 1 kHz (0.009MHz~ 0.15 MHz),

RBW is set to 10 kHz (0.15 MHz~ 30 MHz)

RBW is set to 100 kHz (30MHz~1000 MHz)

RBW is set to 1000 kHz (above 1000MHz)

The modulation mode and RB allocation refer to section 5.1, using the maximum output power configuration.

Test setup

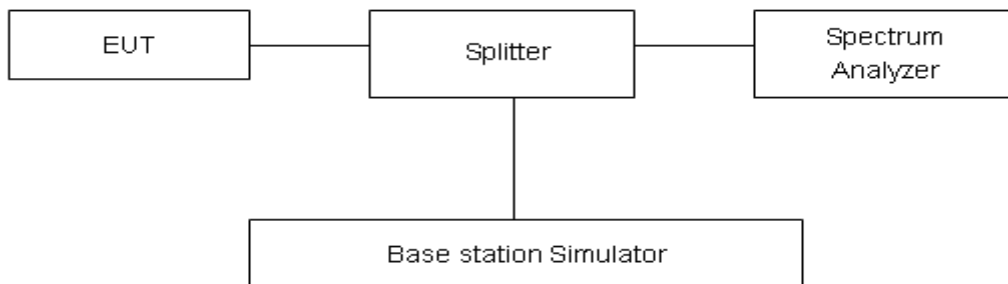

Limits

Rule Part 24.238(a) specifies that “on any frequency outside a licensee's frequency block, the power of any emission shall be attenuated below the transmitter power (P) by at least 43 + 10 log₁₀ (P) dB.”

Limit	-13 dBm
-------	---------

Measurement Uncertainty

The assessed measurement uncertainty to ensure 99.75% confidence level for the normal distribution is with the coverage factor $k = 1.96$.

Frequency	Uncertainty
9kHz-1GHz	0.684 dB
1GHz-20GHz	1.407 dB



Test Result

Sweep the whole frequency band through the range from 9kHz to the 10th harmonic of the carrier, the emissions more than 20 dB below the limit are not reported.

The signal beyond the limit is carrier.

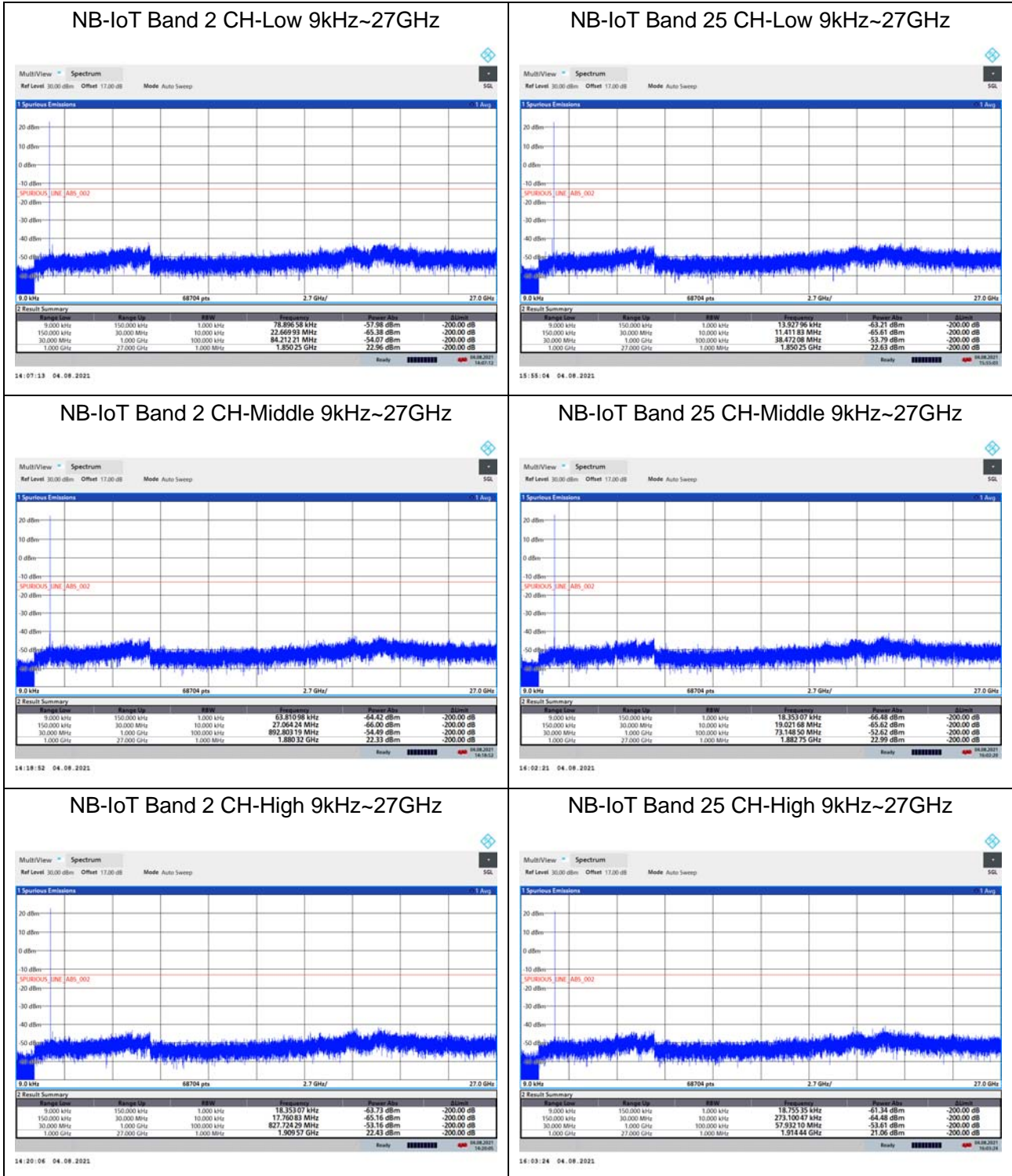

5.7. Radiates Spurious Emission

Ambient condition

Temperature	Relative humidity	Pressure
23°C ~25°C	45%~50%	101.5kPa

Method of Measurement

1. The testing follows FCC KDB 971168 v03r01 Section 5.8 and ANSI C63.26 (2015).
2. Below 1GHz: The EUT is placed on a turntable 0.8 meters above the ground in the chamber, 3 meter away from the antenna. The maximal emission value is acquired by adjusting the antenna height, polarisation and turntable azimuth. Normally, the height range of antenna is 1 m to 4 m, the azimuth range of turntable is 0° to 360°, and the receive antenna has two polarizations Vertical (V) and Horizontal (H). Above 1GHz: (Note: the FCC's permission to use 1.5m as an alternative per TCBC Conf call of Dec. 2, 2014.) The EUT is placed on a turntable 1.5 meters above the ground in the chamber, 3 meter away from the antenna. The maximal emission value is acquired by adjusting the antenna height, polarisation and turntable azimuth. Normally, the height range of antenna is 1 m to 4 m, the azimuth range of turntable is 0° to 360°, and the receive antenna has two polarizations Vertical (V) and Horizontal (H).
3. A loop antenna, A log-periodic antenna or horn antenna shall be substituted in place of the EUT. The log-periodic antenna will be driven by a signal generator and the level will be adjusted till the same power value on the spectrum analyzer or receiver. The level of the spurious emissions can be calculated through the level of the signal generator, cable loss, the gain of the substitution antenna and the reading of the spectrum analyzer or receiver.
4. The EUT is then put into continuously transmitting mode at its maximum power level during the test. Set Test Receiver or Spectrum RBW=1MHz, VBW=3MHz, and the maximum value of the receiver should be recorded as (Pr).
5. The EUT shall be replaced by a substitution antenna. In the chamber, an substitution antenna for the frequency band of interest is placed at the reference point of the chamber. An RF Signal source for the frequency band of interest is connected to the substitution antenna with a cable that has been constructed to not interfere with the radiation pattern of the antenna. A power (PMea) is applied to the input of the substitution antenna, and adjust the level of the signal generator output until the value of the receiver reach the previously recorded (Pr). The power of signal source (PMea) is recorded. The test should be performed by rotating the test item and adjusting the receiving antenna polarization.
6. A amplifier should be connected to the Signal Source output port. And the cable should be connect between the Amplifier and the Substitution Antenna. The cable loss (Pcl) ,the Substitution Antenna Gain (Ga) and the Amplifier Gain (PAg) should be recorded after test.
7. The measurement results are obtained as described below:
$$\text{Power(EIRP)} = \text{PMea} - \text{PAg} - \text{Pcl} + \text{Ga}$$
The measurement results are amend as described below:
$$\text{Power(EIRP)} = \text{PMea} - \text{Pcl} + \text{Ga}$$
8. This value is EIRP since the measurement is calibrated using an antenna of known gain (2.15 dBi) and known input power. ERP can be calculated from EIRP by subtracting the gain of the dipole, ERP

= EIRP-2.15dBi.

The modulation mode and RB allocation refer to section 5.1, using the maximum output power configuration.

Test setup

9KHz ~ 30MHz

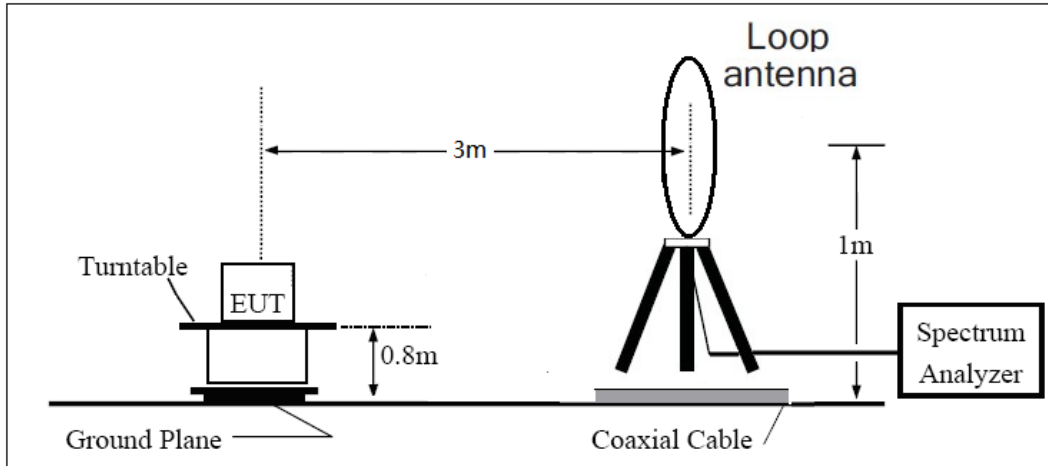

30MHz ~ 1GHz

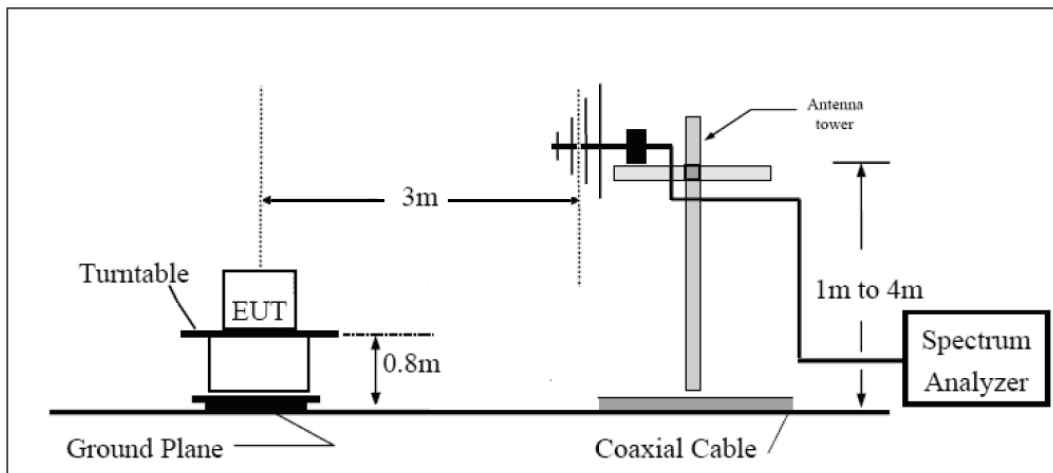

Above 1GHz

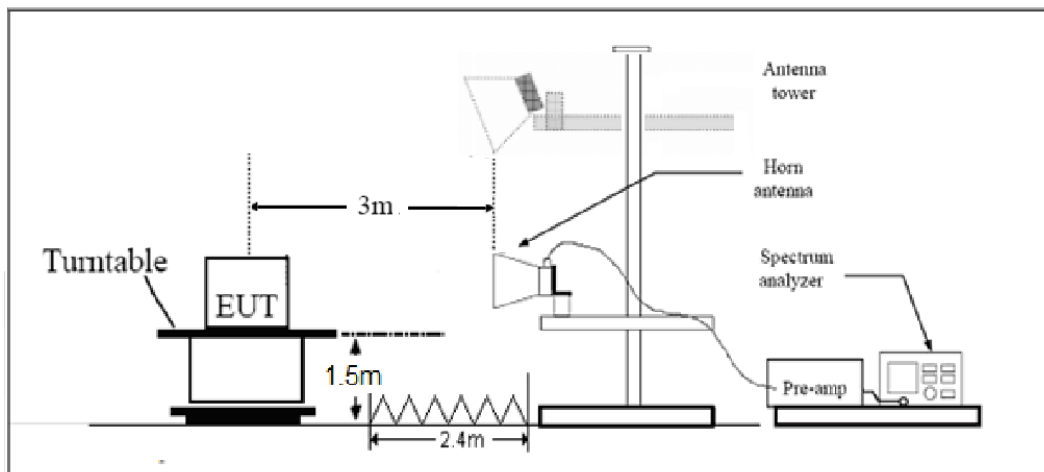

Note: Area side: 2.4mX3.6m

Limits

Rule Part 24.238(a) specifies that “on any frequency outside a licensee's frequency block, the power of any emission shall be attenuated below the transmitter power (P) by at least $43 + 10 \log_{10} (P)$ dB.”

Limit	-13 dBm
-------	---------

Measurement Uncertainty

The assessed measurement uncertainty to ensure 95% confidence level for the normal distribution is with the coverage factor $k = 1.96$, $U = 3.55$ dB.

Test Result

Sweep the whole frequency band through the range from 9kHz to the 10th harmonic of the carrier, the emissions below the noise floor will not be recorded in the report.

NB-IoT Band 2 3.75KHz BPSK CH-Low

Harmonic	Frequency (MHz)	SG (dBm)	Cable Loss (dB)	Gain (dBi)	Antenna Polarization	ERP Level (dBm)	Limit (dBm)	Margin (dB)	Azimuth (deg)
2	3760.00	-58.72	1.70	8.70	Vertical	-51.72	-13.00	38.72	270
3	5640.00	-52.73	2.30	12.00	Vertical	-43.03	-13.00	30.03	315
4	7520.00	-56.52	2.70	12.70	Vertical	-46.52	-13.00	33.52	90
5	9400.00	-56.10	3.00	12.50	Vertical	-46.60	-13.00	33.60	180
6	11280.00	-54.56	3.40	12.50	Vertical	-45.46	-13.00	32.46	0
7	13160.00	-54.95	3.40	12.80	Vertical	-45.55	-13.00	32.55	90
8	15040.00	-55.25	4.10	11.50	Vertical	-47.85	-13.00	34.85	90
9	16920.00	-53.05	4.20	12.20	Vertical	-45.05	-13.00	32.05	45
10	18800.00	/	/	/	/	/	/	/	/

Note: 1.The other Spurious RF Radiated emissions level is no more than noise floor.
2.The worst emission was found in the antenna is Vertical position.

NB-IoT Band 2 3.75KHz BPSK CH-Middle

Harmonic	Frequency (MHz)	SG (dBm)	Cable Loss (dB)	Gain (dBi)	Antenna Polarization	ERP Level (dBm)	Limit (dBm)	Margin (dB)	Azimuth (deg)
2	3700.20	-59.20	1.70	8.70	Vertical	-52.20	-13.00	39.20	270
3	5550.30	-50.59	2.30	12.00	Vertical	-40.89	-13.00	27.89	315
4	7400.40	-53.94	2.70	12.70	Vertical	-43.94	-13.00	30.94	90
5	9250.50	-59.83	3.00	12.50	Vertical	-50.33	-13.00	37.33	180
6	11100.60	-55.07	3.40	12.50	Vertical	-45.97	-13.00	32.97	0
7	12950.70	-55.64	3.40	12.80	Vertical	-46.24	-13.00	33.24	90
8	14800.80	-53.18	4.10	11.50	Vertical	-45.78	-13.00	32.78	90
9	16650.90	-54.39	4.20	12.20	Vertical	-46.39	-13.00	33.39	45
10	18501.00	/	/	/	/	/	/	/	/

Note: 1.The other Spurious RF Radiated emissions level is no more than noise floor.
2.The worst emission was found in the antenna is Vertical position.

NB-IoT Band 2 3.75KHz BPSK CH-High

Harmonic	Frequency (MHz)	SG (dBm)	Cable Loss (dB)	Gain (dBi)	Antenna Polarization	ERP Level (dBm)	Limit (dBm)	Margin (dB)	Azimuth (deg)
2	3819.80	-58.14	1.70	8.70	Vertical	-51.14	-13.00	38.14	270
3	5729.70	-53.78	2.30	12.00	Vertical	-44.08	-13.00	31.08	180
4	7639.60	-56.74	2.70	12.70	Vertical	-46.74	-13.00	33.74	45
5	9549.50	-57.53	3.00	12.50	Vertical	-48.03	-13.00	35.03	315
6	11459.40	-54.24	3.40	12.50	Vertical	-45.14	-13.00	32.14	90
7	13369.30	-55.53	3.40	12.80	Vertical	-46.13	-13.00	33.13	315
8	15279.20	-56.50	4.10	11.50	Vertical	-49.10	-13.00	36.10	315
9	17189.10	-53.15	4.20	12.20	Vertical	-45.15	-13.00	32.15	90
10	19099.00	/	/	/	/	/	/	/	/

Note: 1.The other Spurious RF Radiated emissions level is no more than noise floor.
 2.The worst emission was found in the antenna is Vertical position.

NB-IoT Band 25 3.75KHz BPSK CH-Low

Harmonic	Frequency (MHz)	SG (dBm)	Cable Loss (dB)	Gain (dBi)	Antenna Polarization	ERP Level (dBm)	Limit (dBm)	Margin (dB)	Azimuth (deg)
2	3700.20	-61.37	1.70	8.70	Vertical	-54.37	-13.00	41.37	45
3	5550.30	-51.29	2.30	12.00	Vertical	-41.59	-13.00	28.59	315
4	7400.40	-55.13	2.70	12.70	Vertical	-45.13	-13.00	32.13	135
5	9250.50	-57.80	3.00	12.50	Vertical	-48.30	-13.00	35.30	180
6	11100.60	-55.19	3.40	12.50	Vertical	-46.09	-13.00	33.09	315
7	12950.70	-53.39	3.40	12.80	Vertical	-43.99	-13.00	30.99	90
8	14800.80	-53.23	4.10	11.50	Vertical	-45.83	-13.00	32.83	45
9	16650.90	-53.04	4.20	12.20	Vertical	-45.04	-13.00	32.04	225
10	18501.00	/	/	/	/	/	/	/	/

Note: 1.The other Spurious RF Radiated emissions level is no more than noise floor.
 2. The worst emission was found in the antenna is Vertical position.

NB-IoT Band25 3.75KHz BPSK CH-Middle

Harmonic	Frequency (MHz)	SG (dBm)	Cable Loss (dB)	Gain (dBi)	Antenna Polarization	ERP Level (dBm)	Limit (dBm)	Margin (dB)	Azimuth (deg)
2	3765.00	-61.25	1.70	8.70	Vertical	-54.25	-13.00	41.25	45
3	5647.50	-53.22	2.30	12.00	Vertical	-43.52	-13.00	30.52	180
4	7530.00	-57.61	2.70	12.70	Vertical	-47.61	-13.00	34.61	135
5	9412.50	-56.81	3.00	12.50	Vertical	-47.31	-13.00	34.31	90
6	11295.00	-53.11	3.40	12.50	Vertical	-44.01	-13.00	31.01	45
7	13177.50	-54.01	3.40	12.80	Vertical	-44.61	-13.00	31.61	315
8	15060.00	-55.11	4.10	11.50	Vertical	-47.71	-13.00	34.71	90
9	16942.50	-52.45	4.20	12.20	Vertical	-44.45	-13.00	31.45	225
10	18825.00	/	/	/	/	/	/	/	/

Note: 1.The other Spurious RF Radiated emissions level is no more than noise floor.
 2.The worst emission was found in the antenna is Vertical position.

NB-IoT Band 25 3.75KHz BPSK CH-High

Harmonic	Frequency (MHz)	SG (dBm)	Cable Loss (dB)	Gain (dBi)	Antenna Polarization	ERP Level (dBm)	Limit (dBm)	Margin (dB)	Azimuth (deg)
2	3829.80	-60.93	1.70	8.70	Vertical	-53.93	-13.00	40.93	225
3	5744.70	-54.44	2.30	12.00	Vertical	-44.74	-13.00	31.74	90
4	7659.60	-57.22	2.70	12.70	Vertical	-47.22	-13.00	34.22	0
5	9574.50	-57.80	3.00	12.50	Vertical	-48.30	-13.00	35.30	0
6	11489.40	-54.22	3.40	12.50	Vertical	-45.12	-13.00	32.12	45
7	13404.30	-53.71	3.40	12.80	Vertical	-44.31	-13.00	31.31	315
8	15319.20	-56.17	4.10	11.50	Vertical	-48.77	-13.00	35.77	180
9	17234.10	-52.38	4.20	12.20	Vertical	-44.38	-13.00	31.38	90
10	19149.00	/	/	/	/	/	/	/	/

Note: 1.The other Spurious RF Radiated emissions level is no more than noise floor.
 2.The worst emission was found in the antenna is Vertical position.

6. Main Test Instruments

Name	Manufacturer	Type	Serial Number	Calibration Date	Expiration Date
Base Station Simulator	R&S	CMU200	118133	2021-05-15	2022-05-14
Base Station Simulator	R&S	CMW500	113824	2021-05-15	2022-05-14
Power Splitter	Hua Xiang	SHX-GF2-2-13	10120101	/	/
Spectrum Analyzer	Key sight	N9010A	MY50210259	2021-05-15	2022-05-14
Universal Radio Communication Tester	Key sight	E5515C	MY48367192	2021-5-15	2022-5-14
Signal Analyzer	R&S	FSV3030	101411	2020-12-13	2021-12-12
Loop Antenna	SCHWARZBECK	FMZB1519	1519-047	2020-04-02	2023-04-01
TRILOG Broadband Antenna	SCHWARZBECK	VULB 9163	391	2019-12-16	2022-12-15
Horn Antenna	R&S	HF907	102723	2020-08-11	2023-08-10
Signal generator	R&S	SMB 100A	102594	2021-05-15	2022-05-14
Climatic Chamber	ESPEC	SU-242	93000506	2020-12-13	2021-12-12
MOB COMMS DC SUPPLY	Keysight	66319D	MY43004105	2021-06-09	2021-12-08
RF Cable	Agilent	SMA 15cm	0001	2021-06-09	2021-12-08
Software	R&S	EMC32	9.26.0	/	/

*****END OF REPORT *****



ANNEX A: The EUT Appearance

The EUT Appearance are submitted separately.



ANNEX B: Test Setup Photos

The Test Setup Photos are submitted separately.



ANNEX C: Product Change Description

The Product Change Description are submitted separately.