



# RF TEST REPORT

**Applicant**      Quectel Wireless Solutions Co., Ltd.  
**FCC ID**            XMR2022BG952AGL  
**Product**          LTE Cat M1 & Cat NB1 Module  
**Brand**              Quectel  
**Model**              BG952A-GL  
**Report No.**        R2206A0479-R1  
**Issue Date**        June 22, 2022

TA Technology (Shanghai) Co., Ltd. tested the above equipment in accordance with the requirements in **FCC CFR47 Part 2 (2021)/ FCC CFR 47 Part 22H (2021)**. The test results show that the equipment tested is capable of demonstrating compliance with the requirements as documented in this report.

Prepared by: Peng Tao

Approved by: Kai Xu

---

**TA Technology (Shanghai) Co., Ltd.**

No.145, Jintang Rd, Tangzhen Industry Park, Pudong Shanghai, China

TEL: +86-021-50791141/2/3

FAX: +86-021-50791141/2/3-8000



## TABLE OF CONTENT

1. Test Laboratory .....	4
1.1. Notes of the Test Report .....	4
1.2. Test facility .....	4
1.3. Testing Location .....	4
2. General Description of Equipment under Test.....	5
2.1. Applicant and Manufacturer Information .....	5
2.2. General Information.....	5
3. Applied Standards .....	6
4. Test Configuration.....	7
5. Test Case Results.....	8
5.1. RF Power Output and Effective Radiated Power Ambient condition .....	8
5.2. Occupied Bandwidth .....	10
5.3. Band Edge Compliance.....	15
5.4. Peak-to-Average Power Ratio (PAPR) .....	18
5.5. Frequency Stability.....	20
5.6. Spurious Emissions at Antenna Terminals .....	23
5.7. Radiates Spurious Emission .....	25
6. Main Test Instruments .....	30
ANNEX A: The EUT Appearance .....	31
ANNEX B: Test Setup Photos .....	32
<b>ANNEX C: Product Change Description .....</b>	<b>33</b>

### Summary of measurement results

No.	Test Case	Clause in FCC rules	Verdict
1	RF Power Output and Effective Radiated Power	2.1046 22.913(a)(5)	PASS
2	Occupied Bandwidth	2.1049	PASS
3	Band Edge Compliance	2.1051 / 22.917(a)	PASS
4	Peak-to-Average Power Ratio	22.913(d)/ KDB 971168 D01(5.7)	PASS
5	Frequency Stability	2.1055 / 22.355	PASS
6	Spurious Emissions at Antenna Terminals	2.1051 / 22.917(a)	PASS
7	Radiates Spurious Emission	2.1053 / 22.917 (a)	PASS

Date of Testing: July 21, 2021 ~ August 5, 2021

Date of Sample Received: July 20, 2021

Note: PASS: The EUT complies with the essential requirements in the standard.

FAIL: The EUT does not comply with the essential requirements in the standard.

All indications of Pass/Fail in this report are opinions expressed by TA Technology (Shanghai) Co., Ltd. based on interpretations and/or observations of test results. Measurement Uncertainties were not taken into account and are published for informational purposes only.

**BG952A-GL (Report No.: R2206A0479-R1) is a variant model of BG950A-GL (Report No.: R2107A0607-R1). Test values duplicated from Original for variant. The power of new variant are varied due to measurement uncertainty, and sample tolerance of the acceptance range. The detailed product change description please refers to following table:**

Module	BG950A-GL	BG952A-GL
QuecOpen®	N/A	Supported
Hardware Version	R1.3	R1.5
Software Version	BG950AGLAAR01A01	BG952AGLAAR01A03
Product Name	LTE Module	LTE Cat M1 & Cat NB1 Module
Others	The same	

The detailed product change description please refers to the Difference Declaration Letter.



## 1. Test Laboratory

### 1.1. Notes of the Test Report

This report shall not be reproduced in full or partial, without the written approval of **TA technology (shanghai) co., Ltd.** The results documented in this report apply only to the tested sample, under the conditions and modes of operation as described herein. Measurement Uncertainties were not taken into account and are published for informational purposes only. This report is written to support regulatory compliance of the applicable standards stated above.

### 1.2. Test facility

#### **FCC (Designation number: CN1179, Test Firm Registration Number: 446626)**

TA Technology (Shanghai) Co., Ltd. has been listed on the US Federal Communications Commission list of test facilities recognized to perform measurements.

#### **A2LA (Certificate Number: 3857.01)**

TA Technology (Shanghai) Co., Ltd. has been listed by American Association for Laboratory Accreditation to perform measurement.

### 1.3. Testing Location

Company: TA Technology (Shanghai) Co., Ltd.  
Address: No.145, Jintang Rd, Tangzhen Industry Park, Pudong  
City: Shanghai  
Post code: 201201  
Country: P. R. China  
Contact: Xu Kai  
Telephone: +86-021-50791141/2/3  
Fax: +86-021-50791141/2/3-8000  
Website: <http://www.ta-shanghai.com>  
E-mail: [xukai@ta-shanghai.com](mailto:xukai@ta-shanghai.com)

## 2. General Description of Equipment under Test

### 2.1. Applicant and Manufacturer Information

Applicant	Quectel Wireless Solutions Co., Ltd.
Applicant address	Building 5, Shanghai Business Park Phase III (Area B), No.1016 Tianlin Road, Minhang District, Shanghai, China, 200233
Manufacturer	Quectel Wireless Solutions Co., Ltd.
Manufacturer address	Building 5, Shanghai Business Park Phase III (Area B), No.1016 Tianlin Road, Minhang District, Shanghai, China, 200233

### 2.2. General Information

EUT Description			
Model	BG952A-GL		
IMEI	869410050002659		
Hardware Version	R1.5		
Software Version	BG952AGLAAR01A03		
Power Supply	External power supply		
Antenna Type	External Antenna		
Antenna Gain	Mode	Frequency (MHz)	Gain (dBi)
	NB-IoT Band 5	820	2.53
		830	2.13
		840	1.89
850		2.29	
Test Mode(s)	NB-IoT Band5;		
Test Modulation	BPSK, QPSK		
Category	NB1		
Deployment	standalone, in-band, guard-band		
Sub-carrier spacing	3.75KHz, 15KHz		
Ntones:	single-tone, multi-tone		
Maximum E.R.P.	NB-IoT Band5	24.05dBm	
Rated Power Supply Voltage	3.3V		
Operating Voltage	Minimum: 2.2V    Maximum: 4.35V		
Operating Temperature	Lowest: -35°C    Highest: +75°C		
Extreme Temperature	Lowest: -35°C    Highest: +75°C		
Frequency Range(s)	Band	Tx (MHz)	Rx (MHz)
	NB-IoT Band5;	824 ~ 849	869 ~ 894
Note: 1. The EUT is sent from the applicant to TA and the information of the EUT is declared by the applicant.			



### 3. Applied Standards

According to the specifications of the manufacturer, it must comply with the requirements of the following standards:

**Test standards:**

**FCC CFR 47 Part 22H (2021)**

**ANSI C63.26-2015**

**Reference standard:**

**FCC CFR47 Part 2 (2021)**

**KDB 971168 D01 Power Meas License Digital Systems v03r01**

## 4. Test Configuration

Radiated measurements are performed by rotating the EUT in three different orthogonal test planes. EUT stand-up position (Z axis), lie-down position (X, Y axis). Receiver antenna polarization (horizontal and vertical), the worst emission was found in position (Z axis, vertical polarization) and the worst case was recorded.

All modes as Subcarrier Spacing, modulations, Channel were investigated.

Subsequently, only the worst case emissions are reported.

The following testing in NB-IoT is set based on the maximum RF Output Power.

The following testing in different mode is set to detail in the following table:

Test modes are chosen as the worst case configuration below for NB-IoT Band 5

Test items	Modes	Deployment mode	Subcarrier Spacing (kHz)		Modulation		Test Channel		
		Stand-alone	3.75	15	BPSK	QPSK	L	M	H
RF power output and Effective Radiated power	NB-IoT B5	O	O	O	O	O	O	O	O
Occupied Bandwidth	NB-IoT B5	O	O	O	O	O	O	O	O
Band Edge Compliance	NB-IoT B5	O	O	O	O	O	O	-	O
Peak-to-Average Power Ratio	NB-IoT B5	O	O	O	O	O	-	O	-
Frequency Stability	NB-IoT B5	O	O	O	O	O	-	O	-
Spurious Emissions at Antenna Terminals	NB-IoT B5	O	-	O	-	O	O	O	O
Radiates Spurious Emission	NB-IoT B5	O	-	O	-	O	-	O	-
<p>Note</p> <ol style="list-style-type: none"> <li>1. The mark "O" means that this configuration is chosen for testing.</li> <li>2. The mark "-" means that this configuration is not testing.</li> </ol>									

## 5. Test Case Results

### 5.1. RF Power Output and Effective Radiated Power Ambient condition

Temperature	Relative humidity	Pressure
23°C ~25°C	45%~50%	101.5kPa

#### Methods of Measurement

During the process of the testing, The EUT was connected to the Base Station Simulator with a known loss. The EUT is controlled by the Base Station Simulator test set to ensure max power transmission with proper modulation.

ERP can then be calculated as follows:

$$\text{EIRP (dBm)} = \text{Output Power (dBm)} - \text{Losses (dB)} + \text{Antenna Gain (dBi)}$$

where:dBd refers to gain relative to an ideal dipole.

$$\text{EIRP (dBm)} = \text{ERP (dBm)} + 2.15 \text{ (dB)}$$

#### Test Setup

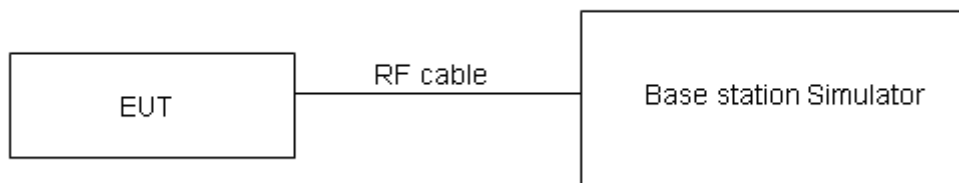

#### Limits

No specific RF power output requirements in part 2.1046.

Rule Part 22.913(a)(5) specifies that "Mobile/portable stations are limited to 7 watts ERP".

Limit	≤ 7 W (38.45 dBm)
-------	-------------------

#### Measurement Uncertainty

The assessed measurement uncertainty to ensure 95% confidence level for the normal distribution is with the coverage factor  $k = 2$ ,  $U = 0.4 \text{ dB}$  for RF power output,  $k = 2$ ,  $U = 1.19 \text{ dB}$  for ERP.



**Test Results**

Mode	Modulation	Sub-carrier spacing (KHz)	Ntones	Maxmum output Power (dBm) for low/mid/high channel			ERP (dBm)		
				20402 /824.2	20525 /836.5	20648 /848.8	20402 /824.2	20525 /836.5	20648 /848.8
NB-IoT Band 5	BPSK	3.75	1@0	23.14	23.30	23.39	23.52	23.04	23.53
			1@47	23.07	23.24	23.37	23.45	22.98	23.51
		15	1@0	23.67	23.67	23.61	24.05	23.41	23.75
			1@11	23.62	23.59	23.57	24.00	23.33	23.71
	QPSK	3.75	1@0	23.14	23.25	23.40	23.52	22.99	23.54
			1@47	23.09	23.21	23.39	23.47	22.95	23.53
		15	1@0	23.47	23.57	23.45	23.85	23.31	23.59
			1@11	23.64	23.61	23.47	24.02	23.35	23.61
		15	12@0	21.20	21.18	21.17	21.58	20.92	21.31

## 5.2. Occupied Bandwidth

### Ambient condition

Temperature	Relative humidity	Pressure
23°C ~25°C	45%~50%	101.5kPa

### Method of Measurement

The EUT was connected to Spectrum Analyzer and Base Station Simulator via power Splitter. The occupied bandwidth is measured using spectrum analyzer.

RBW is set to 2kHz, VBW is set to 6.2kHz for NB-IoT Band 5

99% power and -26dBc occupied bandwidths are recorded. Spectrum analyzer plots are included on the following pages.

### Test Setup

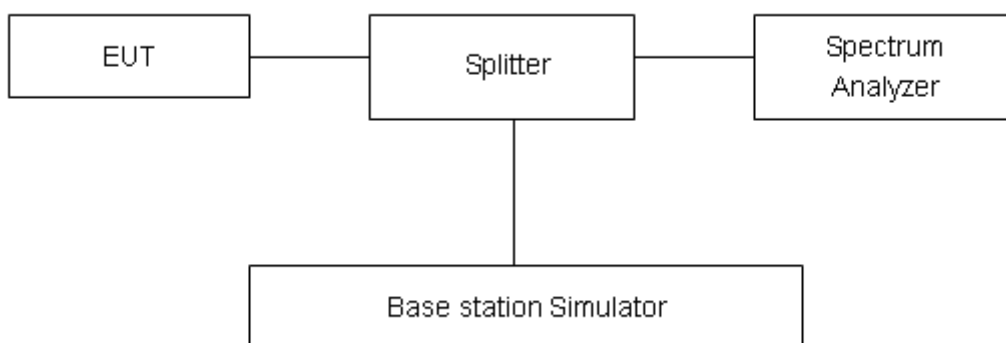

### Limits

No specific occupied bandwidth requirements in part 2.1049.

### Measurement Uncertainty

The assessed measurement uncertainty to ensure 95% confidence level for the normal distribution is with the coverage factor  $k = 2$ ,  $U = 624\text{Hz}$ .

**Test Result**

Mode	Modulation	Sub-carrier spacing (KHz)	Ntones	Bandwidth(KHz) for low/mid/high channel					
				20402/824.2(MHz)		20525/836.5(MHz)		20648/848.8(MHz)	
				99% Power	-26dBc	99% Power	-26dBc	99% Power	-26dBc
NB-IoT Band 5 Standalone	BPSK	3.75	1@0	36.82	38.02	38.72	37.54	38.56	36.88
	QPSK	3.75	1@0	39.74	39.06	41.90	41.30	41.32	40.99
	BPSK	15	1@0	73.98	92.67	75.40	90.44	74.26	100.10
	QPSK	15	1@0	72.50	100.20	71.86	90.24	71.41	98.26
	QPSK	15	12@0	185.71	267.30	188.04	262.90	187.00	242.80

NB-IoT Band 5 BPSK 3.75kHz 1@0 CH-Low

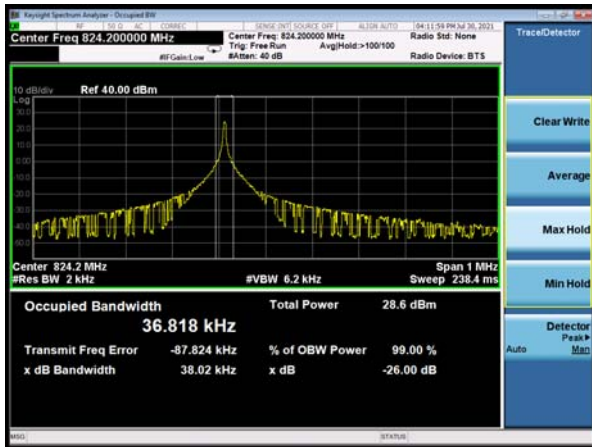

NB-IoT Band 5 BPSK 15kHz 1@0 CH-Low

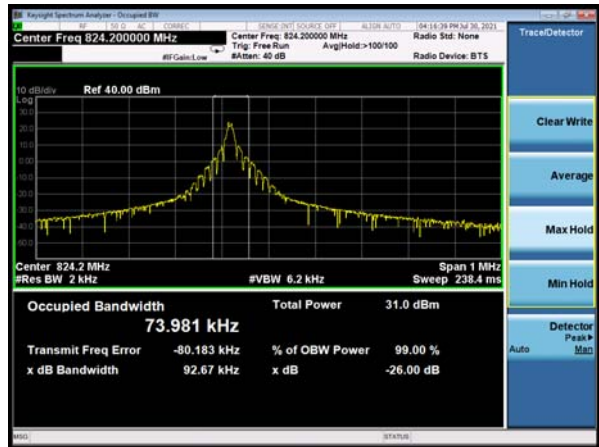

NB-IoT Band 5 BPSK 3.75kHz 1@0 CH-Middle

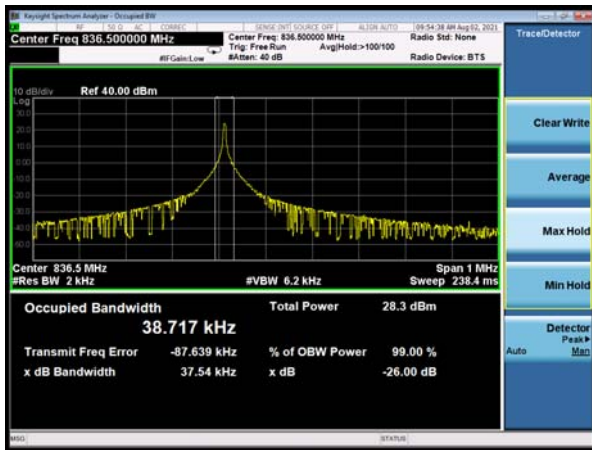

NB-IoT Band 5 BPSK 15kHz 1@0 CH-Middle

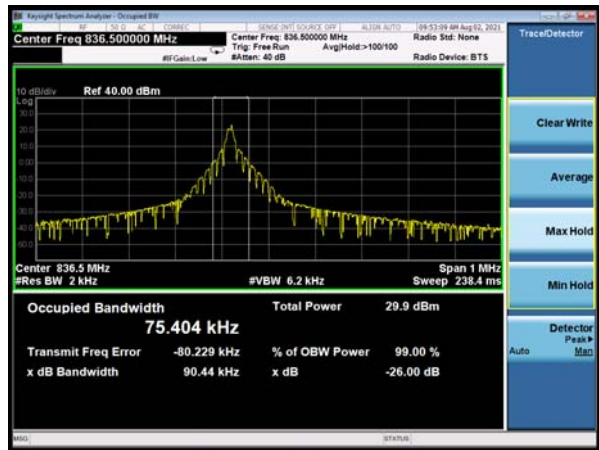

NB-IoT Band 5 BPSK 3.75kHz 1@0 CH-High

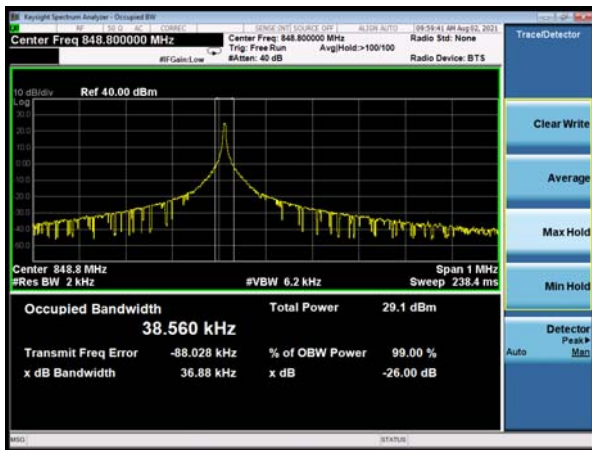

NB-IoT Band 5 BPSK 15kHz 1@0 CH-High



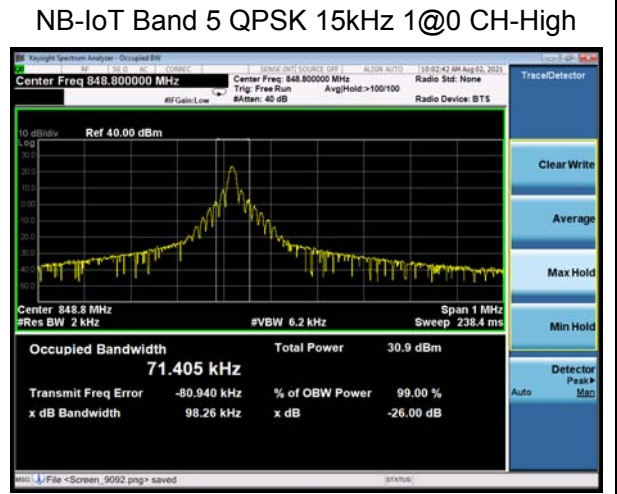
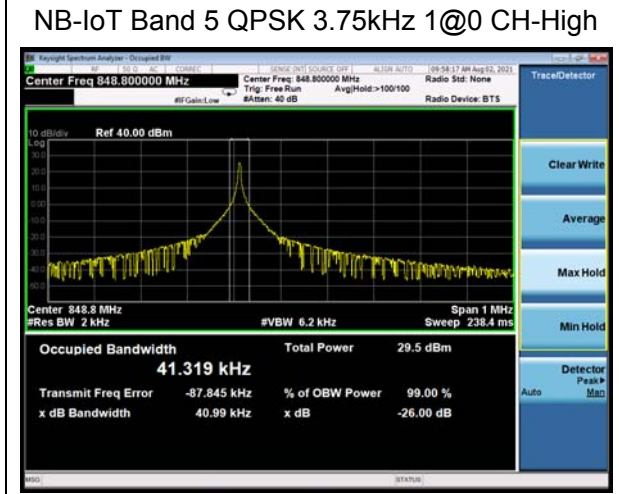
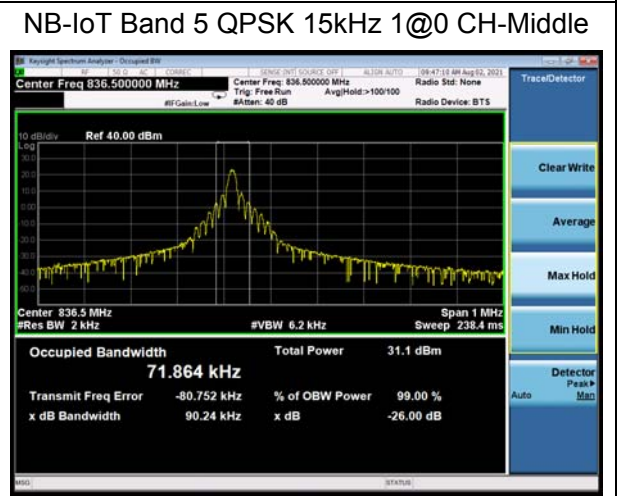
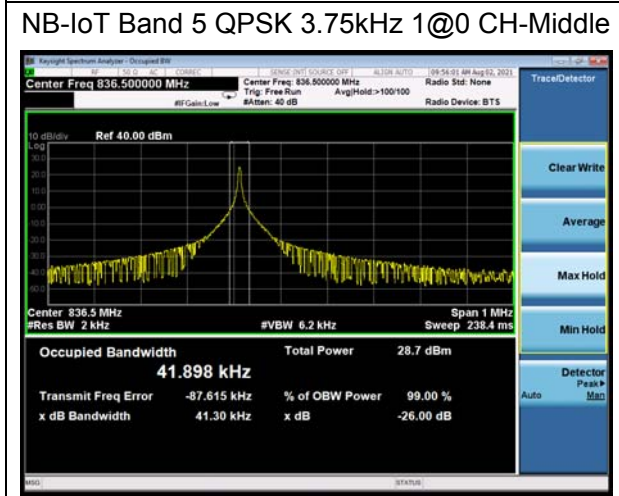
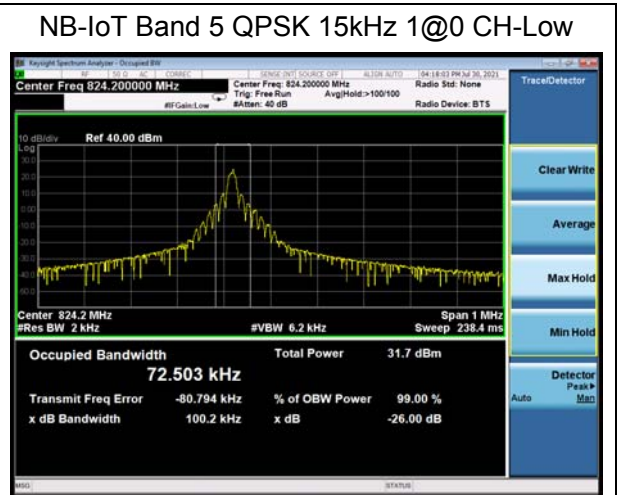
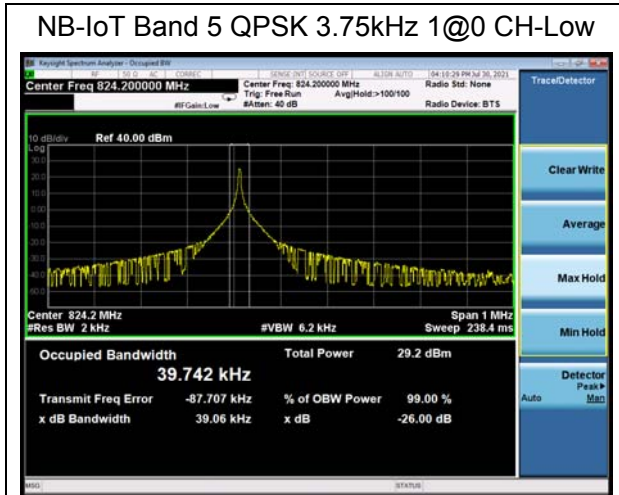

NB-IoT Band 5 QPSK 15kHz 12@0 CH-Low



NB-IoT Band 5 QPSK 15kHz 12@0 CH-Middle

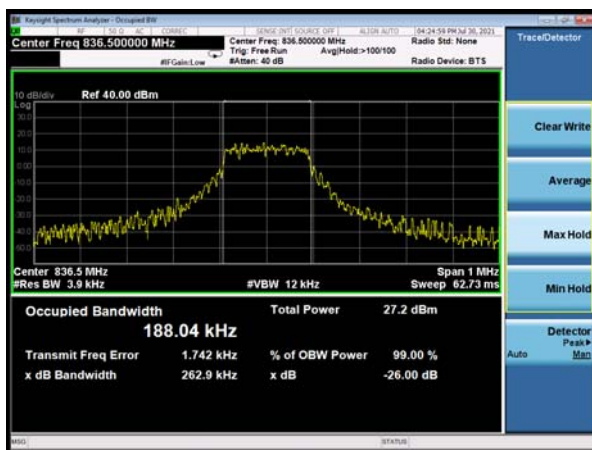

NB-IoT Band 5 QPSK 15kHz 12@0 CH-High

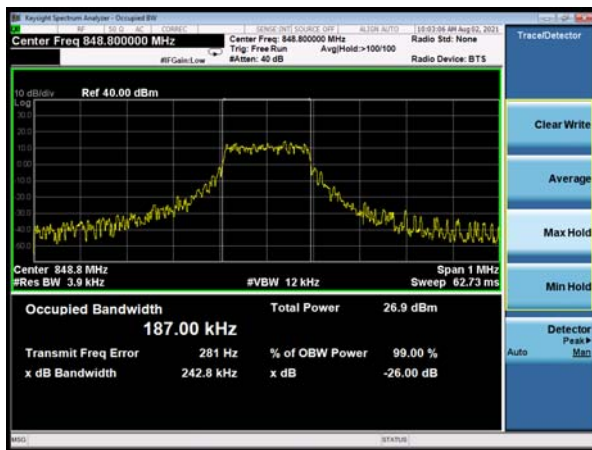

### 5.3. Band Edge Compliance

#### Ambient condition

Temperature	Relative humidity	Pressure
23°C ~25°C	45%~50%	101.5kPa

#### Method of Measurement

The EUT was connected to Spectrum Analyzer and Base Station Simulator via power Splitter. The band edge of the lowest and highest channels were measured. The average detector is used. RBW is set to  $\geq 1\%EBW$ , VBW is set to 3x RBW.

Spectrum analyzer plots are included on the following pages.

#### Test Setup

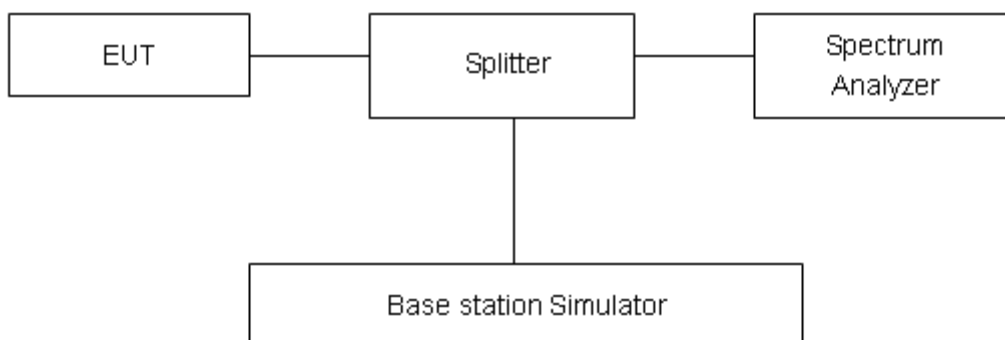

#### Limits

Rule Part 22.917(a) specifies that “The power of any emission outside of the authorized operating frequency ranges must be attenuated below the transmitting power (P) by a factor of at least  $43 + 10 \log(P)$  dB.”

Limit	-13 dBm
-------	---------

#### Measurement Uncertainty

The assessed measurement uncertainty to ensure 95% confidence level for the normal distribution is with the coverage factor  $k = 1.96$ ,  $U=0.684$ dB.

Test Result:

NB-IoT Band 5 BPSK 3.75kHz 1@0 CH-Low

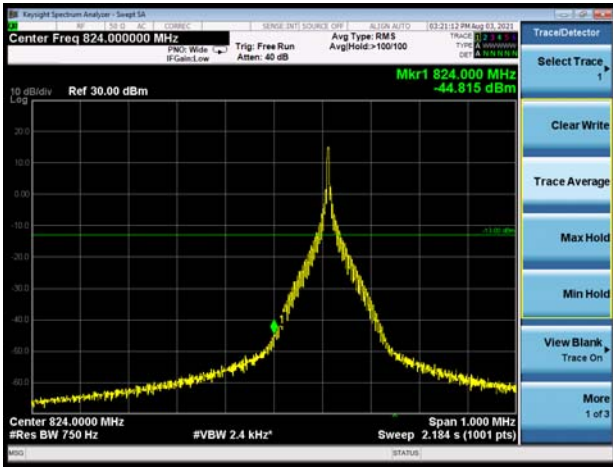

NB-IoT Band 5 BPSK 3.75kHz 1@47 CH-High

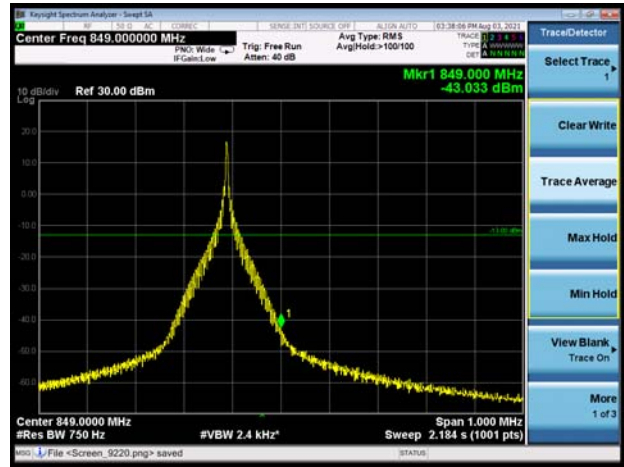

NB-IoT Band 5 BPSK 15kHz 1@0 CH-Low

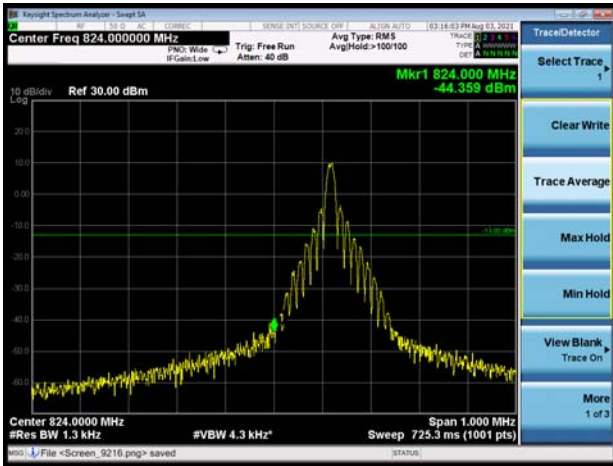

NB-IoT Band 5 BPSK 15kHz 1@11 CH-High

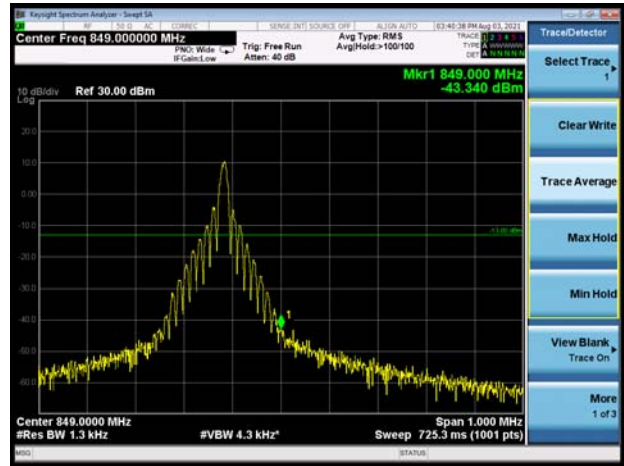

NB-IoT Band 5 QPSK 3.75kHz 1@0 CH-Low

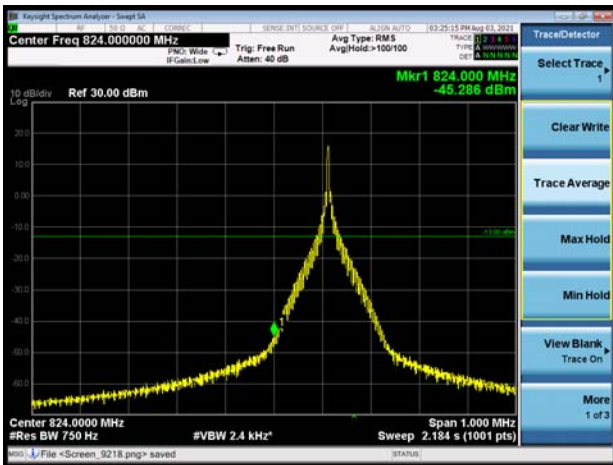

NB-IoT Band 5 QPSK 3.75kHz 1@47 CH-High

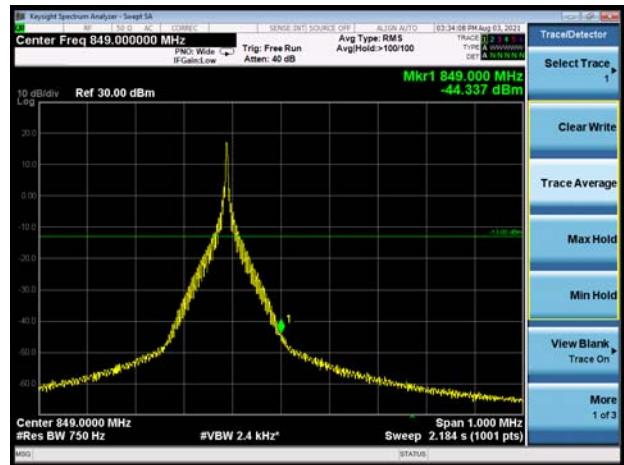



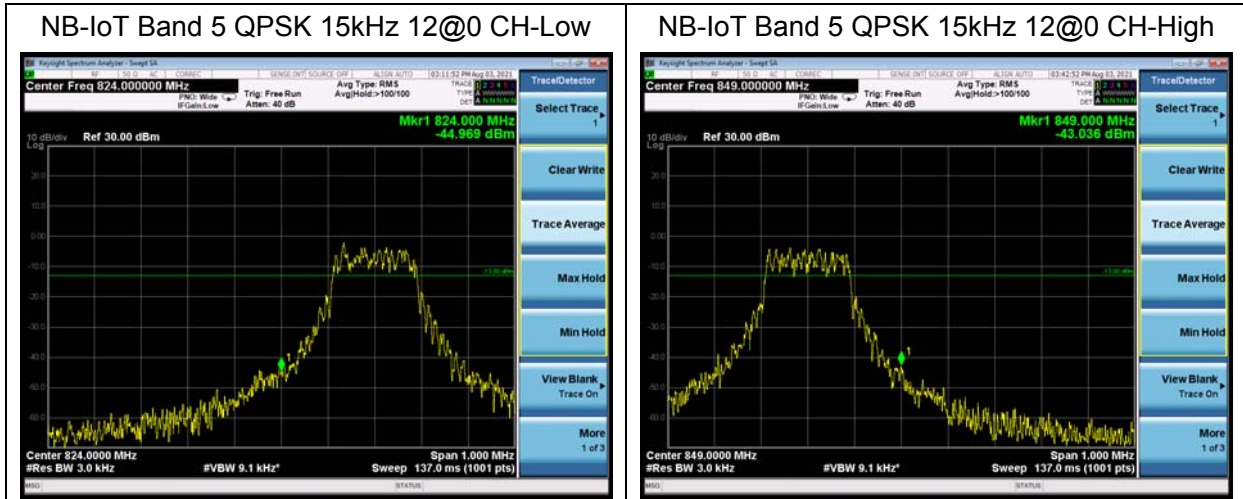

### 5.4. Peak-to-Average Power Ratio (PAPR)

#### Ambient condition

Temperature	Relative humidity	Pressure
23°C ~25°C	45%~50%	101.5kPa

#### Methods of Measurement

Measure the total peak power and record as  $P_{Pk}$ . And measure the total average power and record as  $P_{Avg}$ . Both the peak and average power levels must be expressed in the same logarithmic units (e.g., dBm). Determine the PAPR from:

$$PAPR (dB) = P_{Pk} (dBm) - P_{Avg} (dBm).$$

#### Test Setup

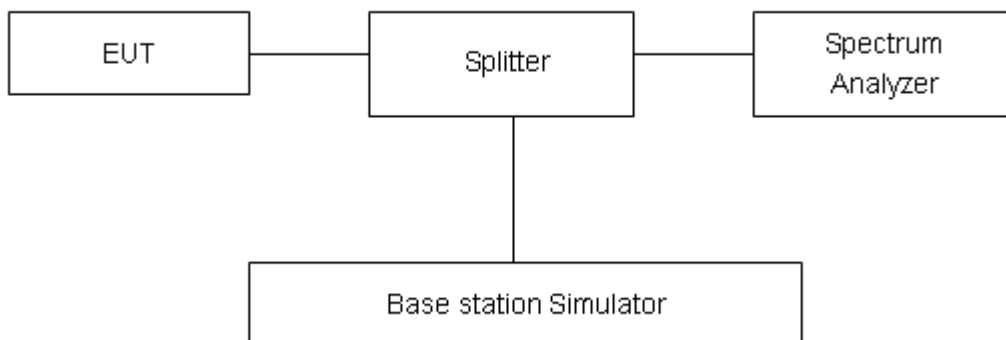

#### Limits

According to the Sec. 22.913(d), The peak-to-average ratio (PAR) of the transmission must not exceed 13 dB.

#### Measurement Uncertainty

The assessed measurement uncertainty to ensure 95% confidence level for the normal distribution is with the coverage factor  $k = 2$ ,  $U = 0.4$  dB.

**Test Results**

Mode	Modulation	Sub-carrier spacing (KHz)	Channel/ Frequency(MHz)	Peak-to-Average Power Ratio (PAPR)		
				Peak(dBm)	Avg(dBm)	PAPR(dB)
NB-IoT Band 5 Standalone	BPSK	3.75	20525/836.5	25.14	22.35	2.79
	QPSK	3.75	20525/836.5	25.24	22.32	2.92
	BPSK	15	20525/836.5	25.07	18.86	6.21
	QPSK	15	20525/836.5	24.96	18.99	5.97

## 5.5. Frequency Stability

### Ambient condition

Temperature	Relative humidity	Pressure
23°C ~25°C	45%~50%	101.5kPa

### Method of Measurement

#### Frequency Stability (Temperature Variation)

The temperature inside the climate chamber is varied from -35°C to +75°C in 10°C step size,

(1) With all power removed, the temperature was decreased to 0°C and permitted to stabilize for three hours.

(2) Measure the carrier frequency with the test equipment in a “call mode”. These measurements should be made within 1 minute of powering up the mobile station, to prevent significant self warming.

(3) Repeat the above measurements at 10°C increments from -35°C to +75°C. Allow at least 1.5 hours at each temperature, un-powered, before making measurements. Frequency Stability (Voltage Variation)

The frequency stability shall be measured with variation of primary supply voltage as follows:

**Primary Supply Voltage:** The primary supply voltage is varied from 85% to 115% of the nominal value for non hand-carried battery and AC powered equipment. For hand-carried, battery-powered equipment, primary supply voltage is reduced to the battery operating end point which shall be specified by the manufacturer.

This transceiver is specified to operate with an input voltage of between 2.2V and 4.35 V, with a nominal voltage of 3.3V.

### Test setup

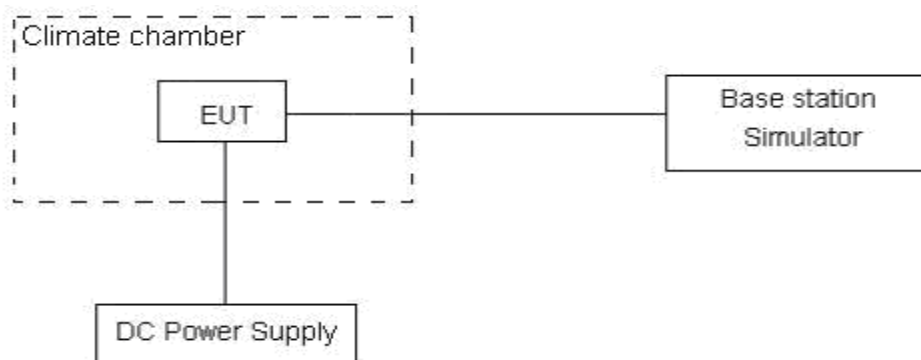

### Limits

According to the Sec. 22.355, the frequency stability of the carrier shall be accurate to within 2.5 ppm of the received frequency for mobile stations.

Limits	≤ 2.5 ppm
--------	-----------

### Measurement Uncertainty

The assessed measurement uncertainty to ensure 99.75% confidence level for the normal distribution is with the coverage factor  $k = 3$ ,  $U = 0.01\text{ppm}$ .



## Test Result

NB-IoT Band 5						
Condition		Freq.Error (Hz)	Freq.Error (Hz)	Frequency Stability(ppm)	Frequency Stability(ppm)	Verdict
Sub-carrier spacing (KHz)	3.75					
Temperature	Voltage	BPSK	QPSK	BPSK	QPSK	
Normal (25°C)	Normal	6.83	9.66	0.00817	0.01155	PASS
Extreme (75°C)		5.96	5.90	0.00712	0.00705	PASS
Extreme (70°C)		7.51	7.40	0.00898	0.00885	PASS
Extreme (60°C)		8.84	6.61	0.01057	0.00790	PASS
Extreme (50°C)		4.80	15.04	0.00573	0.01798	PASS
Extreme (40°C)		15.03	6.53	0.01797	0.00781	PASS
Extreme (30°C)		7.59	9.47	0.00908	0.01132	PASS
Extreme (20°C)		5.95	6.94	0.00711	0.00829	PASS
Extreme (10°C)		5.77	2.96	0.00689	0.00353	PASS
Extreme (0°C)		4.88	6.60	0.00583	0.00789	PASS
Extreme (-10°C)		17.41	6.94	0.02081	0.00830	PASS
Extreme (-20°C)		4.27	4.73	0.00510	0.00566	PASS
Extreme (-30°C)		1.46	9.54	0.00174	0.01141	PASS
Extreme (-35°C)		3.90	16.47	0.00466	0.01969	PASS
25°C	LV	13.90	8.81	0.01661	0.01053	PASS
	HV	3.92	16.53	0.00468	0.01976	PASS
Condition		Freq.Error (Hz)	Freq.Error (Hz)	Frequency Stability(ppm)	Frequency Stability(ppm)	Verdict
Sub-carrier spacing (KHz)	15					
Temperature	Voltage	BPSK	QPSK	BPSK	QPSK	
Normal (25°C)	Normal	5.89	13.90	0.00705	0.01661	PASS
Extreme (75°C)		9.23	17.79	0.01104	0.02127	PASS
Extreme (70°C)		5.01	7.69	0.00599	0.00920	PASS
Extreme (60°C)		1.73	14.02	0.00207	0.01676	PASS
Extreme (50°C)		9.95	9.35	0.01189	0.01118	PASS
Extreme (40°C)		8.47	12.88	0.01012	0.01540	PASS
Extreme (30°C)		1.39	9.73	0.00166	0.01163	PASS
Extreme (20°C)		14.54	11.97	0.01738	0.01431	PASS
Extreme (10°C)		12.66	14.54	0.01514	0.01738	PASS
Extreme (0°C)		16.88	11.38	0.02018	0.01360	PASS
Extreme (-10°C)		4.03	16.00	0.00482	0.01913	PASS
Extreme (-20°C)		14.46	2.03	0.01728	0.00243	PASS
Extreme (-30°C)		2.79	14.10	0.00333	0.01686	PASS



Extreme (-35°C)		2.32	6.71	0.00277	0.00802	PASS
25°C	LV	16.10	3.92	0.01925	0.00469	PASS
	HV	6.20	10.96	0.00741	0.01310	PASS

## 5.6. Spurious Emissions at Antenna Terminals

### Ambient condition

Temperature	Relative humidity	Pressure
23°C ~25°C	45%~50%	101.5kPa

### Method of Measurement

The EUT was connected to Spectrum Analyzer and Base Station Simulator via power Splitter. The measurement is carried out using a spectrum analyzer. The spectrum analyzer scans from 9kHz to the 10th harmonic of the carrier.

The peak detector is used. RBW are set to 100 kHz and VBW are set to 300 kHz for below 1G, RBW are set to 1MHz and VBW are set to 3MHz for above 1G, Sweep is set to ATUO.

RBW is set to 1 kHz (0.009MHz~ 0.15 MHz),

RBW is set to 10 kHz (0.15 MHz~ 30 MHz)

RBW is set to 100 kHz (30MHz~1000 MHz)

RBW is set to 1000 kHz (above 1000MHz)

The modulation mode and RB allocation refer to section 5.1, using the maximum output power configuration.

### Test setup

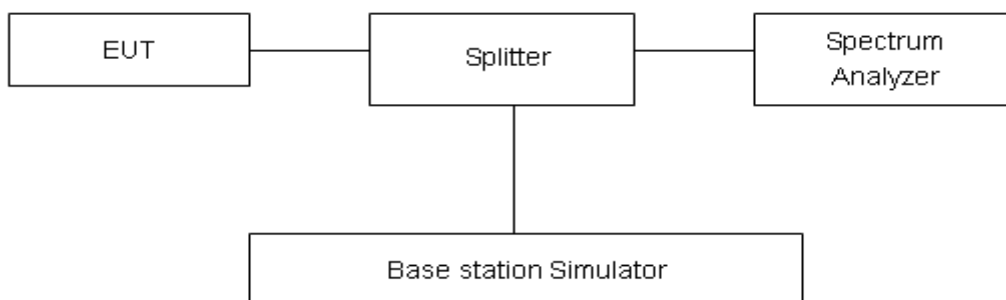

### Limits

Rule Part 22.917(a) specifies that “The power of any emission outside of the authorized operating frequency ranges must be attenuated below the transmitting power (P) by a factor of at least 43 + 10 log (P) dB.”

Limit	-13 dBm

### Measurement Uncertainty

The assessed measurement uncertainty to ensure 99.75% confidence level for the normal distribution is with the coverage factor  $k = 1.96$ .

Frequency	Uncertainty
9kHz-1GHz	0.684 dB
1GHz-18GHz	1.407 dB



### Test Result

Sweep the whole frequency band through the range from 9kHz to the 10th harmonic of the carrier, the emissions more than 20 dB below the limit are not reported.

The signal beyond the limit is carrier.

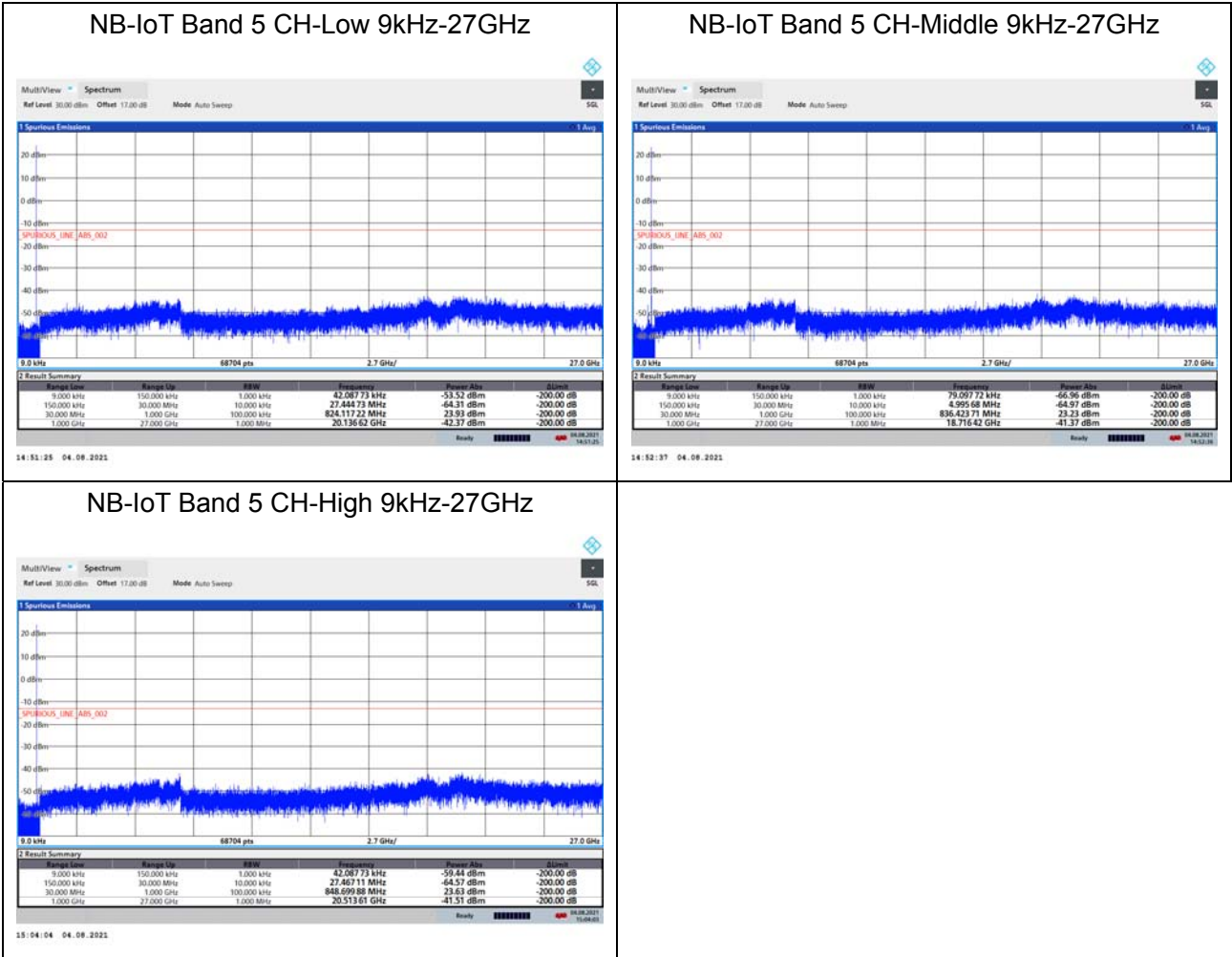



## 5.7. Radiates Spurious Emission

### Ambient condition

Temperature	Relative humidity	Pressure
23°C ~25°C	45%~50%	101.5kPa

### Method of Measurement

1. The testing follows FCC KDB 971168 v03r01 Section 5.8 and ANSI C63.26 (2015).
2. Below 1GHz: The EUT is placed on a turntable 0.8 meters above the ground in the chamber, 3 meter away from the antenna. The maximal emission value is acquired by adjusting the antenna height, polarisation and turntable azimuth. Normally, the height range of antenna is 1 m to 4 m, the azimuth range of turntable is 0° to 360°, and the receive antenna has two polarizations Vertical (V) and Horizontal (H). Above 1GHz: (Note: the FCC's permission to use 1.5m as an alternative per TCBC Conf call of Dec. 2, 2014.) The EUT is placed on a turntable 1.5 meters above the ground in the chamber, 3 meter away from the antenna. The maximal emission value is acquired by adjusting the antenna height, polarisation and turntable azimuth. Normally, the height range of antenna is 1 m to 4 m, the azimuth range of turntable is 0° to 360°, and the receive antenna has two polarizations Vertical (V) and Horizontal (H).
3. A loop antenna, A log-periodic antenna or horn antenna shall be substituted in place of the EUT. The log-periodic antenna will be driven by a signal generator and the level will be adjusted till the same power value on the spectrum analyzer or receiver. The level of the spurious emissions can be calculated through the level of the signal generator, cable loss, the gain of the substitution antenna and the reading of the spectrum analyzer or receiver.
4. The EUT is then put into continuously transmitting mode at its maximum power level during the test. Set Test Receiver or Spectrum RBW=100kHz,VBW=300kHz, and the maximum value of the receiver should be recorded as (Pr).
5. The EUT shall be replaced by a substitution antenna. In the chamber, an substitution antenna for the frequency band of interest is placed at the reference point of the chamber. An RF Signal source for the frequency band of interest is connected to the substitution antenna with a cable that has been constructed to not interfere with the radiation pattern of the antenna. A power (PMea) is applied to the input of the substitution antenna, and adjust the level of the signal generator output until the value of the receiver reach the previously recorded (Pr). The power of signal source (PMea) is recorded. The test should be performed by rotating the test item and adjusting the receiving antenna polarization.
6. A amplifier should be connected to the Signal Source output port. And the cable should be connect between the Amplifier and the Substitution Antenna. The cable loss (Pcl), the Substitution Antenna Gain (Ga) and the Amplifier Gain (PAg) should be recorded after test.
7. The measurement results are obtained as described below:  
Power(EIRP)=PMea- PAg - Pcl + Ga  
The measurement results are amend as described below:  
Power(EIRP)=PMea- Pcl + Ga
8. This value is EIRP since the measurement is calibrated using an antenna of known gain (2.15 dBi) and known input power. ERP can be calculated from EIRP by subtracting the gain of the dipole, ERP

= EIRP-2.15dBi.

The modulation mode and RB allocation refer to section 5.1, using the maximum output power configuration.

**Test setup**

**9KHz ~ 30MHz**

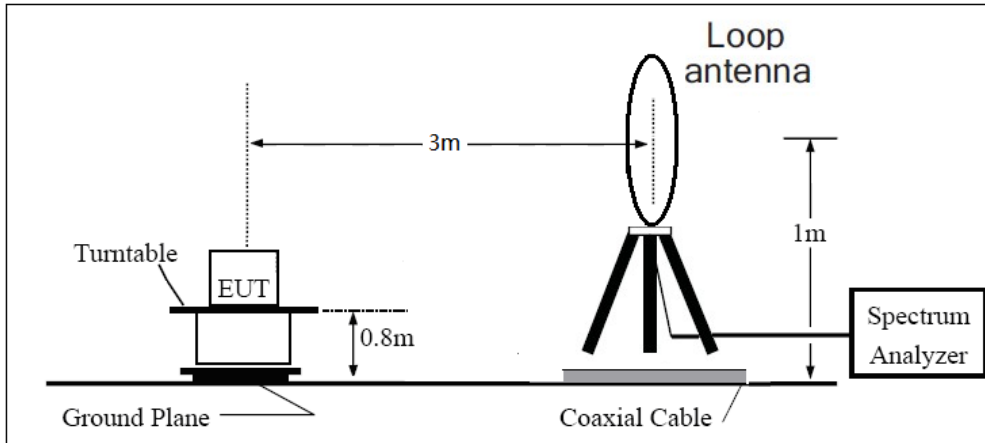

**30MHz ~ 1GHz**

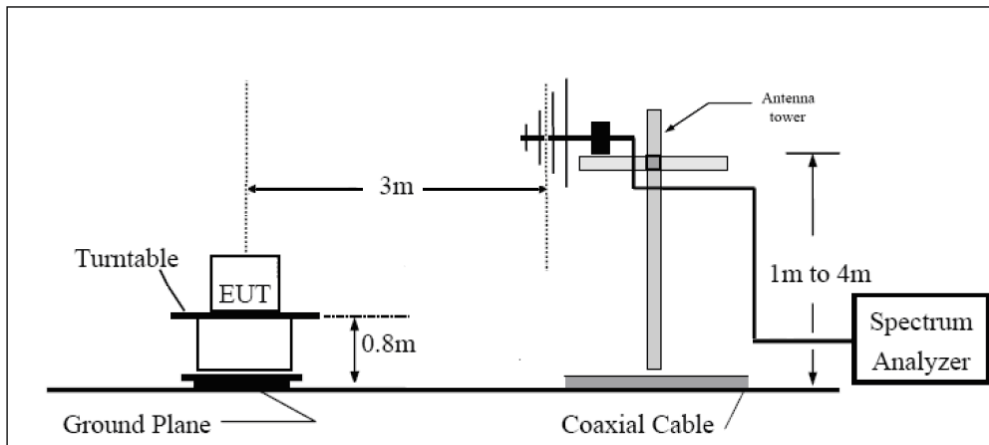

**Above 1GHz**

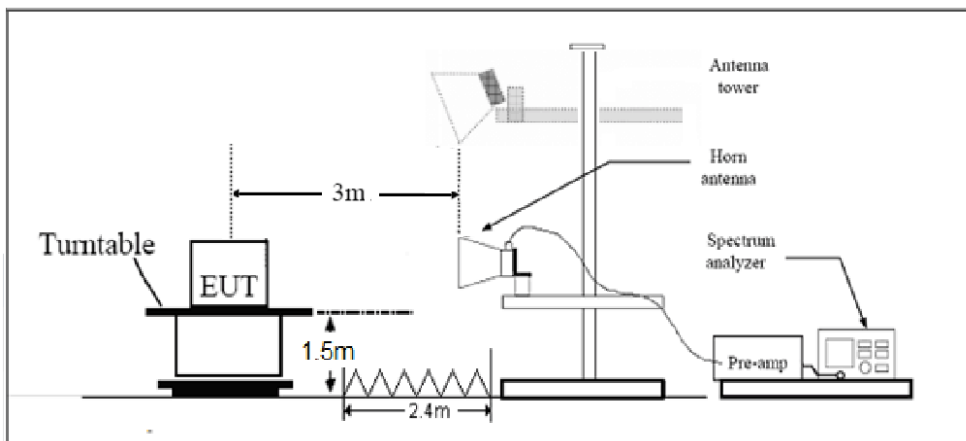

Note: Area side:2.4mX3.6m



### Limits

Rule Part 22.917(a) specifies that “The power of any emission outside of the authorized operating frequency ranges must be attenuated below the transmitting power (P) by a factor of at least  $43 + 10 \log (P)$  dB.”

Limit	-13 dBm
-------	---------

### Measurement Uncertainty

The assessed measurement uncertainty to ensure 95% confidence level for the normal distribution is with the coverage factor  $k = 1.96$ ,  $U = 3.55$  dB.

**Test Result**

Sweep the whole frequency band through the range from 9kHz to the 10th harmonic of the carrier, the emissions below the noise floor will not be recorded in the report.

## NB-IoT Band 5 3.75KHz BPSK CH-Low

Harmonic	Frequency (MHz)	SG (dBm)	Cable Loss (dB)	Gain (dBi)	Antenna Polarization	ERP Level (dBm)	Limit (dBm)	Margin (dB)	Azimuth (deg)
2	1648.20	-55.87	1.70	8.70	Vertical	-51.02	-13.00	38.02	270
3	2472.30	-62.84	2.30	12.00	Vertical	-55.29	-13.00	42.29	180
4	3296.40	-65.14	2.70	12.70	Vertical	-57.29	-13.00	44.29	315
5	4120.50	-61.02	3.00	12.50	Vertical	-53.67	-13.00	40.67	90
6	4944.60	-50.66	3.40	12.50	Vertical	-43.71	-13.00	30.71	0
7	5768.70	-55.61	3.40	12.80	Vertical	-48.36	-13.00	35.36	225
8	6592.80	-55.59	4.10	11.50	Vertical	-50.34	-13.00	37.34	225
9	7416.90	-55.12	4.20	12.20	Vertical	-49.27	-13.00	36.27	270
10	8241.00	-54.38	4.30	12.50	Vertical	-48.33	-13.00	35.33	135

Note: 1.The other Spurious RF Radiated emissions level is no more than noise floor.  
2.The worst emission was found in the antenna is Vertical position.

## NB-IoT Band5 3.75KHz BPSK CH-Middle

Harmonic	Frequency (MHz)	SG (dBm)	Cable Loss (dB)	Gain (dBi)	Antenna Polarization	ERP Level (dBm)	Limit (dBm)	Margin (dB)	Azimuth (deg)
2	1673.00	-52.43	1.70	8.70	Vertical	-47.58	-13.00	34.58	45
3	2509.50	-63.63	2.30	12.00	Vertical	-56.08	-13.00	43.08	315
4	3346.00	-65.99	2.70	12.70	Vertical	-58.14	-13.00	45.14	225
5	4182.50	-59.22	3.00	12.50	Vertical	-51.87	-13.00	38.87	180
6	5019.00	-47.88	3.40	12.50	Vertical	-40.93	-13.00	27.93	45
7	5855.50	-55.41	3.40	12.80	Vertical	-48.16	-13.00	35.16	315
8	6692.00	-56.80	4.10	11.50	Vertical	-51.55	-13.00	38.55	90
9	7528.50	-57.45	4.20	12.20	Vertical	-51.60	-13.00	38.60	315
10	8365.00	-55.54	4.30	12.50	Vertical	-49.49	-13.00	36.49	315

Note: 1.The other Spurious RF Radiated emissions level is no more than noise floor.  
2.The worst emission was found in the antenna is Vertical position.



## NB-IoT Band5 3.75KHz BPSK CH-High

Harmonic	Frequency (MHz)	SG (dBm)	Cable Loss (dB)	Gain (dBi)	Antenna Polarization	ERP Level (dBm)	Limit (dBm)	Margin (dB)	Azimuth (deg)
2	1697.80	-50.90	1.70	8.70	Vertical	-46.05	-13.00	33.05	90
3	2546.70	-62.94	2.30	12.00	Vertical	-55.39	-13.00	42.39	315
4	3395.60	-67.53	2.70	12.70	Vertical	-59.68	-13.00	46.68	270
5	4244.50	-59.49	3.00	12.50	Vertical	-52.14	-13.00	39.14	135
6	5093.40	-45.93	3.40	12.50	Vertical	-38.98	-13.00	25.98	225
7	5942.30	-54.24	3.40	12.80	Vertical	-46.99	-13.00	33.99	180
8	6791.20	-57.38	4.10	11.50	Vertical	-52.13	-13.00	39.13	45
9	7640.10	-54.97	4.20	12.20	Vertical	-49.12	-13.00	36.12	315
10	8489.00	-57.87	4.30	12.50	Vertical	-51.82	-13.00	38.82	90

Note: 1.The other Spurious RF Radiated emissions level is no more than noise floor.

2.The worst emission was found in the antenna is Vertical position.



## 6. Main Test Instruments

Name	Manufacturer	Type	Serial Number	Calibration Date	Expiration Date
Base Station Simulator	R&S	CMW500	113645	2021-05-15	2022-05-14
Power Splitter	Hua Xiang	SHX-GF2-2-13	10120101	/	/
Spectrum Analyzer	Key sight	N9010A	MY50210259	2020-05-18	2022-05-14
Universal Radio Communication Tester	Key sight	E5515C	MY48367192	2021-05-15	2022-05-14
Signal Analyzer	R&S	FSV3030	101411	2020-12-13	2021-12-12
Loop Antenna	SCHWARZBECK	FMZB1519	1519-047	2020-04-02	2023-04-01
TRILOG Broadband Antenna	SCHWARZBECK	VULB 9163	391	2019-12-16	2021-12-15
Horn Antenna	R&S	HF907	102723	2018-08-11	2021-08-10
Horn Antenna	ETS-Lindgren	3160-09	00102643	2018-06-20	2023-06-19
Signal generator	R&S	SMB 100A	180235	2021-05-15	2022-05-14
Climatic Chamber	ESPEC	SU-242	93000506	2020-12-13	2021-12-12
Preamplifier	R&S	SCU18	102327	2021-05-15	2022-05-14
MOB COMMS DC SUPPLY	Keysight	66319D	MY43004105	2021-05-15	2022-05-14
Software	R&S	EMC32	9.26.0	/	/
Wireless Test Set	StarPoint	SP8315	SP8315-1202	2021-05-15	2022-05-14
Wireless Test Set	StarPoint	SP8315	SP8315-1203	2021-05-15	2022-05-14

\*\*\*\*\*END OF REPORT \*\*\*\*\*



## ANNEX A: The EUT Appearance

The EUT Appearance are submitted separately.



## **ANNEX B: Test Setup Photos**

The Test Setup Photos are submitted separately.





## ANNEX C: Product Change Description

The Product Change Description are submitted separately.