

RF TEST REPORT

Applicant Quectel Wireless Solutions Co., Ltd.

FCC ID XMR2022BG772AGL

Product LTE Cat M1 & Cat NB2 Module

Brand Quectel

Model BG772A-GL

Report No. R2301A0034-R5

Issue Date July 18, 2023

TA Technology (Shanghai) Co., Ltd. tested the above equipment in accordance with the requirements in **FCC CFR47 Part 2 (2022)/ FCC CFR 47 Part 24E (2022)**. The test results show that the equipment tested is capable of demonstrating compliance with the requirements as documented in this report.

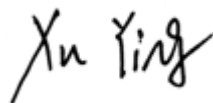

Prepared by: Xu Ying

Approved by: Xu Kai

TA Technology (Shanghai) Co., Ltd.

Building 3, No.145, Jintang Rd, Pudong Shanghai, P.R.China

TEL: +86-021-50791141/2/3

FAX: +86-021-50791141/2/3-8000

TABLE OF CONTENT

1. Test Laboratory	5
1.1. Notes of the test report.....	5
1.2. Test facility	5
1.3. Testing Location	5
2. General Description of Equipment under Test.....	6
2.1. Applicant and Manufacturer Information.....	6
2.2. General information.....	6
3. Applied Standards	7
4. Test Configuration	8
5. Test Case	9
5.1. RF Power Output and Effective Isotropic Radiated Power	9
5.2. Occupied Bandwidth	10
5.3. Band Edge Compliance.....	11
5.4. Peak-to-Average Power Ratio (PAPR).....	12
5.5. Frequency Stability.....	13
5.6. Spurious Emissions at Antenna Terminals.....	15
5.7. Radiated Spurious Emission	16
6. Test Results	19
6.1. RF Power Output and Effective Isotropic Radiated Power	19
6.2. Occupied Bandwidth	20
6.3. Band Edge Compliance.....	27
6.4. Peak-to-Average Power Ratio (PAPR).....	31
6.5. Frequency Stability.....	32
6.6. Spurious Emissions at Antenna Terminals.....	34
6.7. Radiated Spurious Emission	35
7. Main Test Instruments.....	38
ANNEX A: The EUT Appearance	39
ANNEX B: Test Setup Photos	40
ANNEX C: Product Change Description (Variant 1)	41
ANNEX D: Product Change Description (Variant 2)	42

Summary of measurement results

No.	Test Case	Clause in FCC rules	Verdict
1	RF Power Output and Effective Isotropic Radiated Power	2.1046 24.232(c)	PASS
2	Occupied Bandwidth	2.1049	PASS
3	Band Edge Compliance	2.1051 /24.238(a)	PASS
4	Peak-to-Average Power Ratio	24.232/KDB 971168 D01(5.7)	PASS
5	Frequency Stability	2.1055 / 24.235	PASS
6	Spurious Emissions at Antenna Terminals	2.1051 / 24.238(a)	PASS
7	Radiated Spurious Emission	2.1053 / 24.238(a)	PASS
Date of Testing: April 21, 2021 ~ May 14, 2021			
Date of Sample Received: April 16, 2021			
Note: PASS: The EUT complies with the essential requirements in the standard. FAIL: The EUT does not comply with the essential requirements in the standard. All indications of Pass/Fail in this report are opinions expressed by TA Technology (Shanghai) Co., Ltd. based on interpretations and/or observations of test results. Measurement Uncertainties were not taken into account and are published for informational purposes only.			

BG772A-GL (Report No.: R2301A0034-R5) is a variant model (Variant 2) of BG772A-GL (Report No.: R2112A1193-R5). BG772A-GL supports from Cat NB1 (3GPP R13) to Cat NB2 (3GPP R14) only by FW updating, the hardware remains the same.

The detailed product change description please refers to following table:

Module	BG772A-GL (Cat NB1)	BG772A-GL (Cat NB2)
Category	Cat M1 & NB1	Cat M1 & NB2
Frequency Bands	Cat M1 Band 2/4/5/12/13/25/26/66 Cat NB1 Band 2/4/5/12/13/17/25/66	Cat M1 Band 2/4/5/12/13/25/26/66 Cat NB2 Band 2/4/5/12/13/17/25/66
Software Version	BG772AGLAAR01A03	BG772AGLAAR02A01
Product Name	LTE Module	LTE Cat M1 & Cat NB2 Module
Others	The same	

There is only verified RF Power Output, Band Edge Compliance and Spurious Emissions at Antenna Terminals, and did not worsen, so they were not recorded in the report.

Powers of new variant are varied due to measurement uncertainty, and sample tolerance of the acceptance range.

The detailed product change description please refers to the *Difference Declaration Letter (Variant 2)*.

BG772A-GL (Report No.: R2112A1193-R5) is a variant model (Variant 1) of BG770A-GL (Report No.: R2104A0331-R5). Test values partial duplicated from Original for variant. There is no test for variant in this report.

The detailed product change description please refers to the *Difference Declaration Letter (Variant 1)*.

1. Test Laboratory

1.1. Notes of the test report

This report shall not be reproduced in full or partial, without the written approval of **TA Technology (Shanghai) Co., Ltd.** The results documented in this report apply only to the tested sample, under the conditions and modes of operation as described herein .Measurement Uncertainties were not taken into account and are published for informational purposes only. This report is written to support regulatory compliance of the applicable standards stated above.

1.2. Test facility

FCC (Designation number: CN1179, Test Firm Registration Number: 446626)

TA Technology (Shanghai) Co., Ltd. has been listed on the US Federal Communications Commission list of test facilities recognized to perform measurements.

A2LA (Certificate Number: 3857.01)

TA Technology (Shanghai) Co., Ltd. has been listed by American Association for Laboratory Accreditation to perform measurement.

1.3. Testing Location

Company: TA Technology (Shanghai) Co., Ltd.
 Address: Building 3, No.145, Jintang Rd, Pudong Shanghai, P.R.China
 City: Shanghai
 Post code: 201201
 Country: P. R. China
 Contact: Xu Kai
 Telephone: +86-021-50791141/2/3
 Fax: +86-021-50791141/2/3-8000
 Website: <http://www.ta-shanghai.com>
 E-mail: xukai@ta-shanghai.com

2. General Description of Equipment under Test

2.1. Applicant and Manufacturer Information

Applicant	Quectel Wireless Solutions Co., Ltd
Applicant address	Building 5, Shanghai Business Park Phase III (Area B), No.1016 Tianlin Road, Minhang District, Shanghai, 200233 China
Manufacturer	Quectel Wireless Solutions Co., Ltd
Manufacturer address	Building 5, Shanghai Business Park Phase III (Area B), No.1016 Tianlin Road, Minhang District, Shanghai, 200233 China

2.2. General information

EUT Description			
Model	BG772A-GL		
IMEI	Original	863593050006733	
Hardware Version	R1.1		
Software Version	BG772AGLAAR02A01		
Power Supply	External power supply		
Antenna Type	External Antenna		
Antenna Gain	Band	Frequency (MHz)	Gain (dBi)
	NB-IoT Band 2/25	1840	1.36
		1860	1.25
		1880	1.38
		1900	1.59
1920		1.36	
Test Mode(s)	NB-IoT Band 2/25		
Test Modulation	BPSK, QPSK		
Category	NB2		
Deployment	stand-alone, In-band, Guard-band		
Sub-carrier spacing	3.75KHz, 15KHz		
Ntones	single-tone, multi-tone		
Maximum E.I.R.P	NB-IoT Band 2	25.34 dBm	
	NB-IoT Band 25	25.21 dBm	
Rated Power Supply Voltage	3.3V		
Operating Voltage	Minimum: 3.1V	Maximum: 4.2V	
Operating Temperature	Lowest: -35°C	Highest: +75°C	
Testing Temperature	Lowest: -30°C	Highest: +50°C	
Frequency Range(s)	Band	Tx (MHz)	Rx (MHz)
	NB-IoT Band 2	1850 ~ 1910	1930 ~ 1990
	NB-IoT Band 25	1850 ~ 1915	1930 ~ 1995
Note: 1. The EUT is sent from the applicant to TA and the information of the EUT is declared by the applicant.			

3. Applied Standards

According to the specifications of the manufacturer, it must comply with the requirements of the following standards:

Test standards:

FCC CFR 47 Part 24E (2022)

FCC CFR47 Part 2 (2022)

Reference standard:

ANSI C63.26-2015

KDB 971168 D01 Power Meas License Digital Systems v03r01

4. Test Configuration

Radiated measurements are performed by rotating the EUT in three different orthogonal test planes. EUT polarization (horizontal and vertical). Receiver antenna polarization (horizontal and vertical), the worst emission was found in position (horizontal polarization, horizontal polarization) and the worst case was recorded.

All modes as Subcarrier Spacing, modulations, Channel were investigated.

Subsequently, only the worst case emissions are reported.

The following testing in NB-IoT is set based on the maximum RF Output Power.

Test modes are chosen to be reported as the worst case configuration below for NB-IoT Band 2/25

Test items	Mode	Deployment mode	Subcarrier Spacing (kHz)		Modulation		Test Channel		
		Stand-alone	3.75	15	BPSK	QPSK	L	M	H
RF Power Output and Effective Isotropic Radiated Power	NB-IoT B2	O	O	O	O	O	O	O	O
	NB-IoT B25	O	O	O	O	O	O	O	O
Occupied Bandwidth	NB-IoT B2	O	O	O	O	O	O	O	O
	NB-IoT B25	O	O	O	O	O	O	O	O
Band Edge Compliance	NB-IoT B2	O	O	O	O	O	O	-	O
	NB-IoT B25	O	O	O	O	O	O	-	O
Peak-to-Average Power Ratio	NB-IoT B2	O	O	O	O	O	-	O	-
	NB-IoT B25	O	O	O	O	O	-	O	-
Frequency Stability	NB-IoT B2	O	O	O	O	O	-	O	-
	NB-IoT B25	O	O	O	O	O	-	O	-
Spurious Emissions at Antenna Terminals	NB-IoT B2	O	-	O	-	O	O	O	O
	NB-IoT B25	O	-	O	-	O	O	O	O
Radiated Spurious Emission	NB-IoT B2	O	-	O	-	O	O	O	O
	NB-IoT B25	O	-	O	-	O	O	O	O

Note

1. The mark "O" means that this configuration is chosen for testing.
2. The mark "-" means that this configuration is not testing.

5. Test Case

5.1. RF Power Output and Effective Isotropic Radiated Power

Ambient condition

Temperature	Relative humidity	Pressure
23°C ~25°C	45%~50%	101.5kPa

Methods of Measurement

During the process of the testing, The EUT was connected to the Base Station Simulator with a known loss. The EUT is controlled by the Base Station Simulator test set to ensure max power transmission with proper modulation.

ERP can then be calculated as follows:

$$\text{EIRP (dBm)} = \text{Output Power (dBm)} + \text{Antenna Gain (dBi)}$$

$$\text{EIRP (dBm)} = \text{ERP (dBm)} + 2.15 \text{ (dB.)}$$

Test Setup

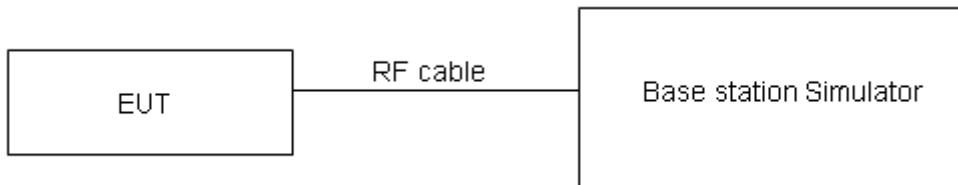

Limits

No specific RF power output requirements in part 2.1046.

Rule Part 24.232(c) Mobile and portable stations are limited to 2 watts EIRP.

Rule Part 24.232(e) Peak transmit power must be measured over any interval of continuous transmission using instrumentation calibrated in terms of an rms-equivalent voltage.

Limit	$\leq 2 \text{ W}$ (33 dBm)
-------	-----------------------------

Measurement Uncertainty

The assessed measurement uncertainty to ensure 95% confidence level for the normal distribution is with the coverage factor $k = 2$, $U = 0.4 \text{ dB}$ for RF power output, $k = 2$, $U = 1.19 \text{ dB}$ for EIRP.

Test Results

Refer to the section 6.1 of this report for test data.

5.2. Occupied Bandwidth

Ambient condition

Temperature	Relative humidity	Pressure
23°C ~25°C	45%~50%	101.5kPa

Method of Measurement

The EUT was connected to Spectrum Analyzer and Base Station Simulator via power Splitter. The occupied bandwidth is measured using spectrum analyzer.

RBW is set to $\geq 1\%EBW$, VBW is set to 3x RBW.

99% power and -26dBc occupied bandwidths are recorded. Spectrum analyzer plots are included on the following pages.

Test Setup

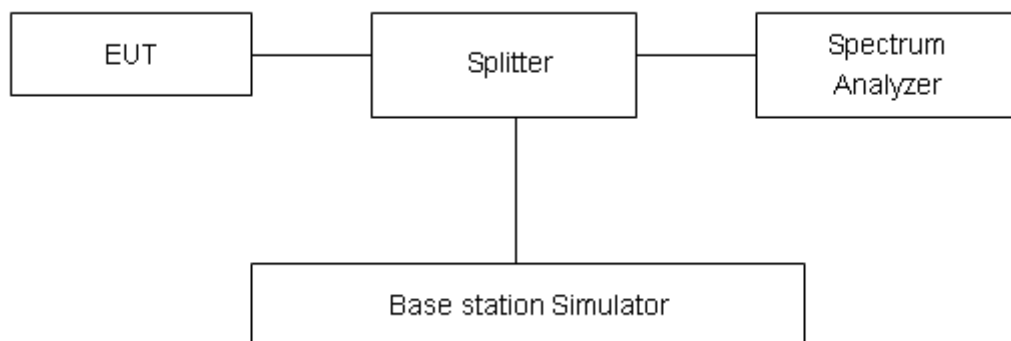

Limits

No specific occupied bandwidth requirements in part 2.1049.

Measurement Uncertainty

The assessed measurement uncertainty to ensure 95% confidence level for the normal distribution is with the coverage factor $k = 2$, $U = 624\text{Hz}$.

Test Results

Refer to the section 6.2 of this report for test data.

5.3. Band Edge Compliance

Ambient condition

Temperature	Relative humidity	Pressure
23°C ~25°C	45%~50%	101.5kPa

Method of Measurement

The EUT was connected to Spectrum Analyzer and Base Station Simulator via power Splitter. The band edge of the lowest and highest channels were measured. The Average detector is used and RBW is set to $\geq 1\%EBW$, VBW is set to 3x RBW.

Spectrum analyzer plots are included on the following pages.

Test Setup

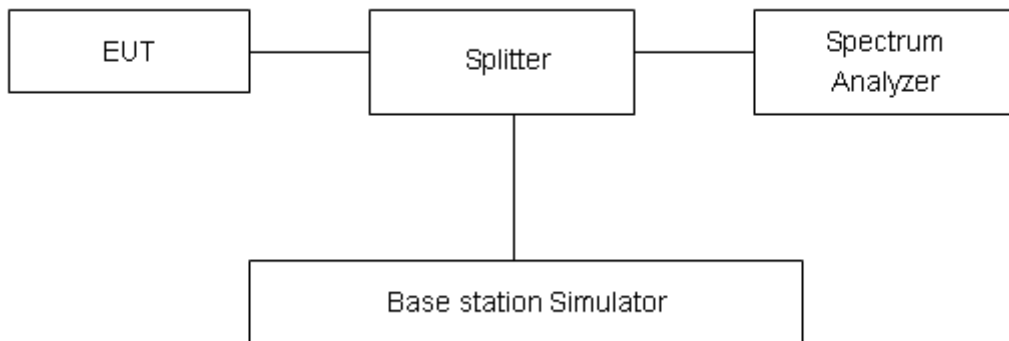

Limits

Rule Part 24.238(a) specifies that “on any frequency outside a licensee's frequency block, the power of any emission shall be attenuated below the transmitter power (P) by at least $43 + 10 \log_{10} (P)$ dB.”

Limit	-13 dBm
-------	---------

Measurement Uncertainty

The assessed measurement uncertainty to ensure 95% confidence level for the normal distribution is with the coverage factor $k = 1.96$, $U=0.684dB$.

Test Results

Refer to the section 6.3 of this report for test data.

5.4. Peak-to-Average Power Ratio (PAPR)

Ambient condition

Temperature	Relative humidity	Pressure
23°C ~25°C	45%~50%	101.5kPa

Methods of Measurement

Measure the total peak power and record as PPK. And measure the total average power and record as PAvg. Both the peak and average power levels must be expressed in the same logarithmic units (e.g., dBm). Determine the PAPR from:

$$PAPR (dB) = PPk (dBm) - PAvg (dBm).$$

Test Setup

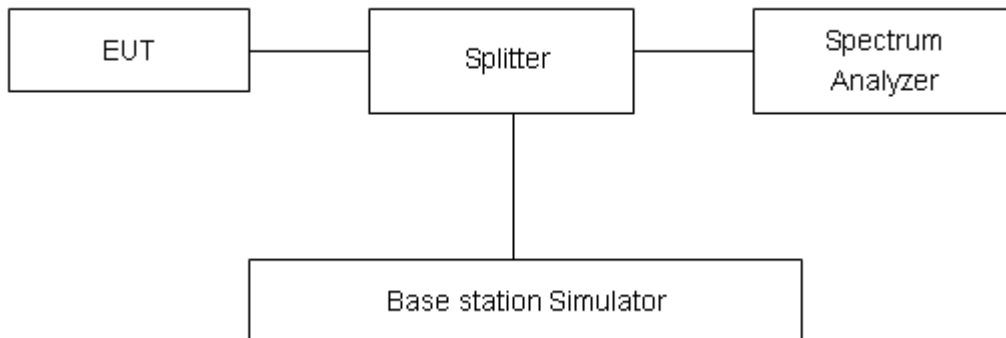

Limits

In measuring transmissions in this band using an average power technique, the peak-to-average ratio (PAR) of the transmission may not exceed 13 dB in 24.232(d).

Measurement Uncertainty

The assessed measurement uncertainty to ensure 95% confidence level for the normal distribution is with the coverage factor $k = 2$, $U = 0.4$ dB.

Test Results

Refer to the section 6.4 of this report for test data.

5.5. Frequency Stability

Ambient condition

Temperature	Relative humidity	Pressure
23°C ~25°C	45%~50%	101.5kPa

Method of Measurement

Frequency Stability (Temperature Variation)

The temperature inside the climate chamber is varied from -30°C to +50°C in 10°C step size,

(1) With all power removed, the temperature was decreased to 0°C and permitted to stabilize for three hours.

(2) Measure the carrier frequency with the test equipment in a “call mode”. These measurements should be made within 1 minute of powering up the mobile station, to prevent significant self warming.

(3) Repeat the above measurements at 10°C increments from -30°C to +50°C. Allow at least 1.5 hours at each temperature, un-powered, before making measurements.

Frequency Stability (Voltage Variation)

The frequency stability shall be measured with variation of primary supply voltage as follows:

Primary Supply Voltage: The primary supply voltage is varied from 85% to 115% of the nominal value for non hand-carried battery and AC powered equipment. For hand-carried, battery-powered equipment, primary supply voltage is reduced to the battery operating end point which shall be specified by the manufacturer.

This transceiver is specified to operate with an input voltage of between 3.1 V and 4.2 V, with a nominal voltage of 3.3V.

Test setup

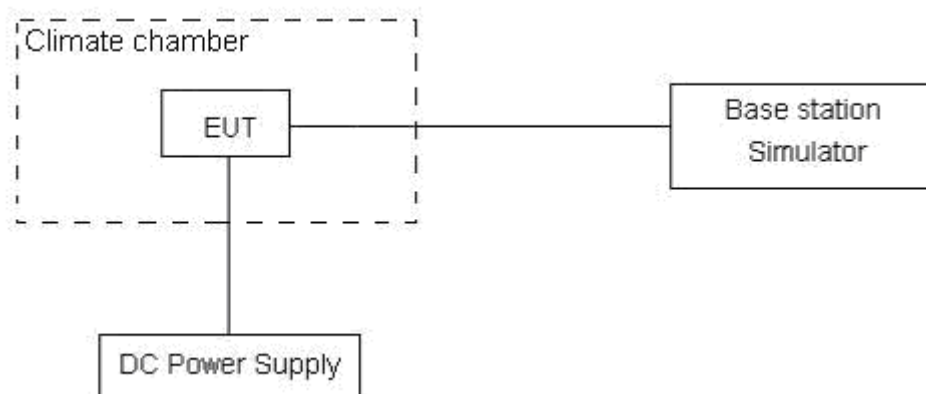

Limits

The frequency stability shall be sufficient to ensure that the fundamental emission stays within the authorized frequency block

Measurement Uncertainty

The assessed measurement uncertainty to ensure 99.75% confidence level for the normal distribution is with the coverage factor $k = 3$, $U = 0.01\text{ppm}$.

Test Results

Refer to the section 6.5 of this report for test data.

5.6. Spurious Emissions at Antenna Terminals

Ambient condition

Temperature	Relative humidity	Pressure
23°C ~25°C	45%~50%	101.5kPa

Method of Measurement

The EUT was connected to Spectrum Analyzer and Base Station Simulator via power Splitter. The measurement is carried out using a spectrum analyzer. The spectrum analyzer scans from 9kHz to the 10th harmonic of the carrier. The peak detector is used.

RBW is set to 1 kHz (0.009MHz~ 0.15 MHz),

RBW is set to 10 kHz (0.15 MHz~ 30 MHz)

RBW is set to 100 kHz (30MHz~1000 MHz)

RBW is set to 1000 kHz (above 1000MHz)

Sweep is set to ATUO.

The modulation mode and RB allocation refer to section 5.1, using the maximum output power configuration.

Test setup

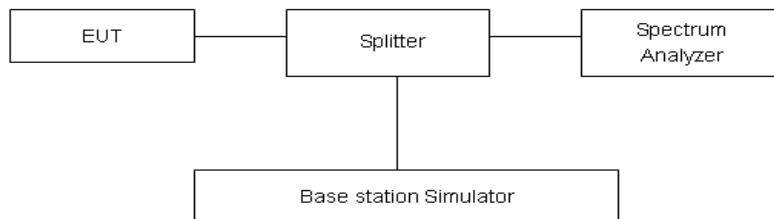

Limits

Rule Part 24.238(a) specifies that “on any frequency outside a licensee's frequency block, the power of any emission shall be attenuated below the transmitter power (P) by at least $43 + 10 \log_{10} (P)$ dB.”

Limit	-13 dBm
-------	---------

Measurement Uncertainty

The assessed measurement uncertainty to ensure 99.75% confidence level for the normal distribution is with the coverage factor $k = 1.96$.

Frequency	Uncertainty
9kHz-1GHz	0.684 dB
1GHz-20GHz	1.407 dB

Test Results

Refer to the section 6.6 of this report for test data.

5.7. Radiated Spurious Emission

Ambient condition

Temperature	Relative humidity	Pressure
23°C ~25°C	45%~50%	101.5kPa

Method of Measurement

1. The testing follows FCC KDB 971168 v03r01 Section 5.8 and ANSI C63.26-2015.
2. Below 1GHz: The EUT is placed on a turntable 0.8 meters above the ground in the chamber, 3 meter away from the antenna. The maximal emission value is acquired by adjusting the antenna height, polarisation and turntable azimuth. Normally, the height range of antenna is 1 m to 4 m, the azimuth range of turntable is 0° to 360°, and the receive antenna has two polarizations Vertical (V) and Horizontal (H). Above 1GHz: (Note: the FCC's permission to use 1.5m as an alternative per TCBC Conf call of Dec. 2, 2014.) The EUT is placed on a turntable 1.5 meters above the ground in the chamber, 3 meter away from the antenna. The maximal emission value is acquired by adjusting the antenna height, polarisation and turntable azimuth. Normally, the height range of antenna is 1 m to 4 m, the azimuth range of turntable is 0° to 360°, and the receive antenna has two polarizations Vertical (V) and Horizontal (H).
3. A loop antenna, A log-periodic antenna or horn antenna shall be substituted in place of the EUT. The log-periodic antenna will be driven by a signal generator and the level will be adjusted till the same power value on the spectrum analyzer or receiver. The level of the spurious emissions can be calculated through the level of the signal generator, cable loss, the gain of the substitution antenna and the reading of the spectrum analyzer or receiver.
4. The EUT is then put into continuously transmitting mode at its maximum power level during the test. Set Test Receiver or Spectrum RBW=1MHz, VBW=3MHz, and the maximum value of the receiver should be recorded as (Pr).
5. The EUT shall be replaced by a substitution antenna. In the chamber, an substitution antenna for the frequency band of interest is placed at the reference point of the chamber. An RF Signal source for the frequency band of interest is connected to the substitution antenna with a cable that has been constructed to not interfere with the radiation pattern of the antenna. A power (PMea) is applied to the input of the substitution antenna, and adjust the level of the signal generator output until the value of the receiver reach the previously recorded (Pr). The power of signal source (PMea) is recorded. The test should be performed by rotating the test item and adjusting the receiving antenna polarization.
6. A amplifier should be connected to the Signal Source output port. And the cable should be connect between the Amplifier and the Substitution Antenna. The cable loss (Pcl) ,the Substitution Antenna Gain (Ga) and the Amplifier Gain (PAg) should be recorded after test.
7. The measurement results are obtained as described below:

$$\text{Power(EIRP)} = \text{PMea} - \text{PAg} - \text{Pcl} + \text{Ga}$$
 The measurement results are amend as described below:

$$\text{Power(EIRP)} = \text{PMea} - \text{Pcl} + \text{Ga}$$
8. This value is EIRP since the measurement is calibrated using an antenna of known gain (2.15 dB) and known input power. ERP can be calculated from EIRP by subtracting the gain of the dipole, ERP

= EIRP-2.15dB.

The modulation mode and RB allocation refer to section 5.1, using the maximum output power configuration.

Test setup

9KHz~ 30MHz

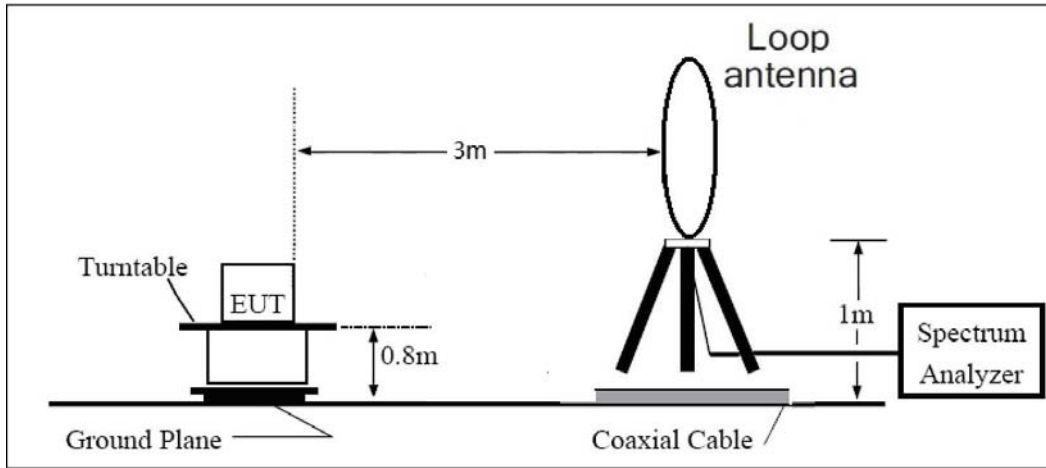

30MHz~ 1GHz

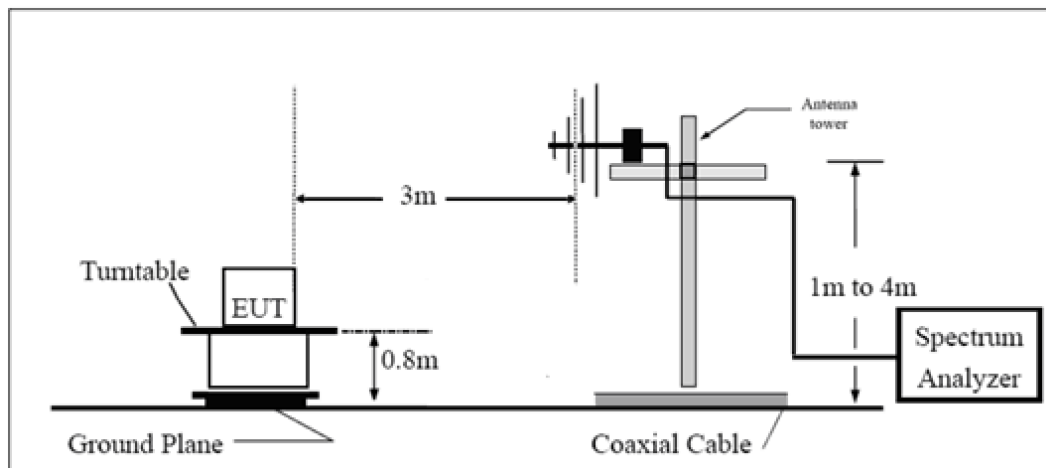

Above 1GHz

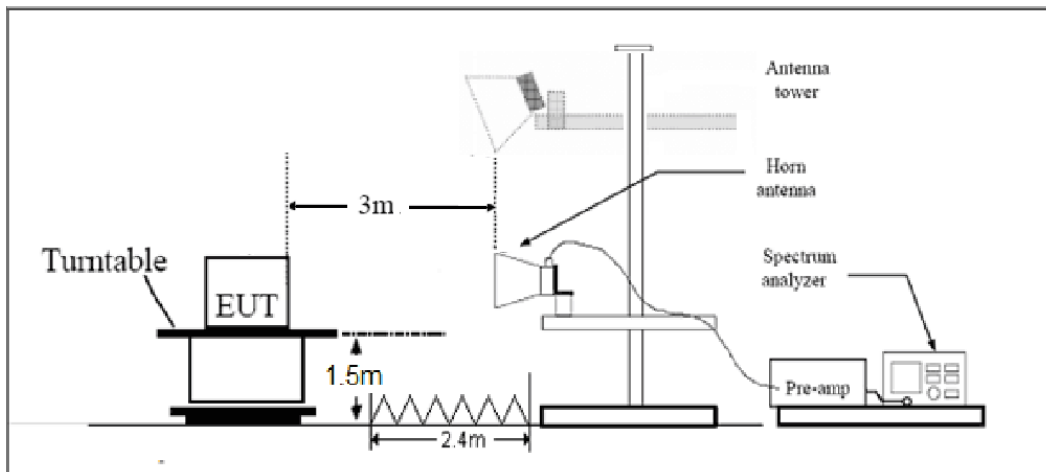

Note: Area side: 2.4mX3.6m

Limits

Rule Part 24.238(a) specifies that “on any frequency outside a licensee's frequency block, the power of any emission shall be attenuated below the transmitter power (P) by at least $43 + 10 \log_{10} (P)$ dB.”

Limit	-13 dBm
-------	---------

Measurement Uncertainty

The assessed measurement uncertainty to ensure 95% confidence level for the normal distribution is with the coverage factor $k = 1.96$, $U = 3.55$ dB.

Test Results

Refer to the section 6.7 of this report for test data.

6. Test Results

6.1. RF Power Output and Effective Isotropic Radiated Power

Mode	Modulation	Sub-carrier spacing (KHz)	Ntones	Maximum Output Power (dBm) for low/middle/high channel			EIRP (dBm)		
				18602 /1850.2MHz	18900 /1880.0MHz	19198 /1909.8MHz	18602 /1850.2MHz	18900 /1880.0MHz	19198 /1909.8MHz
NB-IoT Band 2	BPSK	3.75	1@0	23.71	23.66	23.52	24.96	25.04	25.11
			1@47	23.68	23.67	23.48	24.93	25.05	25.07
		15	1@0	23.59	23.71	23.61	24.84	25.09	25.20
			1@11	23.61	23.67	23.75	24.86	25.05	25.34
	QPSK	3.75	1@0	23.71	23.65	23.51	24.96	25.03	25.10
			1@47	23.68	23.63	23.50	24.93	25.01	25.09
		15	1@0	23.49	23.52	23.69	24.74	24.90	25.28
			1@11	23.66	23.75	23.73	24.91	25.13	25.32
		15	12@0	21.85	21.93	22.00	23.10	23.31	23.59

Mode	Modulation	Sub-carrier spacing (KHz)	Ntones	Maximum Output Power (dBm) for low/middle/high channel			EIRP (dBm)		
				26042 /1850.2MHz	26365 /1882.5MHz	26688 /1914.8MHz	26042 /1850.2MHz	26365 /1882.5MHz	26688 /1914.8MHz
NB-IoT Band 25	BPSK	3.75	1@0	23.71	23.67	23.42	24.96	25.05	24.78
			1@47	23.69	23.66	23.43	24.94	25.04	24.79
		15	1@0	23.68	23.73	23.79	24.93	25.11	25.15
			1@11	23.58	23.66	23.80	24.83	25.04	25.16
	QPSK	3.75	1@0	23.72	23.63	23.42	24.97	25.01	24.78
			1@47	23.68	23.63	23.40	24.93	25.01	24.76
		15	1@0	23.48	23.58	23.63	24.73	24.96	24.99
			1@11	23.65	23.61	23.85	24.90	24.99	25.21
		15	12@0	21.86	21.92	22.04	23.11	23.30	23.40

6.2. Occupied Bandwidth

Mode	Modulation	Sub-carrier spacing (KHz)	Ntones	Bandwidth(KHz) for low/mid/high channel					
				18602/1850.2 MHz		18900/1880.0 MHz		19198/1909.8 MHz	
				99% Power	-26dBc	99% Power	-26dBc	99% Power	-26dBc
Band 2 Standalone	BPSK	3.75	1@0	40.45	38.50	40.38	38.27	39.90	38.20
	QPSK	3.75	1@0	44.83	42.07	42.90	42.36	42.73	41.70
	BPSK	15	1@0	75.16	92.78	74.45	92.27	72.04	88.46
	QPSK	15	1@0	73.58	102.70	74.54	99.83	73.45	101.40
	QPSK	15	12@0	186.04	253.40	185.27	241.50	185.69	264.80
Mode	Modulation	Sub-carrier spacing (KHz)	Ntones	Bandwidth(KHz) for low/mid/high channel					
				26042/1850.2 MHz		26365/1882.5 MHz		26688/1914.8 MHz	
				99% Power	-26dBc	99% Power	-26dBc	99% Power	-26dBc
Band 25 Standalone	BPSK	3.75	1@0	40.66	38.11	41.25	38.04	39.66	37.28
	QPSK	3.75	1@0	43.06	41.67	44.34	41.65	42.03	39.32
	BPSK	15	1@0	74.60	92.74	76.67	100.70	75.02	92.31
	QPSK	15	1@0	74.08	100.80	73.97	102.20	78.40	102.90
	QPSK	15	12@0	184.74	265.40	184.63	265.30	184.54	251.90

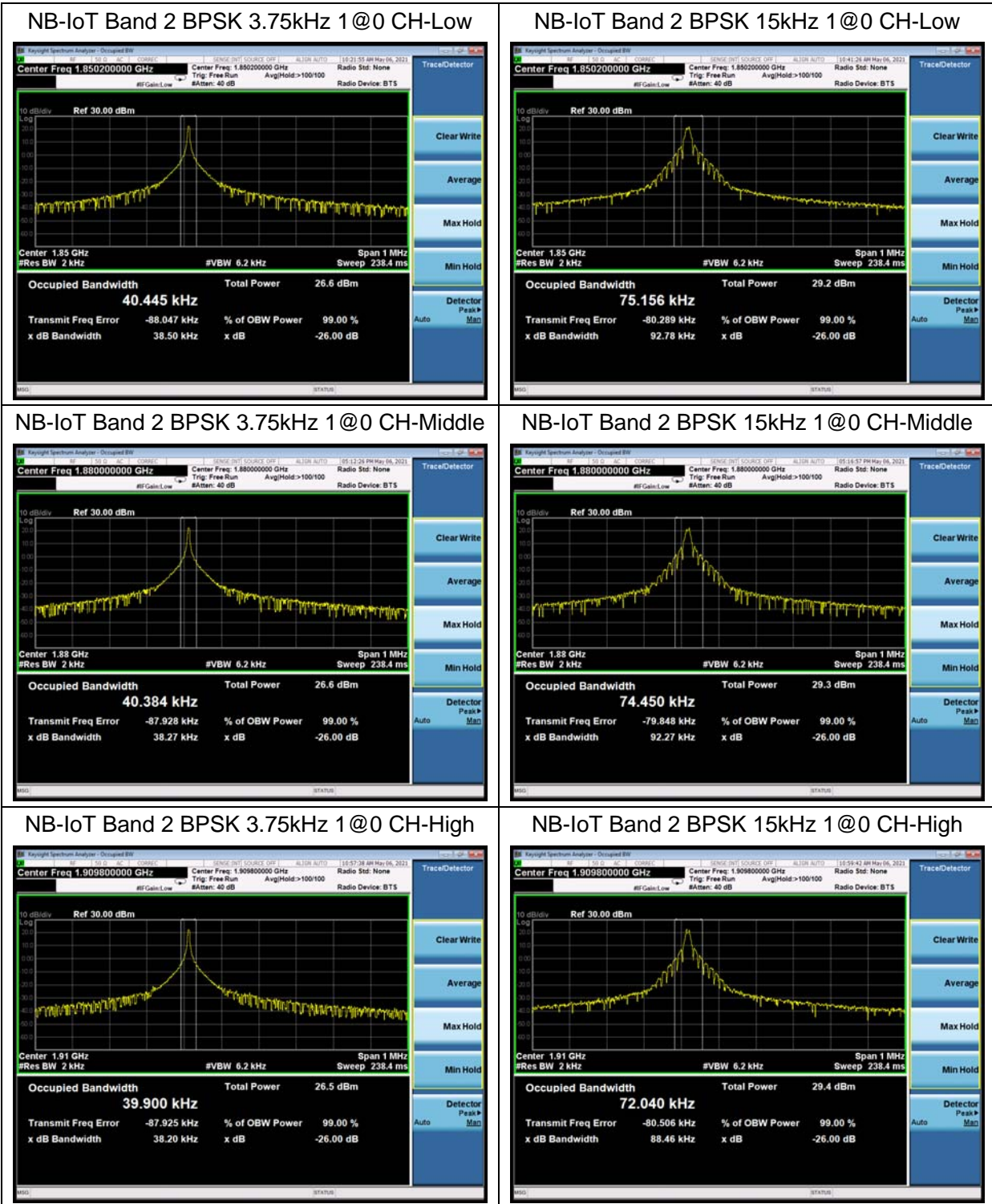

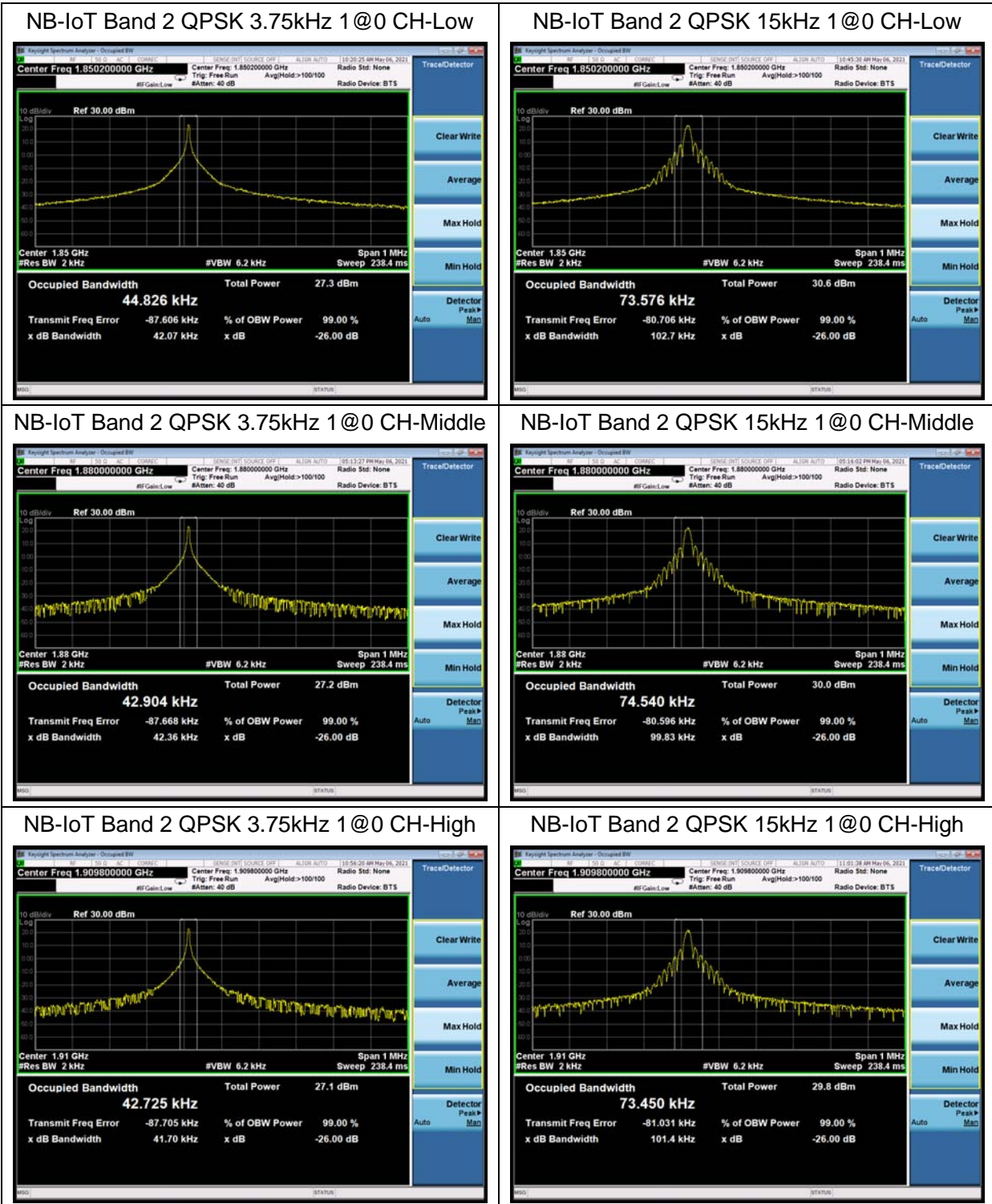

NB-IoT Band 2 QPSK 15kHz 12@0 CH-Low



NB-IoT Band 2 QPSK 15kHz 12@0 CH-Middle

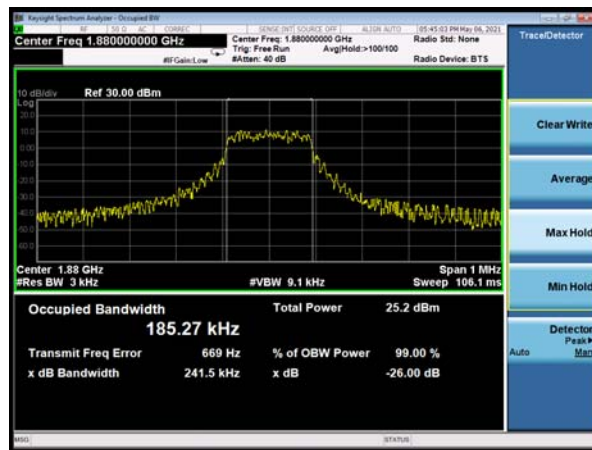

NB-IoT Band 2 QPSK 15kHz 12@0 CH-High



NB-IoT Band 25 BPSK 3.75kHz 1@0 CH-Low



NB-IoT Band 25 BPSK 15kHz 1@0 CH-Low



NB-IoT Band 25 BPSK 3.75kHz 1@0 CH-Middle



NB-IoT Band 25 BPSK 15kHz 1@0 CH-Middle



NB-IoT Band 25 BPSK 3.75kHz 1@0 CH-High

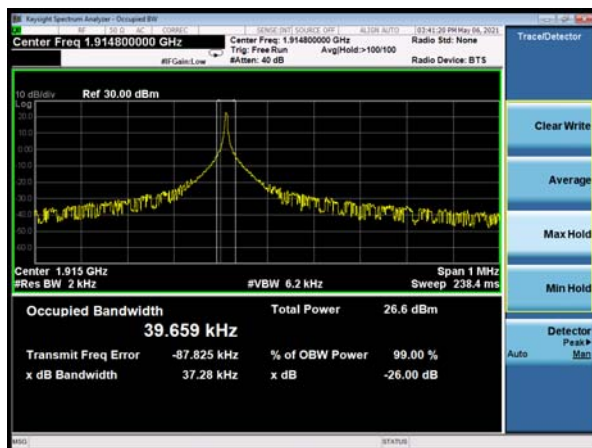

NB-IoT Band 25 BPSK 15kHz 1@0 CH-High

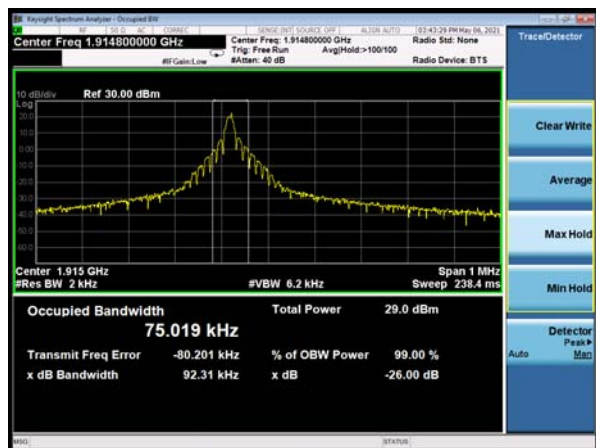

NB-IoT Band 25 QPSK 3.75kHz 1@0 CH-Low



NB-IoT Band 25 QPSK 15kHz 1@0 CH-Low



NB-IoT Band 25 QPSK 3.75kHz 1@0 CH-Middle



NB-IoT Band 25 QPSK 15kHz 1@0 CH-Middle



NB-IoT Band 25 QPSK 3.75kHz 1@0 CH-High

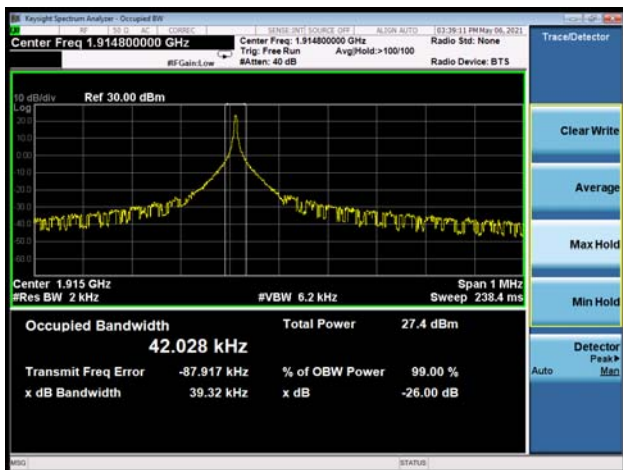

NB-IoT Band 25 QPSK 15kHz 1@0 CH-High



NB-IoT Band 25 QPSK 15kHz 12@0 CH-Low



NB-IoT Band 25 QPSK 15kHz 12@0 CH-Middle

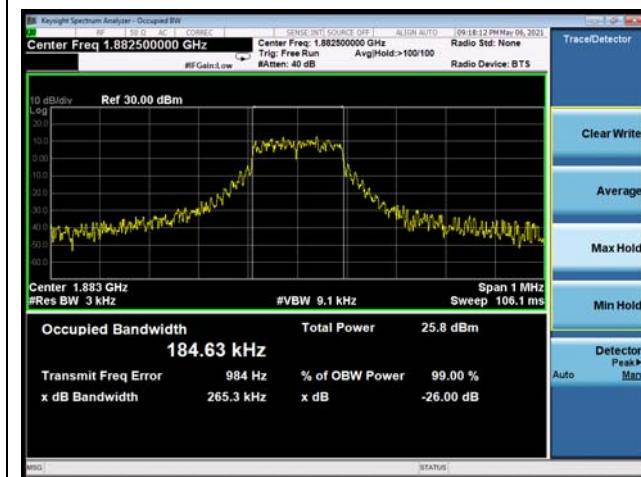

NB-IoT Band 25 QPSK 15kHz 12@0 CH-High



6.3. Band Edge Compliance

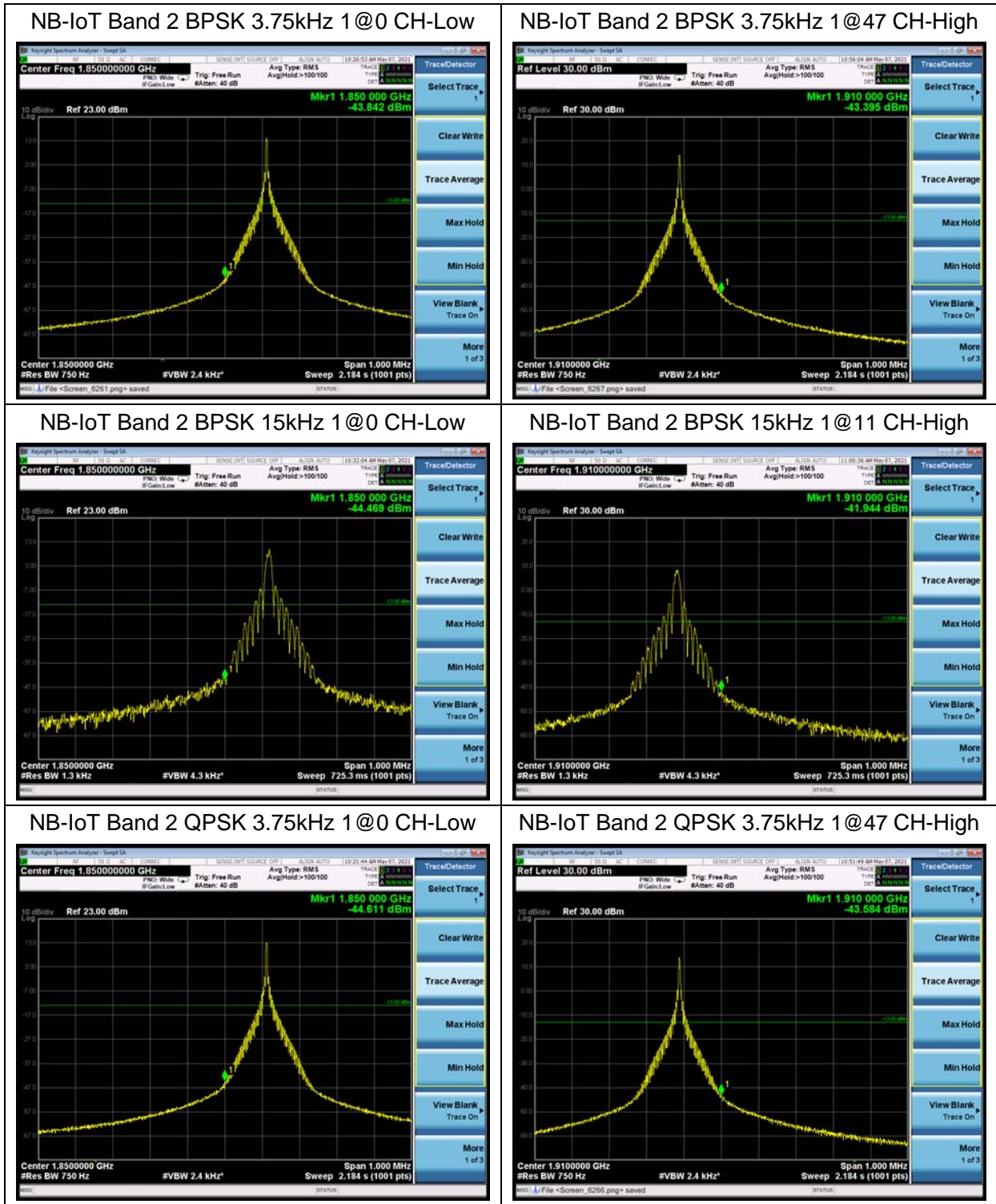

NB-IoT Band 2 QPSK 15kHz 1@0 CH-Low

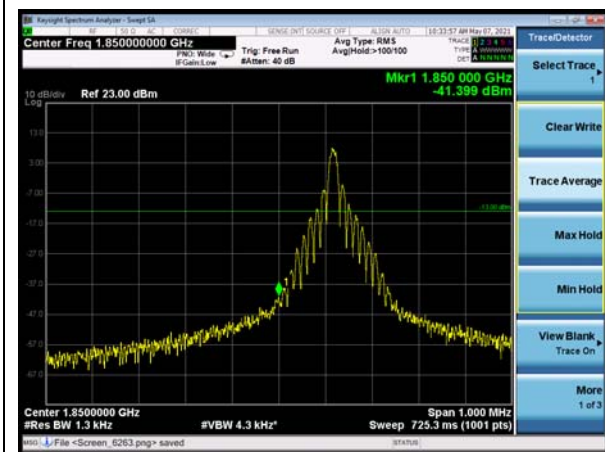

NB-IoT Band 2 QPSK 15kHz 1@11 CH-High

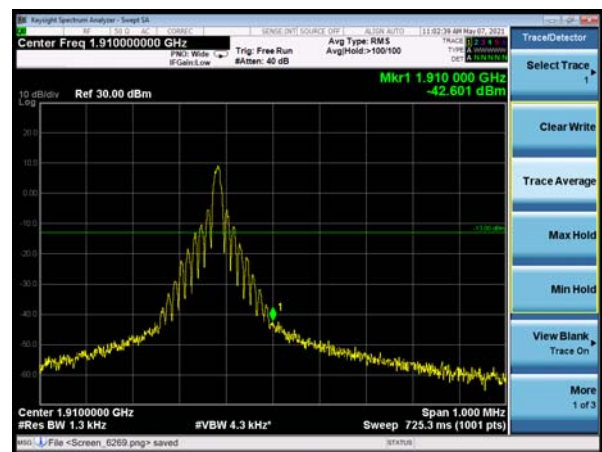

NB-IoT Band 2 QPSK 15kHz 12@0 CH-Low

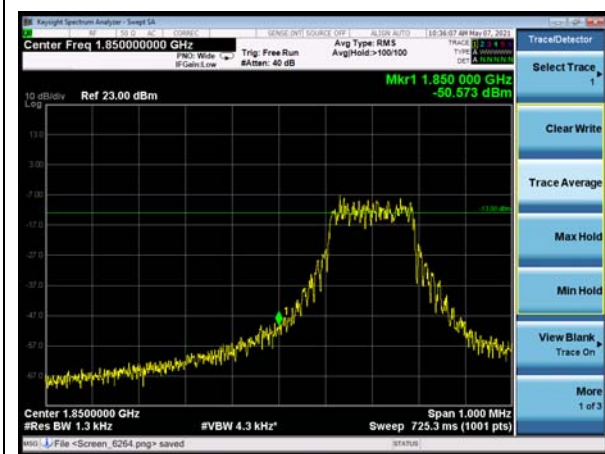

NB-IoT Band 2 QPSK 15kHz 12@0 CH-High

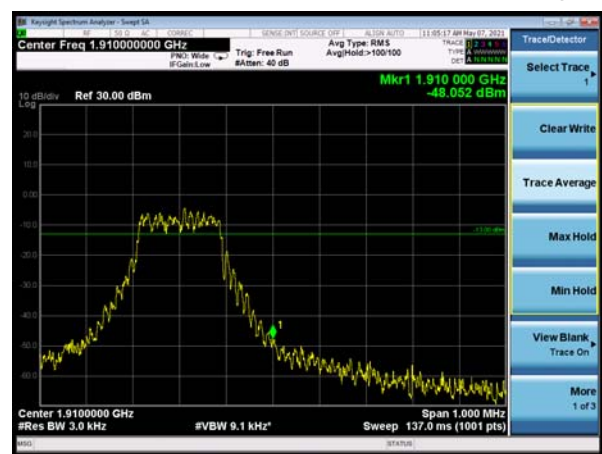

NB-IoT Band 25 BPSK 3.75kHz 1@0 CH-Low

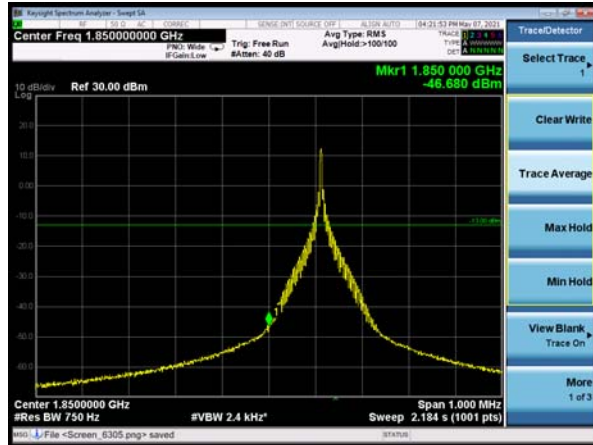

NB-IoT Band 25 BPSK 3.75kHz 1@47 CH-High

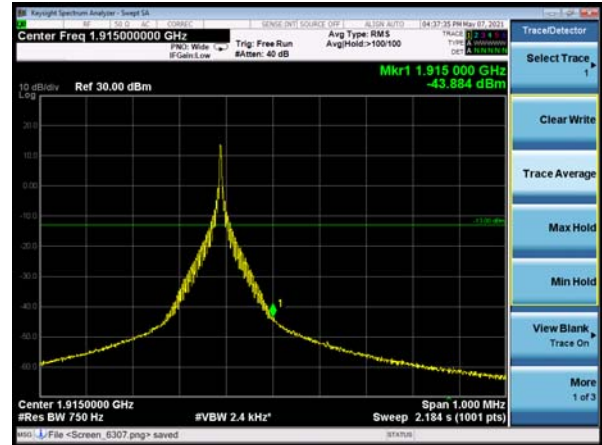

NB-IoT Band 25 BPSK 15kHz 1@0 CH-Low

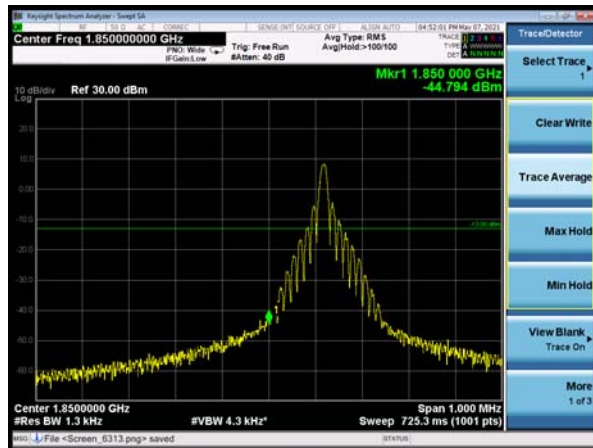

NB-IoT Band 25 BPSK 15kHz 1@11 CH-High

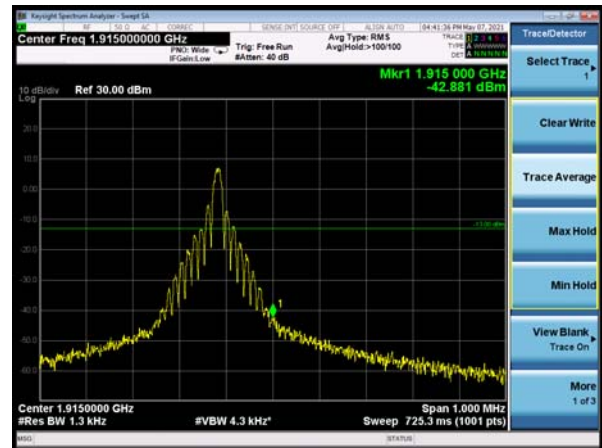

NB-IoT Band 25 QPSK 3.75kHz 1@0 CH-Low

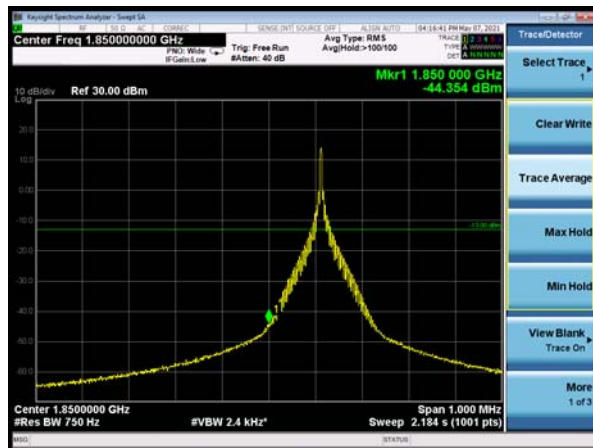

NB-IoT Band 25 QPSK 3.75kHz 1@47 CH-High

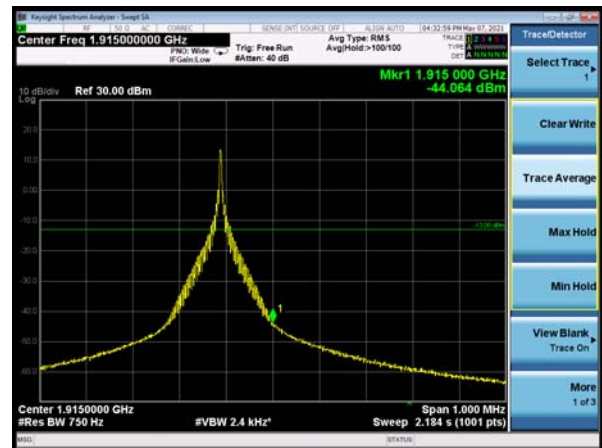

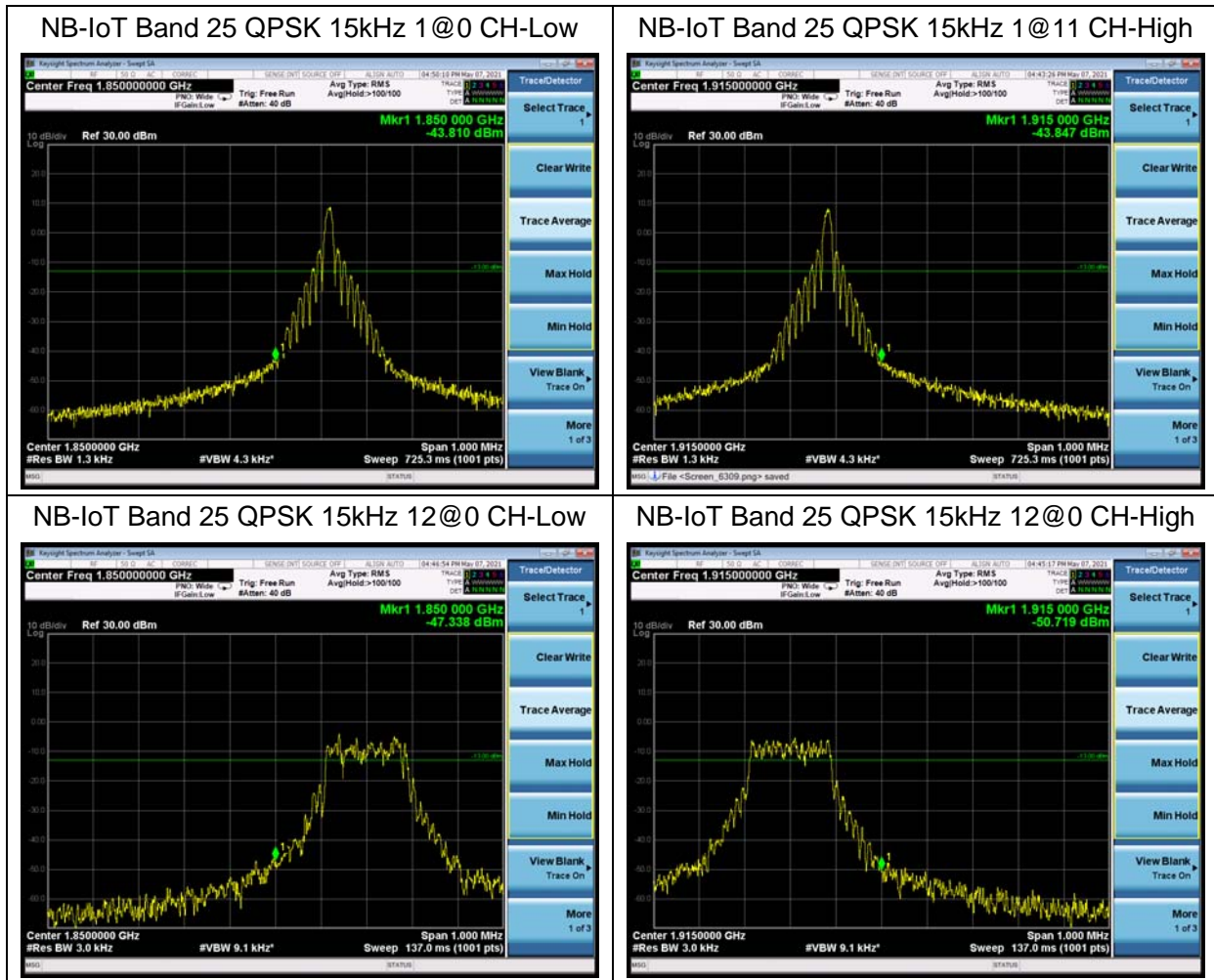

6.4. Peak-to-Average Power Ratio (PAPR)

Mode	Modulation	Sub-carrier spacing (KHz)	Channel/ Frequency(MHz)	Peak-to-Average Power Ratio (PAPR)		
				Peak(dBm)	Avg(dBm)	PAPR(dB)
Band 2 Standalone	BPSK	3.75	18900/1880.0	23.72	19.22	4.50
	QPSK	3.75	18900/1880.0	23.93	19.22	4.71
	BPSK	15	18900/1880.0	24.33	15.74	8.59
	QPSK	15	18900/1880.0	24.36	15.75	8.61
Mode	Modulation	Sub-carrier spacing (KHz)	Channel/ Frequency(MHz)	Peak-to-Average Power Ratio (PAPR)		
				Peak(dBm)	Avg(dBm)	PAPR(dB)
Band 25 Standalone	BPSK	3.75	26365/1882.5	23.93	19.42	4.51
	QPSK	3.75	26365/1882.5	23.79	19.09	4.70
	BPSK	15	26365/1882.5	24.43	15.78	8.65
	QPSK	15	26365/1882.5	24.47	15.91	8.56

6.5. Frequency Stability

NB-IoT Band 2						
Condition		Freq.Error (Hz)	Freq.Error (Hz)	Frequency Stability(ppm)	Frequency Stability(ppm)	Verdict
Sub-carrier spacing (KHz)	3.75					
Temperature	Voltage	BPSK	QPSK	BPSK	QPSK	
Normal (25°C)	Normal	12.78	3.59	0.00680	0.00191	PASS
Extreme (50°C)		7.84	1.15	0.00417	0.00061	PASS
Extreme (40°C)		7.79	4.60	0.00415	0.00244	PASS
Extreme (30°C)		8.89	11.18	0.00473	0.00595	PASS
Extreme (20°C)		2.32	6.38	0.00123	0.00339	PASS
Extreme (10°C)		1.69	13.39	0.00090	0.00712	PASS
Extreme (0°C)		1.69	17.30	0.00090	0.00920	PASS
Extreme (-10°C)		4.00	16.36	0.00213	0.00870	PASS
Extreme (-20°C)		16.06	6.50	0.00854	0.00346	PASS
Extreme (-30°C)		17.84	11.17	0.00949	0.00594	PASS
25°C		LV	4.90	6.20	0.00261	0.00330
	HV	11.05	16.37	0.00588	0.00871	PASS
Condition		Freq.Error (Hz)	Freq.Error (Hz)	Frequency Stability(ppm)	Frequency Stability(ppm)	Verdict
Sub-carrier spacing (KHz)	15					
Temperature	Voltage	BPSK	QPSK	BPSK	QPSK	
Normal (25°C)	Normal	5.69	5.96	0.00303	0.00317	PASS
Extreme (50°C)		9.24	17.43	0.00491	0.00927	PASS
Extreme (40°C)		9.29	5.63	0.00494	0.00299	PASS
Extreme (30°C)		9.99	5.69	0.00532	0.00303	PASS
Extreme (20°C)		6.22	4.32	0.00331	0.00230	PASS
Extreme (10°C)		8.93	13.18	0.00475	0.00701	PASS
Extreme (0°C)		3.34	7.43	0.00178	0.00395	PASS
Extreme (-10°C)		16.02	8.29	0.00852	0.00441	PASS
Extreme (-20°C)		7.58	8.83	0.00403	0.00469	PASS
Extreme (-30°C)		7.26	8.94	0.00386	0.00476	PASS
25°C		LV	1.85	1.96	0.00099	0.00104
	HV	11.04	2.99	0.00587	0.00159	PASS

NB-IoT Band 25						
Condition		Freq.Error (Hz)	Freq.Error (Hz)	Frequency Stability(ppm)	Frequency Stability(ppm)	Verdict
Sub-carrier spacing (KHz)	3.75					
Temperature	Voltage	BPSK	QPSK	BPSK	QPSK	
Normal (25°C)	Normal	12.86	16.10	0.00684	0.00856	PASS
Extreme (50°C)		14.35	9.03	0.00763	0.00480	PASS
Extreme (40°C)		4.50	3.19	0.00239	0.00170	PASS
Extreme (30°C)		12.78	9.37	0.00680	0.00498	PASS
Extreme (20°C)		7.54	7.70	0.00401	0.00410	PASS
Extreme (10°C)		14.39	9.14	0.00766	0.00486	PASS
Extreme (0°C)		11.78	8.07	0.00627	0.00429	PASS
Extreme (-10°C)		10.30	4.60	0.00548	0.00244	PASS
Extreme (-20°C)		11.31	10.87	0.00602	0.00578	PASS
Extreme (-30°C)		4.88	11.49	0.00259	0.00611	PASS
25°C	LV	12.88	12.59	0.00685	0.00670	PASS
	HV	1.87	2.85	0.00099	0.00151	PASS
Condition		Freq.Error (Hz)	Freq.Error (Hz)	Frequency Stability(ppm)	Frequency Stability(ppm)	Verdict
Sub-carrier spacing (KHz)	15					
Temperature	Voltage	BPSK	QPSK	BPSK	QPSK	
Normal (25°C)	Normal	9.71	3.87	0.00516	0.00206	PASS
Extreme (50°C)		16.47	2.74	0.00876	0.00146	PASS
Extreme (40°C)		12.81	15.61	0.00681	0.00830	PASS
Extreme (30°C)		7.45	15.71	0.00396	0.00835	PASS
Extreme (20°C)		7.93	6.94	0.00422	0.00369	PASS
Extreme (10°C)		12.10	12.81	0.00644	0.00682	PASS
Extreme (0°C)		3.71	12.95	0.00197	0.00689	PASS
Extreme (-10°C)		1.49	1.63	0.00079	0.00087	PASS
Extreme (-20°C)		3.47	17.41	0.00185	0.00926	PASS
Extreme (-30°C)		4.87	15.78	0.00259	0.00839	PASS
25°C	LV	9.79	14.59	0.00521	0.00776	PASS
	HV	13.39	8.46	0.00712	0.00450	PASS

6.6. Spurious Emissions at Antenna Terminals

Sweep the whole frequency band through the range from 9kHz to the 10th harmonic of the carrier, the emissions more than 20 dB below the limit are not reported. The signal beyond the limit is carrier.

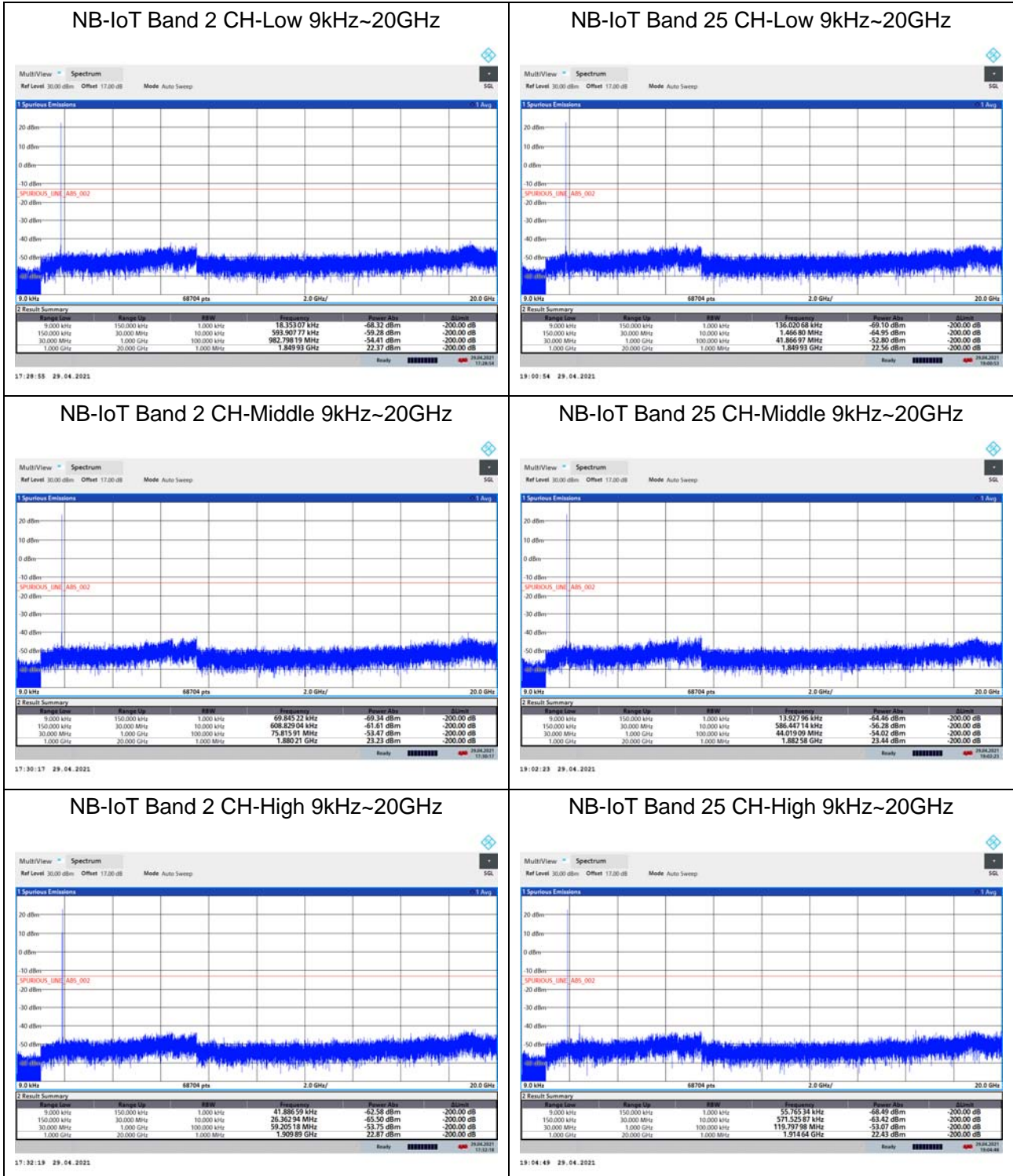

6.7. Radiated Spurious Emission

Sweep the whole frequency band through the range from 9kHz to the 10th harmonic of the carrier, the emissions below the noise floor will not be recorded in the report.

NB-IoT Band 2 15kHz CH-Low

Harmonic	Frequency (MHz)	SG (dBm)	Cable Loss (dB)	Gain (dBi)	Antenna Polarization	EIRP Level (dBm)	Limit (dBm)	Margin (dB)	Azimuth (deg)
2	3700.2	-57.92	2.60	12.50	Horizontal	-48.02	-13.00	35.02	180
3	5550.3	-60.66	3.30	12.50	Horizontal	-51.46	-13.00	38.46	135
4	7400.4	-56.32	4.20	12.20	Horizontal	-48.32	-13.00	35.32	225
5	9250.5	-52.39	4.30	11.10	Horizontal	-45.59	-13.00	32.59	90
6	11100.6	-51.46	5.90	11.90	Horizontal	-45.46	-13.00	32.46	0
7	12950.7	-50.60	5.70	14.00	Horizontal	-42.30	-13.00	29.30	45
8	14800.8	-44.82	5.80	13.10	Horizontal	-37.52	-13.00	24.52	315
9	16650.9	-50.15	6.10	14.60	Horizontal	-41.65	-13.00	28.65	90
10	18501.0	-	-	-	-	-	-	-	-

Note: 1. The other Spurious RF Radiated emissions level is no more than noise floor.
 2. The worst emission was found in the antenna is Horizontal position.

NB-IoT Band 2 15kHz CH-Middle

Harmonic	Frequency (MHz)	SG (dBm)	Cable Loss (dB)	Gain (dBi)	Antenna Polarization	EIRP Level (dBm)	Limit (dBm)	Margin (dB)	Azimuth (deg)
2	3759.4	-57.94	2.60	12.50	Horizontal	-48.04	-13.00	35.04	0
3	5640.0	-60.66	3.30	12.50	Horizontal	-51.46	-13.00	38.46	90
4	7520.0	-59.02	4.20	12.20	Horizontal	-51.02	-13.00	38.02	315
5	9400.0	-52.60	4.30	11.10	Horizontal	-45.80	-13.00	32.80	45
6	11280.0	-50.03	5.90	11.90	Horizontal	-44.03	-13.00	31.03	0
7	13160.0	-52.00	5.70	14.00	Horizontal	-43.70	-13.00	30.70	0
8	15040.0	-46.93	5.80	13.10	Horizontal	-39.63	-13.00	26.63	90
9	16920.0	-50.54	6.10	14.60	Horizontal	-42.04	-13.00	29.04	225
10	18800.0	-	-	-	-	-	-	-	-

Note: 1. The other Spurious RF Radiated emissions level is no more than noise floor.
 2. The worst emission was found in the antenna is Horizontal position.

NB-IoT Band 2 15kHz CH-High

Harmonic	Frequency (MHz)	SG (dBm)	Cable Loss (dB)	Gain (dBi)	Antenna Polarization	EIRP Level (dBm)	Limit (dBm)	Margin (dB)	Azimuth (deg)
2	3819.8	-65.65	2.60	12.50	Horizontal	-55.75	-13.00	42.75	45
3	5729.7	-60.72	3.30	12.50	Horizontal	-51.52	-13.00	38.52	225
4	7639.6	-57.75	4.20	12.20	Horizontal	-49.75	-13.00	36.75	90
5	9549.5	-53.71	4.30	11.10	Horizontal	-46.91	-13.00	33.91	0
6	11459.4	-49.33	5.90	11.90	Horizontal	-43.33	-13.00	30.33	0
7	13369.3	-52.35	5.70	14.00	Horizontal	-44.05	-13.00	31.05	45
8	15279.2	-46.45	5.80	13.10	Horizontal	-39.15	-13.00	26.15	315
9	17189.1	-48.71	6.10	14.60	Horizontal	-40.21	-13.00	27.21	90
10	19099.0	-	-	-	-	-	-	-	-

Note: 1.The other Spurious RF Radiated emissions level is no more than noise floor.

2. The worst emission was found in the antenna is Horizontal position.

NB-IoT Band 25 15kHz CH-Low

Harmonic	Frequency (MHz)	SG (dBm)	Cable Loss (dB)	Gain (dBi)	Antenna Polarization	EIRP Level (dBm)	Limit (dBm)	Margin (dB)	Azimuth (deg)
2	3700.2	-58.79	2.60	12.50	Horizontal	-48.89	-13.00	35.89	315
3	5550.3	-60.90	3.30	12.50	Horizontal	-51.70	-13.00	38.70	225
4	7400.4	-57.27	4.20	12.20	Horizontal	-49.27	-13.00	36.27	0
5	9250.5	-54.17	4.30	11.10	Horizontal	-47.37	-13.00	34.37	180
6	11100.6	-51.39	5.90	11.90	Horizontal	-45.39	-13.00	32.39	45
7	12950.7	-52.68	5.70	14.00	Horizontal	-44.38	-13.00	31.38	315
8	14800.8	-46.09	5.80	13.10	Horizontal	-38.79	-13.00	25.79	225
9	16650.9	-50.28	6.10	14.60	Horizontal	-41.78	-13.00	28.78	90
10	18501.0	-	-	-	-	-	-	-	-

Note: 1.The other Spurious RF Radiated emissions level is no more than noise floor.

2.The worst emission was found in the antenna is Horizontal position.

NB-IoT Band 25 15kHz CH-Middle

Harmonic	Frequency (MHz)	SG (dBm)	Cable Loss (dB)	Gain (dBi)	Antenna Polarization	EIRP Level (dBm)	Limit (dBm)	Margin (dB)	Azimuth (deg)
2	3765.0	-62.76	2.60	12.50	Horizontal	-52.86	-13.00	39.86	315
3	5647.5	-61.52	3.30	12.50	Horizontal	-52.32	-13.00	39.32	45
4	7530.0	-57.44	4.20	12.20	Horizontal	-49.44	-13.00	36.44	180
5	9412.5	-53.92	4.30	11.10	Horizontal	-47.12	-13.00	34.12	270
6	11295.0	-53.08	5.90	11.90	Horizontal	-47.08	-13.00	34.08	315
7	13177.5	-51.70	5.70	14.00	Horizontal	-43.40	-13.00	30.40	45
8	15060.0	-47.04	5.80	13.10	Horizontal	-39.74	-13.00	26.74	0
9	16942.5	-51.36	6.10	14.60	Horizontal	-42.86	-13.00	29.86	270
10	18825.0	-	-	-	-	-	-	-	-

Note: 1.The other Spurious RF Radiated emissions level is no more than noise floor.

2. The worst emission was found in the antenna is Horizontal position.

NB-IoT Band 25 15kHz CH-High

Harmonic	Frequency (MHz)	SG (dBm)	Cable Loss (dB)	Gain (dBi)	Antenna Polarization	EIRP Level (dBm)	Limit (dBm)	Margin (dB)	Azimuth (deg)
2	3829.8	-64.93	2.60	12.50	Horizontal	-55.03	-13.00	42.03	45
3	5744.7	-62.11	3.30	12.50	Horizontal	-52.91	-13.00	39.91	270
4	7659.6	-57.90	4.20	12.20	Horizontal	-49.90	-13.00	36.90	180
5	9574.5	-54.30	4.30	11.10	Horizontal	-47.50	-13.00	34.50	0
6	11489.4	-50.03	5.90	11.90	Horizontal	-44.03	-13.00	31.03	90
7	13404.3	-52.35	5.70	14.00	Horizontal	-44.05	-13.00	31.05	45
8	15319.2	-46.93	5.80	13.10	Horizontal	-39.63	-13.00	26.63	315
9	17234.1	-50.83	6.10	14.60	Horizontal	-42.33	-13.00	29.33	0
10	19149.0	-	-	-	-	-	-	-	-

Note: 1.The other Spurious RF Radiated emissions level is no more than noise floor.

2. The worst emission was found in the antenna is Horizontal position.

7. Main Test Instruments

Name	Manufacturer	Type	Serial Number	Calibration Date	Expiration Date
Base Station Simulator	R&S	CMU200	118133	2020-05-17	2021-05-16
Base Station Simulator	R&S	CMW500	113824	2020-05-18	2021-05-17
Power Splitter	Hua Xiang	SHX-GF2-2-13	10120101	/	/
Spectrum Analyzer	Key sight	N9010A	MY50210259	2020-05-18	2021-05-17
Universal Radio Communication Tester	Key sight	E5515C	MY48367192	2020-05-27	2021-05-26
Signal Analyzer	R&S	FSV30	100815	2020-12-13	2021-12-12
Loop Antenna	SCHWARZBECK	FMZB1519	1519-047	2020-04-02	2023-04-01
TRILOG Broadband Antenna	SCHWARZBECK	VULB 9163	391	2019-12-16	2021-12-15
Horn Antenna	R&S	HF907	102723	2018-08-11	2021-08-10
Horn Antenna	ETS-Lindgren	3160-09	00102643	2018-06-20	2021-06-19
Signal generator	R&S	SMB 100A	102594	2020-05-18	2021-05-17
Climatic Chamber	ESPEC	SU-242	93000506	2020-12-13	2021-12-12
Preamplifier	R&S	SCU18	102327	2020-05-18	2021-05-17
MOB COMMS DC SUPPLY	Keysight	66319D	MY43004105	2020-05-18	2021-05-17
RF Cable	Agilent	SMA 15cm	0001	2021-5-15	2022-5-14
Software	R&S	EMC32	9.26.0	/	/

ANNEX A: The EUT Appearance

The EUT Appearance is submitted separately.

ANNEX B: Test Setup Photos

The Test Setup Photos is submitted separately.

ANNEX C: Product Change Description (Variant 1)

The Product Change Description are submitted separately.

ANNEX D: Product Change Description (Variant 2)

The Product Change Description are submitted separately.

***** END OF REPORT *****