

## RF TEST REPORT

<b>Applicant</b>	Quectel Wireless Solutions Co., Ltd.
<b>FCC ID</b>	XMR2022BG772AGL
<b>Product</b>	LTE Cat M1 & Cat NB2 Module
<b>Brand</b>	Quectel
<b>Model</b>	BG772A-GL
<b>Report No.</b>	R2301A0034-R2
<b>Issue Date</b>	July 18, 2023

TA Technology (Shanghai) Co., Ltd. tested the above equipment in accordance with the requirements in **FCC CFR47 Part 2 (2022)/ FCC CFR 47 Part 22H (2022)**. The test results show that the equipment tested is capable of demonstrating compliance with the requirements as documented in this report.

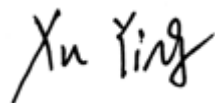

*Prepared by: Xu Ying*

*Approved by: Xu Kai*

---

**TA Technology (Shanghai) Co., Ltd.**

*Building 3, No.145, Jintang Rd, Pudong Shanghai, P.R.China*

*TEL: +86-021-50791141/2/3*

*FAX: +86-021-50791141/2/3-8000*

## TABLE OF CONTENT

1. Test Laboratory .....	5
1.1. Notes of the Test Report .....	5
1.2. Test Facility .....	5
1.3. Testing Location .....	5
2. General Description of Equipment Under Test .....	6
2.1. Applicant and Manufacturer Information .....	6
2.2. General Information .....	6
3. Applied Standards .....	7
4. Test Configuration .....	8
5. Test Case .....	9
5.1. RF Power Output and Effective Radiated Power .....	9
5.2. Occupied Bandwidth .....	10
5.3. Band Edge Compliance .....	11
5.4. Peak-to-Average Power Ratio (PAPR) .....	12
5.5. Frequency Stability .....	13
5.6. Spurious Emissions at Antenna Terminals .....	15
5.7. Radiated Spurious Emission .....	16
6. Test Result .....	19
6.1. RF Power Output and Effective Radiated Power .....	19
6.2. Occupied Bandwidth .....	21
6.3. Band Edge Compliance .....	23
6.4. Peak-to-Average Power Ratio (PAPR) .....	29
6.5. Frequency Stability .....	30
6.6. Spurious Emissions at Antenna Terminals .....	32
6.7. Radiated Spurious Emission .....	34
7. Main Test Instruments .....	36
ANNEX A: The EUT Appearance .....	37
ANNEX B: Test Setup Photos .....	38
ANNEX C: Product Change Description (Variant 1) .....	39
ANNEX D: Product Change Description (Variant 2) .....	40

## Summary of Measurement Results

No.	Test Case	Clause in FCC rules	Verdict
1	RF Power Output and Effective Radiated Power	2.1046 22.913(a)(5)	PASS
2	Occupied Bandwidth	2.1049	PASS
3	Band Edge Compliance	2.1051 / 22.917(a)	PASS
4	Peak-to-Average Power Ratio	22.913(d) KDB 971168 D01(5.7)	PASS
5	Frequency Stability	2.1055 / 22.355	PASS
6	Spurious Emissions at Antenna Terminals	2.1051 / 22.917(a)	PASS
7	Radiated Spurious Emission	2.1053 / 22.917 (a)	PASS
Date of Testing: (Original) April 21, 2021 ~ May 14, 2021 (Variant 1) January 19, 2022 Date of Sample Received: (Original) April 16, 2021 (Variant 1) December 28, 2021			
Note: PASS: The EUT complies with the essential requirements in the standard. FAIL: The EUT does not comply with the essential requirements in the standard. All indications of Pass/Fail in this report are opinions expressed by TA Technology (Shanghai) Co., Ltd. based on interpretations and/or observations of test results. Measurement Uncertainties were not taken into account and are published for informational purposes only.			

**BG772A-GL (Report No.: R2301A0034-R2) is a variant model (Variant 2) of BG772A-GL (Report No.: R2112A1193-R2). BG772A-GL supports from Cat NB1 (3GPP R13) to Cat NB2 (3GPP R14) only by FW updating, the hardware remains the same.**

**The detailed product change description please refers to following table:**

Module	BG772A-GL (Cat NB1)	BG772A-GL (Cat NB2)
Category	Cat M1 & NB1	Cat M1 & NB2
Frequency Bands	Cat M1 Band 2/4/5/12/13/25/26/66 Cat NB1 Band 2/4/5/12/13/17/25/66	Cat M1 Band 2/4/5/12/13/25/26/66 Cat NB2 Band 2/4/5/12/13/17/25/66
Software Version	BG772AGLAAR01A03	BG772AGLAAR02A01
Product Name	LTE Module	LTE Cat M1 & Cat NB2 Module
Others	The same	

**There is only verified RF Power Output, Band Edge Compliance and Spurious Emissions at Antenna Terminals, and did not worsen, so they were not recorded in the report.**

**Powers of new variant are varied due to measurement uncertainty, and sample tolerance of the acceptance range.**

**The detailed product change description please refers to the *Difference Declaration Letter (Variant 2)*.**

**BG772A-GL (Report No.: R2112A1193-R2) is a variant model (Variant 1) of BG770A-GL (Report No.: R2104A0331-R2). Test values partial duplicated from Original for variant. There is only test RF Power Output for variant in this report.**

**The detailed product change description please refers to the *Difference Declaration Letter (Variant 1)*.**

## 1. Test Laboratory

### 1.1. Notes of the Test Report

This report shall not be reproduced in full or partial, without the written approval of **TA Technology (Shanghai) Co., Ltd.** The results documented in this report apply only to the tested sample, under the conditions and modes of operation as described herein. Measurement Uncertainties were not taken into account and are published for informational purposes only. This report is written to support regulatory compliance of the applicable standards stated above.

### 1.2. Test Facility

#### **FCC (Designation number: CN1179, Test Firm Registration Number: 446626)**

TA Technology (Shanghai) Co., Ltd. has been listed on the US Federal Communications Commission list of test facilities recognized to perform measurements.

#### **A2LA (Certificate Number: 3857.01)**

TA Technology (Shanghai) Co., Ltd. has been listed by American Association for Laboratory Accreditation to perform measurement.

### 1.3. Testing Location

Company: TA Technology (Shanghai) Co., Ltd.  
Address: Building 3, No.145, Jintang Rd, Pudong Shanghai, P.R.China  
City: Shanghai  
Post code: 201201  
Country: P. R. China  
Contact: Xu Kai  
Telephone: +86-021-50791141/2/3  
Fax: +86-021-50791141/2/3-8000  
Website: <http://www.ta-shanghai.com>  
E-mail: [xukai@ta-shanghai.com](mailto:xukai@ta-shanghai.com)

## 2. General Description of Equipment Under Test

### 2.1. Applicant and Manufacturer Information

Applicant	Quectel Wireless Solutions Co., Ltd
Applicant address	Building 5, Shanghai Business Park Phase III (Area B), No.1016 Tianlin Road, Minhang District, Shanghai, 200233 China
Manufacturer	Quectel Wireless Solutions Co., Ltd
Manufacturer address	Building 5, Shanghai Business Park Phase III (Area B), No.1016 Tianlin Road, Minhang District, Shanghai, 200233 China

### 2.2. General Information

EUT Description			
Model	BG772A-GL		
IMEI	Original	863593050006733	
	Variant 1	863593050007525	
Hardware Version	R1.1		
Software Version	BG772AGLAAR02A01		
Power Supply	External power supply		
Antenna Type	External Antenna		
Antenna Gain	Mode	Frequency (MHz)	Gain (dBi)
	LTE-M Band 5	820	2.53
		830	2.13
		840	1.89
		850	2.29
		870	3.01
		880	2.98
		890	2.46
Test Mode(s)	LTE-M Band 5		
Test Modulation	QPSK, 16QAM;		
LTE-M Category	M1		
Maximum E.R.P.	LTE-M Band 5:	24.13dBm	
Rated Power Supply Voltage	3.3V		
Operating Voltage	Minimum: 3.1V    Maximum: 4.2V		
Operating Temperature	Lowest: -35°C    Highest: +75°C		
Testing Temperature	Lowest: -30°C    Highest: +50°C		
Frequency Range(s)	Band	Tx (MHz)	Rx (MHz)
	LTE-M Band 5	824 ~ 849	869 ~ 894
Note: 1. The EUT is sent from the applicant to TA and the information of the EUT is declared by the applicant.			

### 3. Applied Standards

According to the specifications of the manufacturer, it must comply with the requirements of the following standards:

**Test standards:**

**FCC CFR 47 Part 22H (2022)**

**FCC CFR47 Part 2 (2022)**

**Reference standard:**

**ANSI C63.26-2015**

**KDB 971168 D01 Power Meas License Digital Systems v03r01**

## 4. Test Configuration

Radiated measurements are performed by rotating the EUT in three different orthogonal test planes. EUT polarization (horizontal and vertical). Receiver antenna polarization (horizontal and vertical), the worst emission was found in position (vertical polarization, horizontal polarization) and the worst case was recorded.

All mode and data rates and positions and RB size and modulations were investigated.

Subsequently, only the worst case emissions are reported.

The following testing in LTE-M is set based on the maximum RF Output Power.

Test modes are chosen as the worst case configuration below for LTE-M Band 5.

Test items	Bandwidth (MHz)				Modulation		RB			Test Channel		
	1.4	3	5	10	QPSK	16QAM	1	50%	100%	L	M	H
RF power output and Effective Radiated power	O	O	O	O	O	O	O	O	O	O	O	O
Occupied Bandwidth	O	O	O	O	O	O	-	-	O	-	O	-
Band Edge Compliance	O	O	O	O	O	O	O	-	O	O	-	O
Peak-to-Average Power Ratio	O	O	O	O	O	O	-	-	O	-	O	-
Frequency Stability	O	O	O	O	O	O	O	-	-	-	O	-
Spurious Emissions at Antenna Terminals	O	O	O	O	O	-	O	-	-	O	O	O
Radiated Spurious Emission	O	-	O	O	O	-	O	-	-	-	O	-
Note	1. The mark "O" means that this configuration is chosen for testing. 2. The mark "-" means that this configuration is not testing.											



## 5. Test Case

### 5.1. RF Power Output and Effective Radiated Power

#### Ambient Condition

Temperature	Relative humidity	Pressure
23°C ~25°C	45%~50%	101.5kPa

#### Methods of Measurement

During the process of the testing, The EUT was connected to the Base Station Simulator with a known loss. The EUT is controlled by the Base Station Simulator test set to ensure max power transmission with proper modulation.

ERP can then be calculated as follows:

$EIRP \text{ (dBm)} = \text{Output Power (dBm)} + \text{Antenna Gain (dBi)}$

$EIRP \text{ (dBm)} = ERP \text{ (dBm)} + 2.15 \text{ (dB)}$ .

#### Test Setup

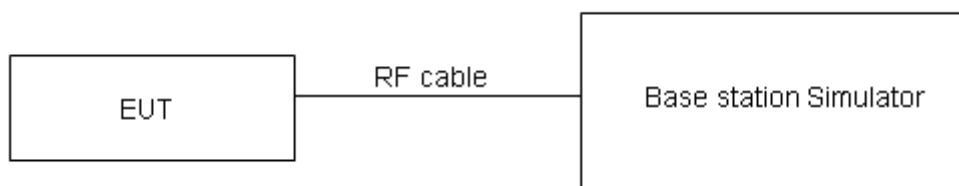

#### Limits

No specific RF power output requirements in part 2.1046.

Rule Part 22.913(a)(5) specifies that "Mobile/portable stations are limited to 7 watts ERP".

Limit	$\leq 7 \text{ W}$ (38.45 dBm)
-------	--------------------------------

#### Measurement Uncertainty

The assessed measurement uncertainty to ensure 95% confidence level for the normal distribution is with the coverage factor  $k = 2$ ,  $U = 0.4 \text{ dB}$  for RF power output,  $k = 2$ ,  $U = 1.19 \text{ dB}$  for ERP.

#### Test Results

Refer to the section 6.1 of this report for test data.

## 5.2. Occupied Bandwidth

### Ambient Condition

Temperature	Relative humidity	Pressure
23°C ~25°C	45%~50%	101.5kPa

### Method of Measurement

The EUT was connected to Spectrum Analyzer and Base Station Simulator via power Splitter. The occupied bandwidth is measured using spectrum analyzer.

RBW is set to  $\geq 1\%$ EBW, VBW is set to 3x RBW.

99% power and -26dBc occupied bandwidths are recorded. Spectrum analyzer plots are included on the following pages.

### Test Setup

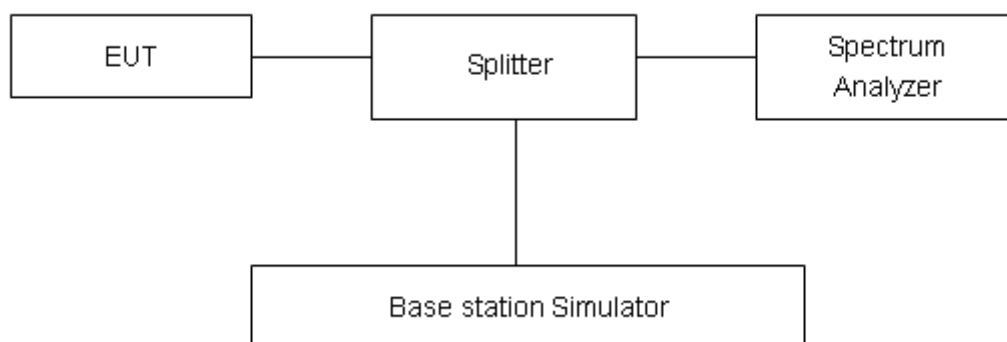

### Limits

No specific occupied bandwidth requirements in part 2.1049.

### Measurement Uncertainty

The assessed measurement uncertainty to ensure 95% confidence level for the normal distribution is with the coverage factor  $k = 2$ ,  $U = 624\text{Hz}$ .

### Test Results

Refer to the section 6.2 of this report for test data.

### 5.3. Band Edge Compliance

#### Ambient Condition

Temperature	Relative humidity	Pressure
23°C ~25°C	45%~50%	101.5kPa

#### Method of Measurement

The EUT was connected to Spectrum Analyzer and Base Station Simulator via power Splitter. The band edge of the lowest and highest channels were measured. The average detector is used. RBW is set to  $\geq 1\%EBW$ , VBW is set to 3x RBW.

Spectrum analyzer plots are included on the following pages.

#### Test Setup

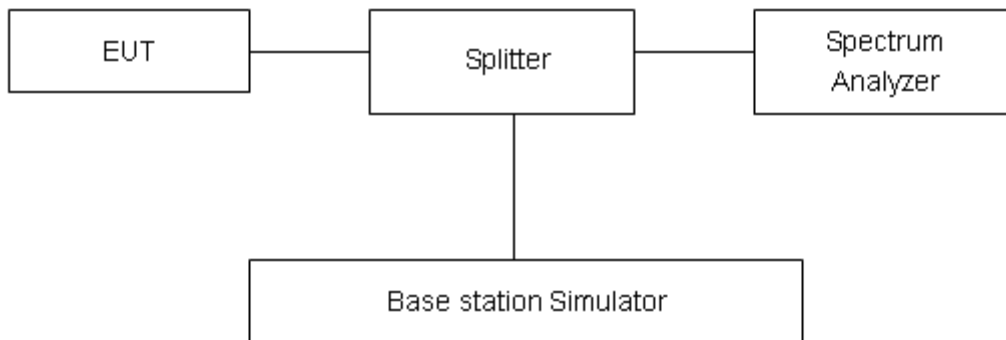

#### Limits

Rule Part 22.917(a) specifies that “The power of any emission outside of the authorized operating frequency ranges must be attenuated below the transmitting power (P) by a factor of at least 43 + 10 log(P) dB.”

Limit	-13 dBm
-------	---------

#### Measurement Uncertainty

The assessed measurement uncertainty to ensure 95% confidence level for the normal distribution is with the coverage factor  $k = 1.96$ ,  $U=0.684dB$ .

#### Test Results

Refer to the section 6.3 of this report for test data.

## 5.4. Peak-to-Average Power Ratio (PAPR)

### Ambient Condition

Temperature	Relative humidity	Pressure
23°C ~25°C	45%~50%	101.5kPa

### Methods of Measurement

Measure the total peak power and record as  $P_{Pk}$ . And measure the total average power and record as  $P_{Avg}$ . Both the peak and average power levels must be expressed in the same logarithmic units (e.g., dBm). Determine the PAPR from:

$$PAPR (dB) = P_{Pk} (dBm) - P_{Avg} (dBm).$$

### Test Setup

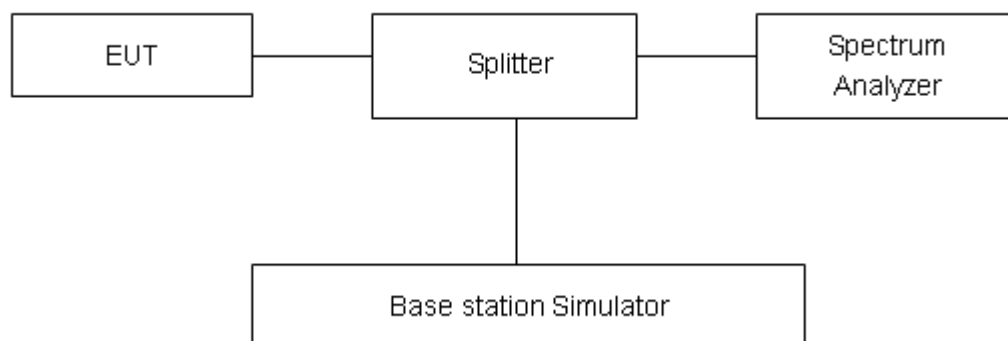

### Limits

According to the Sec. 22.913(d), The peak-to-average ratio (PAR) of the transmission must not exceed 13 dB.

### Measurement Uncertainty

The assessed measurement uncertainty to ensure 95% confidence level for the normal distribution is with the coverage factor  $k = 2$ ,  $U = 0.4$  dB.

### Test Results

Refer to the section 6.4 of this report for test data.

## 5.5. Frequency Stability

### Ambient Condition

Temperature	Relative humidity	Pressure
23°C ~25°C	45%~50%	101.5kPa

### Method of Measurement

#### Frequency Stability (Temperature Variation)

The temperature inside the climate chamber is varied from -30°C to +50°C in 10°C step size,

(1) With all power removed, the temperature was decreased to 0°C and permitted to stabilize for three hours.

(2) Measure the carrier frequency with the test equipment in a “call mode”. These measurements should be made within 1 minute of powering up the mobile station, to prevent significant self warming.

(3) Repeat the above measurements at 10°C increments from -30°C to +50°C. Allow at least 1.5 hours at each temperature, un-powered, before making measurements.

#### Frequency Stability (Voltage Variation)

The frequency stability shall be measured with variation of primary supply voltage as follows:

**Primary Supply Voltage:** The primary supply voltage is varied from 85% to 115% of the nominal value for non hand-carried battery and AC powered equipment. For hand-carried, battery-powered equipment, primary supply voltage is reduced to the battery operating end point which shall be specified by the manufacturer.

This transceiver is specified to operate with an input voltage of between 3.1 V and 4.2 V, with a nominal voltage of 3.3V.

### Test Setup

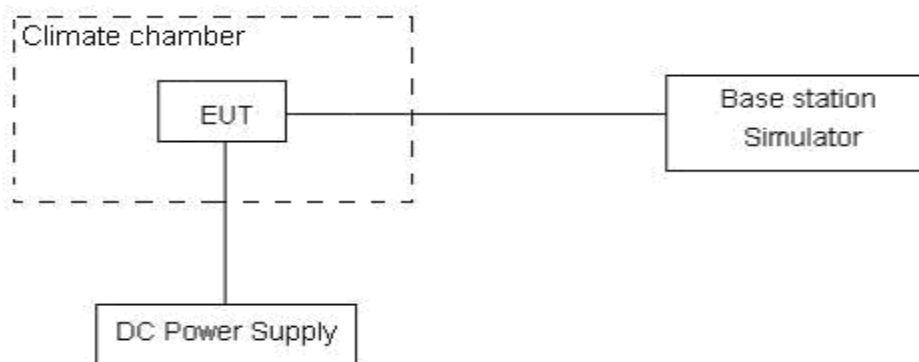

### Limits

According to the Sec. 22.355, the frequency stability of the carrier shall be accurate to within 2.5 ppm of the received frequency for mobile stations.

Limits	≤ 2.5 ppm
--------	-----------

### Measurement Uncertainty

The assessed measurement uncertainty to ensure 99.75% confidence level for the normal distribution is with the coverage factor  $k = 3$ ,  $U = 0.01\text{ppm}$ .

## Test Results

Refer to the section 6.5 of this report for test data.

## 5.6. Spurious Emissions at Antenna Terminals

### Ambient Condition

Temperature	Relative humidity	Pressure
23°C ~25°C	45%~50%	101.5kPa

### Method of Measurement

The EUT was connected to Spectrum Analyzer and Base Station Simulator via power Splitter. The measurement is carried out using a spectrum analyzer. The spectrum analyzer scans from 9kHz to the 10th harmonic of the carrier.

The peak detector is used.

RBW is set to 1 kHz (0.009MHz~ 0.15 MHz),

RBW is set to 10 kHz (0.15 MHz~ 30 MHz)

RBW is set to 100 kHz (30MHz~1000 MHz)

RBW is set to 1000 kHz (above 1000MHz)

Sweep is set to ATUO.

The modulation mode and RB allocation refer to section 5.1, using the maximum output power configuration.

### Test Setup

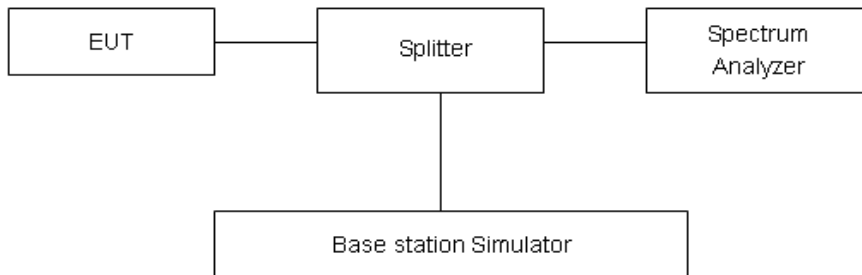

### Limits

Rule Part 22.917(a) specifies that “The power of any emission outside of the authorized operating frequency ranges must be attenuated below the transmitting power (P) by a factor of at least  $43 + 10 \log (P)$  dB.”

Limit	-13 dBm

### Measurement Uncertainty

The assessed measurement uncertainty to ensure 99.75% confidence level for the normal distribution is with the coverage factor  $k = 1.96$ .

Frequency	Uncertainty
9kHz-1GHz	0.684 dB
1GHz-20GHz	1.407 dB

### Test Results

Refer to the section 6.6 of this report for test data.

## 5.7. Radiated Spurious Emission

### Ambient Condition

Temperature	Relative humidity	Pressure
23°C ~25°C	45%~50%	101.5kPa

### Method of Measurement

- The testing follows FCC KDB 971168 v03r01 Section 5.8 and ANSI C63.26-2015.
- Below 1GHz: The EUT is placed on a turntable 0.8 meters above the ground in the chamber, 3 meter away from the antenna. The maximal emission value is acquired by adjusting the antenna height, polarisation and turntable azimuth. Normally, the height range of antenna is 1 m to 4 m, the azimuth range of turntable is 0° to 360°, and the receive antenna has two polarizations Vertical (V) and Horizontal (H). Above 1GHz: (Note: the FCC's permission to use 1.5m as an alternative per TCBC Conf call of Dec. 2, 2014.) The EUT is placed on a turntable 1.5 meters above the ground in the chamber, 3 meter away from the antenna. The maximal emission value is acquired by adjusting the antenna height, polarisation and turntable azimuth. Normally, the height range of antenna is 1 m to 4 m, the azimuth range of turntable is 0° to 360°, and the receive antenna has two polarizations Vertical (V) and Horizontal (H).
- A loop antenna, A log-periodic antenna or horn antenna shall be substituted in place of the EUT. The log-periodic antenna will be driven by a signal generator and the level will be adjusted till the same power value on the spectrum analyzer or receiver. The level of the spurious emissions can be calculated through the level of the signal generator, cable loss, the gain of the substitution antenna and the reading of the spectrum analyzer or receiver.
- The EUT is then put into continuously transmitting mode at its maximum power level during the test. Set Test Receiver or Spectrum RBW=100kHz, VBW=300kHz, and the maximum value of the receiver should be recorded as (Pr).
- The EUT shall be replaced by a substitution antenna. In the chamber, an substitution antenna for the frequency band of interest is placed at the reference point of the chamber. An RF Signal source for the frequency band of interest is connected to the substitution antenna with a cable that has been constructed to not interfere with the radiation pattern of the antenna. A power (PMea) is applied to the input of the substitution antenna, and adjust the level of the signal generator output until the value of the receiver reach the previously recorded (Pr). The power of signal source (PMea) is recorded. The test should be performed by rotating the test item and adjusting the receiving antenna polarization.
- A amplifier should be connected to the Signal Source output port. And the cable should be connect between the Amplifier and the Substitution Antenna. The cable loss (Pcl) ,the Substitution Antenna Gain (Ga) and the Amplifier Gain (PAg) should be recorded after test.
- The measurement results are obtained as described below:  
 Power (EIRP) = PMea - PAg - Pcl + Ga  
 The measurement results are amend as described below:  
 Power (EIRP) = PMea - Pcl + Ga
- This value is EIRP since the measurement is calibrated using an antenna of known gain (2.15 dB) and known input power. ERP can be calculated from EIRP by subtracting the gain of the dipole, ERP = EIRP-2.15dB.



The modulation mode and RB allocation refer to section 5.1, using the maximum output power configuration.

**Test Setup**

**9KHz~ 30MHz**

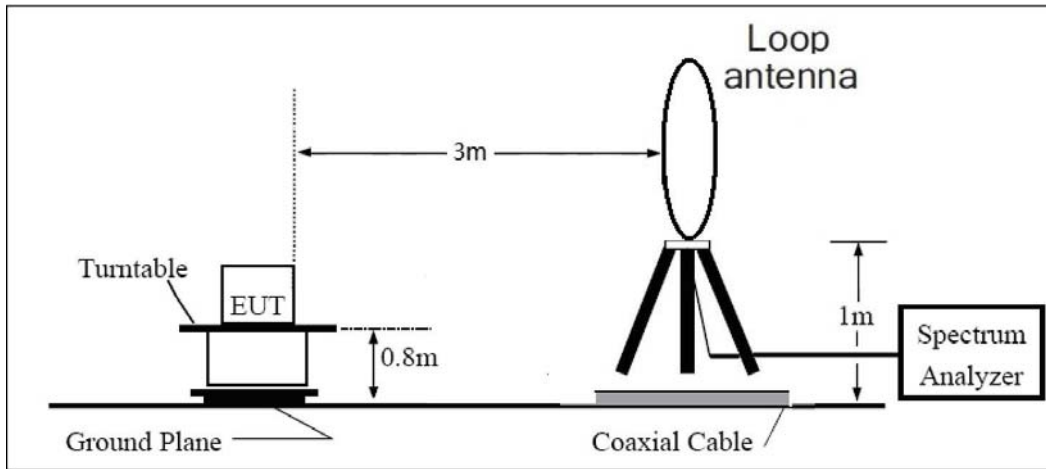

**30MHz~ 1GHz**

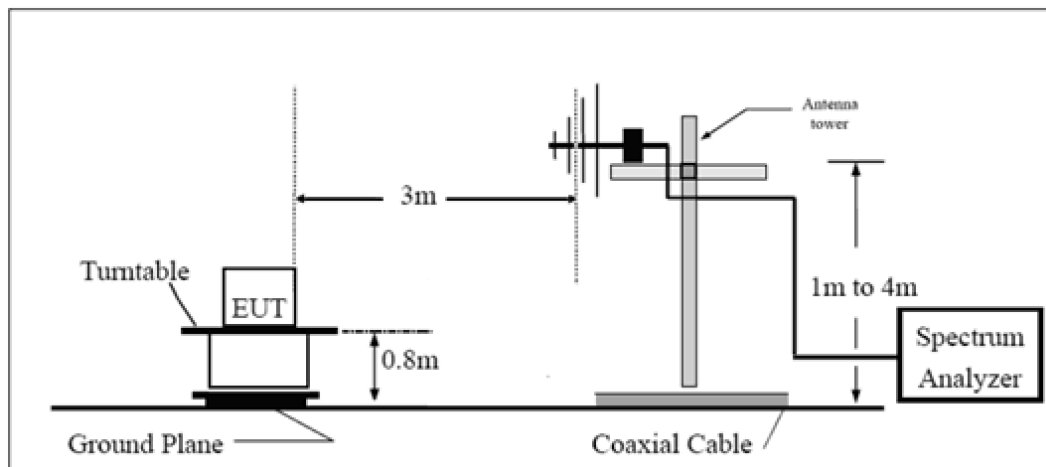

**Above 1GHz**

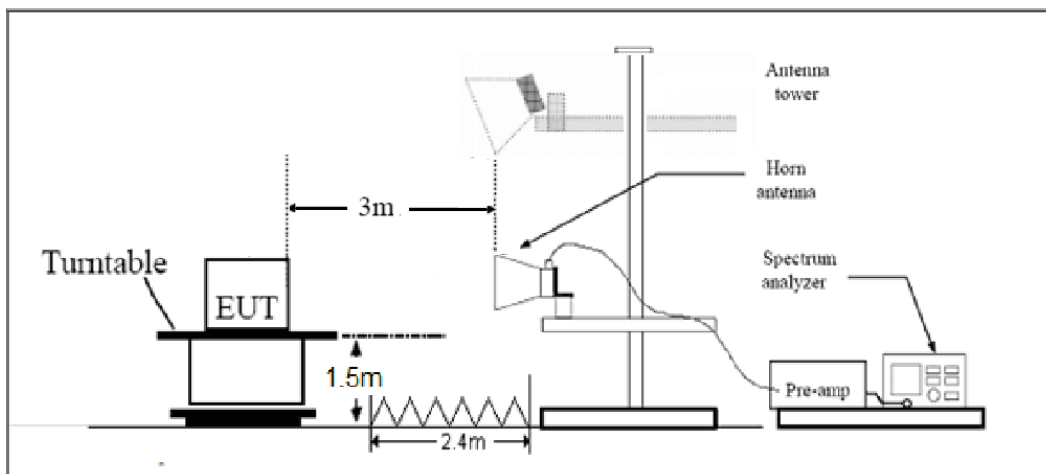

Note: Area side: 2.4mX3.6m

### Limits

Rule Part 22.917(a) specifies that “The power of any emission outside of the authorized operating frequency ranges must be attenuated below the transmitting power (P) by a factor of at least  $43 + 10 \log (P)$  Db.”

Limit	-13 dBm
-------	---------

### Measurement Uncertainty

The assessed measurement uncertainty to ensure 95% confidence level for the normal distribution is with the coverage factor  $k = 1.96$ ,  $U = 3.55$  Db.

### Test Results

Refer to the section 6.7 of this report for test data.

## 6. Test Result

### 6.1. RF Power Output and Effective Radiated Power

Original

LTE-M Band 5	Channel/ Frequency(MHz)	Index	RB#	RB#	Conducted Power (dBm)		ERP (dBm)	
			RBstart QPSK	RBstart 16QAM	QPSK	16QAM	QPSK	16QAM
1.4MHz	20407/824.7	0	1#0	1#0	23.75	22.73	24.13	23.11
		0	6#0	5#0	22.12	21.73	22.50	22.11
	20525/836.5	0	1#0	1#0	23.68	22.63	23.42	22.37
		0	6#0	5#0	22.22	21.75	21.96	21.49
	20643/848.3	0	1#5	1#5	23.78	22.62	23.92	22.76
		0	6#0	5#0	22.17	21.64	22.31	21.78
3MHz	20415/825.5	0	1#0	1#0	23.55	22.86	23.53	22.84
		0	6#0	5#0	21.99	21.80	21.97	21.78
	20525/836.5	0	1#0	1#0	23.55	22.87	23.29	22.61
		0	6#0	5#0	22.00	21.80	21.74	21.54
	20635/847.5	1	1#5	1#5	23.38	22.74	23.52	22.88
		1	6#0	5#0	21.90	21.63	22.04	21.77
5MHz	20425/826.5	3	1#0	1#0	23.55	23.42	23.53	23.40
		0	6#0	5#0	23.20	21.85	23.18	21.83
	20525/836.5	0	1#0	1#0	23.57	23.44	23.31	23.18
		0	6#0	5#0	23.09	21.87	22.83	21.61
	20625/846.5	0	1#5	1#5	23.66	23.48	23.80	23.62
		3	6#0	5#0	22.96	21.82	23.10	21.96
10MHz	20450/829	3	1#0	1#0	23.52	23.41	23.50	23.39
		0	4#0	4#0	23.69	22.86	23.67	22.84
	20525/836.5	0	1#0	1#0	23.52	23.35	23.26	23.09
		0	4#0	4#0	23.64	22.90	23.38	22.64
	20600/844	4	1#5	1#5	23.59	23.52	23.33	23.26
		7	4#2	4#2	23.60	21.87	23.34	21.61

**Variant 1**

Band5	Channel/ Frequency(MHz)	Index	RB#		Conducted Power (dBm)	
			RBstart QPSK	RBstart 16QAM	QPSK	16QAM
1.4MHz	20407/824.7	0	1#0	1#0	23.46	22.05
		0	6#0	5#0	21.94	21.59
	20525/836.5	0	1#0	1#0	23.42	21.99
		0	6#0	5#0	22.00	21.50
	20643/848.3	0	1#5	1#5	23.42	21.97
		0	6#0	5#0	21.97	21.49
3MHz	20415/825.5	0	1#0	1#0	23.50	22.27
		0	6#0	5#0	21.67	21.54
	20525/836.5	0	1#0	1#0	23.48	22.23
		0	6#0	5#0	21.67	21.52
	20635/847.5	1	1#5	1#5	23.44	22.30
		1	6#0	5#0	21.68	21.51
5MHz	20425/826.5	3	1#0	1#0	23.49	23.24
		0	6#0	5#0	22.87	21.69
	20525/836.5	0	1#0	1#0	23.47	23.25
		0	6#0	5#0	22.65	21.55
	20625/846.5	0	1#5	1#5	23.65	23.48
		3	6#0	5#0	22.86	21.67
10MHz	20450/829	3	1#0	1#0	23.52	23.28
		0	4#0	4#0	23.74	22.59
	20525/836.5	0	1#0	1#0	23.51	23.21
		0	4#0	4#0	23.73	22.54
	20600/844	4	1#5	1#5	23.65	23.52
		7	4#2	4#2	23.26	21.73

## 6.2. Occupied Bandwidth

Mode	Bandwidth	Modulation	Channel/ Frequency(MHz)	RB	Index	Bandwidth(MHz)	
						99% Power	-26dBc
Band 5	1.4MHz	QPSK	20525/836.5	6#0	0	1.1161	1.340
		16QAM	20525/836.5	5#0	0	0.9689	1.299
	3MHz	QPSK	20525/836.5	6#0	0	1.1073	1.334
		16QAM	20525/836.5	5#0	0	0.9613	1.294
	5MHz	QPSK	20525/836.5	6#0	0	1.0997	1.324
		16QAM	20525/836.5	5#0	0	0.9800	1.308
	10MHz	QPSK	20525/836.5	6#0	0	1.1086	1.335
		16QAM	20525/836.5	5#0	0	0.9893	1.318

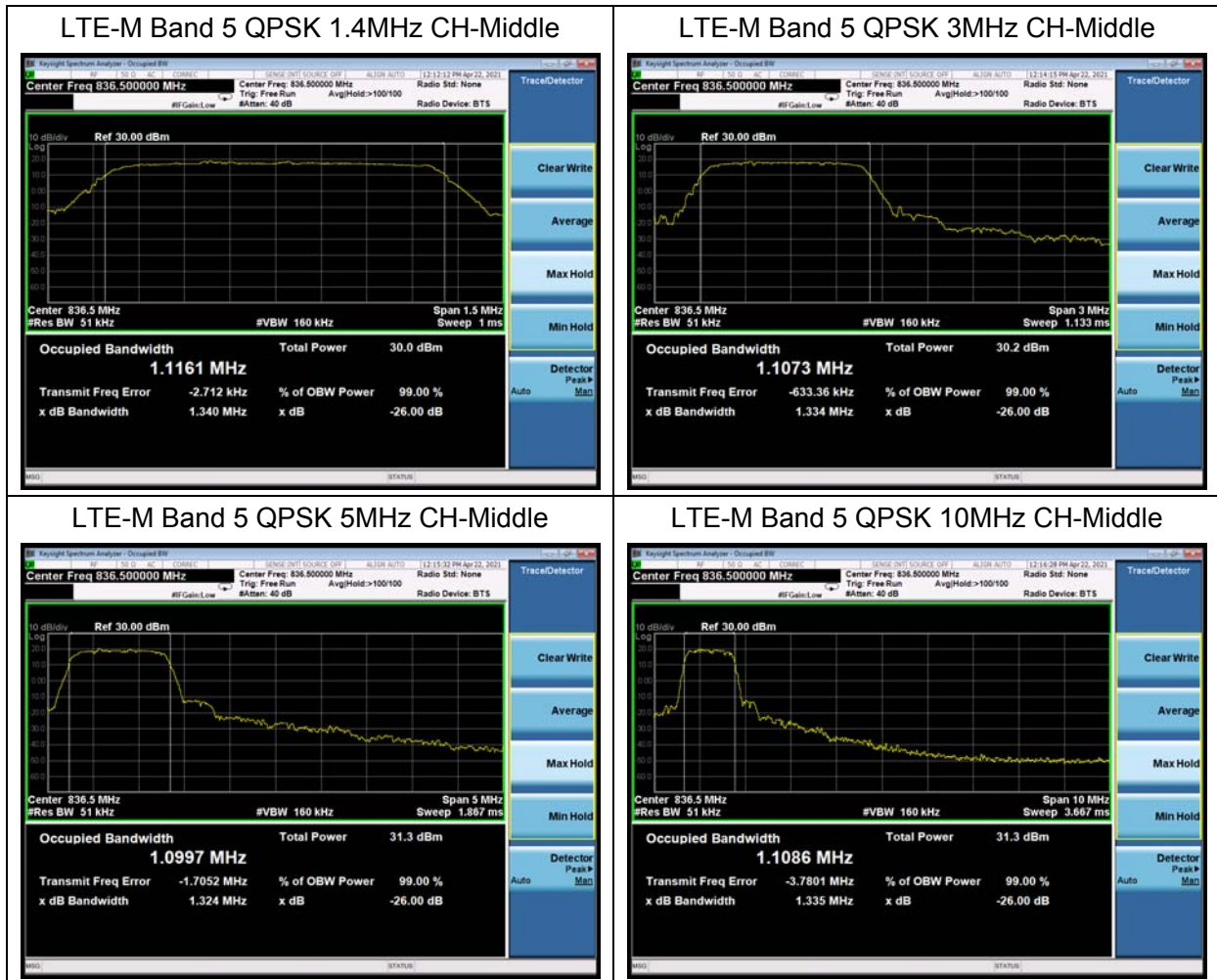

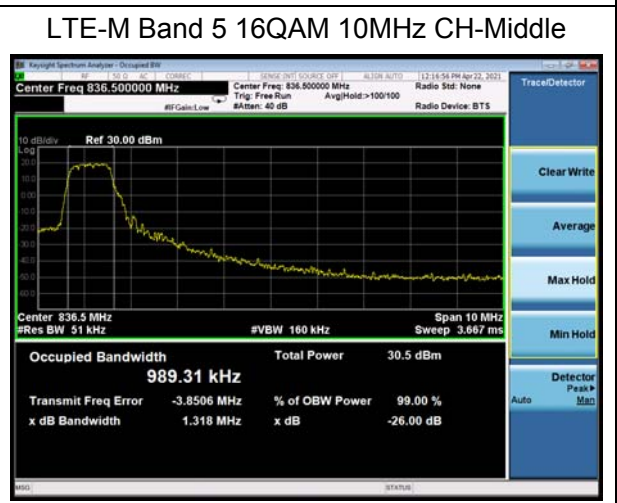
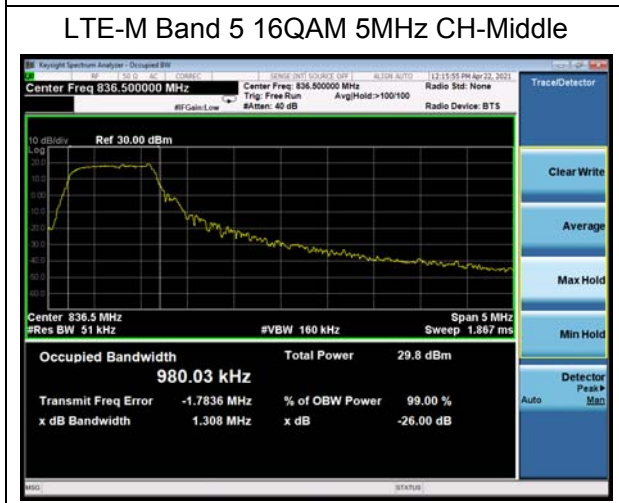
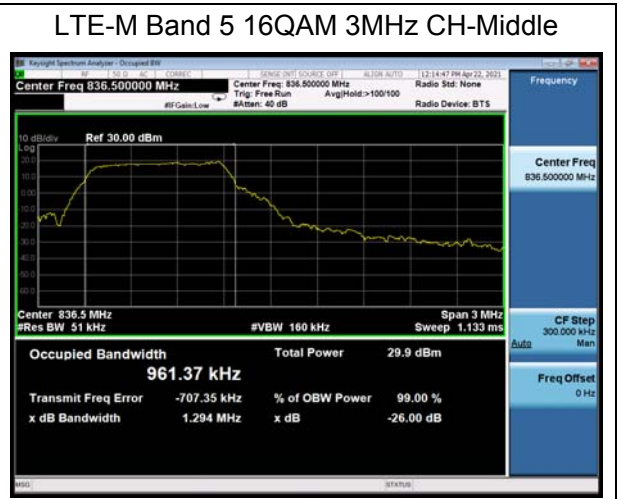

### 6.3. Band Edge Compliance

LTE-M Band 5 QPSK 1.4MHz CH-Low 1RB

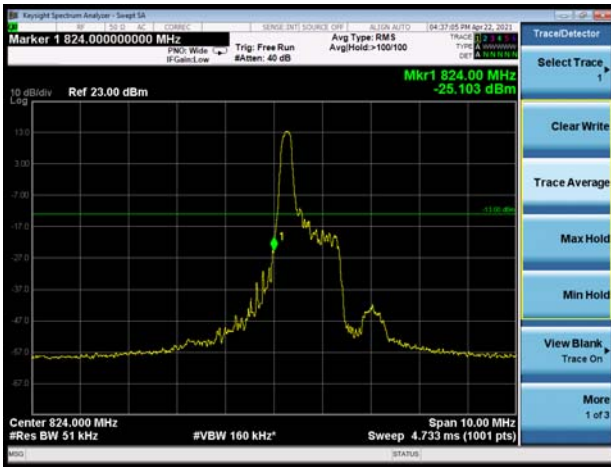

LTE-M Band 5 QPSK 1.4MHz CH-High 1RB



LTE-M Band 5 QPSK 1.4MHz CH-Low 100%RB



LTE-M Band 5 QPSK 1.4MHz CH-High 100%RB

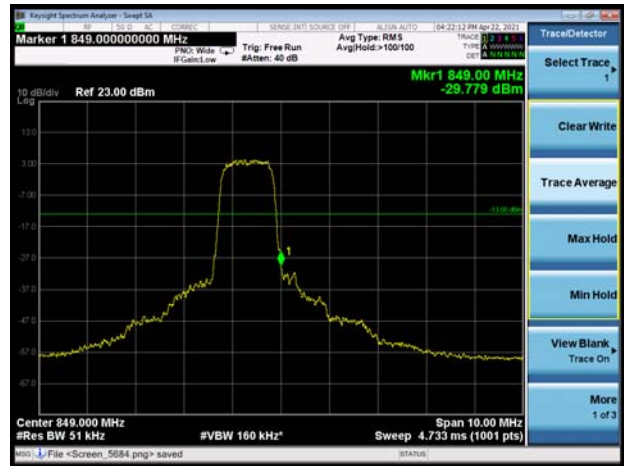

LTE-M Band 5 QPSK 3MHz CH-Low 1RB



LTE-M Band 5 QPSK 3MHz CH-High 1RB



LTE-M Band 5 QPSK 3MHz CH-Low 100%RB

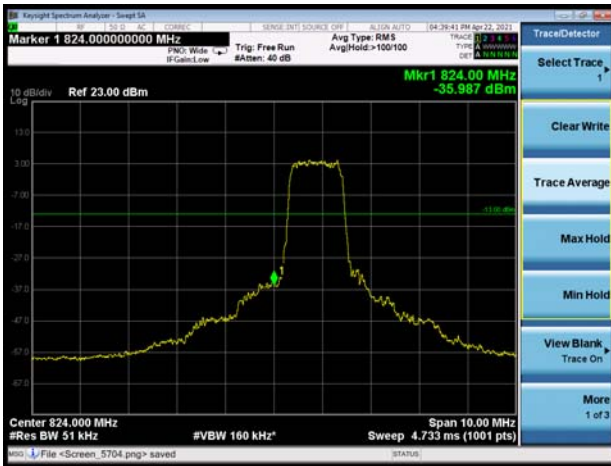

LTE-M Band 5 QPSK 3MHz CH-High 100%RB



LTE-M Band 5 QPSK 5MHz CH-Low 1RB



LTE-M Band 5 QPSK 5MHz CH-High 1RB

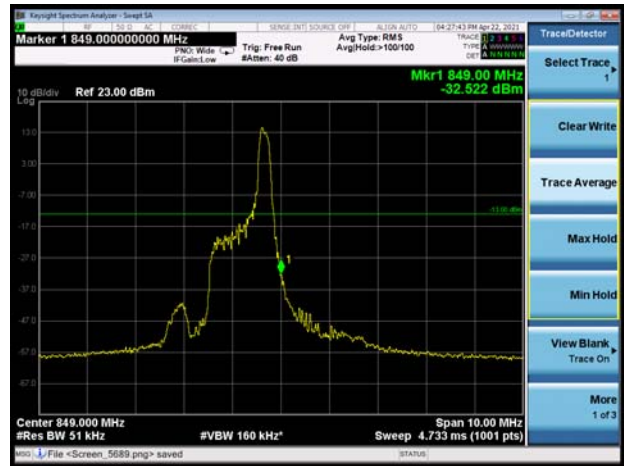

LTE-M Band 5 QPSK 5MHz CH-Low 100%RB

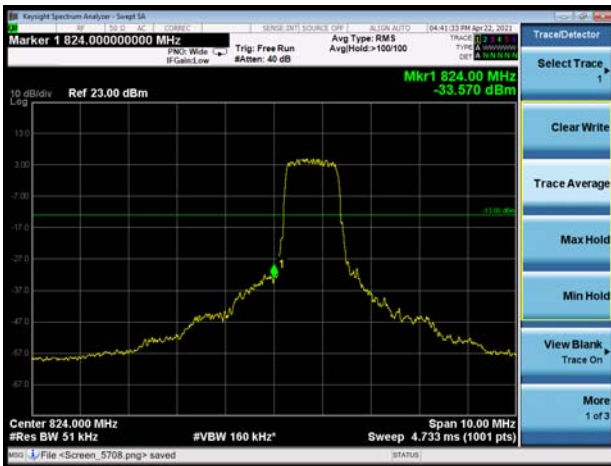

LTE-M Band 5 QPSK 5MHz CH-High 100%RB





LTE-M Band 5 QPSK 10MHz CH-Low 1RB



LTE-M Band 5 QPSK 10MHz CH-High 1RB



LTE-M Band 5 QPSK 10MHz CH-Low 100%RB



LTE-M Band 5 QPSK 10MHz CH-High 100%RB



LTE-M Band 5 16QAM 1.4MHz CH-Low 1RB



LTE-M Band 5 16QAM 1.4MHz CH-High 1RB



LTE-M Band 5 16QAM 1.4MHz CH-Low 100%RB

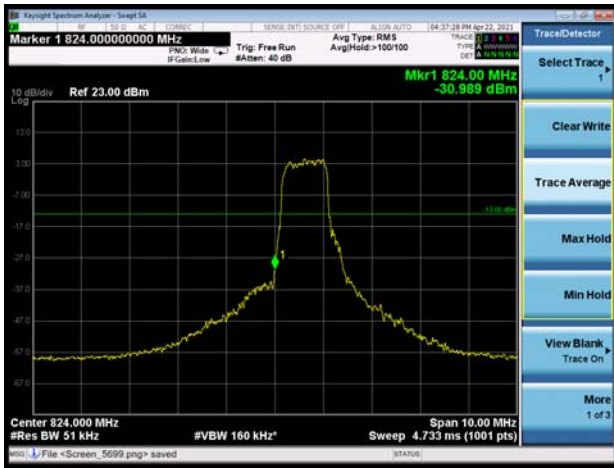

LTE-M Band 5 16QAM 1.4MHz CH-High 100%RB

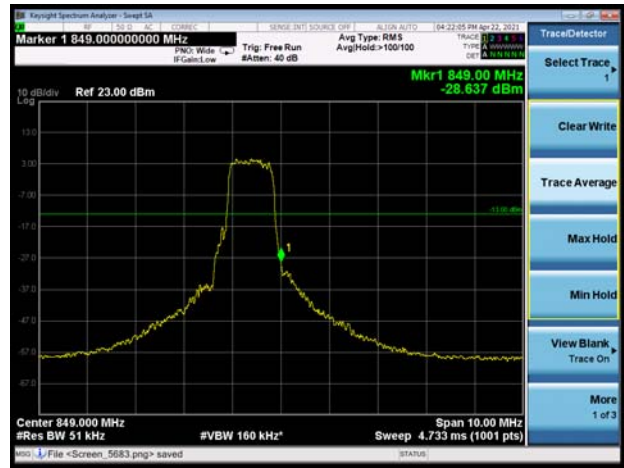

LTE-M Band 5 16QAM 3MHz CH-Low 1RB



LTE-M Band 5 16QAM 3MHz CH-High 1RB



LTE-M Band 5 16QAM 3MHz CH-Low 100%RB

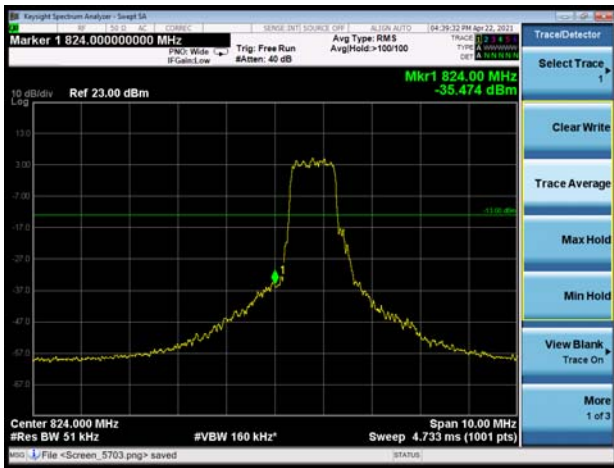

LTE-M Band 5 16QAM 3MHz CH-High 100%RB

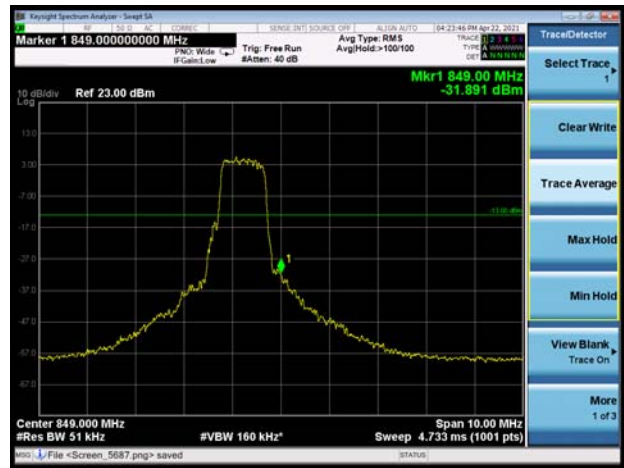

LTE-M Band 5 16QAM 5MHz CH-Low 1RB



LTE-M Band 5 16QAM 5MHz CH-High 1RB

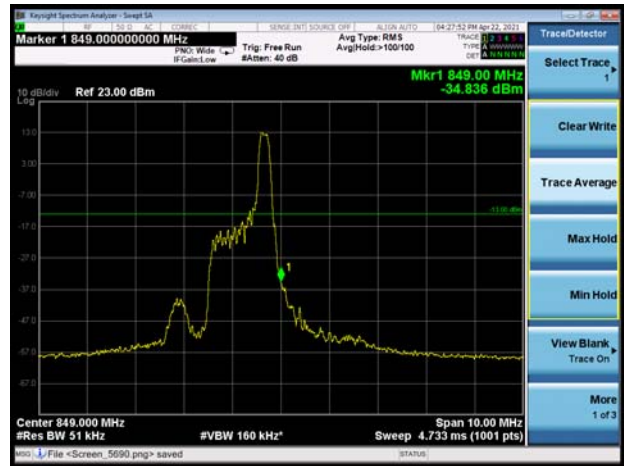

LTE-M Band 5 16QAM 5MHz CH-Low 100%RB

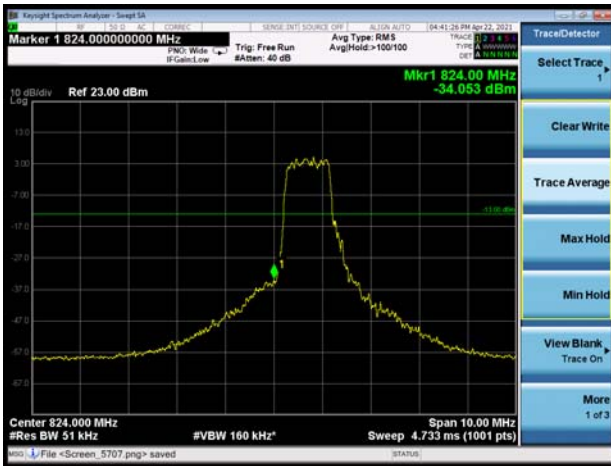

LTE-M Band 5 16QAM 5MHz CH-High 100%RB

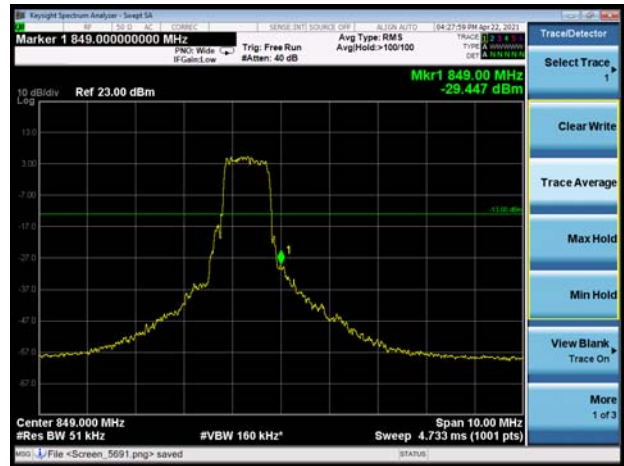

LTE-M Band 5 16QAM 10MHz CH-Low 1RB



LTE-M Band 5 16QAM 10MHz CH-High 1RB



LTE-M Band 5 16QAM 10MHz CH-Low 100%RB

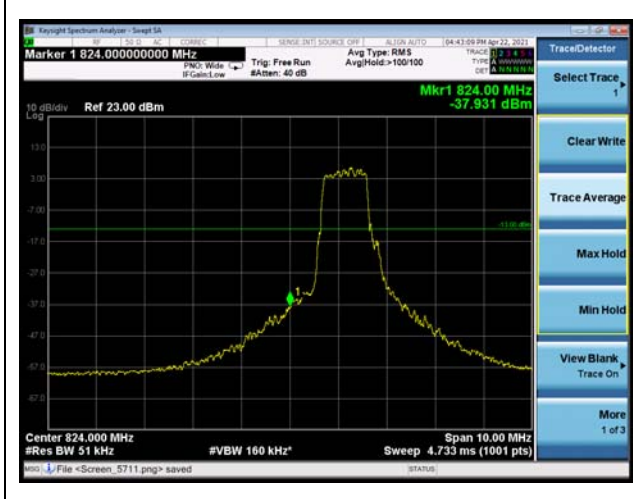

LTE-M Band 5 16QAM 10MHz CH-High 100%RB

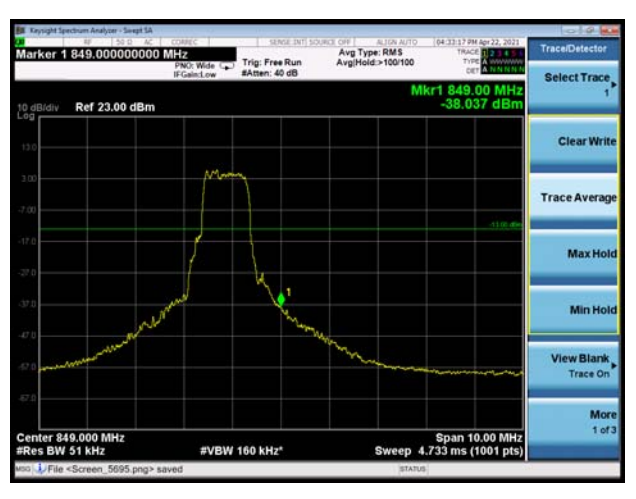

#### 6.4. Peak-to-Average Power Ratio (PAPR)

Mode	Bandwidth	Modulation	Channel/ Frequency (MHz)	Peak-to-Average Power Ratio (PAPR)			Limit (dB)	Conclusion
				Peak (dBm)	Avg (dBm)	PAPR (dB)		
LTE-M Band5	1.4MHz	QPSK	20525/836.5	26.35	16.28	10.07	≤13	PASS
		16QAM	20525/836.5	26.83	15.04	11.79	≤13	PASS
	3MHz	QPSK	20525/836.5	26.18	15.94	10.24	≤13	PASS
		16QAM	20525/836.5	27.09	15.70	11.39	≤13	PASS
	5MHz	QPSK	20525/836.5	27.34	17.10	10.24	≤13	PASS
		16QAM	20525/836.5	27.10	15.53	11.57	≤13	PASS
	10MHz	QPSK	20525/836.5	27.40	17.16	10.24	≤13	PASS
		16QAM	20525/836.5	28.06	16.52	11.54	≤13	PASS

### 6.5. Frequency Stability

LTE-M Band 5						
Condition		Freq.Error (Hz)	Freq.Error (Hz)	Frequency Stability (ppm)	Frequency Stability (ppm)	Verdict
BANDWIDTH	1.4MHz					
Temperature	Voltage	16QAM	QPSK	16QAM	QPSK	
Normal (25°C)	Normal	16.23	7.38	0.00863	0.00393	PASS
Extreme (50°C)		3.68	4.11	0.00196	0.00219	PASS
Extreme (40°C)		12.00	15.46	0.00638	0.00822	PASS
Extreme (30°C)		2.86	15.94	0.00152	0.00848	PASS
Extreme (20°C)		13.17	17.74	0.00700	0.00943	PASS
Extreme (10°C)		10.50	7.13	0.00559	0.00379	PASS
Extreme (0°C)		5.84	15.82	0.00311	0.00842	PASS
Extreme (-10°C)		5.01	1.67	0.00266	0.00089	PASS
Extreme (-20°C)		13.38	6.60	0.00712	0.00351	PASS
Extreme (-30°C)		2.35	8.15	0.00125	0.00433	PASS
25°C	LV	3.97	13.88	0.00211	0.00738	PASS
	HV	9.75	5.08	0.00519	0.00270	PASS
Condition		Freq.Error (Hz)	Freq.Error (Hz)	Frequency Stability (ppm)	Frequency Stability (ppm)	Verdict
BANDWIDTH	3MHz					
Temperature	Voltage	16QAM	QPSK	16QAM	QPSK	
Normal (25°C)	Normal	7.26	14.28	0.00386	0.00760	PASS
Extreme (50°C)		8.87	5.77	0.00472	0.00307	PASS
Extreme (40°C)		2.56	7.11	0.00136	0.00378	PASS
Extreme (30°C)		15.31	13.80	0.00814	0.00734	PASS
Extreme (20°C)		5.90	17.46	0.00314	0.00929	PASS
Extreme (10°C)		3.18	1.57	0.00169	0.00083	PASS
Extreme (0°C)		9.95	13.10	0.00529	0.00697	PASS
Extreme (-10°C)		16.13	2.61	0.00858	0.00139	PASS
Extreme (-20°C)		10.03	16.78	0.00534	0.00893	PASS
Extreme (-30°C)		13.92	11.65	0.00740	0.00620	PASS
25°C	LV	16.39	2.57	0.00872	0.00137	PASS
	HV	5.12	2.72	0.00272	0.00145	PASS
Condition		Freq.Error (Hz)	Freq.Error (Hz)	Frequency Stability (ppm)	Frequency Stability (ppm)	Verdict
BANDWIDTH	5MHz					
Temperature	Voltage	16QAM	QPSK	16QAM	QPSK	
Normal (25°C)	Normal	9.35	5.19	0.00497	0.00276	PASS
Extreme (50°C)		17.60	16.05	0.00936	0.00854	PASS
Extreme (40°C)		3.76	8.13	0.00200	0.00433	PASS

Extreme (30°C)		1.05	17.38	0.00056	0.00925	PASS
Extreme (20°C)		9.65	9.62	0.00513	0.00512	PASS
Extreme (10°C)		13.85	16.08	0.00737	0.00855	PASS
Extreme (0°C)		5.28	14.88	0.00281	0.00791	PASS
Extreme (-10°C)		8.79	4.49	0.00468	0.00239	PASS
Extreme (-20°C)		5.51	10.48	0.00293	0.00557	PASS
Extreme (-30°C)		10.69	3.82	0.00568	0.00203	PASS
25°C	LV	10.05	14.23	0.00534	0.00757	PASS
	HV	16.82	9.46	0.00895	0.00503	PASS
Condition		Freq.Error (Hz)	Freq.Error (Hz)	Frequency Stability (ppm)	Frequency Stability (ppm)	Verdict
BANDWIDTH	10MHz					
Temperature	Voltage	16QAM	QPSK	16QAM	QPSK	
Normal (25°C)	Normal	2.21	15.54	0.00117	0.00827	PASS
Extreme (50°C)		15.18	14.40	0.00807	0.00766	PASS
Extreme (40°C)		4.35	14.67	0.00231	0.00781	PASS
Extreme (30°C)		16.12	12.11	0.00858	0.00644	PASS
Extreme (20°C)		17.24	10.62	0.00917	0.00565	PASS
Extreme (10°C)		1.58	4.19	0.00084	0.00223	PASS
Extreme (0°C)		2.66	13.16	0.00142	0.00700	PASS
Extreme (-10°C)		8.73	11.24	0.00464	0.00598	PASS
Extreme (-20°C)		15.39	4.73	0.00819	0.00251	PASS
Extreme (-30°C)		8.00	11.68	0.00425	0.00621	PASS
25°C	LV	1.07	8.26	0.00057	0.00439	PASS
	HV	4.80	11.24	0.00255	0.00598	PASS

### 6.6. Spurious Emissions at Antenna Terminals

Sweep the whole frequency band through the range from 9kHz to the 10th harmonic of the carrier, the emissions more than 20 dB below the limit are not reported.

The signal beyond the limit is carrier.

LTE-M Band 5 1.4MHz CH-Low 9kHz~20GHz

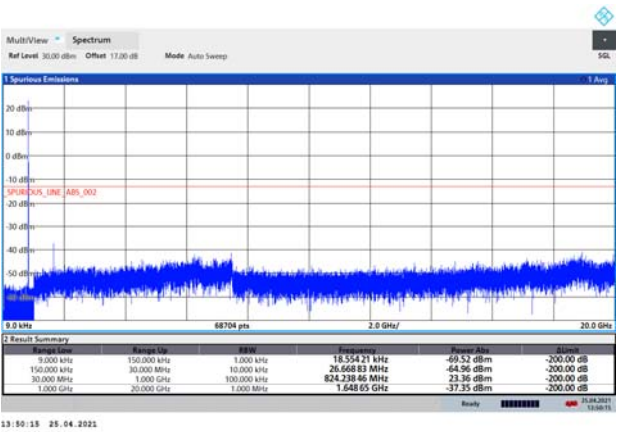

LTE-M Band 5 3MHz CH-Low 9kHz~20GHz

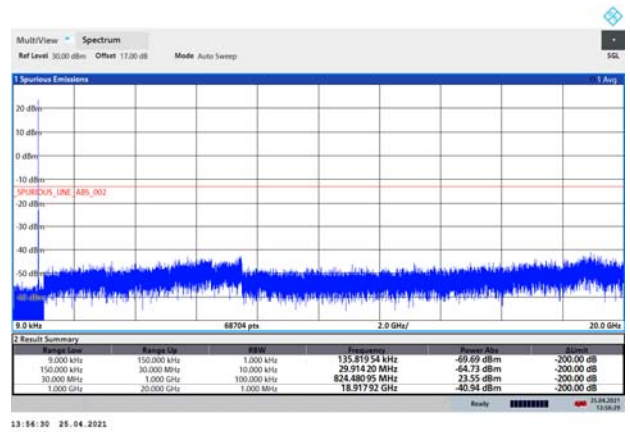

LTE-M Band 5 1.4MHz CH-Middle 9kHz~20GHz

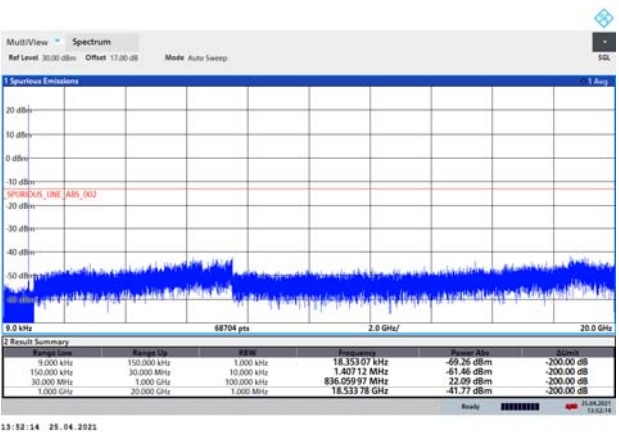

LTE-M Band 5 3MHz CH-Middle 9kHz~20GHz

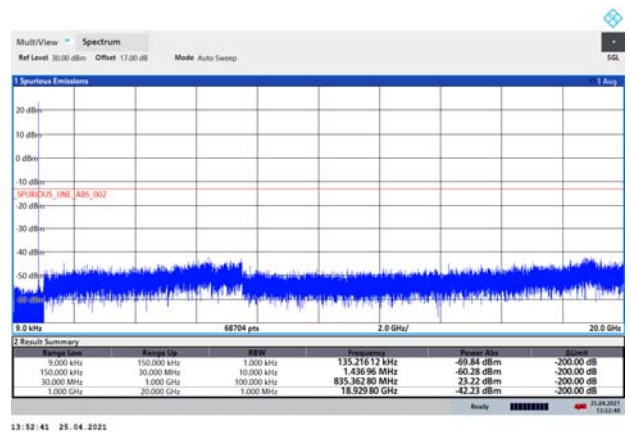

LTE-M Band 5 1.4MHz CH-High 9kHz~20GHz

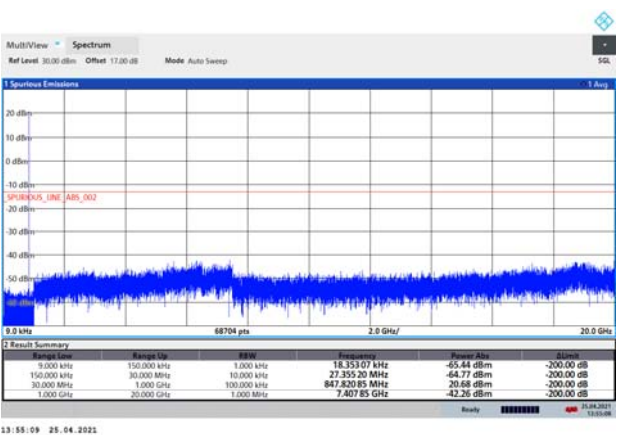

LTE-M Band 5 3MHz CH-High 9kHz~20GHz

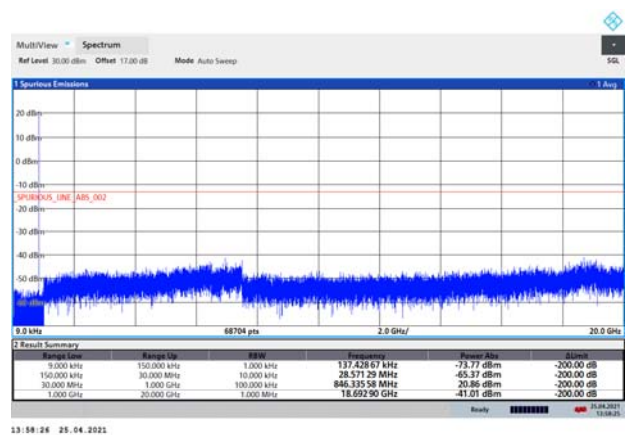



LTE-M Band 5 5MHz CH-Low 9kHz~20GHz

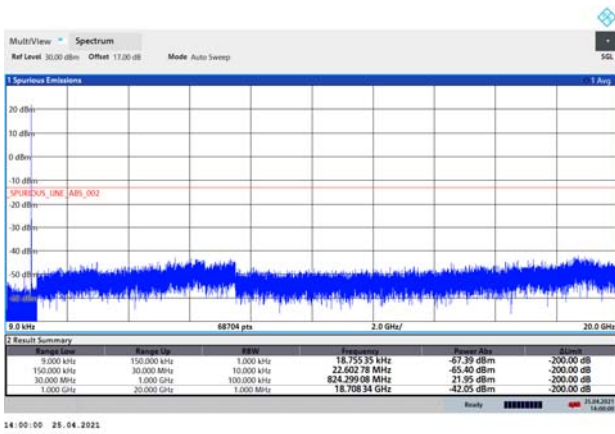

LTE-M Band 5 10MHz CH-Low 9kHz~20GHz

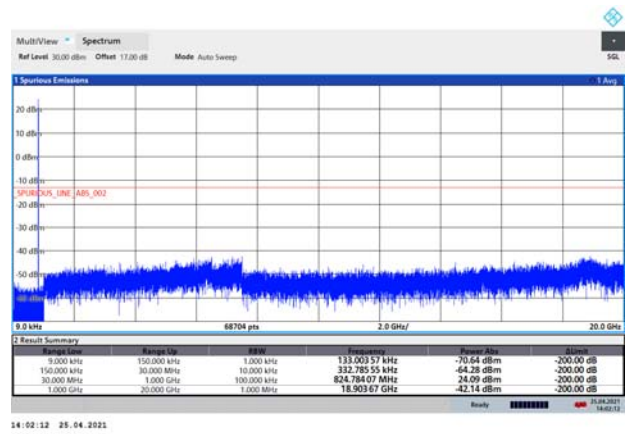

LTE-M Band 5 5MHz CH-Middle 9kHz~20GHz

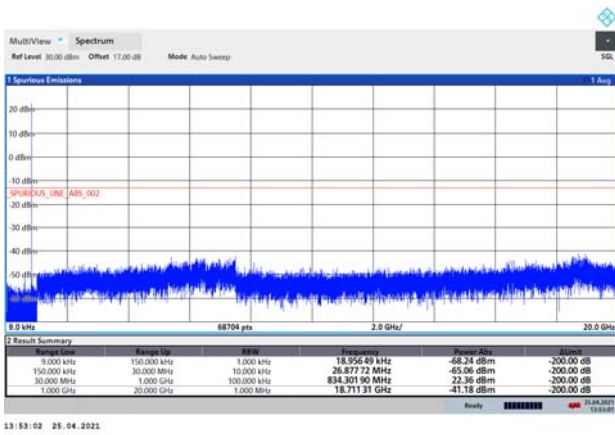

LTE-M Band 5 10MHz CH-Middle 9kHz~20GHz

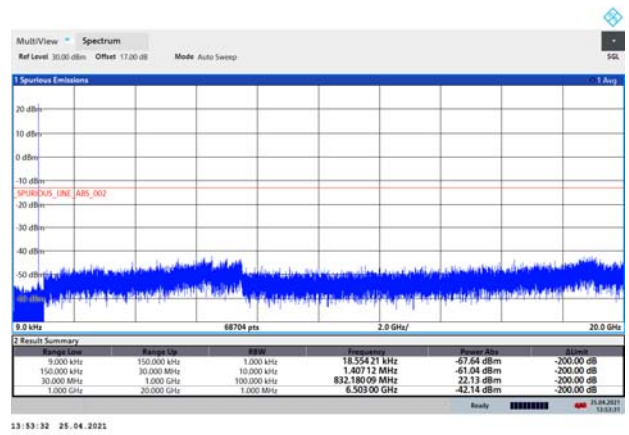

LTE-M Band 5 5MHz CH-High 9kHz~20GHz

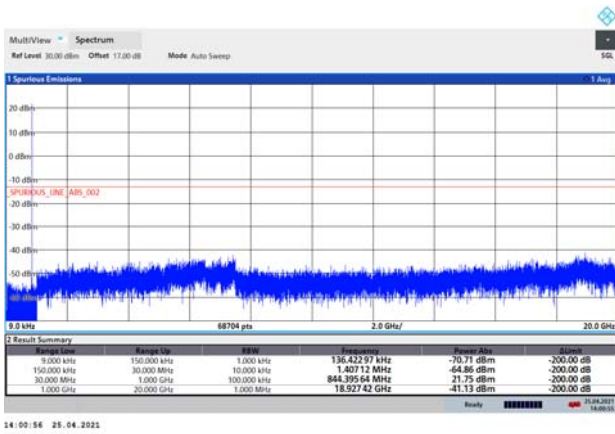

LTE-M Band 5 10MHz CH-High 9kHz~20GHz

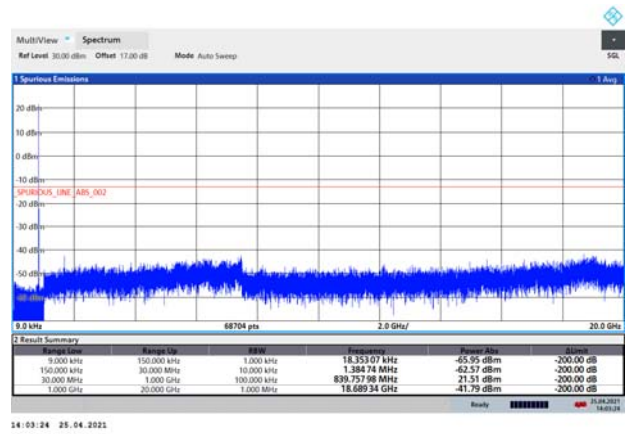

## 6.7. Radiated Spurious Emission

Sweep the whole frequency band through the range from 9kHz to the 10th harmonic of the carrier, the emissions below the noise floor will not be recorded in the report.

LTE-M Band 5 1.4MHz CH-Middle

Harmonic	Frequency (MHz)	SG (dBm)	Cable Loss (dB)	Gain (dBi)	Antenna Polarization	ERP Level (dBm)	Limit (dBm)	Margin (dB)	Azimuth (deg)
2	1673.00	-47.30	1.70	8.70	Horizontal	-42.45	-13.00	29.45	90
3	2509.50	-46.34	2.30	12.00	Horizontal	-38.79	-13.00	25.79	225
4	3346.00	-65.60	2.70	12.70	Horizontal	-57.75	-13.00	44.75	315
5	4182.50	-63.63	3.00	12.50	Horizontal	-56.28	-13.00	43.28	0
6	5019.00	-63.41	3.40	12.50	Horizontal	-56.46	-13.00	43.46	270
7	5855.50	-64.15	3.40	12.80	Horizontal	-56.90	-13.00	43.90	270
8	6692.00	-58.27	4.10	11.50	Horizontal	-53.02	-13.00	40.02	135
9	7528.50	-55.44	4.20	12.20	Horizontal	-49.59	-13.00	36.59	45
10	8365.00	-57.17	4.30	12.50	Horizontal	-51.12	-13.00	38.12	90

Note: 1.The other Spurious RF Radiated emissions level is no more than noise floor.  
2.The worst emission was found in the antenna is Horizontal position.

LTE-M Band 5 5MHz CH-Middle

Harmonic	Frequency (MHz)	SG (dBm)	Cable Loss (dB)	Gain (dBi)	Antenna Polarization	ERP Level (dBm)	Limit (dBm)	Margin (dB)	Azimuth (deg)
2	1668.60	-47.40	1.70	8.70	Horizontal	-42.55	-13.00	29.55	315
3	2503.30	-45.29	2.30	12.00	Horizontal	-37.74	-13.00	24.74	0
4	3466.20	-67.13	2.70	12.70	Horizontal	-59.28	-13.00	46.28	135
5	4215.90	-66.24	3.00	12.50	Horizontal	-58.89	-13.00	45.89	45
6	5165.60	-64.29	3.40	12.50	Horizontal	-57.34	-13.00	44.34	270
7	5815.30	-63.08	3.40	12.80	Horizontal	-55.83	-13.00	42.83	45
8	6765.00	-58.49	4.10	11.50	Horizontal	-53.24	-13.00	40.24	315
9	7614.70	-58.77	4.20	12.20	Horizontal	-52.92	-13.00	39.92	90
10	8464.40	-56.74	4.30	12.50	Horizontal	-50.69	-13.00	37.69	135

Note: 1.The other Spurious RF Radiated emissions level is no more than noise floor.  
2.The worst emission was found in the antenna is Horizontal position.

LTE-M Band 5 10MHz CH-Middle

Harmonic	Frequency (MHz)	SG (dBm)	Cable Loss (dB)	Gain (dBi)	Antenna Polarization	ERP Level (dBm)	Limit (dBm)	Margin (dB)	Azimuth (deg)
2	1664.40	-47.69	1.70	8.70	Horizontal	-42.84	-13.00	29.84	225
3	2496.60	-45.86	2.30	12.00	Horizontal	-38.31	-13.00	25.31	45
4	3346.00	-69.40	2.70	12.70	Horizontal	-61.55	-13.00	48.55	90
5	4182.50	-66.21	3.00	12.50	Horizontal	-58.86	-13.00	45.86	45
6	5019.00	-63.14	3.40	12.50	Horizontal	-56.19	-13.00	43.19	180
7	5855.50	-64.01	3.40	12.80	Horizontal	-56.76	-13.00	43.76	315
8	6692.00	-58.64	4.10	11.50	Horizontal	-53.39	-13.00	40.39	0
9	7528.50	-55.78	4.20	12.20	Horizontal	-49.93	-13.00	36.93	0
10	8365.00	-56.07	4.30	12.50	Horizontal	-50.02	-13.00	37.02	270

Note: 1.The other Spurious RF Radiated emissions level is no more than noise floor.

2.The worst emission was found in the antenna is Horizontal position.

## 7. Main Test Instruments

Date of Testing: (Original) April 21, 2021 ~ May 14, 2021

Name	Manufacturer	Type	Serial Number	Calibration Date	Expiration Date
Base Station Simulator	R&S	CMW500	113824	2020-05-18	2021-05-17
Power Splitter	Hua Xiang	SHX-GF2-2-13	10120101	/	/
Spectrum Analyzer	Key sight	N9010A	MY50210259	2020-05-18	2021-05-17
Universal Radio Communication Tester	Key sight	E5515C	MY48367192	2020-05-27	2021-05-26
Signal Analyzer	R&S	FSV30	100815	2020-12-13	2021-12-12
Loop Antenna	SCHWARZBECK	FMZB1519	1519-047	2020-04-02	2023-04-01
TRILOG Broadband Antenna	SCHWARZBECK	VULB 9163	391	2019-12-16	2021-12-15
Horn Antenna	R&S	HF907	102723	2018-08-11	2021-08-10
Signal generator	R&S	SMB 100A	102594	2020-05-18	2021-05-17
Climatic Chamber	ESPEC	SU-242	93000506	2017-12-17	2020-12-16
Preamplifier	R&S	SCU18	102327	2020-05-18	2021-05-17
MOB COMMS DC SUPPLY	Keysight	66319D	MY43004105	2020-05-18	2021-05-17
RF Cable	Agilent	SMA 15cm	0001	2020-12-12	2021-06-11
Software	R&S	EMC32	9.26.0	/	/

Date of Testing: (Variant 1) January 19, 2022

Name	Manufacturer	Type	Serial Number	Calibration Date	Expiration Date
Base Station Simulator	R&S	CMW500	113824	2021-05-15	2022-05-14
Climate Chamber	Weiss	VT4002	58226119450010	2021-05-15	2022-05-14
Spectrum Analyzer	Key sight	N9020	MY52330084	2021-05-15	2022-05-14
Signal Analyzer	R&S	FSV3030	101411	2021-12-12	2022-12-12

## ANNEX A: The EUT Appearance

The EUT Appearance is submitted separately.

## ANNEX B: Test Setup Photos

The Test Setup Photos is submitted separately.

## **ANNEX C: Product Change Description (Variant 1)**

The Product Change Description are submitted separately.

## ANNEX D: Product Change Description (Variant 2)

The Product Change Description are submitted separately.

\*\*\*\*\* END OF REPORT \*\*\*\*\*