

RF MEASUREMENT REPORT

FCC ID: XMR202212EG25GL
Application: Quectel Wireless Solutions Co., Ltd.
Product: LTE CAT4 Module
Model No.: EG25-GL, EG25-GL MINIPCIE
Brand Name: QUECTEL
FCC Rule Part(s): Part 90 Subpart S
Test Procedure(s): ANSI C63.26: 2015
Result: Complies
Received Date: 2022-11-23
Test Date: 2022-11-24 ~ 2023-02-09

Reviewed By:

Sunny Sun

Approved By:

Robin Wu



The test results relate only to the samples tested.

This equipment has been shown to be capable of compliance with the applicable technical standards as indicated in the measurement report and was tested in accordance with the measurement procedures specified in ANSI C63.26-2015. Test results reported herein relate only to the item(s) tested.

The test report shall not be reproduced except in full without the written approval of MRT Technology (Suzhou) Co., Ltd.

Revision History

Report No.	Version	Description	Issue Date	Note
2211RSU065-U3	Rev. 01	Initial Report	2023-02-26	Valid

CONTENTS

Description	Page
1. General Information.....	5
1.1. Applicant	5
1.2. Manufacturer	5
1.3. Testing Facility	5
1.4. Product Information.....	6
1.5. Radio Specification under Testing.....	6
1.6. Description of Available Antennas.....	7
1.7. Test Methodology	7
2. Test Configuration	8
2.1. Test System Connection Diagram.....	8
2.2. Test Environment Condition	8
3. Measuring Instrument	9
4. Decision Rules and Measurement Uncertainty.....	10
4.1. Decision Rules	10
4.2. Measurement Uncertainty.....	10
5. Test Result	11
5.1. Summary.....	11
5.2. Occupied Bandwidth Measurement.....	12
5.2.1. Test Limit	12
5.2.2. Test Procedure.....	12
5.2.3. Test Setting	12
5.2.4. Test Setup	12
5.2.5. Test Result	12
5.3. Frequency Stability Measurement	13
5.3.1. Test Limit	13
5.3.2. Test Procedure.....	13
5.3.3. Test Setting	13
5.3.4. Test Setup	14
5.3.5. Test Result	14
5.4. Conducted Output Power Measurement	15
5.4.1. Test Limit	15
5.4.2. Test Procedure.....	15
5.4.3. Test Setting	15
5.4.4. Test Setup	15

5.4.5.	Test Result	15
5.5.	Band Edge Measurement	16
5.5.1.	Test Limit	16
5.5.2.	Test Procedure	16
5.5.3.	Test Setting	16
5.5.4.	Test Setup	17
5.5.5.	Test Result	17
5.6.	Conducted Spurious Emissions Measurement.....	18
5.6.1.	Test Limit	18
5.6.2.	Test Procedure	18
5.6.3.	Test Setting	18
5.6.4.	Test Setup	19
5.6.5.	Test Result	19
5.7.	Radiated Spurious Emissions Measurement.....	20
5.7.1.	Test Limit	20
5.7.2.	Test Procedure	20
5.7.3.	Test Setting	20
5.7.4.	Test Setup	21
5.7.5.	Test Result	22
Appendix A - Test Result		23
A.1	Occupied Bandwidth Test Result.....	23
A.2	Frequency Stability Test Result	26
A.3	Conducted Output Power Test Result	27
A.4	Band Edge Test Result	31
A.5	Conducted Spurious Emissions Test Result	35
A.6	Radiated Spurious Emissions Test Result	39
Appendix B - Test Setup Photograph		40
Appendix C - EUT Photograph		41

1.4. Product Information

Product Name	LTE CAT4 Module
Model No.	EG25-GL, EG25-GL MINIPCIE
Brand Name	QUECTEL
IMEI	865061060011919
GNSS Specification	GPS, GLONASS, Galileo, Bei Dou
GSM Band	GSM 850, PCS1900
UMTS Band	Band 2, 4, 5
E-UTRA Band	Band 2, 4, 5, 7, 12, 13, 25, 26, 38, 41, 66
Operating Temperature	-35 ~ 75 °C
Supply Voltage	3.3 ~ 4.3Vdc, typical 3.8Vdc
Remark: 1. The information of EUT was provided by the manufacturer, and the accuracy of the information shall be the responsibility of the manufacturer. 2. The model difference is the different encapsulation, all the other circuits are the same. This report assessed the EG25-GL model.	

1.5. Radio Specification under Testing

FDD Tx Frequency Range	Band 26: 814 ~ 824 MHz
FDD Rx Frequency Range	Band 26: 859 ~ 869 MHz
Modulation	QPSK, 16QAM
Power Class	3

Note 1: For other features of this EUT, test report will be issued separately.

Note 2: The declared of product specification for EUT presented in the report are provided by the manufacturer, and the manufacturer takes all the responsibilities for the accuracy of product specification.

Note 3: LTE band 26 transmit frequency for part 90 rule is 814 ~ 824MHz and part 22 rule is 824 ~ 849MHz. ERP over 15MHz bandwidth complies the ERP limit line of part 22 rule, therefore ERP of the partial frequency spectrum which falls within part 22 also complies.

1.6. Description of Available Antennas

Technology	Frequency Range (MHz)	Antenna Type	MaxPeak Gain (dBi)
GSM 850	824 ~ 849	Dipole	2.29
PCS 1900	1850 ~ 1910		1.38
WCDMA Band II	1850 ~ 1910		1.38
WCDMA Band IV	1710 ~ 1755		2.00
WCDMA Band V	824 ~ 849		2.13
LTE Band 2	1850 ~ 1910		1.38
LTE Band 4	1710 ~ 1755		2.00
LTE Band 5	824 ~ 849		2.13
LTE Band 7	2500 ~ 2570		2.33
LTE Band 12	699 ~ 716		3.26
LTE Band 13	777 ~ 787		3.98
LTE Band 25	1850 ~ 1915		1.38
LTE Band 26	814 ~ 849		2.13
LTE Band 38	2570 ~ 2620		2.00
LTE Band 41	2496 ~ 2690		2.04
LTE Band 66	1710 ~ 1780		2.00

Note: All antenna information (Antenna type and Peak Gain) is provided by the manufacturer.

1.7. Test Methodology

According to the specifications of the manufacturer, the EUT must comply with the requirements of the following standards:

- ANSI C63.26:2015
- FCC CFR 47 Part 90
- FCC KDB 971168 D01 v03r01: Power Meas License Digital Systems
- FCC KDB 971168 D02 v02r01: Misc Rev Approv License Devices
- FCC KDB 412172 D01 v01r01: Determining ERP and EIRP

2. Test Configuration

2.1. Test System Connection Diagram

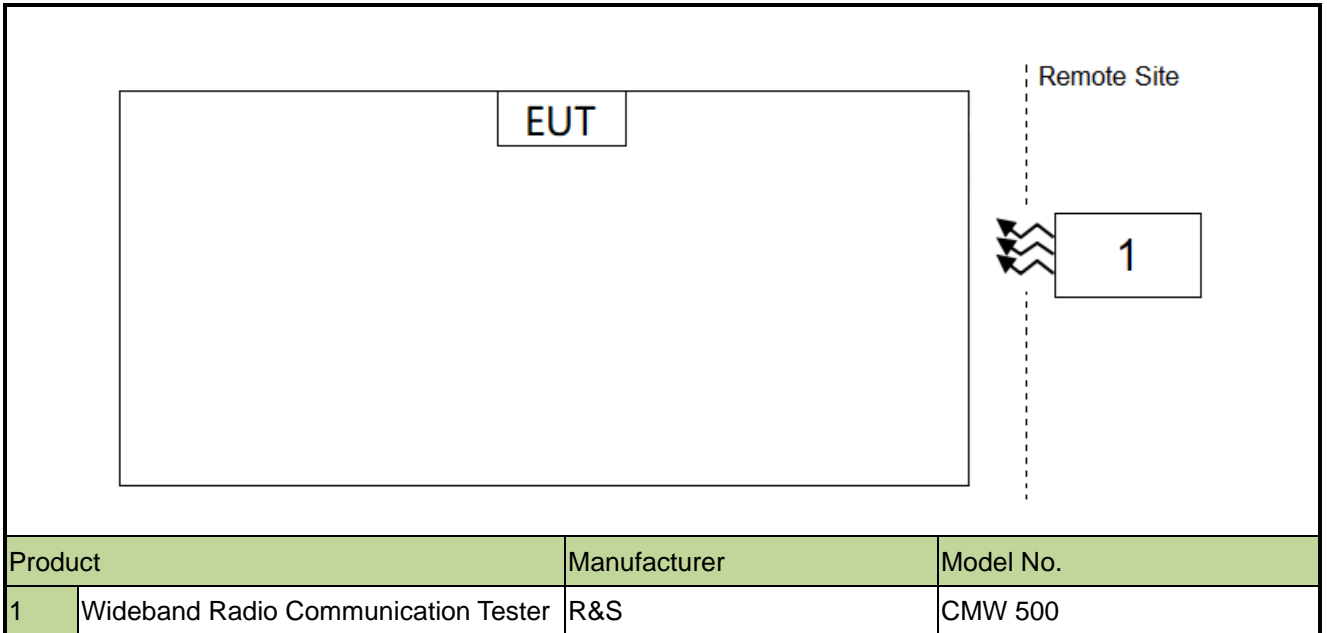

2.2. Test Environment Condition

Ambient Temperature	15 ~ 35°C
Relative Humidity	20% ~ 75%RH

3. Measuring Instrument

Instrument	Manufacturer	Model No.	Asset No.	Cali. Interval	Cali. Due Date	Test Site
Anechoic Chamber	RIKEN	SIP-AC1	MRTSUE06554	1 year	2022-12-23	SIP-AC1
Anechoic Chamber	RIKEN	SIP-AC1	MRTSUE06554	1 year	2023-12-22	SIP-AC1
Preamplifier	EMCI	EMC051845SE	MRTSUE06600	1 year	2023-11-07	SIP-AC1
Horn Antenna	R&S	HF907	MRTSUE06610	1 year	2023-07-13	SIP-AC1
Thermohygrometer	testo	608-H1	MRTSUE06616	1 year	2023-11-01	SIP-AC1
Thermohygrometer	testo	608-H1	MRTSUE06620	1 year	2022-11-28	SIP-AC1
Thermohygrometer	testo	608-H1	MRTSUE06620	1 year	2023-11-27	SIP-AC1
TRILOG Antenna	Schwarzbeck	VULB 9168	MRTSUE06645	1 year	2023-07-30	SIP-AC1
Communication Tester	R&S	CMW500	MRTSUE06243	1 year	2023-10-08	SIP
Thermohygrometer	testo	608-H1	MRTSUE06362	1 year	2023-02-15	WZ-SR6
Shielding Room	HUAMING	WZ-SR6	MRTSUE06443	N/A	N/A	WZ-SR6
Signal Analyzer	Keysight	N9020B	MRTSUE06583	1 year	2023-10-08	WZ-SR6
5G Wireless Test Platform	Keysight	E7515B	MRTSUE06942	1 year	2023-03-03	WZ-SR6
Thermohygrometer	testo	608-H1	MRTSUE06362	1 year	2023-02-15	WZ-SR6
Temperature Chamber	BAOYT	BYH-150CL	MRTSUE06051	1 year	2023-10-08	WZ-TR3
Vibration Test System	DongLing	ES-1-150	MRTSUE06206	1 year	2023-07-07	WZ-TR3
Thermohygrometer	testo	608-H1	MRTSUE06401	1 year	2023-06-06	WZ-TR3
Radio Communication Analyzer	Anritsu	MT8821C	MRTSUE06960	1 year	2023-07-08	WZ-SR6/WZ-TR3
Communication Tester	R&S	CMW500	MRTSUE06108	1 year	2022-11-26	WZ-SR6/WZ-TR3
Communication Tester	R&S	CMW500	MRTSUE06108	1 year	2023-11-25	WZ-SR6/WZ-TR3
Attenuator	MVE	MVE2213	MRTSUE11094	1 year	2023-06-09	WZ
Attenuator	MVE	MVE2213	MRTSUE11095	1 year	2023-06-09	WZ
Attenuator	MVE	MVE2213	MRTSUE11096	1 year	2023-06-09	WZ

Software	Version	Function
EMI V3	V 3.0.0	EMI Test Software
Controller_MF 7802BS	1.02	RE Antenna & Turntable

4. Decision Rules and Measurement Uncertainty

4.1. Decision Rules

The Decision Rule is based on Simple Acceptance in accordance with ISO Guide 98-4: 2012 Clause 8.2. (Measurement uncertainty is not taken into account when stating conformity with a specified requirement.)

4.2. Measurement Uncertainty

Where relevant, the following test uncertainty levels have been estimated for tests performed on the EUT as specified in CISPR 16-4-2. This uncertainty represents an expanded uncertainty expressed at approximately the 95% confidence level using a coverage factor of $k = 2$.

Radiated Spurious Emissions
Measurement Uncertainty for a Level of Confidence of 95% ($U=2Uc(y)$): Horizontal: 9kHz ~ 300MHz: 5.04dB 300MHz ~ 1GHz: 4.95dB 1GHz ~ 40GHz: 6.40dB Vertical: 9kHz ~ 300MHz: 5.24dB 300MHz ~ 1GHz: 6.03dB 1GHz ~ 40GHz: 6.40dB
Conducted Spurious Emissions
Measuring Uncertainty for a Level of Confidence of 95% ($U=2Uc(y)$): 0.78dB
Output Power
Measuring Uncertainty for a Level of Confidence of 95% ($U=2Uc(y)$): 1.13dB
Occupied Bandwidth
Measuring Uncertainty for a Level of Confidence of 95% ($U=2Uc(y)$): 0.28%
Frequency Stability
Measuring Uncertainty for a Level of Confidence of 95% ($U=2Uc(y)$): 76.2Hz

5. Test Result

5.1. Summary

FCC Part Section(s)	Test Description	Test Condition	Verdict
2.1049	Occupied Bandwidth	Conducted	Pass
2.1055, 90.213	Frequency Stability		Pass
90.635	Conducted Output Power		Pass
2.1051, 90.691(a)	Band Edge		Pass
2.1051, 90.691(a)	Spurious Emission		Pass
2.1053, 90.691(a)	Spurious Emissions	Radiated	Pass

Notes:

- 1) The analyzer plots shown in this section were all taken with a correction table loaded into the analyzer. The correction table was used to account for the losses of the cables and attenuators used as part of the system to connect the EUT to the analyzer at all frequencies of interest.
- 2) All supported modulation types were evaluated. The worst-case emission of modulation was selected. Therefore, the Frequency Stability, Channel Band Edge, Radiated & Conducted Spurious Emission were presented worst-case in the test report.
- 3) For radiated emission tests, every axis (X, Y, Z) was also verified. The test results shown in the following sections represent the worst-case emissions.

5.2. Occupied Bandwidth Measurement

5.2.1. Test Limit

The occupied bandwidth, that is the frequency bandwidth such that, below its lower and above its upper frequency limits, the mean powers radiated are each equal to 0.5 percent of the total mean power radiated by a given emission shall be measured.

5.2.2. Test Procedure

ANSI C63.26-2015 - Section 5.4

5.2.3. Test Setting

1. Set center frequency to the nominal EUT channel center frequency
2. RBW = The nominal RBW shall be in the range of 1% to 5% of the anticipated OBW
3. VBW $\geq 3 \times$ RBW
4. Detector = Peak
5. Trace mode = max hold
6. Sweep = auto couple
7. Allow the trace to stabilize
8. Use the 99% power bandwidth function of the instrument and report the measured bandwidth.

5.2.4. Test Setup

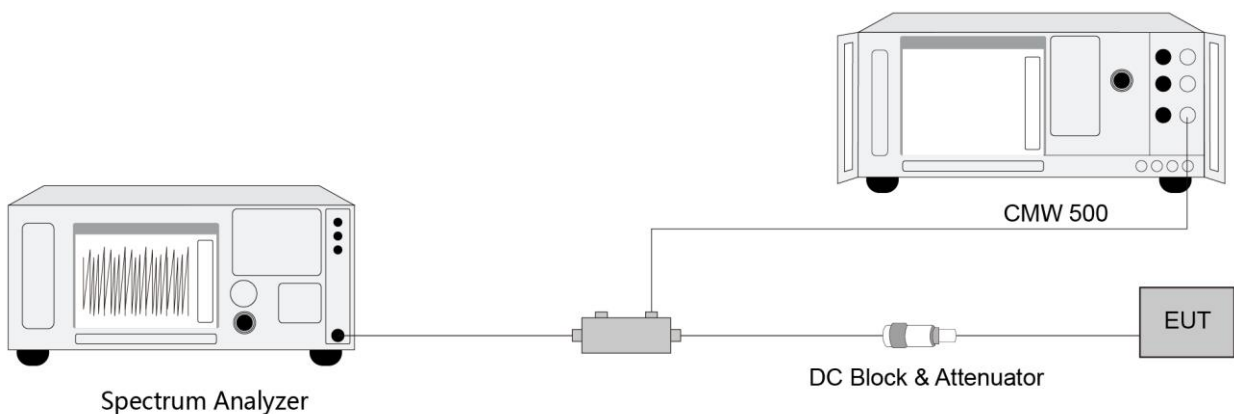

5.2.5. Test Result

Refer to Appendix A.1.

5.3. Frequency Stability Measurement

5.3.1. Test Limit

The frequency stability shall be measured by variation of ambient temperature and variation of primary supply voltage to ensure that the fundamental emission stays within the authorized frequency block. The frequency stability of the transmitter shall be maintained within $\pm 0.00025\%$ ($\pm 2.5\text{ppm}$) of the center frequency.

5.3.2. Test Procedure

ANSI C63.26-2015 - Section 5.6

5.3.3. Test Setting

Frequency Stability Under Temperature Variations:

The equipment under test was connected to an external AC or DC power supply and input rated voltage. RF output was connected to a frequency counter or spectrum analyzer via feed through attenuators. The EUT was placed inside the temperature chamber. Set the spectrum analyzer RBW low enough to obtain the desired frequency resolution and measure EUT 20°C operating frequency as reference frequency. Turn EUT off and set the chamber temperature to highest. After the temperature stabilized for approximately 30 minutes recorded the frequency. Repeat step measure with 10°C decreased per stage until the lowest temperature reached.

Frequency Stability Under Voltage Variations:

Set chamber temperature to 20°C. Use a variable AC power supply / DC power source to power the EUT and set the voltage to rated voltage. Set the spectrum analyzer RBW low enough to obtain the desired frequency resolution and recorded the frequency.

Reduce the input voltage to specify extreme voltage variation ($\pm 15\%$) and endpoint, record the maximum frequency change.

5.3.4. Test Setup

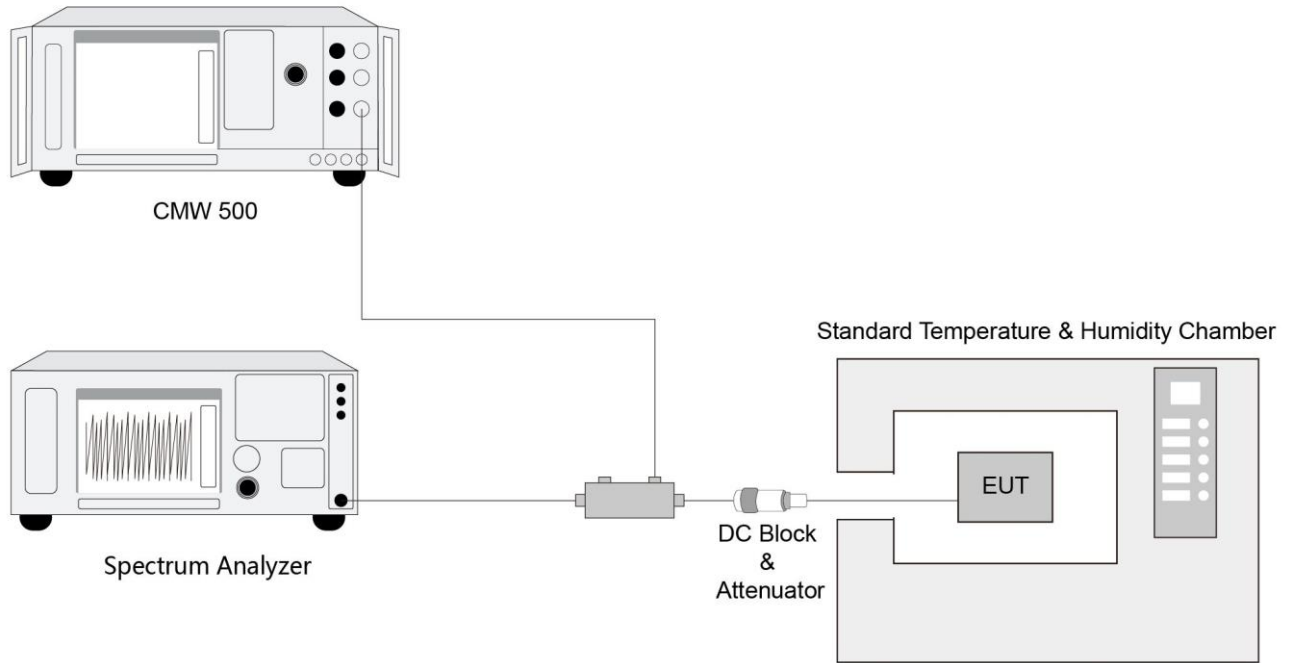

5.3.5. Test Result

Refer to Appendix A.2.

5.4. Conducted Output Power Measurement

5.4.1. Test Limit

The maximum output power of the transmitter for mobile stations is 100 watts (20dBw).

5.4.2. Test Procedure

ANSI C63.26-2015 - Section 5.2

5.4.3. Test Setting

Average power measurements were performed only when the EUT was transmitting at its maximum power control level using a broadband power meter with a pulse sensor. The power meter implemented triggering and gating capabilities which were set up such that power measurements were recorded only during the ON time of the transmitter.

5.4.4. Test Setup



5.4.5. Test Result

Refer to Appendix A.3.

5.5. Band Edge Measurement

5.5.1. Test Limit

Out-of-band emission requirement shall apply only to the “outer” channels included in an EA license and to spectrum adjacent to interior channels used by incumbent licensees. The emission limits are as follows:

- (1) For any frequency removed from the EA licensee's frequency block by up to and including 37.5 kHz, the power of any emission shall be attenuated below the transmitter power (P) in watts by at least $116 \text{ Log}(f/6.1)$ decibels or $50 + 10 \text{ Log}(P)$ decibels or 80 decibels, whichever is the lesser attenuation, where f is the frequency removed from the center of the outer channel in the block in kilohertz and where f is greater than 12.5 kHz.
- (2) For any frequency removed from the EA licensee's frequency block greater than 37.5 kHz, the power of any emission shall be attenuated below the transmitter power (P) in watts by at least $43 + 10\text{Log}_{10}(P)$ decibels or 80 decibels, whichever is the lesser attenuation, where f is the frequency removed from the center of the outer channel in the block in kilohertz and where f is greater than 37.5 kHz.

5.5.2. Test Procedure

ANSI C63.26-2015 - Section 5.7

5.5.3. Test Setting

1. Set the analyzer frequency to low or high channel
2. $\text{RBW} \geq$ The nominal RBW shall be in the range of 1% of the anticipated OBW (in the 1MHz band immediately outside and adjacent to the band edge). For improvement of the accuracy in the measurement of the average power of a noise-like emission, a RBW narrower than the specified reference bandwidth can be used (generally limited to no less than 1% of the OBW), provided that a subsequent integration is performed over the full required measurement bandwidth. This integration should be performed using the spectrum analyzer's band power functions.
3. $\text{VBW} \geq 3 \cdot \text{RBW}$
4. Sweep time = auto
5. Detector = power averaging (rms)
6. Set sweep trigger to “free run.”
7. User gate triggered such that the analyzer only sweeps when the device is transmitting at full power
8. Trace average at least 100 traces in power averaging (rms) mode if sweep is set to auto-couple. To accurately determine the average power over the on and off time of the transmitter, it can be necessary to

increase the number of traces to be averaged above 100, or if using a manually configured sweep time, increase the sweep time.

5.5.4. Test Setup

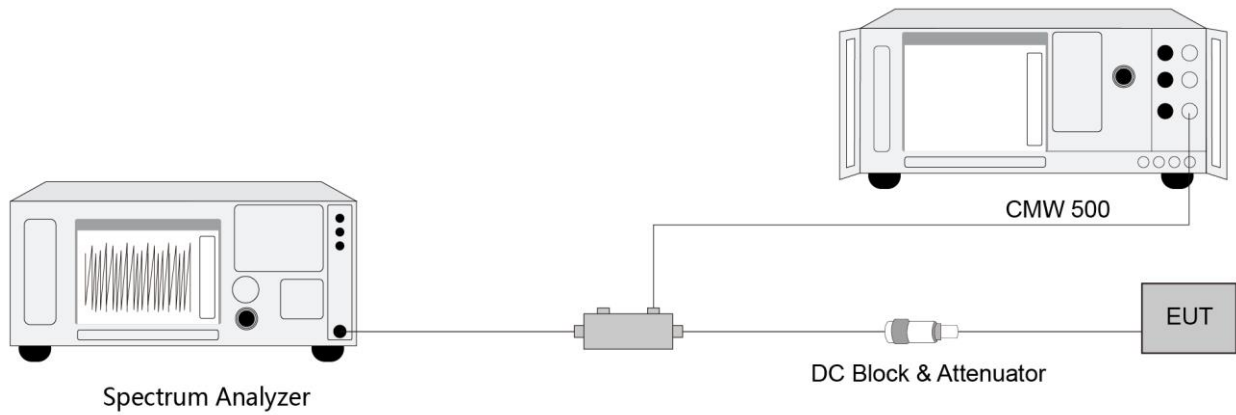

5.5.5. Test Result

Refer to Appendix A.4.

5.6. Conducted Spurious Emissions Measurement

5.6.1. Test Limit

The level of the carrier and the various conducted spurious and harmonic frequencies is measured by means of a calibrated spectrum analyzer. The spectrum is scanned from the lowest frequency generated in the equipment up to a frequency including its 10th harmonic. All out of band emissions are measured with a spectrum analyzer connected to the antenna terminal of the EUT while the EUT is operating at its maximum duty cycle, at maximum power, and at the appropriate frequencies. All data rates were investigated to determine the worst-case configuration. All modes of operation were investigated, and the worst-case configuration results are reported in this section.

For any frequency removed from the EA licensee's frequency block greater than 37.5 kHz, the power of any emission shall be attenuated below the transmitter power (P) in watts by at least $43 + 10\text{Log}_{10}(P)$ decibels or 80 decibels, whichever is the lesser attenuation, where f is the frequency removed from the center of the outer channel in the block in kilohertz and where f is greater than 37.5 kHz.

5.6.2. Test Procedure

ANSI C63.26-2015 - Section 5.7

5.6.3. Test Setting

1. Set the analyzer frequency to low, mid, high channel.
2. RBW = 1MHz
3. VBW \geq 3*RBW
4. Sweep time = auto
5. Detector = power averaging (rms)
6. Set sweep trigger to "free run."
7. User gate triggered such that the analyzer only sweeps when the device is transmitting at full power.
8. Trace average at least 100 traces in power averaging (rms) mode if sweep is set to auto-couple. To accurately determine the average power over the on and off time of the transmitter, it can be necessary to increase the number of traces to be averaged above 100, or if using a manually configured sweep time, increase the sweep time.

5.6.4. Test Setup

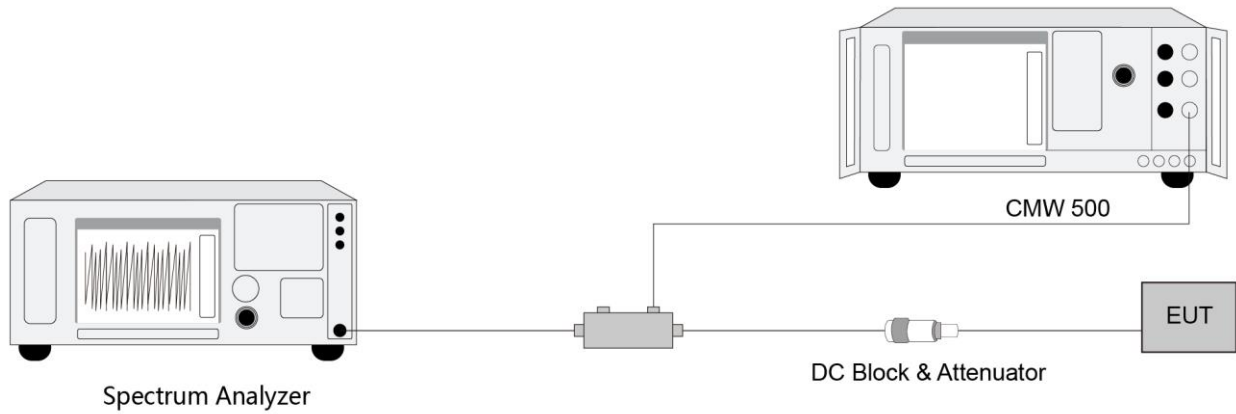

5.6.5. Test Result

Refer to Appendix A.5.

5.7. Radiated Spurious Emissions Measurement

5.7.1. Test Limit

Out of band emissions: The power of any emission outside of the authorized operating frequency ranges must be attenuated below the transmitting power (P) by a factor of at least $43 + 10 \log(P)$ dB. The emission limit equal to -13dBm.

E (dB μ V/m) = EIRP (dBm) - 20 log D + 104.8; where D is the measurement distance in meters. The emission limit equal to 82.3dB μ V/m.

5.7.2. Test Procedure

ANSI C63.26-2015 - Section 5.2.7 & 5.5

5.7.3. Test Setting

1. RBW = 1MHz
2. VBW \geq 3*RBW
3. Sweep time \geq 10 \times (number of points in sweep) \times (transmission symbol period)
4. Detector = Peak
5. Trace mode = max hold
6. The trace was allowed to stabilize

5.7.4. Test Setup

Below 1GHz Test Setup:

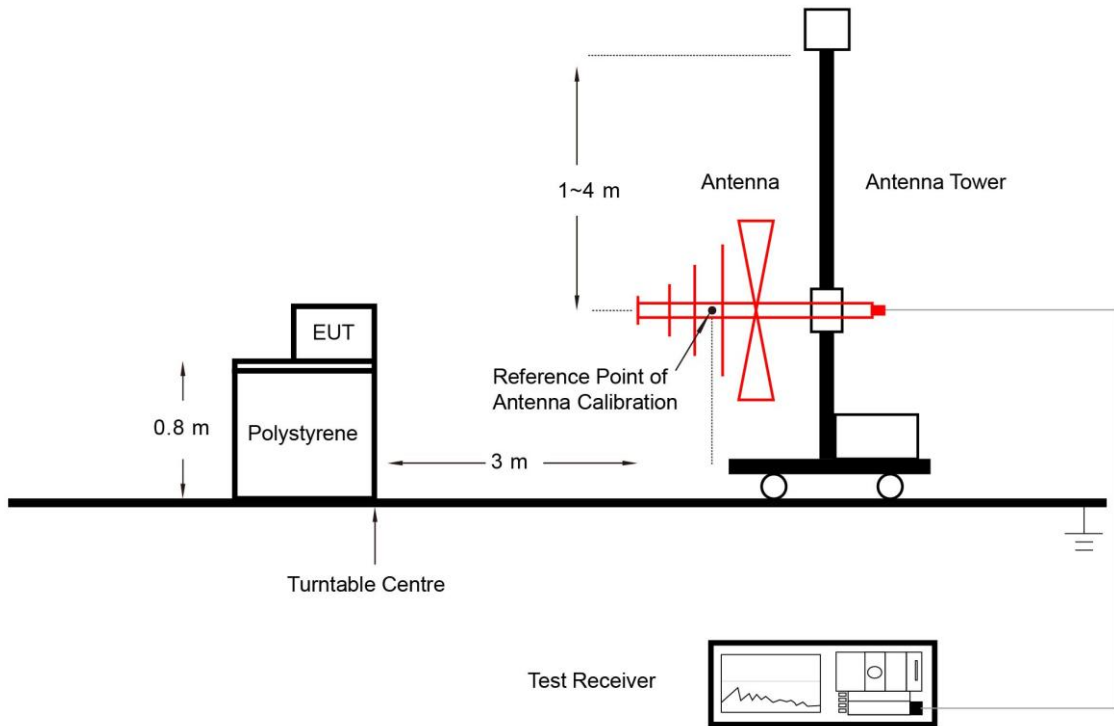

Above 1GHz Test Setup:

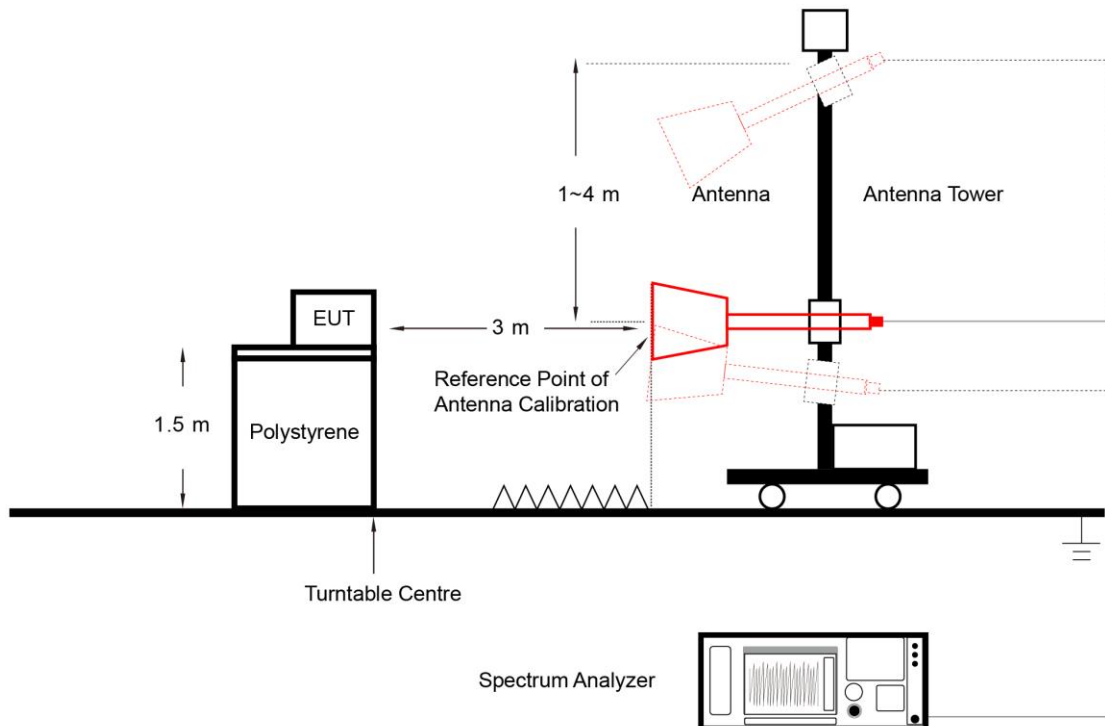

5.7.5. Test Result

Refer to Appendix A.6.

Appendix A - Test Result

A.1 Occupied Bandwidth Test Result

Test Site	WZ-SR6	Test Engineer	Cloud Guo
Test Date	2022/12/09	Test Band	LTE Band 26

Modulation	Frequency (MHz)	Bandwidth (MHz)	99% Bandwidth (MHz)
QPSK	819.0	1.4	1.08
		3	2.68
		5	4.47
		10	8.93
16QAM	819.0	1.4	1.08
		3	2.68
		5	4.47
		10	8.91
QPSK	821.5	15	13.38
16QAM			13.38

99% Bandwidth - QPSK

1.4MHz Channel Bandwidth

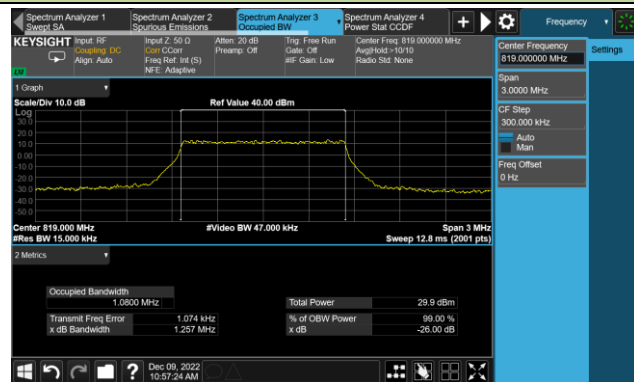

3MHz Channel Bandwidth

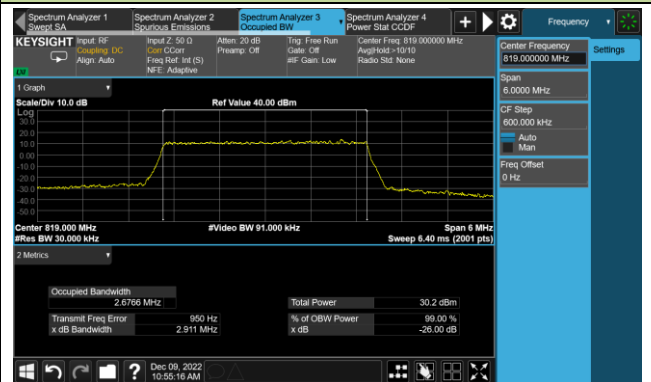

5MHz Channel Bandwidth

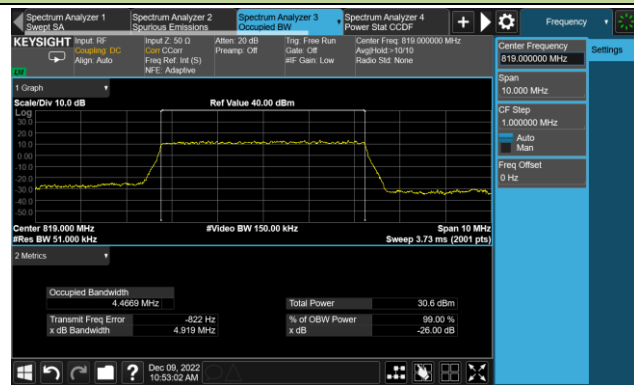

10MHz Channel Bandwidth



15MHz Channel Bandwidth

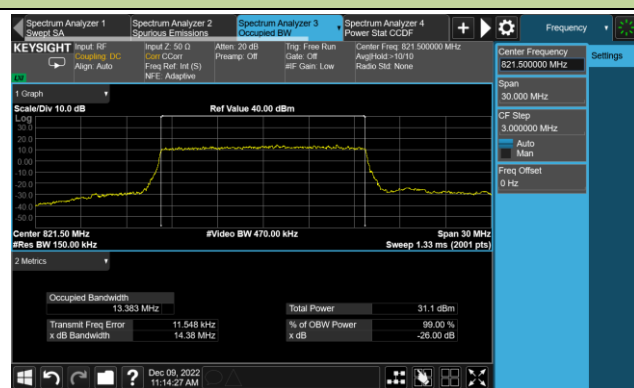

99% Bandwidth - 16QAM

1.4MHz Channel Bandwidth

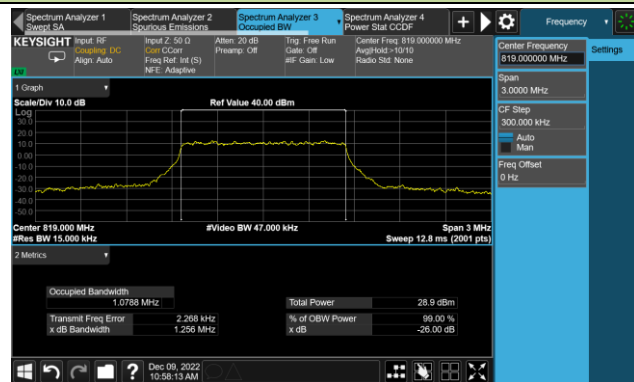

3MHz Channel Bandwidth

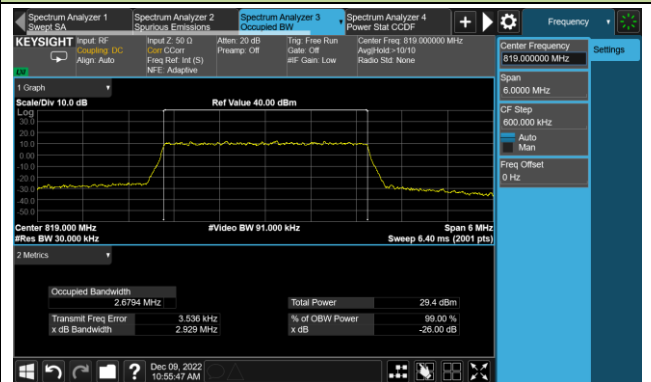

5MHz Channel Bandwidth

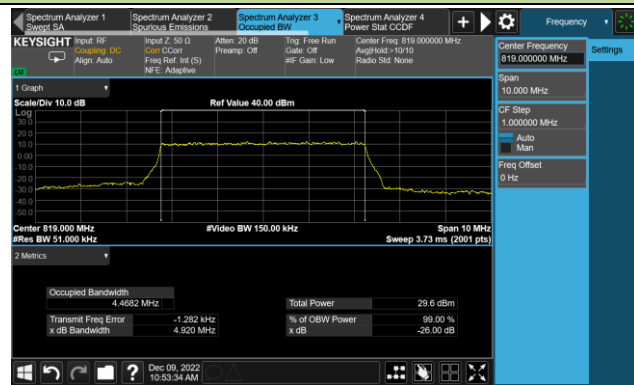

10MHz Channel Bandwidth

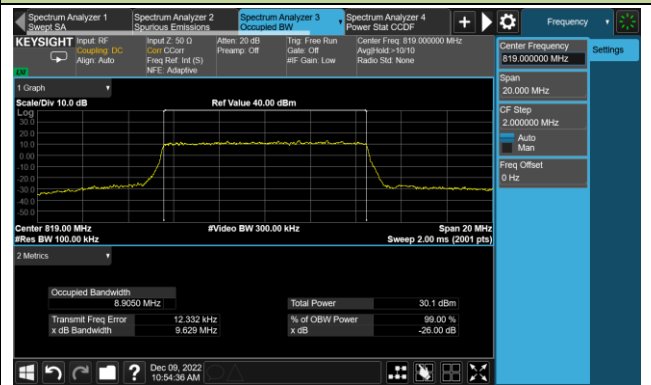

15MHz Channel Bandwidth

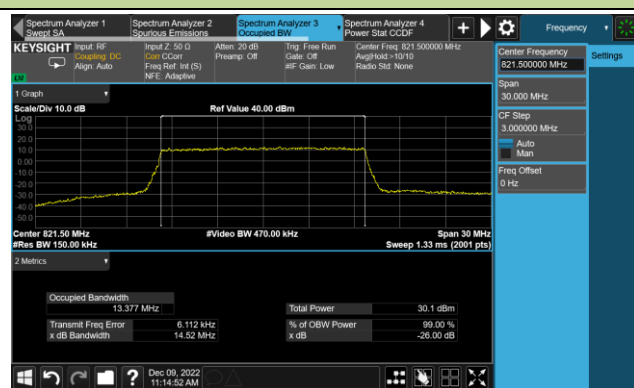

A.2 Frequency Stability Test Result

Test Site	WZ-TR3	Test Engineer	Cloud Guo
Test Date	2022/11/29	Test Band	LTE Band 26

Power (Vdc)	Temp. (°C)	Frequency Tolerance (ppm)
3.80	- 30	-0.0061
	- 20	-0.0038
	- 10	-0.0035
	0	-0.0060
	+ 10	-0.0031
	+ 20 (Ref)	0.0000
	+ 30	-0.0011
	+ 40	-0.0099
	+ 50	-0.0037
4.30	+ 20	0.0002
3.30	+ 20	-0.0012

A.3 Conducted Output Power Test Result

Test Site	WZ-SR6	Test Engineer	Cloud Guo
Test Date	2022/12/08	Test Band	LTE Band 26

Frequency (MHz)	Channel BW (MHz)	RB Size	RB Offset	Output Power (dBm)	Output Power (W)	Limit (W)
QPSK						
814.7	1.4	1	0	22.70	0.1862	< 100
819.0				22.70	0.1862	< 100
823.3				23.04	0.2014	< 100
814.7	1.4	1	2	22.83	0.1919	< 100
819.0				22.62	0.1828	< 100
823.3				22.98	0.1986	< 100
814.7	1.4	1	6	22.89	0.1945	< 100
819.0				22.64	0.1837	< 100
823.3				22.81	0.1910	< 100
814.7	1.4	6	0	21.92	0.1556	< 100
819.0				21.81	0.1517	< 100
823.3				21.93	0.1560	< 100
815.5	3	1	0	22.81	0.1910	< 100
819.0				22.69	0.1858	< 100
822.5				22.66	0.1845	< 100
815.5	3	1	7	22.98	0.1986	< 100
819.0				22.80	0.1905	< 100
822.5				23.06	0.2023	< 100
815.5	3	1	14	22.90	0.1950	< 100
819.0				22.51	0.1782	< 100
822.5				22.85	0.1928	< 100
815.5	3	15	0	21.99	0.1581	< 100
819.0				21.83	0.1524	< 100
822.5				21.95	0.1567	< 100

Frequency (MHz)	Channel BW (MHz)	RB Size	RB Offset	Output Power (dBm)	Output Power (W)	Limit (W)
QPSK						
816.5	5	1	0	22.81	0.1910	< 100
819.0				22.84	0.1923	< 100
821.5				22.85	0.1928	< 100
816.5	5	1	12	22.92	0.1959	< 100
819.0				22.69	0.1858	< 100
821.5				23.03	0.2009	< 100
816.5	5	1	24	22.70	0.1862	< 100
819.0				22.56	0.1803	< 100
821.5				22.96	0.1977	< 100
816.5	5	25	0	21.80	0.1514	< 100
819.0				21.73	0.1489	< 100
821.5				21.99	0.1581	< 100
819.0	10	1	0	22.76	0.1888	< 100
		1	24	22.85	0.1928	< 100
		1	49	22.71	0.1866	< 100
		50	0	21.89	0.1545	< 100
821.5	15	1	0	22.76	0.1888	< 100
		1	36	22.96	0.1977	< 100
		1	74	22.91	0.1954	< 100
		75	0	21.97	0.1574	< 100

Frequency (MHz)	Channel BW (MHz)	RB Size	RB Offset	Output Power (dBm)	Output Power (W)	Limit (W)
16QAM						
814.7	1.4	1	0	21.80	0.1514	< 100
819.0				21.45	0.1396	< 100
823.3				21.49	0.1409	< 100
814.7	1.4	1	2	21.76	0.1500	< 100
819.0				21.41	0.1384	< 100
823.3				21.17	0.1309	< 100
814.7	1.4	1	6	21.50	0.1413	< 100
819.0				21.47	0.1403	< 100
823.3				21.70	0.1479	< 100
814.7	1.4	6	0	20.81	0.1205	< 100
819.0				20.59	0.1146	< 100
823.3				20.84	0.1213	< 100
815.5	3	1	0	21.54	0.1426	< 100
819.0				21.31	0.1352	< 100
822.5				21.63	0.1455	< 100
815.5	3	1	7	21.81	0.1517	< 100
819.0				21.73	0.1489	< 100
822.5				21.75	0.1496	< 100
815.5	3	1	14	21.64	0.1459	< 100
819.0				21.46	0.1400	< 100
822.5				21.51	0.1416	< 100
815.5	3	15	0	20.98	0.1253	< 100
819.0				20.84	0.1213	< 100
822.5				21.01	0.1262	< 100

Frequency (MHz)	Channel BW (MHz)	RB Size	RB Offset	Output Power (dBm)	Output Power (W)	Limit (W)
16QAM						
816.5	5	1	0	21.62	0.1452	< 100
819.0				21.49	0.1409	< 100
821.5				21.41	0.1384	< 100
816.5	5	1	12	21.90	0.1549	< 100
819.0				21.72	0.1486	< 100
821.5				21.85	0.1531	< 100
816.5	5	1	24	21.20	0.1318	< 100
819.0				21.11	0.1291	< 100
821.5				21.38	0.1374	< 100
816.5	5	25	0	20.71	0.1178	< 100
819.0				20.77	0.1194	< 100
821.5				20.84	0.1213	< 100
819.0	10	1	0	21.44	0.1393	< 100
		1	24	21.58	0.1439	< 100
		1	49	21.27	0.1340	< 100
		50	0	21.04	0.1271	< 100
821.5	15	1	0	21.60	0.1445	< 100
		1	36	22.02	0.1592	< 100
		1	74	21.78	0.1507	< 100
		75	0	20.86	0.1219	< 100

A.4 Band Edge Test Result

Test Site	WZ-SR6	Test Engineer	Cloud Guo
Test Date	2022/11/28	Test Band	LTE Band 26

1.4MHz Channel Bandwidth - 1RB

Lower Band Edge

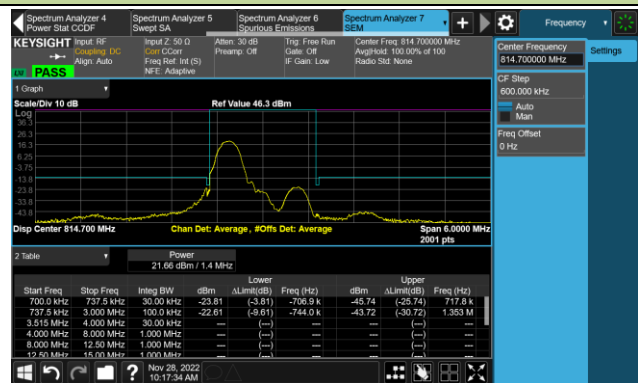

Upper Band Edge

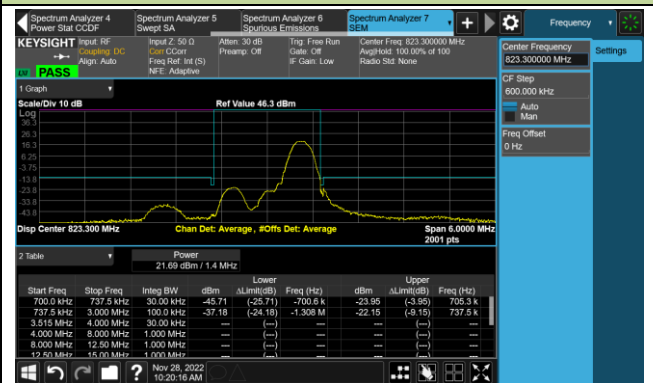

3MHz Channel Bandwidth - 1RB

Lower Band Edge

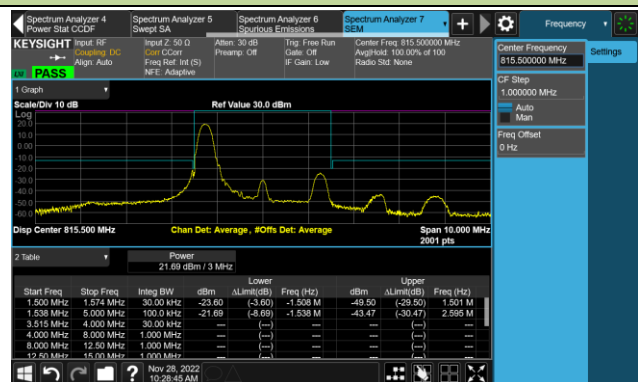

Upper Band Edge

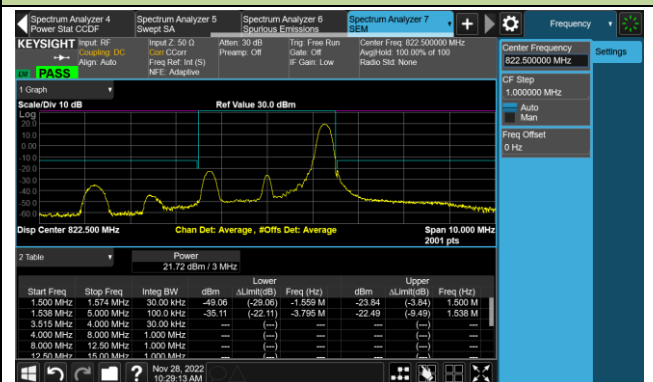

5MHz Channel Bandwidth - 1RB

Lower Band Edge

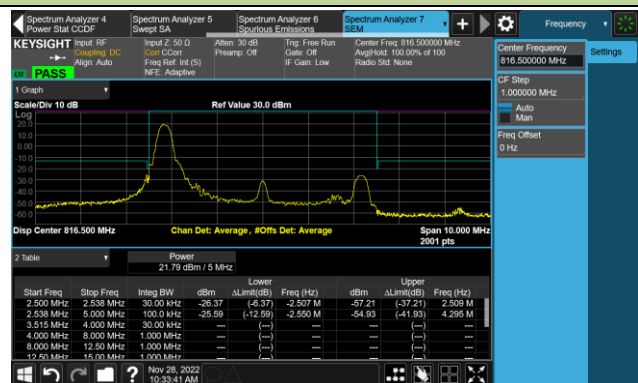

Upper Band Edge

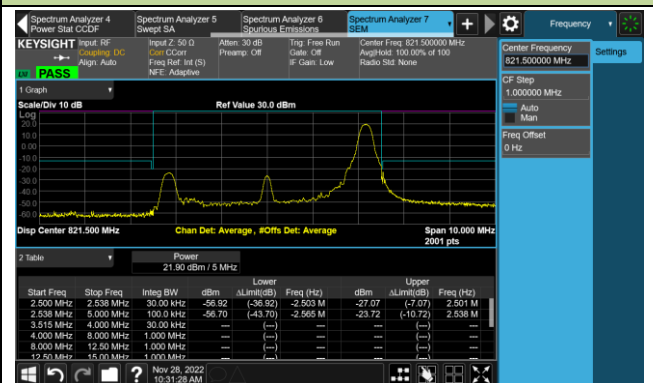

10MHz Channel Bandwidth - 1RB

Lower Band Edge

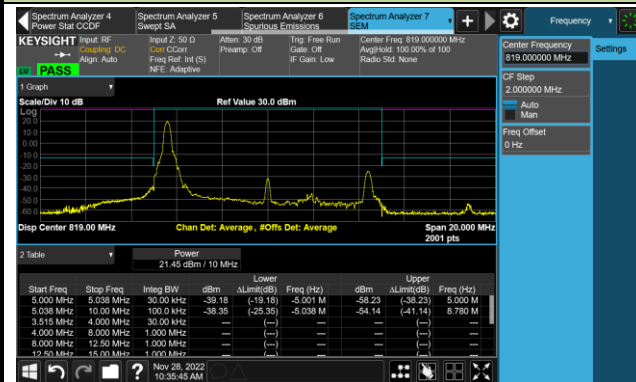

Upper Band Edge

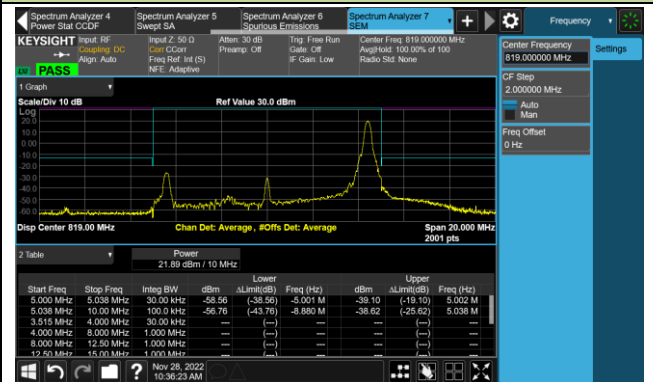

15MHz Channel Bandwidth - 1RB

Lower Band Edge

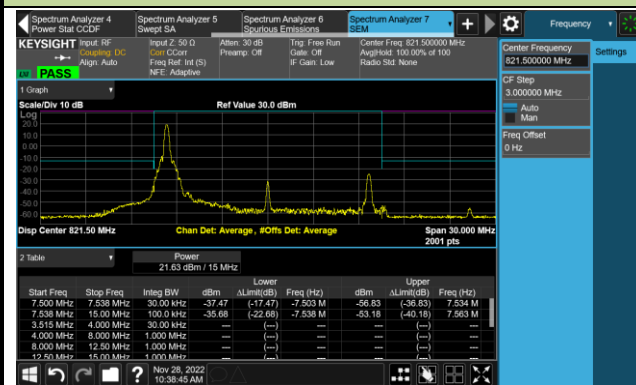

Upper Band Edge

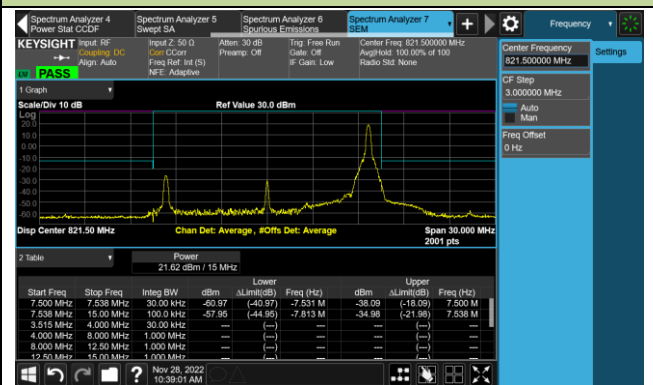

1.4MHz Channel Bandwidth - Full RB

Lower Band Edge

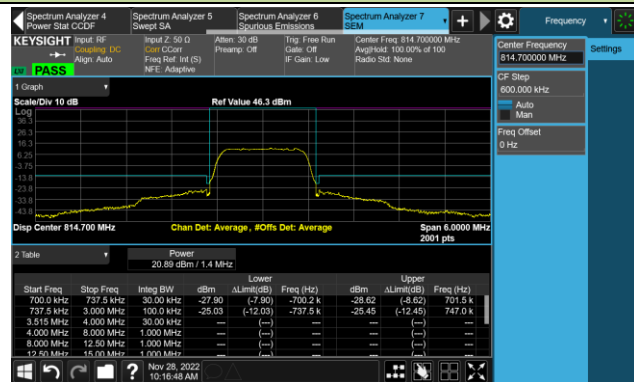

Upper Band Edge

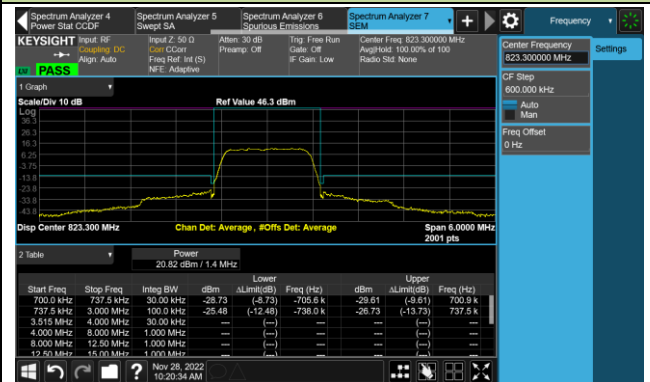

3MHz Channel Bandwidth - Full RB

Lower Band Edge

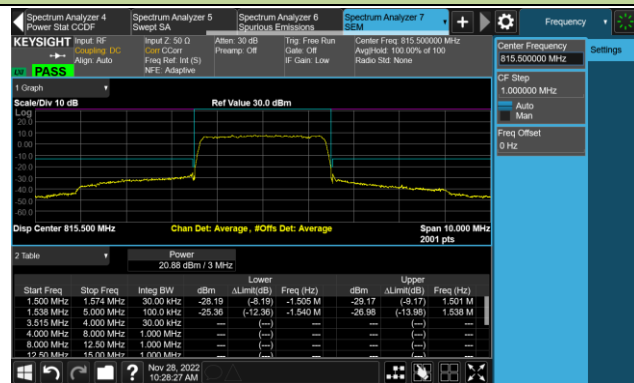

Upper Band Edge



5MHz Channel Bandwidth - Full RB

Lower Band Edge

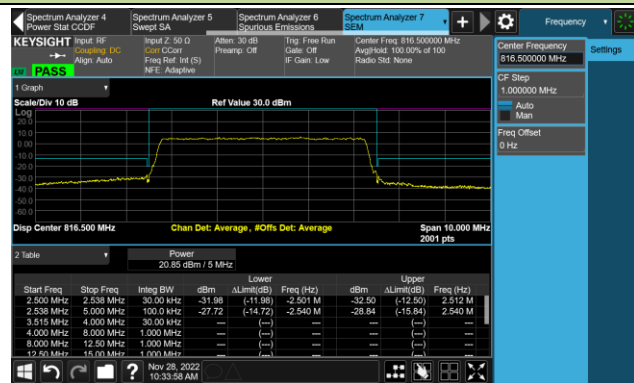

Upper Band Edge



10MHz Channel Bandwidth - Full RB

Band Edge



15MHz Channel Bandwidth - Full RB

Band Edge



A.5 Conducted Spurious Emissions Test Result

Test Site	WZ-SR6	Test Engineer	Cloud Guo
Test Date	2022/12/08	Test Band	LTE Band 26

Frequency (MHz)	Channel BW (MHz)	Frequency Range (MHz)	Max Spurious Emissions (dBm)	Limit (dBm)	Result
QPSK					
814.7	1.4	30 ~ 10000	-43.52	≤ -13.00	Pass
819.0	1.4	30 ~ 10000	-42.58	≤ -13.00	Pass
823.3	1.4	30 ~ 10000	-44.92	≤ -13.00	Pass
815.5	3	30 ~ 10000	-44.52	≤ -13.00	Pass
819.0	3	30 ~ 10000	-43.38	≤ -13.00	Pass
822.5	3	30 ~ 10000	-44.69	≤ -13.00	Pass
816.5	5	30 ~ 10000	-44.90	≤ -13.00	Pass
819.0	5	30 ~ 10000	-43.38	≤ -13.00	Pass
821.5	5	30 ~ 10000	-45.17	≤ -13.00	Pass
819.0	10	30 ~ 10000	-46.38	≤ -13.00	Pass
821.5	15	30 ~ 10000	-31.27	≤ -13.00	Pass

1.4MHz Channel Bandwidth

Low Channel

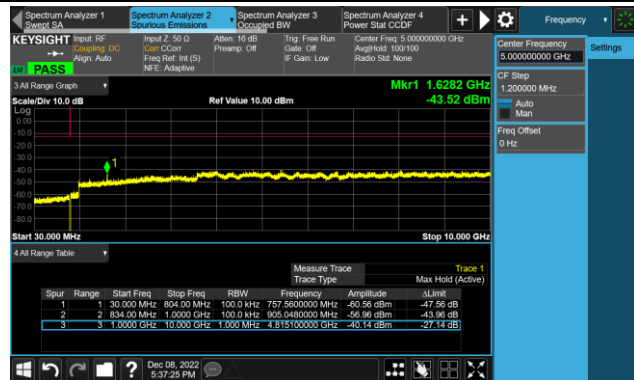

Middle Channel

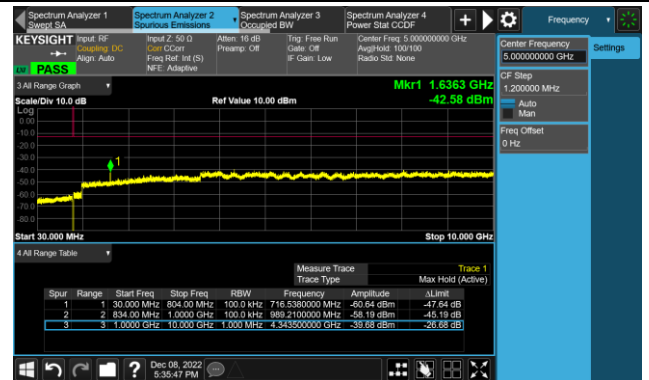

High Channel

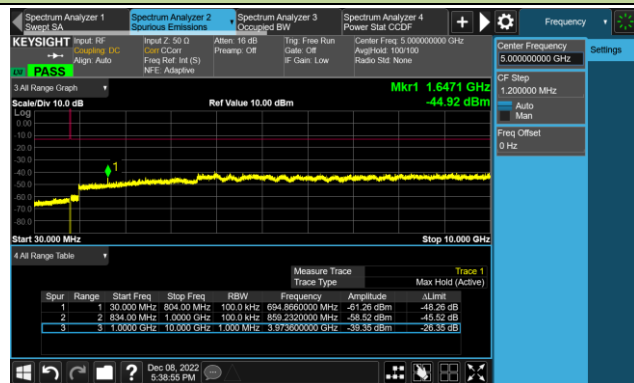

3MHz Channel Bandwidth

Low Channel

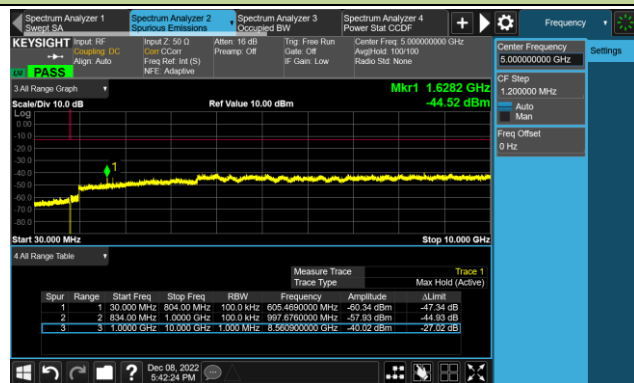

Middle Channel

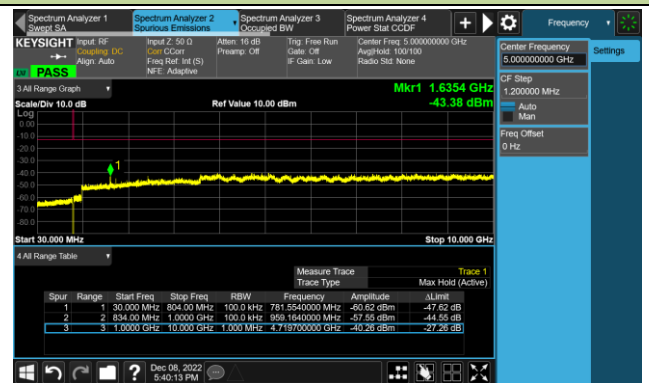

High Channel

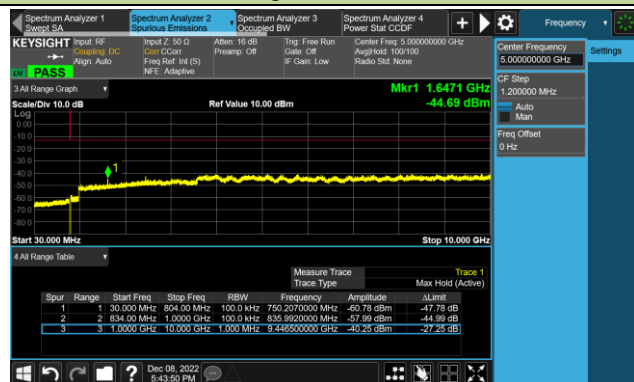

5MHz Channel Bandwidth

Low Channel

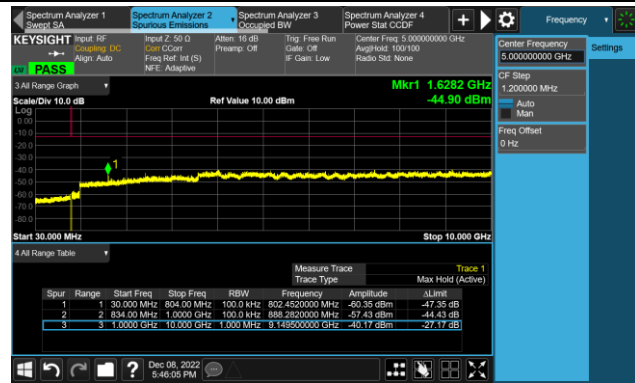

Middle Channel

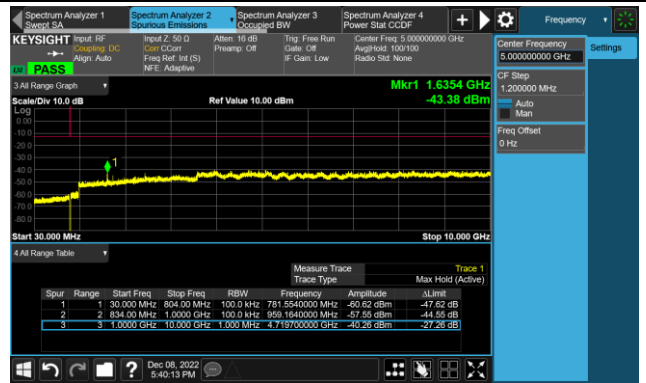

High Channel

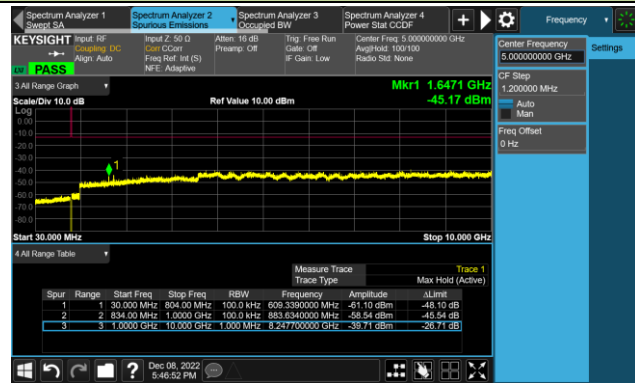

10MHz Channel Bandwidth

Middle Channel

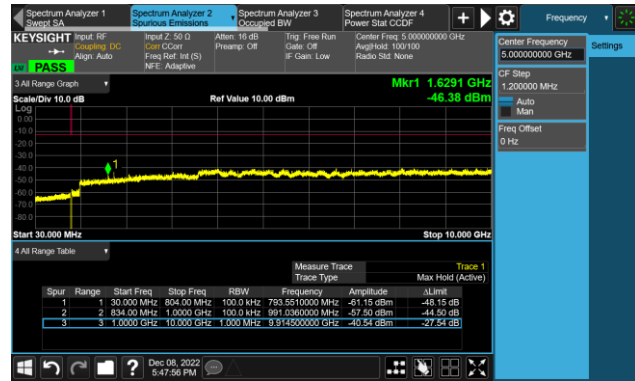

15MHz Channel Bandwidth

Middle Channel

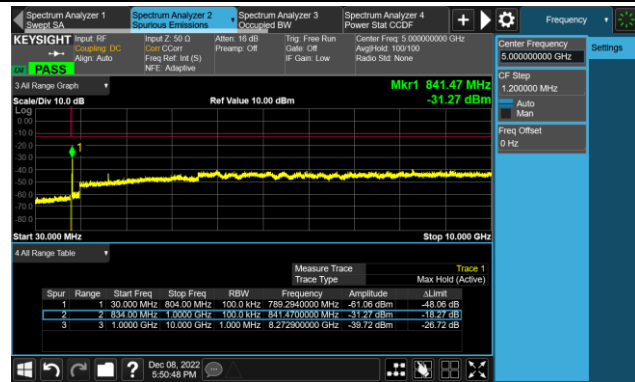

A.6 Radiated Suprious Emissions Test Result

Test Site	SIP-AC1	Test Engineer	Mero Zhou
Test Date	2022/12/03 ~ 2022/12/05	Test Band	LTE Band 26, 1.4MHz, 1RB

Frequency (MHz)	Reading Level (dBμV)	Factor (dB/m)	Measure Level (dBμV/m)	Limit (dBμV/m)	Margin (dB)	Detector	Polarization
Low Channel							
164.3	16.3	17.8	34.1	82.3	-48.2	Peak	Horizontal
581.9	15.0	24.8	39.8	82.3	-42.5	Peak	Horizontal
137.2	18.3	17.3	35.6	82.3	-46.7	Peak	Vertical
627.0	16.1	25.8	41.9	82.3	-40.4	Peak	Vertical
1728.0	61.7	-19.6	42.1	82.3	-40.2	Peak	Horizontal
2444.0	61.3	-16.5	44.8	82.3	-37.5	Peak	Horizontal
1628.0	57.9	-20.2	37.7	82.3	-44.6	Peak	Vertical
2444.0	68.4	-16.5	51.9	82.3	-30.4	Peak	Vertical
Middle Channel							
137.2	18.6	17.3	35.9	82.3	-46.4	Peak	Horizontal
698.3	16.0	26.8	42.8	82.3	-39.5	Peak	Horizontal
68.3	18.2	16.1	34.3	82.3	-48.0	Peak	Vertical
152.2	14.9	18.3	33.2	82.3	-49.1	Peak	Vertical
1636.0	65.9	-20.0	45.9	82.3	-36.4	Peak	Horizontal
2456.0	76.4	-16.3	60.1	82.3	-22.2	Peak	Horizontal
1636.0	65.0	-20.0	45.0	82.3	-37.3	Peak	Vertical
2456.0	81.3	-16.3	65.0	82.3	-17.3	Peak	Vertical
High Channel							
152.2	16.5	18.3	34.8	82.3	-47.5	Peak	Horizontal
553.3	15.4	24.3	39.7	82.3	-42.6	Peak	Horizontal
68.3	39.3	16.1	55.4	82.3	-26.9	Peak	Vertical
137.2	17.0	17.3	34.3	82.3	-48.0	Peak	Vertical
1648.0	61.6	-19.7	41.9	82.3	-40.4	Peak	Horizontal
2472.0	79.3	-16.3	63.0	82.3	-19.3	Peak	Horizontal
1648.0	66.8	-19.7	47.1	82.3	-35.2	Peak	Vertical
2472.0	82.3	-16.3	66.0	82.3	-16.3	Peak	Vertical

Note: Measure Level (dBμV/m) = Reading Level (dBμV) + Factor (dB/m).

Appendix B - Test Setup Photograph

Refer to "2211RSU065-UT" file.

Appendix C - EUT Photograph

Refer to "2211RSU065-UE" file.