

RF MEASUREMENT REPORT

FCC ID: XMR202212EG25GL
Application: Quectel Wireless Solutions Co., Ltd.
Product: LTE CAT4 Module
Model No.: EG25-GL, EG25-GL MINIPCIE
Brand Name: QUECTEL
FCC Rule Part(s): Part 2, 22 (H), 24 (E), 27
Test Procedure(s): ANSI C63.26: 2015
Result: Complies
Received Date: 2022-11-23
Test Date: 2022-11-24 ~ 2023-02-09

Reviewed By:

Sunny Sun

Approved By:

Robin Wu



The test results relate only to the samples tested.

This equipment has been shown to be capable of compliance with the applicable technical standards as indicated in the measurement report and was tested in accordance with the measurement procedures specified in ANSI C63.26-2015. Test results reported herein relate only to the item(s) tested.

The test report shall not be reproduced except in full without the written approval of MRT Technology (Suzhou) Co., Ltd.

Revision History

Report No.	Version	Description	Issue Date	Note
2211RSU065-U2	Rev. 01	Initial Report	2023-02-26	Valid

CONTENTS

Description	Page
1. General Information.....	5
1.1. Applicant	5
1.2. Manufacturer	5
1.3. Testing Facility	5
1.4. Product Information.....	6
1.5. Radio Specification Under Testing	7
1.6. Description of Available Antennas.....	8
1.7. Test Methodology	8
1.8. Device Capabilities	9
2. Test Configuration	10
2.1. Test System Connection Diagram.....	10
2.2. Test Environment Condition	10
3. Measuring Instrument	11
4. Decision Rules and Measurement Uncertainty.....	12
4.1. Decision Rules	12
4.2. Measurement Uncertainty.....	12
5. Test Result.....	13
5.1. Summary.....	13
5.2. Occupied Bandwidth Measurement.....	14
5.2.1. Test Limit	14
5.2.2. Test Procedure.....	14
5.2.3. Test Setting	14
5.2.4. Test Setup	14
5.2.5. Test Result	14
5.3. Frequency Stability Measurement	15
5.3.1. Test Limit	15
5.3.2. Test Procedure.....	15
5.3.3. Test Setting	15
5.3.4. Test Setup	16
5.3.5. Test Result	16
5.4. Equivalent Isotropically Radiated Power Measurement	17
5.4.1. Test Limit	17
5.4.2. Test Procedure.....	17
5.4.3. Test Setting	17

5.4.4.	Test Setup	18
5.4.5.	Test Result	18
5.5.	Band Edge Measurement	19
5.5.1.	Test Limit	19
5.5.2.	Test Procedure	19
5.5.3.	Test Setting	20
5.5.4.	Test Setup	20
5.5.5.	Test Result	20
5.6.	Peak to Average Ratio Measurement	21
5.6.1.	Test Limit	21
5.6.2.	Test Procedure	21
5.6.3.	Test Setting	21
5.6.4.	Test Setup	21
5.6.5.	Test Result	21
5.7.	Conducted Spurious Emissions Measurement.....	22
5.7.1.	Test Limit	22
5.7.2.	Test Procedure	22
5.7.3.	Test Setting	23
5.7.4.	Test Setup	23
5.7.5.	Test Result	23
5.8.	Radiated Spurious Emissions Measurement.....	24
5.8.1.	Test Limit	24
5.8.2.	Test Procedure	24
5.8.3.	Test Setting	24
5.8.4.	Test Setup	25
5.8.5.	Test Result	26
Appendix A - Test Result		27
A.1	Occupied Bandwidth Test Result	27
A.2	Frequency Stability Test Result.....	47
A.3	Equivalent Isotropically Radited Power Test Result.....	54
A.4	Band Edge Test Result	86
A.5	Peak to Average Radio Test Result	120
A.6	Conducted Spurious Emissions Test Result	127
A.7	Radiated Spurious Emissions Test Result	151
Appendix B - Test Setup Photograph		158
Appendix C - EUT Photograph		159

1.4. Product Information

Product Name	LTE CAT4 Module
Model No.	EG25-GL, EG25-GL MINIPCIE
Brand Name	QUECTEL
IMEI	865061060011919
GNSS Specification	GPS, GLONASS, Galileo, Bei Dou
GSM Band	GSM 850, PCS1900
UMTS Band	Band 2, 4, 5
E-UTRA Band	Band 2, 4, 5, 7, 12, 13, 25, 26, 38, 41, 66
Operating Temperature	-35 ~ 75 °C
Supply Voltage	3.3 ~ 4.3Vdc, typical 3.8Vdc
Remark: <ol style="list-style-type: none">1. The information of EUT was provided by the manufacturer, and the accuracy of the information shall be the responsibility of the manufacturer.2. The model difference is the different encapsulation, all the other circuits are the same. This report assessed the EG25-GL model.	

1.5. Radio Specification Under Testing

FDD Tx Frequency Range	Band 2: 1850 ~ 1910 MHz; Band 4: 1710 ~ 1755 MHz Band 5: 824 ~ 849 MHz; Band 7: 2500 ~ 2570 MHz Band 12: 699 ~ 716 MHz; Band 13: 777 ~ 787 MHz Band 25: 1850 ~ 1915 MHz; Band 26: 824 ~ 849 MHz Band 66: 1710 ~ 1780 MHz
FDD Rx Frequency Range	Band 2: 1930 ~ 1990 MHz; Band 4: 2110 ~ 2155 MHz Band 5: 869 ~ 894 MHz; Band 7: 2620 ~ 2690 MHz Band 12: 729 ~ 746 MHz; Band 13: 746 ~ 756 MHz Band 25: 1930 ~ 1995 MHz; Band 26: 869 ~ 894 MHz Band 66: 2110 ~ 2180 MHz;
TDD Tx & Rx Frequency Range	Band 38: 2570 ~ 2620 MHz; Band 41: 2496 ~ 2690 MHz
Support Bandwidth	Band 2/4/25/66: 1.4MHz, 3MHz, 5MHz, 10MHz, 15MHz, 20MHz Band 5/12: 1.4MHz, 3MHz, 5MHz, 10MHz Band 7/38/41: 5MHz, 10MHz, 15MHz, 20MHz Band 13: 5MHz, 10MHz Band 26: 1.4MHz, 3MHz, 5MHz, 10MHz, 15MHz
Modulation	QPSK, 16QAM
Power Class	3

Note: LTE band 26 transmit frequency for part 90 rule is 814 ~ 824MHz and part 22 rule is 824 ~ 849MHz. ERP over 15MHz bandwidth complies the ERP limit line of part 22 rule, therefore ERP of the partial frequency spectrum which falls within part 22 also complies.

1.6. Description of Available Antennas

Technology	Frequency Range (MHz)	Antenna Type	MaxPeak Gain (dBi)
GSM 850	824 ~ 849	Dipole	2.29
PCS 1900	1850 ~ 1910		1.38
WCDMA Band II	1850 ~ 1910		1.38
WCDMA Band IV	1710 ~ 1755		2.00
WCDMA Band V	824 ~ 849		2.13
LTE Band 2	1850 ~ 1910		1.38
LTE Band 4	1710 ~ 1755		2.00
LTE Band 5	824 ~ 849		2.13
LTE Band 7	2500 ~ 2570		2.33
LTE Band 12	699 ~ 716		3.26
LTE Band 13	777 ~ 787		3.98
LTE Band 25	1850 ~ 1915		1.38
LTE Band 26	814 ~ 849		2.13
LTE Band 38	2570 ~ 2620		2.00
LTE Band 41	2496 ~ 2690		2.04
LTE Band 66	1710 ~ 1780		2.00

Note: All antenna information (Antenna type and Peak Gain) is provided by the manufacturer.

1.7. Test Methodology

According to the specifications of the manufacturer, the EUT must comply with the requirements of the following standards:

- ANSI C63.26:2015
- FCC CFR 47 Part 2, 22, 24, 27
- FCC KDB 971168 D01 v03r01: Power Meas License Digital Systems
- FCC KDB 971168 D02 v02r01: Misc Rev Approv License Devices
- FCC KDB 412172 D01 v01r01: Determining ERP and EIRP

1.8. Device Capabilities

This device contains the following capabilities:

Working on LTE Band 2, 4, 5, 7, 12, 13, 25, 26, 38, 41 LTE Module.

LTE Band 25 (1850 ~ 1915 MHz) overlaps the entire frequency range of LTE Band 2 (1850 ~ 1910 MHz).

Therefore, test data provided in this report covers Band 2 as well as Band 25.

LTE Band 26 (814 ~ 849 MHz) overlaps the entire frequency range of LTE Band 5 (824 ~ 849 MHz). Therefore, test data provided in this report covers Band 5 as well as Band 26.

LTE Band 66 (1710 ~ 1780 MHz) overlaps the entire frequency range of LTE Band 4 (1710 ~ 1755 MHz).

Therefore, test data provided in this report covers Band 4 as well as Band 66.

LTE Band 41 (2496 ~ 2690 MHz) overlaps the entire frequency range of LTE Band 38 (2570 ~ 2620 MHz).

Therefore, test data provided in this report covers Band 38 as well as Band 41.

2. Test Configuration

2.1. Test System Connection Diagram

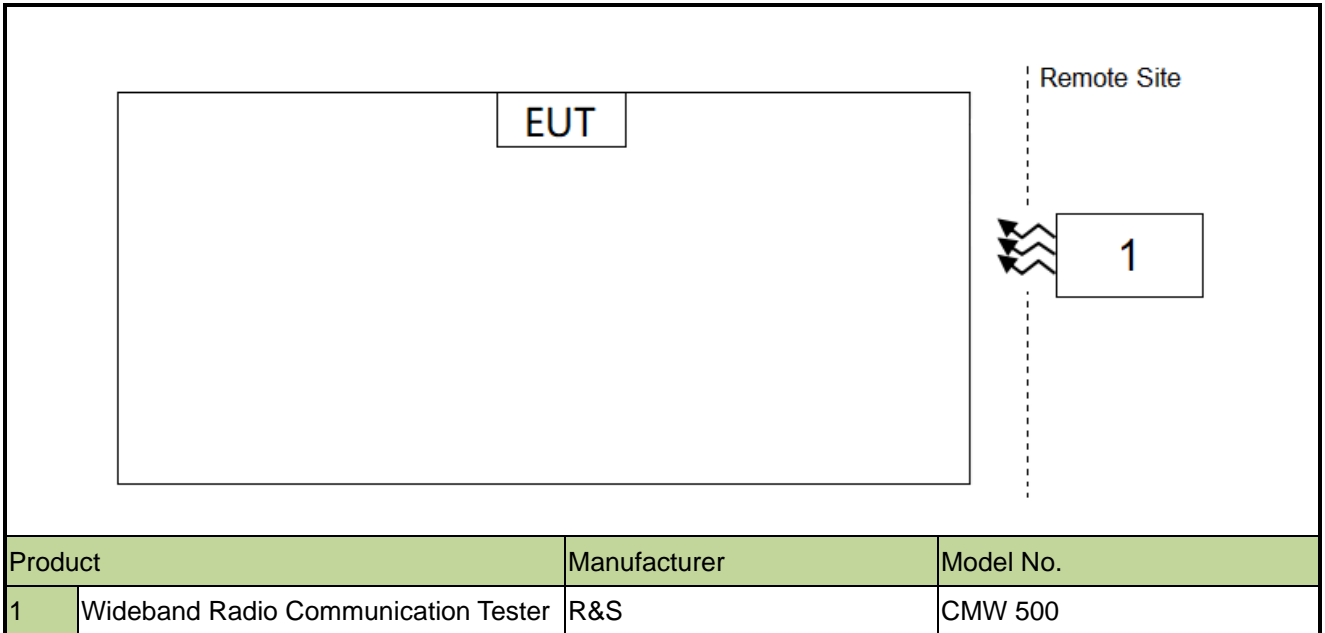

2.2. Test Environment Condition

Ambient Temperature	15 ~ 35°C
Relative Humidity	20% ~ 75%RH

3. Measuring Instrument

Instrument	Manufacturer	Model No.	Asset No.	Cali. Interval	Cali. Due Date	Test Site
Anechoic Chamber	RIKEN	SIP-AC1	MRTSUE06554	1 year	2022-12-23	SIP-AC1
Anechoic Chamber	RIKEN	SIP-AC1	MRTSUE06554	1 year	2023-12-22	SIP-AC1
Preamplifier	EMCI	EMC051845SE	MRTSUE06600	1 year	2023-11-07	SIP-AC1
Horn Antenna	R&S	HF907	MRTSUE06610	1 year	2023-07-13	SIP-AC1
Thermohygrometer	testo	608-H1	MRTSUE06616	1 year	2023-11-01	SIP-AC1
Thermohygrometer	testo	608-H1	MRTSUE06620	1 year	2022-11-28	SIP-AC1
Thermohygrometer	testo	608-H1	MRTSUE06620	1 year	2023-11-27	SIP-AC1
TRILOG Antenna	Schwarzbeck	VULB 9168	MRTSUE06645	1 year	2023-07-30	SIP-AC1
Communication Tester	R&S	CMW500	MRTSUE06243	1 year	2023-10-08	SIP
Thermohygrometer	testo	608-H1	MRTSUE06362	1 year	2023-02-15	WZ-SR6
Shielding Room	HUAMING	WZ-SR6	MRTSUE06443	N/A	N/A	WZ-SR6
Signal Analyzer	Keysight	N9020B	MRTSUE06583	1 year	2023-10-08	WZ-SR6
5G Wireless Test Platform	Keysight	E7515B	MRTSUE06942	1 year	2023-03-03	WZ-SR6
Thermohygrometer	testo	608-H1	MRTSUE06362	1 year	2023-02-15	WZ-SR6
Temperature Chamber	BAOYT	BYH-150CL	MRTSUE06051	1 year	2023-10-08	WZ-TR3
Vibration Test System	DongLing	ES-1-150	MRTSUE06206	1 year	2023-07-07	WZ-TR3
Thermohygrometer	testo	608-H1	MRTSUE06401	1 year	2023-06-06	WZ-TR3
Radio Communication Analyzer	Anritsu	MT8821C	MRTSUE06960	1 year	2023-07-08	WZ-SR6/WZ-TR3
Communication Tester	R&S	CMW500	MRTSUE06108	1 year	2022-11-26	WZ-SR6/WZ-TR3
Communication Tester	R&S	CMW500	MRTSUE06108	1 year	2023-11-25	WZ-SR6/WZ-TR3
Attenuator	MVE	MVE2213	MRTSUE11094	1 year	2023-06-09	WZ
Attenuator	MVE	MVE2213	MRTSUE11095	1 year	2023-06-09	WZ
Attenuator	MVE	MVE2213	MRTSUE11096	1 year	2023-06-09	WZ

Software	Version	Function
EMI V3	V 3.0.0	EMI Test Software
Controller_MF 7802BS	1.02	RE Antenna & Turntable

4. Decision Rules and Measurement Uncertainty

4.1. Decision Rules

The Decision Rule is based on Simple Acceptance in accordance with ISO Guide 98-4: 2012 Clause 8.2. (Measurement uncertainty is not taken into account when stating conformity with a specified requirement.)

4.2. Measurement Uncertainty

Where relevant, the following test uncertainty levels have been estimated for tests performed on the EUT as specified in CISPR 16-4-2. This uncertainty represents an expanded uncertainty expressed at approximately the 95% confidence level using a coverage factor of $k = 2$.

Radiated Spurious Emissions
Measurement Uncertainty for a Level of Confidence of 95% ($U=2Uc(y)$): Horizontal: 9kHz ~ 300MHz: 5.04dB 300MHz ~ 1GHz: 4.95dB 1GHz ~ 40GHz: 6.40dB Vertical: 9kHz ~ 300MHz: 5.24dB 300MHz ~ 1GHz: 6.03dB 1GHz ~ 40GHz: 6.40dB
Conducted Spurious Emissions
Measuring Uncertainty for a Level of Confidence of 95% ($U=2Uc(y)$): 0.78dB
Output Power
Measuring Uncertainty for a Level of Confidence of 95% ($U=2Uc(y)$): 1.13dB
Occupied Bandwidth
Measuring Uncertainty for a Level of Confidence of 95% ($U=2Uc(y)$): 0.28%
Frequency Stability
Measuring Uncertainty for a Level of Confidence of 95% ($U=2Uc(y)$): 76.2Hz

5. Test Result

5.1. Summary

FCC Part Section(s)	Test Description	Test Condition	Verdict
2.1049	Occupied Bandwidth	Conducted	Pass
2.1055, 22.355 24.235, 27.54	Frequency Stability		Pass
22.913(a)(5), 27.50(b)(9) 27.50(c)(9), 27.50(d)(4) 27.50(h)(2), 24.232(c)	Equivalent (Isotropic) Radiated Power		Pass
24.232(d), 27.50(d)(5)	Peak to Average Ratio		Pass
2.1051, 22.917(a), 24.238(a) 27.53(c) (f) (g) (h) (m)	Band Edge		Pass
2.1051, 22.917(a), 24.238(a) 27.53(c) (f) (g) (h) (m)	Spurious Emission		
2.1051, 22.917(a), 24.238(a) 27.53(c) (f) (g) (h) (m)	Spurious Emissions	Radiated	Pass

Notes:

- 1) The analyzer plots shown in this section were all taken with a correction table loaded into the analyzer. The correction table was used to account for the losses of the cables and attenuators used as part of the system to connect the EUT to the analyzer at all frequencies of interest.
- 2) All supported modulation types were evaluated. The worst-case emission of modulation was selected. Therefore, the Frequency Stability, Channel Band Edge, Conducted Spurious Emission, Radiated Spurious Emission were presented the worst-case in the test report.
- 3) For radiated emission tests, every axis (X, Y, Z) was also verified. The test results shown in the following sections represent the worst-case emissions.

5.2. Occupied Bandwidth Measurement

5.2.1. Test Limit

The occupied bandwidth, that is the frequency bandwidth such that, below its lower and above its upper frequency limits, the mean powers radiated are each equal to 0.5 percent of the total mean power radiated by a given emission shall be measured.

5.2.2. Test Procedure

ANSI C63.26-2015 - Section 5.4

5.2.3. Test Setting

1. Set center frequency to the nominal EUT channel center frequency
2. RBW = The nominal RBW shall be in the range of 1% to 5% of the anticipated OBW
3. VBW $\geq 3 \times$ RBW
4. Detector = Peak
5. Trace mode = max hold
6. Sweep = auto couple
7. Allow the trace to stabilize
8. Use the 99% power bandwidth function of the instrument and report the measured bandwidth.

5.2.4. Test Setup

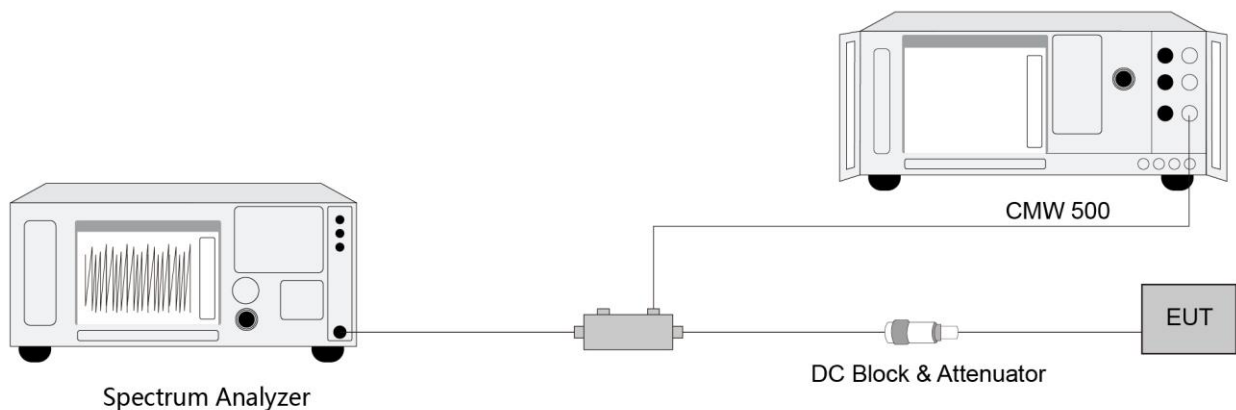

5.2.5. Test Result

Refer to Appendix A.1.

5.3. Frequency Stability Measurement

5.3.1. Test Limit

The frequency stability shall be measured by variation of ambient temperature and variation of primary supply voltage to ensure that the fundamental emission stays within the authorized frequency block. The frequency stability of the transmitter shall be maintained within $\pm 0.00025\%$ ($\pm 2.5\text{ppm}$) of the center frequency.

5.3.2. Test Procedure

ANSI C63.26-2015 - Section 5.6

5.3.3. Test Setting

Frequency Stability Under Temperature Variations:

The equipment under test was connected to an external AC or DC power supply and input rated voltage. RF output was connected to a frequency counter or spectrum analyzer via feed through attenuators. The EUT was placed inside the temperature chamber. Set the spectrum analyzer RBW low enough to obtain the desired frequency resolution and measure EUT 20°C operating frequency as reference frequency. Turn EUT off and set the chamber temperature to highest. After the temperature stabilized for approximately 30 minutes recorded the frequency. Repeat step measure with 10°C decreased per stage until the lowest temperature reached.

Frequency Stability Under Voltage Variations:

Set chamber temperature to 20°C. Use a variable AC power supply / DC power source to power the EUT and set the voltage to rated voltage. Set the spectrum analyzer RBW low enough to obtain the desired frequency resolution and recorded the frequency.

Reduce the input voltage to specify extreme voltage variation ($\pm 15\%$) and endpoint, record the maximum frequency change.

5.3.4. Test Setup

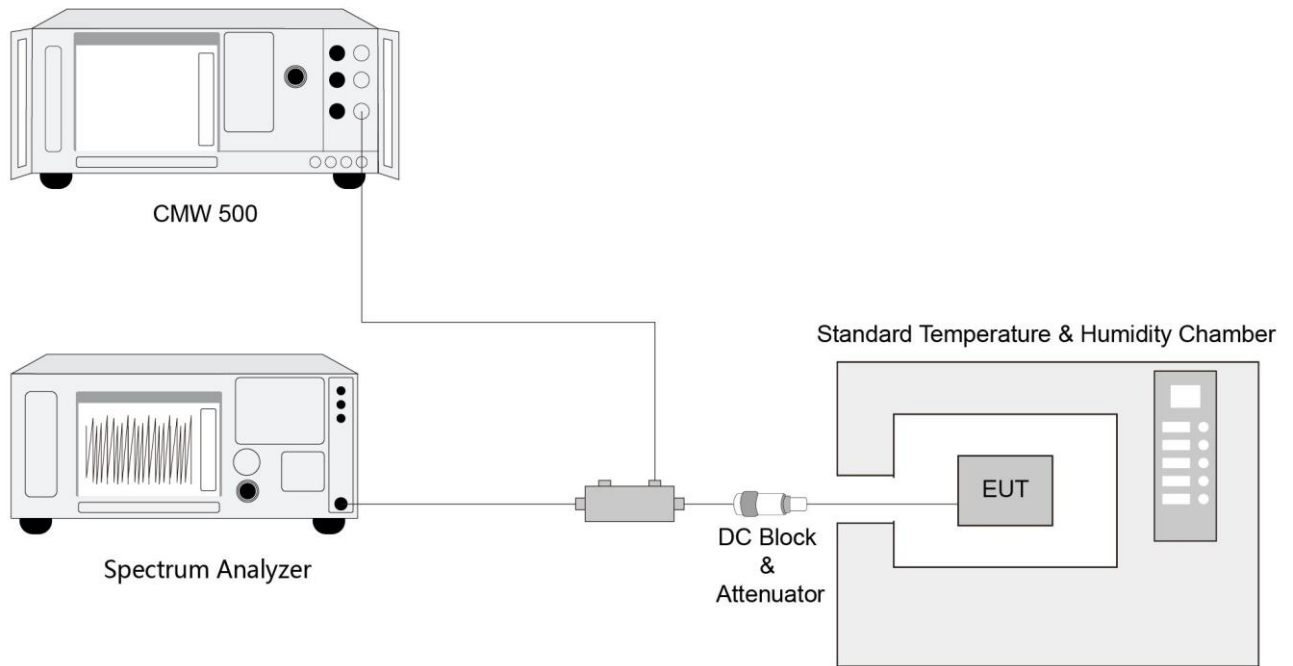

5.3.5. Test Result

Refer to Appendix A.2.

5.4. Equivalent Isotropically Radiated Power Measurement

5.4.1. Test Limit

Band 5/26

The ERP of mobile transmitters and auxiliary test transmitters must not exceed 7 watts.

Band 12, 13

Control stations and mobile stations transmitting in the 746-757 MHz, 776-788 MHz, and 805-806 MHz bands are limited to 30 watts ERP.

Control and mobile stations in the 698-746 MHz band are limited to 30 watts ERP.

Band 2/25, 7, 38/41

Mobile and portable stations are limited to 2 watts EIRP and the equipment must employ a means for limiting power to the minimum necessary for successful communications.

Band 4/66

Fixed, mobile stations operating in the 1710-1755 MHz band and mobile in the 1695-1710 MHz and 1755-1780 MHz bands are limited to 1 watt EIRP.

5.4.2. Test Procedure

ANSI C63.26-2015 - Section 5.2

5.4.3. Test Setting

Average power measurements were performed only when the EUT was transmitting at its maximum power control level using a broadband power meter with a pulse sensor. The power meter implemented triggering and gating capabilities which were set up such that power measurements were recorded only during the ON time of the transmitter.

The relevant equation for determining the maximum ERP or EIRP from the measured RF output power is given in Equation (1) as follows:

$$\text{ERP or EIRP} = P_{\text{Meas}} + G_{\text{T}}$$

where

ERP or EIRP effective radiated power or equivalent isotropically radiated power, respectively (expressed in the same units as P_{Meas} , e.g., dBm or dBW)

P_{Meas} measured transmitter output power or PSD, in dBm or dBW

G_{T} gain of the transmitting antenna, in dBd (ERP) or dBi (EIRP)

$$\text{ERP} = \text{EIRP} - 2.15$$

5.4.4. Test Setup



5.4.5. Test Result

Refer to Appendix A.3.

5.5. Band Edge Measurement

5.5.1. Test Limit

22.917(a), 24.238 (a), 27.53 (g) (h)

For operations in the 824 ~ 849 MHz, 1850 ~ 1910 MHz, 1930 ~ 1990 MHz, 600MHz & 698 ~ 746 MHz and 1710 ~ 1755 MHz, the FCC limit is $43 + 10\log_{10}(P_{\text{Watts}})$ dB below the transmitter power $P(\text{Watts})$ in a 1 MHz bandwidth. However, in the 1MHz bands immediately outside and adjacent to the licensee's frequency block, a resolution bandwidth of at least one percent of the emission bandwidth of the fundamental emission of the transmitter may be employed.

27.53 (c)

For operations in the 776-788 MHz band, the FCC limit is $43 + 10\log_{10}(P_{\text{Watts}})$ dB below the transmitter power $P(\text{Watts})$ in a 100 kHz bandwidth. However, in the 100 kHz bands immediately outside and adjacent to the frequency block, a resolution bandwidth of at least 30 kHz may be employed. In addition, the power of any unwanted emissions in any 6.25 kHz bandwidth for all frequencies between 763-775 MHz and 793-806 Hz shall be attenuated below the transmitter power, P (dBW), by at least $65 + 10 \log_{10} (P_{\text{Watts}})$, dB, for mobile and portable equipment.

27.53(m)(4)

For mobile digital stations, the attenuation factor shall be not less than $40 + 10 \log (P)$ dB on all frequencies between the channel edge and 5 megahertz from the channel edge, $43 + 10 \log (P)$ dB on all frequencies between 5 megahertz and X megahertz from the channel edge, and $55 + 10 \log (P)$ dB on all frequencies more than X megahertz from the channel edge, where X is the greater of 6 megahertz or the actual emission bandwidth as defined in paragraph (m)(6) of this section. In addition, the attenuation factor shall not be less than $43 + 10 \log (P)$ dB on all frequencies between 2490.5 MHz and 2496 MHz and $55 + 10 \log (P)$ dB at or below 2490.5 MHz. Mobile Satellite Service licensees operating on frequencies below 2495 MHz may also submit a documented interference complaint against BRS licensees operating on channel BRS Channel 1 on the same terms and conditions as adjacent channel BRS or EBS licensees.

5.5.2. Test Procedure

ANSI C63.26-2015 - Section 5.7

5.5.3. Test Setting

1. Set the analyzer frequency to low or high channel.
2. $RBW \geq$ The nominal RBW shall be in the range of 1% of the anticipated OBW (in the 1MHz band immediately outside and adjacent to the band edge). For improvement of the accuracy in the measurement of the average power of a noise-like emission, a RBW narrower than the specified reference bandwidth can be used (generally limited to no less than 1% of the OBW), provided that a subsequent integration is performed over the full required measurement bandwidth. This integration should be performed using the spectrum analyzer's band power functions.
3. $VBW \geq 3*RBW$
4. Sweep time = auto
5. Detector = power averaging (rms)
6. Set sweep trigger to "free run."
7. User gate triggered such that the analyzer only sweeps when the device is transmitting at full power
8. Trace average at least 100 traces in power averaging (rms) mode if sweep is set to auto-couple. To accurately determine the average power over the on and off time of the transmitter, it can be necessary to increase the number of traces to be averaged above 100, or if using a manually configured sweep time, increase the sweep time.

5.5.4. Test Setup

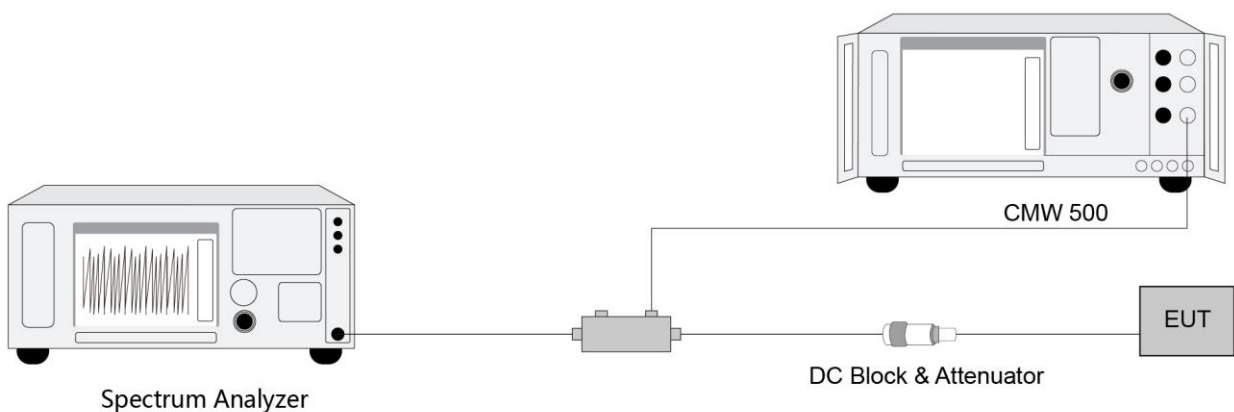

5.5.5. Test Result

Refer to Appendix A.4.

5.6. Peak to Average Ratio Measurement

5.6.1. Test Limit

A peak to average ratio measurement is performed at the conducted port of the EUT. The spectrum analyzers Complementary Cumulative Distribution Function (CCDF) measurement profile is used to determine the largest deviation between the average and the peak power of the EUT in a given bandwidth. The CCDF curve shows how much time the peak waveform spends at or above a given average power level. The percent of time the signal spends at or above the level defines the probability for that particular power level.

5.6.2. Test Procedure

ANSI C63.26-2015 - Section 5.2.3.4 (CCDF).

5.6.3. Test Setting

1. Set the resolution / measurement bandwidth \geq signal's occupied bandwidth.
2. Set the number of counts to a value that stabilizes the measured CCDF curve.
3. Record the maximum PARR level associated with a probability of 0.1%.

5.6.4. Test Setup

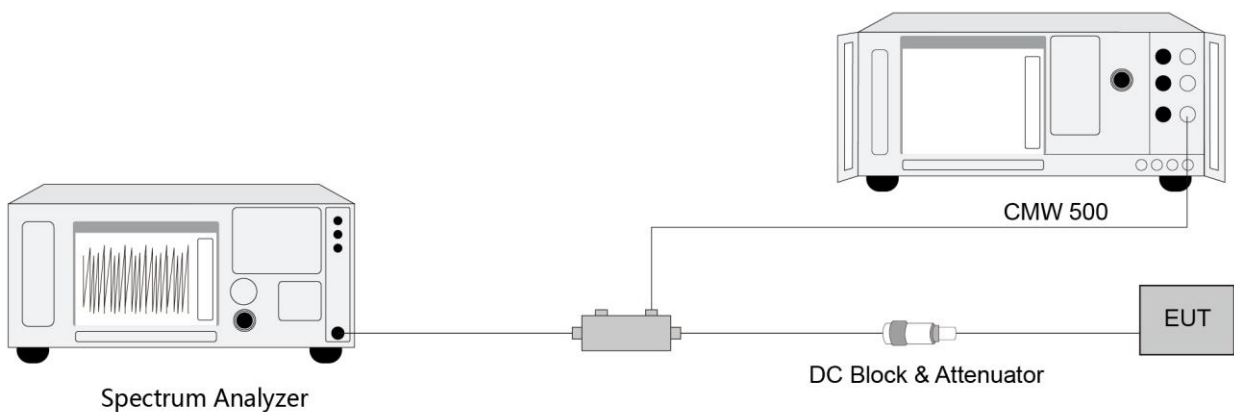

5.6.5. Test Result

Refer to Appendix A.5

5.7. Conducted Spurious Emissions Measurement

5.7.1. Test Limit

The level of the carrier and the various conducted spurious and harmonic frequencies is measured by means of a calibrated spectrum analyzer. The spectrum is scanned from the lowest frequency generated in the equipment up to a frequency including its 10th harmonic. All out of band emissions are measured with a spectrum analyzer connected to the antenna terminal of the EUT while the EUT is operating at its maximum duty cycle, at maximum power, and at the appropriate frequencies. All data rates were investigated to determine the worst-case configuration. All modes of operation were investigated and the worst-case configuration results are reported in this section.

The power of any emission outside of the authorized operating frequency ranges must be attenuated below the transmitting power (P) by a factor of at least $43 + 10 \log(P)$ dB.

For operations in the 746-758 MHz, 775-788 MHz, and 805-806 MHz bands, emissions in the band 1559-1610 MHz shall be limited to -70 dBW/MHz equivalent isotropically radiated power (EIRP) for wideband signals.

For Band 7, 38/41: For mobile digital stations, the attenuation factor shall be not less than $40 + 10 \log(P)$ dB on all frequencies between the channel edge and 5 megahertz from the channel edge, $43 + 10 \log(P)$ dB on all frequencies between 5 megahertz and X megahertz from the channel edge, and $55 + 10 \log(P)$ dB on all frequencies more than X megahertz from the channel edge, where X is the greater of 6 megahertz or the actual emission bandwidth.

5.7.2. Test Procedure

ANSI C63.26-2015 - Section 5.7

5.7.3. Test Setting

1. Set the analyzer frequency to low, mid, high channel.
2. RBW = 1MHz
3. VBW $\geq 3 \times$ RBW
4. Sweep time = auto
5. Detector = power averaging (rms)
6. Set sweep trigger to "free run."
7. User gate triggered such that the analyzer only sweeps when the device is transmitting at full power.
8. Trace average at least 100 traces in power averaging (rms) mode if sweep is set to auto-couple. To accurately determine the average power over the on and off time of the transmitter, it can be necessary to increase the number of traces to be averaged above 100, or if using a manually configured sweep time, increase the sweep time.

5.7.4. Test Setup

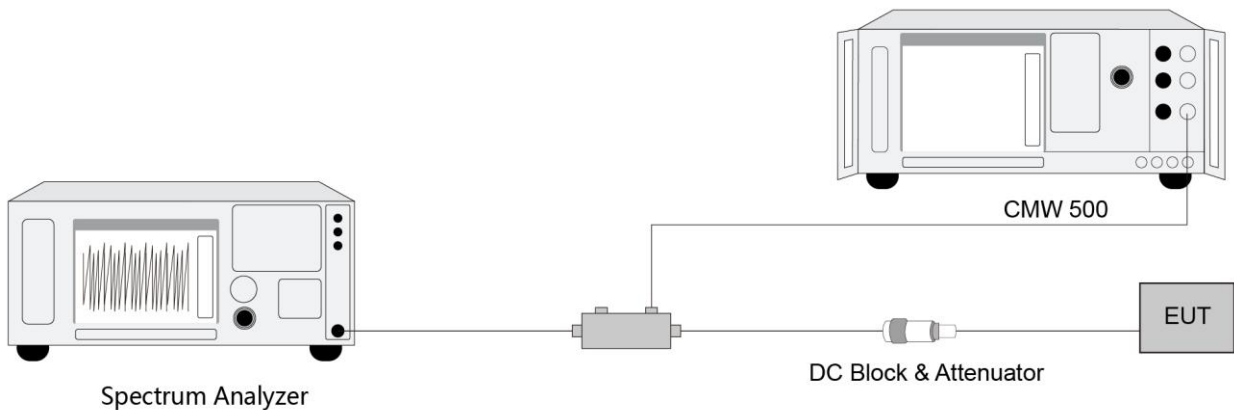

5.7.5. Test Result

Refer to Appendix A.6

5.8. Radiated Spurious Emissions Measurement

5.8.1. Test Limit

The power of any emission outside of the authorized operating frequency ranges must be attenuated below the transmitting power (P) by a factor of at least $43 + 10 \log(P)$ dB. The emission limit equal to -13dBm.

For Band 7, 38/41: For mobile digital stations, the attenuation factor shall be not less than $40 + 10 \log(P)$ dB on all frequencies between the channel edge and 5 megahertz from the channel edge, $43 + 10 \log(P)$ dB on all frequencies between 5 megahertz and X megahertz from the channel edge, and $55 + 10 \log(P)$ dB on all frequencies more than X megahertz from the channel edge, where X is the greater of 6 megahertz or the actual emission bandwidth.

For LTE Band 13, For operations in the 746-758 MHz, 775-788 MHz, and 805-806 MHz bands, emissions in the band 1559-1610 MHz shall be limited to -70 dBW/MHz (-40dBm/MHz) equivalent isotropically radiated power (EIRP) for wideband signals, and -80 dBW (-50dBm) EIRP for discrete emissions of less than 700 Hz bandwidth.

E (dB μ V/m) = EIRP (dBm) - 20 log D + 104.8; where D is the measurement distance in meters. The emission limit equal to 82.3dB μ V/m or 70.3dB μ V/m.

5.8.2. Test Procedure

ANSI C63.26-2015 - Section 5.2.7 & 5.5

5.8.3. Test Setting

1. RBW = 1MHz
2. VBW \geq 3*RBW
3. Sweep time \geq 10 \times (number of points in sweep) \times (transmission symbol period)
4. Detector = Peak
5. Trace mode = max hold
6. The trace was allowed to stabilize

5.8.4. Test Setup

Below 1GHz Test Setup:

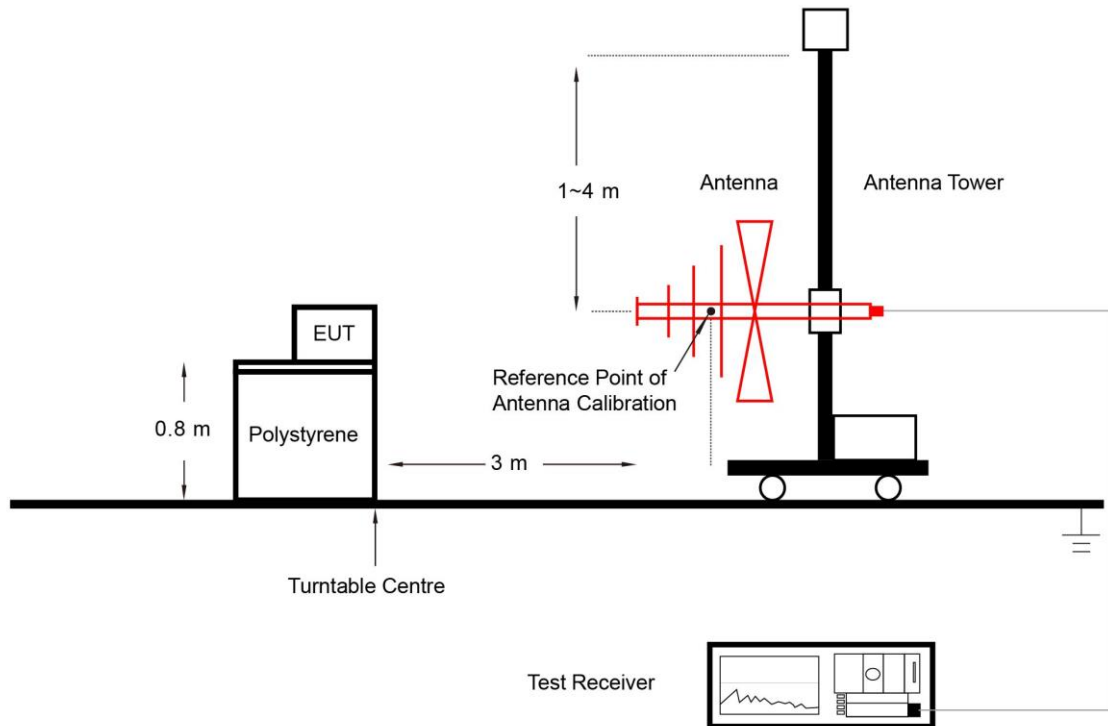

Above 1GHz Test Setup:

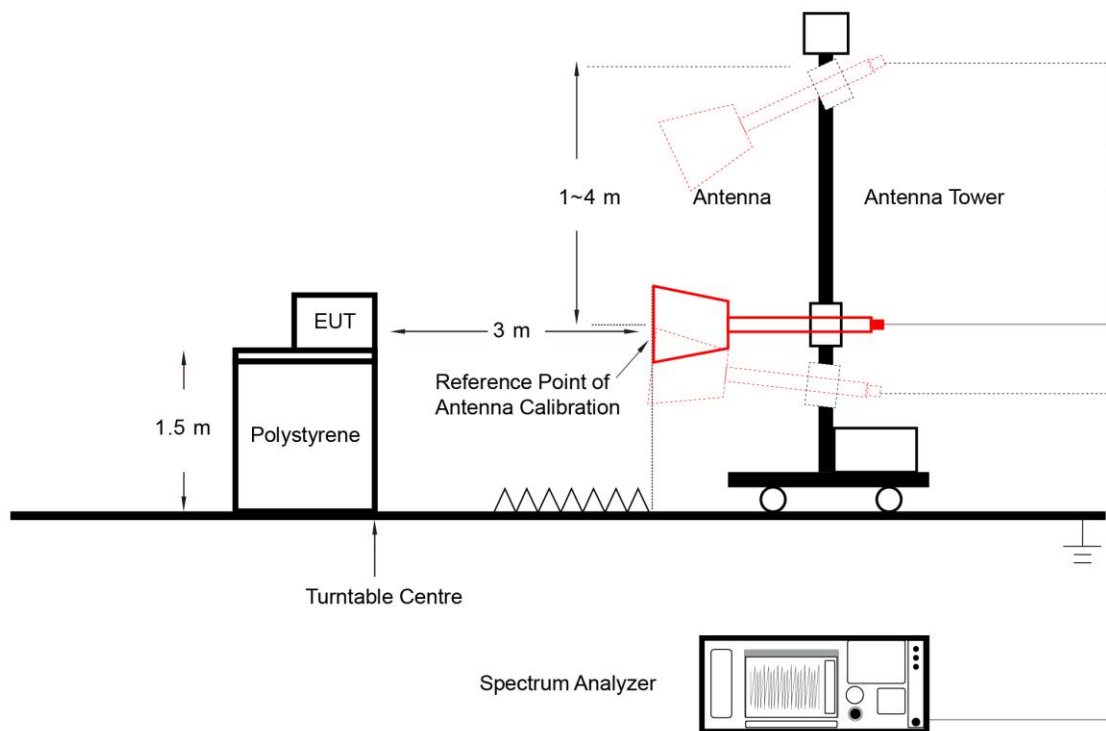

5.8.5. Test Result

Refer to Appendix A.7.

Appendix A - Test Result

A.1 Occupied Bandwidth Test Result

Test Site	WZ-SR6	Test Engineer	Cloud Guo
Test Date	2022/11/24 ~ 2022/12/09	Test Band	Band 2/25

Modulation	Bandwidth (MHz)	Frequency (MHz)	99% Bandwidth (MHz)
QPSK	1.4	1882.5	1.08
	3		2.68
	5		4.47
	10		8.92
	15		13.40
	20		17.79
16QAM	1.4	1882.5	1.08
	3		2.68
	5		4.47
	10		8.90
	15		13.37
	20		17.84

99% Bandwidth - QPSK

1.4MHz Channel Bandwidth

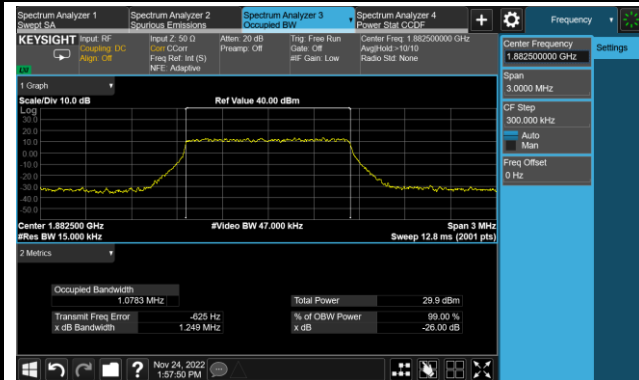

3MHz Channel Bandwidth

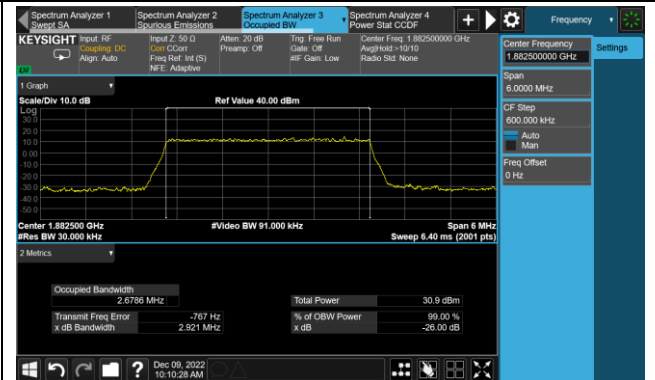

5MHz Channel Bandwidth

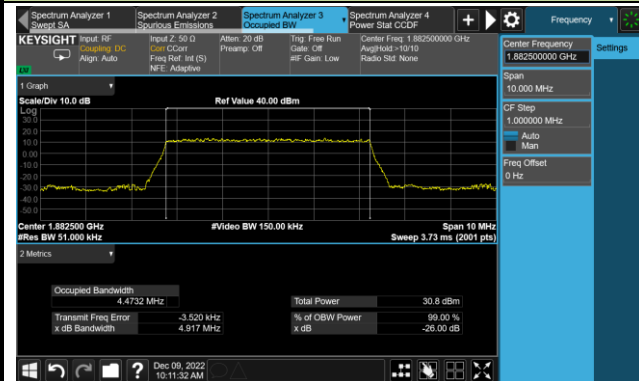

10MHz Channel Bandwidth

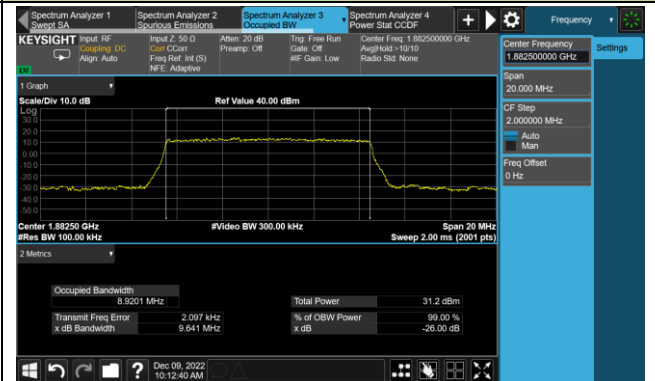

15MHz Channel Bandwidth

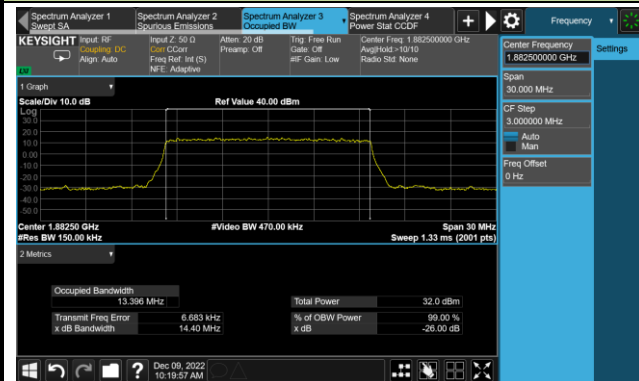

20MHz Channel Bandwidth

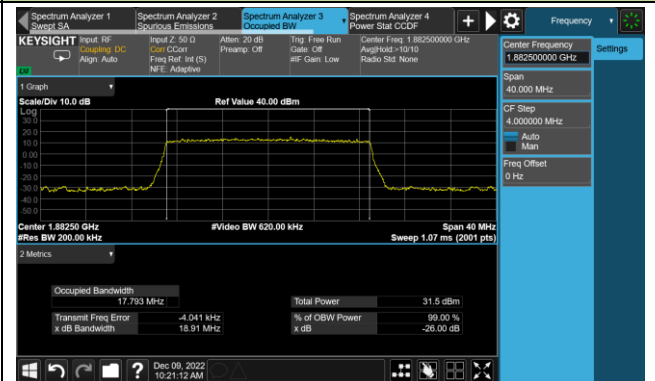

99% Bandwidth - 16QAM

1.4MHz Channel Bandwidth

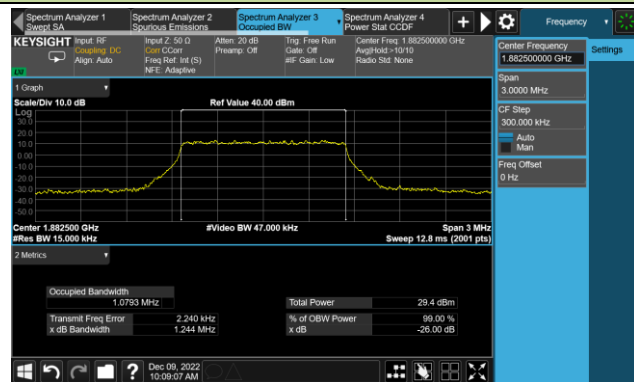

3MHz Channel Bandwidth

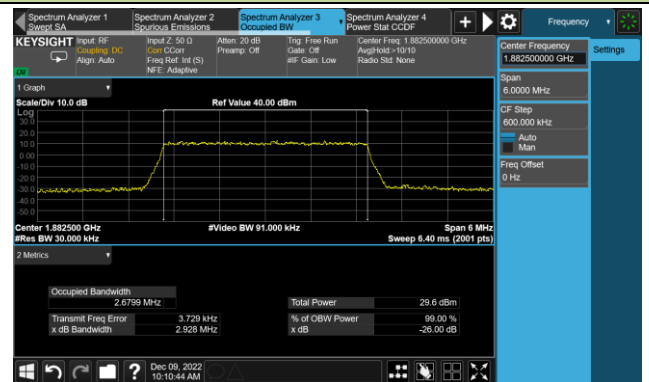

5MHz Channel Bandwidth

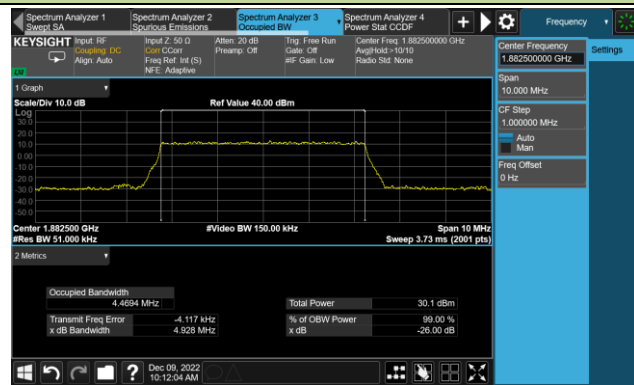

10MHz Channel Bandwidth

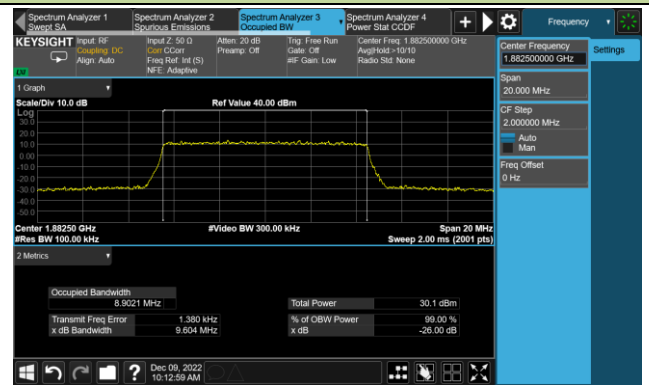

15MHz Channel Bandwidth

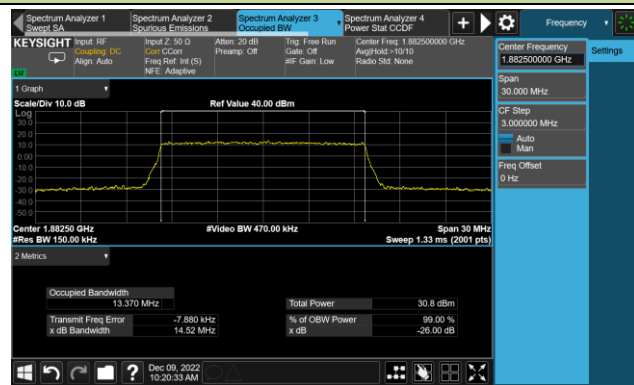

20MHz Channel Bandwidth

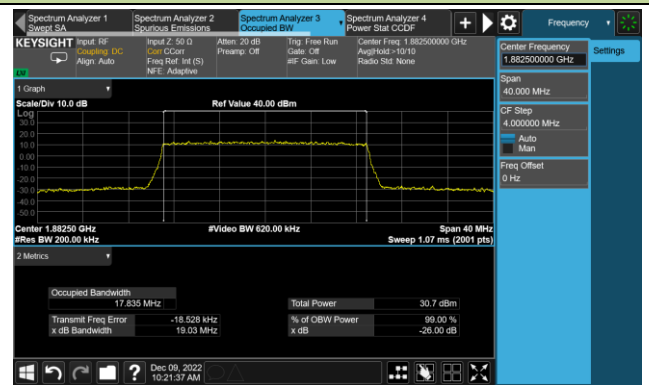

Test Site	WZ-SR6	Test Engineer	Cloud Guo
Test Date	2022/12/09	Test Band	Band 4/66

Modulation	Bandwidth (MHz)	Frequency (MHz)	99% Bandwidth (MHz)
QPSK	1.4	1745.0	1.08
	3		2.68
	5		4.47
	10		8.93
	15		13.40
	20		17.81
16QAM	1.4	1745.0	1.08
	3		2.68
	5		4.47
	10		8.90
	15		13.37
	20		17.80

99% Bandwidth - QPSK

1.4MHz Channel Bandwidth

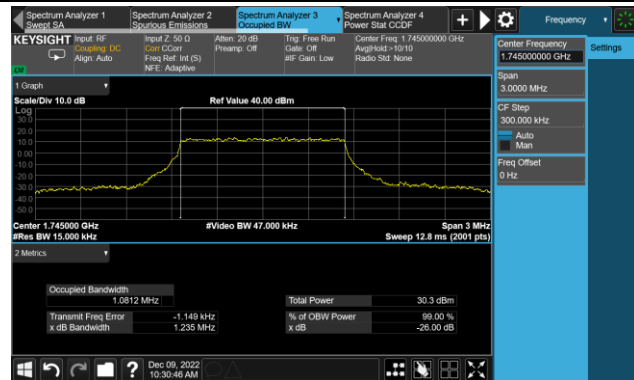

3MHz Channel Bandwidth

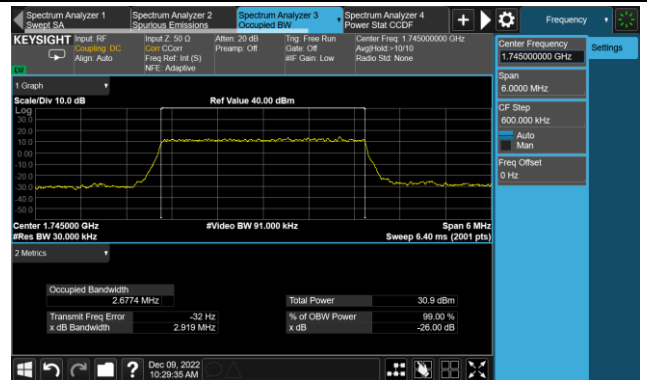

5MHz Channel Bandwidth

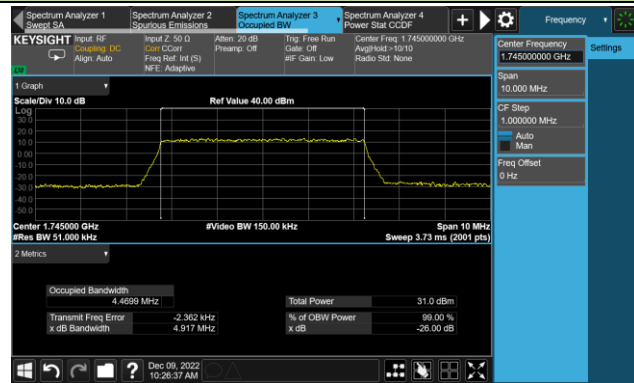

10MHz Channel Bandwidth

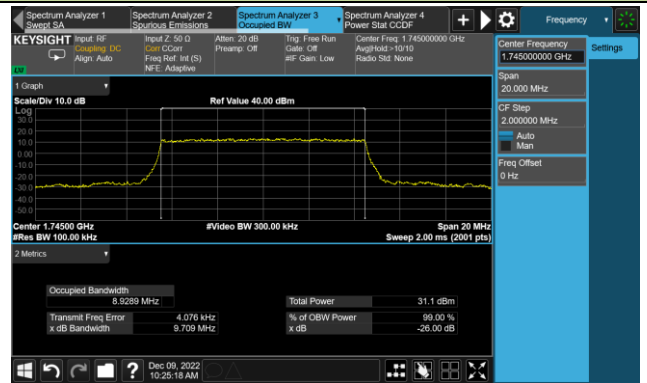

15MHz Channel Bandwidth

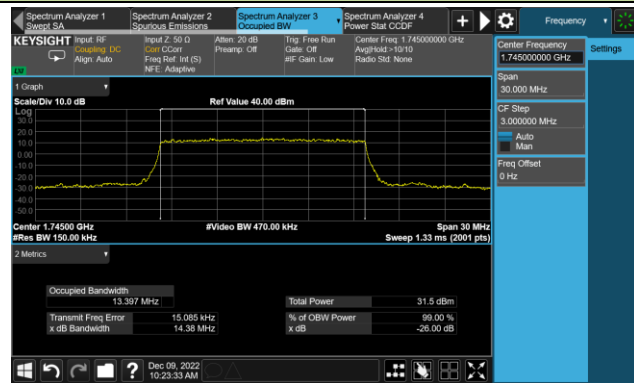

20MHz Channel Bandwidth

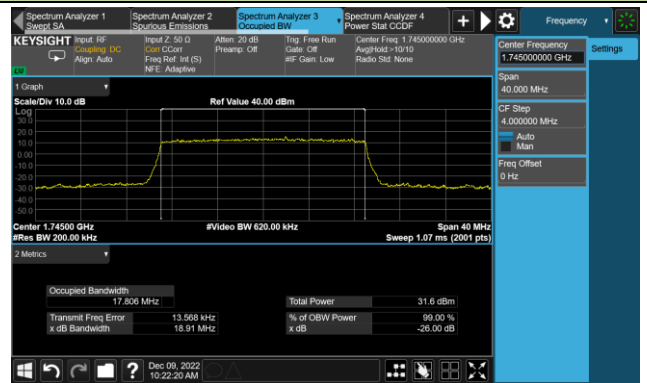

99% Bandwidth - 16QAM

1.4MHz Channel Bandwidth

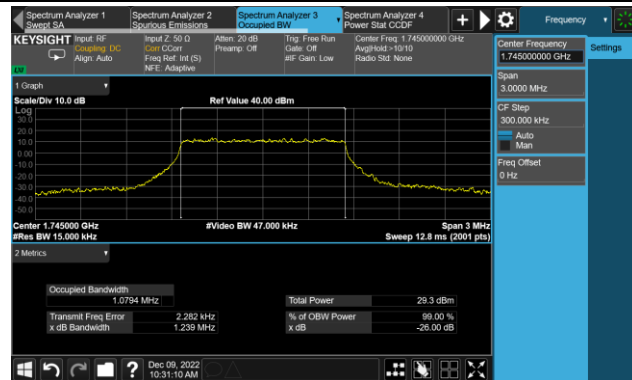

3MHz Channel Bandwidth

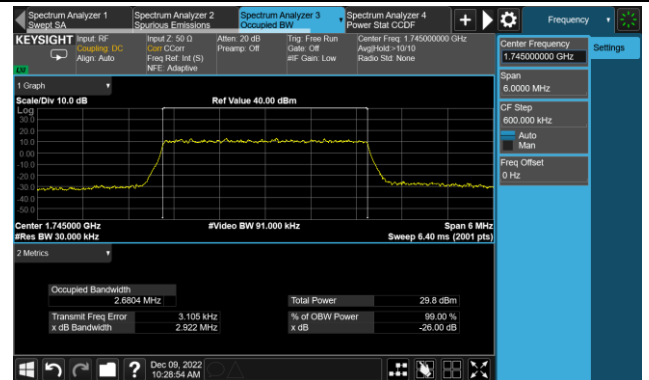

5MHz Channel Bandwidth

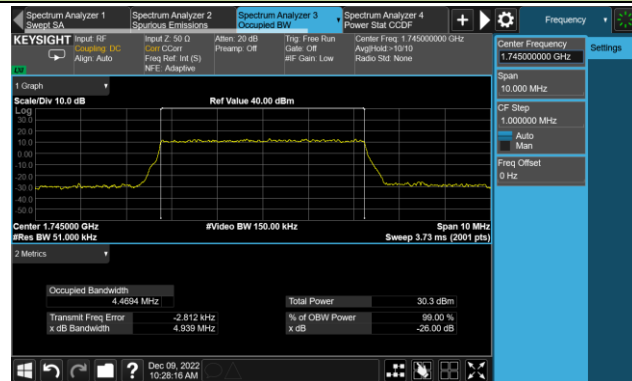

10MHz Channel Bandwidth

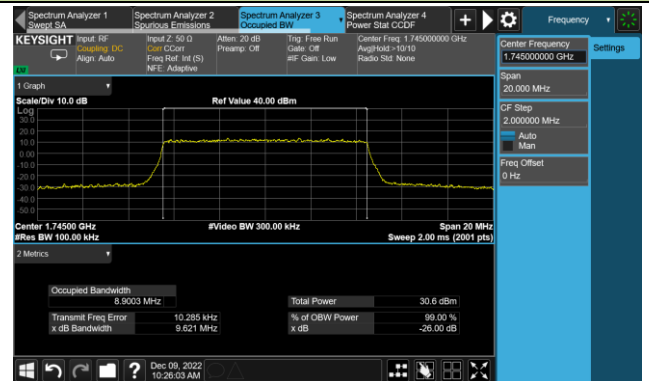

15MHz Channel Bandwidth

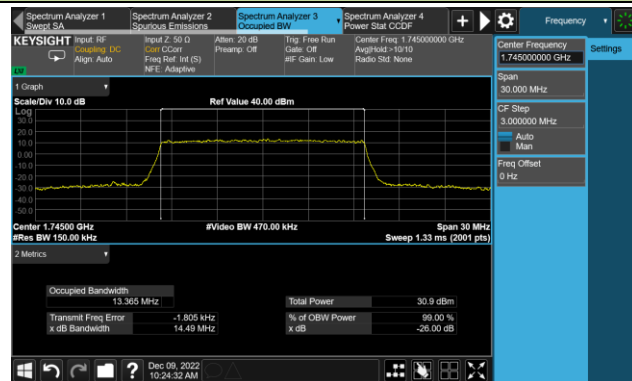

20MHz Channel Bandwidth

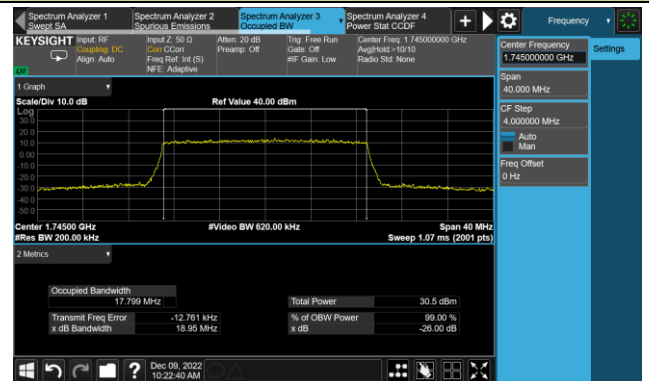

Test Site	WZ-SR6	Test Engineer	Cloud Guo
Test Date	2022/12/09	Test Band	Band 5/26

Modulation	Bandwidth (MHz)	Frequency (MHz)	99% Bandwidth (MHz)
QPSK	1.4	836.5	1.08
	3		2.69
	5		4.47
	10		8.92
	15		13.40
	15	821.5	13.38
16QAM	1.4	836.5	1.08
	3		2.68
	5		4.46
	10		8.90
	15		13.37
	15	821.5	13.38

99% Bandwidth - QPSK

1.4MHz Channel Bandwidth

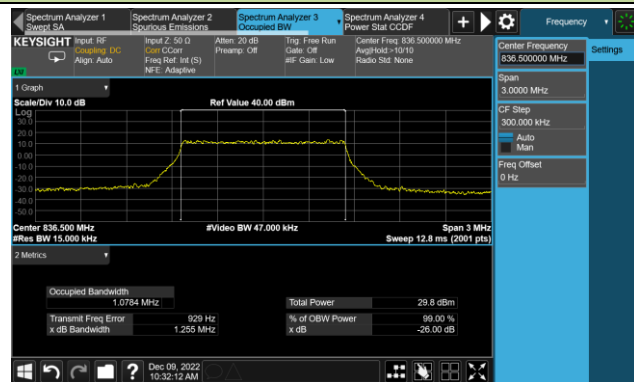

3MHz Channel Bandwidth



5MHz Channel Bandwidth

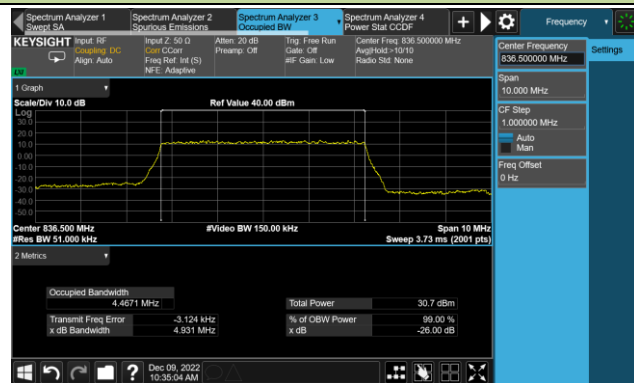

10MHz Channel Bandwidth

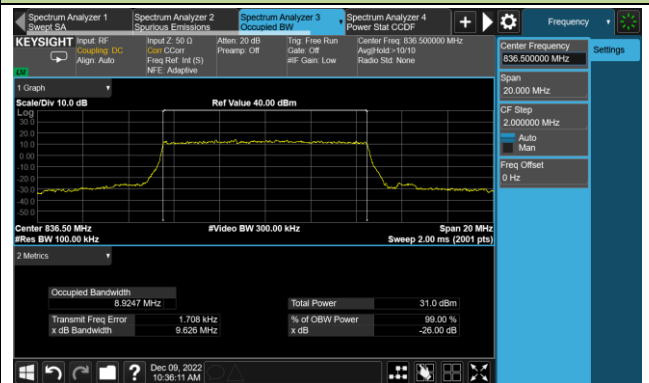

15MHz Channel Bandwidth

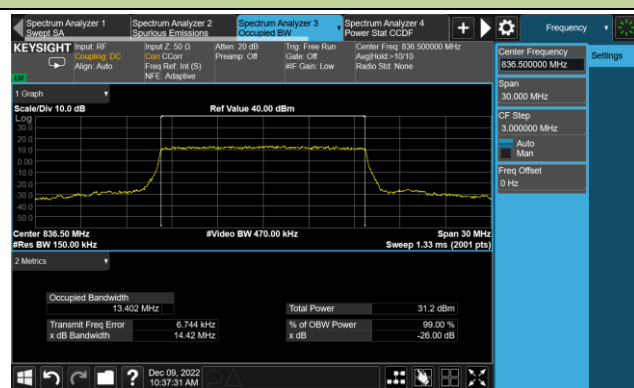

821.5MHz

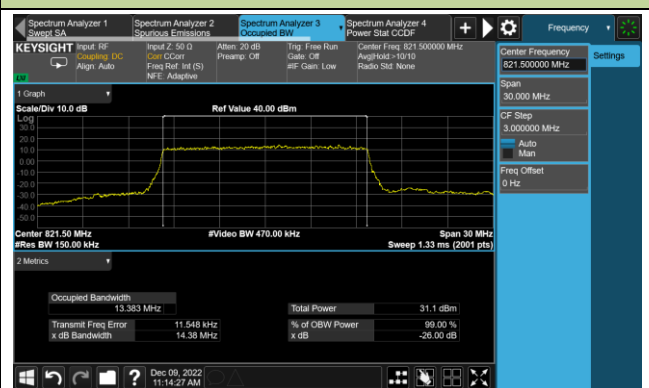

99% Bandwidth -16QAM

1.4MHz Channel Bandwidth

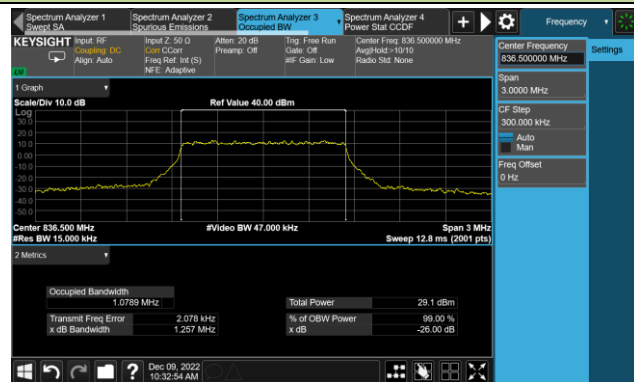

3MHz Channel Bandwidth

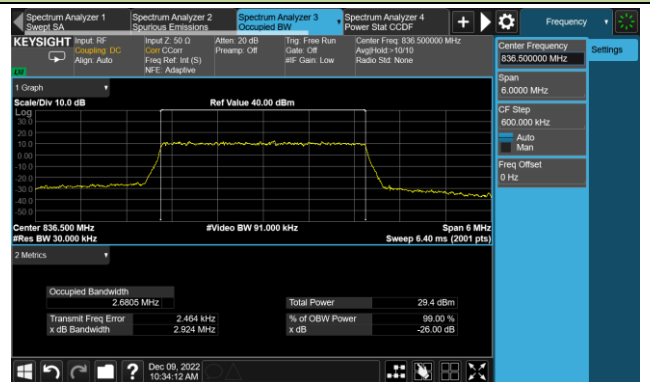

5MHz Channel Bandwidth

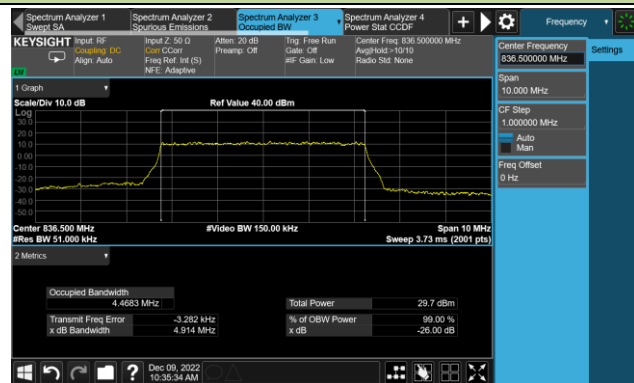

10MHz Channel Bandwidth

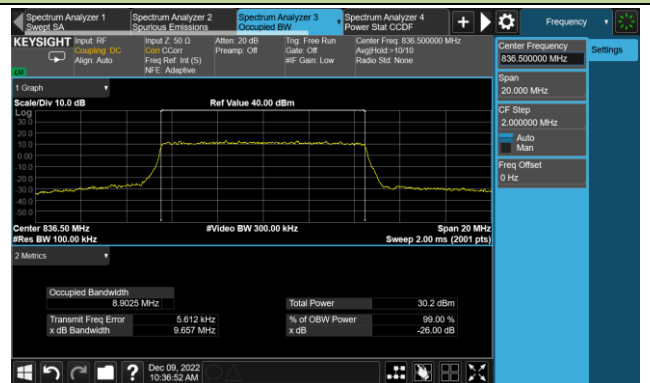

15MHz Channel Bandwidth

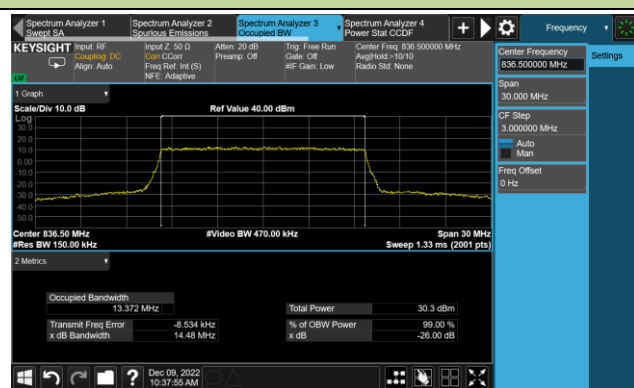

821.5MHz

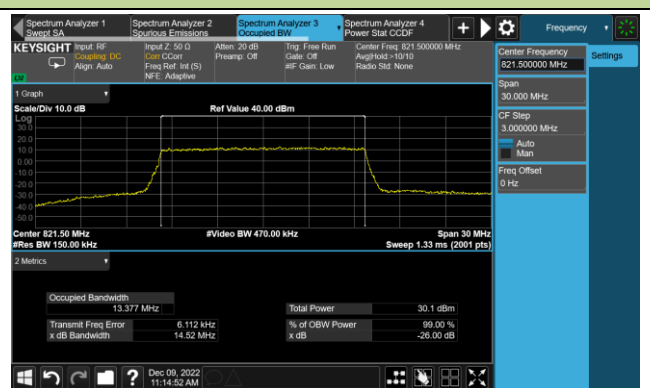

Test Site	WZ-SR6	Test Engineer	Cloud Guo
Test Date	2022/12/09	Test Band	LTE Band 7

Modulation	Bandwidth (MHz)	Frequency (MHz)	99% Bandwidth (MHz)
QPSK	5	2535.0	4.47
	10		8.92
	15		13.41
	20		17.81
16QAM	5	2535.0	4.47
	10		8.90
	15		13.37
	20		17.84

99% Bandwidth - QPSK

5MHz Channel Bandwidth

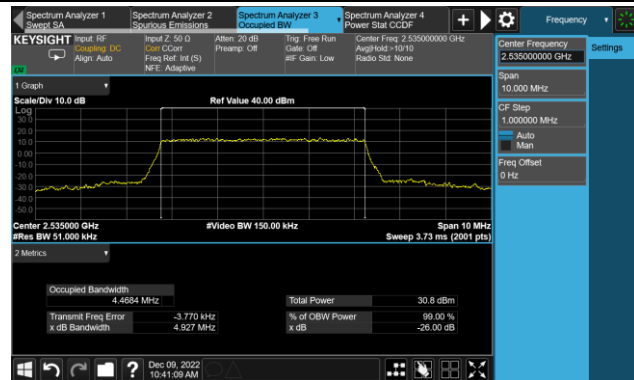

10MHz Channel Bandwidth

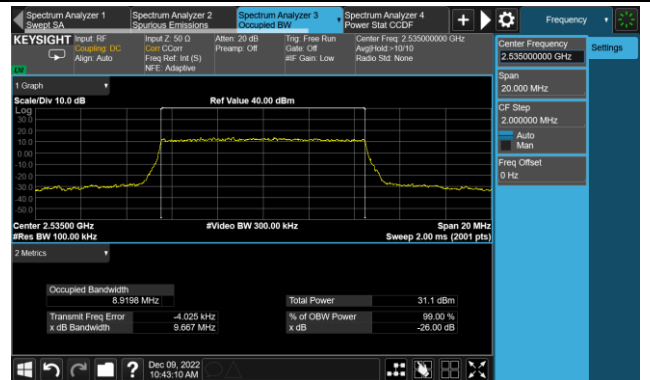

15MHz Channel Bandwidth

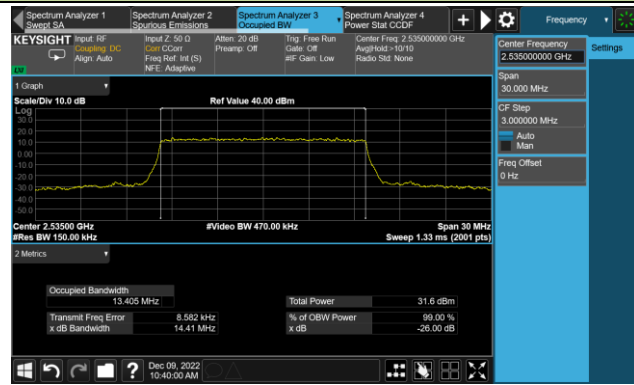

20MHz Channel Bandwidth

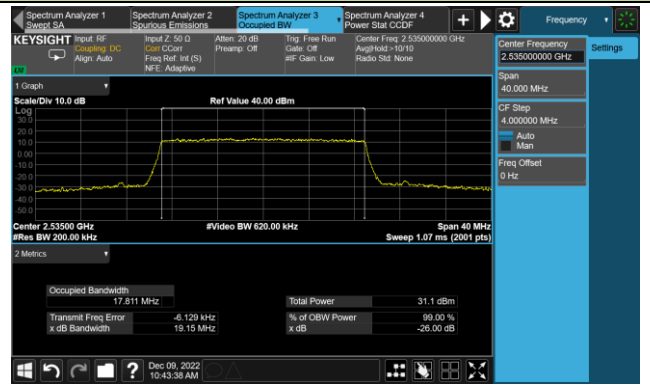

99% Bandwidth - 16QAM

5MHz Channel Bandwidth

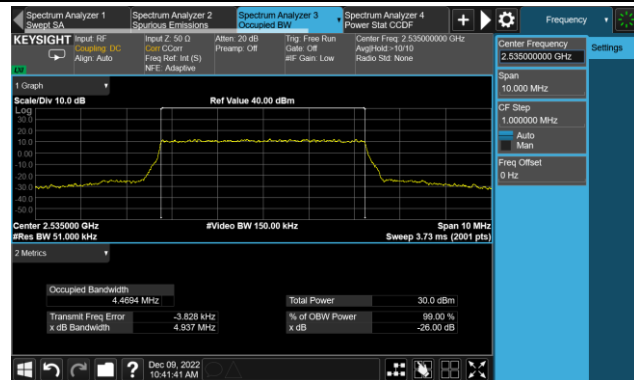

10MHz Channel Bandwidth

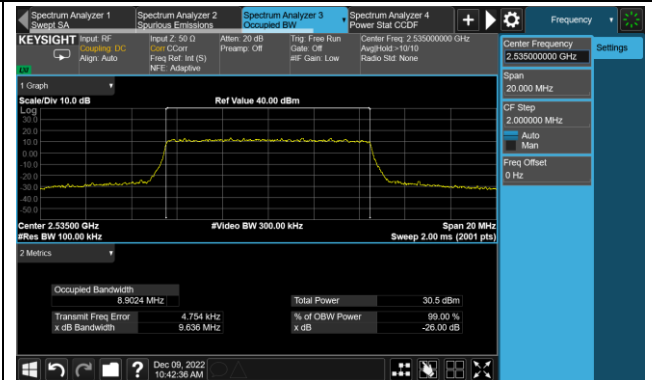

15MHz Channel Bandwidth

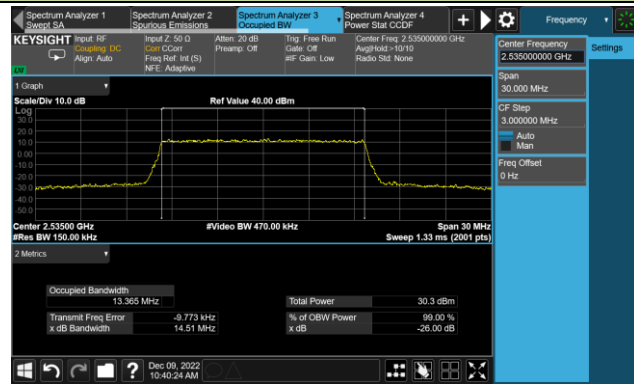

20MHz Channel Bandwidth

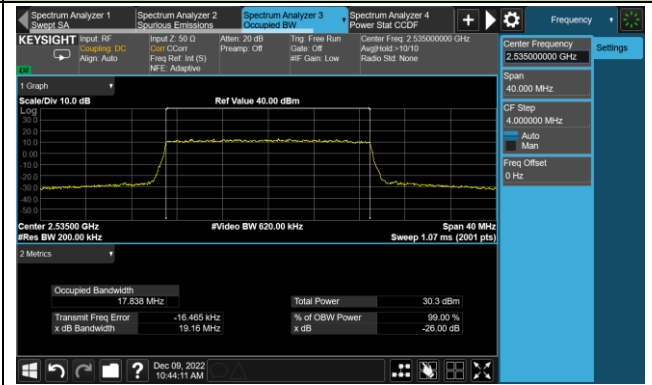

Test Site	WZ-SR6	Test Engineer	Cloud Guo
Test Date	2022/12/09	Test Band	LTE Band 12

Modulation	Bandwidth (MHz)	Frequency (MHz)	99% Bandwidth (MHz)
QPSK	1.4	707.5	1.08
	3		2.68
	5		4.47
	10		8.93
16QAM	1.4	707.5	1.08
	3		2.68
	5		4.47
	10		8.91

99% Bandwidth - QPSK

1.4MHz Channel Bandwidth

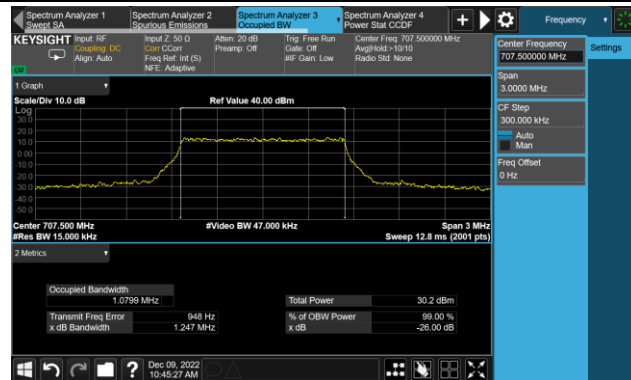

3MHz Channel Bandwidth



5MHz Channel Bandwidth

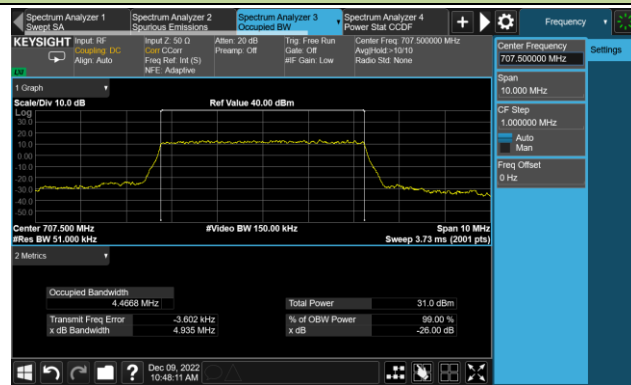

10MHz Channel Bandwidth

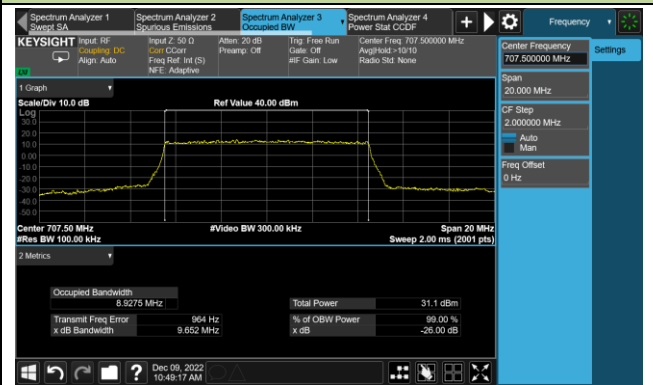

99% Bandwidth - 16QAM

1.4MHz Channel Bandwidth

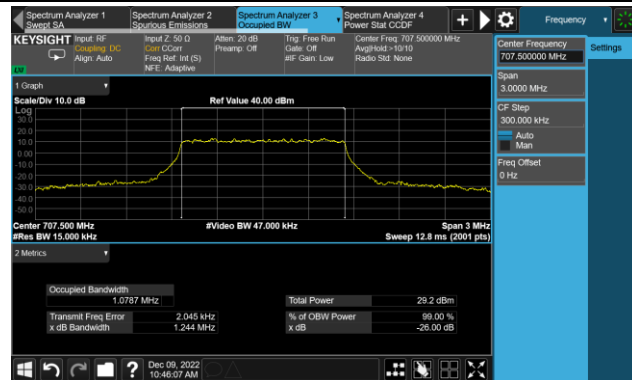

3MHz Channel Bandwidth

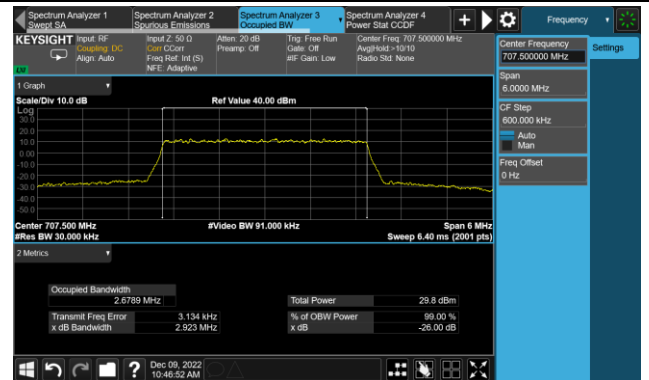

5MHz Channel Bandwidth

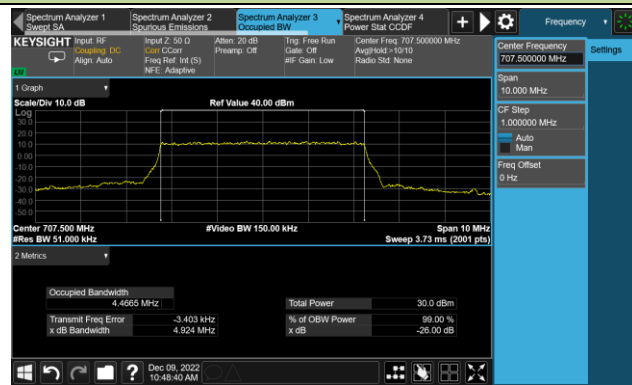

10MHz Channel Bandwidth

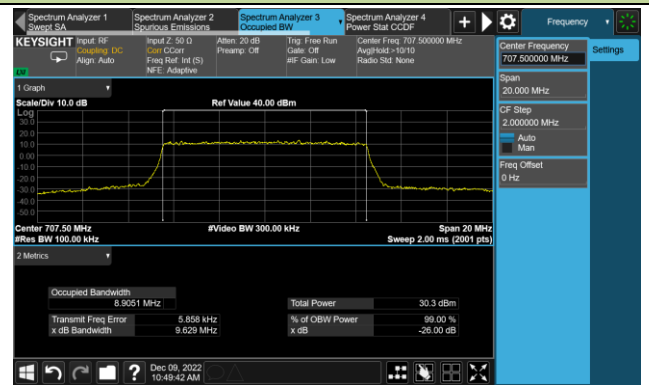

Test Site	WZ-SR6	Test Engineer	Cloud Guo
Test Date	2022/12/09	Test Band	LTE Band 13

Modulation	Bandwidth (MHz)	Frequency (MHz)	99% Bandwidth (MHz)
QPSK	5	782.0	4.47
	10		8.92
16QAM	5	782.0	4.47
	10		8.89



Test Site	WZ-SR6	Test Engineer	Cloud Guo
Test Date	2022/12/09	Test Band	LTE Band 38/41

Modulation	Bandwidth (MHz)	Frequency (MHz)	99% Bandwidth (MHz)
QPSK	5	2593.0	4.47
	10		8.92
	15		13.39
	20		17.82
16QAM	5	2593.0	4.46
	10		8.91
	15		13.38
	20		17.82

99% Bandwidth - QPSK

5MHz Channel Bandwidth

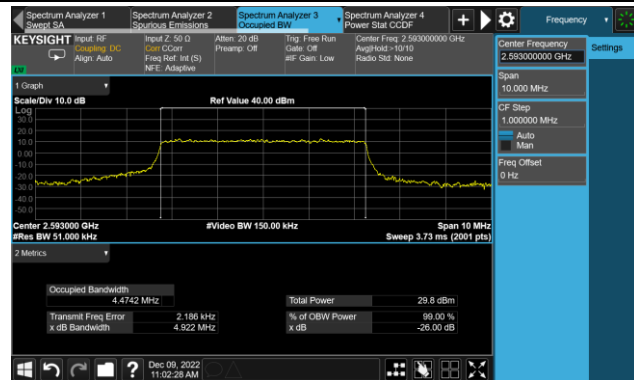

10MHz Channel Bandwidth

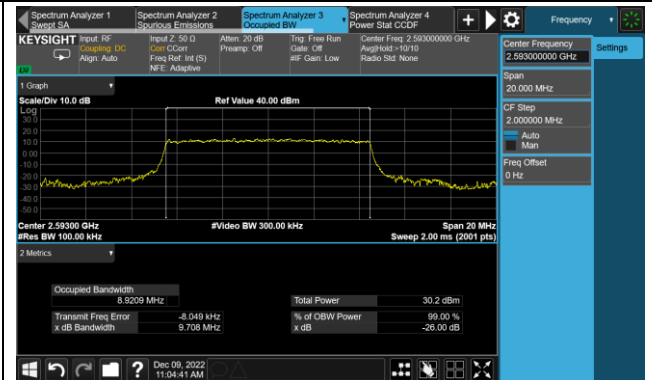

15MHz Channel Bandwidth

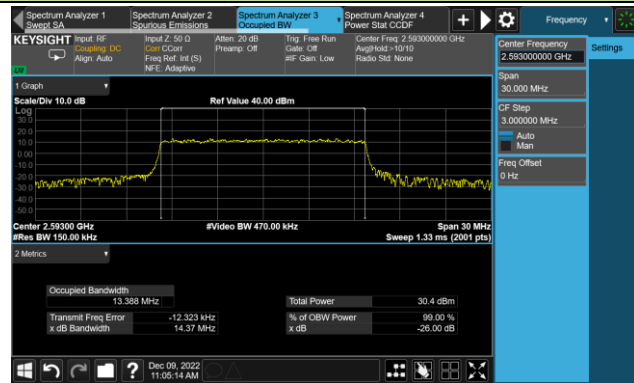

20MHz Channel Bandwidth

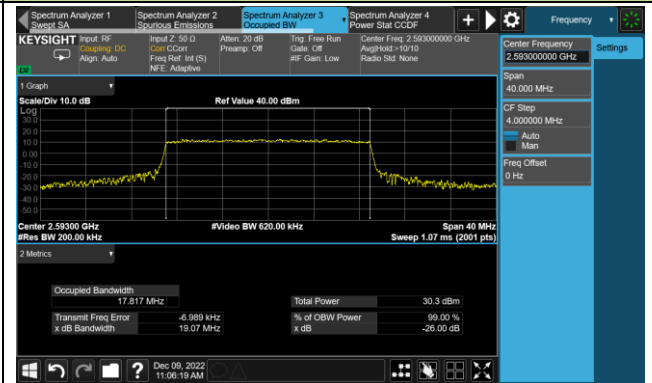

99% Bandwidth - 16QAM

5MHz Channel Bandwidth

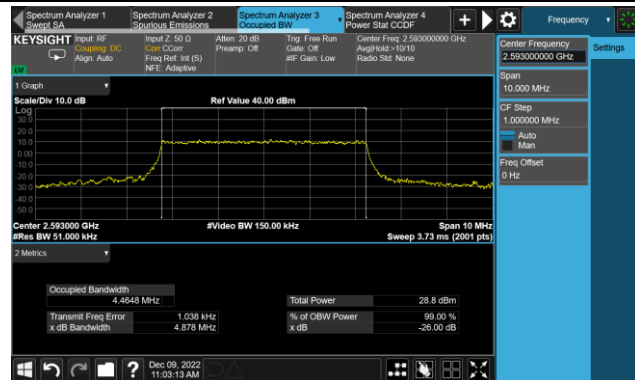

10MHz Channel Bandwidth

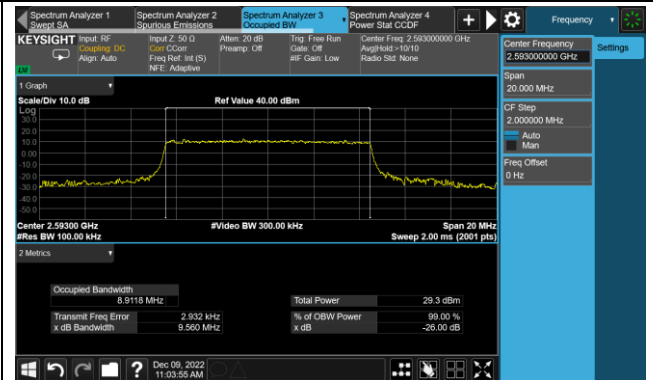

15MHz Channel Bandwidth

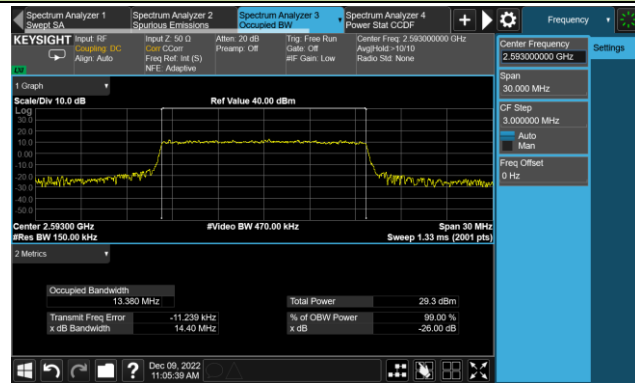

20MHz Channel Bandwidth

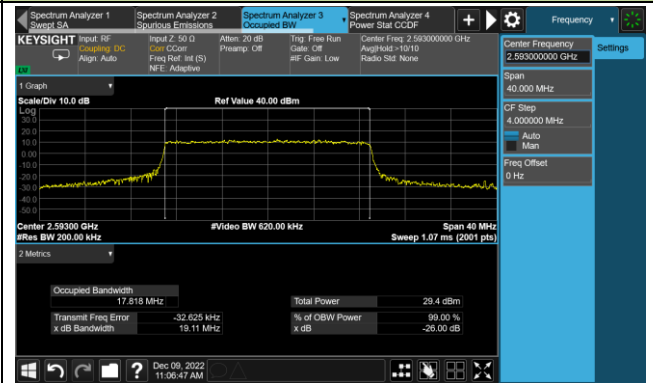

A.2 Frequency Stability Test Result

Test Site	WZ-TR3	Test Engineer	Cloud Guo
Test Date	2022/11/29	Test Band	LTE Band 2/25

Power (VDC)	Temp (°C)	Frequency Tolerance (ppm)
3.80	- 30	-0.0011
	- 20	-0.0019
	- 10	-0.0007
	0	-0.0022
	+ 10	-0.0021
	+ 20 (Ref)	0.0000
	+ 30	-0.0057
	+ 40	-0.0051
	+ 50	-0.0052
4.30	+ 20	-0.0060
3.30	+ 20	-0.0027

Test Site	WZ-TR3	Test Engineer	Cloud Guo
Test Date	2022/11/29	Test Band	LTE Band 4/66

Power (VDC)	Temp (°C)	Frequency Tolerance (ppm)
3.80	- 30	0.0019
	- 20	0.0016
	- 10	0.0016
	0	0.0023
	+ 10	0.0013
	+ 20 (Ref)	0.0000
	+ 30	0.0003
	+ 40	0.0007
	+ 50	0.0005
4.30	+ 20	0.0007
3.30	+ 20	0.0005

Test Site	WZ-TR3	Test Engineer	Cloud Guo
Test Date	2022/11/29	Test Band	LTE Band 5/26

Power (VDC)	Temp (°C)	Frequency Tolerance (ppm)
3.80	- 30	-0.0088
	- 20	-0.0038
	- 10	-0.0044
	0	-0.0048
	+ 10	-0.0025
	+ 20 (Ref)	0.0000
	+ 30	-0.0016
	+ 40	-0.0056
	+ 50	-0.0088
4.30	+ 20	-0.0075
3.30	+ 20	-0.0049

Test Site	WZ-TR3	Test Engineer	Cloud Guo
Test Date	2022/11/29	Test Band	LTE Band 7

Power (VDC)	Temp (°C)	Frequency Tolerance (ppm)
3.80	- 30	0.0002
	- 20	0.0007
	- 10	0.0004
	0	0.0019
	+ 10	0.0002
	+ 20 (Ref)	0.0000
	+ 30	0.0013
	+ 40	-0.0003
	+ 50	0.0017
4.30	+ 20	0.0000
3.30	+ 20	0.0011

Test Site	WZ-TR3	Test Engineer	Cloud Guo
Test Date	2022/11/29	Test Band	LTE Band 12

Power (VDC)	Temp (°C)	Frequency Tolerance (ppm)
3.80	- 30	0.0052
	- 20	0.0055
	- 10	0.0049
	0	0.0025
	+ 10	0.0044
	+ 20 (Ref)	0.0000
	+ 30	0.0010
	+ 40	0.0020
	+ 50	0.0051
4.30	+ 20	0.0000
3.30	+ 20	0.0014

Test Site	WZ-TR3	Test Engineer	Cloud Guo
Test Date	2022/11/29	Test Band	LTE Band 13

Power (VDC)	Temp (°C)	Frequency Tolerance (ppm)
3.80	- 30	0.0042
	- 20	0.0045
	- 10	0.0052
	0	0.0047
	+ 10	0.0066
	+ 20 (Ref)	0.0000
	+ 30	-0.0014
	+ 40	0.0003
	+ 50	-0.0003
4.30	+ 20	-0.0005
3.30	+ 20	-0.0036

Test Site	WZ-TR3	Test Engineer	Cloud Guo
Test Date	2022/11/29	Test Band	LTE Band 38/41

Power (VDC)	Temp (°C)	Frequency Tolerance (ppm)
3.80	- 30	0.0028
	- 20	-0.0009
	- 10	-0.0006
	0	0.0043
	+ 10	-0.0002
	+ 20 (Ref)	0.0000
	+ 30	0.0044
	+ 40	0.0047
	+ 50	0.0005
4.30	+ 20	0.0048
3.30	+ 20	0.0049

A.3 Equivalent Isotropically Radited Power Test Result

Test Site	WZ-SR6	Test Engineer	Cloud Guo
Test Date	2022/12/08	Test Band	LTE Band 2/25

Frequency (MHz)	Channel Bandwidth (MHz)	RB Size	RB Offset	Output Power (dBm)	EIRP (dBm)	Limit (dBm)
QPSK						
1850.70	1.4	1	0	23.25	24.63	< 33.01
1882.50				23.24	24.62	< 33.01
1914.30				23.32	24.70	< 33.01
1850.70	1.4	1	2	23.44	24.82	< 33.01
1882.50				23.33	24.71	< 33.01
1914.30				23.54	24.92	< 33.01
1850.70	1.4	1	6	23.31	24.69	< 33.01
1882.50				23.22	24.60	< 33.01
1914.30				23.26	24.64	< 33.01
1850.70	1.4	6	0	22.36	23.74	< 33.01
1882.50				22.32	23.70	< 33.01
1914.30				22.39	23.77	< 33.01
1851.50	3	1	0	23.48	24.86	< 33.01
1882.50				23.18	24.56	< 33.01
1913.50				23.12	24.50	< 33.01
1851.50	3	1	7	23.39	24.77	< 33.01
1882.50				23.29	24.67	< 33.01
1913.50				23.26	24.64	< 33.01
1851.50	3	1	14	23.17	24.55	< 33.01
1882.50				23.36	24.74	< 33.01
1913.50				22.98	24.36	< 33.01
1851.50	3	15	0	22.36	23.74	< 33.01
1882.50				22.24	23.62	< 33.01
1913.50				22.44	23.82	< 33.01

Frequency (MHz)	Channel Bandwidth (MHz)	RB Size	RB Offset	Output Power (dBm)	EIRP (dBm)	Limit (dBm)
QPSK						
1852.50	5	1	0	23.20	24.58	< 33.01
1882.50				23.26	24.64	< 33.01
1912.50				23.27	24.65	< 33.01
1852.50	5	1	12	23.23	24.61	< 33.01
1882.50				23.30	24.68	< 33.01
1912.50				23.16	24.54	< 33.01
1852.50	5	1	24	23.23	24.61	< 33.01
1882.50				23.26	24.64	< 33.01
1912.50				23.21	24.59	< 33.01
1852.50	5	25	0	22.21	23.59	< 33.01
1882.50				22.26	23.64	< 33.01
1912.50				22.33	23.71	< 33.01
1855.00	10	1	0	23.23	24.61	< 33.01
1882.50				23.21	24.59	< 33.01
1910.00				23.21	24.59	< 33.01
1855.00	10	1	24	23.23	24.61	< 33.01
1882.50				23.38	24.76	< 33.01
1910.00				23.40	24.78	< 33.01
1855.00	10	1	49	23.23	24.61	< 33.01
1882.50				23.16	24.54	< 33.01
1910.00				23.18	24.56	< 33.01
1855.00	10	50	0	22.38	23.76	< 33.01
1882.50				22.35	23.73	< 33.01
1910.00				22.47	23.85	< 33.01
Note: The EIRP (dBm) = Output Power (dBm) + Antenna Gain (dBi)						

Frequency (MHz)	Channel Bandwidth (MHz)	RB Size	RB Offset	Output Power (dBm)	EIRP (dBm)	Limit (dBm)
QPSK						
1857.50	15	1	0	23.21	24.59	< 33.01
1882.50				23.35	24.73	< 33.01
1907.50				23.32	24.70	< 33.01
1857.50	15	1	37	23.38	24.76	< 33.01
1882.50				23.38	24.76	< 33.01
1907.50				23.30	24.68	< 33.01
1857.50	15	1	74	23.44	24.82	< 33.01
1882.50				23.26	24.64	< 33.01
1907.50				23.32	24.70	< 33.01
1857.50	15	75	0	22.25	23.63	< 33.01
1882.50				22.39	23.77	< 33.01
1907.50				22.52	23.90	< 33.01
1860.00	20	1	0	23.23	24.61	< 33.01
1882.50				23.36	24.74	< 33.01
1905.00				23.30	24.68	< 33.01
1860.00	20	1	49	23.50	24.88	< 33.01
1882.50				23.48	24.86	< 33.01
1905.00				23.62	25.00	< 33.01
1860.00	20	1	99	23.23	24.61	< 33.01
1882.50				23.23	24.61	< 33.01
1905.00				23.44	24.82	< 33.01
1860.00	20	100	0	22.32	23.70	< 33.01
1882.50				22.39	23.77	< 33.01
1905.00				22.50	23.88	< 33.01
Note: The EIRP (dBm) = Output Power (dBm) + Antenna Gain (dBi)						

Frequency (MHz)	Channel Bandwidth (MHz)	RB Size	RB Offset	Output Power (dBm)	EIRP (dBm)	Limit (dBm)
16QAM						
1850.70	1.4	1	0	21.88	23.26	< 33.01
1882.50				21.96	23.34	< 33.01
1914.30				22.08	23.46	< 33.01
1850.70	1.4	1	2	22.03	23.41	< 33.01
1882.50				21.81	23.19	< 33.01
1914.30				21.98	23.36	< 33.01
1850.70	1.4	1	6	21.91	23.29	< 33.01
1882.50				22.10	23.48	< 33.01
1914.30				21.91	23.29	< 33.01
1850.70	1.4	6	0	21.38	22.76	< 33.01
1882.50				21.56	22.94	< 33.01
1914.30				21.33	22.71	< 33.01
1851.50	3	1	0	22.09	23.47	< 33.01
1882.50				21.88	23.26	< 33.01
1913.50				22.04	23.42	< 33.01
1851.50	3	1	7	22.00	23.38	< 33.01
1882.50				22.25	23.63	< 33.01
1913.50				22.27	23.65	< 33.01
1851.50	3	1	14	21.94	23.32	< 33.01
1882.50				22.17	23.55	< 33.01
1913.50				22.05	23.43	< 33.01
1851.50	3	15	0	21.39	22.77	< 33.01
1882.50				21.28	22.66	< 33.01
1913.50				21.46	22.84	< 33.01
Note: The EIRP (dBm) = Output Power (dBm) + Antenna Gain (dBi)						

Frequency (MHz)	Channel Bandwidth (MHz)	RB Size	RB Offset	Output Power (dBm)	EIRP (dBm)	Limit (dBm)
16QAM						
1852.50	5	1	0	21.97	23.35	< 33.01
1882.50				22.12	23.50	< 33.01
1912.50				21.85	23.23	< 33.01
1852.50	5	1	12	21.50	22.88	< 33.01
1882.50				21.91	23.29	< 33.01
1912.50				21.88	23.26	< 33.01
1852.50	5	1	24	22.06	23.44	< 33.01
1882.50				22.27	23.65	< 33.01
1912.50				21.65	23.03	< 33.01
1852.50	5	25	0	21.33	22.71	< 33.01
1882.50				21.41	22.79	< 33.01
1912.50				21.38	22.76	< 33.01
1855.00	10	1	0	22.06	23.44	< 33.01
1882.50				22.43	23.81	< 33.01
1910.00				21.98	23.36	< 33.01
1855.00	10	1	24	22.02	23.40	< 33.01
1882.50				22.41	23.79	< 33.01
1910.00				22.16	23.54	< 33.01
1855.00	10	1	49	21.91	23.29	< 33.01
1882.50				22.01	23.39	< 33.01
1910.00				22.16	23.54	< 33.01
1855.00	10	50	0	21.39	22.77	< 33.01
1882.50				21.35	22.73	< 33.01
1910.00				21.49	22.87	< 33.01
Note: The EIRP (dBm) = Output Power (dBm) + Antenna Gain (dBi)						

Frequency (MHz)	Channel Bandwidth (MHz)	RB Size	RB Offset	Output Power (dBm)	EIRP (dBm)	Limit (dBm)
16QAM						
1857.50	15	1	0	22.16	23.54	< 33.01
1882.50				22.27	23.65	< 33.01
1907.50				21.85	23.23	< 33.01
1857.50	15	1	37	22.24	23.62	< 33.01
1882.50				22.46	23.84	< 33.01
1907.50				22.54	23.92	< 33.01
1857.50	15	1	74	22.01	23.39	< 33.01
1882.50				22.14	23.52	< 33.01
1907.50				22.17	23.55	< 33.01
1857.50	15	75	0	21.27	22.65	< 33.01
1882.50				21.50	22.88	< 33.01
1907.50				21.43	22.81	< 33.01
1860.00	20	1	0	22.25	23.63	< 33.01
1882.50				22.60	23.98	< 33.01
1905.00				21.97	23.35	< 33.01
1860.00	20	1	49	22.25	23.63	< 33.01
1882.50				21.82	23.20	< 33.01
1905.00				22.46	23.84	< 33.01
1860.00	20	1	99	21.96	23.34	< 33.01
1882.50				21.66	23.04	< 33.01
1905.00				22.41	23.79	< 33.01
1860.00	20	100	0	21.22	22.60	< 33.01
1882.50				21.41	22.79	< 33.01
1905.00				21.44	22.82	< 33.01
Note: The EIRP (dBm) = Output Power (dBm) + Antenna Gain (dBi)						

Test Site	WZ-SR6	Test Engineer	Cloud Guo
Test Date	2022/12/08	Test Band	LTE Band 4/66

Frequency (MHz)	Channel Bandwidth (MHz)	RB Size	RB Offset	Output Power (dBm)	EIRP (dBm)	Limit (dBm)
QPSK						
1710.70	1.4	1	0	23.05	25.05	< 30.00
1745.00				23.08	25.08	< 30.00
1779.30				23.33	25.33	< 30.00
1710.70	1.4	1	2	23.09	25.09	< 30.00
1745.00				23.15	25.15	< 30.00
1779.30				23.41	25.41	< 30.00
1710.70	1.4	1	6	22.98	24.98	< 30.00
1745.00				22.97	24.97	< 30.00
1779.30				23.03	25.03	< 30.00
1710.70	1.4	6	0	22.16	24.16	< 30.00
1732.50				22.16	24.16	< 30.00
1754.30				22.36	24.36	< 30.00
1711.50	3	1	0	23.09	25.09	< 30.00
1745.00				23.20	25.20	< 30.00
1778.50				23.34	25.34	< 30.00
1711.50	3	1	7	23.13	25.13	< 30.00
1745.00				23.03	25.03	< 30.00
1778.50				23.44	25.44	< 30.00
1711.50	3	1	14	23.19	25.19	< 30.00
1745.00				23.04	25.04	< 30.00
1778.50				23.31	25.31	< 30.00
1711.50	3	15	0	22.20	24.20	< 30.00
1745.00				22.30	24.30	< 30.00
1778.50				22.40	24.40	< 30.00

Note: The EIRP (dBm) = Output Power (dBm) + Antenna Gain (dBi)

Frequency (MHz)	Channel Bandwidth (MHz)	RB Size	RB Offset	Output Power (dBm)	EIRP (dBm)	Limit (dBm)
QPSK						
1712.50	5	1	0	23.16	25.16	< 30.00
1745.00				23.24	25.24	< 30.00
1777.50				23.34	25.34	< 30.00
1712.50	5	1	12	23.23	25.23	< 30.00
1745.00				23.15	25.15	< 30.00
1777.50				23.51	25.51	< 30.00
1712.50	5	1	24	23.17	25.17	< 30.00
1745.00				23.16	25.16	< 30.00
1777.50				23.45	25.45	< 30.00
1712.50	5	25	0	22.24	24.24	< 30.00
1745.00				22.16	24.16	< 30.00
1777.50				22.51	24.51	< 30.00
1715.00	10	1	0	23.12	25.12	< 30.00
1745.00				23.17	25.17	< 30.00
1775.00				23.13	25.13	< 30.00
1715.00	10	1	24	23.25	25.25	< 30.00
1745.00				23.43	25.43	< 30.00
1775.00				23.38	25.38	< 30.00
1715.00	10	1	49	22.94	24.94	< 30.00
1745.00				23.36	25.36	< 30.00
1775.00				23.11	25.11	< 30.00
1715.00	10	50	0	22.34	24.34	< 30.00
1745.00				22.33	24.33	< 30.00
1775.00				22.40	24.40	< 30.00
Note: The EIRP (dBm) = Output Power (dBm) + Antenna Gain (dBi)						

Frequency (MHz)	Channel Bandwidth (MHz)	RB Size	RB Offset	Output Power (dBm)	EIRP (dBm)	Limit (dBm)
QPSK						
1717.50	15	1	0	23.24	25.24	< 30.00
1745.00				23.21	25.21	< 30.00
1772.50				23.28	25.28	< 30.00
1717.50	15	1	37	23.29	25.29	< 30.00
1745.00				23.26	25.26	< 30.00
1772.50				23.57	25.57	< 30.00
1717.50	15	1	74	23.25	25.25	< 30.00
1745.00				23.10	25.10	< 30.00
1772.50				23.36	25.36	< 30.00
1717.50	15	75	0	22.36	24.36	< 30.00
1745.00				22.34	24.34	< 30.00
1772.50				22.49	24.49	< 30.00
1720.00	20	1	0	23.12	25.12	< 30.00
1745.00				23.22	25.22	< 30.00
1770.00				23.30	25.30	< 30.00
1720.00	20	1	49	23.57	25.57	< 30.00
1745.00				23.48	25.48	< 30.00
1770.00				23.62	25.62	< 30.00
1720.00	20	1	99	23.39	25.39	< 30.00
1745.00				23.45	25.45	< 30.00
1770.00				23.34	25.34	< 30.00
1720.00	20	100	0	22.30	24.30	< 30.00
1745.00				22.40	24.40	< 30.00
1770.00				22.45	24.45	< 30.00
Note: The EIRP (dBm) = Output Power (dBm) + Antenna Gain (dBi)						

Frequency (MHz)	Channel Bandwidth (MHz)	RB Size	RB Offset	Output Power (dBm)	EIRP (dBm)	Limit (dBm)
16QAM						
1710.70	1.4	1	0	21.67	23.67	< 30.00
1745.00				22.09	24.09	< 30.00
1779.30				21.76	23.76	< 30.00
1710.70	1.4	1	2	21.89	23.89	< 30.00
1745.00				22.16	24.16	< 30.00
1779.30				21.71	23.71	< 30.00
1710.70	1.4	1	6	21.85	23.85	< 30.00
1745.00				21.95	23.95	< 30.00
1779.30				21.78	23.78	< 30.00
1710.70	1.4	6	0	21.57	23.57	< 30.00
1732.50				21.10	23.10	< 30.00
1754.30				21.22	23.22	< 30.00
1711.50	3	1	0	21.93	23.93	< 30.00
1745.00				21.92	23.92	< 30.00
1778.50				22.18	24.18	< 30.00
1711.50	3	1	7	22.38	24.38	< 30.00
1745.00				22.23	24.23	< 30.00
1778.50				22.12	24.12	< 30.00
1711.50	3	1	14	21.79	23.79	< 30.00
1745.00				21.88	23.88	< 30.00
1778.50				22.16	24.16	< 30.00
1711.50	3	15	0	21.30	23.30	< 30.00
1745.00				21.38	23.38	< 30.00
1778.50				21.30	23.30	< 30.00
Note: The EIRP (dBm) = Output Power (dBm) + Antenna Gain (dBi)						

Frequency (MHz)	Channel Bandwidth (MHz)	RB Size	RB Offset	Output Power (dBm)	EIRP (dBm)	Limit (dBm)
16QAM						
1712.50	5	1	0	21.48	23.48	< 30.00
1745.00				22.05	24.05	< 30.00
1777.50				22.19	24.19	< 30.00
1712.50	5	1	12	21.56	23.56	< 30.00
1745.00				22.20	24.20	< 30.00
1777.50				22.42	24.42	< 30.00
1712.50	5	1	24	21.63	23.63	< 30.00
1745.00				22.20	24.20	< 30.00
1777.50				22.22	24.22	< 30.00
1712.50	5	25	0	21.15	23.15	< 30.00
1745.00				21.19	23.19	< 30.00
1777.50				21.56	23.56	< 30.00
1715.00	10	1	0	22.01	24.01	< 30.00
1745.00				22.06	24.06	< 30.00
1775.00				21.95	23.95	< 30.00
1715.00	10	1	24	22.06	24.06	< 30.00
1745.00				22.15	24.15	< 30.00
1775.00				22.33	24.33	< 30.00
1715.00	10	1	49	22.06	24.06	< 30.00
1745.00				21.99	23.99	< 30.00
1775.00				21.91	23.91	< 30.00
1715.00	10	50	0	21.24	23.24	< 30.00
1745.00				21.45	23.45	< 30.00
1775.00				21.30	23.30	< 30.00
Note: The EIRP (dBm) = Output Power (dBm) + Antenna Gain (dBi)						

Frequency (MHz)	Channel Bandwidth (MHz)	RB Size	RB Offset	Output Power (dBm)	EIRP (dBm)	Limit (dBm)
16QAM						
1717.50	15	1	0	21.95	23.95	< 30.00
1745.00				22.08	24.08	< 30.00
1772.50				22.23	24.23	< 30.00
1717.50	15	1	37	22.22	24.22	< 30.00
1745.00				22.11	24.11	< 30.00
1772.50				22.63	24.63	< 30.00
1717.50	15	1	74	22.09	24.09	< 30.00
1745.00				22.02	24.02	< 30.00
1772.50				22.15	24.15	< 30.00
1717.50	15	75	0	21.42	23.42	< 30.00
1745.00				21.47	23.47	< 30.00
1772.50				21.41	23.41	< 30.00
1720.00	20	1	0	21.80	23.80	< 30.00
1745.00				21.52	23.52	< 30.00
1770.00				21.83	23.83	< 30.00
1720.00	20	1	49	21.89	23.89	< 30.00
1745.00				21.89	23.89	< 30.00
1770.00				21.81	23.81	< 30.00
1720.00	20	1	99	21.68	23.68	< 30.00
1745.00				21.86	23.86	< 30.00
1770.00				22.43	24.43	< 30.00
1720.00	20	100	0	21.32	23.32	< 30.00
1745.00				21.42	23.42	< 30.00
1770.00				21.49	23.49	< 30.00
Note: The EIRP (dBm) = Output Power (dBm) + Antenna Gain (dBi)						

Test Site	WZ-SR6	Test Engineer	Cloud Guo
Test Date	2022/12/08	Test Band	LTE Band 5/26

Frequency (MHz)	Channel Bandwidth (MHz)	RB Size	RB Offset	Output Power (dBm)	ERP (dBm)	Limit (dBm)
QPSK						
824.70	1.4	1	0	23.20	23.18	< 38.45
836.50				23.35	23.33	< 38.45
848.30				23.29	23.27	< 38.45
824.70	1.4	1	2	23.25	23.23	< 38.45
836.50				23.34	23.32	< 38.45
848.30				23.28	23.26	< 38.45
824.70	1.4	1	6	23.21	23.19	< 38.45
836.50				23.08	23.06	< 38.45
848.30				23.18	23.16	< 38.45
824.70	1.4	6	0	22.25	22.23	< 38.45
836.50				22.27	22.25	< 38.45
848.30				22.25	22.23	< 38.45
825.50	3	1	0	22.91	22.89	< 38.45
836.50				23.08	23.06	< 38.45
846.50				23.21	23.19	< 38.45
825.50	3	1	7	23.21	23.19	< 38.45
836.50				23.23	23.21	< 38.45
846.50				23.18	23.16	< 38.45
825.50	3	1	14	23.11	23.09	< 38.45
836.50				23.26	23.24	< 38.45
846.50				23.20	23.18	< 38.45
825.50	3	15	0	22.16	22.14	< 38.45
836.50				22.37	22.35	< 38.45
846.50				22.25	22.23	< 38.45

Note: The ERP (dBm) = Output Power (dBm) + Antenna Gain (dBi) - 2.15

Frequency (MHz)	Channel Bandwidth (MHz)	RB Size	RB Offset	Output Power (dBm)	ERP (dBm)	Limit (dBm)
QPSK						
826.50	5	1	0	23.12	23.10	< 38.45
836.50				23.10	23.08	< 38.45
846.50				23.10	23.08	< 38.45
826.50	5	1	12	23.48	23.46	< 38.45
836.50				23.44	23.42	< 38.45
846.50				23.48	23.46	< 38.45
826.50	5	1	24	23.30	23.28	< 38.45
836.50				23.11	23.09	< 38.45
846.50				23.06	23.04	< 38.45
826.50	5	25	0	22.42	22.40	< 38.45
836.50				22.28	22.26	< 38.45
846.50				22.30	22.28	< 38.45
829.00	10	1	0	23.16	23.14	< 38.45
836.50				22.97	22.95	< 38.45
844.00				23.07	23.05	< 38.45
829.00	10	1	24	23.52	23.50	< 38.45
836.50				23.59	23.57	< 38.45
844.00				23.55	23.53	< 38.45
829.00	10	1	49	22.87	22.85	< 38.45
836.50				23.04	23.02	< 38.45
844.00				22.93	22.91	< 38.45
829.00	10	50	0	22.33	22.31	< 38.45
836.50				22.37	22.35	< 38.45
844.00				22.33	22.31	< 38.45

Note: The ERP (dBm) = Output Power (dBm) + Antenna Gain (dBi) - 2.15

Frequency (MHz)	Channel Bandwidth (MHz)	RB Size	RB Offset	Output Power (dBm)	ERP (dBm)	Limit (dBm)
QPSK						
821.50	15	1	0	22.98	22.96	< 38.45
836.50				23.10	23.08	< 38.45
841.50				22.87	22.85	< 38.45
821.50	15	1	37	23.31	23.29	< 38.45
836.50				23.00	22.98	< 38.45
841.50				23.37	23.35	< 38.45
821.50	15	1	74	22.99	22.97	< 38.45
836.50				22.88	22.86	< 38.45
841.50				22.89	22.87	< 38.45
821.50	15	75	0	22.30	22.28	< 38.45
836.50				22.19	22.17	< 38.45
841.50				22.17	22.15	< 38.45
Note: The ERP (dBm) = Output Power (dBm) + Antenna Gain (dBi) - 2.15						

Frequency (MHz)	Channel Bandwidth (MHz)	RB Size	RB Offset	Output Power (dBm)	ERP (dBm)	Limit (dBm)
16QAM						
824.70	1.4	1	0	21.90	21.88	< 38.45
836.50				21.92	21.90	< 38.45
848.30				21.84	21.82	< 38.45
824.70	1.4	1	2	21.81	21.79	< 38.45
836.50				21.95	21.93	< 38.45
848.30				21.86	21.84	< 38.45
824.70	1.4	1	6	21.81	21.79	< 38.45
836.50				22.06	22.04	< 38.45
848.30				21.95	21.93	< 38.45
824.70	1.4	6	0	21.15	21.13	< 38.45
836.50				21.52	21.50	< 38.45
848.30				21.13	21.11	< 38.45
825.50	3	1	0	21.96	21.94	< 38.45
836.50				21.93	21.91	< 38.45
846.50				21.82	21.80	< 38.45
825.50	3	1	7	22.22	22.20	< 38.45
836.50				22.41	22.39	< 38.45
846.50				22.20	22.18	< 38.45
825.50	3	1	14	21.89	21.87	< 38.45
836.50				22.06	22.04	< 38.45
846.50				21.96	21.94	< 38.45
825.50	3	15	0	21.36	21.34	< 38.45
836.50				21.27	21.25	< 38.45
846.50				21.26	21.24	< 38.45
Note: The ERP (dBm) = Output Power (dBm) + Antenna Gain (dBi) - 2.15						

Frequency (MHz)	Channel Bandwidth (MHz)	RB Size	RB Offset	Output Power (dBm)	ERP (dBm)	Limit (dBm)
16QAM						
826.50	5	1	0	21.55	21.53	< 38.45
836.50				21.95	21.93	< 38.45
846.50				22.01	21.99	< 38.45
826.50	5	1	12	22.22	22.20	< 38.45
836.50				21.99	21.97	< 38.45
846.50				22.40	22.38	< 38.45
826.50	5	1	24	21.54	21.52	< 38.45
836.50				21.70	21.68	< 38.45
846.50				21.65	21.63	< 38.45
826.50	5	25	0	21.35	21.33	< 38.45
836.50				21.32	21.30	< 38.45
846.50				21.24	21.22	< 38.45
829.00	10	1	0	21.99	21.97	< 38.45
836.50				22.01	21.99	< 38.45
844.00				22.03	22.01	< 38.45
829.00	10	1	24	22.16	22.14	< 38.45
836.50				21.94	21.92	< 38.45
844.00				22.25	22.23	< 38.45
829.00	10	1	49	21.58	21.56	< 38.45
836.50				21.84	21.82	< 38.45
844.00				21.97	21.95	< 38.45
829.00	10	50	0	21.56	21.54	< 38.45
836.50				21.37	21.35	< 38.45
844.00				21.35	21.33	< 38.45
Note: The ERP (dBm) = Output Power (dBm) + Antenna Gain (dBi) - 2.15						

Frequency (MHz)	Channel Bandwidth (MHz)	RB Size	RB Offset	Output Power (dBm)	ERP (dBm)	Limit (dBm)
16QAM						
821.50	15	1	0	21.91	21.89	< 38.45
836.50				21.72	21.70	< 38.45
841.50				21.83	21.81	< 38.45
821.50	15	1	37	22.52	22.50	< 38.45
836.50				22.02	22.00	< 38.45
841.50				22.35	22.33	< 38.45
821.50	15	1	74	21.71	21.69	< 38.45
836.50				21.80	21.78	< 38.45
841.50				21.55	21.53	< 38.45
821.50	15	75	0	21.16	21.14	< 38.45
836.50				21.22	21.20	< 38.45
841.50				21.32	21.30	< 38.45
Note: The ERP (dBm) = Output Power (dBm) + Antenna Gain (dBi) - 2.15						

Test Site	WZ-SR6	Test Engineer	Cloud Guo
Test Date	2022/12/08	Test Band	LTE Band 7

Frequency (MHz)	Channel Bandwidth (MHz)	RB Size	RB Offset	Output Power (dBm)	EIRP (dBm)	Limit (dBm)
QPSK						
2502.50	5	1	0	22.58	24.91	< 33.01
2535.00				22.92	25.25	< 33.01
2567.50				22.88	25.21	< 33.01
2502.50	5	1	12	22.77	25.10	< 33.01
2535.00				23.03	25.36	< 33.01
2567.50				23.09	25.42	< 33.01
2502.50	5	1	24	22.66	24.99	< 33.01
2535.00				22.88	25.21	< 33.01
2567.50				23.07	25.40	< 33.01
2502.50	5	25	0	21.78	24.11	< 33.01
2535.00				22.01	24.34	< 33.01
2567.50				22.14	24.47	< 33.01
2505.00	10	1	0	22.69	25.02	< 33.01
2535.00				22.90	25.23	< 33.01
2565.00				22.70	25.03	< 33.01
2505.00	10	1	24	22.82	25.15	< 33.01
2535.00				23.00	25.33	< 33.01
2565.00				23.13	25.46	< 33.01
2505.00	10	1	49	22.52	24.85	< 33.01
2535.00				23.01	25.34	< 33.01
2565.00				22.97	25.30	< 33.01
2505.00	10	50	0	21.89	24.22	< 33.01
2535.00				22.12	24.45	< 33.01
2565.00				22.17	24.50	< 33.01

Note: The EIRP (dBm) = Output Power (dBm) + Antenna Gain (dBi)

Frequency (MHz)	Channel Bandwidth (MHz)	RB Size	RB Offset	Output Power (dBm)	EIRP (dBm)	Limit (dBm)
QPSK						
2507.50	15	1	0	22.84	25.17	< 33.01
2535.00				22.97	25.30	< 33.01
2562.50				23.02	25.35	< 33.01
2507.50	15	1	37	22.90	25.23	< 33.01
2535.00				23.15	25.48	< 33.01
2562.50				22.94	25.27	< 33.01
2507.50	15	1	74	22.74	25.07	< 33.01
2535.00				22.83	25.16	< 33.01
2562.50				23.32	25.65	< 33.01
2507.50	15	75	0	21.87	24.20	< 33.01
2535.00				22.04	24.37	< 33.01
2562.50				21.98	24.31	< 33.01
2510.00	20	1	0	22.79	25.12	< 33.01
2535.00				23.04	25.37	< 33.01
2560.00				23.32	25.65	< 33.01
2510.00	20	1	49	22.84	25.17	< 33.01
2535.00				23.23	25.56	< 33.01
2560.00				23.10	25.43	< 33.01
2510.00	20	1	99	22.80	25.13	< 33.01
2535.00				22.82	25.15	< 33.01
2560.00				23.11	25.44	< 33.01
2510.00	20	100	0	21.94	24.27	< 33.01
2535.00				21.92	24.25	< 33.01
2560.00				21.97	24.30	< 33.01
Note: The EIRP (dBm) = Output Power (dBm) + Antenna Gain (dBi)						

Frequency (MHz)	Channel Bandwidth (MHz)	RB Size	RB Offset	Output Power (dBm)	EIRP (dBm)	Limit (dBm)
16QAM						
2502.50	5	1	0	21.57	23.90	< 33.01
2535.00				21.69	24.02	< 33.01
2567.50				21.49	23.82	< 33.01
2502.50	5	1	12	21.60	23.93	< 33.01
2535.00				21.51	23.84	< 33.01
2567.50				21.96	24.29	< 33.01
2502.50	5	1	24	21.22	23.55	< 33.01
2535.00				21.37	23.70	< 33.01
2567.50				22.03	24.36	< 33.01
2502.50	5	25	0	20.72	23.05	< 33.01
2535.00				20.97	23.30	< 33.01
2567.50				21.13	23.46	< 33.01
2505.00	10	1	0	21.52	23.85	< 33.01
2535.00				21.72	24.05	< 33.01
2565.00				21.97	24.30	< 33.01
2505.00	10	1	24	21.40	23.73	< 33.01
2535.00				21.98	24.31	< 33.01
2565.00				21.77	24.10	< 33.01
2505.00	10	1	49	21.21	23.54	< 33.01
2535.00				21.49	23.82	< 33.01
2565.00				21.62	23.95	< 33.01
2505.00	10	50	0	20.89	23.22	< 33.01
2535.00				21.14	23.47	< 33.01
2565.00				21.24	23.57	< 33.01
Note: The EIRP (dBm) = Output Power (dBm) + Antenna Gain (dBi)						

Frequency (MHz)	Channel Bandwidth (MHz)	RB Size	RB Offset	Output Power (dBm)	EIRP (dBm)	Limit (dBm)
16QAM						
2507.50	15	1	0	21.58	23.91	< 33.01
2535.00				21.79	24.12	< 33.01
2562.50				21.77	24.10	< 33.01
2507.50	15	1	37	21.82	24.15	< 33.01
2535.00				22.07	24.40	< 33.01
2562.50				22.03	24.36	< 33.01
2507.50	15	1	74	21.53	23.86	< 33.01
2535.00				21.61	23.94	< 33.01
2562.50				21.77	24.10	< 33.01
2507.50	15	75	0	20.80	23.13	< 33.01
2535.00				20.97	23.30	< 33.01
2562.50				21.02	23.35	< 33.01
2510.00	20	1	0	21.98	24.31	< 33.01
2535.00				21.88	24.21	< 33.01
2560.00				21.52	23.85	< 33.01
2510.00	20	1	49	21.81	24.14	< 33.01
2535.00				21.35	23.68	< 33.01
2560.00				21.49	23.82	< 33.01
2510.00	20	1	99	21.18	23.51	< 33.01
2535.00				21.13	23.46	< 33.01
2560.00				21.46	23.79	< 33.01
2510.00	20	100	0	20.88	23.21	< 33.01
2535.00				20.94	23.27	< 33.01
2560.00				20.96	23.29	< 33.01
Note: The EIRP (dBm) = Output Power (dBm) + Antenna Gain (dBi)						

Test Site	WZ-SR6	Test Engineer	Cloud Guo
Test Date	2022/12/08	Test Band	LTE Band 12

Frequency (MHz)	Channel Bandwidth (MHz)	RB Size	RB Offset	Output Power (dBm)	ERP (dBm)	Limit (dBm)
QPSK						
699.7	1.4	1	0	22.79	23.90	< 44.77
707.5				23.12	24.23	< 44.77
715.3				23.04	24.15	< 44.77
699.7	1.4	1	2	22.75	23.86	< 44.77
707.5				23.32	24.43	< 44.77
715.3				22.86	23.97	< 44.77
699.7	1.4	1	6	22.61	23.72	< 44.77
707.5				23.15	24.26	< 44.77
715.3				22.73	23.84	< 44.77
699.7	1.4	6	0	21.90	23.01	< 44.77
707.5				22.13	23.24	< 44.77
715.3				22.10	23.21	< 44.77
700.5	3	1	0	22.84	23.95	< 44.77
707.5				23.07	24.18	< 44.77
714.5				23.19	24.30	< 44.77
700.5	3	1	7	23.08	24.19	< 44.77
707.5				23.49	24.60	< 44.77
714.5				23.03	24.14	< 44.77
700.5	3	1	14	23.10	24.21	< 44.77
707.5				23.22	24.33	< 44.77
714.5				22.75	23.86	< 44.77
700.5	3	15	0	22.18	23.29	< 44.77
707.5				22.22	23.33	< 44.77
714.5				22.07	23.18	< 44.77

Note: The ERP (dBm) = Output Power (dBm) + Antenna Gain (dBi) - 2.15

Frequency (MHz)	Channel Bandwidth (MHz)	RB Size	RB Offset	Output Power (dBm)	ERP (dBm)	Limit (dBm)
QPSK						
701.5	5	1	0	22.95	24.06	< 44.77
707.5				22.89	24.00	< 44.77
713.5				23.15	24.26	< 44.77
701.5	5	1	12	23.07	24.18	< 44.77
707.5				23.36	24.47	< 44.77
713.5				23.26	24.37	< 44.77
701.5	5	1	24	22.89	24.00	< 44.77
707.5				22.93	24.04	< 44.77
713.5				22.95	24.06	< 44.77
701.5	5	25	0	22.08	23.19	< 44.77
707.5				22.28	23.39	< 44.77
713.5				22.10	23.21	< 44.77
704.0	10	1	0	22.75	23.86	< 44.77
707.5				22.72	23.83	< 44.77
711.0				22.93	24.04	< 44.77
704.0	10	1	24	23.20	24.31	< 44.77
707.5				23.40	24.51	< 44.77
711.0				23.43	24.54	< 44.77
704.0	10	1	49	22.83	23.94	< 44.77
707.5				22.93	24.04	< 44.77
711.0				22.70	23.81	< 44.77
704.0	10	50	0	22.18	23.29	< 44.77
707.5				22.18	23.29	< 44.77
711.0				22.23	23.34	< 44.77
Note: The ERP (dBm) = Output Power (dBm) + Antenna Gain (dBi) - 2.15						

Frequency (MHz)	Channel Bandwidth (MHz)	RB Size	RB Offset	Output Power (dBm)	ERP (dBm)	Limit (dBm)
16QAM						
699.7	1.4	1	0	21.79	22.90	< 44.77
707.5				21.56	22.67	< 44.77
715.3				21.71	22.82	< 44.77
699.7	1.4	1	2	21.83	22.94	< 44.77
707.5				21.52	22.63	< 44.77
715.3				21.35	22.46	< 44.77
699.7	1.4	1	6	21.57	22.68	< 44.77
707.5				21.44	22.55	< 44.77
715.3				21.59	22.70	< 44.77
699.7	1.4	6	0	20.95	22.06	< 44.77
707.5				21.35	22.46	< 44.77
715.3				21.09	22.20	< 44.77
700.5	3	1	0	21.91	23.02	< 44.77
707.5				21.79	22.90	< 44.77
714.5				21.83	22.94	< 44.77
700.5	3	1	7	21.84	22.95	< 44.77
707.5				22.05	23.16	< 44.77
714.5				22.17	23.28	< 44.77
700.5	3	1	14	21.62	22.73	< 44.77
707.5				21.55	22.66	< 44.77
714.5				21.82	22.93	< 44.77
700.5	3	15	0	21.07	22.18	< 44.77
707.5				21.17	22.28	< 44.77
714.5				21.15	22.26	< 44.77
Note: The ERP (dBm) = Output Power (dBm) + Antenna Gain (dBi) - 2.15						

Frequency (MHz)	Channel Bandwidth (MHz)	RB Size	RB Offset	Output Power (dBm)	ERP (dBm)	Limit (dBm)
16QAM						
701.5	5	1	0	21.35	22.46	< 44.77
707.5				21.93	23.04	< 44.77
713.5				21.44	22.55	< 44.77
701.5	5	1	12	21.58	22.69	< 44.77
707.5				22.11	23.22	< 44.77
713.5				22.07	23.18	< 44.77
701.5	5	1	24	21.24	22.35	< 44.77
707.5				21.85	22.96	< 44.77
713.5				21.24	22.35	< 44.77
701.5	5	25	0	20.95	22.06	< 44.77
707.5				21.17	22.28	< 44.77
713.5				21.11	22.22	< 44.77
704.0	10	1	0	21.73	22.84	< 44.77
707.5				21.40	22.51	< 44.77
711.0				21.72	22.83	< 44.77
704.0	10	1	24	21.45	22.56	< 44.77
707.5				21.61	22.72	< 44.77
711.0				22.07	23.18	< 44.77
704.0	10	1	49	21.73	22.84	< 44.77
707.5				22.04	23.15	< 44.77
711.0				21.20	22.31	< 44.77
704.0	10	50	0	21.35	22.46	< 44.77
707.5				21.15	22.26	< 44.77
711.0				21.21	22.32	< 44.77
Note: The ERP (dBm) = Output Power (dBm) + Antenna Gain (dBi) - 2.15						

Test Site	WZ-SR6	Test Engineer	Cloud Guo
Test Date	2022/12/08	Test Band	LTE Band 13

Frequency (MHz)	Channel Bandwidth (MHz)	RB Size	RB Offset	Output Power (dBm)	ERP (dBm)	Limit (dBm)
QPSK						
779.5	5	1	0	22.82	24.65	< 44.77
782.0				22.89	24.72	< 44.77
784.5				22.83	24.66	< 44.77
779.5	5	1	12	22.82	24.65	< 44.77
782.0				22.89	24.72	< 44.77
784.5				22.98	24.81	< 44.77
779.5	5	1	24	22.90	24.73	< 44.77
782.0				22.78	24.61	< 44.77
784.5				22.92	24.75	< 44.77
779.5	5	25	0	22.05	23.88	< 44.77
782.0				22.06	23.89	< 44.77
784.5				22.02	23.85	< 44.77
782.0	10	1	0	22.75	24.58	< 44.77
782.0		1	24	23.06	24.89	< 44.77
782.0		1	49	22.90	24.73	< 44.77
782.0		50	0	22.00	23.83	< 44.77

Note: The ERP (dBm) = Output Power (dBm) + Antenna Gain (dBi) - 2.15

Frequency (MHz)	Channel Bandwidth (MHz)	RB Size	RB Offset	Output Power (dBm)	ERP (dBm)	Limit (dBm)
16QAM						
779.5	5	1	0	21.73	23.56	< 44.77
782.0				21.81	23.64	< 44.77
784.5				21.73	23.56	< 44.77
779.5	5	1	12	21.32	23.15	< 44.77
782.0				21.38	23.21	< 44.77
784.5				21.88	23.71	< 44.77
779.5	5	1	24	21.50	23.33	< 44.77
782.0				21.70	23.53	< 44.77
784.5				21.93	23.76	< 44.77
779.5	5	25	0	21.00	22.83	< 44.77
782.0				20.86	22.69	< 44.77
784.5				20.83	22.66	< 44.77
782.0	10	1	0	21.63	23.46	< 44.77
782.0		1	24	21.84	23.67	< 44.77
782.0		1	49	21.58	23.41	< 44.77
782.0		50	0	21.00	22.83	< 44.77
Note: The ERP (dBm) = Output Power (dBm) + Antenna Gain (dBi) - 2.15						

Test Site	WZ-SR6	Test Engineer	Cloud Guo
Test Date	2022/12/08	Test Band	LTE Band 38/41

Frequency (MHz)	Channel Bandwidth (MHz)	RB Size	RB Offset	Output Power (dBm)	EIRP (dBm)	Limit (dBm)
QPSK						
2498.50	5	1	0	22.57	24.61	< 33.01
2593.00				22.64	24.68	< 33.01
2687.50				22.85	24.89	< 33.01
2498.50	5	1	12	22.71	24.75	< 33.01
2593.00				22.90	24.94	< 33.01
2687.50				23.02	25.06	< 33.01
2498.50	5	1	24	22.68	24.72	< 33.01
2593.00				22.62	24.66	< 33.01
2687.50				22.69	24.73	< 33.01
2498.50	5	25	0	21.81	23.85	< 33.01
2593.00				21.58	23.62	< 33.01
2687.50				21.77	23.81	< 33.01
2501.00	10	1	0	22.57	24.61	< 33.01
2593.00				22.48	24.52	< 33.01
2685.00				22.96	25.00	< 33.01
2501.00	10	1	24	22.57	24.61	< 33.01
2593.00				22.50	24.54	< 33.01
2685.00				22.69	24.73	< 33.01
2501.00	10	1	49	22.66	24.70	< 33.01
2593.00				22.51	24.55	< 33.01
2685.00				22.60	24.64	< 33.01
2501.00	10	50	0	21.81	23.85	< 33.01
2593.00				21.68	23.72	< 33.01
2685.00				21.74	23.78	< 33.01

Note: The EIRP (dBm) = Output Power (dBm) + Antenna Gain (dBi)

Frequency (MHz)	Channel Bandwidth (MHz)	RB Size	RB Offset	Output Power (dBm)	EIRP (dBm)	Limit (dBm)
QPSK						
2503.50	15	1	0	22.66	24.70	< 33.01
2593.00				22.88	24.92	< 33.01
2682.50				22.99	25.03	< 33.01
2503.50	15	1	37	23.01	25.05	< 33.01
2593.00				22.77	24.81	< 33.01
2682.50				23.01	25.05	< 33.01
2503.50	15	1	74	22.81	24.85	< 33.01
2593.00				22.76	24.80	< 33.01
2682.50				23.24	25.28	< 33.01
2503.50	15	75	0	21.72	23.76	< 33.01
2593.00				21.62	23.66	< 33.01
2682.50				21.69	23.73	< 33.01
2506.00	20	1	0	22.35	24.39	< 33.01
2593.00				22.66	24.70	< 33.01
2680.00				22.52	24.56	< 33.01
2506.00	20	1	49	22.83	24.87	< 33.01
2593.00				22.64	24.68	< 33.01
2680.00				22.94	24.98	< 33.01
2506.00	20	1	99	22.46	24.50	< 33.01
2593.00				22.43	24.47	< 33.01
2680.00				22.67	24.71	< 33.01
2506.00	20	100	0	21.58	23.62	< 33.01
2593.00				21.64	23.68	< 33.01
2680.00				21.73	23.77	< 33.01
Note: The EIRP (dBm) = Output Power (dBm) + Antenna Gain (dBi)						

Frequency (MHz)	Channel Bandwidth (MHz)	RB Size	RB Offset	Output Power (dBm)	EIRP (dBm)	Limit (dBm)
16QAM						
2498.50	5	1	0	21.73	23.77	< 33.01
2593.00				21.45	23.49	< 33.01
2687.50				21.60	23.64	< 33.01
2498.50	5	1	12	21.85	23.89	< 33.01
2593.00				21.73	23.77	< 33.01
2687.50				21.94	23.98	< 33.01
2498.50	5	1	24	21.64	23.68	< 33.01
2593.00				21.26	23.30	< 33.01
2687.50				21.64	23.68	< 33.01
2498.50	5	25	0	20.77	22.81	< 33.01
2593.00				20.65	22.69	< 33.01
2687.50				20.85	22.89	< 33.01
2501.00	10	1	0	20.91	22.95	< 33.01
2593.00				20.81	22.85	< 33.01
2685.00				20.92	22.96	< 33.01
2501.00	10	1	24	21.02	23.06	< 33.01
2593.00				20.69	22.73	< 33.01
2685.00				20.75	22.79	< 33.01
2501.00	10	1	49	21.00	23.04	< 33.01
2593.00				20.48	22.52	< 33.01
2685.00				20.77	22.81	< 33.01
2501.00	10	50	0	20.77	22.81	< 33.01
2593.00				20.75	22.79	< 33.01
2685.00				20.89	22.93	< 33.01
Note: The EIRP (dBm) = Output Power (dBm) + Antenna Gain (dBi)						

Frequency (MHz)	Channel Bandwidth (MHz)	RB Size	RB Offset	Output Power (dBm)	EIRP (dBm)	Limit (dBm)
16QAM						
2503.50	15	1	0	21.28	23.32	< 33.01
2593.00				21.35	23.39	< 33.01
2682.50				21.38	23.42	< 33.01
2503.50	15	1	37	21.48	23.52	< 33.01
2593.00				21.31	23.35	< 33.01
2682.50				21.35	23.39	< 33.01
2503.50	15	1	74	21.04	23.08	< 33.01
2593.00				21.17	23.21	< 33.01
2682.50				21.30	23.34	< 33.01
2503.50	15	75	0	20.62	22.66	< 33.01
2593.00				20.63	22.67	< 33.01
2682.50				20.73	22.77	< 33.01
2506.00	20	1	0	21.49	23.53	< 33.01
2593.00				21.66	23.70	< 33.01
2680.00				21.40	23.44	< 33.01
2506.00	20	1	49	21.57	23.61	< 33.01
2593.00				21.37	23.41	< 33.01
2680.00				21.47	23.51	< 33.01
2506.00	20	1	99	21.32	23.36	< 33.01
2593.00				21.32	23.36	< 33.01
2680.00				21.27	23.31	< 33.01
2506.00	20	100	0	20.59	22.63	< 33.01
2593.00				20.67	22.71	< 33.01
2680.00				20.68	22.72	< 33.01
Note: The EIRP (dBm) = Output Power (dBm) + Antenna Gain (dBi)						

A.4 Band Edge Test Result

Test Site	WZ-SR6	Test Engineer	Cloud Guo
Test Date	2022/11/25	Test Band	LTE Band 2/25

1.4MHz Channel Bandwidth - 1RB

Lower Band Edge

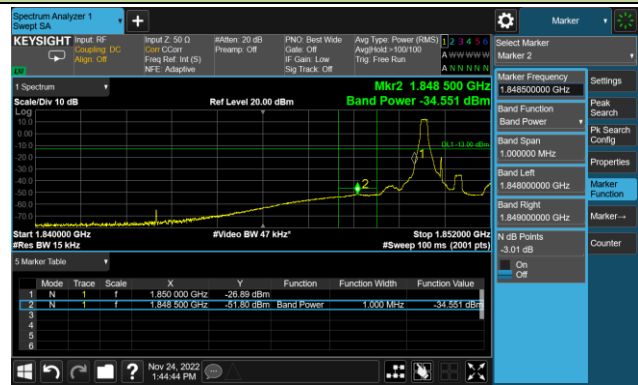

Upper Band Edge



3MHz Channel Bandwidth - 1RB

Lower Band Edge

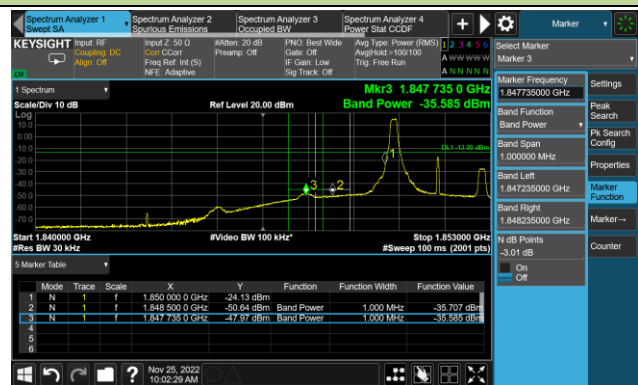

Upper Band Edge

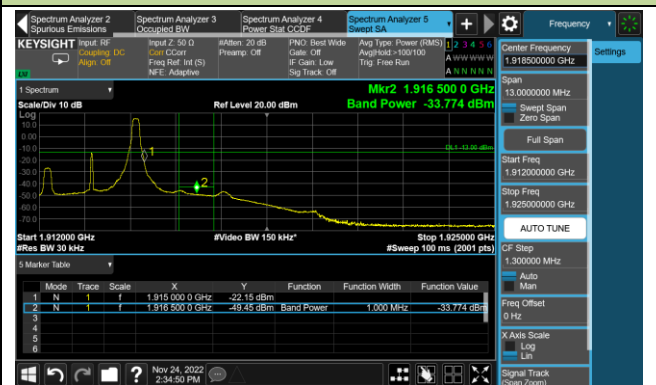

5MHz Channel Bandwidth - 1RB

Lower Band Edge

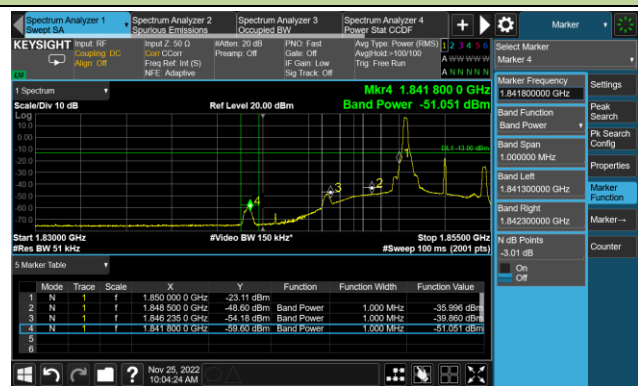

Upper Band Edge

