

Product Name: Wi-Fi&Bluetooth Module	Report No: FCC022022-5799RF0
Product Model: FC905A	Security Classification: Open
Version: V1.0	Total Page:21

TIRT Testing Report



Prepared By:	Checked By:	Approved By:	
Stone Tang	Randy Lv	Daniel Chen	
<i>Stone Tang</i>	<i>Randy Lv</i>	<i>Daniel chen</i>	

FCC DFS Test Report

FCC ID: XMR202208FC905A

This report concerns: Original Grant

Project No. : 022022-5799
Equipment : Wi-Fi&Bluetooth Module
Brand Name : Quectel
Test Model : FC905A
Series Model : NA
Applicant : Quectel Wireless Solutions Co., Ltd
Address : Building 5, Shanghai Business Park Phase III (Area B), No.1016 Tianlin Road, Minhang District, Shanghai, China 200233
Manufacturer : Quectel Wireless Solutions Co., Ltd
Address : Building 5, Shanghai Business Park Phase III (Area B), No.1016 Tianlin Road, Minhang District, Shanghai, China 200233
Date of Test : Sep. 14, 2022~Nov. 01, 2022
Issued Date : Nov. 12, 2022
Report Version : V1.0.0
Test Sample : Engineering Sample No.: 20221108019601
Standard(s) : FCC CFR Title 47, Part 15, Subpart E
FCC KDB 789033 D02 General U-NII Test Procedures New Rules v02r01
FCC KDB 905462 D02 UNII DFS Compliance Procedures New Rules v02
FCC KDB 905462 D03 UNII Clients Without Radar Detection New Rules v01r02

- The test result referred exclusively to the presented test model /sample.
- Without written approval of TIRT Inc. the test report shall not reproduced except in full.

Lab: Beijing TIRT Technology Service Co.,Ltd Shenzhen
Add: 101, 3 # Factory Building, Gongjin Electronics, Shatin Community, Kengzi Street, Pingshan District, Shenzhen City, China

TEL: +86-0755-27087573

Table of Contents	Page
REPORT ISSUED HISTORY	4
1 . TEST LOCATION	5
2 . TEST ENVIRONMENT CONDITIONS	5
3 . SUMMARY OF TEST RESULTS	5
4 . GENERAL INFORMATION	6
4.1 GENERAL DESCRIPTION OF EUT	6
4.2 MAXIMUM OUTPUT POWER AND E.I.R.P.	9
4.3 DESCRIPTION OF TEST MODES	9
5 . U-NII DFS RULE REQUIREMENTS	10
5.1 WORKING MODES AND REQUIRED TEST ITEMS	10
5.2 TEST LIMITS AND RADAR SIGNAL PARAMETERS	11
6 . MEASUREMENT INSTRUMENTS LIST	12
7 . DYNAMIC FREQUENCY SELECTION (DFS)	13
7.1 DFS MEASUREMENT SYSTEM	13
7.2 CALIBRATION OF DFS DETECTION THRESHOLD LEVEL	16
7.3 DEVIATION FROM TEST STANDARD	16
8 . TEST RESULTS	17
8.1 SUMMARY OF DFS TEST RESULT	17
8.2 DFS DETECTION THRESHOLD	18
8.3 CHANNEL MOVE TIME AND CHANNEL CLOSING TRANSMISSION TIME	19
8.4 NON-OCCUPANCY PERIOD	20
9 . EUT TEST PHOTO	21

REPORT ISSUED HISTORY

Report No.	Version	Description	Issued Date	Note
FCC022022-5799RF0	V1.0	Original Report.	Nov. 12, 2022	Valid

1. TEST LOCATION

Company:	Beijing TIRT Technology Service Co.,Ltd Shenzhen
Address:	101, 3 # Factory Building, Gongjin Electronics Shatin Community, Kengzi Street, Pingshan District, Shenzhen, China
CNAS Registration Number:	CNAS L14158
A2LA Registration Number:	6049.01
FCC Accredited Lab. Designation Number:	CN1309
FCC Test Firm Registration Number:	825524
Telephone:	+86-0755-27087573

2. TEST ENVIRONMENT CONDITIONS

Test Item	Temperature	Humidity	Test Voltage	Tested By
Dynamic Frequency Selection (DFS)	25°C	56%	3.6V DC	Stone Tang

3. SUMMARY OF TEST RESULTS

Test procedures according to the technical standard(s):

FCC CFR Title 47, Part 15, Subpart E				
Standard(s) Section	Test Item	Test Result	Judgment	Remark
FCC 15.407(h)	Transmit Power Control (TPC) and Dynamic Frequency Selection (DFS)	-----	PASS	-----

4. GENERAL INFORMATION

4.1 GENERAL DESCRIPTION OF EUT

Equipment	Wi-Fi&Bluetooth Module
Brand Name	Quectel
Test Model	FC905A
Series Model	NA
Model Difference(s)	NA
Software Version	NA
Hardware Version	R1.0
Power Source	DC voltage supplied from AC/DC adapter.
Power Rating	DC 3.6V
Operation Frequency Band(s)	UNII-2A: 5250 MHz ~ 5350 MHz UNII-2C: 5470 MHz ~ 5725 MHz
Modulation Type	IEEE 802.11a/n/ac: OFDM
Bit Rate of Transmitter	IEEE 802.11a: 54/48/36/24/18/12/9/6 Mbps IEEE 802.11n: up to 150Mbps IEEE 802.11ac: up to 433.3Mbps
Operating Mode(s)	<input type="checkbox"/> Master <input checked="" type="checkbox"/> Client device without radar detection <input type="checkbox"/> Client device with radar detection
Max. Output Power _UNII-2A	IEEE 802.11n20: 17.66 dBm (0.0583 W)
Max. Output Power _UNII-2C	IEEE 802.11ac80: 18.60 dBm (0.0724 W)

Note:

1. For a more detailed features description, please refer to the manufacturer's specifications or the user's manual.

2. Channel List:

IEEE 802.11a IEEE 802.11n(HT20) IEEE 802.11ac(VHT20)		IEEE 802.11n(HT40) IEEE 802.11ac(VHT40)		IEEE 802.11ac(VHT80)	
UNII-2A		UNII-2A		UNII-2A	
Channel	Frequency (MHz)	Channel	Frequency (MHz)	Channel	Frequency (MHz)
52	5260	54	5270	58	5290
56	5280	62	5310		
60	5300				
64	5320				

IEEE 802.11a IEEE 802.11n(HT20) IEEE 802.11ac(VHT20)		IEEE 802.11n(HT40) IEEE 802.11ac(VHT40)		IEEE 802.11ac(VHT80)	
UNII-2C		UNII-2C		UNII-2C	
Channel	Frequency (MHz)	Channel	Frequency (MHz)	Channel	Frequency (MHz)
100	5500	102	5510	106	5530
104	5520	110	5550	122	5610
108	5540	118	5590		
112	5560	126	5630		
116	5580	134	5670		
120	5600				
124	5620				
128	5640				
132	5660				
136	5680				
140	5700				

4. Antenna Specification:

Ant.	Brand	Model Name	Antenna Type	Connector	Gain (dBi)
1	N/A	N/A	Dipole	N/A	0.66

Note:

- 1) The antenna gain are provided by the manufacturer.
- 2) The antenna is for testing only and will not be sold with equipments.

5. Table for Antenna Configuration:

For SISO:

Operating Mode	TX Mode	1TX
IEEE 802.11a		V (Ant. 1)
IEEE 802.11n(HT20)		V (Ant. 1)
IEEE 802.11n(HT40)		V (Ant. 1)
IEEE 802.11ac(VHT20)		V (Ant. 1)
IEEE 802.11ac(VHT40)		V (Ant. 1)
IEEE 802.11ac(VHT80)		V (Ant. 1)

4.2 MAXIMUM OUTPUT POWER AND E.I.R.P.

SISO				
Frequency Band (MHz)	Max Output Power (dBm)	Antenna Gain (dBi)	Max. e.i.r.p. (dBm)	Max. e.i.r.p. (mW)
5250~5350	17.66	0.66	18.32	67.92
5470~5725	18.60	0.66	19.26	84.33

Note:

- 1) U-NII devices operating in the 5.25-5.35 GHz band and the 5.47-5.725 GHz band shall employ a TPC mechanism. A TPC mechanism is not required for systems with an e.i.r.p. of less than 500 mW.

4.3 DESCRIPTION OF TEST MODES

Test Mode	Description
Mode 1	IEEE 802.11ac(VHT80): 5530MHz

5. U-NII DFS RULE REQUIREMENTS

5.1 WORKING MODES AND REQUIRED TEST ITEMS

The manufacturer shall state whether the UUT is capable of operating as a Master and/or a Client. If the UUT is capable of operating in more than one operating mode then each operating mode shall be tested separately. See tables below for the applicability of DFS requirements for each of the operational modes.

Applicability of DFS requirements prior to use a channel

Requirement	Operational Mode		
	Master	Client without radar detection	Client with radar detection
Non-Occupancy Period	√	√	√
DFS Detection Threshold	√	Not required	√
Channel Availability Check Tim	√	Not required	Not required
U-NII Detection Bandwidth	√	Not required	√

Applicability of DFS requirements during normal operation

Requirement	Operational Mode		
	Master	Client without radar detection	Client with radar detection
DFS Detection Threshold	√	Not required	√
Channel Closing Transmission Time	√	√	√
Channel Move Tim	√	√	√
U-NII Detection Bandwidth	√	Not required	√

Additional requirements for devices with multiple bandwidth modes	Master Device or Client with Radar Detection	Client Without Radar Detection
U-NII Detection Bandwidth and Statistical Performance Check	All BW modes must be tested	Not required
Channel Move Time and Channel Closing Transmission Time	Test using widest BW mode available	Test using the widest BW mode available for the link
All other tests	Any single BW mode	Not required

Note: Frequencies selected for statistical performance check should include several frequencies within the radar detection bandwidth and frequencies near the edge of the radar detection bandwidth. For 802.11 devices it is suggested to select frequencies in each of the bonded 20 MHz channels and the channel center frequency.

5.2 TEST LIMITS AND RADAR SIGNAL PARAMETERS

DETECTION THRESHOLD VALUES

DFS Detection Thresholds for Master Devices and Client Devices with Radar Detection

Maximum Transmit Power	Value (See Notes 1, 2 and 3)
e.i.r.p. \geq 200 milliwatt	-64 dBm
e.i.r.p. < 200 milliwatt and power spectral density < 10 dBm/MHz	-62 dBm
e.i.r.p. < 200 milliwatt that do not meet the power spectral density requirement	-64 dBm

Note 1: This is the level at the input of the receiver assuming a 0 dBi receive antenna.

Note 2: Throughout these test procedures an additional 1 dB has been added to the amplitude of the test transmission waveforms to account for variations in measurement equipment. This will ensure that the test signal is at or above the detection threshold level to trigger a DFS response.

Note 3: e.i.r.p. is based on the highest antenna gain. For MIMO devices refer to KDB Publication 662911 D01.

TEST LIMIT

DFS Response Requirement Values

Parameter	Value
Non-occupancy period	Minimum 30 minutes
Channel Availability Check Time	60 seconds
Channel Move Time	10 seconds. See Note 1.
Channel Closing Transmission Time	200 milliseconds + an aggregate of 60 milliseconds over remaining 10 second period. See Notes 1 and 2.
U-NII Detection Bandwidth	Minimum 100% of the UNII 99% transmission power bandwidth. See Note 3.

Note 1: Channel Move Time and the Channel Closing Transmission Time should be performed with Radar Type 0. The measurement timing begins at the end of the Radar Type 0 burst.

Note 2: The Channel Closing Transmission Time is comprised of 200 milliseconds starting at the beginning of the Channel Move Time plus any additional intermittent control signals required to facilitate a Channel move (an aggregate of 60 milliseconds) during the remainder of the 10 second period. The aggregate duration of control signals will not count quiet periods in between transmissions.

Note 3: During the U-NII Detection Bandwidth detection test, radar type 0 should be used. For each frequency step the minimum percentage of detection is 90 percent. Measurements are performed with no data traffic.

PARAMETERS OF DFS TEST SIGNALS

Step intervals of 0.1 microsecond for Pulse Width, 1 microsecond for PRI, 1 MHz for chirp width and 1 for the number of pulses will be utilized for the random determination of specific test waveforms.

Short Pulse Radar Test Waveforms.

Radar Type	Pulse Width (μ sec)	PRI (μ sec)	Number of Pulses	Minimum Percentage of Successful Detection	Minimum Number of Trials
0	1	1428	18	See Note 1	See Note 1

Note 1: Short Pulse Radar Type 0 should be used for the detection bandwidth test, channel move time, and channel closing time tests.

6. MEASUREMENT INSTRUMENTS LIST

Kind of Equipment	Manufacturer	Type No.	Serial No.	Calibrated until
Spectrum Analyzer	Agilent	N9010A	MY52221119	2022/11/09
Vector Signal Generator	Agilent	N5182B	MY53051091	2022/11/09
Temp&Humidity Recorder	Anymetre	JR900	NA	2022/11/03
Keysight.Signal Studio for DFS Rader Profiles	Keysight	N7607B Signal studio V3.0.0.0	NA	NA
Wi-Fi Router	Tp-Link	Archer AX6000	NA	NA

Remark: "N/A" denotes no model name, serial no. or calibration specified.
All calibration period of equipment list is one year.
Wi-Fi Router's FCC ID: TE7AX6000

7. DYNAMIC FREQUENCY SELECTION (DFS)

7.1 DFS MEASUREMENT SYSTEM

Test Procedure

1. Master device and client device are set up by conduction method as the following configuration.
2. The client device is connected to notebook and to access a IP address on wireless connection with the master device.
3. Then the master device is connected to another notebook to access a IP address.
4. Finally, let the two IP addresses run traffic with each other through the Run flow software “Lan test” to reach 17% channel loading as below.

Setup for Client with injection at the Master

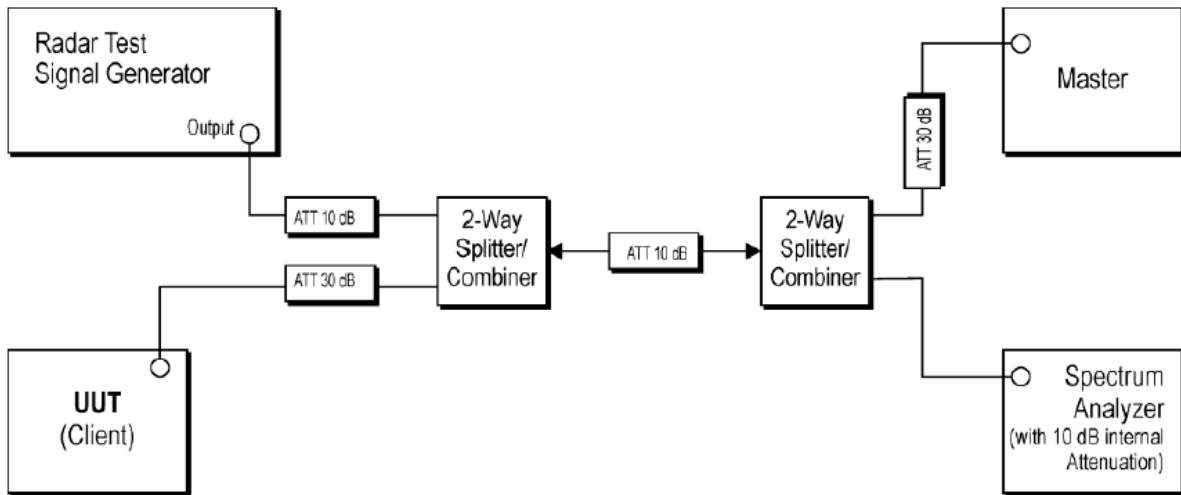

Radars Test Waveforms are injected into the Master.

Channel Loading

IEEE 802.11ac(VHT80) Mode

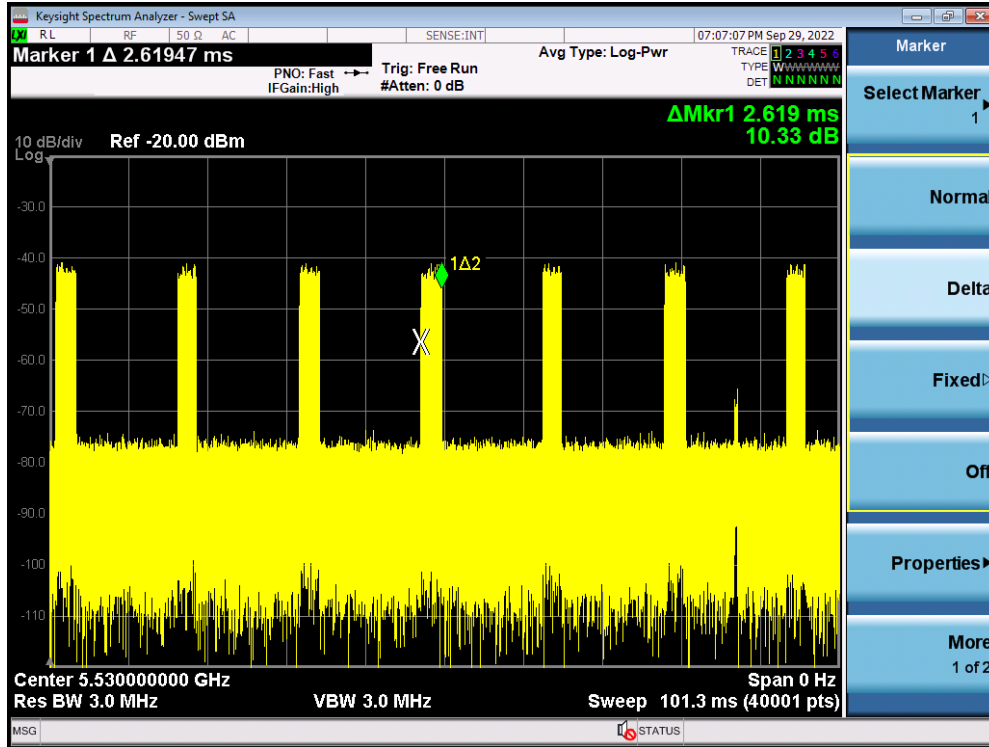

Frequency (MHz)	Marker Delta (ms)	Number	On Time (ms)	Total Time (ms)	Duty cycle (%)	Limit (%)
5530	2.619	7	18.333	101.3	18.10%	17.00

The signal monitoring equipment consists of a spectrum analyzer set to display 8001 bins on the horizontal axis. The time-domain resolution is 2 msec / bin with a 16 second sweep time, meeting the 10 second short pulse reporting criteria. The aggregate ON time is calculated by multiplying the number of bins above a threshold during a particular observation period by the dwell time per bin, with the analyzer set to peak detection and max hold.

Should multiple RF ports be utilized for the Master and/or Slave devices (for example, for diversity or MIMO implementations), additional combiner/dividers are inserted between the Master Combiner/Divider and the pad connected to the Master Device (and/or between the Slave Combiner/Divider and the pad connected to the Slave Device). Additional pads are utilized such that there is one pad at each RF port on each EUT.

7.2 CALIBRATION OF DFS DETECTION THRESHOLD LEVEL

A 50 ohm load is connected in place of the spectrum analyzer, and the spectrum analyzer is connected in place of the master device and the signal generator is set to CW mode. The amplitude of the signal generator is adjusted to yield a level of -62dBm as measured on the spectrum analyzer.

Without changing any of the instrument settings, the spectrum analyzer is reconnected to the Common port of the Spectrum Analyzer Combiner/Divider. Measure the amplitude and calculate the difference from -64 dBm. Adjust the Reference Level Offset of the spectrum analyzer to this difference.

The spectrum analyzer displays the level of the signal generator as received at the antenna ports of the Master Device. The interference detection threshold may be varied from the calibrated value of -64 dBm and the spectrum analyzer will still indicate the level as received by the Master Device.

Set the signal generator to produce a radar waveform, trigger a burst manually and measure the level on the spectrum analyzer. Readjust the amplitude of the signal generator as required so that the peak level of the waveform is at a displayed level equal to the required or desired interference detection threshold. Separate signal generator amplitude settings are determined as required for each radar type.

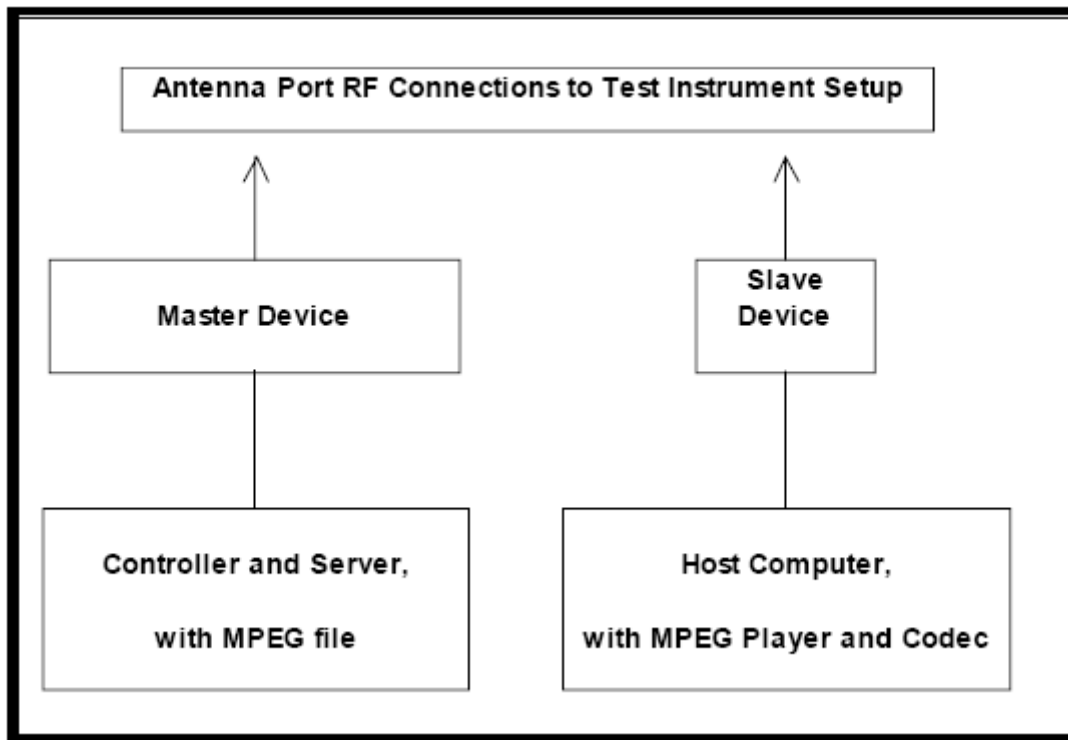

7.3 DEVIATION FROM TEST STANDARD

No deviation.

8. TEST RESULTS

8.1 SUMMARY OF DFS TEST RESULT

Clause	Test Parameter	Remarks	Result
FCC 15.407	Channel Move Time	Applicable	Pass
	Channel Closing Transmission Time	Applicable	Pass
	Non-Occupancy Period	Applicable	Pass

8.2 DFS DETECTION THRESHOLD

Calibration:

The EUT is slave equipment and it with a lowest gain is 2dBi.
 For a detection threshold level of -62dBm and the master antenna gain is 2dBi, required detection threshold is -60 dBm (= -62+2).

Note: Maximum Transmit Power is less than 200 milliwatt in this report, so detection threshold level is -62dBm.

Radar Signal 0

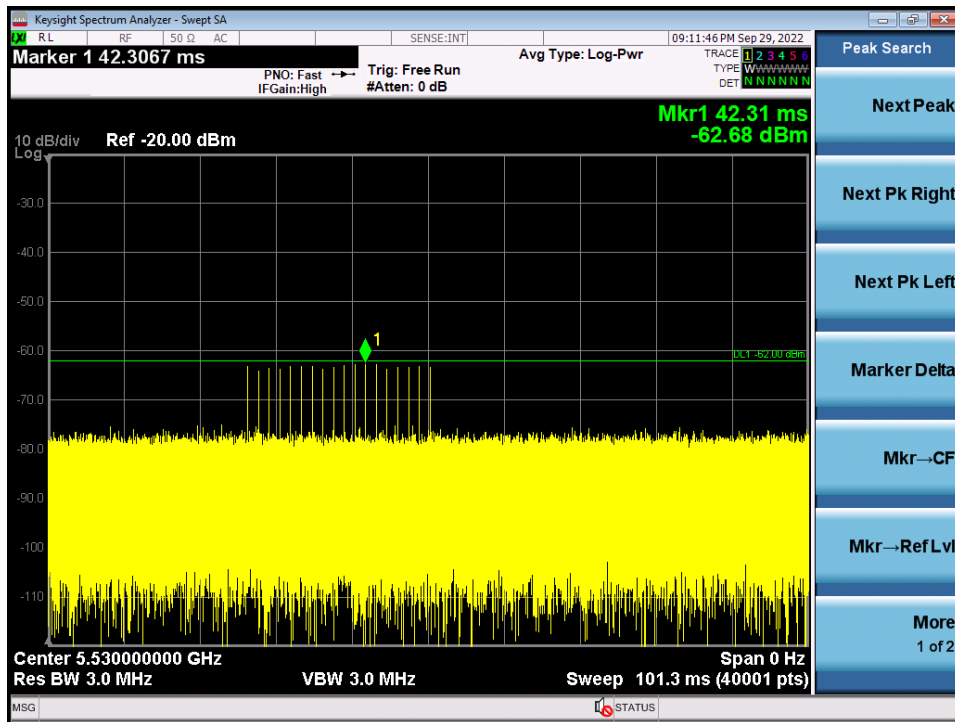

8.3 CHANNEL MOVE TIME AND CHANNEL CLOSING TRANSMISSION TIME

IEEE 802.11ac(VHT80) Mode		
Item	Measured Value(s)	Limit(s)
Channel Move Time	1.0469738	10
Channel Close Time	0.0059999	200 milliseconds + an aggregate of 60 milliseconds over remaining 10 second period.

TX (IEEE 802.11ac(VHT80) Mode)

Radar signal 0

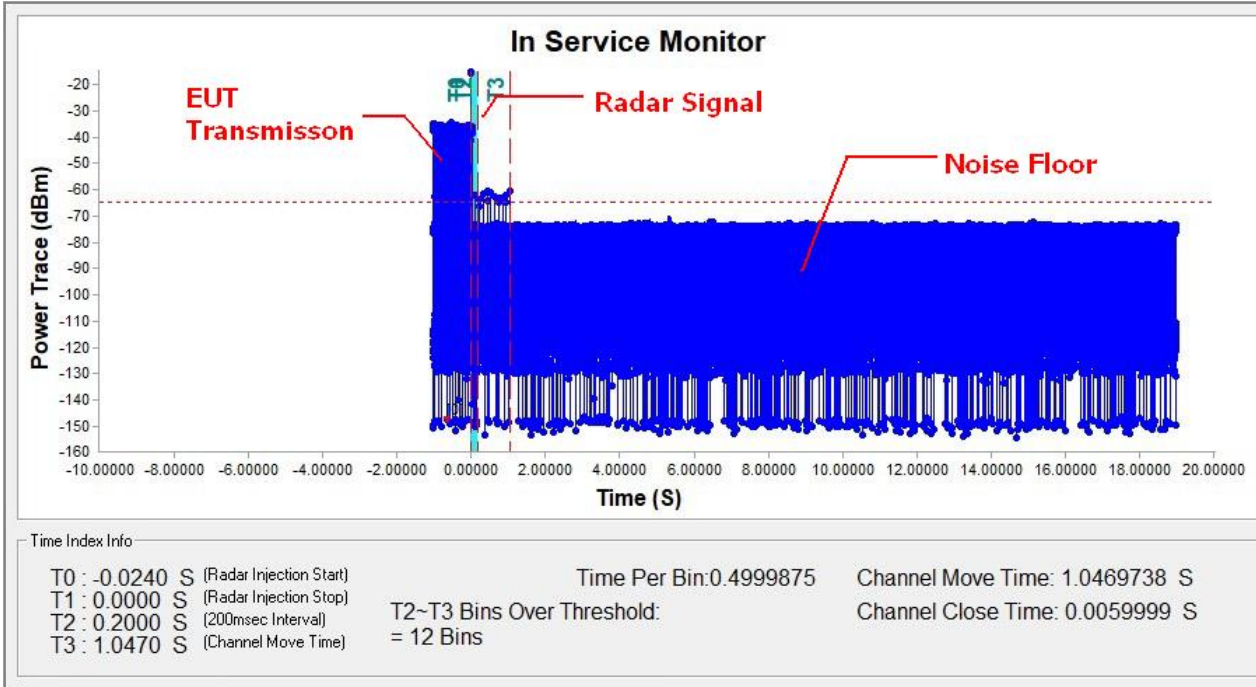

Note: T0 denotes the Radar Injection Start.

T1 denotes the start of Channel Move Time upon the end of the last Radar burst.

T2 denotes the data transmission time of 200ms from T1.

T3 denotes the end of Channel Move Time.

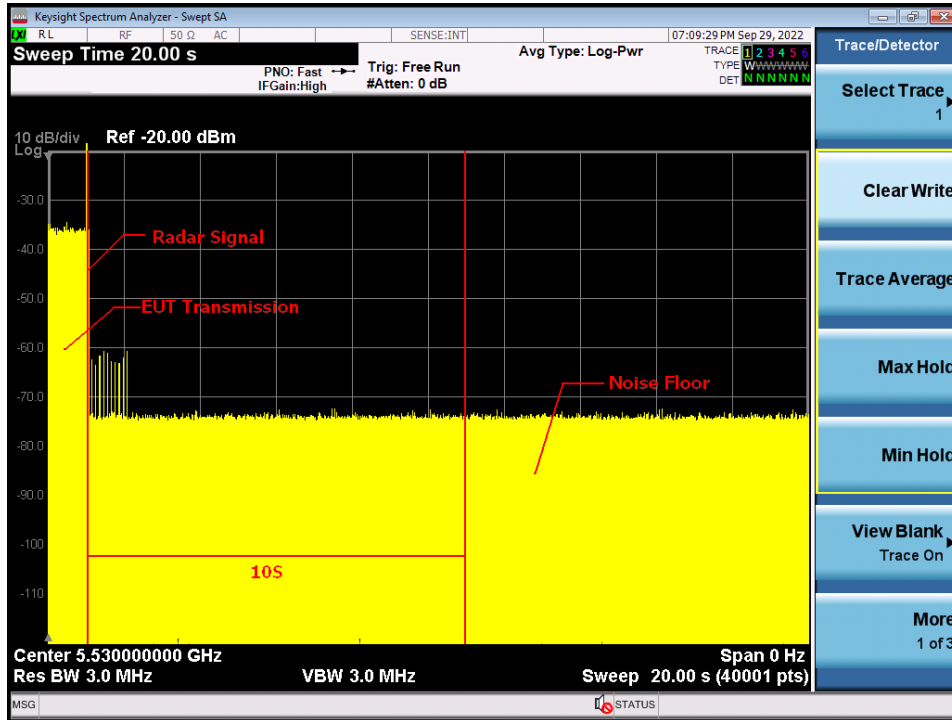

8.4 NON-OCCUPANCY PERIOD

During the 30 minutes observation time, UUT did not make any transmissions on a channel after a radar signal was detected on that channel by either the Channel Availability Check or the In-Service Monitoring.

TX (IEEE 802.11ac(VHT80) Mode) 5530MHz_Non-Occupancy Period

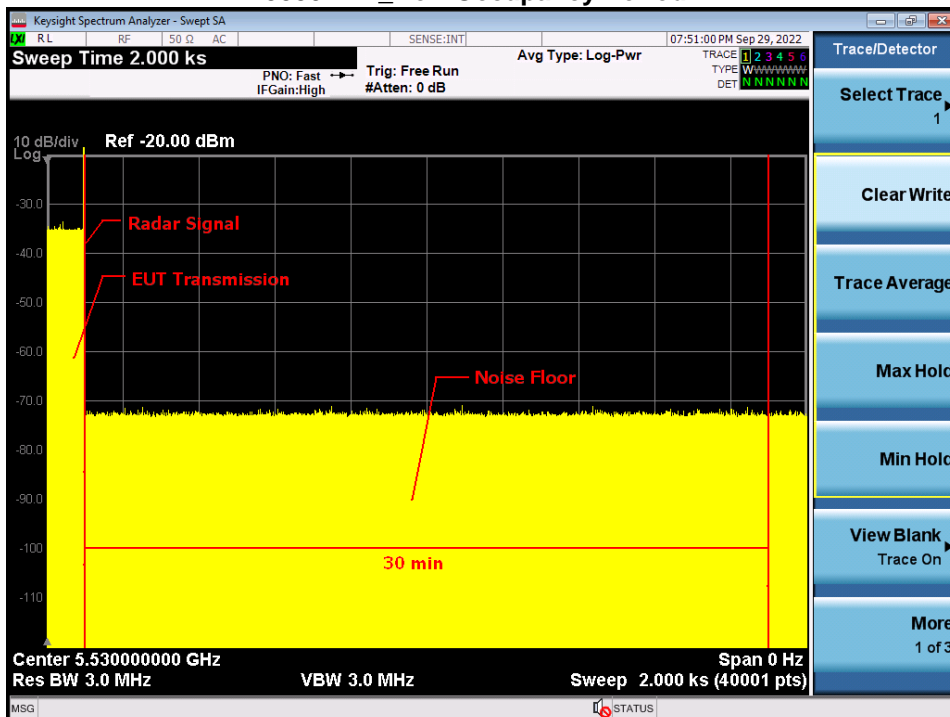

9. EUT TEST PHOTO

Please refer to the Appendix TEST PHOTOS .

End of Test Report