



# RF TEST REPORT

**Applicant**      Quectel Wireless Solutions Co., Ltd  
**FCC ID**          XMR2021EG91NAXDL  
**Product**        LTE Module  
**Brand**            Quectel  
**Model**            EG91-NAXDL  
**Report No.**      R2110A0928-R2V1  
**Issue Date**      December 16, 2021

TA Technology (Shanghai) Co., Ltd. tested the above equipment in accordance with the requirements in **FCC CFR47 Part 2 (2020)/ FCC CFR 47 Part 24E (2020)**. The test results show that the equipment tested is capable of demonstrating compliance with the requirements as documented in this report.

Performed by: Peng Tao

Approved by: Kai Xu

---

## TA Technology (Shanghai) Co., Ltd.

No.145, Jintang Rd, Tangzhen Industry Park, Pudong Shanghai, China

TEL: +86-021-50791141/2/3

FAX: +86-021-50791141/2/3-8000



## TABLE OF CONTENT

1. Test Laboratory .....	5
1.1. Notes of the test report .....	5
1.2. Test facility .....	5
1.3. Testing Location .....	5
2. General Description of Equipment under Test .....	6
2.1. Applicant and Manufacturer Information .....	6
2.2. General information .....	6
3. Applied Standards .....	7
4. Test Configuration .....	8
5. Test Case Results .....	9
5.1. RF Power Output and Effective Radiated Power .....	9
5.2. Occupied Bandwidth .....	17
5.3. Band Edge Compliance .....	24
5.4. Peak-to-Average Power Ratio (PAPR) .....	32
5.5. Frequency Stability .....	34
5.6. Spurious Emissions at Antenna Terminals .....	37
5.7. Radiates Spurious Emission .....	44
6. Main Test Instruments .....	49
<b>ANNEX A: The EUT Appearance .....</b>	<b>51</b>
<b>ANNEX B: Test Setup Photos .....</b>	<b>52</b>
<b>ANNEX C: Product Change Description .....</b>	<b>53</b>



Version	Revision description	Issue Date
Rev.0	Initial issue of report.	December 8, 2021
Rev.1	Add description in Page 8.	December 16, 2021

Note: This revised report (Report No. R2110A0928-R2V1) supersedes and replaces the previously issued report (Report No. R2110A0928-R2). Please discard or destroy the previously issued report and dispose of it accordingly.

### Summary of measurement results

No.	Test Case	Clause in FCC rules	Verdict
1	RF power output and Effective Radiated Power	2.1046 24.232(c)	PASS
2	Occupied Bandwidth	2.1049	PASS
3	Band Edge Compliance	2.1051 /24.238(a)	PASS
4	Peak-to-Average Power Ratio	24.232/KDB 971168 D01(5.7)	PASS
5	Frequency Stability	2.1055 / 24.235	PASS
6	Spurious Emissions at Antenna Terminals	2.1051 / 24.238(a)	PASS
7	Radiates Spurious Emission	2.1053 / 24.238(a)	PASS
Date of Testing(Original):October 22, 2019 ~ November 9, 2019 and July 7, 2020 (Variant): November 30, 2021~ December 1, 2021			
<p>Note: PASS: The EUT complies with the essential requirements in the standard.            FAIL: The EUT does not comply with the essential requirements in the standard.            All indications of Pass/Fail in this report are opinions expressed by TA Technology (Shanghai) Co., Ltd. based on interpretations and/or observations of test results. Measurement Uncertainties were not taken into account and are published for informational purposes only.</p>			

**EG91-NAXDL (Report No.: R2110A0928-R2V1) is a variant model of EG91-NAXD (Report No.: R2006A0379-R2). There is only changed the Software Version, FCC ID and Model of product. Tested cases refer to the following table.**

Test Case	Original	Variant
Occupied Bandwidth	PASS	Updated the data of 16QAM (1.4M/3M/5M).
Band Edge Compliance	PASS	Updated the data of 16QAM (1.4M/3M/5M).
Peak-to-Average Power Ratio	PASS	Updated the data of 16QAM (1.4M/3M/5M).

**The detailed product change description please refers to the *Difference Declaration Letter*.**



## 1. Test Laboratory

### 1.1. Notes of the test report

This report shall not be reproduced in full or partial, without the written approval of **TA technology (shanghai) co., Ltd.** The results documented in this report apply only to the tested sample, under the conditions and modes of operation as described herein. Measurement Uncertainties were not taken into account and are published for informational purposes only. This report is written to support regulatory compliance of the applicable standards stated above.

### 1.2. Test facility

#### **FCC (Designation number: CN1179, Test Firm Registration Number: 446626)**

TA Technology (Shanghai) Co., Ltd. has been listed on the US Federal Communications Commission list of test facilities recognized to perform electromagnetic emissions measurements.

#### **A2LA (Certificate Number: 3857.01)**

TA Technology (Shanghai) Co., Ltd. has been listed by American Association for Laboratory Accreditation to perform electromagnetic emission measurement.

### 1.3. Testing Location

Company: TA Technology (Shanghai) Co., Ltd.  
Address: No.145, Jintang Rd, Tangzhen Industry Park, Pudong  
City: Shanghai  
Post code: 201201  
Country: P. R. China  
Contact: Xu Kai  
Telephone: +86-021-50791141/2/3  
Fax: +86-021-50791141/2/3-8000  
Website: <http://www.ta-shanghai.com>  
E-mail: [xukai@ta-shanghai.com](mailto:xukai@ta-shanghai.com)

## 2. General Description of Equipment under Test

### 2.1. Applicant and Manufacturer Information

Applicant	Quectel Wireless Solutions Co., Ltd
Applicant address	Building 5, Shanghai Business Park Phase III (Area B), No.1016 Tianlin Road, Minhang District, Shanghai, China 200233
Manufacturer	Quectel Wireless Solutions Co., Ltd
Manufacturer address	Building 5, Shanghai Business Park Phase III (Area B), No.1016 Tianlin Road, Minhang District, Shanghai, China 200233

### 2.2. General information

EUT Description			
Model	EG91-NAXDL		
IMEI	Original(EG91-NAXD)	863071010199125	
	Variant(EG91-NAXDL)	863495050001955	
Hardware Version	R1.0		
Software Version	EG91NAXDLGAR07A01M1G		
Power Supply	External Power Supply		
Antenna Type	The EUT don't have standard Antenna, The Antenna used for testing in this report is the after-market accessory (Dipole Antenna)		
Antenna Gain	Frequency(MHz)	Gain(dBi)	
	1860	1.25	
	1880	1.38	
	1900	1.59	
Antenna Gain	1920	1.36	
Test Mode(s)	LTE Band 25;		
Test Modulation	(LTE)QPSK,16QAM		
LTE Category	1		
Maximum E.I.R.P	LTE Band 25:	25.47dBm	
Rated Power Supply Voltage	3.8V		
Extreme Voltage	Minimum: 3.3V Maximum: 4.3V		
Extreme Temperature	Lowest: -40°C Highest: +85°C		
Operating Frequency Range(s)	Band	Tx (MHz)	Rx (MHz)
	LTE Band 25	1850 ~ 1915	1930 ~ 1995
Note: 1. The EUT is sent from the applicant to TA and the information of the EUT is declared by the applicant.			

### 3. Applied Standards

According to the specifications of the manufacturer, it must comply with the requirements of the following standards:

**Test standards:**

**FCC CFR 47 Part 24E (2020)**

**ANSI C63.26 (2015)**

**Reference standard:**

**FCC CFR47 Part 2 (2020)**

**KDB 971168 D01 Power Meas License Digital Systems v03r01**

### 4. Test Configuration

Radiated measurements are performed by rotating the EUT in three different orthogonal test planes. EUT stand-up position (Z axis), lie-down position (X, Y axis). Receiver antenna polarization (horizontal and vertical), the worst emission was found in position (X axis, vertical polarization) and the worst case was recorded.

All mode and data rates and positions and RB size and modulations were investigated.

Subsequently, only the worst case emissions are reported.

The following testing in LTE is set based on the maximum RF Output Power.

Test modes are chosen to be reported as the worst case configuration below for LTE Band 25:

Test items	Bandwidth (MHz)						Modulation		RB			Test Channel		
	1.4	3	5	10	15	20	QPSK	16QAM	1	50%	100%	L	M	H
RF power output and Effective Isotropic Radiated power	O	O	O	O	O	O	O	O	O	O	O	O	O	O
Occupied Bandwidth	O	O	O	O	O	O	O	O	-	-	O	O	O	O
Band Edge Compliance	O	O	O	O	O	O	O	O	O	-	O	O	-	O
Peak-to-Average Power Ratio	O	O	O	O	O	O	O	O	-	-	O	O	O	O
Frequency Stability	-	-	-	-	O	O	O	O	-	-	O	O	O	O
Conducted Spurious Emissions	O	O	O	O	O	O	O	-	O	-	-	O	O	O
Radiates Spurious Emission	O	-	O	-	-	O	O	-	O	-	-	-	O	-

Note:

1. The mark “O” means that this configuration is chosen for testing.
2. The mark “-” means that this configuration is not testing.
3. The product prototype category level is 1, 16QAM10M/15M/20M can only support up to 24RB, and cannot support full RB, so Bandwidth and PAPA that require full RB testing have not been tested.



## 5. Test Case Results

### 5.1.RF Power Output and Effective Radiated Power

#### Ambient condition

Temperature	Relative humidity	Pressure
23°C ~25°C	45%~50%	101.5kPa

#### Methods of Measurement

The testing follows FCC KDB 971168 v03r01 Section 5.8 and ANSI C63.26 (2015).

- a) Connect the equipment as illustrated. Mount the equipment with the manufacturer specified antenna in a vertical orientation on a manufacturer specified mounting surface located on a non-conducting rotating platform of a RF anechoic chamber (preferred) or a standard radiation site.
- b) Key the transmitter, then rotate the EUT 360° azimuthally and record spectrum analyzer power level (LVL) measurements at angular increments that are sufficiently small to permit resolution of all peaks. If a standard radiation test site is used, raise and lower the test antenna to obtain a maximum reading at each angular increment. (Note: several batteries may be needed to offset the effect of battery voltage droop, which should not exceed 5% of the manufactured specified battery voltage during transmission).
- c) Replace the transmitter under test with a vertically polarized half-wave dipole (or an antenna whose gain is known relative to an ideal half-wave dipole). The center of the antenna should be at the same location as the center of the antenna under test.
- d) Connect the antenna to a signal generator with a known output power and record the path loss (in dB) as LOSS. If a standard radiation test site is used, raise and lower the test antenna to obtain a maximum reading.  $LOSS = \text{Generator Output Power (dBm)} - \text{Analyzer reading (dBm)}$
- e) Determine the effective radiated output power at each angular position from the readings in steps b) and d) using the following equation:  $ERP \text{ (dBm)} = \text{LVL (dBm)} + \text{LOSS (dB)}$
- f) The maximum ERP is the maximum value determined in the preceding step.
- g) When calculating ERP, in addition to knowing the antenna radiation and matching characteristics, it is necessary to know the loss values of all elements (e.g.transmission line attenuation, mismatches, filters, combiners) interposed between the point where transmitter output power is measured, and the point where power is applied to the antenna. ERP can then be calculated as follows:  
 $EIRP \text{ (dBm)} = \text{Output Power (dBm)} - \text{Losses (dB)} + \text{Antenna Gain (dBi)}$   
 where:dBd refers to gain relative to an ideal dipole.  
 $EIRP \text{ (dBm)} = ERP \text{ (dBm)} + 2.15 \text{ (dB.)}$

The RB allocation refers to section 5.1, using the maximum output power configuration.

### Test Setup

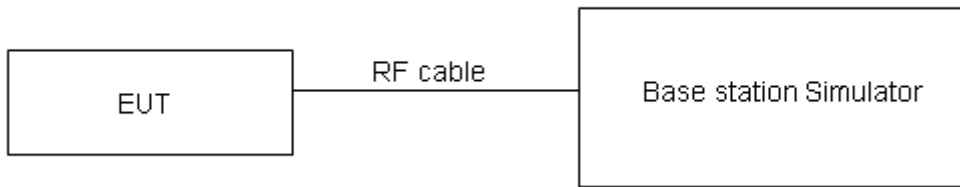

The loss between RF output port of the EUT and the input port of the tester has been taken into consideration.

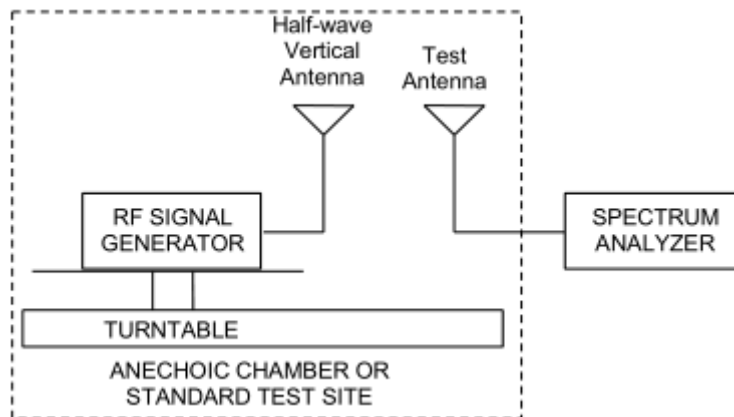
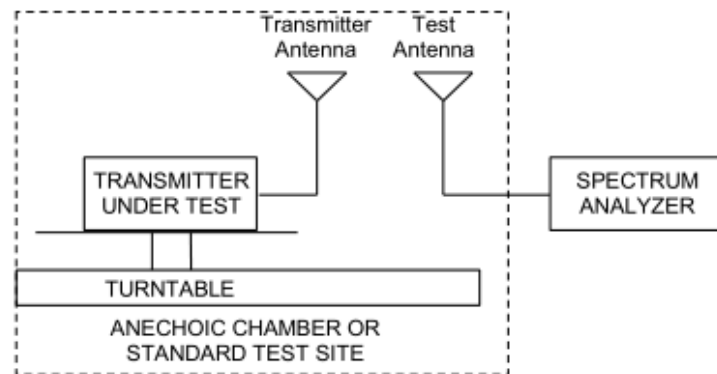

### Limits

No specific RF power output requirements in part 2.1046.

Rule Part 24.232(c) Mobile and portable stations are limited to 2 watts EIRP.

Rule Part 24.232(e) Peak transmit power must be measured over any interval of continuous transmission using instrumentation calibrated in terms of an rms-equivalent voltage.

Limit	$\leq 2\text{ W}$ (33 dBm)
-------	----------------------------

### Measurement Uncertainty

The assessed measurement uncertainty to ensure 95% confidence level for the normal distribution is with the coverage factor  $k = 2$ ,  $U = 0.4$  dB for RF power output,  $k = 2$ ,  $U = 1.19$  dB for EIRP.

**Test Results**

Band	Bandwidth	Modulation	Channel	RB Configuration	Conducted Power(dBm)	EIRP(dBm)
LTE Band 25	1.4M	QPSK	26047	1RB#0	23.44	24.69
LTE Band 25	1.4M	QPSK	26047	1RB#2	23.45	24.70
LTE Band 25	1.4M	QPSK	26047	1RB#5	23.40	24.65
LTE Band 25	1.4M	QPSK	26047	3RB#0	22.46	23.71
LTE Band 25	1.4M	QPSK	26047	3RB#2	22.44	23.69
LTE Band 25	1.4M	QPSK	26047	3RB#3	22.49	23.74
LTE Band 25	1.4M	QPSK	26047	6RB#0	22.42	23.67
LTE Band 25	1.4M	QPSK	26365	1RB#0	23.59	24.97
LTE Band 25	1.4M	QPSK	26365	1RB#2	23.50	24.88
LTE Band 25	1.4M	QPSK	26365	1RB#5	23.54	24.92
LTE Band 25	1.4M	QPSK	26365	3RB#0	22.58	23.96
LTE Band 25	1.4M	QPSK	26365	3RB#2	22.60	23.98
LTE Band 25	1.4M	QPSK	26365	3RB#3	22.59	23.97
LTE Band 25	1.4M	QPSK	26365	6RB#0	22.64	24.02
LTE Band 25	1.4M	QPSK	26683	1RB#0	23.30	24.66
LTE Band 25	1.4M	QPSK	26683	1RB#2	23.49	24.85
LTE Band 25	1.4M	QPSK	26683	1RB#5	23.55	24.91
LTE Band 25	1.4M	QPSK	26683	3RB#0	22.38	23.74
LTE Band 25	1.4M	QPSK	26683	3RB#2	22.43	23.79
LTE Band 25	1.4M	QPSK	26683	3RB#3	22.49	23.85
LTE Band 25	1.4M	QPSK	26683	6RB#0	22.37	23.73
LTE Band 25	1.4M	16QAM	26047	1RB#0	22.26	23.51
LTE Band 25	1.4M	16QAM	26047	1RB#2	22.41	23.66
LTE Band 25	1.4M	16QAM	26047	1RB#5	22.31	23.56
LTE Band 25	1.4M	16QAM	26047	3RB#0	21.23	22.48
LTE Band 25	1.4M	16QAM	26047	3RB#2	21.29	22.54
LTE Band 25	1.4M	16QAM	26047	3RB#3	21.36	22.61
LTE Band 25	1.4M	16QAM	26047	6RB#0	21.39	22.64
LTE Band 25	1.4M	16QAM	26365	1RB#0	21.98	23.36
LTE Band 25	1.4M	16QAM	26365	1RB#2	21.96	23.34
LTE Band 25	1.4M	16QAM	26365	1RB#5	21.90	23.28
LTE Band 25	1.4M	16QAM	26365	3RB#0	21.17	22.55
LTE Band 25	1.4M	16QAM	26365	3RB#2	21.30	22.68
LTE Band 25	1.4M	16QAM	26365	3RB#3	21.46	22.84
LTE Band 25	1.4M	16QAM	26365	6RB#0	21.56	22.94
LTE Band 25	1.4M	16QAM	26683	1RB#0	22.21	23.57
LTE Band 25	1.4M	16QAM	26683	1RB#2	22.54	23.90
LTE Band 25	1.4M	16QAM	26683	1RB#5	22.89	24.25
LTE Band 25	1.4M	16QAM	26683	3RB#0	21.16	22.52



LTE Band 25	1.4M	16QAM	26683	3RB#2	21.18	22.54
LTE Band 25	1.4M	16QAM	26683	3RB#3	21.15	22.51
LTE Band 25	1.4M	16QAM	26683	6RB#0	21.25	22.61
LTE Band 25	3M	QPSK	26055	1RB#0	23.46	24.71
LTE Band 25	3M	QPSK	26055	1RB#7	23.48	24.73
LTE Band 25	3M	QPSK	26055	1RB#14	23.43	24.68
LTE Band 25	3M	QPSK	26055	8RB#0	22.54	23.79
LTE Band 25	3M	QPSK	26055	8RB#4	22.54	23.79
LTE Band 25	3M	QPSK	26055	8RB#7	22.57	23.82
LTE Band 25	3M	QPSK	26055	15RB#0	22.45	23.70
LTE Band 25	3M	QPSK	26365	1RB#0	23.63	25.01
LTE Band 25	3M	QPSK	26365	1RB#7	23.55	24.93
LTE Band 25	3M	QPSK	26365	1RB#14	23.59	24.97
LTE Band 25	3M	QPSK	26365	8RB#0	22.68	24.06
LTE Band 25	3M	QPSK	26365	8RB#4	22.68	24.06
LTE Band 25	3M	QPSK	26365	8RB#7	22.68	24.06
LTE Band 25	3M	QPSK	26365	15RB#0	22.68	24.06
LTE Band 25	3M	QPSK	26675	1RB#0	23.33	24.69
LTE Band 25	3M	QPSK	26675	1RB#7	23.53	24.89
LTE Band 25	3M	QPSK	26675	1RB#14	23.59	24.95
LTE Band 25	3M	QPSK	26675	8RB#0	22.49	23.85
LTE Band 25	3M	QPSK	26675	8RB#4	22.53	23.89
LTE Band 25	3M	QPSK	26675	8RB#7	22.57	23.93
LTE Band 25	3M	QPSK	26675	15RB#0	22.40	23.76
LTE Band 25	3M	16QAM	26055	1RB#0	22.29	23.54
LTE Band 25	3M	16QAM	26055	1RB#7	22.44	23.69
LTE Band 25	3M	16QAM	26055	1RB#14	22.33	23.58
LTE Band 25	3M	16QAM	26055	8RB#0	21.32	22.57
LTE Band 25	3M	16QAM	26055	8RB#4	21.38	22.63
LTE Band 25	3M	16QAM	26055	8RB#7	21.44	22.69
LTE Band 25	3M	16QAM	26055	15RB#0	21.42	22.67
LTE Band 25	3M	16QAM	26365	1RB#0	22.00	23.38
LTE Band 25	3M	16QAM	26365	1RB#7	22.01	23.39
LTE Band 25	3M	16QAM	26365	1RB#14	21.94	23.32
LTE Band 25	3M	16QAM	26365	8RB#0	21.28	22.66
LTE Band 25	3M	16QAM	26365	8RB#4	21.41	22.79
LTE Band 25	3M	16QAM	26365	8RB#7	21.56	22.94
LTE Band 25	3M	16QAM	26365	15RB#0	21.60	22.98
LTE Band 25	3M	16QAM	26675	1RB#0	22.24	23.60
LTE Band 25	3M	16QAM	26675	1RB#7	22.58	23.94
LTE Band 25	3M	16QAM	26675	1RB#14	22.92	24.28
LTE Band 25	3M	16QAM	26675	8RB#0	21.26	22.62
LTE Band 25	3M	16QAM	26675	8RB#4	21.28	22.64



LTE Band 25	3M	16QAM	26675	8RB#7	21.26	22.62
LTE Band 25	3M	16QAM	26675	15RB#0	21.28	22.64
LTE Band 25	5M	QPSK	26065	1RB#0	23.41	24.66
LTE Band 25	5M	QPSK	26065	1RB#13	23.46	24.71
LTE Band 25	5M	QPSK	26065	1RB#24	23.37	24.62
LTE Band 25	5M	QPSK	26065	12RB#0	22.49	23.74
LTE Band 25	5M	QPSK	26065	12RB#6	22.50	23.75
LTE Band 25	5M	QPSK	26065	12RB#13	22.51	23.76
LTE Band 25	5M	QPSK	26065	25RB#0	22.46	23.71
LTE Band 25	5M	QPSK	26365	1RB#0	23.54	24.92
LTE Band 25	5M	QPSK	26365	1RB#13	23.51	24.89
LTE Band 25	5M	QPSK	26365	1RB#24	23.52	24.90
LTE Band 25	5M	QPSK	26365	12RB#0	22.59	23.97
LTE Band 25	5M	QPSK	26365	12RB#6	22.60	23.98
LTE Band 25	5M	QPSK	26365	12RB#13	22.62	24.00
LTE Band 25	5M	QPSK	26365	25RB#0	22.60	23.98
LTE Band 25	5M	QPSK	26665	1RB#0	23.27	24.63
LTE Band 25	5M	QPSK	26665	1RB#13	23.49	24.85
LTE Band 25	5M	QPSK	26665	1RB#24	23.51	24.87
LTE Band 25	5M	QPSK	26665	12RB#0	22.42	23.78
LTE Band 25	5M	QPSK	26665	12RB#6	22.45	23.81
LTE Band 25	5M	QPSK	26665	12RB#13	22.50	23.86
LTE Band 25	5M	QPSK	26665	25RB#0	22.33	23.69
LTE Band 25	5M	16QAM	26065	1RB#0	22.21	23.46
LTE Band 25	5M	16QAM	26065	1RB#13	22.38	23.63
LTE Band 25	5M	16QAM	26065	1RB#24	22.28	23.53
LTE Band 25	5M	16QAM	26065	12RB#0	21.27	22.52
LTE Band 25	5M	16QAM	26065	12RB#6	21.31	22.56
LTE Band 25	5M	16QAM	26065	12RB#13	21.39	22.64
LTE Band 25	5M	16QAM	26065	25RB#0	21.38	22.63
LTE Band 25	5M	16QAM	26365	1RB#0	21.93	23.31
LTE Band 25	5M	16QAM	26365	1RB#13	21.98	23.36
LTE Band 25	5M	16QAM	26365	1RB#24	21.87	23.25
LTE Band 25	5M	16QAM	26365	12RB#0	21.23	22.61
LTE Band 25	5M	16QAM	26365	12RB#6	21.33	22.71
LTE Band 25	5M	16QAM	26365	12RB#13	21.47	22.85
LTE Band 25	5M	16QAM	26365	25RB#0	21.52	22.90
LTE Band 25	5M	16QAM	26665	1RB#0	22.16	23.52
LTE Band 25	5M	16QAM	26665	1RB#13	22.52	23.88
LTE Band 25	5M	16QAM	26665	1RB#24	22.86	24.22
LTE Band 25	5M	16QAM	26665	12RB#0	21.21	22.57
LTE Band 25	5M	16QAM	26665	12RB#6	21.20	22.56
LTE Band 25	5M	16QAM	26665	12RB#13	21.19	22.55



LTE Band 25	5M	16QAM	26665	25RB#0	21.20	22.56
LTE Band 25	10M	QPSK	26090	1RB#0	23.61	24.86
LTE Band 25	10M	QPSK	26090	1RB#25	23.62	24.87
LTE Band 25	10M	QPSK	26090	1RB#49	23.75	25.00
LTE Band 25	10M	QPSK	26090	25RB#0	22.54	23.79
LTE Band 25	10M	QPSK	26090	25RB#13	22.50	23.75
LTE Band 25	10M	QPSK	26090	25RB#25	22.55	23.80
LTE Band 25	10M	QPSK	26090	50RB#0	22.61	23.86
LTE Band 25	10M	QPSK	26365	1RB#0	23.55	24.93
LTE Band 25	10M	QPSK	26365	1RB#25	23.72	25.10
LTE Band 25	10M	QPSK	26365	1RB#49	23.47	24.85
LTE Band 25	10M	QPSK	26365	25RB#0	22.64	24.02
LTE Band 25	10M	QPSK	26365	25RB#13	22.66	24.04
LTE Band 25	10M	QPSK	26365	25RB#25	22.67	24.05
LTE Band 25	10M	QPSK	26365	50RB#0	22.67	24.05
LTE Band 25	10M	QPSK	26640	1RB#0	23.65	25.01
LTE Band 25	10M	QPSK	26640	1RB#25	23.69	25.05
LTE Band 25	10M	QPSK	26640	1RB#49	23.70	25.06
LTE Band 25	10M	QPSK	26640	25RB#0	22.66	24.02
LTE Band 25	10M	QPSK	26640	25RB#13	22.51	23.87
LTE Band 25	10M	QPSK	26640	25RB#25	22.38	23.74
LTE Band 25	10M	QPSK	26640	50RB#0	22.52	23.88
LTE Band 25	10M	16QAM	26090	1RB#0	22.83	24.08
LTE Band 25	10M	16QAM	26090	1RB#25	23.35	24.60
LTE Band 25	10M	16QAM	26090	1RB#49	22.91	24.16
LTE Band 25	10M	16QAM	26090	25RB#0	21.47	22.72
LTE Band 25	10M	16QAM	26090	25RB#13	21.52	22.77
LTE Band 25	10M	16QAM	26090	25RB#25	21.59	22.84
LTE Band 25	10M	16QAM	26365	1RB#0	22.93	24.31
LTE Band 25	10M	16QAM	26365	1RB#25	23.02	24.40
LTE Band 25	10M	16QAM	26365	1RB#49	22.38	23.76
LTE Band 25	10M	16QAM	26365	25RB#0	21.57	22.95
LTE Band 25	10M	16QAM	26365	25RB#13	21.58	22.96
LTE Band 25	10M	16QAM	26365	25RB#25	21.60	22.98
LTE Band 25	10M	16QAM	26640	1RB#0	22.88	24.24
LTE Band 25	10M	16QAM	26640	1RB#25	23.22	24.58
LTE Band 25	10M	16QAM	26640	1RB#49	22.40	23.76
LTE Band 25	10M	16QAM	26640	25RB#0	21.55	22.91
LTE Band 25	10M	16QAM	26640	25RB#13	21.43	22.79
LTE Band 25	10M	16QAM	26640	25RB#25	21.37	22.73
LTE Band 25	15M	QPSK	26115	1RB#0	23.50	24.75
LTE Band 25	15M	QPSK	26115	1RB#38	23.57	24.82
LTE Band 25	15M	QPSK	26115	1RB#74	23.45	24.70



LTE Band 25	15M	QPSK	26115	36RB#0	22.60	23.85
LTE Band 25	15M	QPSK	26115	36RB#18	22.60	23.85
LTE Band 25	15M	QPSK	26115	36RB#39	22.58	23.83
LTE Band 25	15M	QPSK	26115	75RB#0	22.61	23.86
LTE Band 25	15M	QPSK	26365	1RB#0	23.55	24.93
LTE Band 25	15M	QPSK	26365	1RB#38	23.50	24.88
LTE Band 25	15M	QPSK	26365	1RB#74	23.41	24.79
LTE Band 25	15M	QPSK	26365	36RB#0	22.63	24.01
LTE Band 25	15M	QPSK	26365	36RB#18	22.60	23.98
LTE Band 25	15M	QPSK	26365	36RB#39	22.58	23.96
LTE Band 25	15M	QPSK	26365	75RB#0	22.61	23.99
LTE Band 25	15M	QPSK	26615	1RB#0	23.46	25.05
LTE Band 25	15M	QPSK	26615	1RB#38	23.78	25.37
LTE Band 25	15M	QPSK	26615	1RB#74	23.45	25.04
LTE Band 25	15M	QPSK	26615	36RB#0	22.58	24.17
LTE Band 25	15M	QPSK	26615	36RB#18	22.41	24.00
LTE Band 25	15M	QPSK	26615	36RB#39	22.34	23.93
LTE Band 25	15M	QPSK	26615	75RB#0	22.53	24.12
LTE Band 25	15M	16QAM	26115	1RB#0	23.09	24.34
LTE Band 25	15M	16QAM	26115	1RB#38	23.13	24.38
LTE Band 25	15M	16QAM	26115	1RB#74	22.98	24.23
LTE Band 25	15M	16QAM	26365	1RB#0	23.19	24.57
LTE Band 25	15M	16QAM	26365	1RB#38	23.13	24.51
LTE Band 25	15M	16QAM	26365	1RB#74	23.06	24.44
LTE Band 25	15M	16QAM	26615	1RB#0	23.11	24.70
LTE Band 25	15M	16QAM	26615	1RB#38	23.07	24.66
LTE Band 25	15M	16QAM	26615	1RB#74	22.89	24.48
LTE Band 25	20M	QPSK	26140	1RB#0	23.28	24.53
LTE Band 25	20M	QPSK	26140	1RB#50	23.89	25.14
LTE Band 25	20M	QPSK	26140	1RB#99	23.32	24.57
LTE Band 25	20M	QPSK	26140	50RB#0	22.68	23.93
LTE Band 25	20M	QPSK	26140	50RB#25	22.60	23.85
LTE Band 25	20M	QPSK	26140	50RB#50	22.55	23.80
LTE Band 25	20M	QPSK	26140	100RB#0	22.51	23.76
LTE Band 25	20M	QPSK	26365	1RB#0	23.18	24.56
LTE Band 25	20M	QPSK	26365	1RB#50	24.00	25.38
LTE Band 25	20M	QPSK	26365	1RB#99	23.31	24.69
LTE Band 25	20M	QPSK	26365	50RB#0	22.74	24.12
LTE Band 25	20M	QPSK	26365	50RB#25	22.70	24.08
LTE Band 25	20M	QPSK	26365	50RB#50	22.67	24.05
LTE Band 25	20M	QPSK	26365	100RB#0	22.63	24.01
LTE Band 25	20M	QPSK	26590	1RB#0	23.82	25.41
LTE Band 25	20M	QPSK	26590	1RB#50	23.88	25.47



LTE Band 25	20M	QPSK	26590	1RB#99	23.50	25.09
LTE Band 25	20M	QPSK	26590	50RB#0	22.49	24.08
LTE Band 25	20M	QPSK	26590	50RB#25	22.41	24.00
LTE Band 25	20M	QPSK	26590	50RB#50	22.34	23.93
LTE Band 25	20M	QPSK	26590	100RB#0	22.43	24.02
LTE Band 25	20M	16QAM	26140	1RB#0	22.50	23.75
LTE Band 25	20M	16QAM	26140	1RB#50	23.21	24.46
LTE Band 25	20M	16QAM	26140	1RB#99	22.57	23.82
LTE Band 25	20M	16QAM	26365	1RB#0	22.74	24.12
LTE Band 25	20M	16QAM	26365	1RB#50	23.26	24.64
LTE Band 25	20M	16QAM	26365	1RB#99	22.82	24.20
LTE Band 25	20M	16QAM	26590	1RB#0	21.82	23.41
LTE Band 25	20M	16QAM	26590	1RB#50	22.49	24.08
LTE Band 25	20M	16QAM	26590	1RB#99	21.91	23.50



## 5.2.Occupied Bandwidth

### Ambient condition

Temperature	Relative humidity	Pressure
23°C ~25°C	45%~50%	101.5kPa

### Method of Measurement

The EUT was connected to Spectrum Analyzer and Base Station Simulator via power Splitter. The occupied bandwidth is measured using spectrum analyzer.

RBW is set to 30kHz, VBW is set to 91kHz for LTE Band 25(1.4MHz),

RBW is set to 62kHz,VBW is set to 180kHz for LTE Band 25 (3MHz),

RBW is set to 100kHz,VBW is set to 300kHz for LTE Band 25 (5MHz),

RBW is set to 200kHz,VBW is set to 620kHz for LTE Band 25(10MHz),

RBW is set to 300kHz,VBW is set to 910kHz for LTE Band 25(15MHz),

RBW is set to 430kHz,VBW is set to 1.2MHz for LTE Band 25(20MHz).

99% power and -26dBc occupied bandwidths are recorded. Spectrum analyzer plots are included on the following pages.

### Test Setup

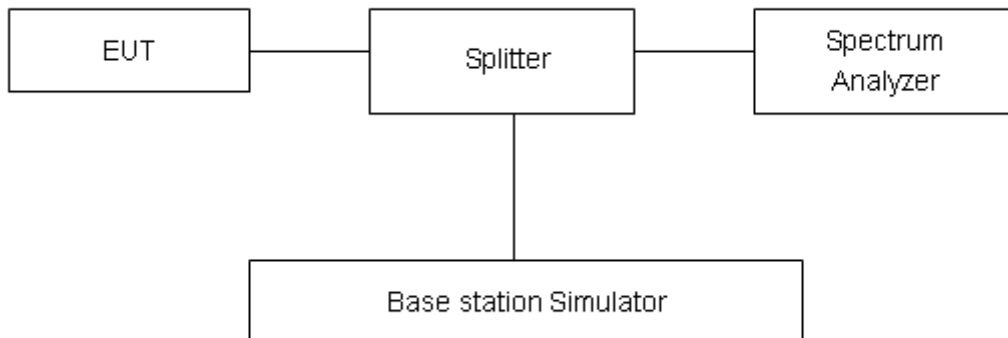

### Limits

No specific occupied bandwidth requirements in part 2.1049.

### Measurement Uncertainty

The assessed measurement uncertainty to ensure 95% confidence level for the normal distribution is with the coverage factor  $k = 2$ ,  $U = 624\text{Hz}$ .

**Test Result**

LTE Band 25						
Modulation	Bandwidth (MHz)	Channel	Frequency (MHz)	99% Power Bandwidth(MHz)	-26dBc Bandwidth(MHz)	
QPSK	1.4	26047	1850.7	1.0928	1.291	
		26365	1882.5	1.0956	1.315	
		26683	1914.3	1.1042	1.285	
	3	26055	1851.5	2.7112	2.996	
		26365	1882.5	2.7173	2.970	
		26675	1913.5	2.7005	2.972	
	5	26065	1852.5	4.5131	4.958	
		26365	1882.5	4.5188	4.992	
		26665	1912.5	4.5178	4.963	
	10	26090	1855	8.9891	9.940	
		26365	1882.5	8.9579	9.768	
		26640	1910	8.9657	9.806	
	15	26115	1857.5	13.4440	14.420	
		26365	1882.5	13.4360	14.610	
		26615	1907.5	13.3930	14.830	
	20	26140	1860	17.8610	19.260	
		26365	1882.5	17.8810	19.310	
		26590	1905	17.8840	19.320	
	16QAM	1.4	26047	1850.7	1.1010	1.304
			26365	1882.5	1.1028	1.306
			26683	1914.3	1.1002	1.286
3		26055	1851.5	2.7070	2.989	
		26365	1882.5	2.7063	2.995	
		26675	1913.5	2.7068	3.018	
5		26065	1852.5	4.5017	4.982	
		26365	1882.5	4.5245	5.029	
		26665	1912.5	4.5443	5.043	

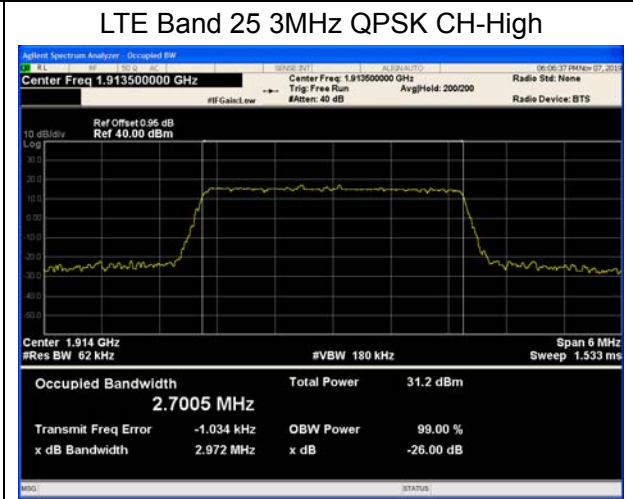
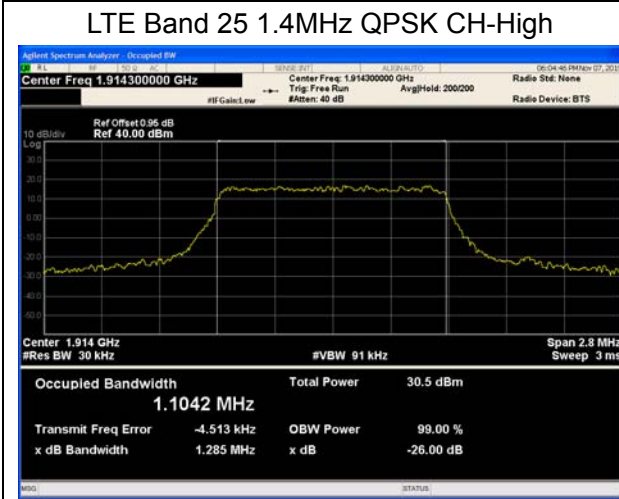
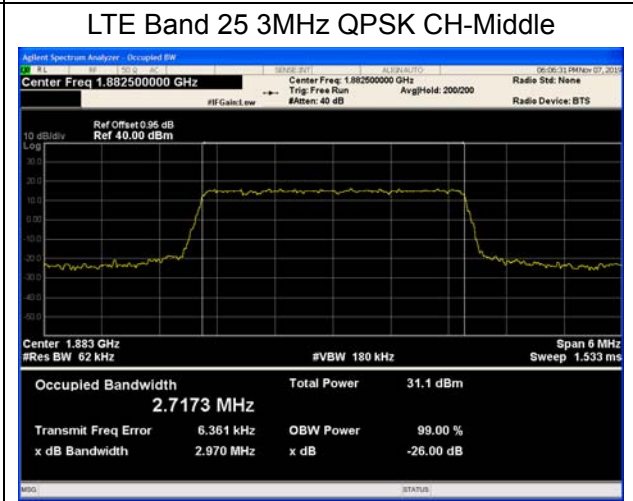
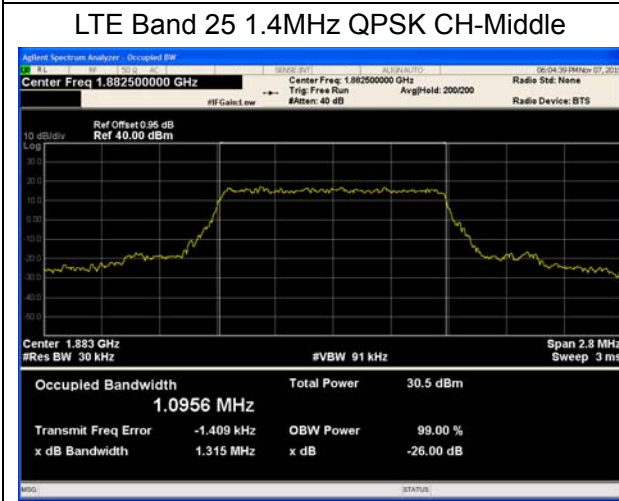
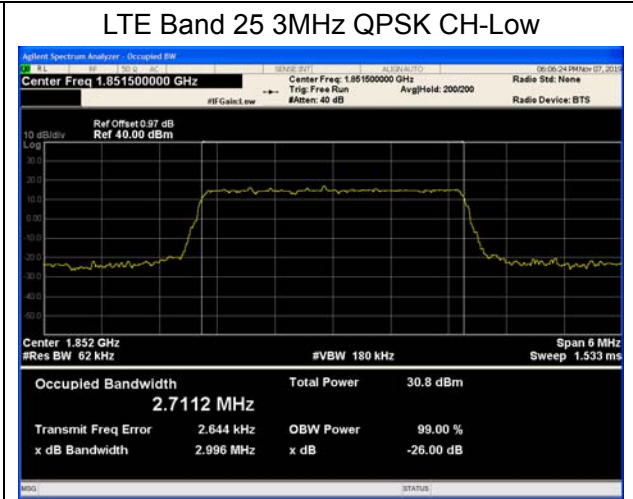
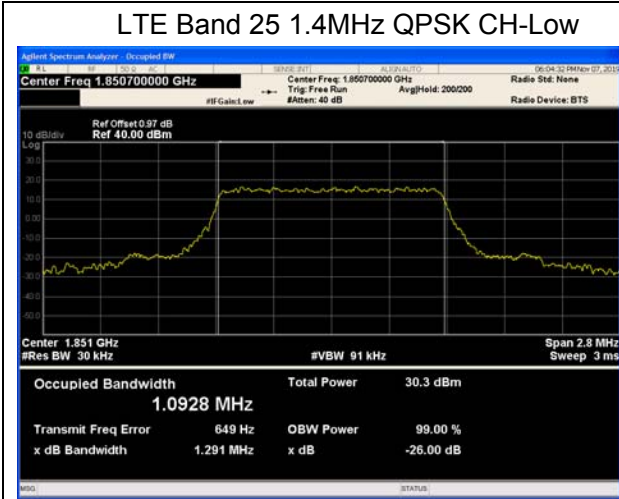

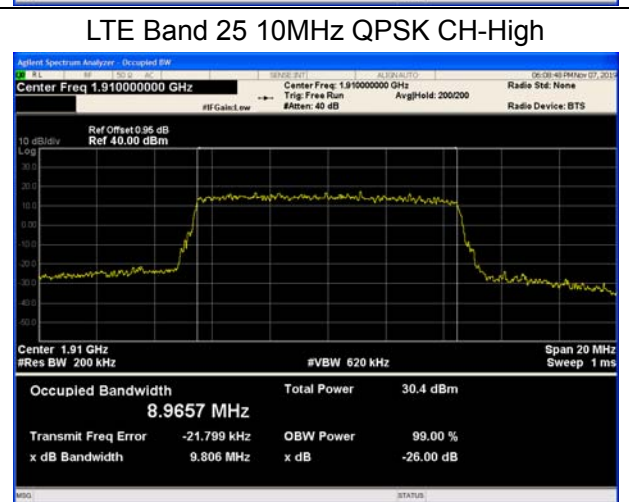
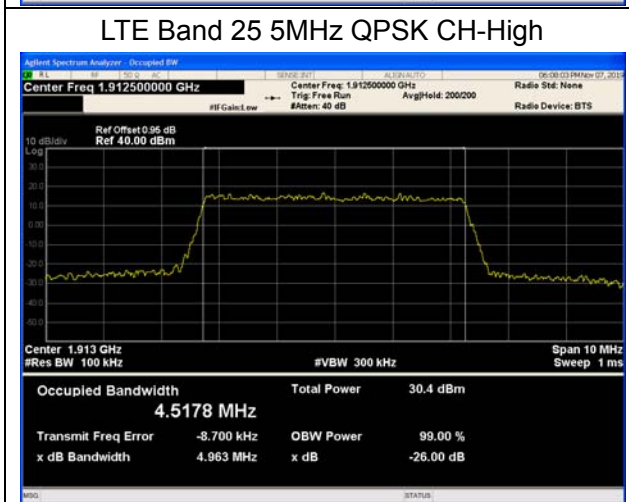
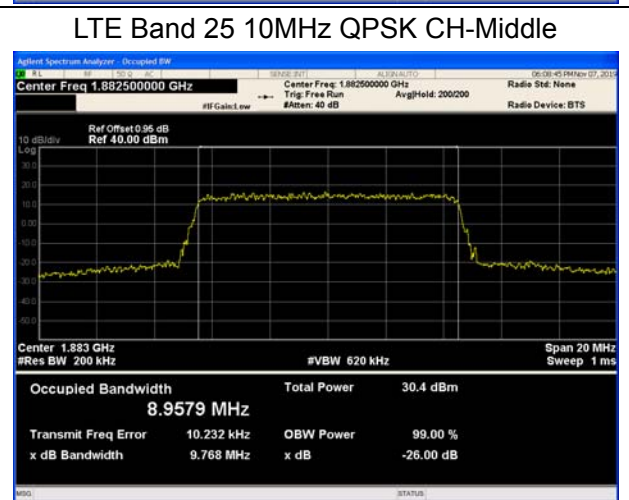
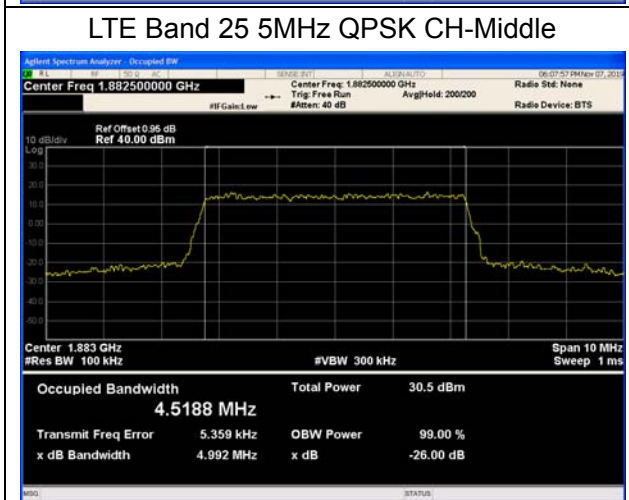
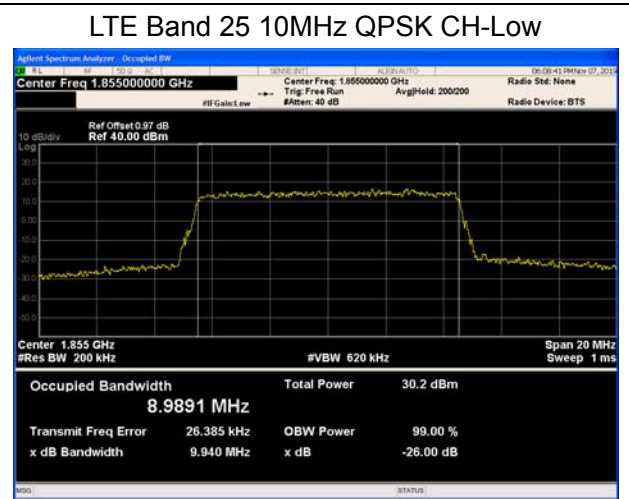
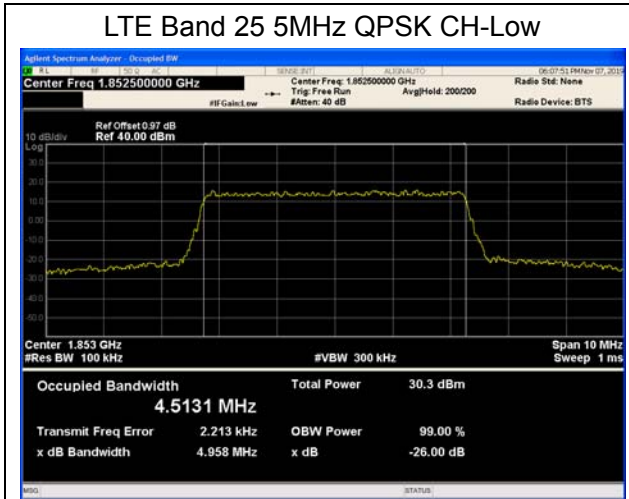

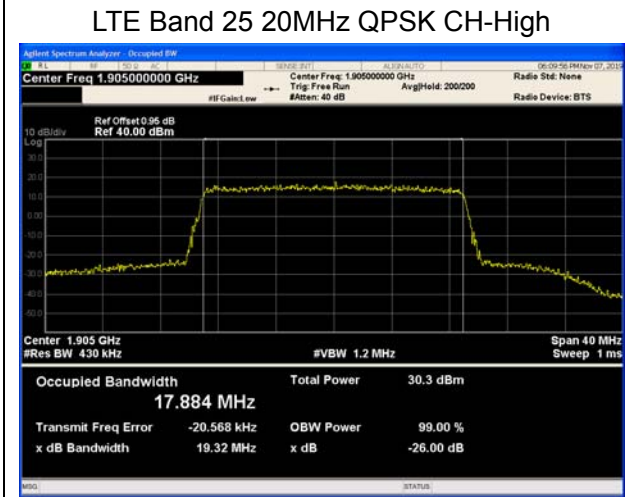
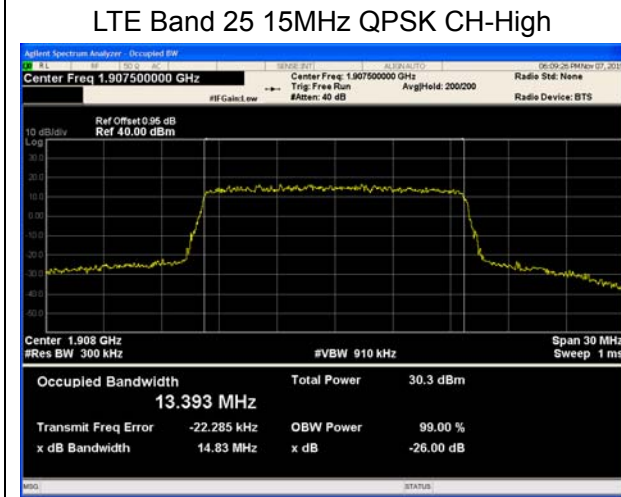
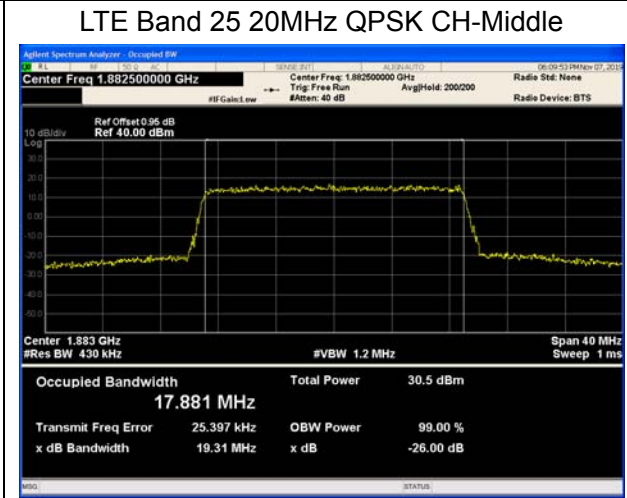
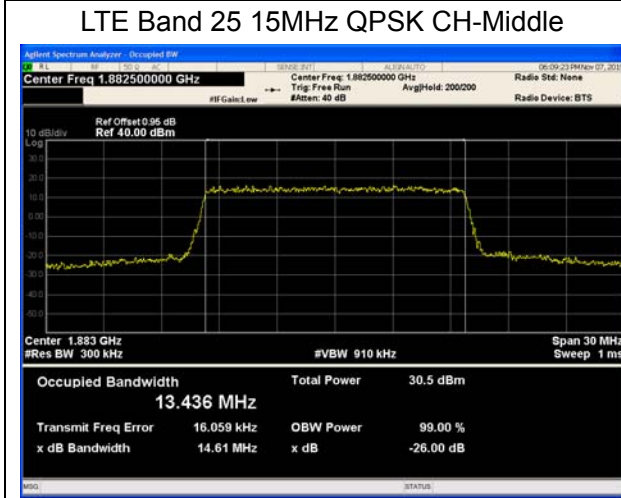
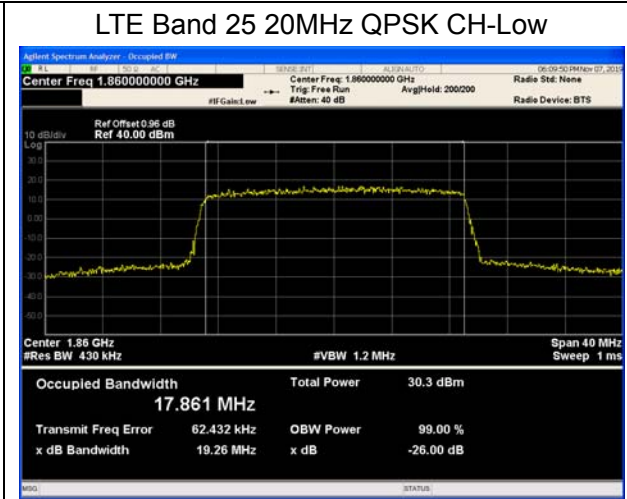
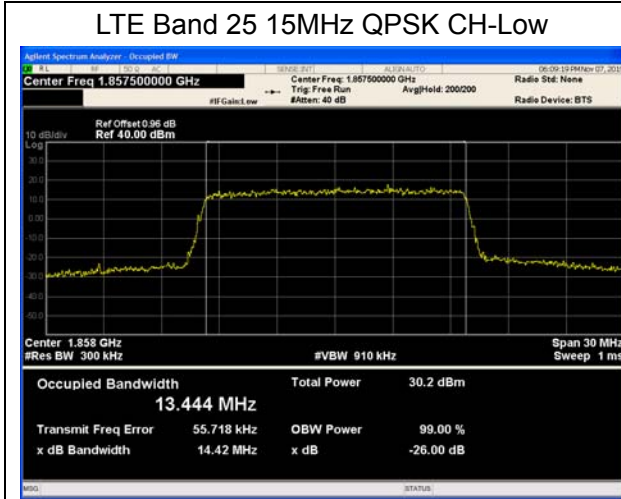

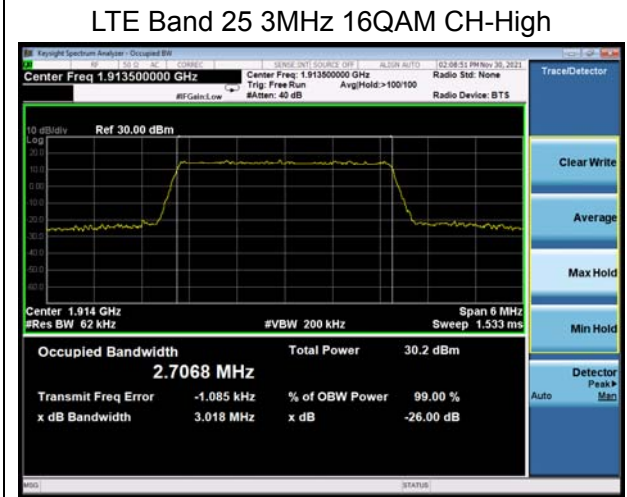
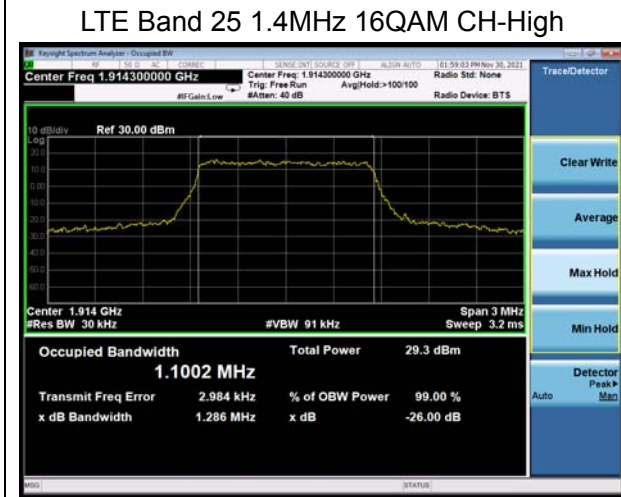
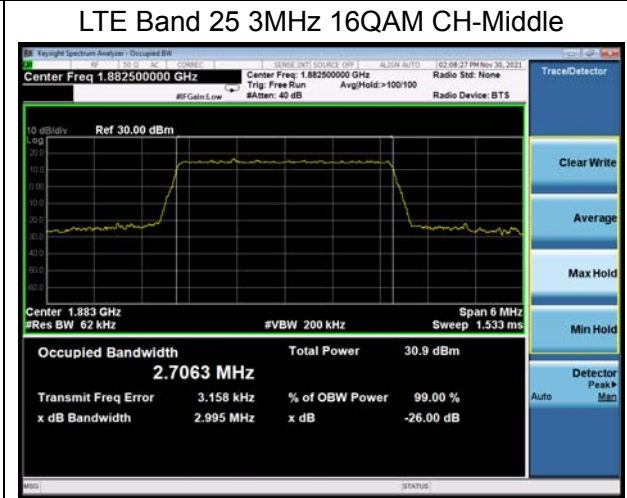
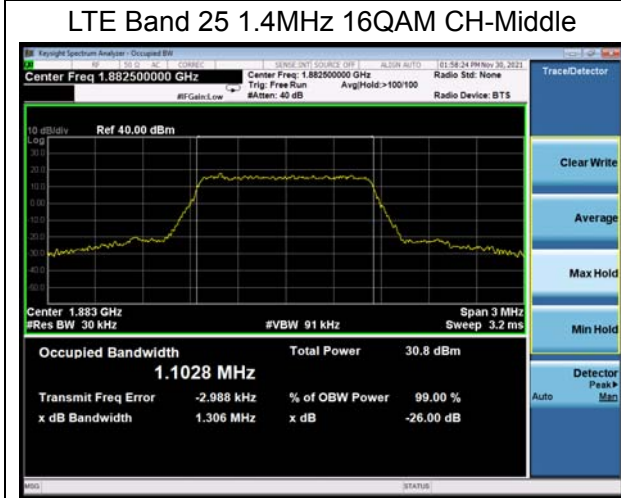
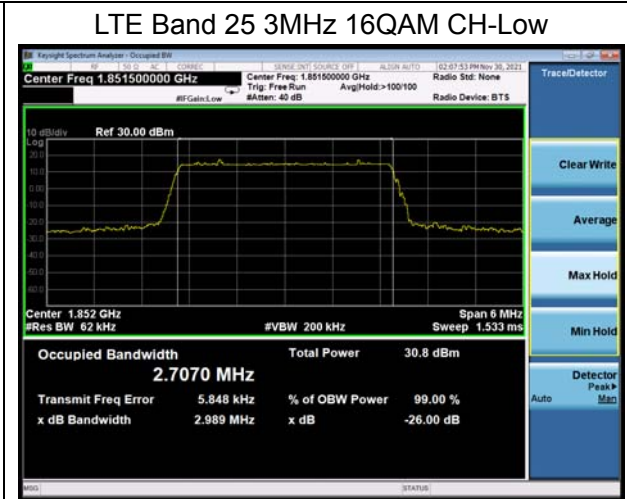
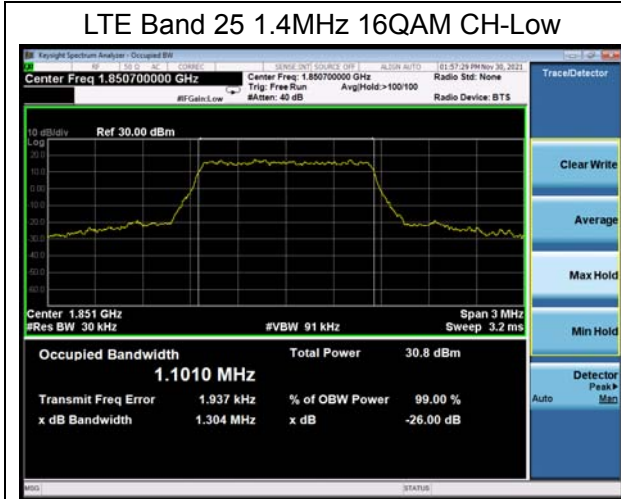

### LTE Band 25 5MHz 16QAM CH-Low



### LTE Band 25 5MHz 16QAM CH-Middle



### LTE Band 25 5MHz 16QAM CH-High



### 5.3. Band Edge Compliance

#### Ambient condition

Temperature	Relative humidity	Pressure
23°C ~25°C	45%~50%	101.5kPa

#### Method of Measurement

The EUT was connected to Spectrum Analyzer and Base Station Simulator via power Splitter. The band edge of the lowest and highest channels were measured. The Average detector is used and RBW is set to 15kHz, VBW is set to 43kHz for LTE Band 25(1.4MHz), RBW is set to 30kHz,VBW is set to 91kHz for LTE Band 25 (3MHz), RBW is set to 51kHz,VBW is set to 150kHz for LTE Band 25 (5MHz), RBW is set to 100kHz,VBW is set to 300kHz for LTE Band 25(10MHz), RBW is set to 150kHz,VBW is set to 470kHz for LTE Band 25(15MHz), RBW is set to 200kHz,VBW is set to 620kHz for LTE Band 25(20MHz). Spectrum analyzer plots are included on the following pages.

#### Test Setup

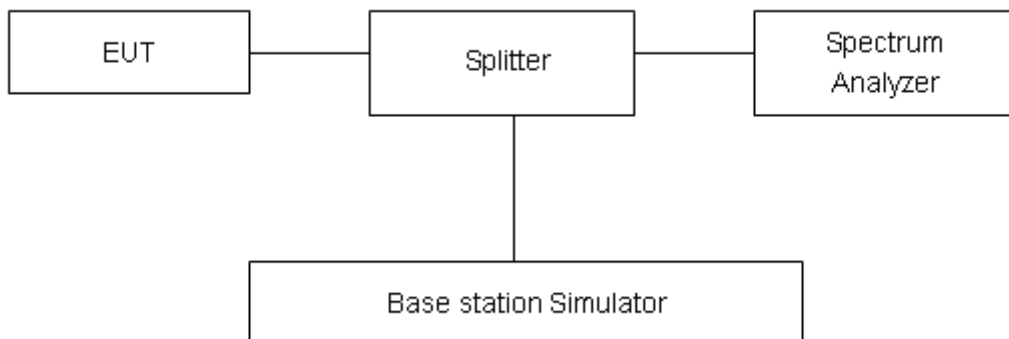

#### Limits

Rule Part 24.238(a) specifies that “on any frequency outside a licensee's frequency block, the power of any emission shall be attenuated below the transmitter power (P) by at least 43 + 10 log10 (P) dB.”

Limit	-13 dBm
-------	---------

#### Measurement Uncertainty

The assessed measurement uncertainty to ensure 95% confidence level for the normal distribution is with the coverage factor  $k = 1.96$ ,  $U=0.684$ dB.





Test Result:

LTE Band 25 1.4MHz QPSK 1RB CH-Low



LTE Band 25 1.4MHz QPSK 1RB CH-High



LTE Band 25 1.4MHz QPSK 100%RB CH-Low



LTE Band 25 1.4MHz QPSK 100%RB CH-High

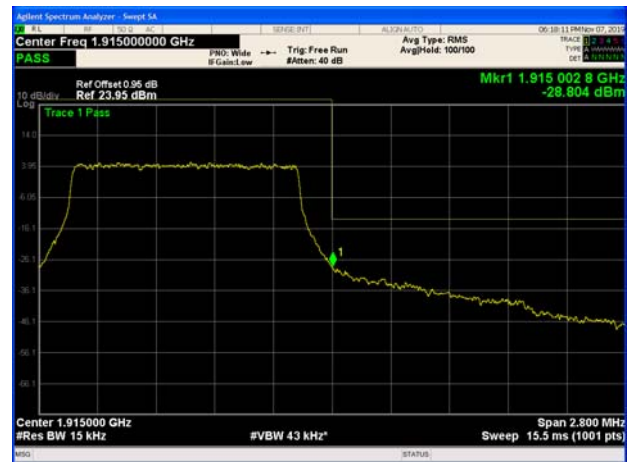

LTE Band 25 3MHz QPSK 1RB CH-Low

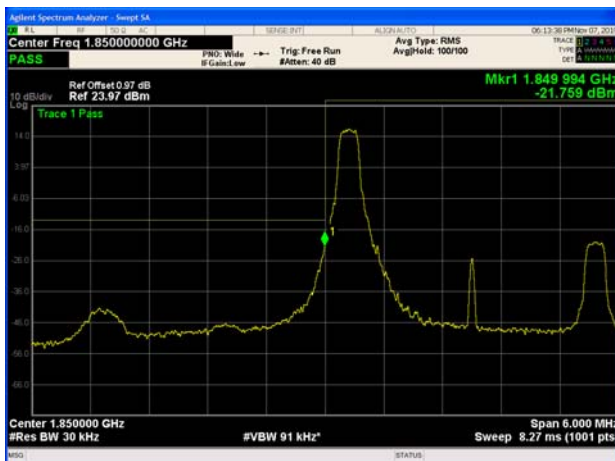

LTE Band 25 3MHz QPSK 1RB CH-High

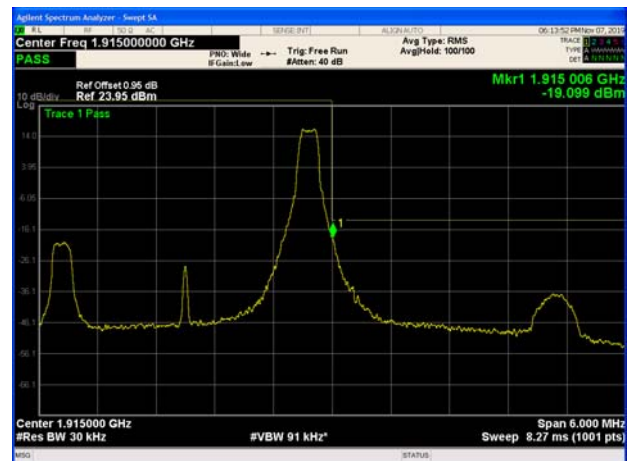



LTE Band 25 3MHz QPSK 100%RB CH-Low



LTE Band 25 3MHz QPSK 100%RB CH-High



LTE Band 25 5MHz QPSK 1RB CH-Low

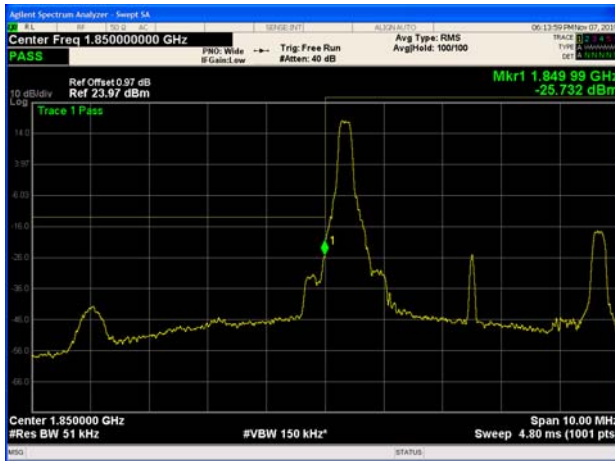

LTE Band 25 5MHz QPSK 1RB CH-High

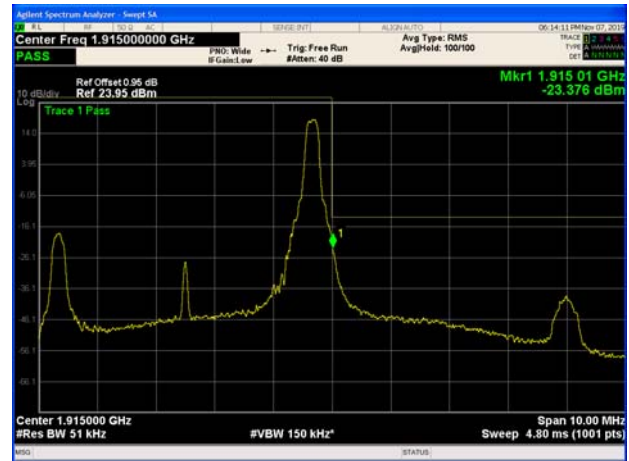

LTE Band 25 5MHz QPSK 100%RB CH-Low



LTE Band 25 5MHz QPSK 100%RB CH-High

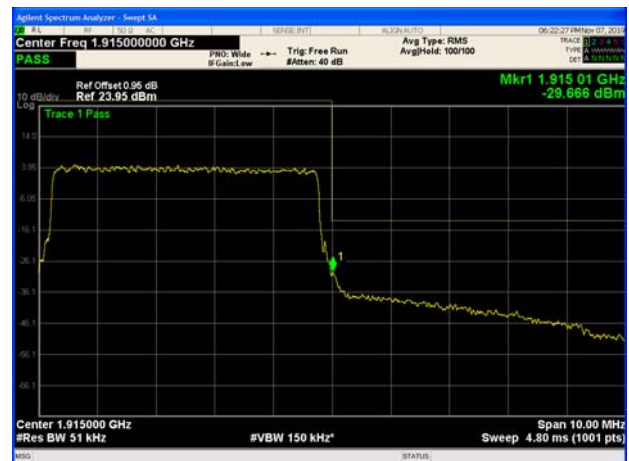



### LTE Band 25 10MHz QPSK 1RB CH-Low

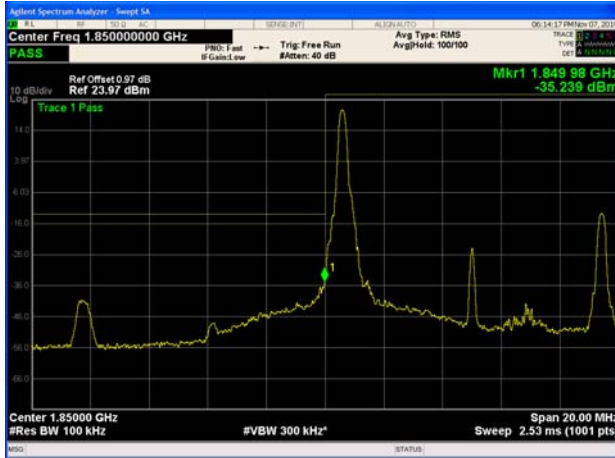

### LTE Band 25 10MHz QPSK 1RB CH-High

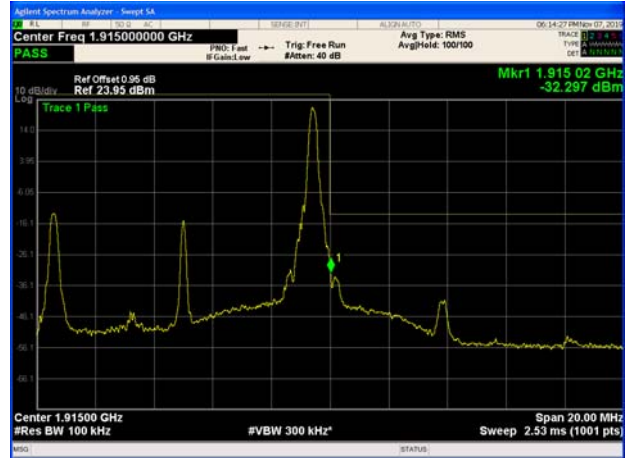

### LTE Band 25 10MHz QPSK 100%RB CH-Low



### LTE Band 25 10MHz QPSK 100%RB CH-High



### LTE Band 25 15MHz QPSK 1RB CH-Low

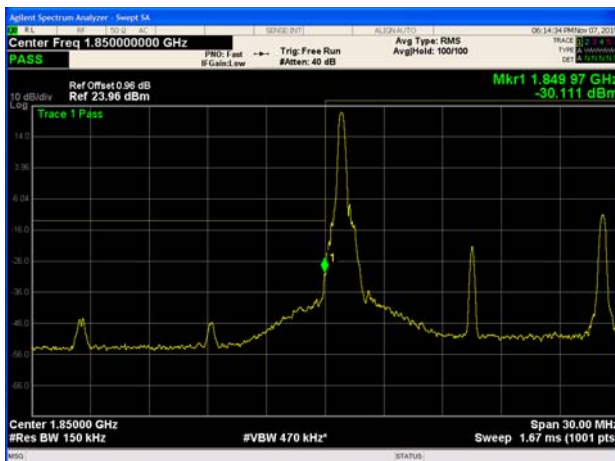

### LTE Band 25 15MHz QPSK 1RB CH-High

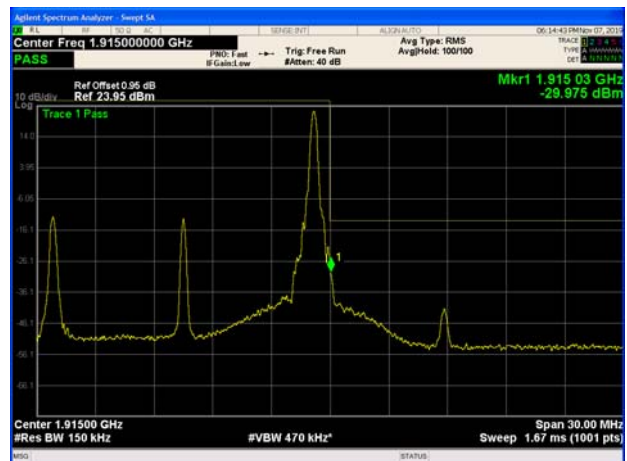



LTE Band 25 15MHz QPSK 100%RB CH-Low



LTE Band 25 15MHz QPSK 100%RB CH-High



LTE Band 25 20MHz QPSK 1RB CH-Low

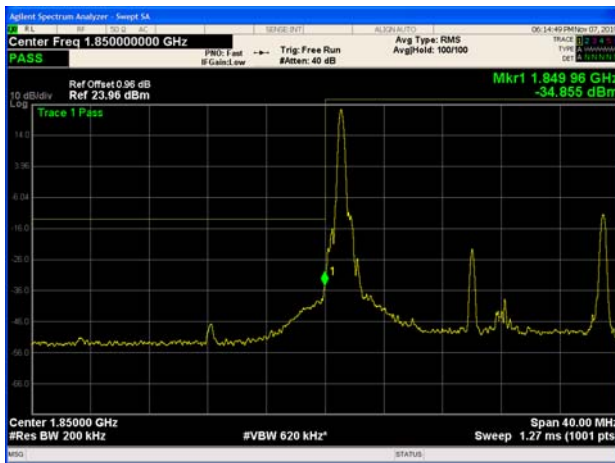

LTE Band 25 20MHz QPSK 1RB CH-High

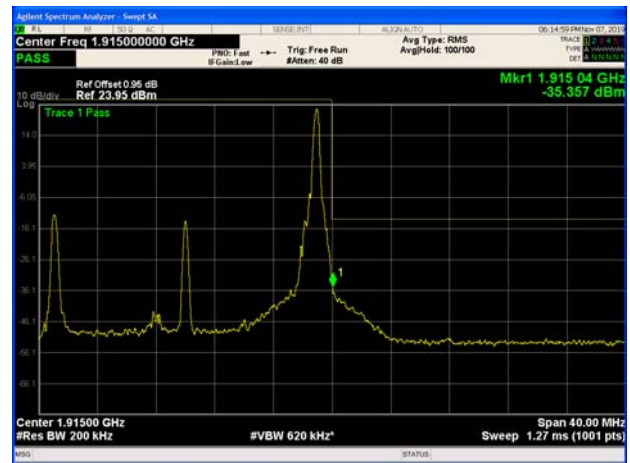

LTE Band 25 20MHz QPSK 100%RB CH-Low

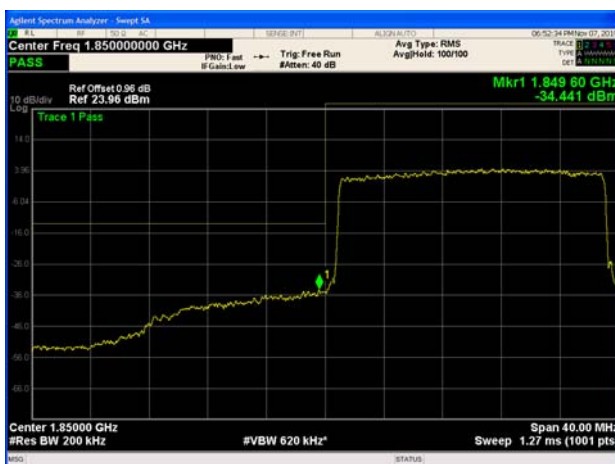

LTE Band 25 20MHz QPSK 100%RB CH-High

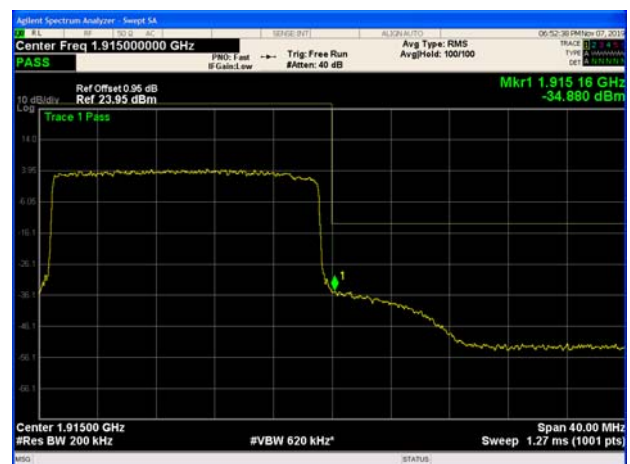



### LTE Band 25 1.4MHz 16QAM 1RB CH-Low



### LTE Band 25 1.4MHz 16QAM 1RB CH-High



### LTE Band 25 1.4MHz 16QAM 100%RB CH-Low



### LTE Band 25 1.4MHz 16QAM 100%RB CH-High



### LTE Band 25 3MHz 16QAM 1RB CH-Low

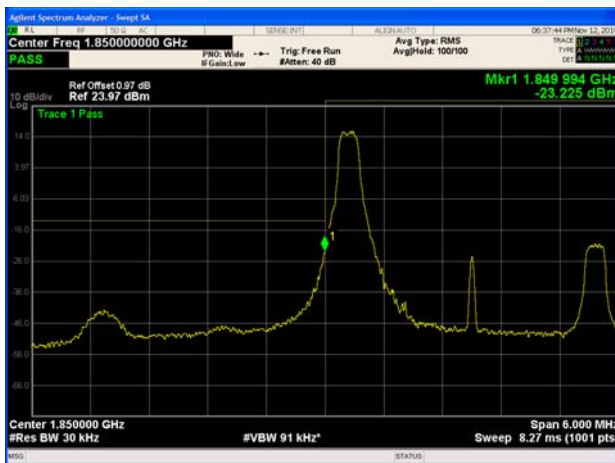

### LTE Band 25 3MHz 16QAM 1RB CH-High

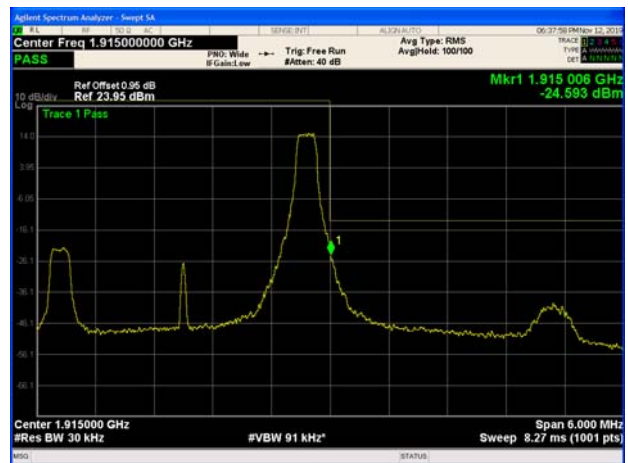



LTE Band 25 3MHz 16QAM 100%RB CH-Low



LTE Band 25 3MHz 16QAM 100%RB CH-High

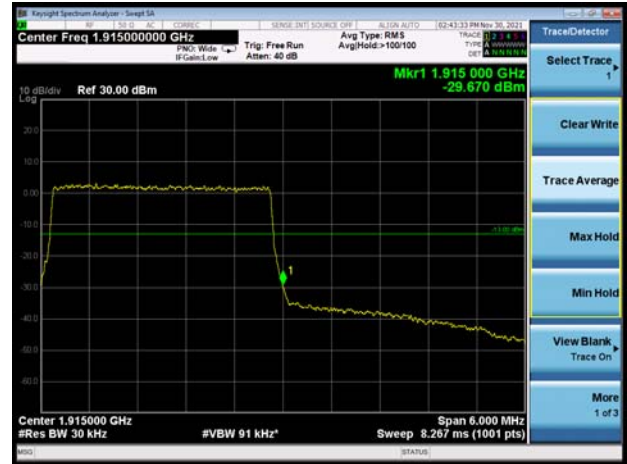

LTE Band 25 5MHz 16QAM 1RB CH-Low

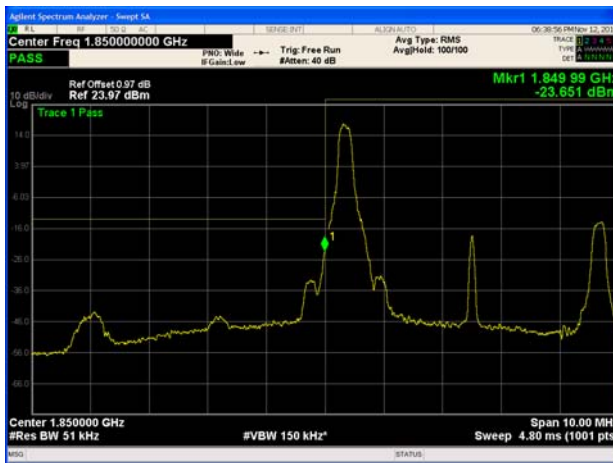

LTE Band 25 5MHz 16QAM 1RB CH-High

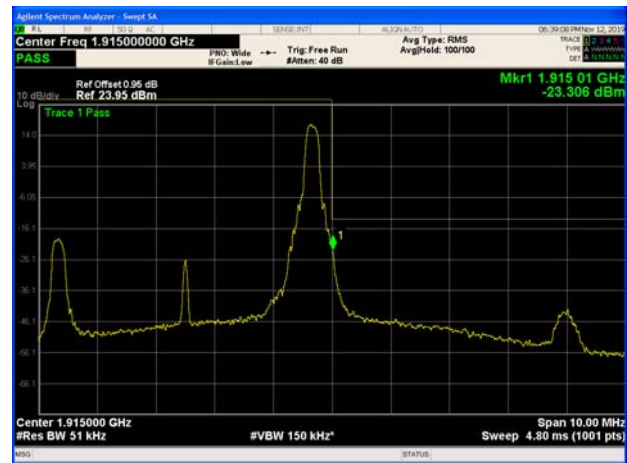

LTE Band 25 5MHz 16QAM 100%RB CH-Low

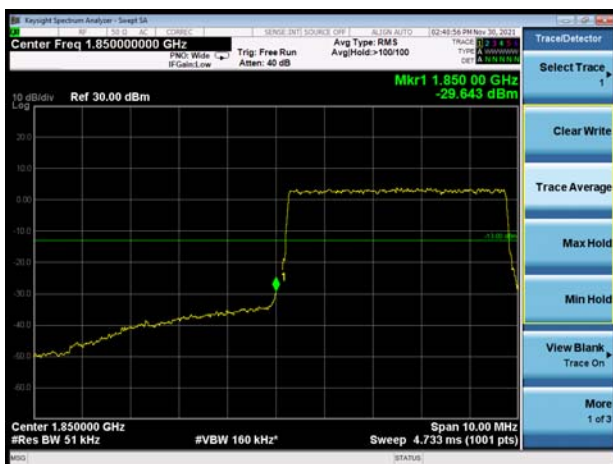

LTE Band 25 5MHz 16QAM 100%RB CH-High





LTE Band 25 10MHz 16QAM 1RB CH-Low

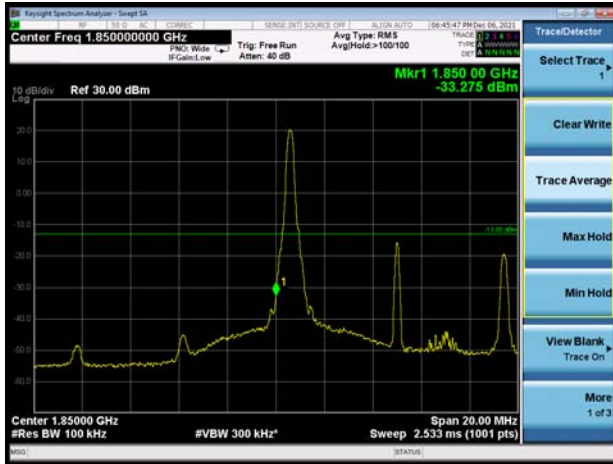

LTE Band 25 10MHz 16QAM 1RB CH-High

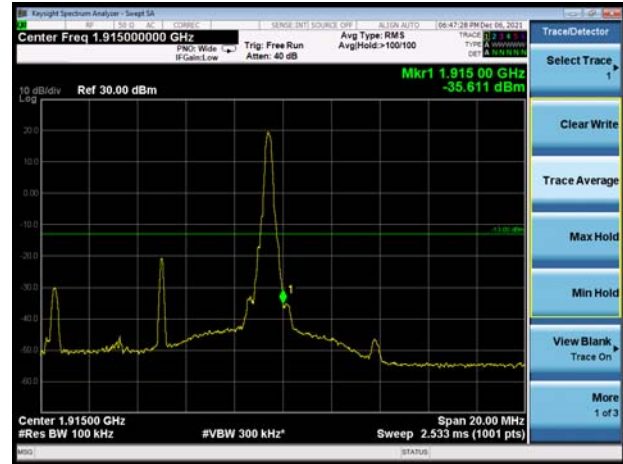

LTE Band 25 15MHz 16QAM 1RB CH-Low

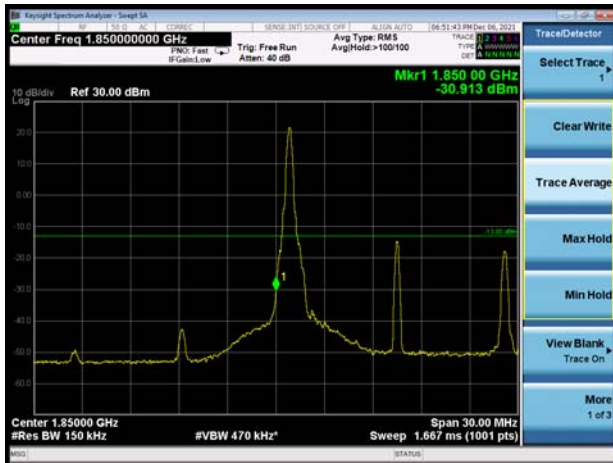

LTE Band 25 15MHz 16QAM 1RB CH-High

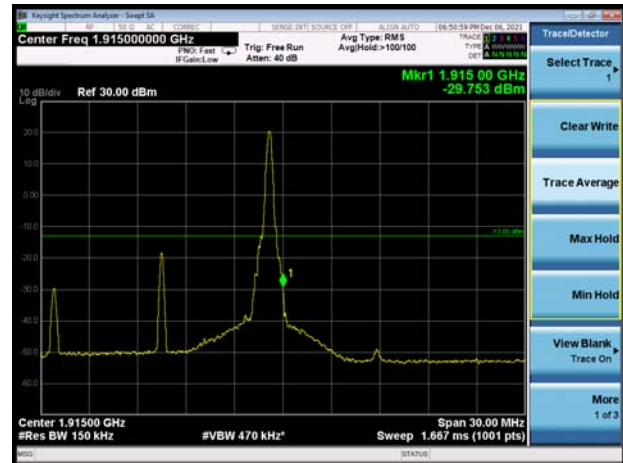

LTE Band 25 20MHz 16QAM 1RB CH-Low

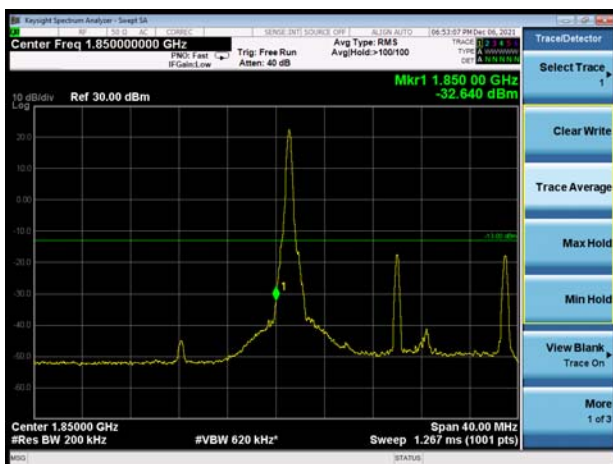

LTE Band 25 20MHz 16QAM 1RB CH-High

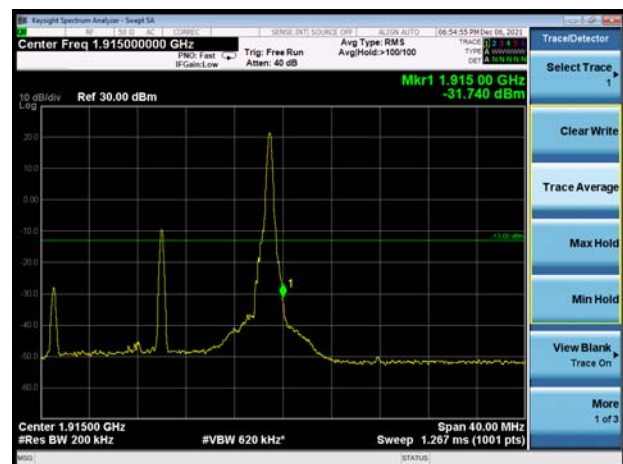

### 5.4. Peak-to-Average Power Ratio (PAPR)

#### Ambient condition

Temperature	Relative humidity	Pressure
23°C ~25°C	45%~50%	101.5kPa

#### Methods of Measurement

Measure the total peak power and record as PPK. And measure the total average power and record as PAvg. Both the peak and average power levels must be expressed in the same logarithmic units (e.g., dBm). Determine the PAPR from:

$$PAPR (dB) = PPK (dBm) - PAvg (dBm).$$

#### Test Setup

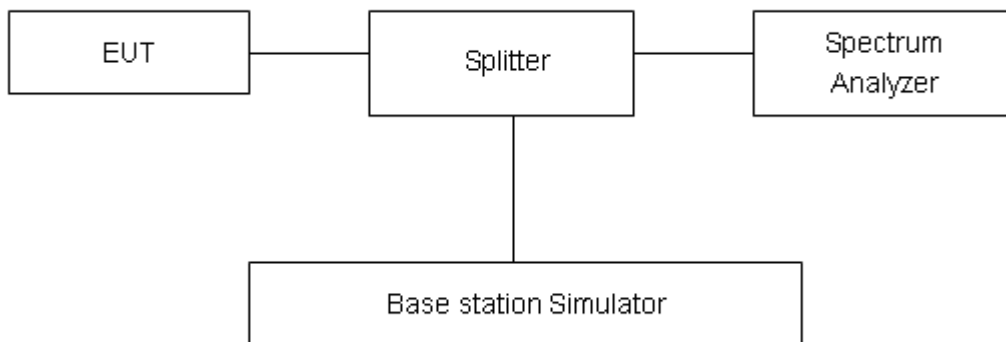

#### Limits

In measuring transmissions in this band using an average power technique, the peak-to-average ratio (PAR) of the transmission may not exceed 13 dB in 24.232(d).

#### Measurement Uncertainty

The assessed measurement uncertainty to ensure 95% confidence level for the normal distribution is with the coverage factor  $k = 2$ ,  $U = 0.4$  dB.



**Test Results**

LTE Band 25								
Modulation	Bandwidth (MHz)	Channel	Frequency (MHz)	Peak (dBm)	Avg (dBm)	PAPR (dB)	Limit (dB)	Conclusion
QPSK	1.4	26047	1850.7	27.76	22.18	5.58	≤13	PASS
		26365	1882.5	28.06	22.38	5.68	≤13	PASS
		26683	1914.3	27.05	22.19	4.86	≤13	PASS
	3	26055	1851.5	27.87	22.18	5.69	≤13	PASS
		26365	1882.5	28.16	22.40	5.76	≤13	PASS
		26675	1913.5	27.21	22.39	4.82	≤13	PASS
	5	26065	1852.5	27.92	22.24	5.68	≤13	PASS
		26365	1882.5	28.11	22.42	5.69	≤13	PASS
		26665	1912.5	27.22	22.31	4.91	≤13	PASS
	10	26090	1855	27.99	22.41	5.58	≤13	PASS
		26365	1882.5	28.31	22.63	5.68	≤13	PASS
		26640	1910	27.59	22.58	5.01	≤13	PASS
	15	26115	1857.5	28.02	22.43	5.59	≤13	PASS
		26365	1882.5	28.31	22.56	5.75	≤13	PASS
		26615	1907.5	27.84	22.55	5.29	≤13	PASS
	20	26140	1860	27.64	22.41	5.23	≤13	PASS
		26365	1882.5	28.05	22.57	5.48	≤13	PASS
		26590	1905	27.72	22.49	5.23	≤13	PASS
16QAM	1.4	26047	1850.7	28.23	21.99	6.24	≤13	PASS
		26365	1882.5	27.48	21.20	6.28	≤13	PASS
		26683	1914.3	26.75	21.01	5.74	≤13	PASS
	3	26055	1851.5	28.20	21.88	6.32	≤13	PASS
		26365	1882.5	28.61	22.26	6.35	≤13	PASS
		26675	1913.5	26.93	21.23	5.70	≤13	PASS
	5	26065	1852.5	28.11	21.80	6.31	≤13	PASS
		26365	1882.5	28.62	22.30	6.32	≤13	PASS
		26665	1912.5	26.97	21.28	5.69	≤13	PASS

## 5.5. Frequency Stability

### Ambient condition

Temperature	Relative humidity	Pressure
23°C ~25°C	45%~50%	101.5kPa

### Method of Measurement

#### Frequency Stability (Temperature Variation)

The temperature inside the climate chamber is varied from -40°C to +85°C in 10°C step size,

(1) With all power removed, the temperature was decreased to 0°C and permitted to stabilize for three hours.

(2) Measure the carrier frequency with the test equipment in a “call mode”. These measurements should be made within 1 minute of powering up the mobile station, to prevent significant self warming.

(3) Repeat the above measurements at 10°C increments from -40°C to +85°C. Allow at least 1.5 hours at each temperature, un-powered, before making measurements.

#### Frequency Stability (Voltage Variation)

The frequency stability shall be measured with variation of primary supply voltage as follows:

(1) Vary primary supply voltage from 85 to 115 percent of the nominal value for other than hand carried battery equipment.

(2) For hand carried, battery powered equipment, reduce primary supply voltage to the battery-operating end point which shall be specified by the manufacturer.

This transceiver is specified to operate with an input voltage of between 3.3 V and 4.3 V, with a nominal voltage of 3.8V.

### Test setup

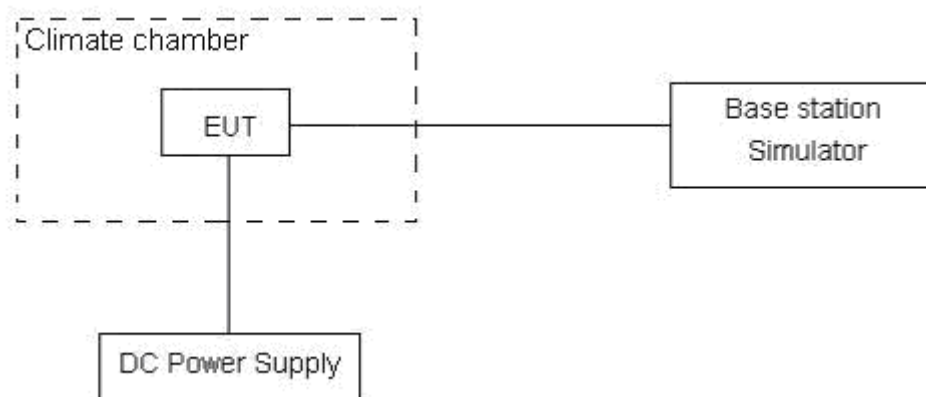

**Limits**

The frequency stability shall be sufficient to ensure that the fundamental emission stays within the authorized frequency block

**Measurement Uncertainty**

The assessed measurement uncertainty to ensure 99.75% confidence level for the normal distribution is with the coverage factor  $k = 3$ ,  $U = 0.01\text{ppm}$ .

**Test Result**

LTE Band 25						
Condition		Freq.Error (Hz)	Freq.Error (Hz)	Frequency Stability (ppm)	Frequency Stability (ppm)	Verdict
BANDWIDTH	20MHz	16QAM	QPSK	16QAM	QPSK	
Temperature	Voltage	16QAM	QPSK	16QAM	QPSK	
Normal (25°C)	Normal	13.84	9.21	0.00736	0.00490	PASS
Extreme (85°C)		5.88	15.86	0.00313	0.00844	PASS
Extreme (80°C)		4.57	3.21	0.00243	0.00171	PASS
Extreme (70°C)		4.03	9.03	0.00214	0.00480	PASS
Extreme (60°C)		8.40	12.85	0.00447	0.00684	PASS
Extreme (50°C)		6.44	6.55	0.00343	0.00348	PASS
Extreme (40°C)		6.92	17.13	0.00368	0.00911	PASS
Extreme (30°C)		6.84	16.82	0.00364	0.00895	PASS
Extreme (20°C)		16.64	9.39	0.00885	0.00499	PASS
Extreme (10°C)		9.09	8.24	0.00484	0.00438	PASS
Extreme (0°C)		3.78	16.57	0.00201	0.00882	PASS
Extreme (-10°C)		9.59	5.40	0.00510	0.00287	PASS
Extreme (-20°C)		17.88	16.96	0.00951	0.00902	PASS
Extreme (-30°C)		8.76	11.17	0.00466	0.00594	PASS
Extreme (-40°C)		17.69	3.30	0.00941	0.00176	PASS
25°C	LV	17.48	12.88	0.00930	0.00685	PASS
	HV	5.14	3.09	0.00273	0.00164	PASS

## 5.6. Spurious Emissions at Antenna Terminals

### Ambient condition

Temperature	Relative humidity	Pressure
23°C ~25°C	45%~50%	101.5kPa

### Method of Measurement

The EUT was connected to Spectrum Analyzer and Base Station Simulator via power Splitter. The measurement is carried out using a spectrum analyzer. The spectrum analyzer scans from 9kHz to the 10th harmonic of the carrier. The peak detector is used.

RBW is set to 100kHz, VBW is set to 300kHz for 30MHz~1GHz

RBW is set to 1MHz, VBW is set to 3MHz for above 1GHz, Sweep is set to ATUO.

The modulation mode and RB allocation refer to section 5.1, using the maximum output power configuration.

### Test setup

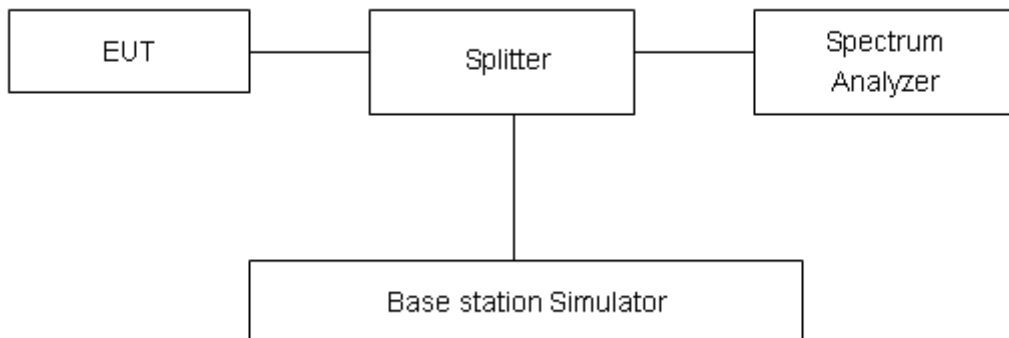

### Limits

Rule Part 24.238(a) specifies that “on any frequency outside a licensee's frequency block, the power of any emission shall be attenuated below the transmitter power (P) by at least 43 + 10 log<sub>10</sub> (P) dB.”

Limit	-13 dBm
-------	---------

### Measurement Uncertainty

The assessed measurement uncertainty to ensure 99.75% confidence level for the normal distribution is with the coverage factor  $k = 1.96$ .

Frequency	Uncertainty
9kHz-1GHz	0.684 dB
1GHz-20GHz	1.407 dB

**Test Result**

Sweep the whole frequency band through the range from 9kHz to the 10th harmonic of the carrier, the emissions more than 20 dB below the limit are not reported.

The signal beyond the limit is carrier.

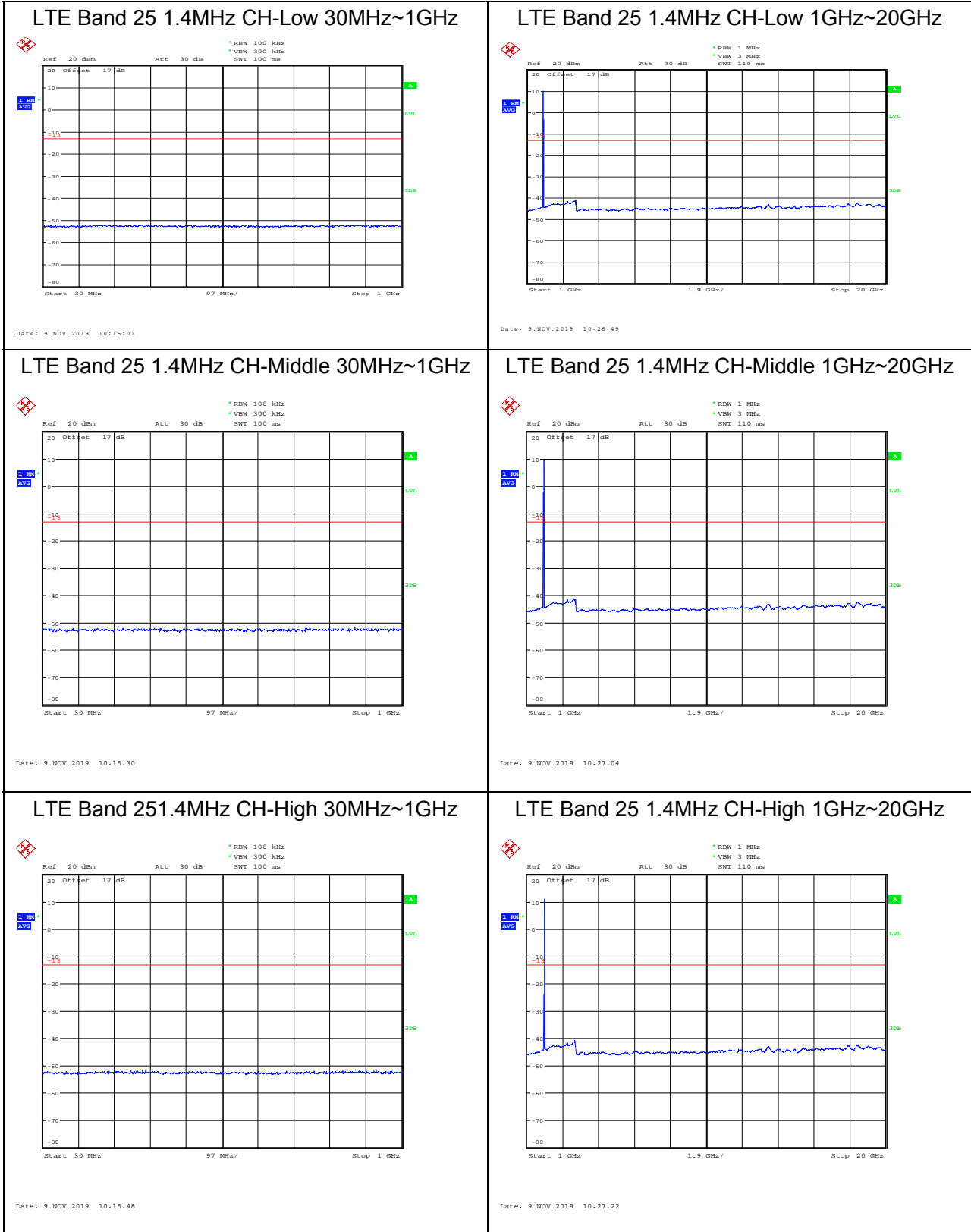



### LTE Band 25 3MHz CH-Low 30MHz~1GHz

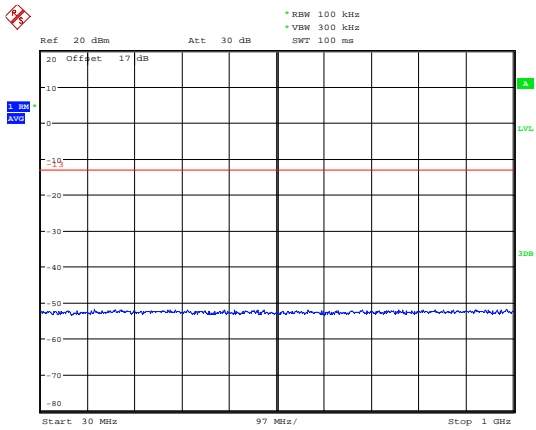

Date: 9.NOV.2019 10:18:22

### LTE Band 25 3MHz CH-Low 1GHz~20GHz

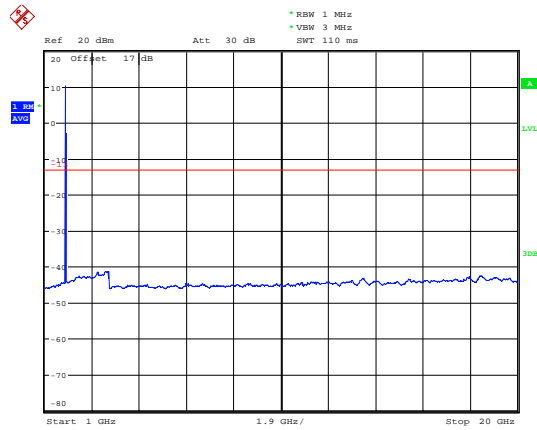

Date: 9.NOV.2019 10:28:31

### LTE Band 25 3MHz CH-Middle 30MHz~1GHz

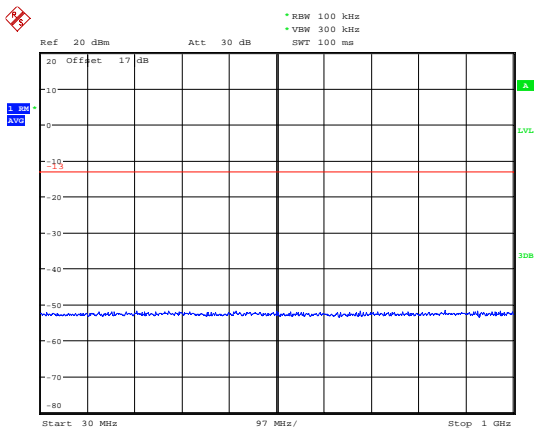

Date: 9.NOV.2019 10:18:39

### LTE Band 25 3MHz CH-Middle 1GHz~20GHz

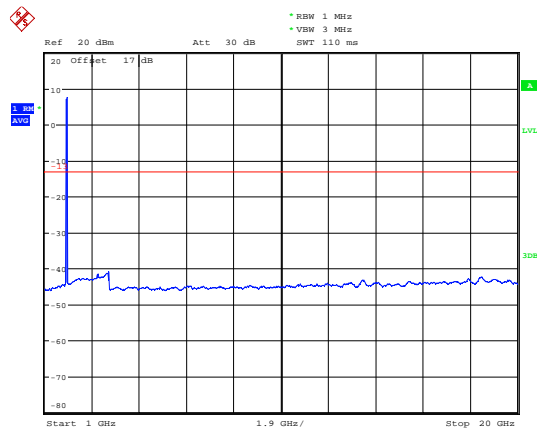

Date: 9.NOV.2019 10:28:47

### LTE Band 25 3MHz CH-High 30MHz~1GHz

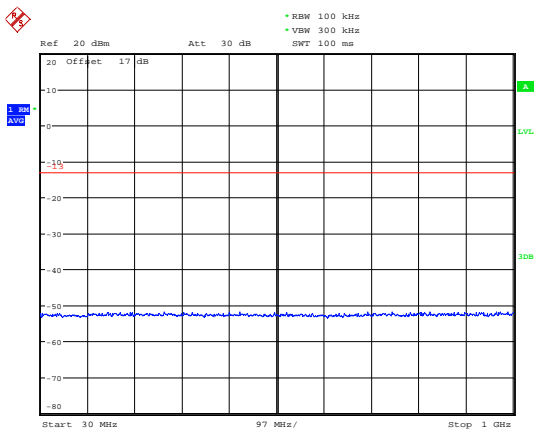

Date: 9.NOV.2019 10:18:58

### LTE Band 25 3MHz CH-High 1GHz~20GHz

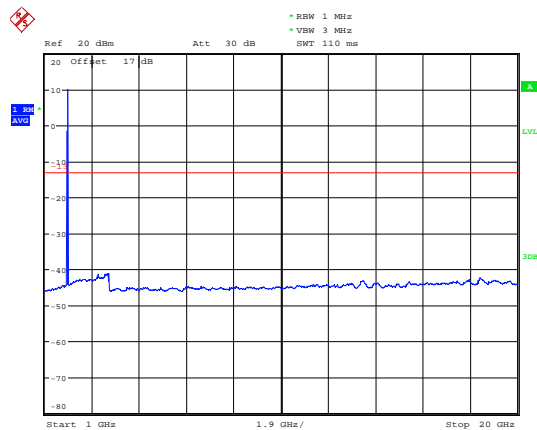

Date: 9.NOV.2019 10:29:04



### LTE Band 25 5MHz CH-Low 30MHz~1GHz

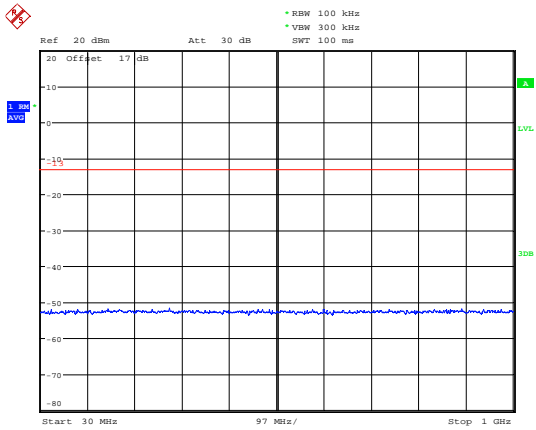

Date: 9.NOV.2019 10:20:29

### LTE Band 25 5MHz CH-Low 1GHz~20GHz

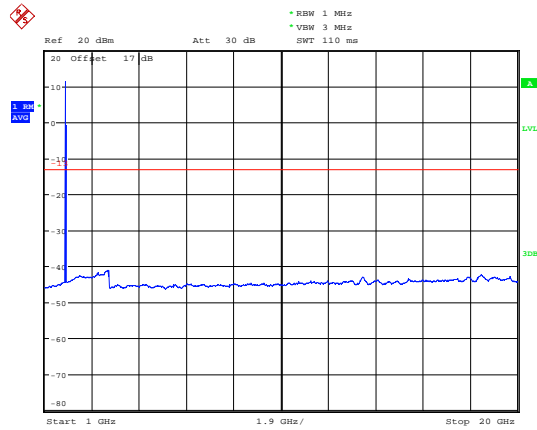

Date: 9.NOV.2019 10:29:32

### LTE Band 25 5MHz CH-Middle 30MHz~1GHz

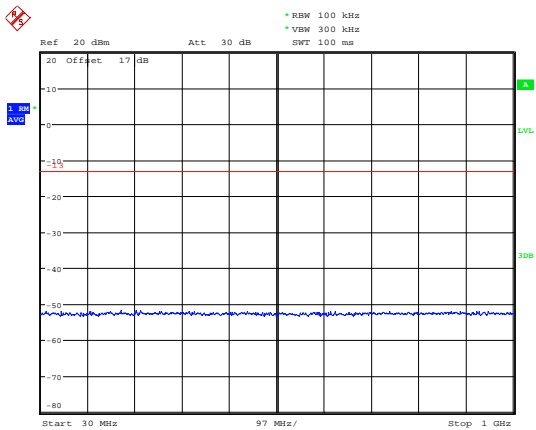

Date: 9.NOV.2019 10:20:48

### LTE Band 25 5MHz CH-Middle 1GHz~20GHz

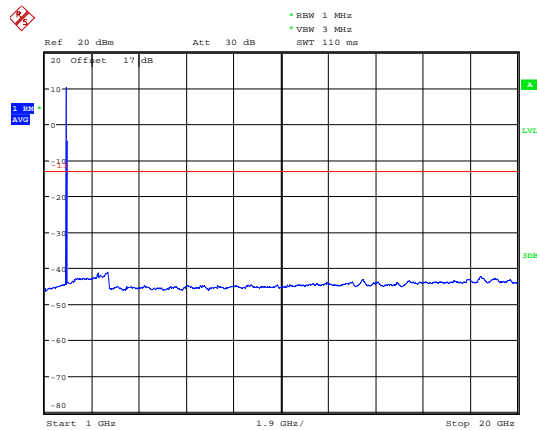

Date: 9.NOV.2019 10:29:47

### LTE Band 25 5MHz CH-High 30MHz~1GHz

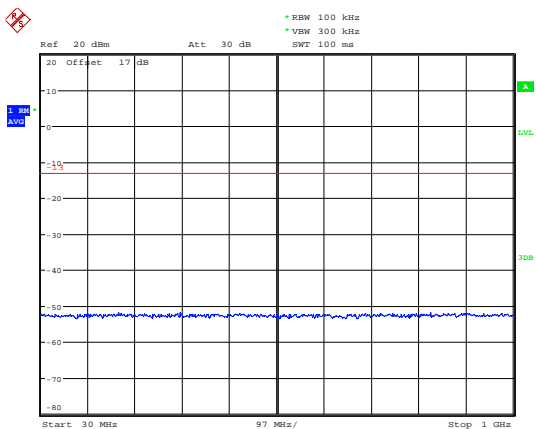

Date: 9.NOV.2019 10:21:06

### LTE Band 25 5MHz CH-High 1GHz~20GHz

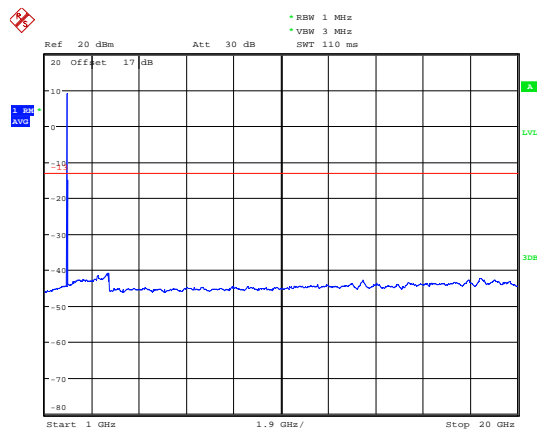

Date: 9.NOV.2019 10:30:05





### LTE Band 25 10MHz CH-Low 30MHz~1GHz

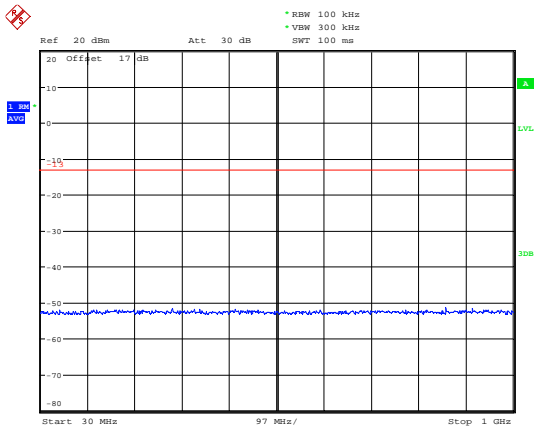

Date: 9.NOV.2019 10:21:43

### LTE Band 25 10MHz CH-Low 1GHz~20GHz

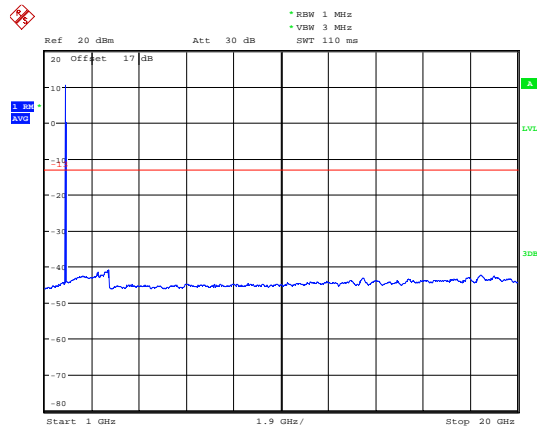

Date: 9.NOV.2019 10:30:30

### LTE Band 25 10MHz CH-Middle 30MHz~1GHz

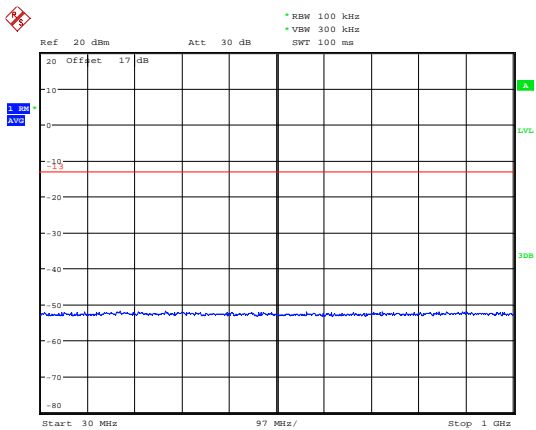

Date: 9.NOV.2019 10:22:01

### LTE Band 25 10MHz CH-Middle 1GHz~20GHz

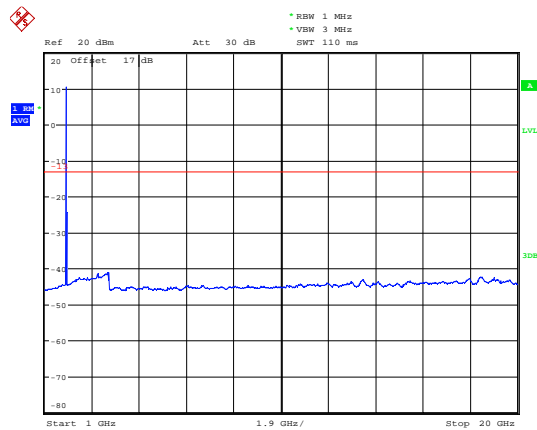

Date: 9.NOV.2019 10:30:43

### LTE Band 25 10MHz CH-High 30MHz~1GHz

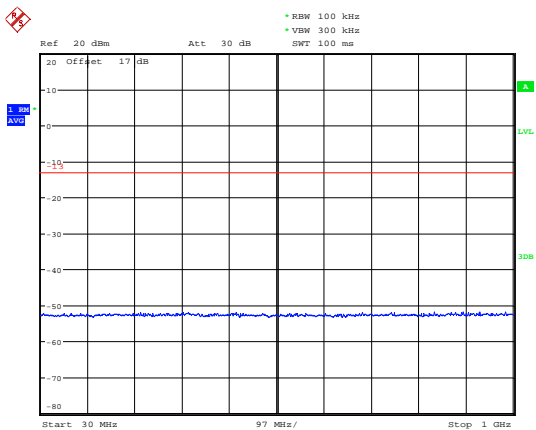

Date: 9.NOV.2019 10:22:52

### LTE Band 25 10MHz CH-High 1GHz~20GHz

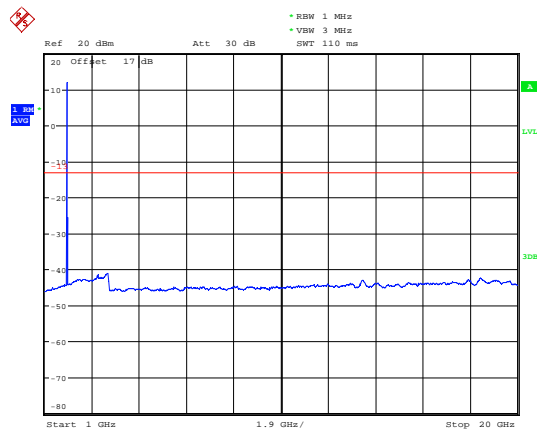

Date: 9.NOV.2019 10:30:59



### LTE Band 25 15MHz CH-Low 30MHz~1GHz

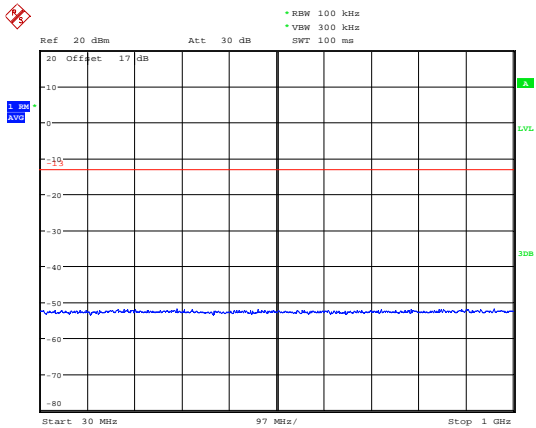

Date: 9.NOV.2019 10:23:45

### LTE Band 25 15MHz CH-Low 1GHz~20GHz

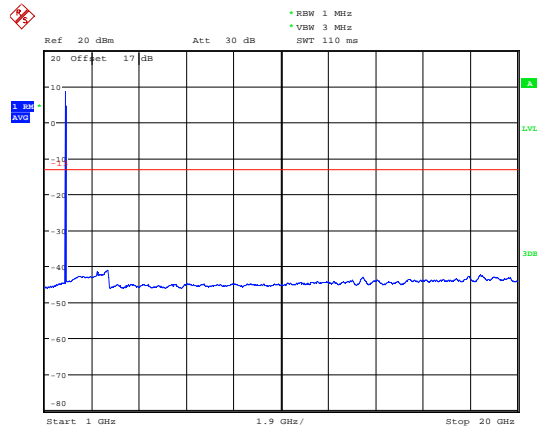

Date: 9.NOV.2019 10:31:26

### LTE Band 25 15MHz CH-Middle 30MHz~1GHz

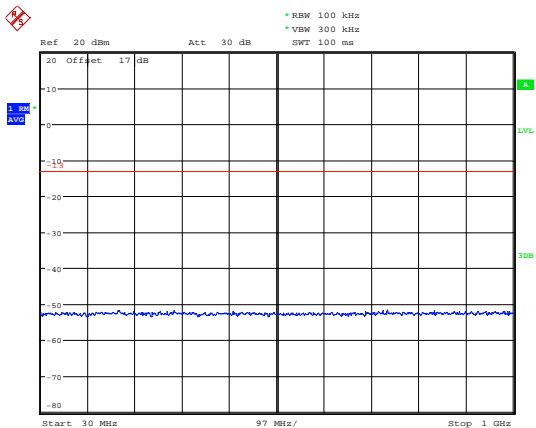

Date: 9.NOV.2019 10:24:00

### LTE Band 25 15MHz CH-Middle 1GHz~20GHz

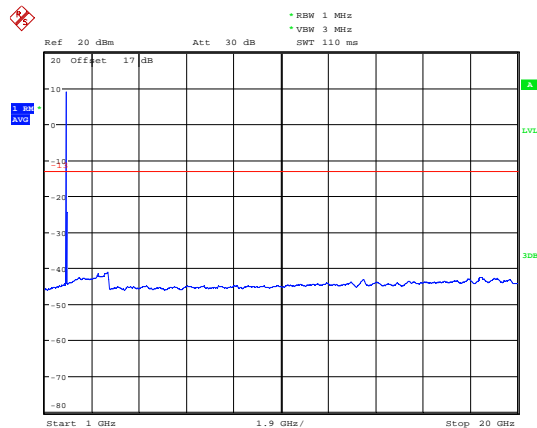

Date: 9.NOV.2019 10:31:51

### LTE Band 25 15MHz CH-High 30MHz~1GHz

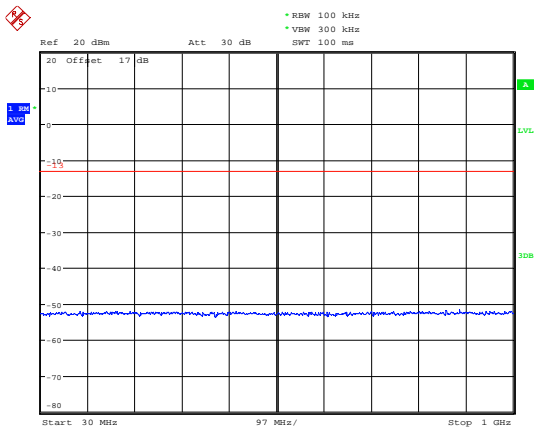

Date: 9.NOV.2019 10:24:18

### LTE Band 25 15MHz CH-High 1GHz~20GHz

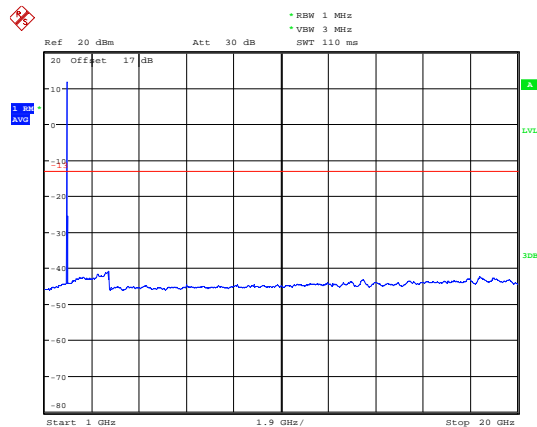

Date: 9.NOV.2019 10:32:08



### LTE Band 25 20MHz CH-Low 30MHz~1GHz

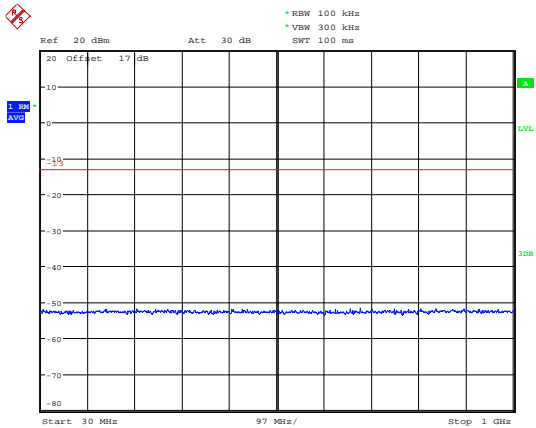

Date: 9.NOV.2019 10:24:59

### LTE Band 25 20MHz CH-Low 1GHz~20GHz

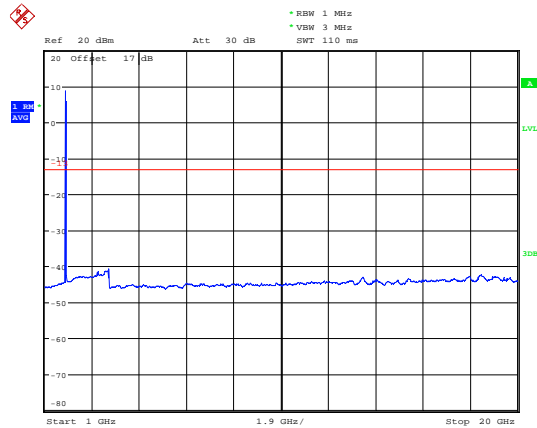

Date: 9.NOV.2019 10:32:32

### LTE Band 25 20MHz CH-Middle 30MHz~1GHz

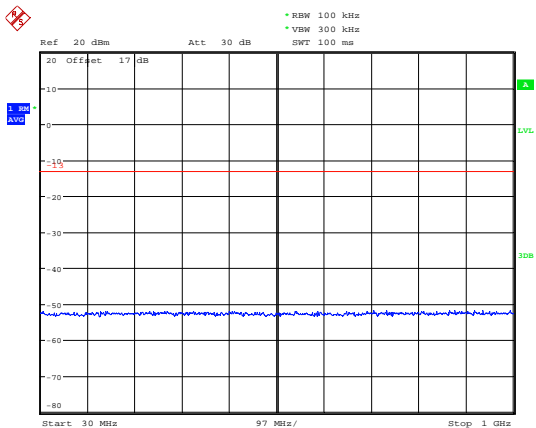

Date: 9.NOV.2019 10:25:15

### LTE Band 25 20MHz CH-Middle 1GHz~20GHz

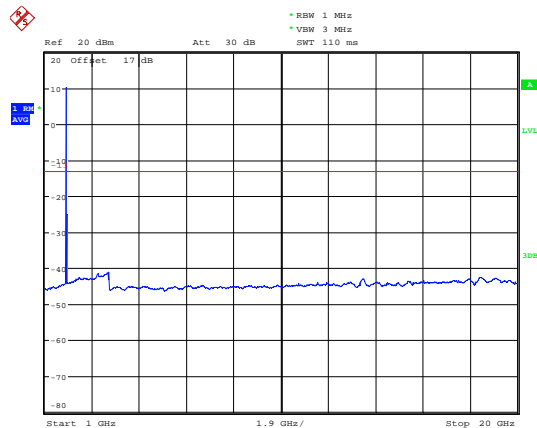

Date: 9.NOV.2019 10:32:45

### LTE Band 25 20MHz CH-High 30MHz~1GHz

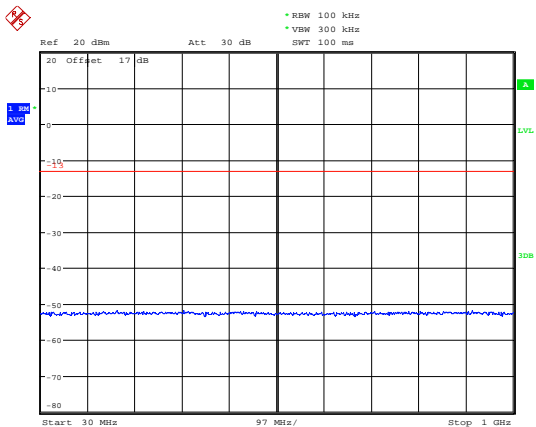

Date: 9.NOV.2019 10:25:58

### LTE Band 25 20MHz CH-High 1GHz~20GHz

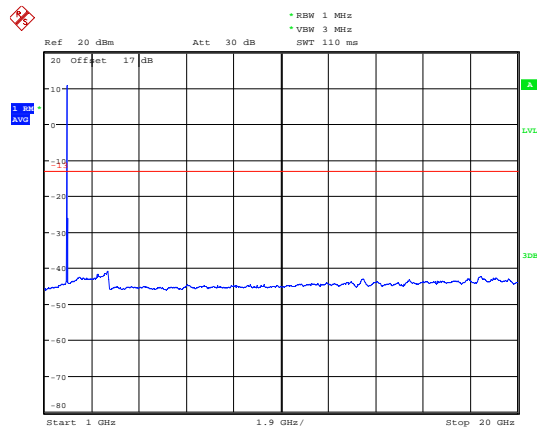

Date: 9.NOV.2019 10:33:01

## 5.7. Radiates Spurious Emission

### Ambient condition

Temperature	Relative humidity	Pressure
23°C ~25°C	45%~50%	101.5kPa

### Method of Measurement

1. The testing follows FCC KDB 971168 v03r01 Section 5.8 and ANSI C63.26 (2015).
2. Below 1GHz: The EUT is placed on a turntable 0.8 meters above the ground in the chamber, 3 meter away from the antenna. The maximal emission value is acquired by adjusting the antenna height, polarisation and turntable azimuth. Normally, the height range of antenna is 1 m to 4 m, the azimuth range of turntable is 0° to 360°, and the receive antenna has two polarizations Vertical (V) and Horizontal (H). Above 1GHz: (Note: the FCC's permission to use 1.5m as an alternative per TCBC Conf call of Dec. 2, 2014.) The EUT is placed on a turntable 1.5 meters above the ground in the chamber, 3 meter away from the antenna. The maximal emission value is acquired by adjusting the antenna height, polarisation and turntable azimuth. Normally, the height range of antenna is 1 m to 4 m, the azimuth range of turntable is 0° to 360°, and the receive antenna has two polarizations Vertical (V) and Horizontal (H).
3. A loop antenna, A log-periodic antenna or horn antenna shall be substituted in place of the EUT. The log-periodic antenna will be driven by a signal generator and the level will be adjusted till the same power value on the spectrum analyzer or receiver. The level of the spurious emissions can be calculated through the level of the signal generator, cable loss, the gain of the substitution antenna and the reading of the spectrum analyzer or receiver.
4. The EUT is then put into continuously transmitting mode at its maximum power level during the test. Set Test Receiver or Spectrum RBW=1MHz, VBW=3MHz, and the maximum value of the receiver should be recorded as (Pr).
5. The EUT shall be replaced by a substitution antenna. In the chamber, an substitution antenna for the frequency band of interest is placed at the reference point of the chamber. An RF Signal source for the frequency band of interest is connected to the substitution antenna with a cable that has been constructed to not interfere with the radiation pattern of the antenna. A power (PMea) is applied to the input of the substitution antenna, and adjust the level of the signal generator output until the value of the receiver reach the previously recorded (Pr). The power of signal source (PMea) is recorded. The test should be performed by rotating the test item and adjusting the receiving antenna polarization.
6. A amplifier should be connected to the Signal Source output port. And the cable should be connect between the Amplifier and the Substitution Antenna. The cable loss (Pcl) ,the Substitution Antenna Gain (Ga) and the Amplifier Gain (PAg) should be recorded after test.
7. The measurement results are obtained as described below:  
 $Power(EIRP)=PMea- PAg - Pcl + Ga$   
 The measurement results are amend as described below:  
 $Power(EIRP)=PMea- Pcl + Ga$
8. This value is EIRP since the measurement is calibrated using an antenna of known gain (2.15 dBi) and known input power. ERP can be calculated from EIRP by subtracting the gain of the dipole, ERP

= EIRP-2.15dBi.

The modulation mode and RB allocation refer to section 5.1, using the maximum output power configuration.

**Test setup**

**9KHz ~ 30MHz**

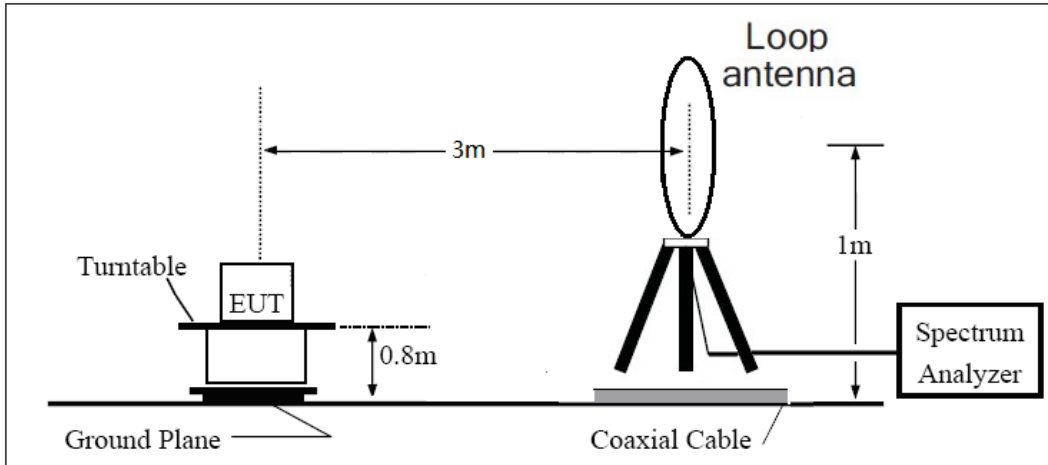

**30MHz ~ 1GHz**

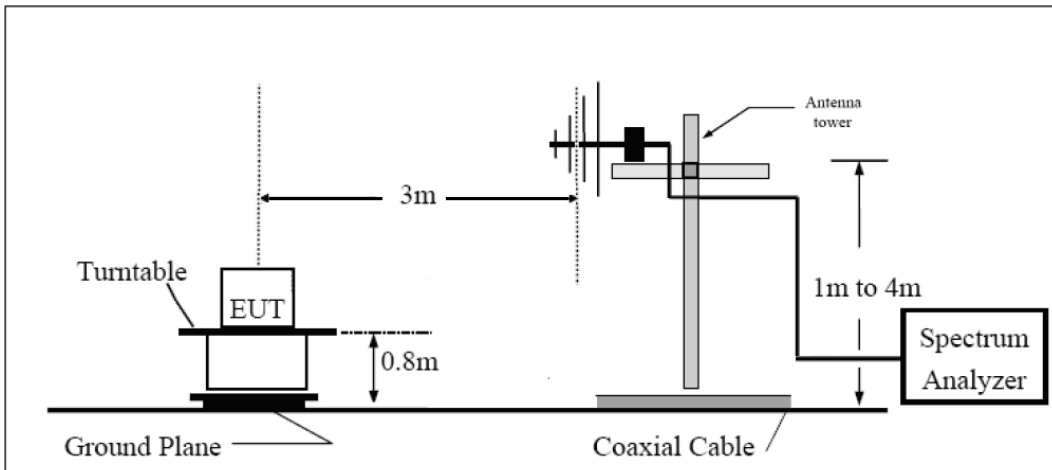

**Above 1GHz**

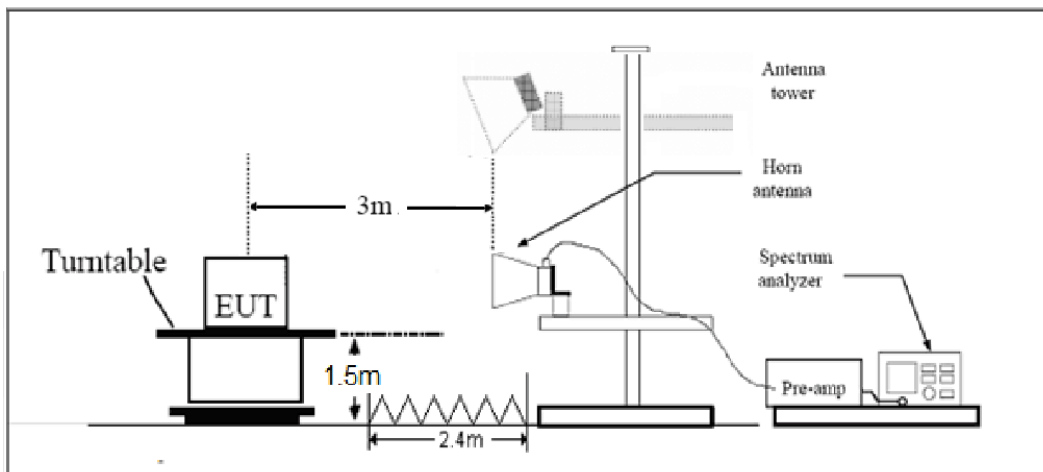

Note: Area side: 2.4mX3.6m

**Limits**

Rule Part 24.238(a) specifies that “on any frequency outside a licensee's frequency block, the power of any emission shall be attenuated below the transmitter power (P) by at least  $43 + 10 \log_{10}(P)$  dB.”

Limit	-13 dBm
-------	---------

**Measurement Uncertainty**

The assessed measurement uncertainty to ensure 95% confidence level for the normal distribution is with the coverage factor  $k = 1.96$ ,  $U = 3.55$  dB.

**Test Result**

Sweep the whole frequency band through the range from 9kHz to the 10th harmonic of the carrier, the emissions below the noise floor will not be recorded in the report.

LTE Band 25 1.4MHz CH-Middle

Harmonic	Frequency (MHz)	SG (dBm)	Cable Loss (dB)	Gain (dBi)	Antenna Polarization	EIRP Level (dBm)	Limit (dBm)	Margin (dB)	Azimuth (deg)
2	3765.0	-48.95	2.60	12.50	Horizontal	-39.05	-13.00	26.05	135
3	5647.5	-50.88	3.30	12.50	Horizontal	-41.68	-13.00	28.68	315
4	7530.0	-59.56	4.20	12.20	Horizontal	-51.56	-13.00	38.56	135
5	9412.5	-55.78	4.30	11.10	Horizontal	-48.98	-13.00	35.98	270
6	11295.0	-52.55	5.90	11.90	Horizontal	-46.55	-13.00	33.55	225
7	13177.5	-54.44	5.70	14.00	Horizontal	-46.14	-13.00	33.14	45
8	15060.0	-53.13	5.80	13.10	Horizontal	-45.83	-13.00	32.83	0
9	16942.5	-55.10	6.10	14.60	Horizontal	-46.60	-13.00	33.60	315
10	18825.0	--	--	--	--	--	--	--	--

Note: 1.The other Spurious RF Radiated emissions level is no more than noise floor.

2. The worst emission was found in the antenna is Horizontal position.

LTE Band 25 5MHz CH-Middle

Harmonic	Frequency (MHz)	SG (dBm)	Cable Loss (dB)	Gain (dBi)	Antenna Polarization	EIRP Level (dBm)	Limit (dBm)	Margin (dB)	Azimuth (deg)
2	3765.0	-58.81	2.60	12.50	Horizontal	-48.91	-13.00	35.91	90
3	5647.5	-49.59	3.30	12.50	Horizontal	-40.39	-13.00	27.39	45
4	7530.0	-58.94	4.20	12.20	Horizontal	-50.94	-13.00	37.94	225
5	9412.5	-55.17	4.30	11.10	Horizontal	-48.37	-13.00	35.37	270
6	11295.0	-53.41	5.90	11.90	Horizontal	-47.41	-13.00	34.41	315
7	13177.5	-54.18	5.70	14.00	Horizontal	-45.88	-13.00	32.88	180
8	15060.0	-53.93	5.80	13.10	Horizontal	-46.63	-13.00	33.63	225
9	16942.5	-50.88	6.10	14.60	Horizontal	-42.38	-13.00	29.38	135
10	18825.0	--	--	--	--	--	--	--	--

Note: 1.The other Spurious RF Radiated emissions level is no more than noise floor.

2. The worst emission was found in the antenna is Horizontal position.



## LTE Band 25 10MHz CH-Middle

Harmonic	Frequency (MHz)	SG (dBm)	Cable Loss (dB)	Gain (dBi)	Antenna Polarization	EIRP Level (dBm)	Limit (dBm)	Margin (dB)	Azimuth (deg)
2	3765.0	-52.04	2.60	12.50	Horizontal	-42.14	-13.00	29.14	90
3	5647.5	-51.81	3.30	12.50	Horizontal	-42.61	-13.00	29.61	45
4	7530.0	-58.33	4.20	12.20	Horizontal	-50.33	-13.00	37.33	0
5	9412.5	-56.68	4.30	11.10	Horizontal	-49.88	-13.00	36.88	0
6	11295.0	-53.70	5.90	11.90	Horizontal	-47.70	-13.00	34.70	90
7	13177.5	-55.57	5.70	14.00	Horizontal	-47.27	-13.00	34.27	135
8	15060.0	-53.41	5.80	13.10	Horizontal	-46.11	-13.00	33.11	270
9	16942.5	-54.10	6.10	14.60	Horizontal	-45.60	-13.00	32.60	315
10	18825.0	--	--	--	--	--	--	--	--

Note: 1. The other Spurious RF Radiated emissions level is no more than noise floor.

2. The worst emission was found in the antenna is Horizontal position.



## 6. Main Test Instruments

(Original): October 22, 2019 ~ November 9, 2019 and July 7, 2020

Name	Manufacturer	Type	Serial Number	Calibration Date	Expiration Date
Base Station Simulator	R&S	CMU200	118133	2019-05-19	2020-05-18
				2020-05-17	2021-05-16
Base Station Simulator	R&S	CMW500	113824	2019-05-19	2020-05-18
				2020-05-18	2021-05-17
Power Splitter	Hua Xiang	SHX-GF2-2-13	10120101	/	/
Spectrum Analyzer	Key sight	N9010A	MY50210259	2019-05-19	2020-05-18
				2020-05-18	2021-05-17
Universal Radio Communication Tester	Key sight	E5515C	MY48367192	2019-05-19	2020-05-27
				2020-05-27	2021-05-26
Signal Analyzer	R&S	FSV30	100815	2018-12-16	2019-12-15
				2019-12-15	2020-12-14
Loop Antenna	SCHWARZBECK	FMZB1519	1519-047	2017-09-26	2020-09-25
Trilog Antenna	SCHWARZBECK	VUBL 9163	9163-201	2017-11-18	2020-11-17
Horn Antenna	R&S	HF907	102723	2018-08-11	2021-08-10
Horn Antenna	ETS-Lindgren	3160-09	00102643	2018-06-20	2021-06-19
Signal generator	R&S	SMB 100A	102594	2019-05-19	2020-05-18
				2020-05-18	2021-05-17
Climatic Chamber	ESPEC	SU-242	93000506	2017-12-17	2020-12-16
Preampfier	R&S	SCU18	102327	2019-05-19	2020-05-18
				2020-05-18	2021-05-17
MOB COMMS DC SUPPLY	Keysight	66319D	MY43004105	2019-05-19	2020-05-18
				2020-05-18	2021-05-17
RF Cable	Agilent	SMA 15cm	0001	2019-06-14	2019-12-13
				2020-06-12	2020-12-11
Software	R&S	EMC32	9.26.0	/	/



(Variant): November 30, 2021~ December 1, 2021

Name	Manufacturer	Type	Serial Number	Calibration Date	Expiration Date
Base Station Simulator	R&S	CMW500	150415	2021-05-15	2022-05-14
Spectrum Analyzer	Keysight	N9020A	MY52330084	2021-05-15	2022-05-14



## **ANNEX A: The EUT Appearance**

The EUT Appearance are submitted separately.



## **ANNEX B: Test Setup Photos**

**The Test Setup Photos are submitted separately.**



## **ANNEX C: Product Change Description**

The Product Change Description are submitted separately.

\*\*\*\*\*END OF REPORT \*\*\*\*\*