

RF TEST REPORT

Applicant Quectel Wireless Solutions Co., Ltd.
FCC ID XMR2021BG951AGL
Product LTE Cat M1/NB Module
Brand Quectel
Model BG951A-GL
Report No. R2301A0026-R6
Issue Date March 21, 2023

TA Technology (Shanghai) Co., Ltd. tested the above equipment in accordance with the requirements in **FCC CFR47 Part 2 (2022)/ FCC CFR47 Part 27C (2022)**. The test results show that the equipment tested is capable of demonstrating compliance with the requirements as documented in this report.

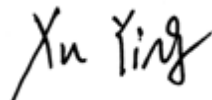

Prepared by: Xu Ying



Approved by: Xu Kai

TA Technology (Shanghai) Co., Ltd.

Building 3, No.145, Jintang Rd, Pudong Shanghai, P.R.China

TEL: +86-021-50791141/2/3

FAX: +86-021-50791141/2/3-8000

TABLE OF CONTENT

1	Test Laboratory	5
1.1	Notes of the Test Report	5
1.2.	Test facility	5
1.3	Testing Location	5
2	General Description of Equipment under Test	6
2.1	Applicant and Manufacturer Information	6
2.2	General information	6
3	Applied Standards	8
4	Test Configuration	9
5	Test Case	11
5.1	RF Power Output and Effective Isotropic Radiated Power	11
5.2	Occupied Bandwidth	13
5.3	Band Edge Compliance	14
5.4	Peak-to-Average Power Ratio (PAPR)	16
5.5	Frequency Stability	17
5.6	Spurious Emissions at Antenna Terminals	18
5.7	Radiated Spurious Emission	20
6	Test Results	24
6.1	RF Power Output and Effective Isotropic Radiated Power	24
6.2	Occupied Bandwidth	27
6.3	Band Edge Compliance	35
6.4	Peak-to-Average Power Ratio (PAPR)	59
6.5	Frequency Stability	61
6.6	Spurious Emissions at Antenna Terminals	70
6.7	Radiated Spurious Emission	80
7	Main Test Instruments	86
	ANNEX A: The EUT Appearance	87
	ANNEX B: Test Setup Photos	88
	ANNEX C: Product Change Description (Variant 1)	89
	ANNEX D: Product Change Description (Variant 2)	90

Summary of Measurement Results

Number	Test Case	Clause in FCC rules	Verdict
1	RF Power Output and Effective Isotropic Radiated Power	2.1046 /27.50(d)(4) /27.50(b)(10) /27.50(c)(10)	PASS
2	Occupied Bandwidth	2.1049	PASS
3	Band Edge Compliance	27.53(h) /27.53(g) /27.53(f) /27.53(c)	PASS
4	Peak-to-Average Power Ratio	27.50(d)/KDB971168 D01(5.7)	PASS
5	Frequency Stability	2.1055 / 27.54	PASS
6	Spurious Emissions at Antenna Terminals	2.1051 /27.53(h) /27.53(g) /27.53(f) /27.53(c)	PASS
7	Radiated Spurious Emission	2.1053 /27.53(h) /27.53(g) /27.53(f) /27.53(c)	PASS

Date of Testing: July 21, 2021 ~ August 5, 2021

Date of Sample Received: July 20, 2021

Note: PASS: The EUT complies with the essential requirements in the standard.

FAIL: The EUT does not comply with the essential requirements in the standard.

All indications of Pass/Fail in this report are opinions expressed by TA Technology (Shanghai) Co., Ltd. based on interpretations and/or observations of test results. Measurement Uncertainties were not taken into account and are published for informational purposes only.

BG951A-GL (Report No.: R2301A0026-R6) is a variant model (Variant 2) of BG951A-GL (Report No.: R2111A0947-R6V2). BG951A-GL supports from Cat NB1 (3GPP R13) to Cat NB2 (3GPP R14) only by FW updating, the hardware remains the same.

The detailed product change description please refers to following table:

Module	BG951A-GL (Cat NB1)	BG951A-GL (Cat NB2)
Category	Cat M1 & NB1	Cat M1 & NB2
Frequency Bands	Cat M1 Band 2/4/5/12/13/25/26/66 Cat NB1 Band 2/4/5/12/13/17/25/66	Cat M1 Band 2/4/5/12/13/25/26/66 Cat NB2 Band 2/4/5/12/13/17/25/66
Others	The same	

There is only verified RF Power Output; Band Edge Compliance; Spurious Emissions at Antenna Terminals and Radiated Spurious Emission(LTE eMTC Band 13, CH Middle, 5MHz, 10MHz), and did not worsen, so they were not recorded in the report.

The detailed product change description please refers to the *Difference Declaration Letter (Variant 2)*.

BG951A (Report No.: R2111A0947-R6V2) is a variant model (Variant 1) of BG950A (Report No.: R2107A0607-R6V1). The product only change mode, Software version, Hardware version, product name and FCC ID. There is no test in this report. The detailed product change description please refers to the *Difference Declaration Letter (Variant 1)*.

1 Test Laboratory

1.1 Notes of the Test Report

This report shall not be reproduced in full or partial, without the written approval of **TA Technology (Shanghai) Co., Ltd.** The results documented in this report apply only to the tested sample, under the conditions and modes of operation as described herein. Measurement Uncertainties were not taken into account and are published for informational purposes only. This report is written to support regulatory compliance of the applicable standards stated above.

1.2. Test facility

FCC (Designation number: CN1179, Test Firm Registration Number: 446626)

TA Technology (Shanghai) Co., Ltd. has been listed on the US Federal Communications Commission list of test facilities recognized to perform measurements.

A2LA (Certificate Number: 3857.01)

TA Technology (Shanghai) Co., Ltd. has been listed by American Association for Laboratory Accreditation to perform measurement.

1.3 Testing Location

Company: TA Technology (Shanghai) Co., Ltd.
 Address: Building 3, No.145, Jintang Rd, Pudong Shanghai, P.R.China
 City: Shanghai
 Post code: 201201
 Country: P. R. China
 Contact: Xu Kai
 Telephone: +86-021-50791141/2/3
 Fax: +86-021-50791141/2/3-8000
 Website: <http://www.ta-shanghai.com>
 E-mail: xukai@ta-shanghai.com

2 General Description of Equipment under Test

2.1 Applicant and Manufacturer Information

Applicant	Quectel Wireless Solutions Co., Ltd.
Applicant address	Building 5, Shanghai Business Park Phase III (Area B), No.1016 Tianlin Road, Minhang District, Shanghai, China, 200233
Manufacturer	Quectel Wireless Solutions Co., Ltd.
Manufacturer address	Building 5, Shanghai Business Park Phase III (Area B), No.1016 Tianlin Road, Minhang District, Shanghai, China, 200233

2.2 General information

EUT Description			
Model	BG951A-GL		
IMEI	(Original) 869410050002659		
Hardware Version	R1.5		
Software Version	BG951AGLAAR02A01		
Power Supply	External power supply		
Antenna Type	External Antenna		
Antenna Gain	Mode	Frequency (MHz)	Gain (dBi)
	LTE eMTC Band 4	1700	1.67
		1720	1.94
		1740	2.00
		1760	1.57
	LTE eMTC Band 12	700	1.66
		710	3.26
		720	3.95
	LTE eMTC Band 13	770	3.98
		780	4.45
		790	3.63
	LTE eMTC Band 66	1700	1.67
		1720	1.94
		1740	2.00
		1760	1.57
		1780	0.97
Test Mode(s)	LTE eMTC Band 4/12/13/66;		
Test Modulation	QPSK 16QAM;		
LTE Category	M1		
Maximum E.I.R.P./ E.R.P.	LTE eMTC Band 4:	25.99dBm	
	LTE eMTC Band 12:	25.08dBm	

	LTE eMTC Band 13:	26.08dBm	
	LTE eMTC Band 66:	25.86dBm	
Rated Power Supply Voltage	3.3V		
Operating Voltage	Minimum: 2.2V Maximum: 4.35V		
Operating Temperature	Lowest: -35°C Highest: +75°C		
Testing Temperature	Lowest: -35°C Highest: +75°C		
Frequency Range(s)	Mode	Tx (MHz)	Rx (MHz)
	LTE eMTC Band 4	1710 ~ 1755	2110 ~ 2155
	LTE eMTC Band 12	699 ~ 716	729 ~ 746
	LTE eMTC Band 13	777 ~ 787	746 ~ 756
	LTE eMTC Band 66	1710 ~ 1780	2110 ~ 2180
Note: 1. The EUT is sent from the applicant to TA and the information of the EUT is declared by the applicant.			

3 Applied Standards

According to the specifications of the manufacturer, it must comply with the requirements of the following standards:

Test standards:

FCC CFR47 Part 27C (2022)

FCC CFR47 Part 2 (2022)

Reference standard:

ANSI C63.26-2015

KDB 971168 D01 Power Meas License Digital Systems v03r01

4 Test Configuration

Radiated measurements are performed by rotating the EUT in three different orthogonal test planes. EUT stand-up position (Z axis), lie-down position (X, Y axis). Receiver antenna polarization (horizontal and vertical), the worst emission was found in position (X, Y axis, vertical polarization) and the worst case was recorded.

All mode and data rates and positions and RB size and modulations were investigated. Subsequently, only the worst case emissions are reported.

The following testing in LTE is set based on the maximum RF Output Power.

The following testing in different Bandwidth is set to detail in the following table:

Test modes are chosen to be reported as the worst case configuration below:

Test modes are chosen to be reported as the worst case configuration below for LTE eMTC Band 4/12/13/66:

Test items	Modes	Bandwidth (MHz)						Modulation		RB			Test Channel		
		1.4	3	5	10	15	20	QPSK	16QAM	1	50%	100%	L	M	H
RF Power Output and Effective Isotropic Radiated Power	LTE 4	0	0	0	0	0	0	0	0	0	0	0	0	0	0
	LTE 12	0	0	0	0	-	-	0	0	0	0	0	0	0	0
	LTE 13	-	-	0	0	-	-	0	0	0	0	0	0	0	0
	LTE 66	0	0	0	0	0	0	0	0	0	0	0	0	0	0
Occupied Bandwidth	LTE 4	0	0	0	0	0	0	0	0	-	-	0	0	0	0
	LTE 12	0	0	0	0	-	-	0	0	-	-	0	0	0	0
	LTE 13	-	-	0	0	-	-	0	0	-	-	0	0	0	0
	LTE 66	0	0	0	0	0	0	0	0	-	-	0	0	0	0
Band Edge Compliance	LTE 4	0	0	0	0	0	0	0	0	0	-	0	0	-	0
	LTE 12	0	0	0	0	-	-	0	0	0	-	0	0	-	0
	LTE 13	-	-	0	0	-	-	0	0	0	-	0	0	-	0
	LTE 66	0	0	0	0	0	0	0	0	0	-	0	0	-	0
Peak-to-Average Power Ratio	LTE 4	0	0	0	0	0	0	0	0	-	-	0	0	0	0
	LTE 12	0	0	0	0	-	-	0	0	-	-	0	0	0	0
	LTE 13	-	-	0	0	-	-	0	0	-	-	0	0	0	0
	LTE 66	0	0	0	0	0	0	0	0	-	-	0	0	0	0
Frequency Stability	LTE 4	0	0	0	0	0	0	0	0	0	-	-	-	0	-
	LTE 12	0	0	0	0	-	-	0	0	0	-	-	-	0	-
	LTE 13	-	-	0	0	-	-	0	0	0	-	-	-	0	-
	LTE 66	0	0	0	0	0	0	0	0	0	-	-	-	0	-
Spurious	LTE 4	0	0	0	0	0	0	0	-	0	-	-	0	0	0

Emissions at Antenna Terminals	LTE 12	O	O	O	O	-	-	O	-	O	-	-	O	O	O
	LTE 13	-	-	O	O	-	-	O	-	O	-	-	O	O	O
	LTE 66	O	O	O	O	O	O	O	-	O	-	-	O	O	O
Radiates Spurious Emission	LTE 4	O	-	O	-	-	O	O	-	O	-	-	-	O	-
	LTE 12	O	-	O	O	-	-	O	-	O	-	-	-	O	-
	LTE 13	-	-	O	O	-	-	O	-	O	-	-	-	O	-
	LTE 66	O	-	O	-	-	O	O	-	O	-	-	-	O	-
Note	1. The mark "O" means that this configuration is chosen for testing. 2. The mark "-" means that this configuration is not testing.														

5 Test Case

5.1 RF Power Output and Effective Isotropic Radiated Power

Ambient condition

Temperature	Relative humidity
20°C ~25°C	45%~50%

Methods of Measurement

During the process of the testing, The EUT was connected to the Base Station Simulator with a known loss. The EUT is controlled by the Base Station Simulator test set to ensure max power transmission with proper modulation.

ERP can then be calculated as follows:

$$\text{EIRP (dBm)} = \text{Output Power (dBm)} + \text{Antenna Gain (dBi)}$$

$$\text{EIRP (dBm)} = \text{ERP (dBm)} + 2.15 \text{ (dB.)}$$

Test Setup

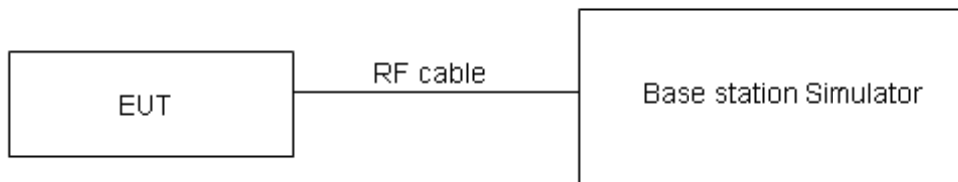

Limits

No specific RF power output requirements in part 2.1046.

Rule Part 27.50(b) (10) specifies that “Portable stations (hand-held devices) transmitting in the 746-757 MHz, 776-788 MHz, and 805-806 MHz bands are limited to 3 watts ERP”

Rule Part 27.50(c) (10) specifies that “Portable stations (hand-held devices) in the 600 MHz uplink band and the 698-746 MHz band, and fixed and mobile stations in the 600 MHz uplink band are limited to 3 watts ERP”

Rule Part 27.50(d) (4) specifies that “Fixed, mobile and portable (hand-held) stations operating in the 1710–1755 MHz band are limited to 1 watt EIRP”

Part 27.50(b)(10)Limit	-LTE 13	$\leq 3 \text{ W}$ (34.77 dBm)
Part 27.50(c)(10)Limit	-LTE 12	$\leq 3 \text{ W}$ (34.77 dBm)
Part 27.50(d)(4)Limit	-LTE 4/66	$\leq 1 \text{ W}$ (30 dBm)

Measurement Uncertainty

The assessed measurement uncertainty to ensure 95% confidence level for the normal distribution is with the coverage factor $k = 2$, $U=0.4$ dB for RF power output, $k = 2$, $U= 1.19$ dB for ERP/EIRP.

Test Results

Refer to the section 6.1 of this report for test data.

5.2 Occupied Bandwidth

Ambient condition

Temperature	Relative humidity
20°C ~25°C	45%~50%

Method of Measurement

The EUT was connected to Spectrum Analyzer and Base Station Simulator via power Splitter. The occupied bandwidth is measured using spectrum analyzer.

RBW is set to $\geq 1\%EBW$, VBW is set to 3x RBW.

99% power and -26dBc occupied bandwidths are recorded. Spectrum analyzer plots are included on the following pages.

Test Setup

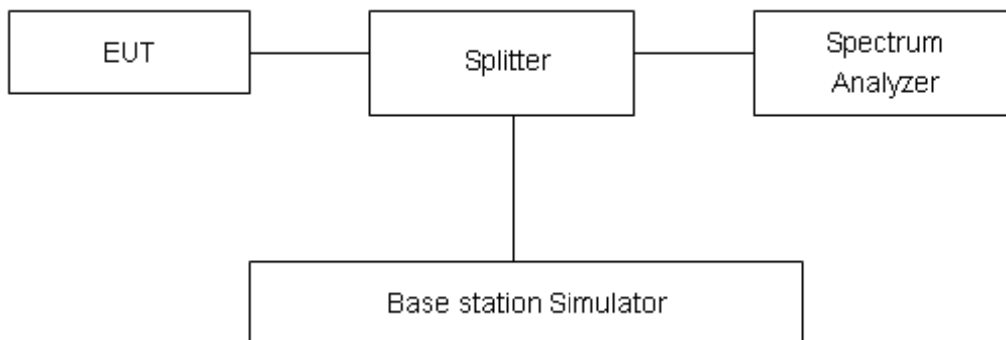

Limits

No specific occupied bandwidth requirements in part 2.1049.

Measurement Uncertainty

The assessed measurement uncertainty to ensure 95% confidence level for the normal distribution is with the coverage factor $k = 2$, $U=624\text{Hz}$.

Test Results

Refer to the section 6.2 of this report for test data.

5.3 Band Edge Compliance

Ambient condition

Temperature	Relative humidity
20°C ~25°C	45%~50%

Method of Measurement

The EUT was connected to Spectrum Analyzer and Base Station Simulator via power Splitter. The band edge of the lowest and highest channels were measured.

The testing follows KDB 971168 D01 v03r01 Section 6.0

The EUT was connected to spectrum analyzer and system simulator via a power divider.

The band edges of low and high channels for the highest RF powers were measured.

RBW is set to $\geq 1\%EBW$, VBW is set to 3x RBW on spectrum analyzer.

Set spectrum analyzer with RMS detector.

The RF fundamental frequency should be excluded against the limit line in the operating frequency band.

Checked that all the results comply with the emission limit line.

Test Setup

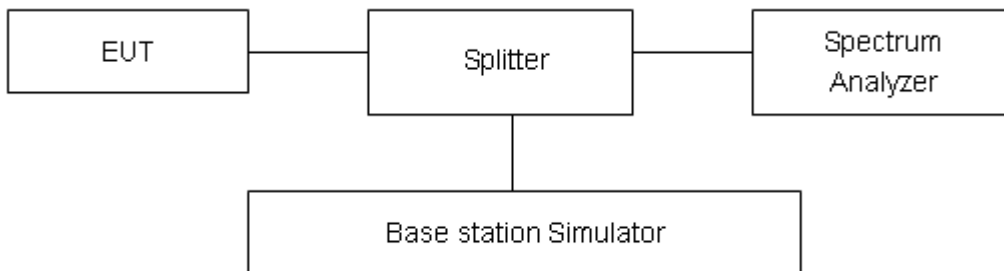

Limits

Rule Part 27.53(i) By a factor of not less than $43 + 10 \log (P)$ dB on all frequencies between 2305 and 2320 MHz.

LTE 4/66 Rule Part 27.53(h) specifies that “ for operations in the 1695-1710 MHz, 1710-1755 MHz, 1755-1780 MHz, 1915-1920 MHz, 1995-2000 MHz, 2000-2020 MHz, 2110-2155 MHz, 2155-2180 MHz, and 2180-2200 bands, the power of any emission outside a licensee's frequency block shall be attenuated below the transmitter power (P) in watts by at least $43 + 10 \log_{10} (P)$ dB”

LTE 12 Rule Part 27.53(g) For operations in the 600 MHz band and the 698-746 MHz band, the power of any emission outside a licensee's frequency band(s) of operation shall be attenuated below the transmitter power (P) within the licensed band(s) of operation, measured in watts, by at least $43 + 10 \log (P)$ dB. Compliance with this provision is based on the use of measurement instrumentation employing a resolution bandwidth of 100 kilohertz or greater. However, in the 100 kilohertz bands immediately outside and adjacent to a licensee's frequency block, a resolution bandwidth of at least 30 kHz may be employed.

LTE 13 Rule Part 27.53(f) For operations in the 746-758 MHz, 775-788 MHz, and 805-806 MHz bands, emissions in the band 1559-1610 MHz shall be limited to -70 dBW/MHz equivalent isotropically radiated power (EIRP) for wideband signals, and -80 dBW EIRP for discrete emissions of less than 700 Hz bandwidth. For the purpose of equipment authorization, a transmitter shall be tested with an antenna that is representative of the type that will be used with the equipment in normal operation.

LTE 13 Rule Part 27.53 (c) For operations in the 746-758 MHz band and the 776-788 MHz band, the power of any emission outside the licensee's frequency band(s) of operation shall be attenuated below the transmitter power (P) within the licensed band(s) of operation, measured in watts, in accordance with the following:

- (1) On any frequency outside the 746-758 MHz band, the power of any emission shall be attenuated outside the band below the transmitter power (P) by at least $43 + 10 \log (P)$ dB;
- (2) On any frequency outside the 776-788 MHz band, the power of any emission shall be attenuated outside the band below the transmitter power (P) by at least $43 + 10 \log (P)$ dB;
- (3) On all frequencies between 763-775 MHz and 793-805 MHz, by a factor not less than $76 + 10 \log (P)$ dB in a 6.25 kHz band segment, for base and fixed stations;
- (4) On all frequencies between 763-775 MHz and 793-805 MHz, by a factor not less than $65 + 10 \log (P)$ dB in a 6.25 kHz band segment, for mobile and portable stations;
- (5) Compliance with the provisions of paragraphs (c)(1) and (c)(2) of this section is based on the use of measurement instrumentation employing a resolution bandwidth of 100 kHz or greater. However, in the 100 kHz bands immediately outside and adjacent to the frequency block, a resolution bandwidth of at least 30 kHz may be employed;

Measurement Uncertainty

The assessed measurement uncertainty to ensure 95% confidence level for the normal distribution is with the coverage factor $k = 1.96$, $U=0.684$ dB.

Test Results

Refer to the section 6.3 of this report for test data.

5.4 Peak-to-Average Power Ratio (PAPR)

Ambient condition

Temperature	Relative humidity
20°C ~25°C	45%~50%

Methods of Measurement

Measure the total peak power and record as PPK. And measure the total average power and record as PAvg. Both the peak and average power levels must be expressed in the same logarithmic units (e.g., dBm). Determine the PAPR from:

$$PAPR (dB) = PPK (dBm) - PAvg (dBm).$$

Test Setup

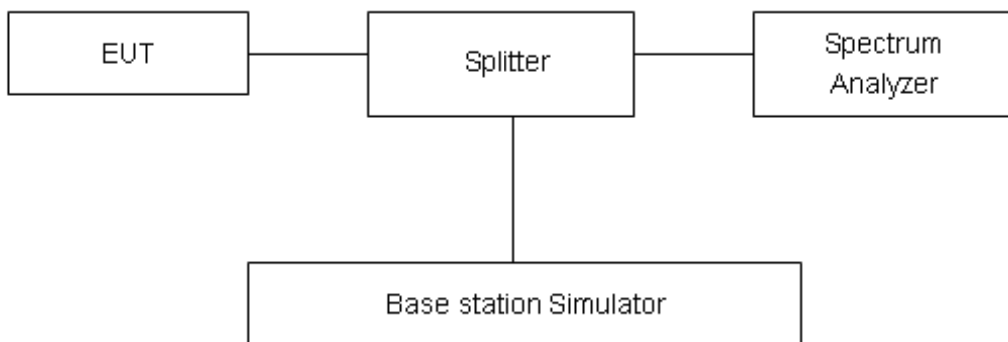

Limits

Rule Part 27.50(d)(5) Equipment employed must be authorized in accordance with the provisions of 24.51. Power measurements for transmissions by stations authorized under this section may be made either in accordance with a Commission-approved average power technique or in compliance with paragraph (d)(6) of this section. In measuring transmissions in this band using an average power technique, the peak-to-average ratio (PAR) of the transmission may not exceed 13 dB.

Measurement Uncertainty

The assessed measurement uncertainty to ensure 95% confidence level for the normal distribution is with the coverage factor $k = 2$, $U = 0.4$ dB.

Test Results

Refer to the section 6.4 of this report for test data.

5.5 Frequency Stability

Ambient condition

Temperature	Relative humidity
20°C ~25°C	45%~50%

Method of Measurement

Frequency Stability (Temperature Variation)

The temperature inside the climate chamber is varied from -35°C to +75°C in 10°C step size.

(1) With all power removed, the temperature was decreased to -10°C and permitted to stabilize for three hours.

(2) Measure the carrier frequency with the test equipment in a “call mode”. These measurements should be made within 1 minute of powering up the mobile station, to prevent significant self warming.

(3) Repeat the above measurements at 10°C increments from -35°C to +75°C. Allow at least 1.5 hours at each temperature, un-powered, before making measurements.

Frequency Stability (Voltage Variation)

The frequency stability shall be measured with variation of primary supply voltage as follows:

Primary Supply Voltage: The primary supply voltage is varied from 85% to 115% of the nominal value for non hand-carried battery and AC powered equipment. For hand-carried, battery-powered equipment, primary supply voltage is reduced to the battery operating end point which shall be specified by the manufacturer.

This transceiver is specified to operate with an input voltage of between 2.2V and 4.35 V, with a nominal voltage of 3.3V.

Test setup

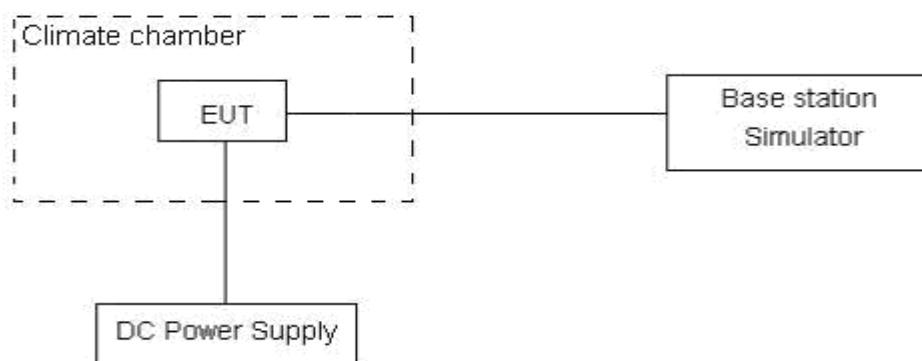

Limits

The frequency stability shall be sufficient to ensure that the fundamental emissions stay within the authorized bands of operation.

Measurement Uncertainty

The assessed measurement uncertainty to ensure 99.75% confidence level for the normal distribution is with the coverage factor $k = 3, U = 0.01\text{ppm}$.

Test Results

Refer to the section 6.5 of this report for test data.

5.6 Spurious Emissions at Antenna Terminals

Ambient condition

Temperature	Relative humidity
20°C ~25°C	45%~50%

Method of Measurement

The EUT was connected to Spectrum Analyzer and Base Station Simulator via power Splitter. The measurement is carried out using a spectrum analyzer. The spectrum analyzer scans from 9kHz to the 10th harmonic of the carrier. The peak detector is used.

RBW is set to 1 kHz (0.009MHz~ 0.15 MHz),

RBW is set to 10 kHz (0.15 MHz~ 30 MHz)

RBW is set to 100 kHz (30MHz~1000 MHz)

RBW is set to 1000 kHz (above 1000MHz)

Sweep is set to ATUO.

Of those disturbances below (limit – 20 dB), the mark is not required for the EUT.

The modulation mode and RB allocation refer to section 5.1, using the maximum output power configuration.

Test setup

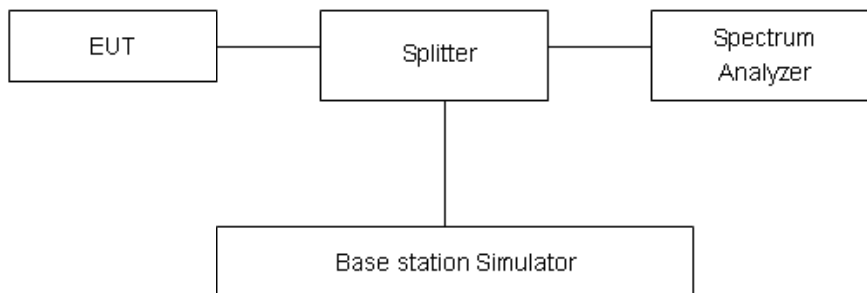

Limits

LTE -4/66 Rule Part 27.53(h) specifies that “for operations in the 1695-1710 MHz, 1710-1755 MHz, 1755-1780 MHz, 1915-1920 MHz, 1995-2000 MHz, 2000-2020 MHz, 2110-2155 MHz, 2155-2180 MHz, and 2180-2200 bands, the power of any emission outside a licensee's frequency block shall be attenuated below the transmitter power (P) in watts by at least $43 + 10 \log_{10}(P)$ dB..”

LTE -12 Rule Part 27.53 (g) For operations in the 600 MHz band and the 698-746 MHz band, the power of any emission outside a licensee's frequency band(s) of operation shall be attenuated below the transmitter power (P) within the licensed band(s) of operation, measured in watts, by at least $43 + 10 \log(P)$ dB. Compliance with this provision is based on the use of measurement instrumentation employing a resolution bandwidth of 100 kilohertz or greater. However, in the 100 kilohertz bands immediately outside and adjacent to a licensee's frequency block, a resolution bandwidth of at least 30 kHz may be employed.

LTE -13 Rule Part 27.53(f) For operations in the 746-758 MHz, 775-788 MHz, and 805-806 MHz

bands, emissions in the band 1559-1610 MHz shall be limited to -70 dBW/MHz equivalent isotropically radiated power (EIRP) for wideband signals, and -80 dBW EIRP for discrete emissions of less than 700 Hz bandwidth. For the purpose of equipment authorization, a transmitter shall be tested with an antenna that is representative of the type that will be used with the equipment in normal operation.

LTE 13- Part 27.53 (c) For operations in the 746-758 MHz band and the 776-788 MHz band, the power of any emission outside the licensee's frequency band(s) of operation shall be attenuated below the transmitter power (P) within the licensed band(s) of operation, measured in watts, in accordance with the following:

- (1) On any frequency outside the 746-758 MHz band, the power of any emission shall be attenuated outside the band below the transmitter power (P) by at least $43 + 10 \log (P)$ dB;
- (2) On any frequency outside the 776-788 MHz band, the power of any emission shall be attenuated outside the band below the transmitter power (P) by at least $43 + 10 \log (P)$ dB;
- (3) On all frequencies between 763-775 MHz and 793-805 MHz, by a factor not less than $76 + 10 \log (P)$ dB in a 6.25 kHz band segment, for base and fixed stations;
- (4) On all frequencies between 763-775 MHz and 793-805 MHz, by a factor not less than $65 + 10 \log (P)$ dB in a 6.25 kHz band segment, for mobile and portable stations;
- (5) Compliance with the provisions of paragraphs (c)(1) and (c)(2) of this section is based on the use of measurement instrumentation employing a resolution bandwidth of 100 kHz or greater. However, in the 100 kHz bands immediately outside and adjacent to the frequency block, a resolution bandwidth of at least 30 kHz may be employed;

Part 27.53(h)/(g) Limit		LTE 4/66	-13 dBm
Part 27.53(f) Limit	Limit out of the band 1559-1610 MHz	LTE 13	-13 dBm
	Limit in the band 1559-1610 MHz		-40 dBm

Measurement Uncertainty

The assessed measurement uncertainty to ensure 99.75% confidence level for the normal distribution is with the coverage factor $k = 1.96$.

Frequency	Uncertainty
9kHz-1GHz	0.684 dB
1GHz-27GHz	1.407 dB

Test Results

Refer to the section 6.6 of this report for test data.

5.7 Radiated Spurious Emission

Ambient condition

Temperature	Relative humidity
20°C ~25°C	45%~50%

Method of Measurement

- The testing follows FCC KDB 971168 D01 v03r01 Section 5.8 and ANSI C63.26-2015.
- Below 1GHz: The EUT is placed on a turntable 0.8 meters above the ground in the chamber, 3 meter away from the antenna. The maximal emission value is acquired by adjusting the antenna height, polarisation and turntable azimuth. Normally, the height range of antenna is 1 m to 4 m, the azimuth range of turntable is 0° to 360°, and the receive antenna has two polarizations Vertical (V) and Horizontal (H). Above 1GHz: (Note: the FCC's permission to use 1.5m as an alternative per TCBC Conf call of Dec. 2, 2014.) The EUT is placed on a turntable 1.5 meters above the ground in the chamber, 3 meter away from the antenna. The maximal emission value is acquired by adjusting the antenna height, polarisation and turntable azimuth. Normally, the height range of antenna is 1 m to 4 m, the azimuth range of turntable is 0° to 360°, and the receive antenna has two polarizations Vertical (V) and Horizontal (H).
- A loop antenna, A log-periodic antenna or horn antenna shall be substituted in place of the EUT. The log-periodic antenna will be driven by a signal generator and the level will be adjusted till the same power value on the spectrum analyzer or receiver. The level of the spurious emissions can be calculated through the level of the signal generator, cable loss, the gain of the substitution antenna and the reading of the spectrum analyzer or receiver.
- The EUT is then put into continuously transmitting mode at its maximum power level during the test. Set Test Receiver or Spectrum RBW=100kHz, VBW=300kHz for 30MHz to 1GHz and RBW=1MHz, VBW=3MHz for above 1GHz, and the maximum value of the receiver should be recorded as (Pr).
- The EUT shall be replaced by a substitution antenna. In the chamber, an substitution antenna for the frequency band of interest is placed at the reference point of the chamber. An RF Signal source for the frequency band of interest is connected to the substitution antenna with a cable that has been constructed to not interfere with the radiation pattern of the antenna. A power (PMea) is applied to the input of the substitution antenna, and adjust the level of the signal generator output until the value of the receiver reach the previously recorded (Pr). The power of signal source (PMea) is recorded. The test should be performed by rotating the test item and adjusting the receiving antenna polarization.
- A amplifier should be connected to the Signal Source output port. And the cable should be connect between the Amplifier and the Substitution Antenna. The cable loss (Pcl) ,the Substitution Antenna Gain (Ga) and the Amplifier Gain (PAg) should be recorded after test.
- The measurement results are obtained as described below:

$$\text{Power(EIRP)} = \text{PMea} - \text{PAg} - \text{Pcl} + \text{Ga}$$
 The measurement results are amend as described below:

$$\text{Power(EIRP)} = \text{PMea} - \text{Pcl} + \text{Ga}$$
- This value is EIRP since the measurement is calibrated using an antenna of known gain (2.15 dB) and known input power. ERP can be calculated from EIRP by subtracting the gain of the dipole, $\text{ERP} = \text{EIRP} - 2.15\text{dB}$.

The modulation mode and RB allocation refer to section 5.1, using the maximum output power configuration.

Test setup

9KHz~ 30MHz

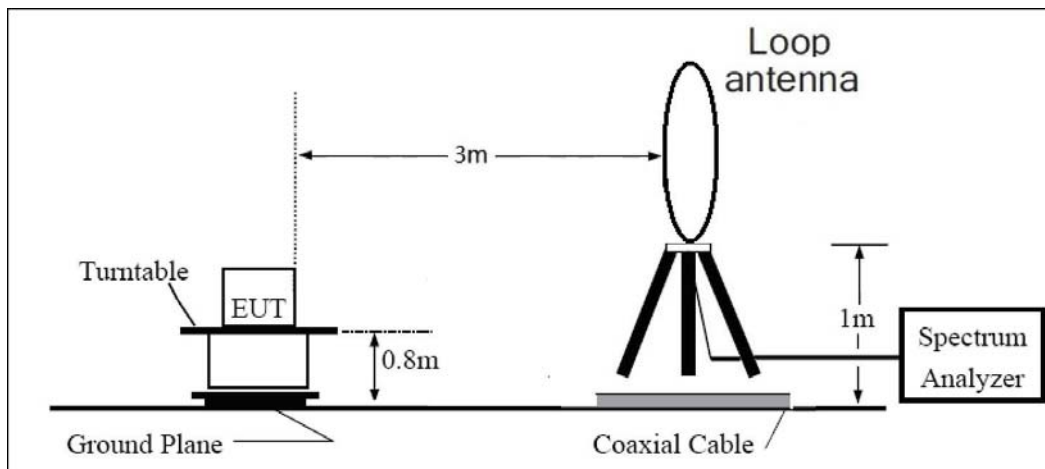

30MHz~ 1GHz

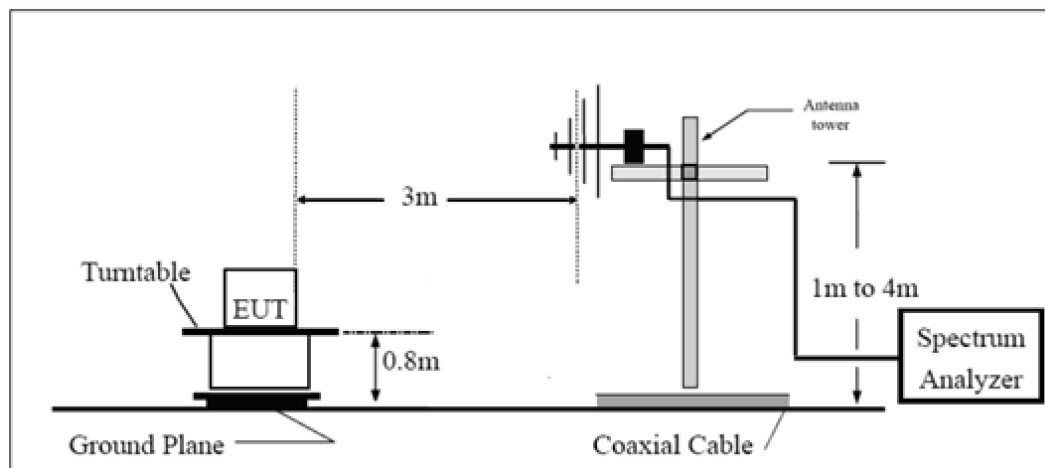

Above 1GHz

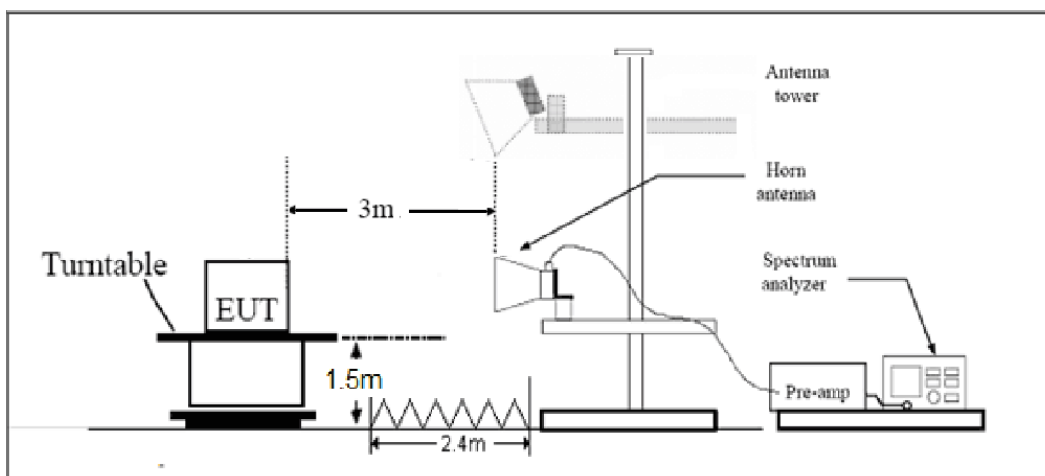

Note: Area side:2.4mX3.6m

Limits

LTE -4/66 Rule Part 27.53(h) specifies that “for operations in the 1695-1710 MHz, 1710-1755 MHz, 1755-1780 MHz, 1915-1920 MHz, 1995-2000 MHz, 2000-2020 MHz, 2110-2155 MHz, 2155-2180 MHz, and 2180-2200 bands, the power of any emission outside a licensee's frequency block shall be attenuated below the transmitter power (P) in watts by at least $43 + 10 \log_{10}(P)$ dB.”

LTE -12 Rule Part 27.53 (g) For operations in the 600 MHz band and the 698-746 MHz band, the power of any emission outside a licensee's frequency band(s) of operation shall be attenuated below the transmitter power (P) within the licensed band(s) of operation, measured in watts, by at least $43 + 10 \log(P)$ dB. Compliance with this provision is based on the use of measurement instrumentation employing a resolution bandwidth of 100 kilohertz or greater. However, in the 100 kilohertz bands immediately outside and adjacent to a licensee's frequency block, a resolution bandwidth of at least 30 kHz may be employed.

LTE -13 Rule Part 27.53(f) For operations in the 746-758 MHz, 775-788 MHz, and 805-806 MHz bands, emissions in the band 1559-1610 MHz shall be limited to -70 dBW/MHz equivalent isotropically radiated power (EIRP) for wideband signals, and -80 dBW EIRP for discrete emissions of less than 700 Hz bandwidth. For the purpose of equipment authorization, a transmitter shall be tested with an antenna that is representative of the type that will be used with the equipment in normal operation.

LTE 13 Part 27.53 (c) For operations in the 746-758 MHz band and the 776-788 MHz band, the power of any emission outside the licensee's frequency band(s) of operation shall be attenuated below the transmitter power (P) within the licensed band(s) of operation, measured in watts, in accordance with the following:

- (1) On any frequency outside the 746-758 MHz band, the power of any emission shall be attenuated outside the band below the transmitter power (P) by at least $43 + 10 \log(P)$ dB;
- (2) On any frequency outside the 776-788 MHz band, the power of any emission shall be attenuated outside the band below the transmitter power (P) by at least $43 + 10 \log(P)$ dB;
- (3) On all frequencies between 763-775 MHz and 793-805 MHz, by a factor not less than $76 + 10 \log(P)$ dB in a 6.25 kHz band segment, for base and fixed stations;
- (4) On all frequencies between 763-775 MHz and 793-805 MHz, by a factor not less than $65 + 10 \log(P)$ dB in a 6.25 kHz band segment, for mobile and portable stations;
- (5) Compliance with the provisions of paragraphs (c)(1) and (c)(2) of this section is based on the use of measurement instrumentation employing a resolution bandwidth of 100 kHz or greater. However, in the 100 kHz bands immediately outside and adjacent to the frequency block, a resolution bandwidth of at least 30 kHz may be employed;

Part 27.53 (h)/(g) Limit		LTE 4/66/12	-13 dBm
Part 27.53(f) Limit	Limit out of the band 1559-1610 MHz	LTE 13	-13 dBm
	Limit in the band 1559-1610 MHz		-40 dBm

Measurement Uncertainty

The assessed measurement uncertainty to ensure 95% confidence level for the normal distribution is with the coverage factor $k = \pm 1.96$, $U = \pm 3.55$ dB.

Test Results

Refer to the section 6.7 of this report for test data.

6 Test Results

6.1 RF Power Output and Effective Isotropic Radiated Power

LTE eMTC Band 4	Channel/ Frequency(MHz)	Index	RB#		Maximum Output Power(dBm)		EIRP (dBm)	
			RBstart		QPSK	16QAM	QPSK	16QAM
			QPSK	16QAM				
1.4MHz	19957/1710.7	0	1#0	1#0	23.70	22.58	25.64	24.52
		0	6#0	5#0	22.31	21.80	24.25	23.74
	20175/1732.5	0	1#0	1#0	23.67	22.47	25.67	24.47
		0	6#0	5#0	23.31	21.81	25.31	23.81
	20393/1754.3	0	1#5	1#5	23.76	22.70	25.33	24.27
		0	6#0	5#0	23.50	21.97	25.07	23.54
3MHz	19965/1711.5	0	1#0	1#0	23.82	22.85	25.76	24.79
		0	6#0	5#0	21.84	21.51	23.78	23.45
	20175/1732.5	0	1#0	1#0	23.82	22.78	25.82	24.78
		0	6#0	5#0	22.14	21.81	24.14	23.81
	20385/1753.5	1	1#5	1#5	23.68	23.02	25.62	24.96
		0	6#0	5#0	22.22	21.96	24.16	23.90
5MHz	19975/1712.5	3	1#0	1#0	23.80	23.81	25.74	25.75
		0	6#0	5#0	23.22	21.71	25.16	23.65
	20175/1732.5	0	1#0	1#0	23.86	23.85	25.86	25.85
		0	6#0	5#0	23.23	21.79	25.23	23.79
	20375/1752.5	0	1#5	1#5	23.52	23.94	25.46	25.88
		0	6#0	5#0	23.36	21.85	25.30	23.79
10MHz	20000/1715	3	1#0	1#0	23.78	23.80	25.72	25.74
		0	4#0	4#0	23.96	22.78	25.90	24.72
	20175/1732.5	0	1#0	1#0	23.83	23.85	25.83	25.85
		0	4#0	4#0	22.95	22.89	24.95	24.89
	20350/1750	4	1#5	1#5	23.59	23.94	25.53	25.88
		7	4#2	4#2	23.81	22.06	25.75	24.00
15MHz	20025/1717.5	3	1#0	1#0	23.78	23.84	25.72	25.78
		0	6#0	5#0	23.61	23.74	25.55	25.68
	20175/1732.5	0	1#0	1#0	23.78	23.75	25.78	25.75
		0	6#0	5#0	23.69	23.70	25.69	25.70
	20325/1747.5	8	1#5	1#5	23.52	23.99	25.52	25.99
		11	6#0	5#0	23.81	23.89	25.81	25.89
20MHz	20050/1720	3	1#0	1#0	23.76	23.78	25.70	25.72
		0	6#0	5#0	23.62	23.64	25.56	25.58
	20175/1732.5	0	1#0	1#0	23.77	23.82	25.77	25.82

		0	6#0	5#0	23.65	23.72	25.65	25.72
	20300/1745	12	1#5	1#5	23.58	23.95	25.58	25.95
		15	6#0	5#0	23.75	23.90	25.75	25.90

LTE eMTC Band12	Channel/ Frequency(MHz)	Index	RB# RBstart		Maximum Output Power(dBm)		ERP (dBm)	
			QPSK	16QAM	QPSK	16QAM	QPSK	16QAM
1.4MHz	23017/699.7	0	1#0	1#0	23.78	22.77	23.29	22.28
		0	6#0	5#0	22.43	22.02	21.94	21.53
	23095/707.5	0	1#0	1#0	23.43	22.40	24.54	23.51
		0	6#0	5#0	22.02	21.57	23.13	22.68
	23173/715.3	0	1#5	1#5	23.19	22.00	24.99	23.80
		0	6#0	5#0	21.64	21.16	23.44	22.96
3MHz	23025/700.5	0	1#0	1#0	23.93	23.12	23.44	22.63
		0	6#0	5#0	22.28	22.01	21.79	21.52
	23095/707.5	0	1#0	1#0	23.57	22.72	24.68	23.83
		0	6#0	5#0	21.86	21.58	22.97	22.69
	23165/714.5	1	1#5	1#5	22.35	22.36	23.46	23.47
		0	6#0	5#0	21.56	21.29	22.67	22.40
5MHz	23035/701.5	3	1#0	1#0	23.77	23.84	23.28	23.35
		0	6#0	5#0	23.25	22.03	22.76	21.54
	23095/707.5	0	1#0	1#0	23.62	23.68	24.73	24.79
		0	6#0	5#0	22.93	21.74	24.04	22.85
	23155/713.5	0	1#5	1#5	23.44	23.40	24.55	24.51
		0	6#0	5#0	22.65	21.44	23.76	22.55
10MHz	23060/704	3	1#0	1#0	23.76	23.82	23.27	23.33
		0	4#0	4#0	23.04	23.05	22.55	22.56
	23095/707.5	0	1#0	1#0	23.67	23.80	24.78	24.91
		0	4#0	4#0	23.97	22.89	25.08	24.00
	23130/711	4	1#5	1#5	23.44	23.42	24.55	24.53
		7	4#2	4#2	22.99	21.36	24.10	22.47
LTE eMTC Band13	Channel/ Frequency(MHz)	Index	RB# RBstart		Maximum Output Power(dBm)		ERP (dBm)	
			QPSK	16QAM	QPSK	16QAM	QPSK	16QAM
5MHz	23205/779.5	3	1#0	1#0	23.55	23.60	25.85	25.90
		0	6#0	5#0	22.37	21.51	24.67	23.81
	23230/782	0	1#0	1#0	23.54	23.62	25.84	25.92
		0	6#0	5#0	22.82	21.73	25.12	24.03
	23255/784.5	0	1#5	1#5	23.72	23.61	26.02	25.91
		0	6#0	5#0	22.91	21.67	25.21	23.97
10MHz	23230/782	0	1#0	1#0	23.53	23.51	25.83	25.81
		0	4#0	4#0	23.78	22.62	26.08	24.92
LTE eMTC	Channel/	Index	RB#		Maximum Output		EIRP (dBm)	

Band66	Frequency(MHz)		RBstart		Power(dBm)			
			QPSK	16QAM	QPSK	16QAM	QPSK	16QAM
1.4MHz	131979/1710.7	0	1#0	1#0	23.48	22.31	25.42	24.25
		0	6#0	5#0	23.22	21.70	25.16	23.64
	132322/1745	0	1#0	1#0	23.60	22.44	25.60	24.44
		0	6#0	5#0	22.35	21.81	24.35	23.81
	132665/1779.3	0	1#5	1#5	23.21	22.81	24.18	23.78
		0	6#0	5#0	22.62	22.09	23.59	23.06
3MHz	131987/1711.5	0	1#0	1#0	23.69	22.68	25.63	24.62
		0	6#0	5#0	21.99	21.72	23.93	23.66
	132322/1745	0	1#0	1#0	23.78	22.74	25.78	24.74
		0	6#0	5#0	22.08	21.81	24.08	23.81
	132657/1778.5	1	1#5	1#5	23.02	23.04	23.99	24.01
		0	6#0	5#0	23.25	22.13	24.22	23.10
5MHz	131997/1712.5	3	1#0	1#0	23.68	23.65	25.62	25.59
		0	6#0	5#0	23.05	21.70	24.99	23.64
	132322/1745	0	1#0	1#0	23.79	23.72	25.79	25.72
		0	6#0	5#0	23.17	21.76	25.17	23.76
	132647/1777.5	0	1#5	1#5	22.82	23.90	23.79	24.87
		0	6#0	5#0	23.41	22.03	24.38	23.00
10MHz	132022/1715	3	1#0	1#0	23.65	23.64	25.59	25.58
		0	4#0	4#0	23.85	22.65	25.79	24.59
	132322/1745	0	1#0	1#0	23.71	23.72	25.71	25.72
		0	4#0	4#0	23.77	22.73	25.77	24.73
	132622/1775	4	1#5	1#5	22.93	23.24	23.90	24.21
		7	4#2	4#2	23.93	22.10	24.90	23.07
15MHz	132047/1717.5	3	1#0	1#0	23.66	23.65	25.60	25.59
		0	6#0	5#0	23.65	23.60	25.59	25.54
	132322/1745	0	1#0	1#0	23.70	23.69	25.70	25.69
		0	6#0	5#0	23.74	23.67	25.74	25.67
	132597/1772.5	8	1#5	1#5	22.88	23.97	23.85	24.94
		11	6#0	5#0	23.10	23.99	24.07	24.96
20MHz	132072/1720	3	1#0	1#0	23.92	23.64	25.86	25.58
		0	6#0	5#0	23.65	23.59	25.59	25.53
	132322/1745	0	1#0	1#0	23.68	23.69	25.68	25.69
		0	6#0	5#0	23.68	23.61	25.68	25.61
	132572/1770	12	1#5	1#5	23.12	23.94	24.09	24.91
		15	6#0	5#0	23.04	23.99	24.01	24.96

6.2 Occupied Bandwidth

Mode	Bandwidth	Modulation	Channel/ Frequency(MHz)	Bandwidth(MHz)		
				99% Power	-26dBc	
LTE eMTC Band4	1.4MHz	QPSK	20175/1732.5	1.105	1.341	
		16QAM	20175/1732.5	0.976	1.342	
	3MHz	QPSK	20175/1732.5	1.110	1.346	
		16QAM	20175/1732.5	0.961	1.309	
	5MHz	QPSK	20175/1732.5	1.100	1.316	
		16QAM	20175/1732.5	0.975	1.317	
	10MHz	QPSK	20175/1732.5	1.108	1.333	
		16QAM	20175/1732.5	0.999	1.333	
	15MHz	QPSK	20175/1732.5	1.120	1.344	
		16QAM	20175/1732.5	1.001	1.353	
	20MHz	QPSK	20175/1732.5	1.113	1.352	
		16QAM	20175/1732.5	1.004	1.354	
	Mode	Bandwidth	Modulation	Channel/ Frequency(MHz)	Bandwidth(MHz)	
	LTE eMTC Band12	1.4MHz	QPSK	23095/707.5	0.973	1.327
16QAM			23095/707.5	0.966	1.302	
3MHz		QPSK	23095/707.5	1.109	1.343	
		16QAM	23095/707.5	0.965	1.308	
5MHz		QPSK	23095/707.5	1.099	1.332	
		16QAM	23095/707.5	0.977	1.314	
10MHz		QPSK	23095/707.5	1.100	1.332	
		16QAM	23095/707.5	0.994	1.322	
Mode		Bandwidth	Modulation	Channel/ Frequency(MHz)	Bandwidth(MHz)	
LTE eMTC Band13		5MHz	QPSK	23230/782	1.103	1.331
			16QAM	23230/782	0.976	1.312
		10MHz	QPSK	23230/782	1.107	1.334
			16QAM	23230/782	0.993	1.322
Mode		Bandwidth	Modulation	Channel/ Frequency(MHz)	Bandwidth(MHz)	
LTE eMTC Band66	1.4MHz	QPSK	132322/1745	1.099	1.321	
		16QAM	132322/1745	0.952	1.294	
	3MHz	QPSK	132322/1745	1.108	1.335	
		16QAM	132322/1745	0.958	1.299	
	5MHz	QPSK	132322/1745	1.101	1.323	
		16QAM	132322/1745	0.995	1.448	
	10MHz	QPSK	132322/1745	1.107	1.340	
		16QAM	132322/1745	0.994	1.317	

	15MHz	QPSK	132322/1745	1.120	1.360
		16QAM	132322/1745	0.991	1.317
	20MHz	QPSK	132322/1745	1.117	1.353
		16QAM	132322/1745	0.997	1.346

LTE eMTC Band 4 QPSK 1.4MHz CH-Middle



LTE eMTC Band 4 QPSK 3MHz CH-Middle



LTE eMTC Band 4 QPSK 5MHz CH-Middle



LTE eMTC Band 4 QPSK 10MHz CH-Middle



LTE eMTC Band 4 QPSK 15MHz CH-Middle



LTE eMTC Band 4 QPSK 20MHz CH-Middle



LTE eMTC Band 4 16QAM 1.4MHz CH-Middle



LTE eMTC Band 4 16QAM 3MHz CH-Middle



LTE eMTC Band 4 16QAM 5MHz CH-Middle



LTE eMTC Band 4 16QAM 10MHz CH-Middle

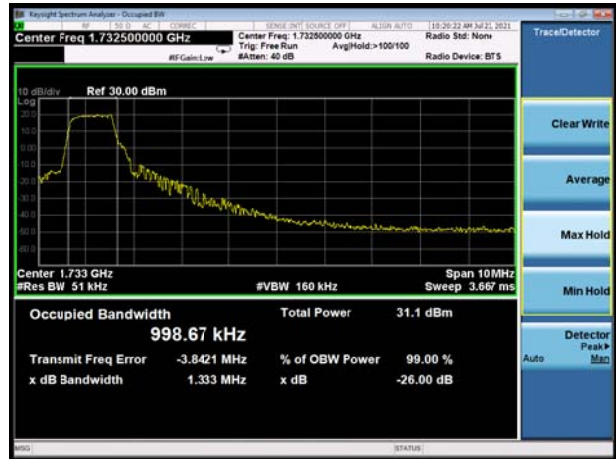

LTE eMTC Band 4 16QAM 15MHz CH-Middle



LTE eMTC Band 4 16QAM 20MHz CH-Middle

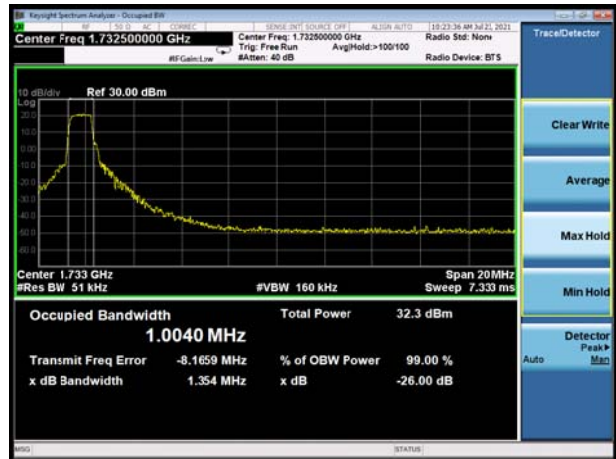

LTE eMTC Band 12 QPSK 1.4MHz CH-Middle



LTE eMTC Band 12 QPSK 3MHz CH-Middle



LTE eMTC Band 12 QPSK 5MHz CH-Middle



LTE eMTC Band 12 QPSK 10MHz CH-Middle



LTE eMTC Band 12 16QAM 1.4MHz CH-Middle



LTE eMTC Band 12 16QAM 3MHz CH-Middle



LTE eMTC Band 12 16QAM 5MHz CH-Middle



LTE eMTC Band 12 16QAM 10MHz CH-Middle



LTE eMTC Band 13 QPSK 5MHz CH-Middle



LTE eMTC Band 13 QPSK 10MHz CH-Middle



LTE eMTC Band 13 16QAM 5MHz CH-Middle



LTE eMTC Band 13 16QAM 10MHz CH-Middle



LTE eMTC Band 66 QPSK 1.4MHz CH-Middle



LTE eMTC Band 66 QPSK 3MHz CH-Middle



LTE eMTC Band 66 QPSK 5MHz CH-Middle



LTE eMTC Band 66 QPSK 10MHz CH-Middle



LTE eMTC Band 66 QPSK 15MHz CH-Middle



LTE eMTC Band 66 QPSK 20MHz CH-Middle



LTE eMTC Band 66 16QAM 1.4MHz CH-Middle



LTE eMTC Band 66 16QAM 3MHz CH-Middle



LTE eMTC Band 66 16QAM 5MHz CH-Middle



LTE eMTC Band 66 16QAM 10MHz CH-Middle



LTE eMTC Band 66 16QAM 15MHz CH-Middle



LTE eMTC Band 66 16QAM 20MHz CH-Middle



6.3 Band Edge Compliance

All the test traces in the plots shows the test results clearly.

LTE eMTC Band 4 QPSK 1.4MHz CH-Low, 1 RB

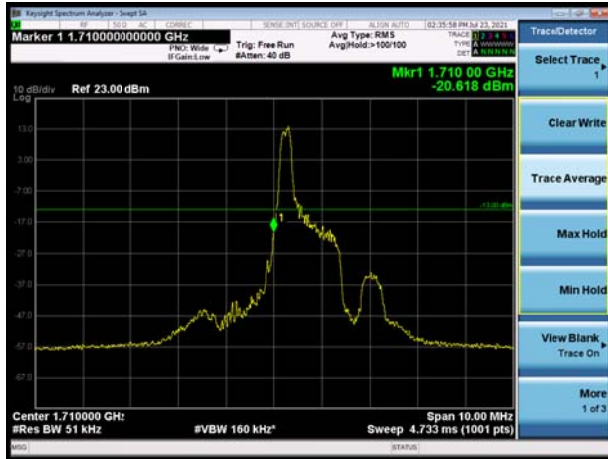

LTE eMTC Band 4 QPSK 1.4MHz CH-High, 1 RB



LTE eMTC Band 4 QPSK 1.4MHz CH-Low, 100%RB



LTE eMTC Band 4 QPSK 1.4MHz CH-High, 100%RB



LTE eMTC Band 4 QPSK 3MHz CH-Low, 1 RB

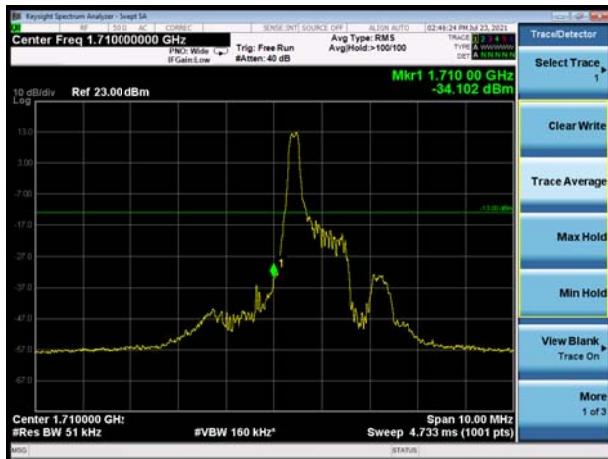

LTE eMTC Band 4 QPSK 3MHz CH-High, 1 RB

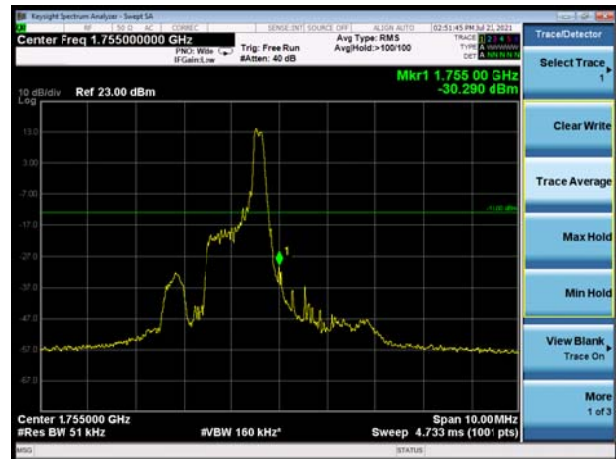

LTE eMTC Band 4 QPSK 3MHz CH-Low, 100%RB

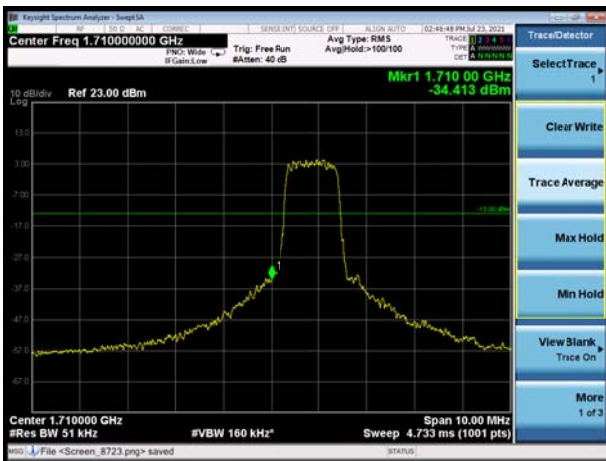

LTE eMTC Band 4 QPSK 3MHz CH-High, 100%RB



LTE eMTC Band 4 QPSK 5MHz CH-Low, 1 RB



LTE eMTC Band 4 QPSK 5MHz CH-High, 1 RB



LTE eMTC Band 4 QPSK 5MHz CH-Low, 100%RB

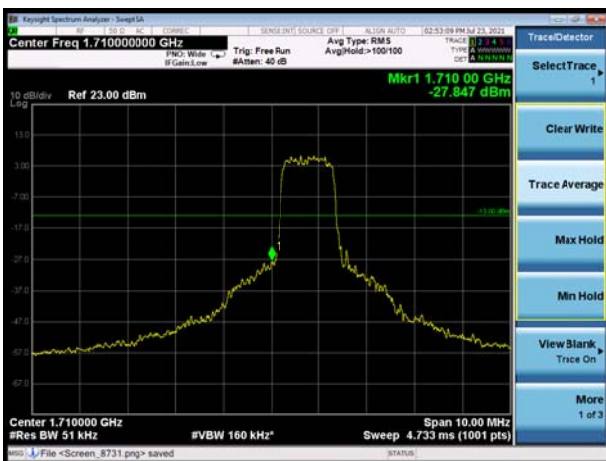

LTE eMTC Band 4 QPSK 5MHz CH-High, 100%RB



LTE eMTC Band 4 QPSK 10MHz CH-Low, 1 RB

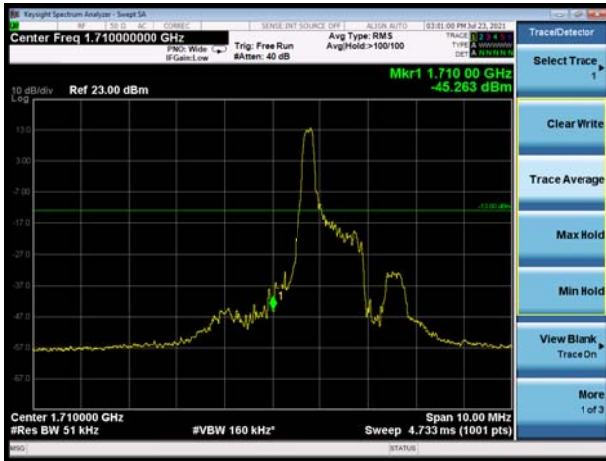

LTE eMTC Band 4 QPSK 10MHz CH-High, 1 RB

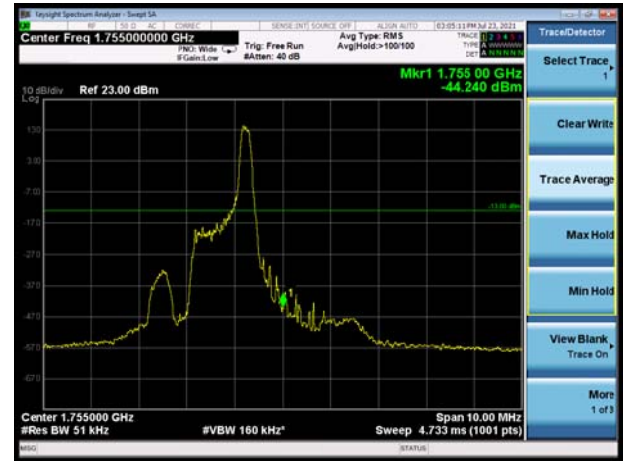

LTE eMTC Band 4 QPSK 10MHz CH-Low, 100%RB

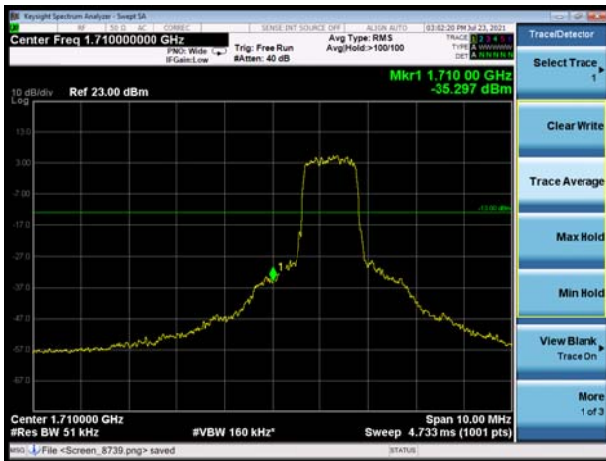

LTE eMTC Band 4 QPSK 10MHz CH-High, 100%RB

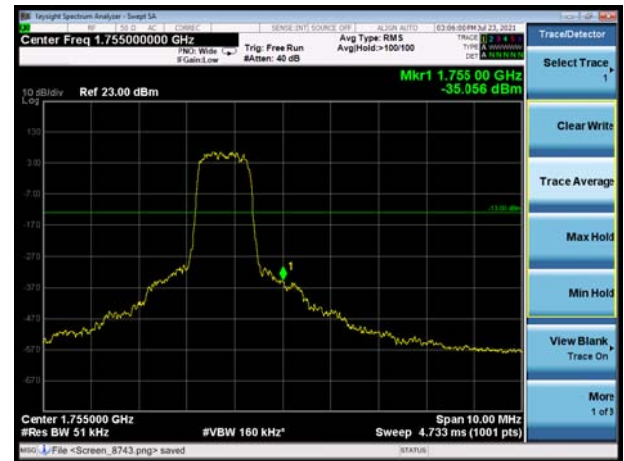

LTE eMTC Band 4 QPSK 15MHz CH-Low, 1 RB

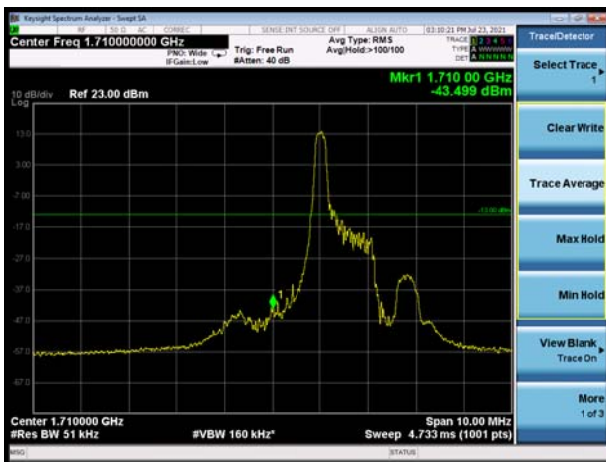

LTE eMTC Band 4 QPSK 15MHz CH-High, 1 RB



LTE eMTC Band 4 QPSK 15MHz CH-Low, 100%RB

LTE eMTC Band 4 QPSK 15MHz CH-High, 100%RB

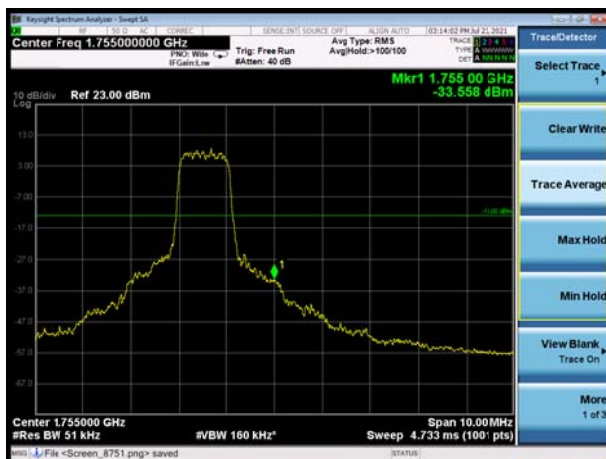
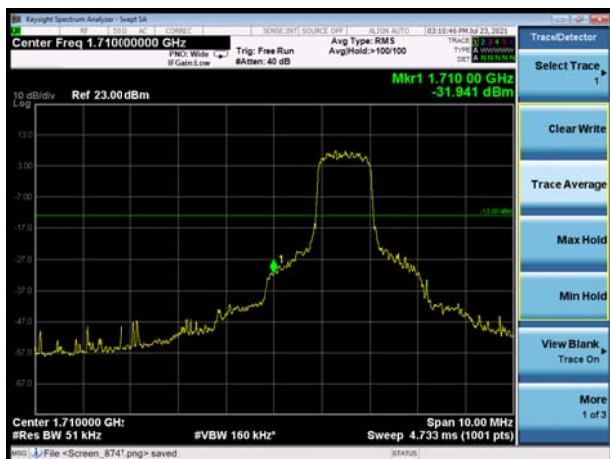

LTE eMTC Band 4 QPSK 20MHz CH-Low, 1 RB

LTE eMTC Band 4 QPSK 20MHz CH-High, 1 RB



LTE eMTC Band 4 QPSK 20MHz CH-Low, 100%RB

LTE eMTC Band 4 QPSK 20MHz CH-High, 100%RB

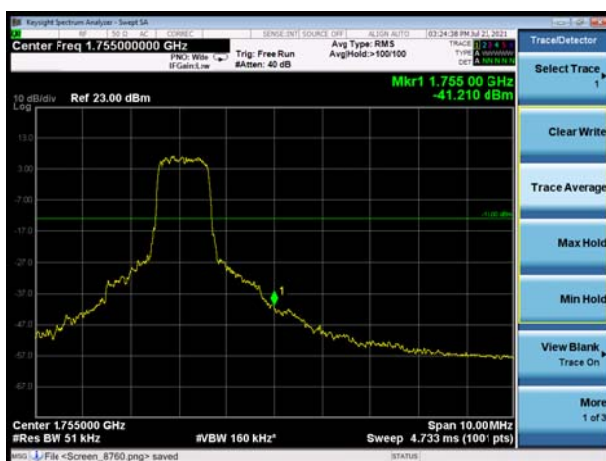
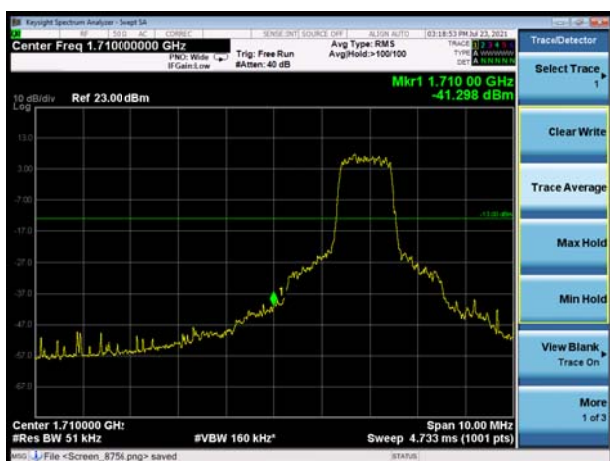

LTE eMTC Band 4 16QAM 1.4MHz CH-Low, 1 RB



LTE eMTC Band 4 16QAM 1.4MHz CH-High, 1 RB



LTE eMTC Band 4 16QAM 1.4MHz CH-Low, 100%RB

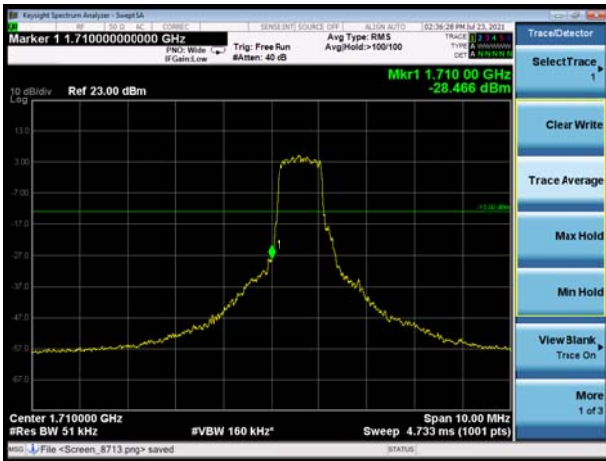

LTE eMTC Band 4 16QAM 1.4MHz CH-High, 100%RB

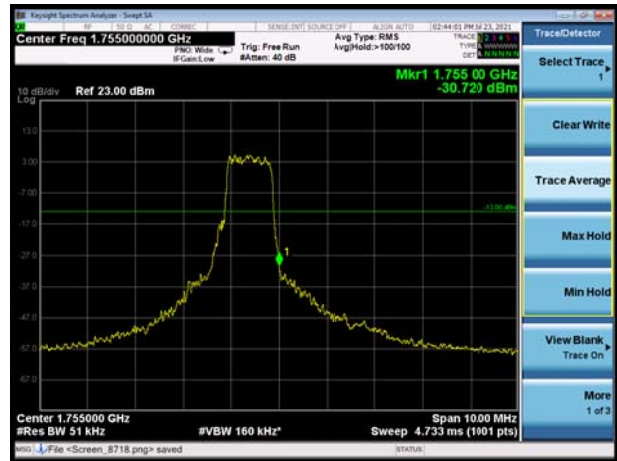

LTE eMTC Band 4 16QAM 3MHz CH-Low, 1 RB



LTE eMTC Band 4 16QAM 3MHz CH-High, 1 RB



LTE eMTC Band 4 16QAM 3MHz CH-Low, 100%RB

LTE eMTC Band 4 16QAM 3MHz CH-High, 100%RB

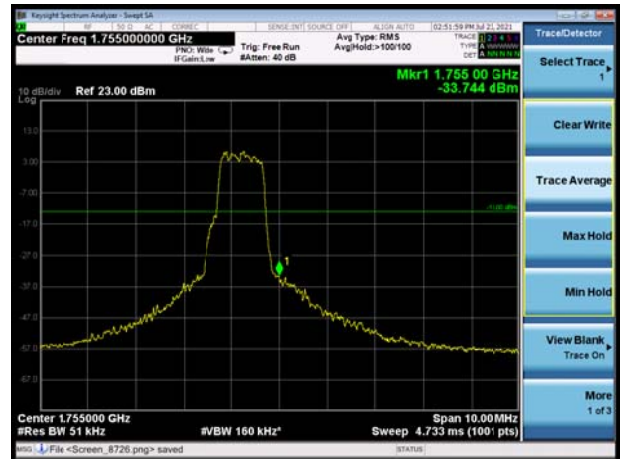
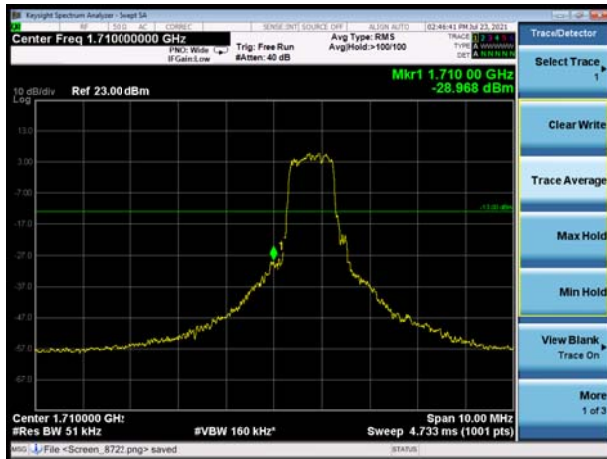

LTE eMTC Band 4 16QAM 5MHz CH-Low, 1 RB

LTE eMTC Band 4 16QAM 5MHz CH-High, 1 RB



LTE eMTC Band 4 16QAM 5MHz CH-Low, 100%RB

LTE eMTC Band 4 16QAM 5MHz CH-High, 100%RB

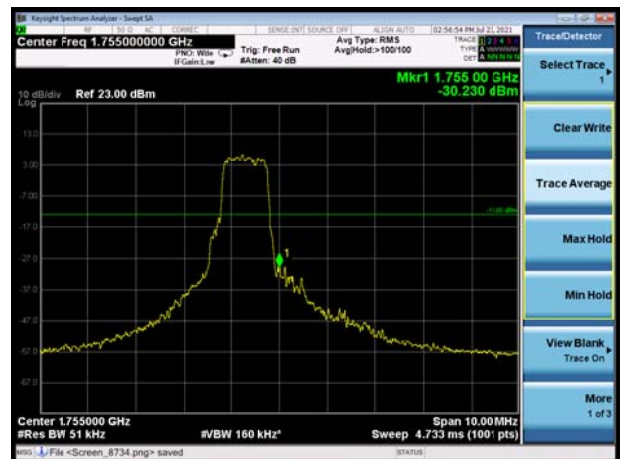
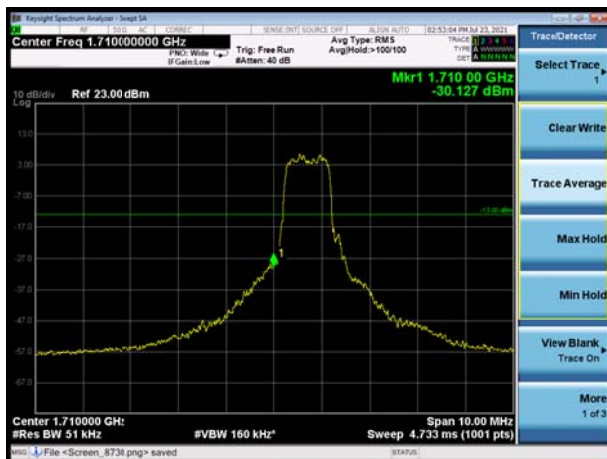

LTE eMTC Band 4 16QAM 10MHz CH-Low, 1 RB



LTE eMTC Band 4 16QAM 10MHz CH-High, 1 RB



LTE eMTC Band 4 16QAM 10MHz CH-Low, 100%RB

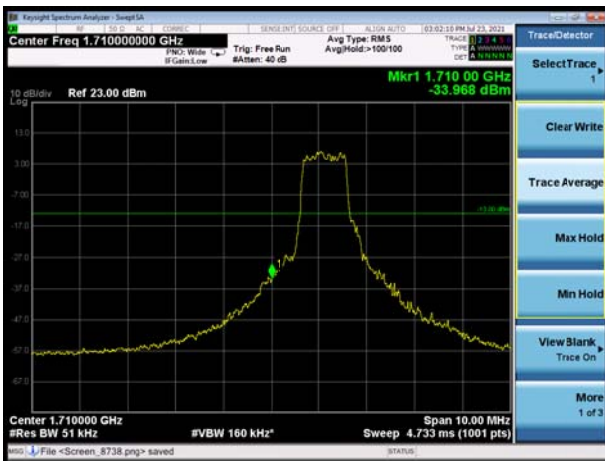

LTE eMTC Band 4 16QAM 10MHz CH-High, 100%RB



LTE eMTC Band 4 16QAM 15MHz CH-Low, 1 RB

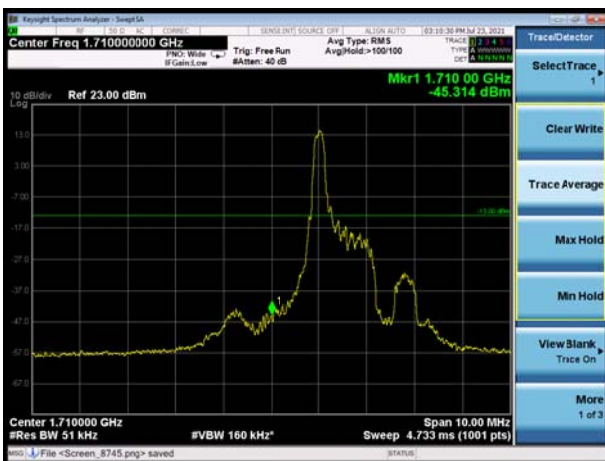

LTE eMTC Band 4 16QAM 15MHz CH-High, 1 RB

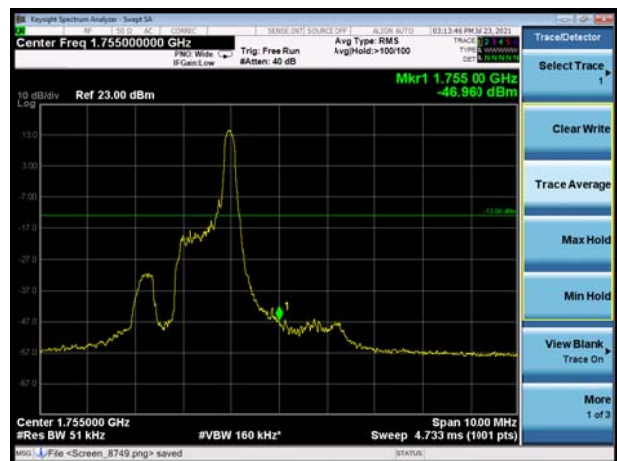

LTE eMTC Band 4 16QAM 15MHz CH-Low, 100%RB

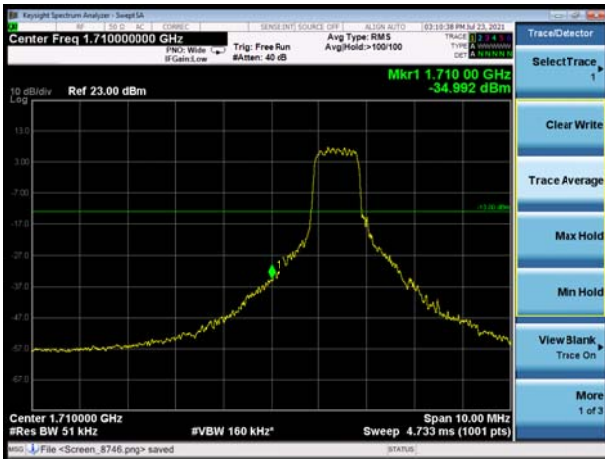

LTE eMTC Band 4 16QAM 15MHz CH-High, 100%RB

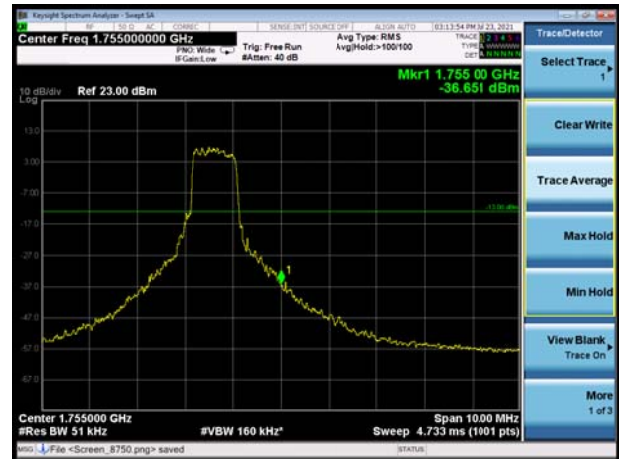

LTE eMTC Band 4 16QAM 20MHz CH-Low, 1 RB



LTE eMTC Band 4 16QAM 20MHz CH-High, 1 RB



LTE eMTC Band 4 16QAM 20MHz CH-Low, 100%RB

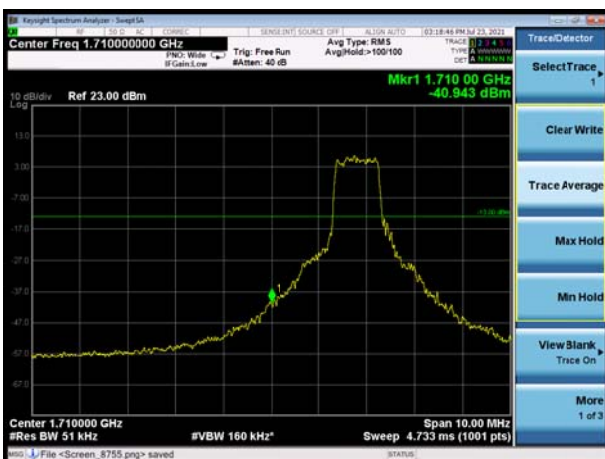

LTE eMTC Band 4 16QAM 20MHz CH-High, 100%RB

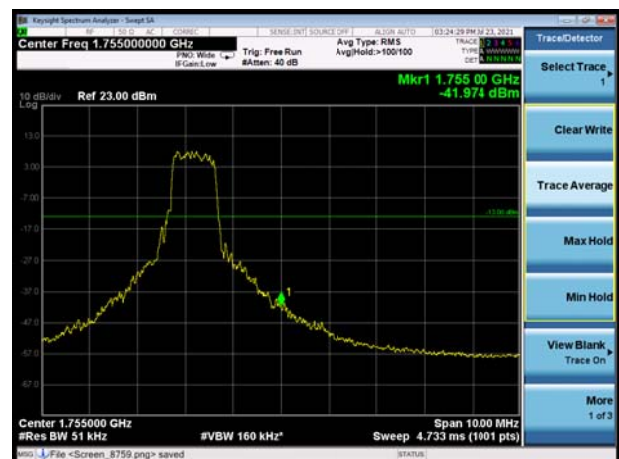

LTE eMTC Band 12 QPSK 1.4MHz CH-Low, 1 RB

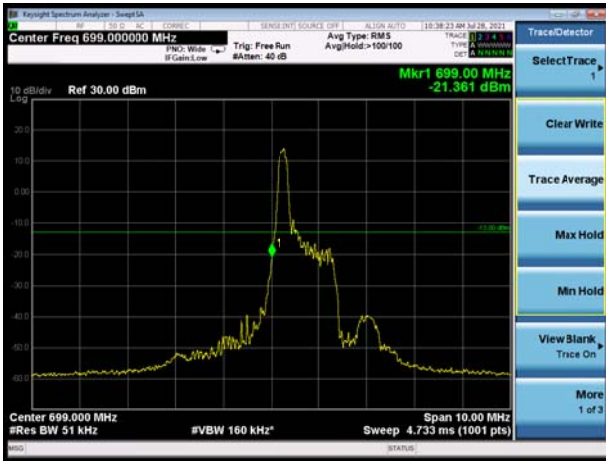

LTE eMTC Band 12 QPSK 1.4MHz CH-High, 1 RB



LTE eMTC Band 12 QPSK 1.4MHz CH-Low, 100%RB

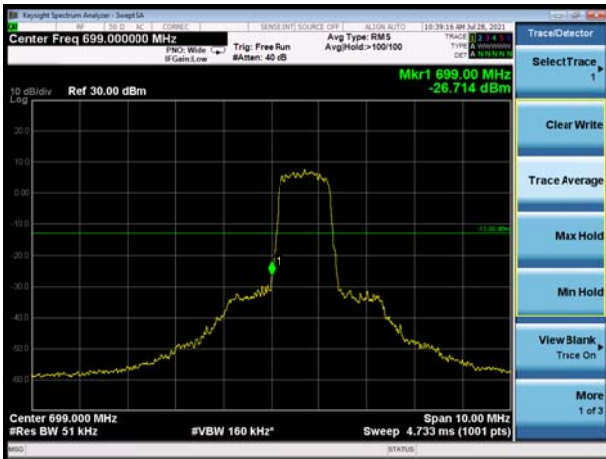

LTE eMTC Band 12 QPSK 1.4MHz CH-High, 100%RB

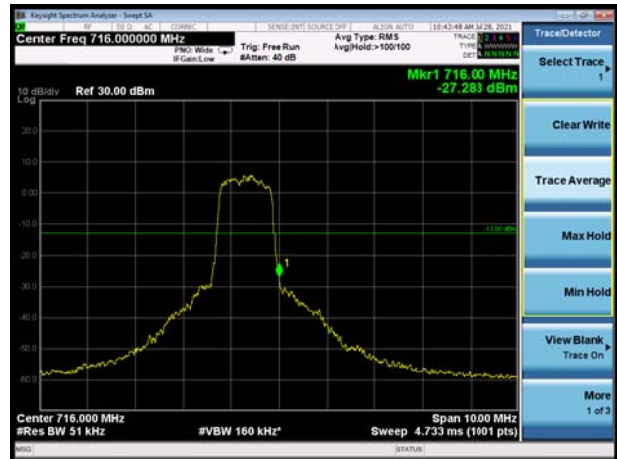

LTE eMTC Band 12 QPSK 3MHz CH-Low, 1 RB



LTE eMTC Band 12 QPSK 3MHz CH-High, 1 RB

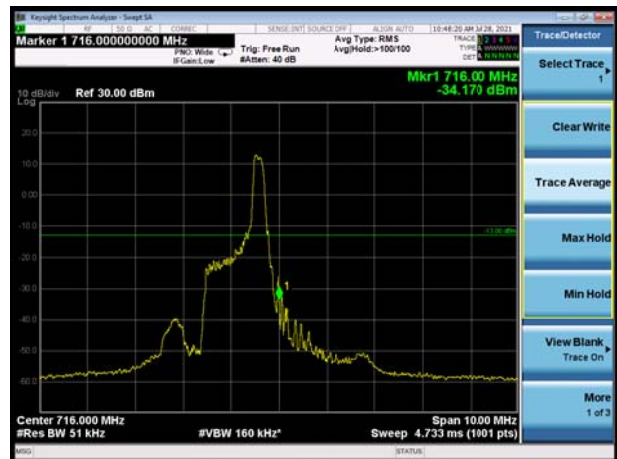

LTE eMTC Band 12 QPSK 3MHz CH-Low, 100%RB

LTE eMTC Band 12 QPSK 3MHz CH-High, 100%RB

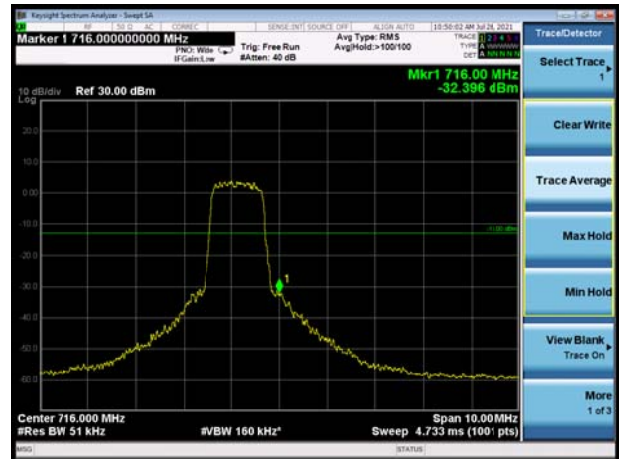
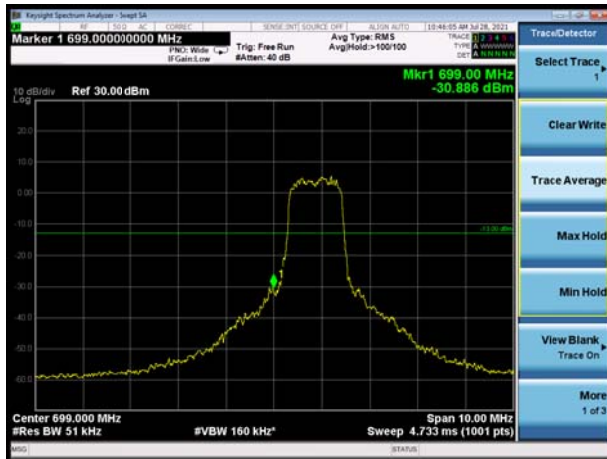

LTE eMTC Band 12 QPSK 5MHz CH-Low, 1 RB

LTE eMTC Band 12 QPSK 5MHz CH-High, 1 RB



LTE eMTC Band 12 QPSK 5MHz CH-Low, 100%RB

LTE eMTC Band 12 QPSK 5MHz CH-High, 100%RB

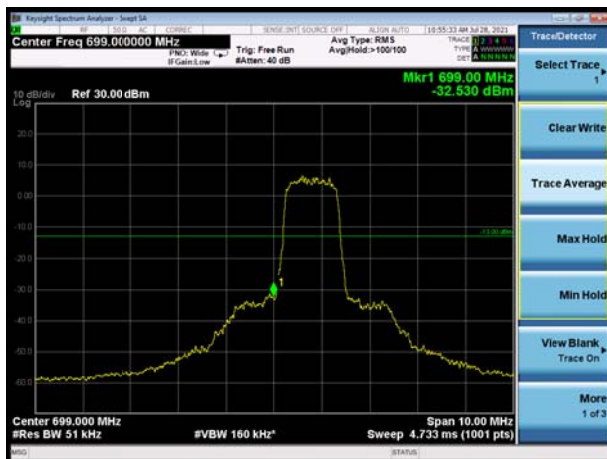

LTE eMTC Band 12 QPSK 10MHz CH-Low, 1 RB

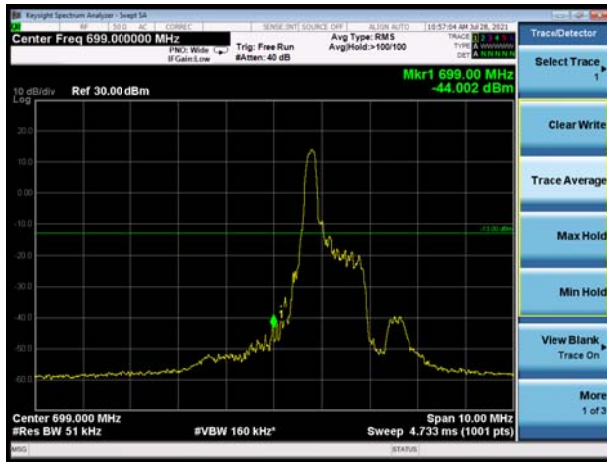

LTE eMTC Band 12 QPSK 10MHz CH-High, 1 RB

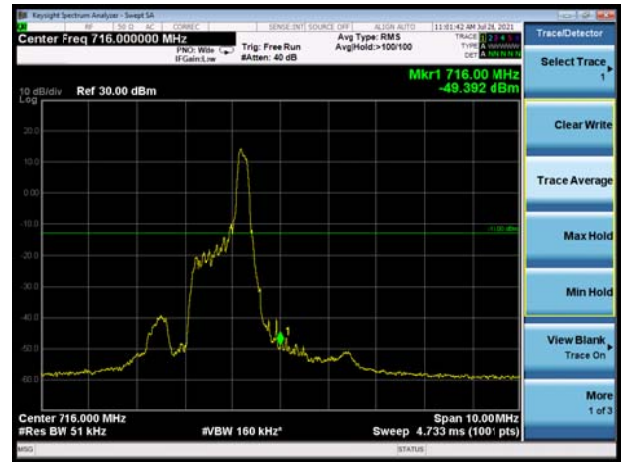

LTE eMTC Band 12 QPSK 10MHz CH-Low, 100%RB

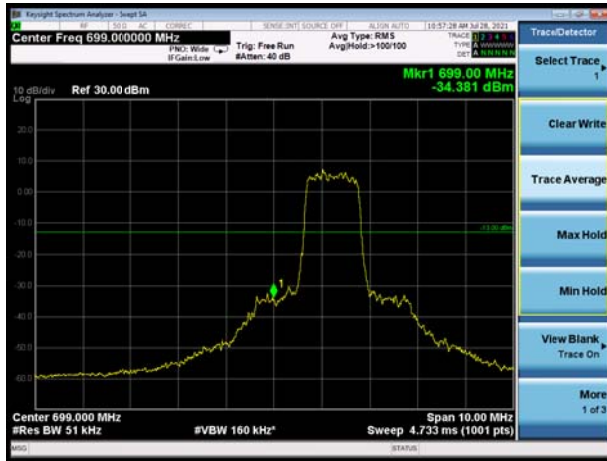

LTE eMTC Band 12 QPSK 10MHz CH-High, 100%RB

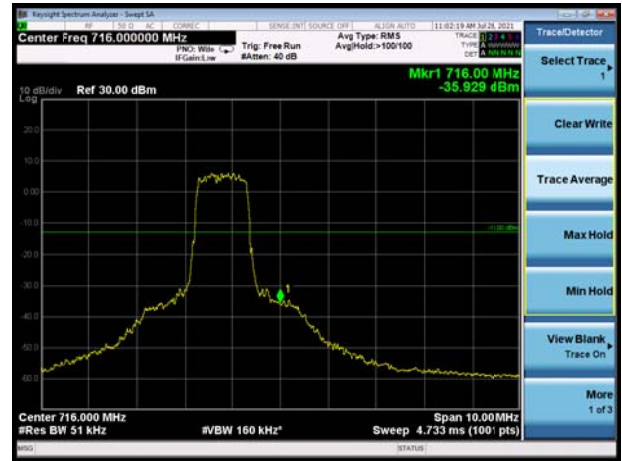

LTE eMTC Band 12 16QAM 1.4MHz CH-Low, 1 RB

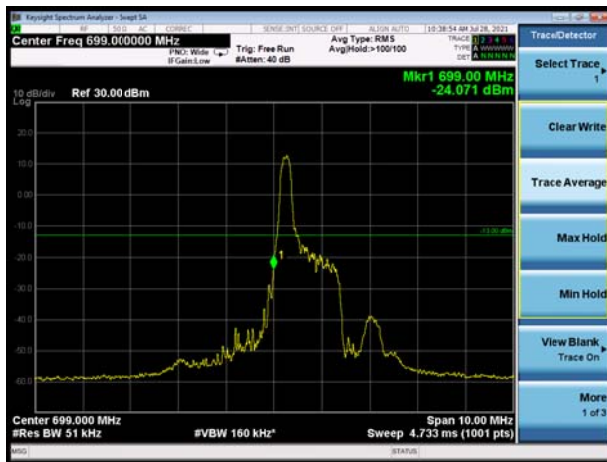

LTE eMTC Band 12 16QAM 1.4MHz CH-High, 1 RB



LTE eMTC Band 12 16QAM 1.4MHz CH-Low, 100%RB

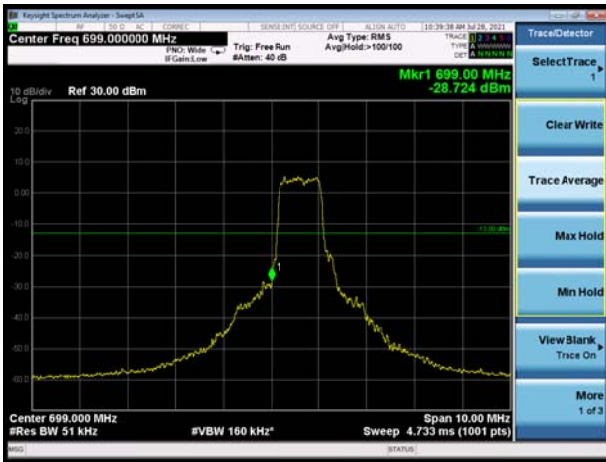

LTE eMTC Band 12 16QAM 1.4MHz CH-High, 100%RB

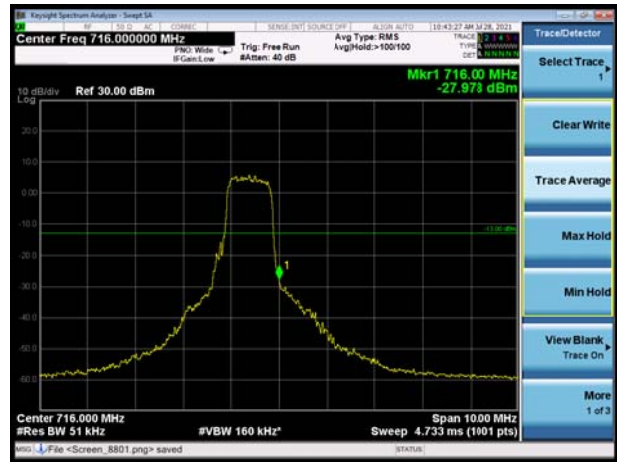

LTE eMTC Band 12 16QAM 3MHz CH-Low, 1 RB

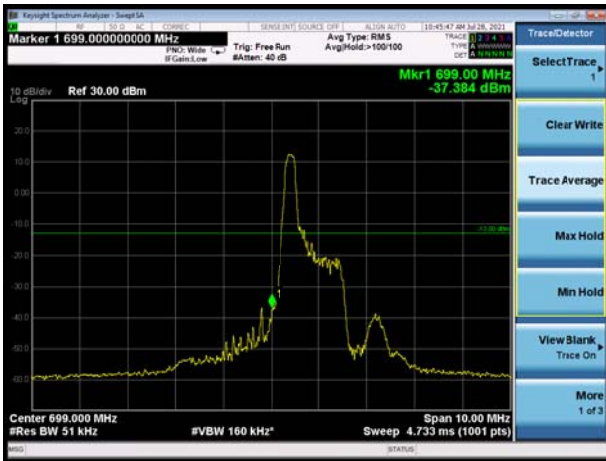

LTE eMTC Band 12 16QAM 3MHz CH-High, 1 RB



LTE eMTC Band 12 16QAM 3MHz CH-Low, 100%RB

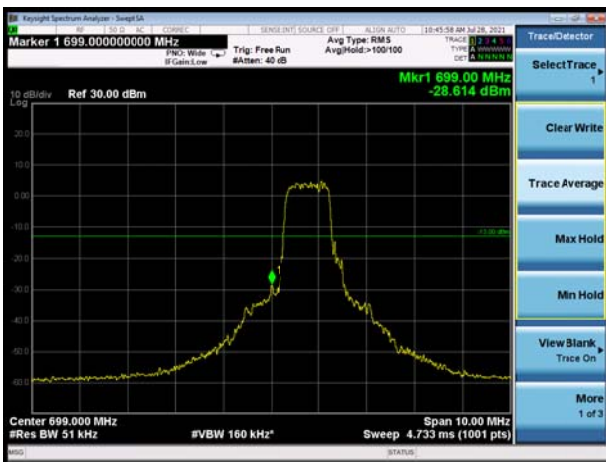

LTE eMTC Band 12 16QAM 3MHz CH-High, 100%RB

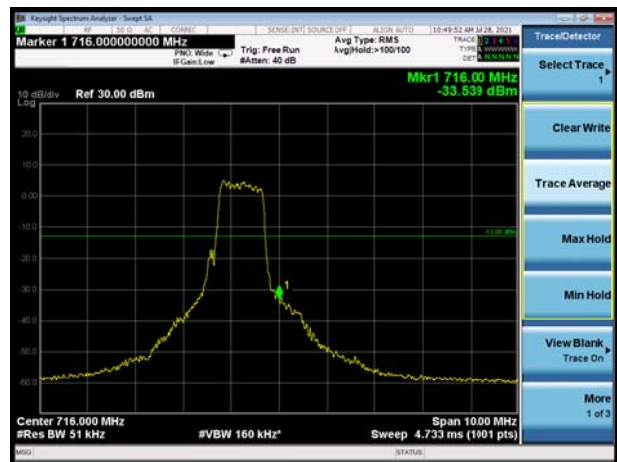

LTE eMTC Band 12 16QAM 5MHz CH-Low, 1 RB



LTE eMTC Band 12 16QAM 5MHz CH-High, 1 RB



LTE eMTC Band 12 16QAM 5MHz CH-Low, 100%RB

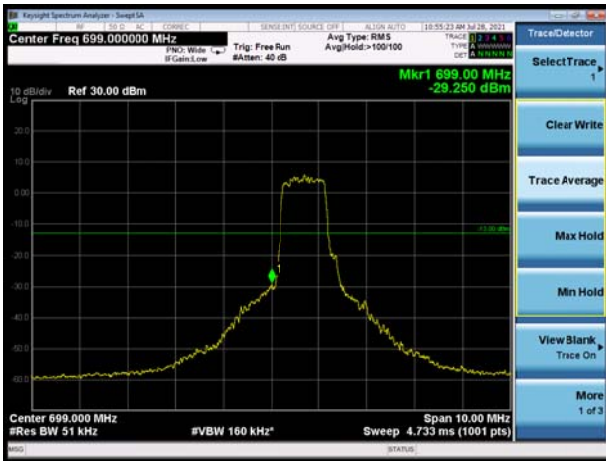

LTE eMTC Band 12 16QAM 5MHz CH-High, 100%RB

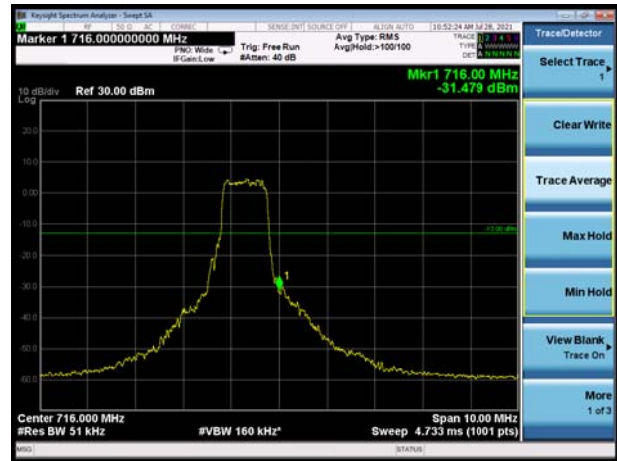

LTE eMTC Band 12 16QAM 10MHz CH-Low, 1 RB

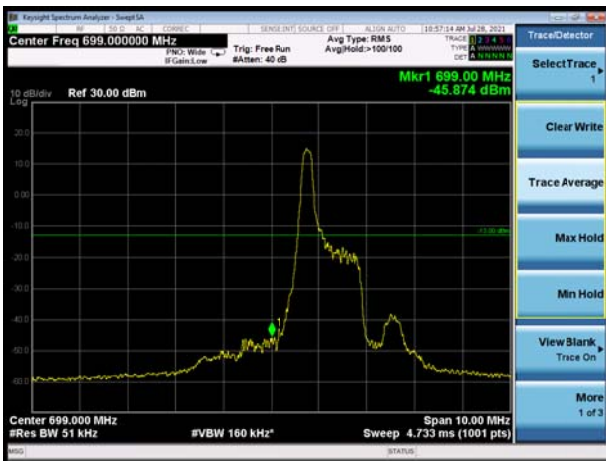

LTE eMTC Band 12 16QAM 10MHz CH-High, 1 RB



LTE eMTC Band 12 16QAM 10MHz CH-Low, 100%RB

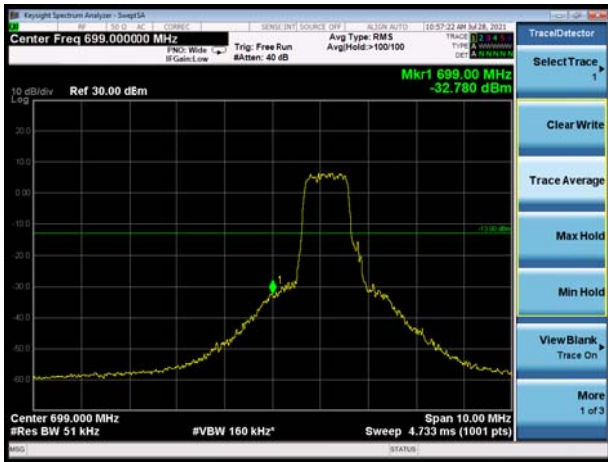

LTE eMTC Band 12 16QAM 10MHz CH-High, 100%RB

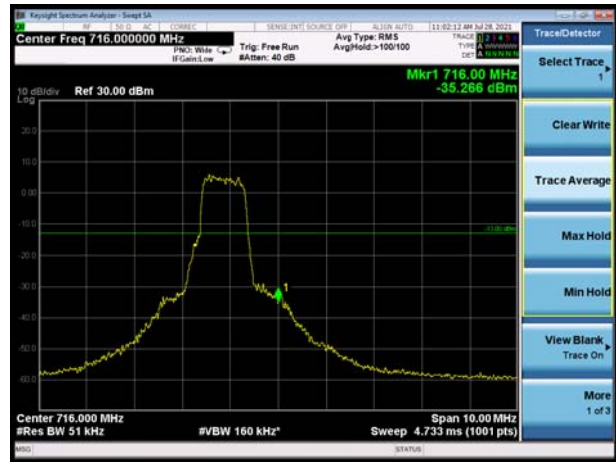

LTE eMTC Band 13 QPSK 5MHz CH-Low, 1 RB (763MHz ~775MHz)



LTE eMTC Band 13 QPSK 10MHz CH-Low, 1 RB (775MHz ~777MHz)

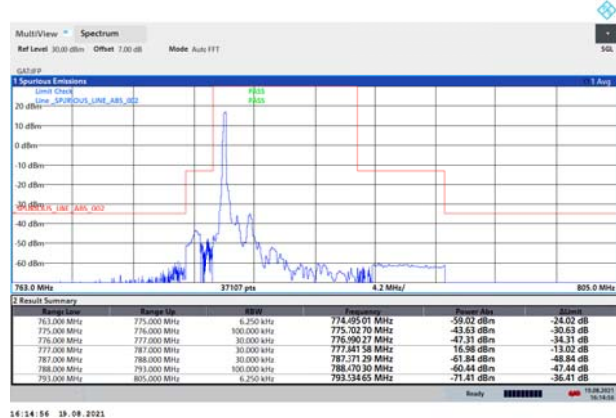

LTE eMTC Band 13 QPSK 5MHz CH-High, 1 RB (787MHz ~793MHz)

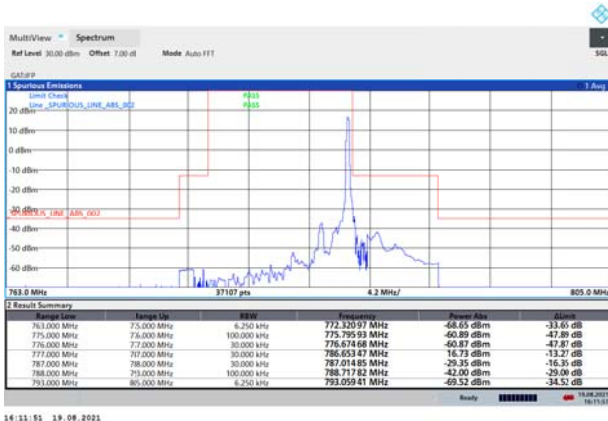

LTE eMTC Band 13 QPSK 10MHz CH-High, 1 RB (793MHz ~805MHz)

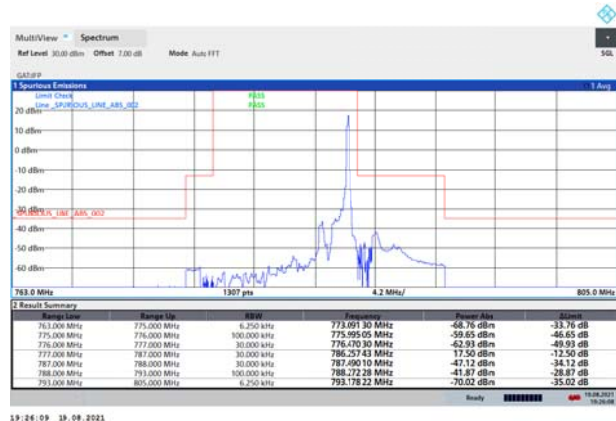

LTE eMTC Band 13 QPSK 5MHz CH-Low,
100%RB
(763MHz ~775MHz)

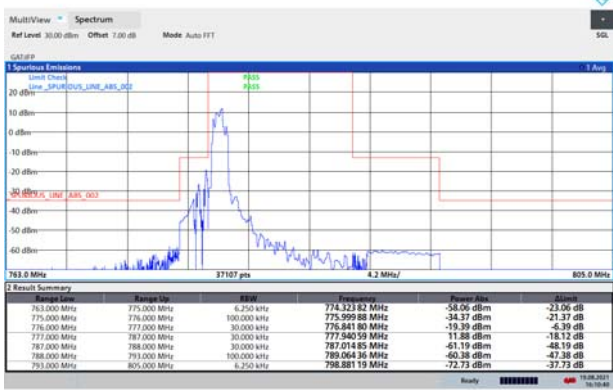

14:10:40 19-08-2021

LTE eMTC Band 13 QPSK 10MHz CH-Low,
100%RB
(775MHz ~777MHz)

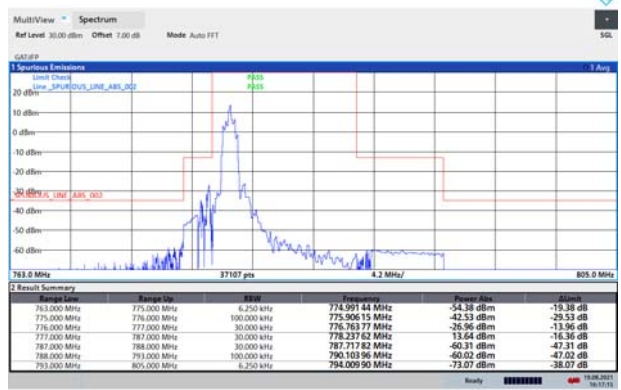

14:17:15 19-08-2021

LTE eMTC Band 13 QPSK 5MHz CH-High,
100%RB
(787MHz ~793MHz)



14:12:50 19-08-2021

LTE eMTC Band 13 QPSK 10MHz CH-High,
100%RB
(793MHz ~805MHz)



19:34:47 19-08-2021

LTE eMTC Band 13 16QAM 5MHz CH-Low, 1 RB
(763MHz ~775MHz)

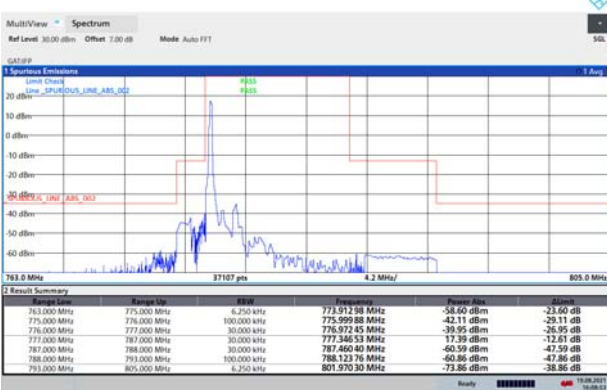

14:08:54 19-08-2021

LTE eMTC Band 13 16QAM 10MHz CH-Low, 1 RB
(775MHz ~777MHz)

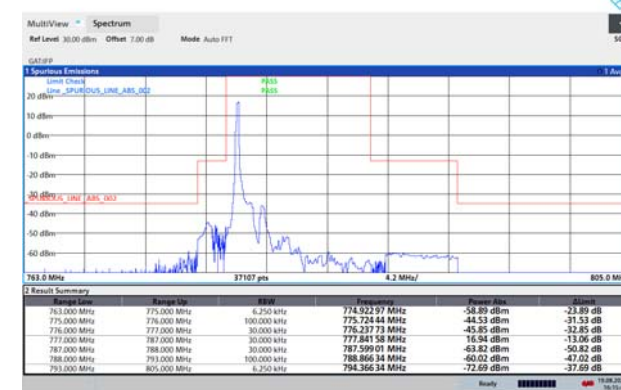

14:15:47 19-08-2021

LTE eMTC Band 13 16QAM 5MHz CH-High, 1 RB
(787MHz ~793MHz)



14:12:11 19-08-2021

LTE eMTC Band 13 16QAM 10MHz CH-High, 1 RB
(793MHz ~805MHz)



19:26:47 19-08-2021

LTE eMTC Band 13 16QAM 5MHz CH-Low, 100%RB
(763MHz ~775MHz)

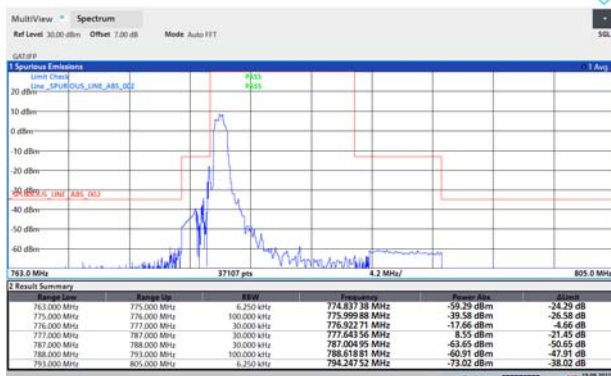

14:09:59 19-08-2021

LTE eMTC Band 13 16QAM 10MHz CH-Low, 100%RB
(775MHz ~777MHz)



14:14:24 19-08-2021

LTE eMTC Band 13 16QAM 5MHz CH-High, 100%RB
(787MHz ~793MHz)



14:12:34 19-08-2021

LTE eMTC Band 13 16QAM 10MHz CH-High, 100%RB
(793MHz ~805MHz)



19:35:04 19-08-2021

LTE eMTC Band 66 QPSK 1.4MHz CH-Low, 1 RB

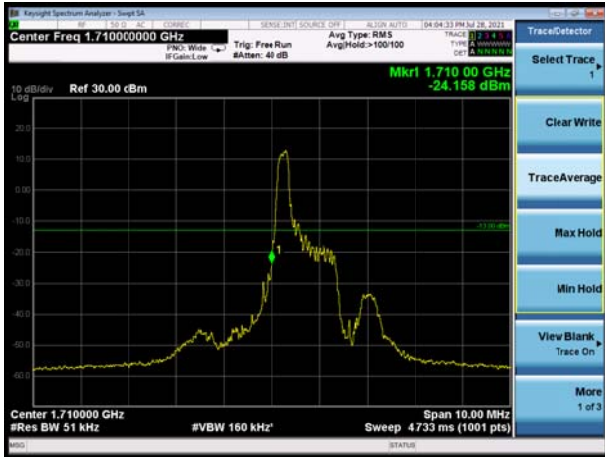

LTE eMTC Band 66 QPSK 1.4MHz CH-High, 1 RB



LTE eMTC Band 66 QPSK 1.4MHz CH-Low, 100%RB

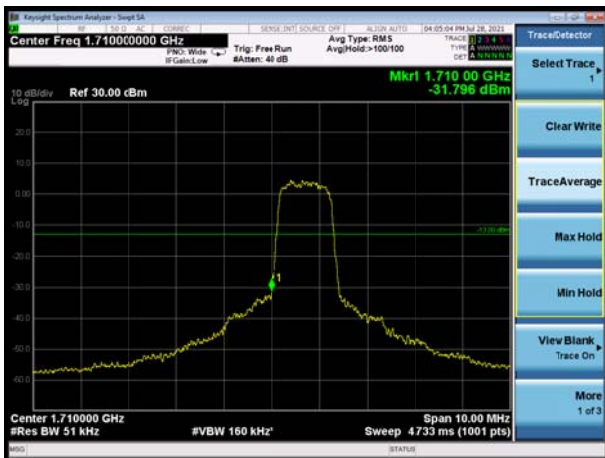

LTE eMTC Band 66 QPSK 1.4MHz CH-High, 100%RB



LTE eMTC Band 66 QPSK 3MHz CH-Low, 1 RB



LTE eMTC Band 66 QPSK 3MHz CH-High, 1 RB



LTE eMTC Band 66 QPSK 3MHz CH-Low, 100%RB



LTE eMTC Band 66 QPSK 3MHz CH-High, 100%RB

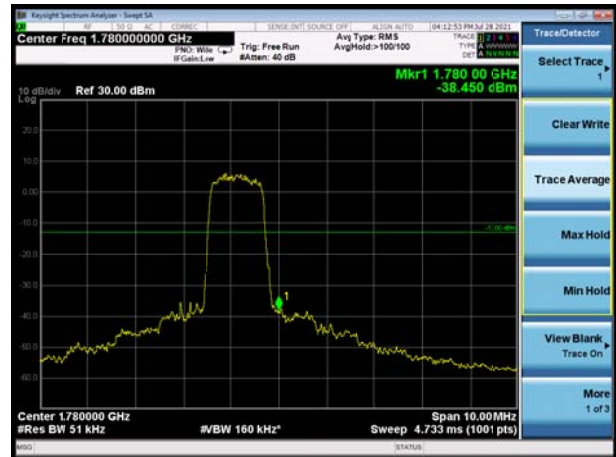

LTE eMTC Band 66 QPSK 5MHz CH-Low, 1 RB



LTE eMTC Band 66 QPSK 5MHz CH-High, 1 RB

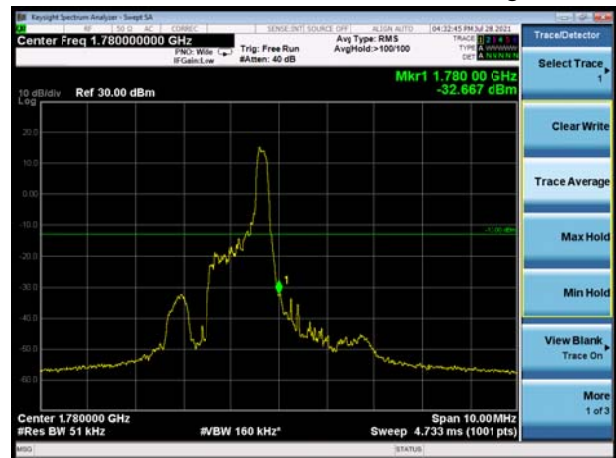

LTE eMTC Band 66 QPSK 5MHz CH-Low, 100%RB

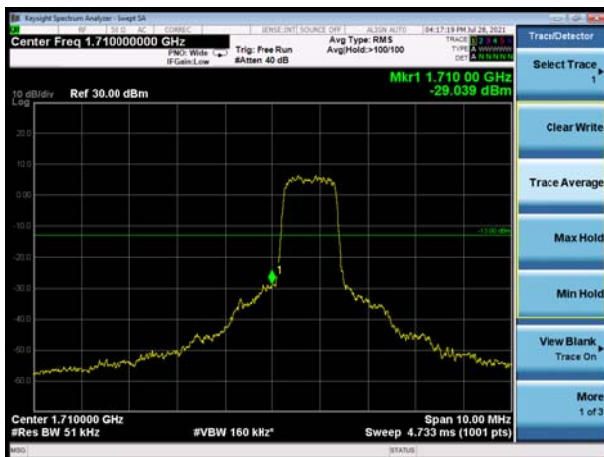

LTE eMTC Band 66 QPSK 5MHz CH-High, 100%RB



LTE eMTC Band 66 QPSK 10MHz CH-Low, 1 RB



LTE eMTC Band 66 QPSK 10MHz CH-High, 1 RB



LTE eMTC Band 66 QPSK 10MHz CH-Low, 100%RB



LTE eMTC Band 66 QPSK 10MHz CH-High, 100%RB



LTE eMTC Band 66 QPSK 15MHz CH-Low, 1 RB

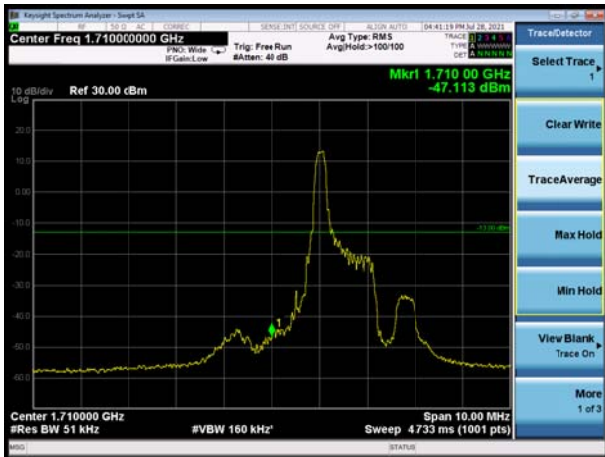

LTE eMTC Band 66 QPSK 15MHz CH-High, 1 RB



LTE eMTC Band 66 QPSK 15MHz CH-Low, 100%RB

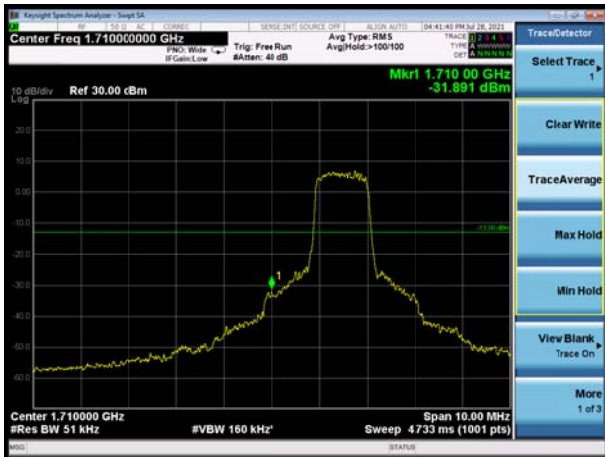

LTE eMTC Band 66 QPSK 15MHz CH-High, 100%RB

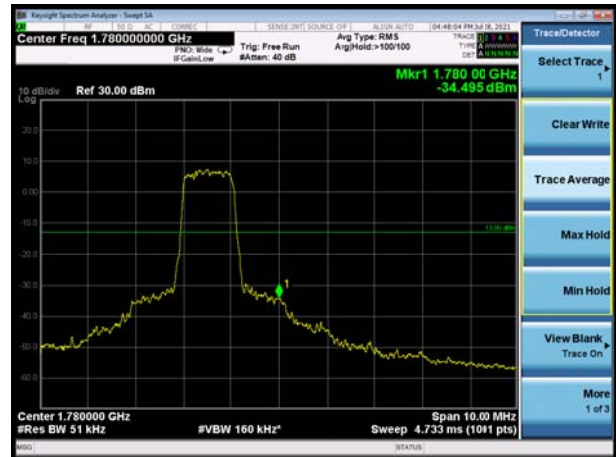

LTE eMTC Band 66 QPSK 20MHz CH-Low, 1 RB



LTE eMTC Band 66 QPSK 20MHz CH-High, 1 RB



LTE eMTC Band 66 QPSK 20MHz CH-Low, 100%RB

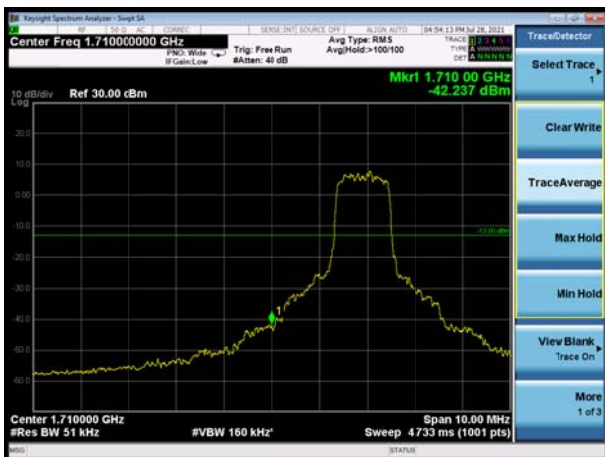

LTE eMTC Band 66 QPSK 20MHz CH-High, 100%RB

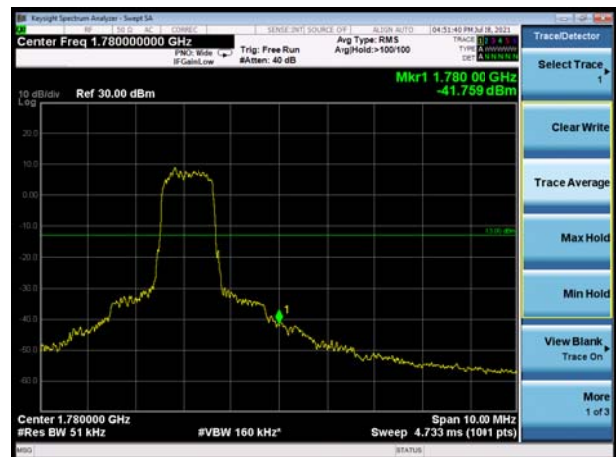

LTE eMTC Band 66 16QAM 1.4MHz CH-Low, 1 RB



LTE eMTC Band 66 16QAM 1.4MHz CH-High, 1 RB

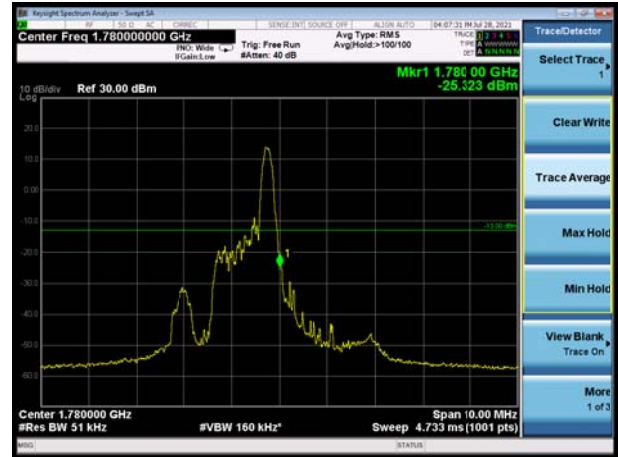

LTE eMTC Band 66 16QAM 1.4MHz CH-Low, 100%RB

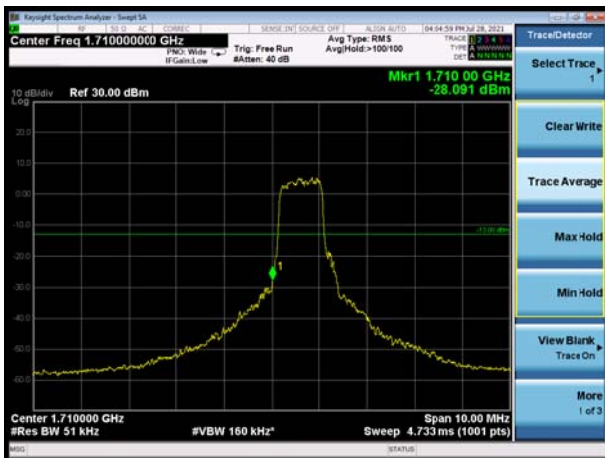

LTE eMTC Band 66 16QAM 1.4MHz CH-High, 100%RB

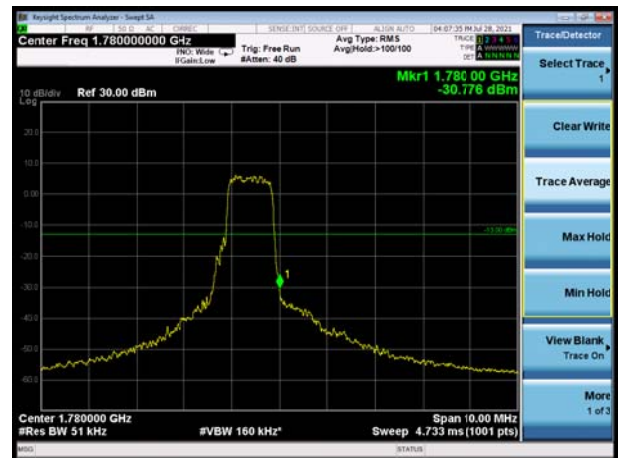

LTE eMTC Band 66 16QAM 3MHz CH-Low, 1 RB



LTE eMTC Band 66 16QAM 3MHz CH-High, 1 RB

