

RF TEST REPORT

Applicant Quetel Wireless Solutions Co., Ltd.
FCC ID XMR2021BG951AGL
Product LTE Cat M1/NB Module
Brand Quetel
Model BG951A-GL
Report No. R2301A0026-R1
Issue Date March 21, 2023

TA Technology (Shanghai) Co., Ltd. tested the above equipment in accordance with the requirements in **FCC CFR47 Part 2 (2022)/ FCC CFR 47 Part 22H (2022)**. The test results show that the equipment tested is capable of demonstrating compliance with the requirements as documented in this report.

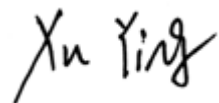

Prepared by: Xu Ying



Approved by: Xu Kai

TA Technology (Shanghai) Co., Ltd.

Building 3, No.145, Jintang Rd, Pudong Shanghai, P.R.China

TEL: +86-021-50791141/2/3

FAX: +86-021-50791141/2/3-8000

TABLE OF CONTENT

1. Test Laboratory	4
1.1. Notes of the Test Report	4
1.2. Test Facility	4
1.3. Testing Location	4
2. General Description of Equipment Under Test	5
2.1. Applicant and Manufacturer Information	5
2.2. General Information	5
3. Applied Standards	6
4. Test Configuration	7
5. Test Case	8
5.1. RF Power Output and Effective Radiated Power	8
5.2. Occupied Bandwidth	9
5.3. Band Edge Compliance	10
5.4. Peak-to-Average Power Ratio (PAPR)	11
5.5. Frequency Stability	12
5.6. Spurious Emissions at Antenna Terminals	14
5.7. Radiated Spurious Emission	15
6. Test Result	18
6.1. RF Power Output and Effective Radiated Power	18
6.2. Occupied Bandwidth	19
6.3. Band Edge Compliance	23
6.4. Peak-to-Average Power Ratio (PAPR)	25
6.5. Frequency Stability	26
6.6. Spurious Emissions at Antenna Terminals	28
6.7. Radiated Spurious Emission	29
7. Main Test Instruments	31
ANNEX A: The EUT Appearance	32
ANNEX B: Test Setup Photos	33
ANNEX C: Product Change Description (Variant 1)	34
ANNEX D: Product Change Description (Variant 2)	35

Summary of Measurement Results

No.	Test Case	Clause in FCC rules	Verdict
1	RF Power Output and Effective Radiated Power	2.1046 22.913(a)(5)	PASS
2	Occupied Bandwidth	2.1049	PASS
3	Band Edge Compliance	2.1051 / 22.917(a)	PASS
4	Peak-to-Average Power Ratio	22.913(d) KDB 971168 D01(5.7)	PASS
5	Frequency Stability	2.1055 / 22.355	PASS
6	Spurious Emissions at Antenna Terminals	2.1051 / 22.917(a)	PASS
7	Radiated Spurious Emission	2.1053 / 22.917 (a)	PASS
Date of Testing: July 21, 2021 ~ August 5, 2021			
Date of Sample Received: July 20, 2021			
Note: PASS: The EUT complies with the essential requirements in the standard. FAIL: The EUT does not comply with the essential requirements in the standard. All indications of Pass/Fail in this report are opinions expressed by TA Technology (Shanghai) Co., Ltd. based on interpretations and/or observations of test results. Measurement Uncertainties were not taken into account and are published for informational purposes only.			

BG951A-GL (Report No.: R2301A0026-R1) is a variant model (Variant 2) of BG951A-GL (Report No.: R2111A0947-R1V2). BG951A-GL supports from Cat NB1 (3GPP R13) to Cat NB2 (3GPP R14) only by FW updating, the hardware remains the same.

The detailed product change description please refers to following table:

Module	BG951A-GL (Cat NB1)	BG951A-GL (Cat NB2)
Category	Cat M1 & NB1	Cat M1 & NB2
Frequency Bands	Cat M1 Band 2/4/5/12/13/25/26/66 Cat NB1 Band 2/4/5/12/13/17/25/66	Cat M1 Band 2/4/5/12/13/25/26/66 Cat NB2 Band 2/4/5/12/13/17/25/66
Others	The same	

There is only verified RF Power Output; Band Edge Compliance; Spurious Emissions at Antenna Terminals, and did not worsen, so they were not recorded in the report.

The detailed product change description please refers to the *Difference Declaration Letter (Variant 2)*.

BG951A (Report No.: R2111A0947-R1V2) is a variant model (Variant 1) of BG950A (Report No.: R2107A0607-R1). The product only change mode, Software version, Hardware version, product name and FCC ID. There is no test in this report. The detailed product change description please refers to the *Difference Declaration Letter (Variant 1)*.

1. Test Laboratory

1.1. Notes of the Test Report

This report shall not be reproduced in full or partial, without the written approval of **TA Technology (Shanghai) Co., Ltd.** The results documented in this report apply only to the tested sample, under the conditions and modes of operation as described herein. Measurement Uncertainties were not taken into account and are published for informational purposes only. This report is written to support regulatory compliance of the applicable standards stated above.

1.2. Test Facility

FCC (Designation number: CN1179, Test Firm Registration Number: 446626)

TA Technology (Shanghai) Co., Ltd. has been listed on the US Federal Communications Commission list of test facilities recognized to perform measurements.

A2LA (Certificate Number: 3857.01)

TA Technology (Shanghai) Co., Ltd. has been listed by American Association for Laboratory Accreditation to perform measurement.

1.3. Testing Location

Company: TA Technology (Shanghai) Co., Ltd.
Address: Building 3, No.145, Jintang Rd, Pudong Shanghai, P.R.China
City: Shanghai
Post code: 201201
Country: P. R. China
Contact: Xu Kai
Telephone: +86-021-50791141/2/3
Fax: +86-021-50791141/2/3-8000
Website: <http://www.ta-shanghai.com>
E-mail: xukai@ta-shanghai.com

2. General Description of Equipment Under Test

2.1. Applicant and Manufacturer Information

Applicant	Quectel Wireless Solutions Co., Ltd.
Applicant address	Building 5, Shanghai Business Park Phase III (Area B), No.1016 Tianlin Road, Minhang District, Shanghai, China, 200233
Manufacturer	Quectel Wireless Solutions Co., Ltd.
Manufacturer address	Building 5, Shanghai Business Park Phase III (Area B), No.1016 Tianlin Road, Minhang District, Shanghai, China, 200233

2.2. General Information

EUT Description			
Model	BG951A-GL		
IMEI	(Original) 869410050002659		
Hardware Version	R1.5		
Software Version	BG951AGLAAR02A01		
Power Supply	External power supply		
Antenna Type	External Antenna		
Antenna Gain	Mode	Frequency (MHz)	Gain (dBi)
	NB-IoT Band 5	820	2.53
		830	2.13
		840	1.89
		850	2.29
Test Mode(s)	NB-IoT Band5;		
Test Modulation	BPSK, QPSK		
Category	NB2		
Deployment	stand-alone, In-band, Guard-band		
Sub-carrier spacing	3.75KHz, 15KHz		
Ntones	single-tone, multi-tone		
Maximum E.R.P.	NB-IoT Band5	24.05dBm	
Rated Power Supply Voltage	3.3V		
Operating Voltage	Minimum: 2.2V Maximum: 4.35V		
Operating Temperature	Lowest: -35°C Highest: +75°C		
Testing Temperature	Lowest: -35°C Highest: +75°C		
Frequency Range(s)	Band	Tx (MHz)	Rx (MHz)
	NB-IoT Band5;	824 ~ 849	869 ~ 894
Note: 1. The EUT is sent from the applicant to TA and the information of the EUT is declared by the applicant.			

3. Applied Standards

According to the specifications of the manufacturer, it must comply with the requirements of the following standards:

Test standards:

FCC CFR 47 Part 22H (2022)

FCC CFR47 Part 2 (2022)

Reference standard:

ANSI C63.26-2015

KDB 971168 D01 Power Meas License Digital Systems v03r01

4. Test Configuration

Radiated measurements are performed by rotating the EUT in three different orthogonal test planes. EUT stand-up position (Z axis), lie-down position (X, Y axis). Receiver antenna polarization (horizontal and vertical), the worst emission was found in position (Z axis, vertical polarization) and the worst case was recorded.

All modes as Subcarrier Spacing, modulations, Channel were investigated.

Subsequently, only the worst case emissions are reported.

The following testing in NB-IoT is set based on the maximum RF Output Power.

The following testing in different mode is set to detail in the following table:

Test modes are chosen as the worst case configuration below for NB-IoT Band 5.

Test items	Modes	Deployment mode	Subcarrier Spacing (kHz)		Modulation		Test Channel		
		Stand-alone	3.75	15	BPSK	QPSK	L	M	H
RF power output and Effective Radiated power	NB-IoT B5	O	O	O	O	O	O	O	O
Occupied Bandwidth	NB-IoT B5	O	O	O	O	O	O	O	O
Band Edge Compliance	NB-IoT B5	O	O	O	O	O	O	-	O
Peak-to-Average Power Ratio	NB-IoT B5	O	O	O	O	O	-	O	-
Frequency Stability	NB-IoT B5	O	O	O	O	O	-	O	-
Spurious Emissions at Antenna Terminals	NB-IoT B5	O	-	O	-	O	O	O	O
Radiated Spurious Emission	NB-IoT B5	O	-	O	-	O	-	O	-
<p>Note</p> <ol style="list-style-type: none"> 1. The mark "O" means that this configuration is chosen for testing. 2. The mark "-" means that this configuration is not testing. 									

5. Test Case

5.1. RF Power Output and Effective Radiated Power

Ambient Condition

Temperature	Relative humidity
20°C ~25°C	45%~50%

Methods of Measurement

During the process of the testing, The EUT was connected to the Base Station Simulator with a known loss. The EUT is controlled by the Base Station Simulator test set to ensure max power transmission with proper modulation.

ERP can then be calculated as follows:

$EIRP \text{ (dBm)} = \text{Output Power (dBm)} + \text{Antenna Gain (dBi)}$

$EIRP \text{ (dBm)} = ERP \text{ (dBm)} + 2.15 \text{ (dB)}$.

Test Setup

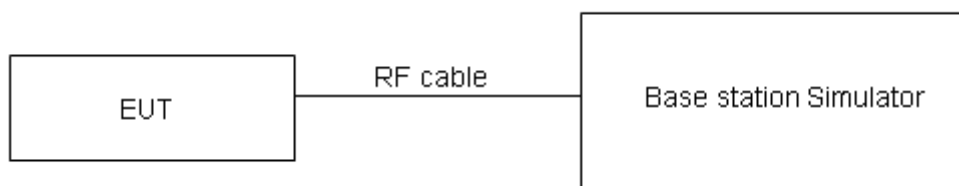

Limits

No specific RF power output requirements in part 2.1046.

Rule Part 22.913(a)(5) specifies that "Mobile/portable stations are limited to 7 watts ERP".

Limit	$\leq 7 \text{ W}$ (38.45 dBm)
-------	--------------------------------

Measurement Uncertainty

The assessed measurement uncertainty to ensure 95% confidence level for the normal distribution is with the coverage factor $k = 2$, $U = 0.4 \text{ dB}$ for RF power output, $k = 2$, $U = 1.19 \text{ dB}$ for ERP.

Test Results

Refer to the section 6.1 of this report for test data.

5.2. Occupied Bandwidth

Ambient Condition

Temperature	Relative humidity
20°C ~25°C	45%~50%

Method of Measurement

The EUT was connected to Spectrum Analyzer and Base Station Simulator via power Splitter. The occupied bandwidth is measured using spectrum analyzer.

RBW is set to $\geq 1\%$ EBW, VBW is set to 3x RBW.

99% power and -26dBc occupied bandwidths are recorded. Spectrum analyzer plots are included on the following pages.

Test Setup

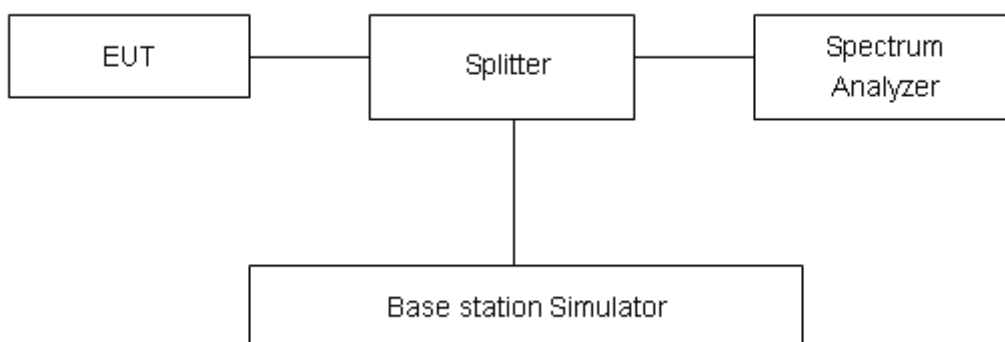

Limits

No specific occupied bandwidth requirements in part 2.1049.

Measurement Uncertainty

The assessed measurement uncertainty to ensure 95% confidence level for the normal distribution is with the coverage factor $k = 2$, $U = 624\text{Hz}$.

Test Results

Refer to the section 6.2 of this report for test data.

5.3. Band Edge Compliance

Ambient Condition

Temperature	Relative humidity
20°C ~25°C	45%~50%

Method of Measurement

The EUT was connected to Spectrum Analyzer and Base Station Simulator via power Splitter. The band edge of the lowest and highest channels were measured. The average detector is used. RBW is set to $\geq 1\%EBW$, VBW is set to 3x RBW.

Spectrum analyzer plots are included on the following pages.

Test Setup

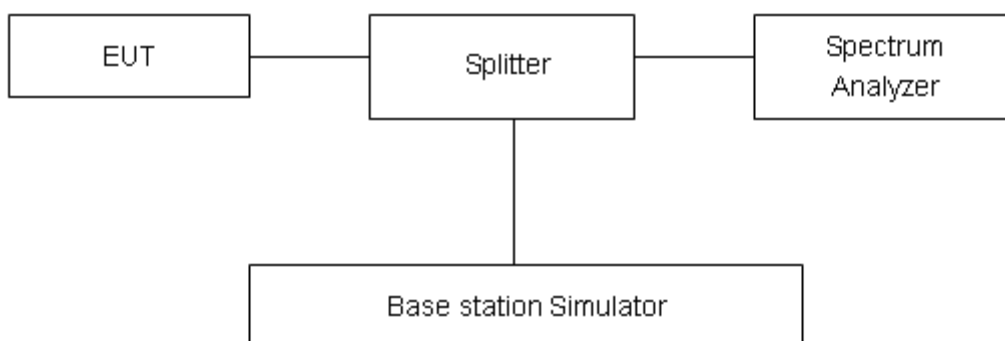

Limits

Rule Part 22.917(a) specifies that “The power of any emission outside of the authorized operating frequency ranges must be attenuated below the transmitting power (P) by a factor of at least 43 + 10 log(P) dB.”

Limit	-13 dBm
-------	---------

Measurement Uncertainty

The assessed measurement uncertainty to ensure 95% confidence level for the normal distribution is with the coverage factor $k = 1.96$, $U=0.684dB$.

Test Results

Refer to the section 6.3 of this report for test data.

5.4. Peak-to-Average Power Ratio (PAPR)

Ambient Condition

Temperature	Relative humidity
20°C ~25°C	45%~50%

Methods of Measurement

Measure the total peak power and record as P_{Pk} . And measure the total average power and record as P_{Avg} . Both the peak and average power levels must be expressed in the same logarithmic units (e.g., dBm). Determine the PAPR from:

$$PAPR (dB) = P_{Pk} (dBm) - P_{Avg} (dBm).$$

Test Setup

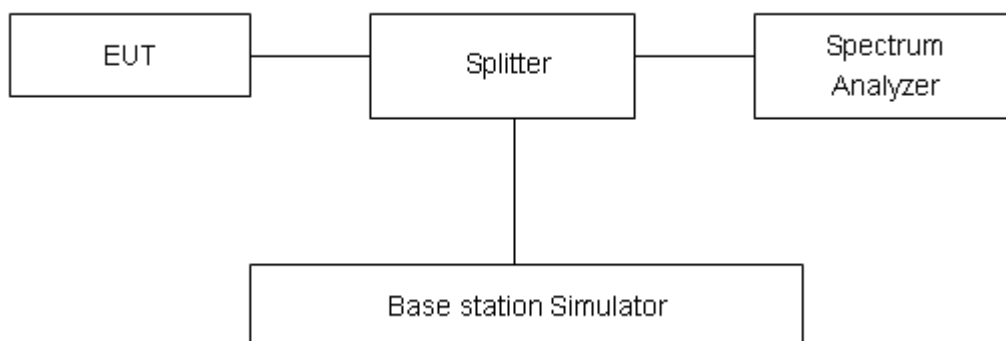

Limits

According to the Sec. 22.913(d), The peak-to-average ratio (PAR) of the transmission must not exceed 13 dB.

Measurement Uncertainty

The assessed measurement uncertainty to ensure 95% confidence level for the normal distribution is with the coverage factor $k = 2$, $U = 0.4$ dB.

Test Results

Refer to the section 6.4 of this report for test data.

5.5. Frequency Stability

Ambient Condition

Temperature	Relative humidity
20°C ~25°C	45%~50%

Method of Measurement

Frequency Stability (Temperature Variation)

The temperature inside the climate chamber is varied from -35°C to +75°C in 10°C step size,

(1) With all power removed, the temperature was decreased to 0°C and permitted to stabilize for three hours.

(2) Measure the carrier frequency with the test equipment in a “call mode”. These measurements should be made within 1 minute of powering up the mobile station, to prevent significant self warming.

(3) Repeat the above measurements at 10°C increments from -35°C to +75°C. Allow at least 1.5 hours at each temperature, un-powered, before making measurements.

Frequency Stability (Voltage Variation)

The frequency stability shall be measured with variation of primary supply voltage as follows:

Primary Supply Voltage: The primary supply voltage is varied from 85% to 115% of the nominal value for non hand-carried battery and AC powered equipment. For hand-carried, battery-powered equipment, primary supply voltage is reduced to the battery operating end point which shall be specified by the manufacturer.

This transceiver is specified to operate with an input voltage of between 2.2V and 4.35 V, with a nominal voltage of 3.3V.

Test Setup

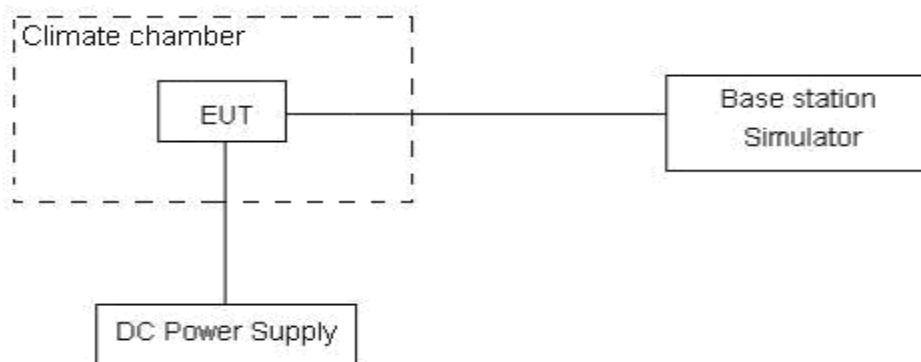

Limits

According to the Sec. 22.355, the frequency stability of the carrier shall be accurate to within 2.5 ppm of the received frequency for mobile stations.

Limits	≤ 2.5 ppm
--------	-----------

Measurement Uncertainty

The assessed measurement uncertainty to ensure 99.75% confidence level for the normal distribution is with the coverage factor $k = 3$, $U = 0.01\text{ppm}$.

Test Results

Refer to the section 6.5 of this report for test data.

5.6. Spurious Emissions at Antenna Terminals

Ambient Condition

Temperature	Relative humidity
20°C ~25°C	45%~50%

Method of Measurement

The EUT was connected to Spectrum Analyzer and Base Station Simulator via power Splitter. The measurement is carried out using a spectrum analyzer. The spectrum analyzer scans from 9kHz to the 10th harmonic of the carrier.

The peak detector is used.

RBW is set to 1 kHz (0.009MHz~ 0.15 MHz),

RBW is set to 10 kHz (0.15 MHz~ 30 MHz)

RBW is set to 100 kHz (30MHz~1000 MHz)

RBW is set to 1000 kHz (above 1000MHz)

Sweep is set to ATUO.

The modulation mode and RB allocation refer to section 5.1, using the maximum output power configuration.

Test Setup

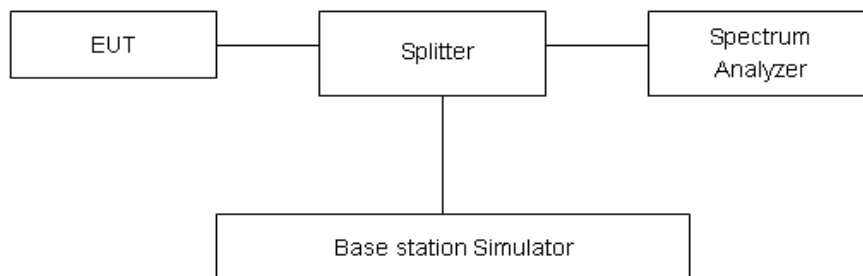

Limits

Rule Part 22.917(a) specifies that “The power of any emission outside of the authorized operating frequency ranges must be attenuated below the transmitting power (P) by a factor of at least $43 + 10 \log (P)$ dB.”

Limit	-13 dBm
-------	---------

Measurement Uncertainty

The assessed measurement uncertainty to ensure 99.75% confidence level for the normal distribution is with the coverage factor $k = 1.96$.

Frequency	Uncertainty
9kHz-1GHz	0.684 dB
1GHz-18GHz	1.407 dB

Test Results

Refer to the section 6.6 of this report for test data.

5.7. Radiated Spurious Emission

Ambient Condition

Temperature	Relative humidity
20°C ~25°C	45%~50%

Method of Measurement

- The testing follows FCC KDB 971168 v03r01 Section 5.8 and ANSI C63.26-2015.
- Below 1GHz: The EUT is placed on a turntable 0.8 meters above the ground in the chamber, 3 meter away from the antenna. The maximal emission value is acquired by adjusting the antenna height, polarisation and turntable azimuth. Normally, the height range of antenna is 1 m to 4 m, the azimuth range of turntable is 0° to 360°, and the receive antenna has two polarizations Vertical (V) and Horizontal (H). Above 1GHz: (Note: the FCC's permission to use 1.5m as an alternative per TCBC Conf call of Dec. 2, 2014.) The EUT is placed on a turntable 1.5 meters above the ground in the chamber, 3 meter away from the antenna. The maximal emission value is acquired by adjusting the antenna height, polarisation and turntable azimuth. Normally, the height range of antenna is 1 m to 4 m, the azimuth range of turntable is 0° to 360°, and the receive antenna has two polarizations Vertical (V) and Horizontal (H).
- A loop antenna, A log-periodic antenna or horn antenna shall be substituted in place of the EUT. The log-periodic antenna will be driven by a signal generator and the level will be adjusted till the same power value on the spectrum analyzer or receiver. The level of the spurious emissions can be calculated through the level of the signal generator, cable loss, the gain of the substitution antenna and the reading of the spectrum analyzer or receiver.
- The EUT is then put into continuously transmitting mode at its maximum power level during the test. Set Test Receiver or Spectrum RBW=100kHz, VBW=300kHz, and the maximum value of the receiver should be recorded as (Pr).
- The EUT shall be replaced by a substitution antenna. In the chamber, an substitution antenna for the frequency band of interest is placed at the reference point of the chamber. An RF Signal source for the frequency band of interest is connected to the substitution antenna with a cable that has been constructed to not interfere with the radiation pattern of the antenna. A power (PMea) is applied to the input of the substitution antenna, and adjust the level of the signal generator output until the value of the receiver reach the previously recorded (Pr). The power of signal source (PMea) is recorded. The test should be performed by rotating the test item and adjusting the receiving antenna polarization.
- A amplifier should be connected to the Signal Source output port. And the cable should be connect between the Amplifier and the Substitution Antenna. The cable loss (Pcl), the Substitution Antenna Gain (Ga) and the Amplifier Gain (PAG) should be recorded after test.
- The measurement results are obtained as described below:
 Power (EIRP) = PMea - PAG - Pcl + Ga
 The measurement results are amend as described below:
 Power (EIRP) = PMea - Pcl + Ga
- This value is EIRP since the measurement is calibrated using an antenna of known gain (2.15 dB) and known input power. ERP can be calculated from EIRP by subtracting the gain of the dipole, ERP = EIRP-2.15dB.

The modulation mode and RB allocation refer to section 5.1, using the maximum output power configuration.

Test Setup

9KHz~ 30MHz

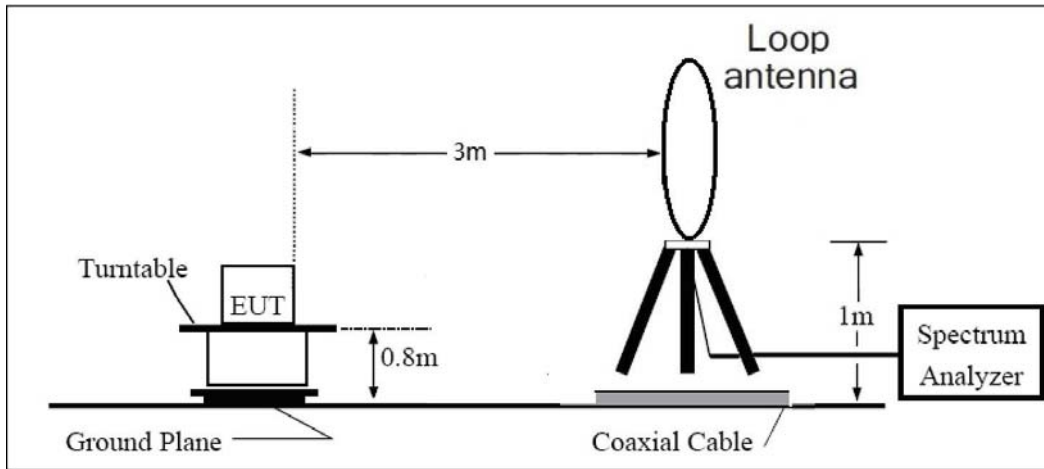

30MHz~ 1GHz

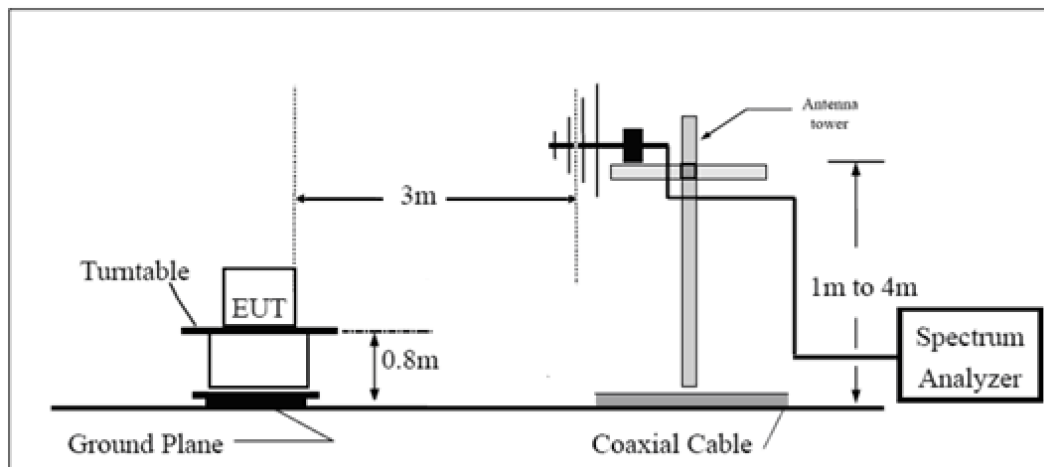

Above 1GHz

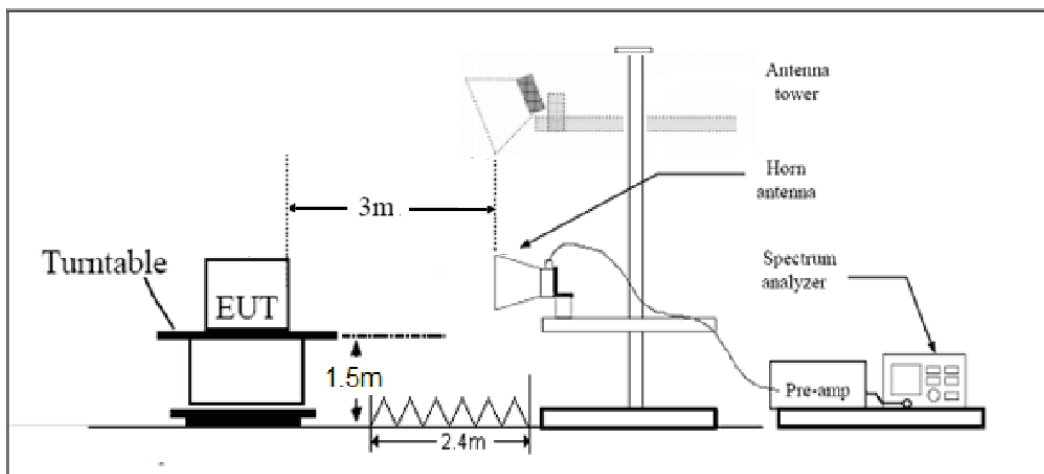

Note: Area side: 2.4mX3.6m

Limits

Rule Part 22.917(a) specifies that “The power of any emission outside of the authorized operating frequency ranges must be attenuated below the transmitting power (P) by a factor of at least $43 + 10 \log (P)$ Db.”

Limit	-13 dBm
-------	---------

Measurement Uncertainty

The assessed measurement uncertainty to ensure 95% confidence level for the normal distribution is with the coverage factor $k = 1.96$, $U = 3.55$ Db.

Test Results

Refer to the section 6.7 of this report for test data.

6. Test Result

6.1. RF Power Output and Effective Radiated Power

Mode	Modulation	Sub-carrier spacing (KHz)	Ntones	Max mum output Power (dBm) for low/mid/high channel			ERP (dBm)		
				20402 /824.2	20525 /836.5	20648 /848.8	20402 /824.2	20525 /836.5	20648 /848.8
NB-IoT Band 5	BPSK	3.75	1@0	23.14	23.30	23.39	23.52	23.04	23.53
			1@47	23.07	23.24	23.37	23.45	22.98	23.51
		15	1@0	23.67	23.67	23.61	24.05	23.41	23.75
			1@11	23.62	23.59	23.57	24.00	23.33	23.71
	QPSK	3.75	1@0	23.14	23.25	23.40	23.52	22.99	23.54
			1@47	23.09	23.21	23.39	23.47	22.95	23.53
		15	1@0	23.47	23.57	23.45	23.85	23.31	23.59
			1@11	23.64	23.61	23.47	24.02	23.35	23.61
		15	12@0	21.20	21.18	21.17	21.58	20.92	21.31

6.2. Occupied Bandwidth

Mode	Modulation	Sub-carrier spacing (KHz)	Ntones	Bandwidth(KHz) for low/mid/high channel					
				20402/824.2(MHz)		20525/836.5(MHz)		20648/848.8(MHz)	
				99% Power	-26dBc	99% Power	-26dBc	99% Power	-26dBc
NB-IoT Band 5 Standalone	BPSK	3.75	1@0	36.82	38.02	38.72	37.54	38.56	36.88
	QPSK	3.75	1@0	39.74	39.06	41.90	41.30	41.32	40.99
	BPSK	15	1@0	73.98	92.67	75.40	90.44	74.26	100.10
	QPSK	15	1@0	72.50	100.20	71.86	90.24	71.41	98.26
	QPSK	15	12@0	185.71	267.30	188.04	262.90	187.00	242.80

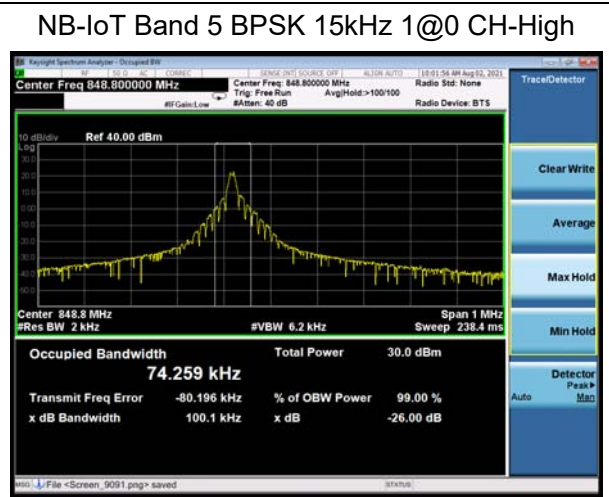
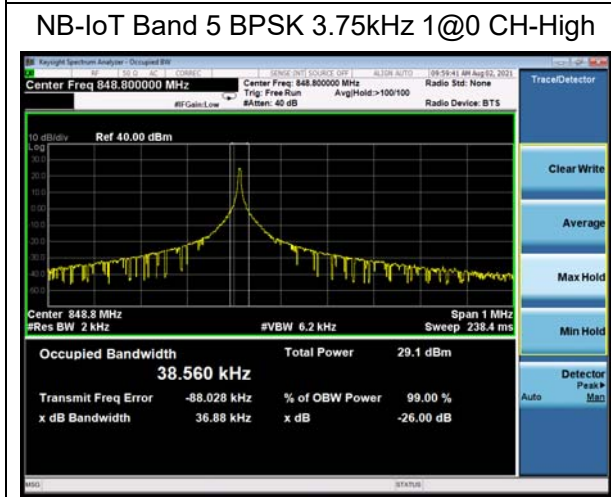
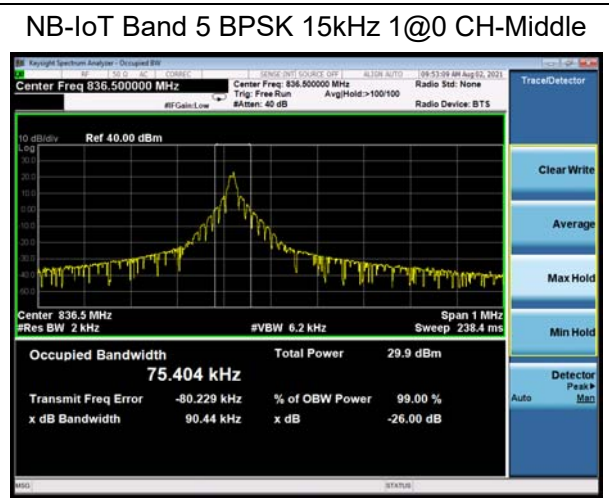
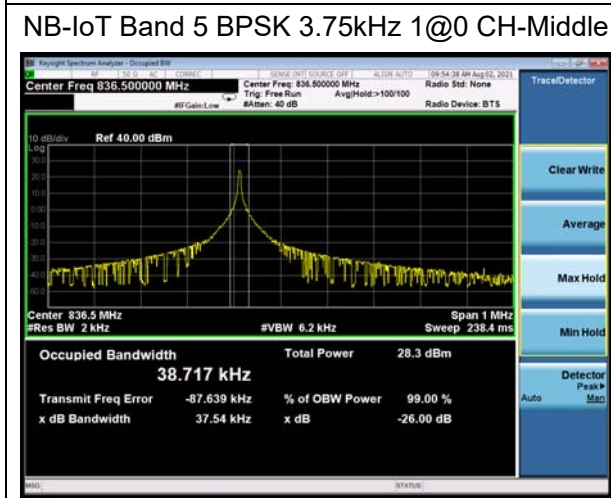
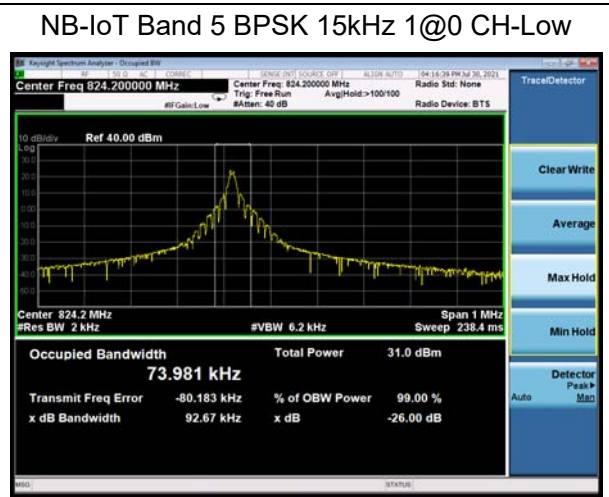
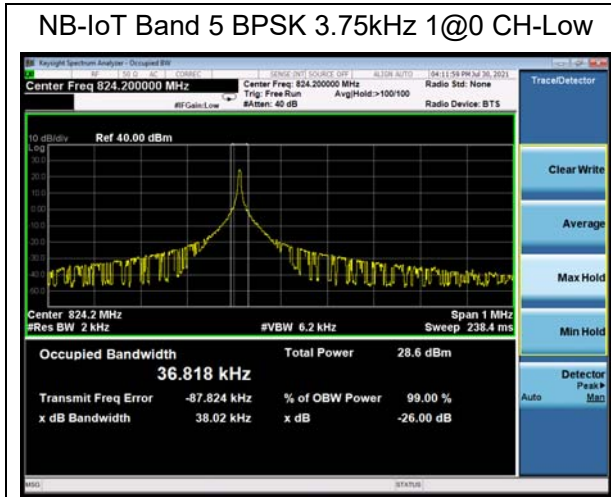

NB-IoT Band 5 QPSK 3.75kHz 1@0 CH-Low

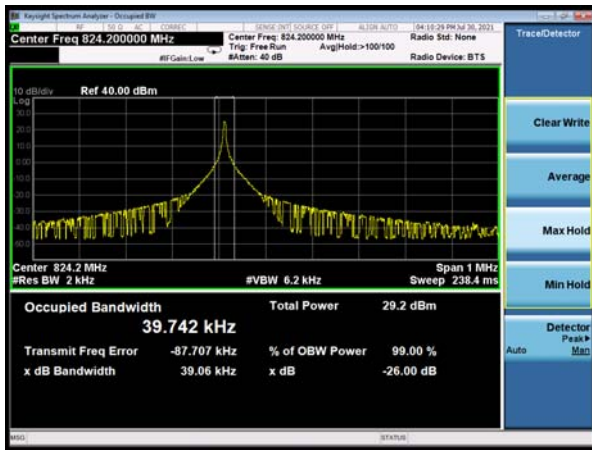

NB-IoT Band 5 QPSK 15kHz 1@0 CH-Low

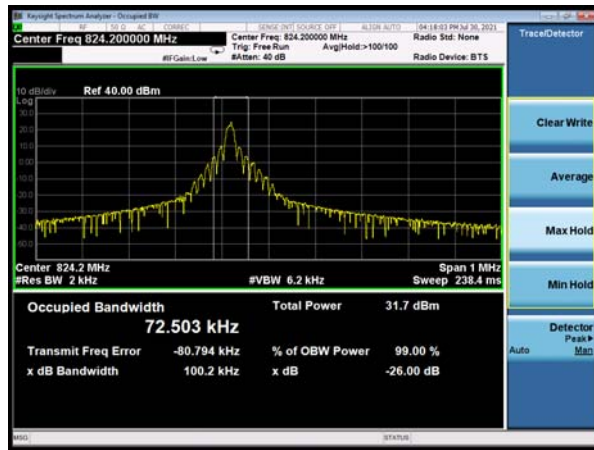

NB-IoT Band 5 QPSK 3.75kHz 1@0 CH-Middle

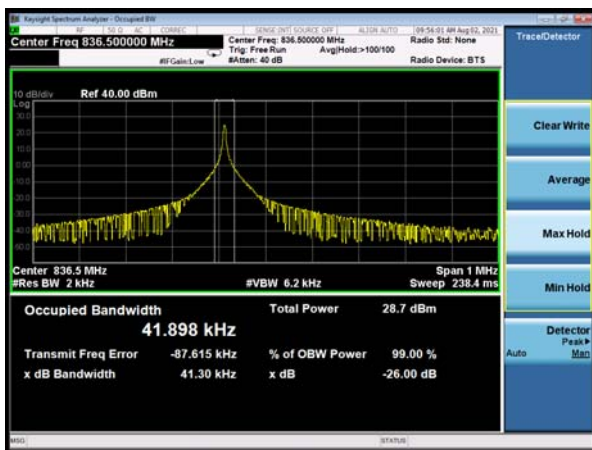

NB-IoT Band 5 QPSK 15kHz 1@0 CH-Middle



NB-IoT Band 5 QPSK 3.75kHz 1@0 CH-High

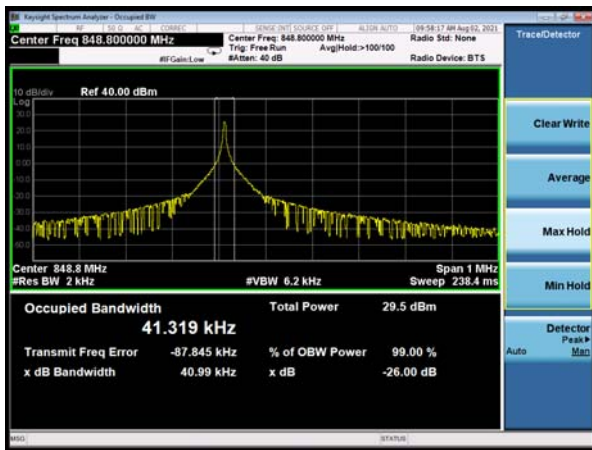

NB-IoT Band 5 QPSK 15kHz 1@0 CH-High



NB-IoT Band 5 QPSK 15kHz 12@0 CH-Low

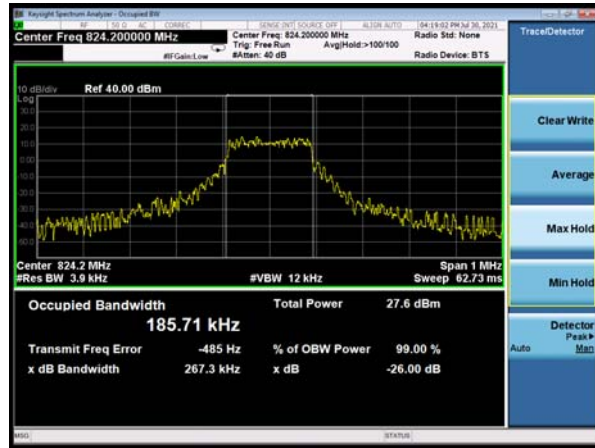

NB-IoT Band 5 QPSK 15kHz 12@0 CH-Middle

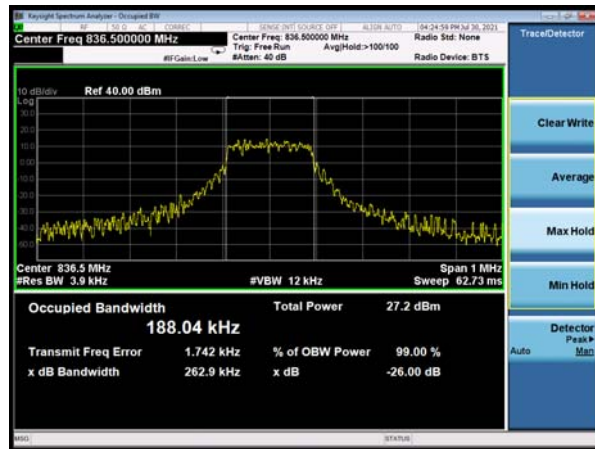

NB-IoT Band 5 QPSK 15kHz 12@0 CH-High

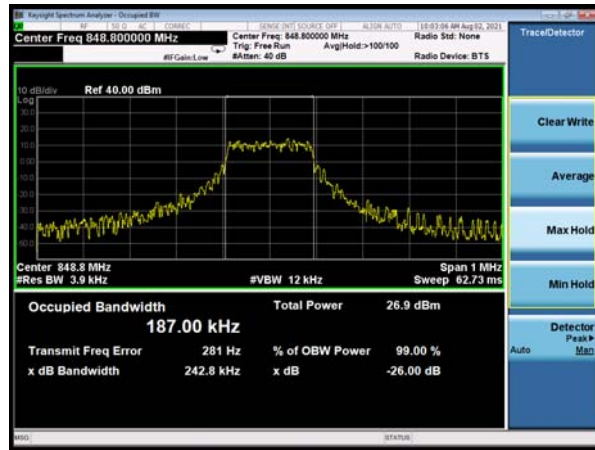

6.3. Band Edge Compliance

NB-IoT Band 5 BPSK 3.75kHz 1@0 CH-Low

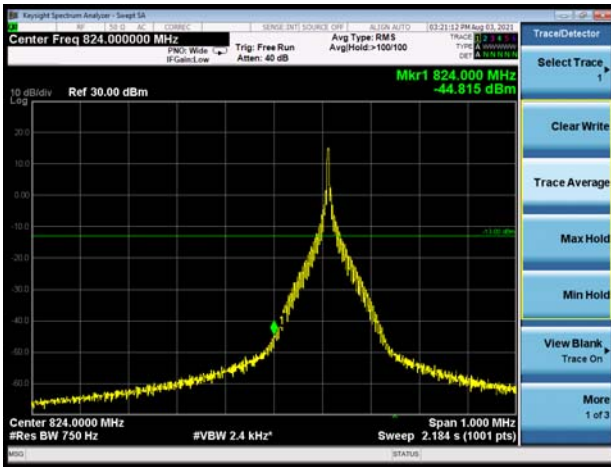

NB-IoT Band 5 BPSK 3.75kHz 1@47 CH-High

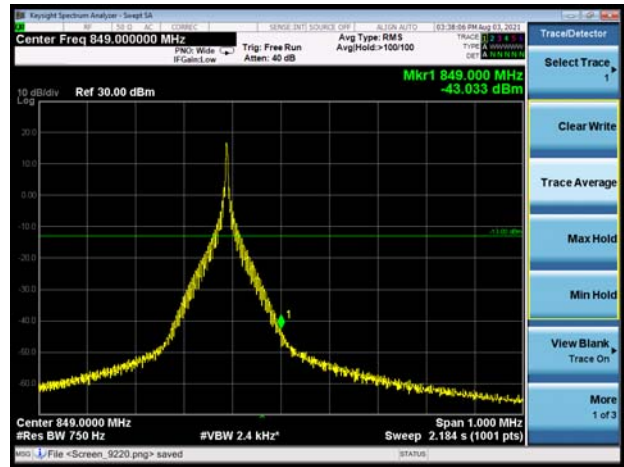

NB-IoT Band 5 BPSK 15kHz 1@0 CH-Low

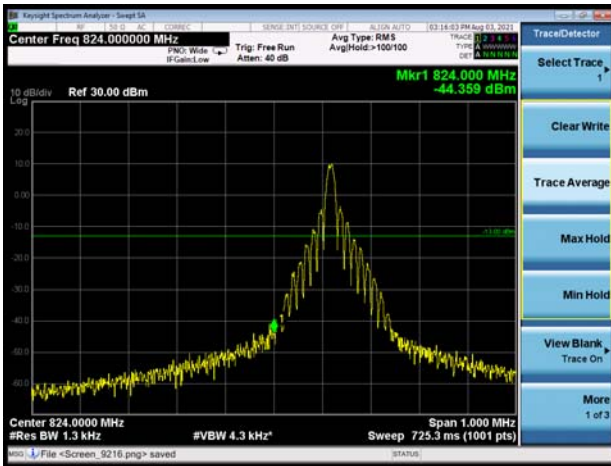

NB-IoT Band 5 BPSK 15kHz 1@11 CH-High

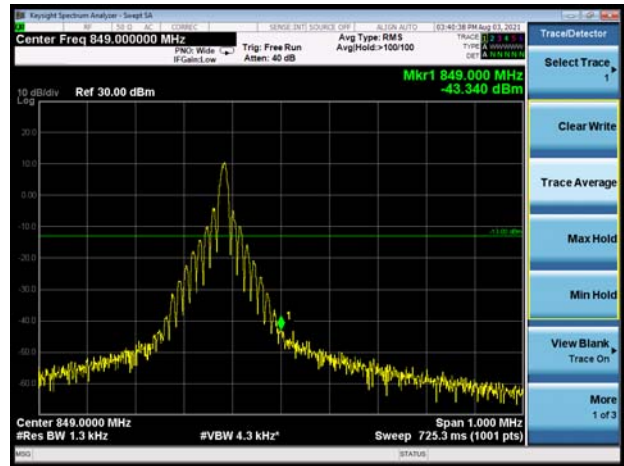

NB-IoT Band 5 QPSK 3.75kHz 1@0 CH-Low

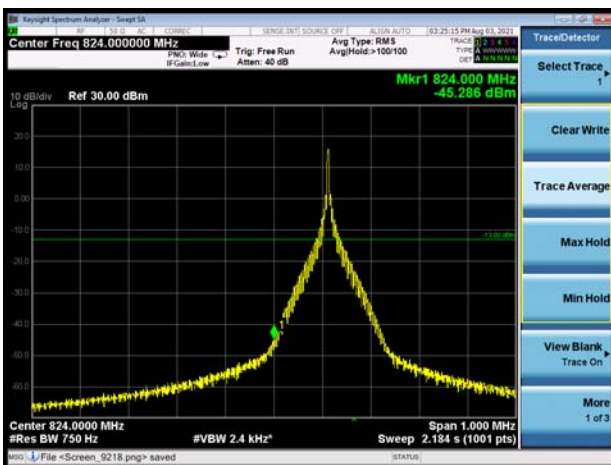

NB-IoT Band 5 QPSK 3.75kHz 1@47 CH-High

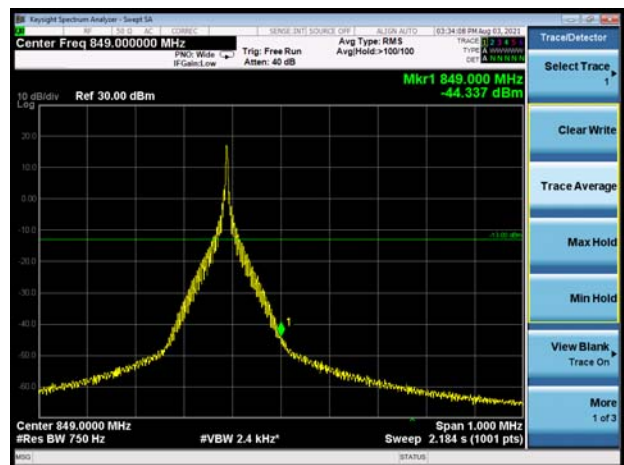

NB-IoT Band 5 QPSK 15kHz 12@0 CH-Low

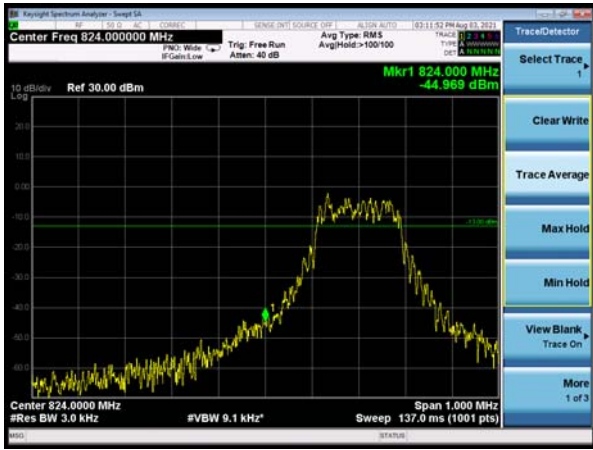

NB-IoT Band 5 QPSK 15kHz 12@0 CH-High

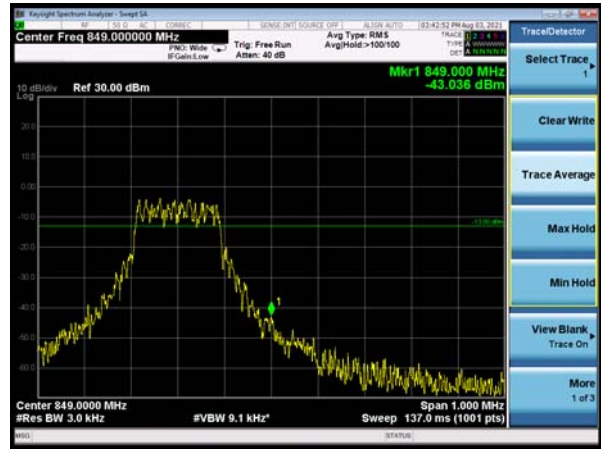

6.4. Peak-to-Average Power Ratio (PAPR)

Mode	Modulation	Sub-carrier spacing (KHz)	Channel/ Frequency(MHz)	Peak-to-Average Power Ratio (PAPR)		
				Peak(dBm)	Avg(dBm)	PAPR(dB)
NB-IoT Band 5 Standalone	BPSK	3.75	20525/836.5	25.14	22.35	2.79
	QPSK	3.75	20525/836.5	25.24	22.32	2.92
	BPSK	15	20525/836.5	25.07	18.86	6.21
	QPSK	15	20525/836.5	24.96	18.99	5.97

6.5. Frequency Stability

NB-IoT Band 5						
Condition		Freq.Error (Hz)	Freq.Error (Hz)	Frequency Stability(ppm)	Frequency Stability(ppm)	Verdict
Sub-carrier spacing (KHz)	3.75					
Temperature	Voltage	BPSK	QPSK	BPSK	QPSK	
Normal (25°C)	Normal	6.83	9.66	0.00817	0.01155	PASS
Extreme (75°C)		5.96	5.90	0.00712	0.00705	PASS
Extreme (70°C)		7.51	7.40	0.00898	0.00885	PASS
Extreme (60°C)		8.84	6.61	0.01057	0.00790	PASS
Extreme (50°C)		4.80	15.04	0.00573	0.01798	PASS
Extreme (40°C)		15.03	6.53	0.01797	0.00781	PASS
Extreme (30°C)		7.59	9.47	0.00908	0.01132	PASS
Extreme (20°C)		5.95	6.94	0.00711	0.00829	PASS
Extreme (10°C)		5.77	2.96	0.00689	0.00353	PASS
Extreme (0°C)		4.88	6.60	0.00583	0.00789	PASS
Extreme (-10°C)		17.41	6.94	0.02081	0.00830	PASS
Extreme (-20°C)		4.27	4.73	0.00510	0.00566	PASS
Extreme (-30°C)		1.46	9.54	0.00174	0.01141	PASS
Extreme (-35°C)		3.90	16.47	0.00466	0.01969	PASS
25°C	LV	13.90	8.81	0.01661	0.01053	PASS
	HV	3.92	16.53	0.00468	0.01976	PASS
Condition		Freq.Error (Hz)	Freq.Error (Hz)	Frequency Stability(ppm)	Frequency Stability(ppm)	Verdict
Sub-carrier spacing (KHz)	15					
Temperature	Voltage	BPSK	QPSK	BPSK	QPSK	
Normal (25°C)	Normal	5.89	13.90	0.00705	0.01661	PASS
Extreme (75°C)		9.23	17.79	0.01104	0.02127	PASS
Extreme (70°C)		5.01	7.69	0.00599	0.00920	PASS
Extreme (60°C)		1.73	14.02	0.00207	0.01676	PASS
Extreme (50°C)		9.95	9.35	0.01189	0.01118	PASS
Extreme (40°C)		8.47	12.88	0.01012	0.01540	PASS
Extreme (30°C)		1.39	9.73	0.00166	0.01163	PASS
Extreme (20°C)		14.54	11.97	0.01738	0.01431	PASS
Extreme (10°C)		12.66	14.54	0.01514	0.01738	PASS
Extreme (0°C)		16.88	11.38	0.02018	0.01360	PASS
Extreme (-10°C)		4.03	16.00	0.00482	0.01913	PASS
Extreme (-20°C)		14.46	2.03	0.01728	0.00243	PASS
Extreme (-30°C)		2.79	14.10	0.00333	0.01686	PASS
Extreme (-35°C)		2.32	6.71	0.00277	0.00802	PASS

25°C	LV	16.10	3.92	0.01925	0.00469	PASS
	HV	6.20	10.96	0.00741	0.01310	PASS

6.6. Spurious Emissions at Antenna Terminals

Sweep the whole frequency band through the range from 9kHz to the 10th harmonic of the carrier, the emissions more than 20 dB below the limit are not reported.

The signal beyond the limit is carrier.

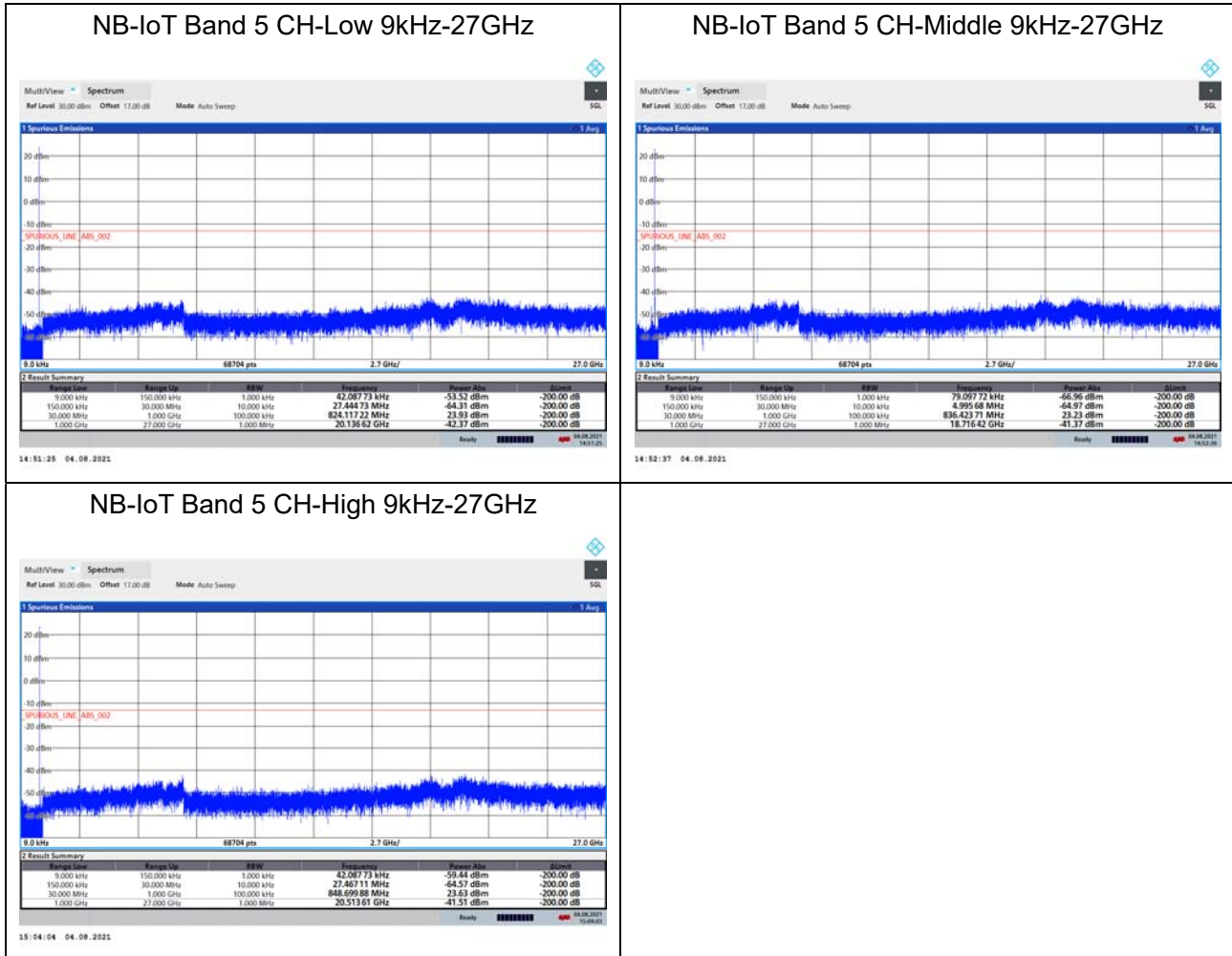

6.7. Radiated Spurious Emission

Sweep the whole frequency band through the range from 9kHz to the 10th harmonic of the carrier, the emissions below the noise floor will not be recorded in the report.

NB-IoT Band 5 3.75KHz BPSK CH-Low

Harmonic	Frequency (MHz)	SG (dBm)	Cable Loss (dB)	Gain (dBi)	Antenna Polarization	ERP Level (dBm)	Limit (dBm)	Margin (dB)	Azimuth (deg)
2	1648.20	-55.87	1.70	8.70	Vertical	-51.02	-13.00	38.02	270
3	2472.30	-62.84	2.30	12.00	Vertical	-55.29	-13.00	42.29	180
4	3296.40	-65.14	2.70	12.70	Vertical	-57.29	-13.00	44.29	315
5	4120.50	-61.02	3.00	12.50	Vertical	-53.67	-13.00	40.67	90
6	4944.60	-50.66	3.40	12.50	Vertical	-43.71	-13.00	30.71	0
7	5768.70	-55.61	3.40	12.80	Vertical	-48.36	-13.00	35.36	225
8	6592.80	-55.59	4.10	11.50	Vertical	-50.34	-13.00	37.34	225
9	7416.90	-55.12	4.20	12.20	Vertical	-49.27	-13.00	36.27	270
10	8241.00	-54.38	4.30	12.50	Vertical	-48.33	-13.00	35.33	135

Note: 1.The other Spurious RF Radiated emissions level is no more than noise floor.
2.The worst emission was found in the antenna is Vertical position.

NB-IoT Band5 3.75KHz BPSK CH-Middle

Harmonic	Frequency (MHz)	SG (dBm)	Cable Loss (dB)	Gain (dBi)	Antenna Polarization	ERP Level (dBm)	Limit (dBm)	Margin (dB)	Azimuth (deg)
2	1673.00	-52.43	1.70	8.70	Vertical	-47.58	-13.00	34.58	45
3	2509.50	-63.63	2.30	12.00	Vertical	-56.08	-13.00	43.08	315
4	3346.00	-65.99	2.70	12.70	Vertical	-58.14	-13.00	45.14	225
5	4182.50	-59.22	3.00	12.50	Vertical	-51.87	-13.00	38.87	180
6	5019.00	-47.88	3.40	12.50	Vertical	-40.93	-13.00	27.93	45
7	5855.50	-55.41	3.40	12.80	Vertical	-48.16	-13.00	35.16	315
8	6692.00	-56.80	4.10	11.50	Vertical	-51.55	-13.00	38.55	90
9	7528.50	-57.45	4.20	12.20	Vertical	-51.60	-13.00	38.60	315
10	8365.00	-55.54	4.30	12.50	Vertical	-49.49	-13.00	36.49	315

Note: 1.The other Spurious RF Radiated emissions level is no more than noise floor.
2. The worst emission was found in the antenna is Vertical position.

NB-IoT Band5 3.75KHz BPSK CH-High

Harmonic	Frequency (MHz)	SG (dBm)	Cable Loss (dB)	Gain (dBi)	Antenna Polarization	ERP Level (dBm)	Limit (dBm)	Margin (dB)	Azimuth (deg)
2	1697.80	-50.90	1.70	8.70	Vertical	-46.05	-13.00	33.05	90
3	2546.70	-62.94	2.30	12.00	Vertical	-55.39	-13.00	42.39	315
4	3395.60	-67.53	2.70	12.70	Vertical	-59.68	-13.00	46.68	270
5	4244.50	-59.49	3.00	12.50	Vertical	-52.14	-13.00	39.14	135
6	5093.40	-45.93	3.40	12.50	Vertical	-38.98	-13.00	25.98	225
7	5942.30	-54.24	3.40	12.80	Vertical	-46.99	-13.00	33.99	180
8	6791.20	-57.38	4.10	11.50	Vertical	-52.13	-13.00	39.13	45
9	7640.10	-54.97	4.20	12.20	Vertical	-49.12	-13.00	36.12	315
10	8489.00	-57.87	4.30	12.50	Vertical	-51.82	-13.00	38.82	90

Note: 1.The other Spurious RF Radiated emissions level is no more than noise floor.
 2.The worst emission was found in the antenna is Vertical position.

7. Main Test Instruments

Name	Manufacturer	Type	Serial Number	Calibration Date	Expiration Date
Base Station Simulator	R&S	CMW500	113645	2021-05-15	2022-05-14
Power Splitter	Hua Xiang	SHX-GF2-2-13	10120101	/	/
Spectrum Analyzer	Key sight	N9010A	MY50210259	2020-05-18	2022-05-14
Universal Radio Communication Tester	Key sight	E5515C	MY48367192	2021-05-15	2022-05-14
Signal Analyzer	R&S	FSV3030	101411	2020-12-13	2021-12-12
Loop Antenna	SCHWARZBECK	FMZB1519	1519-047	2020-04-02	2023-04-01
TRILOG Broadband Antenna	SCHWARZBECK	VULB 9163	391	2019-12-16	2021-12-15
Horn Antenna	R&S	HF907	102723	2018-08-11	2021-08-10
Horn Antenna	ETS-Lindgren	3160-09	00102643	2018-06-20	2023-06-19
Signal generator	R&S	SMB 100A	180235	2021-05-15	2022-05-14
Climatic Chamber	ESPEC	SU-242	93000506	2020-12-13	2021-12-12
Preamplifier	R&S	SCU18	102327	2021-05-15	2022-05-14
MOB COMMS DC SUPPLY	Keysight	66319D	MY43004105	2021-05-15	2022-05-14
Software	R&S	EMC32	9.26.0	/	/
Wireless Test Set	StarPoint	SP8315	SP8315-1202	2021-05-15	2022-05-14
Wireless Test Set	StarPoint	SP8315	SP8315-1203	2021-05-15	2022-05-14

*****END OF REPORT *****

ANNEX A: The EUT Appearance

The EUT Appearance is submitted separately.

ANNEX B: Test Setup Photos

The Test Setup Photos is submitted separately.

ANNEX C: Product Change Description (Variant 1)

The Product Change Description are submitted separately.

ANNEX D: Product Change Description (Variant 2)

The Product Change Description are submitted separately.