

RF TEST REPORT

Applicant Quectel Wireless Solutions Co., Ltd.
FCC ID XMR2021BG950AGL
Product LTE Module
Brand Quectel
Model BG950A-GL
Report No. R2301A0022-R3V1
Issue Date April 27, 2023

TA Technology (Shanghai) Co., Ltd. tested the above equipment in accordance with the requirements in **FCC CFR47 Part 2 (2022)/ FCC CFR47 Part 27C (2022)**. The test results show that the equipment tested is capable of demonstrating compliance with the requirements as documented in this report.

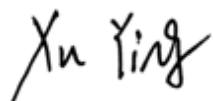

Prepared by: Xu Ying



Approved by: Xu Kai

TA Technology (Shanghai) Co., Ltd.

Building 3, No.145, Jintang Rd, Pudong Shanghai, P.R.China

TEL: +86-021-50791141/2/3

FAX: +86-021-50791141/2/3-8000

TABLE OF CONTENT

1	Test Laboratory.....	5
1.1	Notes of the Test Report.....	5
1.2	Test facility.....	5
1.3	Testing Location.....	5
2	General Description of Equipment under Test.....	6
2.1	Applicant and Manufacturer Information.....	6
2.2	General information.....	6
3	Applied Standards.....	8
4	Test Configuration.....	9
5	Test Case Results.....	11
5.1	RF Power Output and Effective Isotropic Radiated Power.....	11
5.2	Occupied Bandwidth.....	15
5.3	Band Edge Compliance.....	32
5.4	Peak-to-Average Power Ratio (PAPR).....	43
5.5	Frequency Stability.....	45
5.6	Spurious Emissions at Antenna Terminals.....	53
5.7	Radiates Spurious Emission.....	58
6	Main Test Instruments.....	69
	ANNEX A: The EUT Appearance.....	70
	ANNEX B: Test Setup Photos.....	71
	ANNEX C: Product Change Description.....	72

Version	Revision description	Issue Date
Rev.0	Initial issue of report.	March 17, 2023
Rev.1	Update information.	April 27, 2023
<p>Note: This revised report (Report No.: R2301A0022-R3V1) supersedes and replaces the previously issued report (Report No.: R2301A0022-R3). Please discard or destroy the previously issued report and dispose of it accordingly.</p>		

Summary of Measurement Results

Number	Test Case	Clause in FCC rules	Verdict
1	RF Power Output and Effective Isotropic Radiated Power	2.1046/ 27.50(d)(4)/ 27.50(b)(10)/ 27.50(c)(10)	PASS
2	Occupied Bandwidth	2.1049	PASS
3	Band Edge Compliance	27.53(h)/ 27.53(g)/ 27.53(f)/ 27.53(c)	PASS
4	Peak-to-Average Power Ratio	27.50(d)/ KDB971168 D01(5.7)	PASS
5	Frequency Stability	2.1055/ 27.54	PASS
6	Spurious Emissions at Antenna Terminals	2.1051/ 27.53(h)/ 27.53(g)/ 27.53(f)/ 27.53(c)	PASS
7	Radiates Spurious Emission	2.1053/ 27.53(h)/ 27.53(g)/ 27.53(f)/ 27.53(c)	PASS
Date of Testing: July 21, 2021 ~ August 5, 2021			
Date of Sample Received: July 20, 2021			
Note: PASS: The EUT complies with the essential requirements in the standard. FAIL: The EUT does not comply with the essential requirements in the standard. All indications of Pass/Fail in this report are opinions expressed by TA Technology (Shanghai) Co., Ltd. based on interpretations and/or observations of test results. Measurement Uncertainties were not taken into account and are published for informational purposes only.			

BG950A-GL (Report No.: R2301A0022-R3V1) is a variant model of BG950A-GL (Report No.: R2107A0607-R3). BG950A-GL supports from Cat NB1 (3GPP R13) to Cat NB2 (3GPP R14) only by FW updating, the hardware remains the same.

The detailed product change description please refers to following table:

Module	BG950A-GL (Cat NB1)	BG950A-GL (Cat NB2)
Category	Cat M1 & NB1	Cat M1 & NB2
Frequency Bands	Cat M1 Band 2/4/5/12/13/25/26/66 Cat NB1 Band 2/4/5/12/13/17/25/66	Cat M1 Band 2/4/5/12/13/25/26/66 Cat NB2 Band 2/4/5/12/13/17/25/66
Others	The same	

There is only verified RF Power Output and Effective Radiated Power, Band Edge Compliance, Spurious Emissions at Antenna Terminals and Radiates Spurious Emission (NB-IoT Band 13, CH Low/Middle/High, 3.75KHz, BPSK), and did not worsen, so they were not recorded in the report.

The detailed product change description please refers to the Difference Declaration Letter.

1 Test Laboratory

1.1 Notes of the Test Report

This report shall not be reproduced in full or partial, without the written approval of **TA technology (shanghai) co., Ltd.** The results documented in this report apply only to the tested sample, under the conditions and modes of operation as described herein .Measurement Uncertainties were not taken into account and are published for informational purposes only. This report is written to support regulatory compliance of the applicable standards stated above.

1.2. Test facility

FCC (Designation number: CN1179, Test Firm Registration Number: 446626)

TA Technology (Shanghai) Co., Ltd. has been listed on the US Federal Communications Commission list of test facilities recognized to perform measurements.

A2LA (Certificate Number: 3857.01)

TA Technology (Shanghai) Co., Ltd. has been listed by American Association for Laboratory Accreditation to perform measurement.

1.3 Testing Location

Company: TA Technology (Shanghai) Co., Ltd.
Address: Building 3, No.145, Jintang Rd, Pudong Shanghai, P.R.China
City: Shanghai
Post code: 201201
Country: P. R. China
Contact: Xu Kai
Telephone: +86-021-50791141/2/3
Fax: +86-021-50791141/2/3-8000
Website: <http://www.ta-shanghai.com>
E-mail: xukai@ta-shanghai.com

2 General Description of Equipment under Test

2.1 Applicant and Manufacturer Information

Applicant	Quectel Wireless Solutions Co., Ltd.
Applicant address	Building 5, Shanghai Business Park Phase III (Area B), No.1016 Tianlin Road, Minhang District, Shanghai, China, 200233
Manufacturer	Quectel Wireless Solutions Co., Ltd.
Manufacturer address	Building 5, Shanghai Business Park Phase III (Area B), No.1016 Tianlin Road, Minhang District, Shanghai, China, 200233

2.2 General information

EUT Description			
Model	BG950A-GL		
IMEI	(Original) 869410050002659		
Hardware Version	R1.5		
Software Version	BG950AGLAAR02A01		
Power Supply	External power supply		
Antenna Type	External Antenna		
Antenna Gain	Mode	Frequency (MHz)	Gain (dBi)
	NB-IoT Band 4	1700	1.67
		1720	1.94
		1740	2.00
		1760	1.57
	NB-IoT Band 12/17	700	1.66
		710	3.26
		720	3.95
	NB-IoT Band 13	770	3.98
		780	4.45
		790	3.63
	NB-IoT Band 66	1700	1.67
		1720	1.94
		1740	2.00
		1760	1.57
		1780	0.97
	Test Mode(s)	NB-IoT Band 4/12/13/17/66;	
Test Modulation	BPSK, QPSK		
Category	NB2		

Deployment	standalone, in-band, guard-band		
Sub-carrier spacing	3.75KHz, 15KHz		
Ntones	single-tone, multi-tone		
Maximum E.I.R.P./ E.R.P.	NB-IoT Band 4:	25.91dBm	
	NB-IoT Band 12:	25.29dBm	
	NB-IoT Band 13:	25.87dBm	
	NB-IoT Band 17:	25.29dBm	
	NB-IoT Band 66:	25.91dBm	
Rated Power Supply Voltage	3.3V		
Operating Voltage	Minimum: 2.2V Maximum: 4.35V		
Operating Temperature	Lowest: -35°C Highest: +75°C		
Extreme Temperature	Lowest: -40°C Highest: +85°C		
Frequency Range(s)	Mode	Tx (MHz)	Rx (MHz)
	NB-IoT Band 4:	1710 ~ 1755	2110 ~ 2155
	NB-IoT Band 12:	699 ~ 716	729 ~ 746
	NB-IoT Band 13:	777 ~ 787	746 ~ 756
	NB-IoT Band 17:	704 ~ 716	734 ~ 746
	NB-IoT Band 66:	1710 ~ 1780	2110 ~ 2180
Note: 1. The EUT is sent from the applicant to TA and the information of the EUT is declared by the applicant.			

3 Applied Standards

According to the specifications of the manufacturer, it must comply with the requirements of the following standards:

Test standards:

FCC CFR47 Part 27C (2022)

FCC CFR47 Part 2 (2022)

Reference standard:

ANSI C63.26-2015

KDB 971168 D01 Power Meas License Digital Systems v03r01

4 Test Configuration

Radiated measurements are performed by rotating the EUT in three different orthogonal test planes. EUT stand-up position (Z axis), lie-down position (X, Y axis). Receiver antenna polarization (horizontal and vertical), the worst emission was found in position (Z axis, vertical polarization) and the worst case was recorded.

All modes as Subcarrier Spacing, modulations, Channel were investigated.

Subsequently, only the worst case emissions are reported.

The following testing in NB-IoT is set based on the maximum RF Output Power.

The following testing in different mode is set to detail in the following table

Test modes are chosen to be reported as the worst case configuration below for NB-IoT Band 4/12/13/17/66:

Test items	Mode	Deployment mode	Subcarrier Spacing (kHz)		Modulation		Test Channel		
		Stand-alone	3.75	15	BPSK	QPSK	L	M	H
RF Power Output and Effective Isotropic Radiated Power	NB-IoT B4	O	O	O	O	O	O	O	O
	NB-IoT B12	O	O	O	O	O	O	O	O
	NB-IoT B13	O	O	O	O	O	O	O	O
	NB-IoT B17	O	O	O	O	O	O	O	O
	NB-IoT B66	O	O	O	O	O	O	O	O
Occupied Bandwidth	NB-IoT B4	O	O	O	O	O	O	O	O
	NB-IoT B12	O	O	O	O	O	O	O	O
	NB-IoT B13	O	O	O	O	O	O	O	O
	NB-IoT B17	O	O	O	O	O	O	O	O
	NB-IoT B66	O	O	O	O	O	O	O	O
Band Edge Compliance	NB-IoT B4	O	O	O	O	O	O	-	O
	NB-IoT B12	O	O	O	O	O	O	-	O
	NB-IoT B13	O	O	O	O	O	O	-	O
	NB-IoT B17	O	O	O	O	O	O	-	O
	NB-IoT B66	O	O	O	O	O	O	-	O
Peak-to-Average Power Ratio	NB-IoT B4	O	O	O	O	O	O	O	O
	NB-IoT B12	O	O	O	O	O	O	O	O
	NB-IoT B13	O	O	O	O	O	O	O	O
	NB-IoT B17	O	O	O	O	O	O	O	O
	NB-IoT B66	O	O	O	O	O	O	O	O
Frequency Stability	NB-IoT B4	O	O	O	O	O	-	O	-
	NB-IoT B12	O	O	O	O	O	-	O	-

	NB-IoT B13	O	O	O	O	O	-	O	-
	NB-IoT B17	O	O	O	O	O	-	O	-
	NB-IoT B66	O	O	O	O	O	-	O	-
Conducted Spurious Emissions	NB-IoT B4	O	-	O	-	O	O	O	O
	NB-IoT B12	O	-	O	-	O	O	O	O
	NB-IoT B13	O	-	O	-	O	O	O	O
	NB-IoT B17	O	-	O	-	O	O	O	O
	NB-IoT B66	O	-	O	-	O	O	O	O
Radiates Spurious Emission	NB-IoT B4	O	-	O	-	O	-	O	-
	NB-IoT B12	O	-	O	-	O	-	O	-
	NB-IoT B13	O	-	O	-	O	-	O	-
	NB-IoT B17	O	-	O	-	O	-	O	-
	NB-IoT B66	O	-	O	-	O	-	O	-
Note 1. The mark "O" means that this configuration is chosen for testing. 2. The mark "-" means that this configuration is not testing.									

5 Test Case Results

5.1 RF Power Output and Effective Isotropic Radiated Power

Ambient condition

Temperature	Relative humidity	Pressure
23°C ~25°C	45%~50%	101.5kPa

Methods of Measurement

During the process of the testing, The EUT was connected to the Base Station Simulator with a known loss. The EUT is controlled by the Base Station Simulator test set to ensure max power transmission with proper modulation.

ERP can then be calculated as follows:

$$\text{EIRP (dBm)} = \text{Output Power (dBm)} + \text{Antenna Gain (dBi)}$$

$$\text{EIRP (dBm)} = \text{ERP (dBm)} + 2.15 \text{ (dB.)}$$

Test Setup

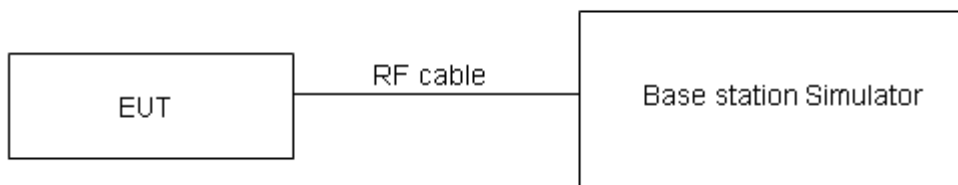

Limits

No specific RF power output requirements in part 2.1046.

Rule Part 27.50(b) (10) specifies that “Portable stations (hand-held devices) transmitting in the 746-757 MHz, 776-788 MHz, and 805-806 MHz bands are limited to 3 watts ERP”

Rule Part 27.50(c) (10) specifies that “Portable stations (hand-held devices) in the 600 MHz uplink band and the 698-746 MHz band, and fixed and mobile stations in the 600 MHz uplink band are limited to 3 watts ERP”

Rule Part 27.50(d) (4) specifies that “Fixed, mobile and portable (hand-held) stations operating in the 1710–1755 MHz band are limited to 1 watt EIRP”

Part 27.50(b)(10)Limit	≤ 3 W (34.77 dBm)
Part 27.50(c)(10)Limit	≤ 3 W (34.77 dBm)

Part 27.50(d)(4)Limit

 $\leq 1 \text{ W}$ (30 dBm)

Measurement Uncertainty

The assessed measurement uncertainty to ensure 95% confidence level for the normal distribution is with the coverage factor $k = 2$, $U = 0.4 \text{ dB}$ for RF power output, $k = 2$, $U = 1.19 \text{ dB}$ for ERP/EIRP.

Test Results

Mode	Modulation	Sub-carrier spacing (KHz)	Ntones	Maximum Output Power (dBm) for low/middle/high channel			EIRP (dBm)		
				19952/ 1710.2MHz	20175/ 1732.5 MHz	20398/ 1754.8 MHz	19952/ 1710.2MHz	20175/ 1732.5 MHz	20398/ 1754.8 MHz
NB-IoT Band 4	BPSK	3.75	1@0	23.94	23.65	23.44	25.88	25.01	24.69
			1@47	23.93	23.62	23.37	25.87	24.98	24.62
		15	1@0	23.85	23.73	23.59	25.79	25.09	24.84
			1@11	23.87	23.62	23.60	25.81	24.98	24.85
	QPSK	3.75	1@0	23.95	23.67	23.40	25.89	25.03	24.65
			1@47	23.97	23.61	23.38	25.91	24.97	24.63
		15	1@0	23.87	23.70	23.57	25.81	25.06	24.82
			1@11	23.94	23.77	23.61	25.88	25.13	24.86
		15	12@0	21.24	21.31	21.23	23.18	22.67	22.48

Mode	Modulation	Sub-carrier spacing (KHz)	Ntones	Maximum Output Power (dBm) for low/middle/high channel			ERP (dBm)		
				23012/ 699.2 MHz	23095/ 707.5 MHz	23178/ 715.8 MHz	23012/ 699.2 MHz	23095/ 707.5 MHz	23178/ 715.8 MHz
NB-IoT Band 12	BPSK	3.75	1@0	23.08	23.17	23.32	22.59	24.28	25.12
			1@47	23.04	23.18	23.34	22.55	24.29	25.14
		15	1@0	23.36	23.45	23.42	22.87	24.56	25.22
			1@11	23.29	23.32	23.35	22.80	24.43	25.15
	QPSK	3.75	1@0	23.07	23.21	23.36	22.58	24.32	25.16
			1@47	23.03	23.23	23.32	22.54	24.34	25.12
		15	1@0	23.25	23.36	23.34	22.76	24.47	25.14
			1@11	23.31	23.47	23.49	22.82	24.58	25.29
		15	12@0	21.21	21.24	21.26	20.72	22.35	23.06

Mode	Modulation	Sub-carrier spacing (KHz)	Ntones	Maximum Output Power (dBm) for low/middle/high channel			ERP (dBm)		
				23182/ 777.2 MHz	23230/ 782MHz	23278/ 786.8 MHz	23182/ 777.2 MHz	23230/ 782MHz	23278/ 786.8 MHz
NB-IoT Band 13	BPSK	3.75	1@0	23.16	23.19	23.16	25.46	25.49	24.64
			1@47	23.15	23.12	23.12	25.45	25.42	24.60
		15	1@0	23.52	23.57	23.47	25.82	25.87	24.95
			1@11	23.41	23.42	23.50	25.71	25.72	24.98
	QPSK	3.75	1@0	23.18	23.13	23.12	25.48	25.43	24.60
			1@47	23.17	23.14	23.08	25.47	25.44	24.56
		15	1@0	23.32	23.42	23.54	25.62	25.72	25.02
			1@11	23.51	23.56	23.62	25.81	25.86	25.10
		15	12@0	21.21	21.20	21.26	23.51	23.50	22.74

Mode	Modulation	Sub-carrier spacing (KHz)	Ntones	Maximum Output Power (dBm) for low/middle/high channel			ERP (dBm)		
				23732/ 704.2 MHz	23790/ 710 MHz	23848/ 715.8 MHz	23732/ 704.2 MHz	23790/ 710 MHz	23848/ 715.8 MHz
NB-IoT Band 17	BPSK	3.75	1@0	23.27	23.28	23.38	22.78	24.39	25.18
			1@47	23.18	23.24	23.33	22.69	24.35	25.13
		15	1@0	23.40	23.42	23.45	22.91	24.53	25.25
			1@11	23.34	23.29	23.34	22.85	24.40	25.14
	QPSK	3.75	1@0	23.22	23.21	23.31	22.73	24.32	25.11
			1@47	23.20	23.20	23.32	22.71	24.31	25.12
		15	1@0	23.47	23.46	23.49	22.98	24.57	25.29
			1@11	23.38	23.43	23.43	22.89	24.54	25.23
		15	12@0	21.26	21.25	21.25	20.77	22.36	23.05

Mode	Modulation	Sub-carrier spacing (KHz)	Ntones	Maximum Output Power (dBm) for low/middle/high channel			EIRP (dBm)		
				131974/ 1710.2 MHz	132322/ 1745 MHz	132670/ 1779.8 MHz	131974/ 1710.2 MHz	132322/ 1745 MHz	132670/ 1779.8 MHz
NB-IoT Band 66	BPSK	3.75	1@0	23.96	23.55	23.29	25.90	25.55	24.26
			1@47	23.95	23.52	23.28	25.89	25.52	24.25
		15	1@0	23.92	23.74	23.71	25.86	25.74	24.68
			1@11	23.91	23.68	23.69	25.85	25.68	24.66
	QPSK	3.75	1@0	23.97	23.56	23.26	25.91	25.56	24.23
			1@47	23.96	23.51	23.25	25.90	25.51	24.22
		15	1@0	23.92	23.72	23.70	25.86	25.72	24.67
			1@11	23.85	23.82	23.73	25.79	25.82	24.70
		15	12@0	21.29	21.31	21.26	23.23	23.31	22.23

5.2 Occupied Bandwidth

Ambient condition

Temperature	Relative humidity	Pressure
23°C ~25°C	45%~50%	101.5kPa

Method of Measurement

The EUT was connected to Spectrum Analyzer and Base Station Simulator via power Splitter. The occupied bandwidth is measured using spectrum analyzer.

RBW is set to 2kHz, VBW is set to 6.2kHz for NB-IoT Band 4/12/13/17/66.

99% power and -26dBc occupied bandwidths are recorded. Spectrum analyzer plots are included on the following pages.

Test Setup

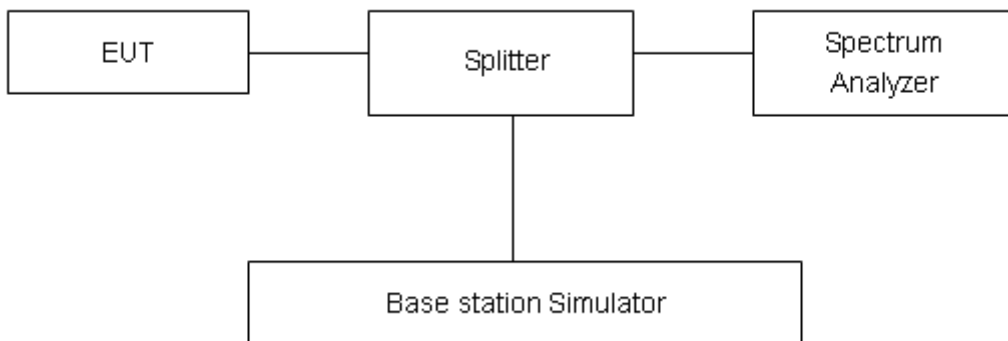

Limits

No specific occupied bandwidth requirements in part 2.1049.

Measurement Uncertainty

The assessed measurement uncertainty to ensure 95% confidence level for the normal distribution is with the coverage factor $k = 2$, $U = 624\text{Hz}$.

Test Result

Mode	Modulation	Sub-carrier spacing (KHz)	Ntones	Bandwidth(KHz) for low/mid/high channel					
				19952/1710.2 MHz		20175/1732.5 MHz		20398/1754.8 MHz	
				99% Power	-26dBc	99% Power	-26dBc	99% Power	-26dBc
Band 4 Standalone	BPSK	3.75	1@0	38.88	37.55	39.52	38.22	37.34	36.77
	QPSK	3.75	1@0	42.20	42.09	41.04	38.95	41.81	39.25
	BPSK	15	1@0	79.03	101.00	74.86	91.85	75.09	91.10
	QPSK	15	1@0	74.54	102.60	73.36	103.00	74.11	100.10
	QPSK	15	12@0	186.82	254.90	188.23	242.50	185.71	252.00
Mode	Modulation	Sub-carrier spacing (KHz)	Ntones	Bandwidth(KHz) for low/mid/high channel					
				23012/699.2 MHz		23095/707.5 MHz		23178/715.8 MHz	
				99% Power	-26dBc	99% Power	-26dBc	99% Power	-26dBc
Band 12 Standalone	BPSK	3.75	1@0	37.26	37.97	37.11	37.55	38.05	37.33
	QPSK	3.75	1@0	41.34	42.39	39.98	39.75	41.52	42.34
	BPSK	15	1@0	73.18	93.47	73.68	89.71	71.78	90.43
	QPSK	15	1@0	73.39	100.70	71.13	90.53	73.60	103.40
	QPSK	15	12@0	187.93	261.10	185.92	262.40	187.08	268.40
Mode	Modulation	Sub-carrier spacing (KHz)	Ntones	Bandwidth(KHz) for low/mid/high channel					
				23182/777.2 MHz		23230/782 MHz		23278/786.8 MHz	
				99% Power	-26dBc	99% Power	-26dBc	99% Power	-26dBc
Band 13 Standalone	BPSK	3.75	1@0	37.25	37.28	38.13	37.08	37.23	37.44
	QPSK	3.75	1@0	41.45	41.33	41.63	41.74	41.51	42.30
	BPSK	15	1@0	74.84	99.39	75.88	93.36	72.67	89.17
	QPSK	15	1@0	73.62	100.60	73.43	102.40	71.42	88.34
	QPSK	15	12@0	185.48	262.20	184.16	266.50	186.70	256.30
Mode	Modulation	Sub-carrier spacing (KHz)	Ntones	Bandwidth(KHz) for low/mid/high channel					
				23732/704.2 MHz		23790/710 MHz		23848/715.8 MHz	
				99% Power	-26dBc	99% Power	-26dBc	99% Power	-26dBc
Band 17 Standalone	BPSK	3.75	1@0	26.38	29.57	37.01	36.82	36.29	36.75
	QPSK	3.75	1@0	28.03	30.57	40.18	38.78	40.94	39.47
	BPSK	15	1@0	68.88	79.40	73.54	92.96	72.22	89.94
	QPSK	15	1@0	68.57	90.26	70.30	90.51	74.88	103.00
	QPSK	15	12@0	184.98	248.80	186.09	263.50	185.53	246.40
Mode	Modulation	Sub-carrier spacing (KHz)	Ntones	Bandwidth(KHz) for low/mid/high channel					
				131974/1710.2 MHz		132322/1745 MHz		132670/1779.8 MHz	
				99% Power	-26dBc	99% Power	-26dBc	99% Power	-26dBc
Band 66 Standalone	BPSK	3.75	1@0	39.62	37.64	38.28	37.92	39.84	38.63
	QPSK	3.75	1@0	41.01	38.50	42.28	41.72	42.92	42.09
	BPSK	15	1@0	74.06	90.64	74.16	95.35	72.04	89.61
	QPSK	15	1@0	74.14	101.30	72.10	102.60	74.29	100.90
	QPSK	15	12@0	187.01	263.50	185.17	252.40	185.62	266.90

NB-IoT Band 4 BPSK 3.75KHz 1@0 CH-Low



NB-IoT Band 4 BPSK 15KHz 1@0 CH-Low

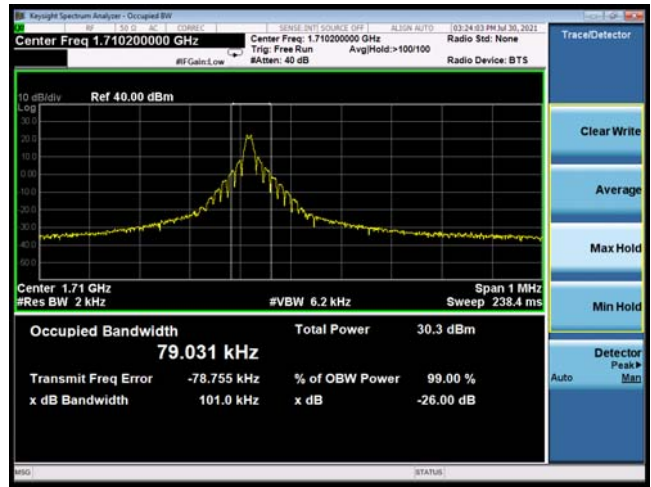

NB-IoT Band 4 BPSK 3.75KHz 1@0 CH-Middle

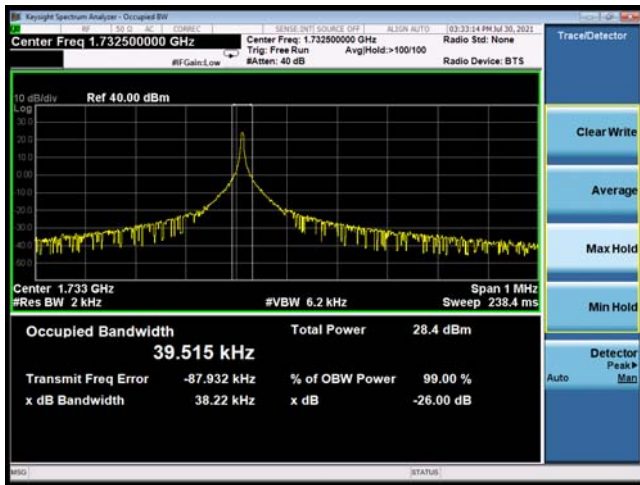

NB-IoT Band 4 BPSK 15KHz 1@0 CH-Middle



NB-IoT Band 4 BPSK 3.75KHz 1@0 CH-High

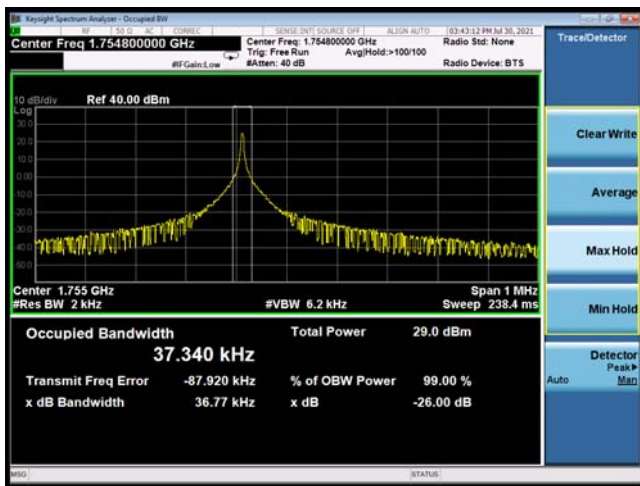

NB-IoT Band 4 BPSK 15KHz 1@0 CH-High



NB-IoT Band 4 QPSK 3.75KHz 1@0 CH-Low

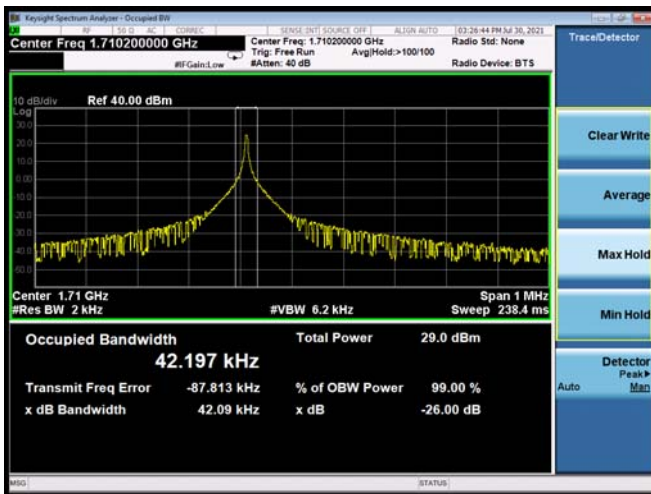

NB-IoT Band 4 QPSK 15KHz 1@0 CH-Low



NB-IoT Band 4 QPSK 3.75KHz 1@0 CH-Middle



NB-IoT Band 4 QPSK 15KHz 1@0 CH-Middle



NB-IoT Band 4 QPSK 3.75KHz 1@0 CH-High



NB-IoT Band 4 QPSK 15KHz 1@0 CH-High



NB-IoT Band 4 QPSK 15KHz 12@0 CH-Low



NB-IoT Band 4 QPSK 15KHz 12@0 CH-Middle



NB-IoT Band 4 QPSK 15KHz 12@0 CH-High



NB-IoT Band 12 BPSK 3.75KHz 1@0 CH-Low



NB-IoT Band 12 BPSK 15KHz 1@0 CH-Low

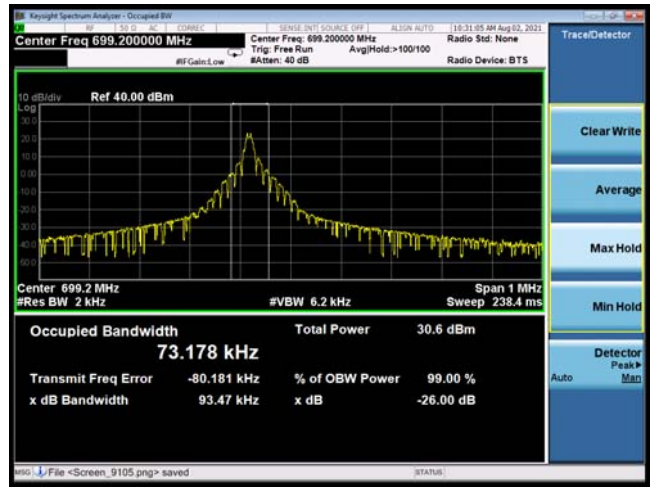

NB-IoT Band 12 BPSK 3.75KHz 1@0 CH-Middle



NB-IoT Band 12 BPSK 15KHz 1@0 CH-Middle



NB-IoT Band 12 BPSK 3.75KHz 1@0 CH-High

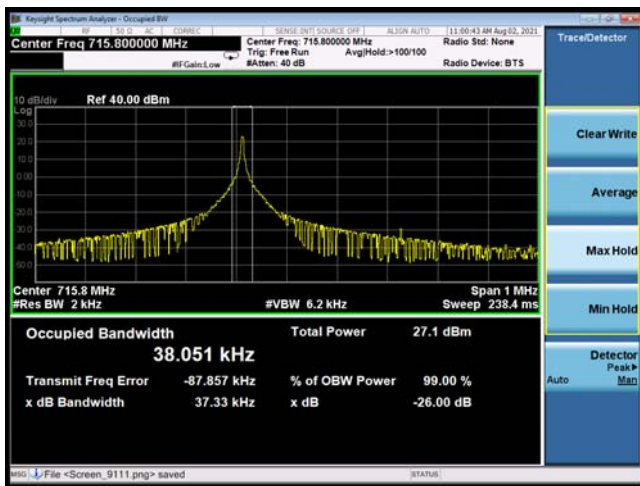

NB-IoT Band 12 BPSK 15KHz 1@0 CH-High



NB-IoT Band 12 QPSK 3.75KHz 1@0 CH-Low



NB-IoT Band 12 QPSK 15KHz 1@0 CH-Low



NB-IoT Band 12 QPSK 3.75KHz 1@0 CH-Middle

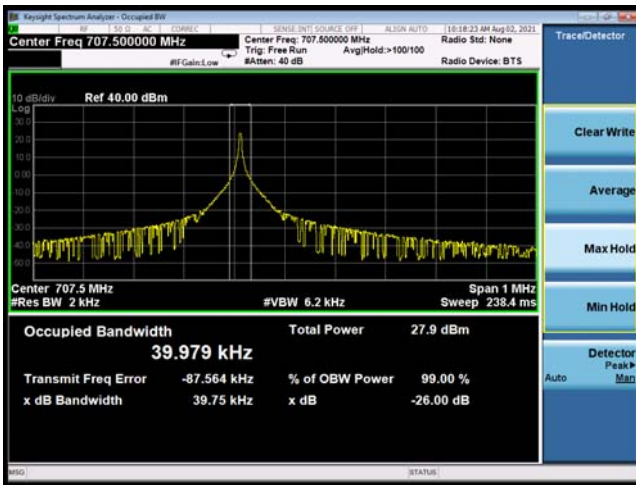

NB-IoT Band 12 QPSK 15KHz 1@0 CH-Middle



NB-IoT Band 12 QPSK 3.75KHz 1@0 CH-High

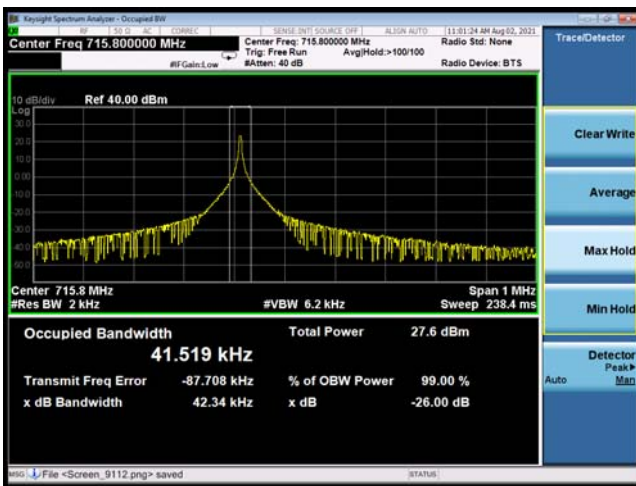

NB-IoT Band 12 QPSK 15KHz 1@0 CH-High

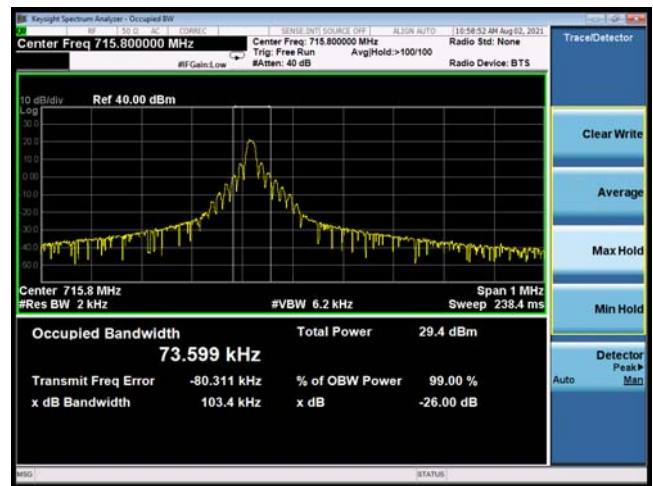

NB-IoT Band 12 QPSK 15KHz 12@0 CH-Low



NB-IoT Band 12 QPSK 15KHz 12@0 CH-Middle



NB-IoT Band 12 QPSK 15KHz 12@0 CH-High



NB-IoT Band 13 BPSK 3.75KHz 1@0 CH-Low

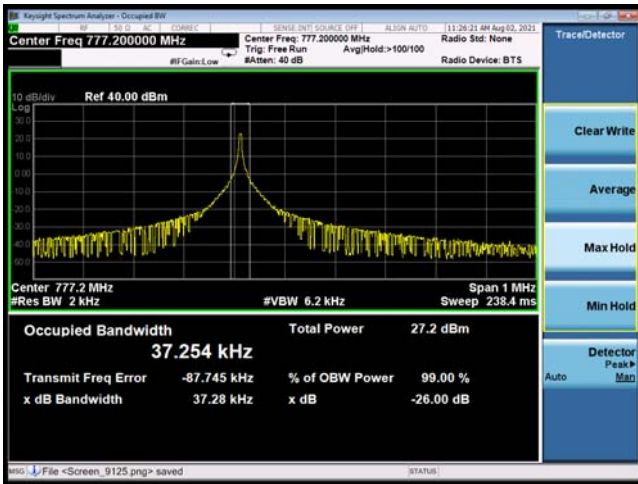

NB-IoT Band 13 BPSK 15KHz 1@0 CH-Low



NB-IoT Band 13 BPSK 3.75KHz 1@0 CH-Middle

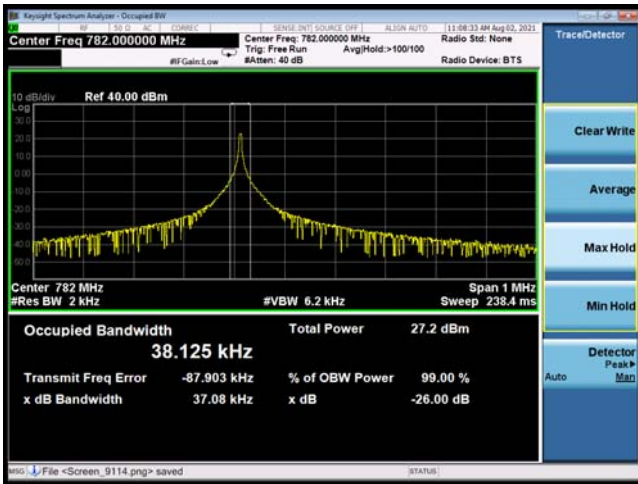

NB-IoT Band 13 BPSK 15KHz 1@0 CH-Middle



NB-IoT Band 13 BPSK 3.75KHz 1@0 CH-High

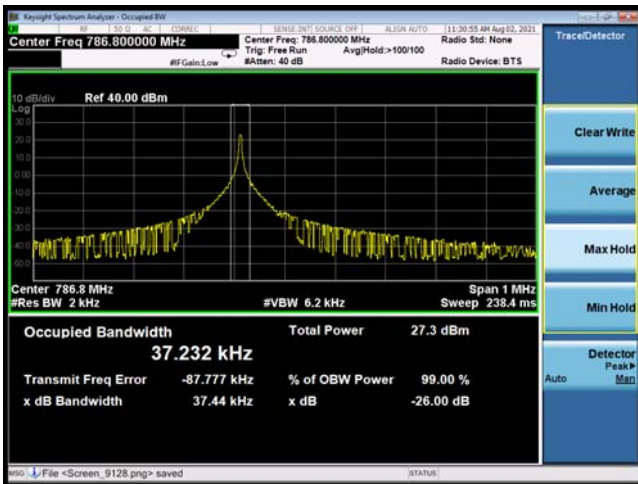

NB-IoT Band 13 BPSK 15KHz 1@0 CH-High



NB-IoT Band 13 QPSK 3.75KHz 1@0 CH-Low



NB-IoT Band 13 QPSK 15KHz 1@0 CH-Low



NB-IoT Band 13 QPSK 3.75KHz 1@0 CH-Middle

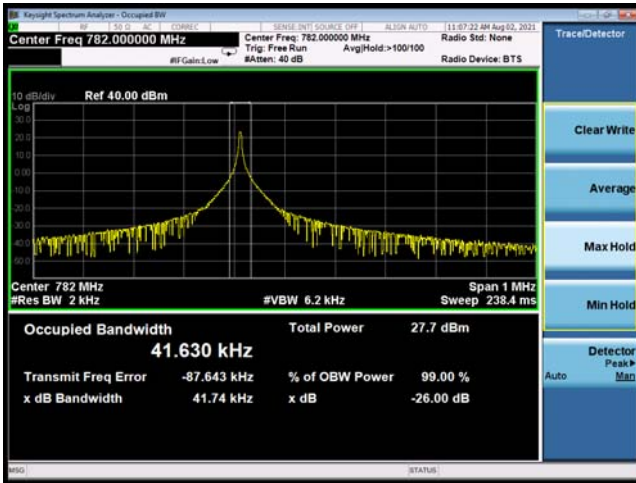

NB-IoT Band 13 QPSK 15KHz 1@0 CH-Middle



NB-IoT Band 13 QPSK 3.75KHz 1@0 CH-High

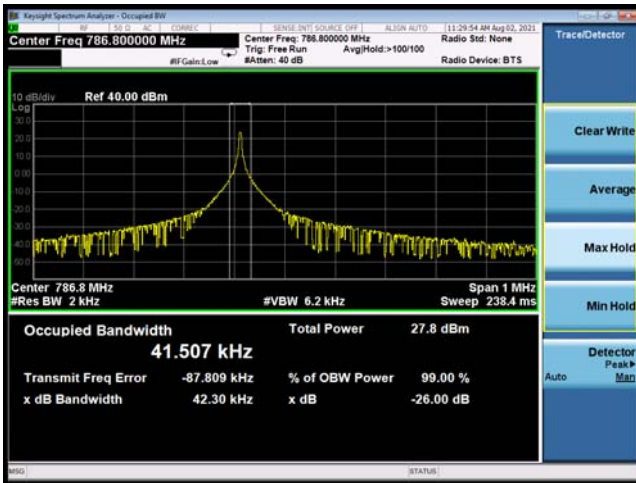

NB-IoT Band 13 QPSK 15KHz 1@0 CH-High



NB-IoT Band 13 QPSK 15KHz 12@0 CH-Low



NB-IoT Band 13 QPSK 15KHz 12@0 CH-Middle



NB-IoT Band 13 QPSK 15KHz 12@0 CH-High



NB-IoT Band 17 BPSK 3.75KHz 1@0 CH-Low



NB-IoT Band 17 BPSK 15KHz 1@0 CH-Low



NB-IoT Band 17 BPSK 3.75KHz 1@0 CH-Middle



NB-IoT Band 17 BPSK 15KHz 1@0 CH-Middle



NB-IoT Band 17 BPSK 3.75KHz 1@0 CH-High

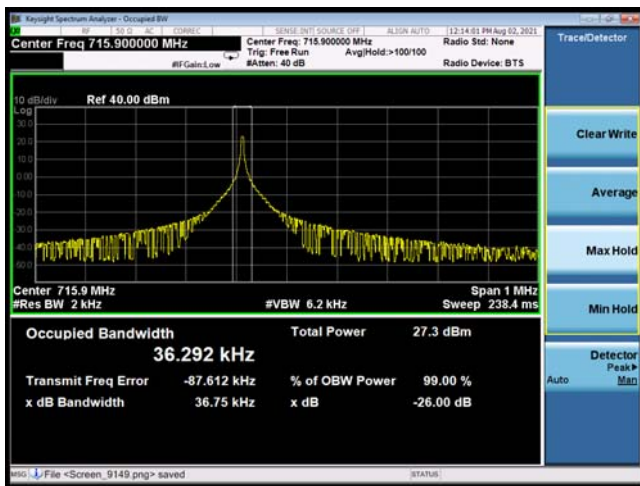

NB-IoT Band 17 BPSK 15KHz 1@0 CH-High

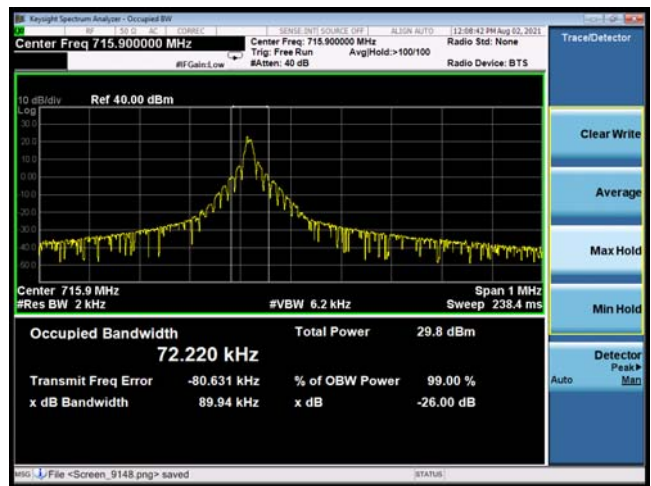

NB-IoT Band 17 QPSK 3.75KHz 1@0 CH-Low



NB-IoT Band 17 QPSK 15KHz 1@0 CH-Low

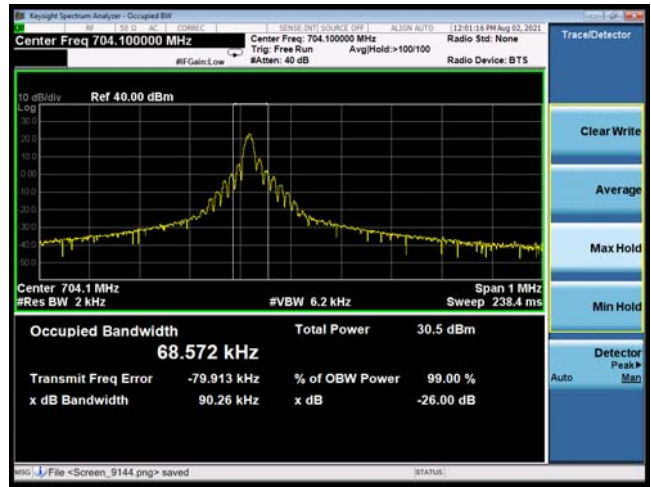

NB-IoT Band 17 QPSK 3.75KHz 1@0 CH-Middle

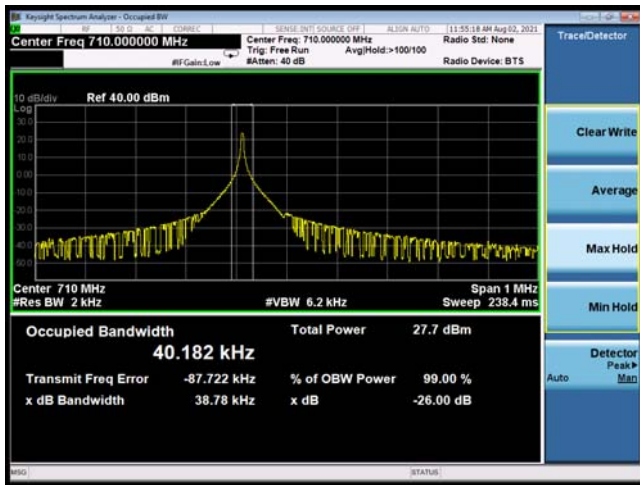

NB-IoT Band 17 QPSK 15KHz 1@0 CH-Middle



NB-IoT Band 17 QPSK 3.75KHz 1@0 CH-High

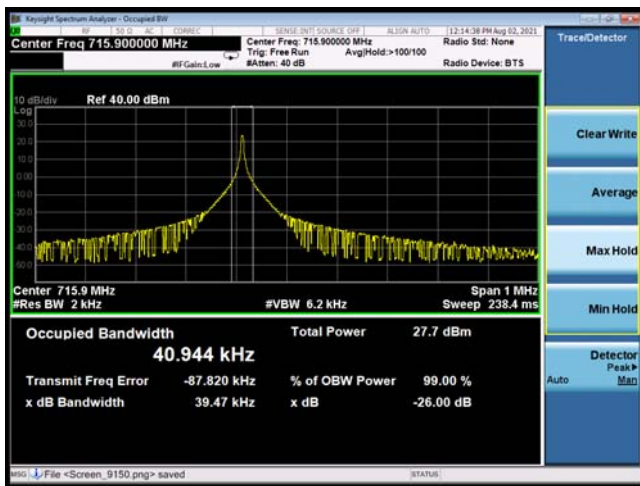

NB-IoT Band 17 QPSK 15KHz 1@0 CH-High



NB-IoT Band 17 QPSK 15KHz 12@0 CH-Low



NB-IoT Band 17 QPSK 15KHz 12@0 CH-Middle



NB-IoT Band 17 QPSK 15KHz 12@0 CH-High

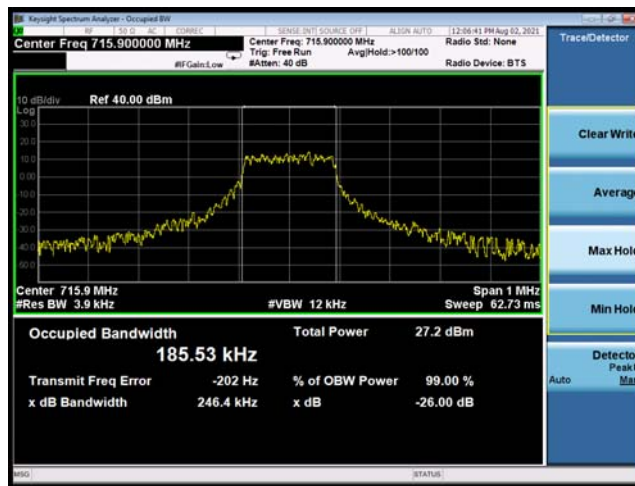

NB-IoT Band 66 BPSK 3.75KHz 1@0 CH-Low

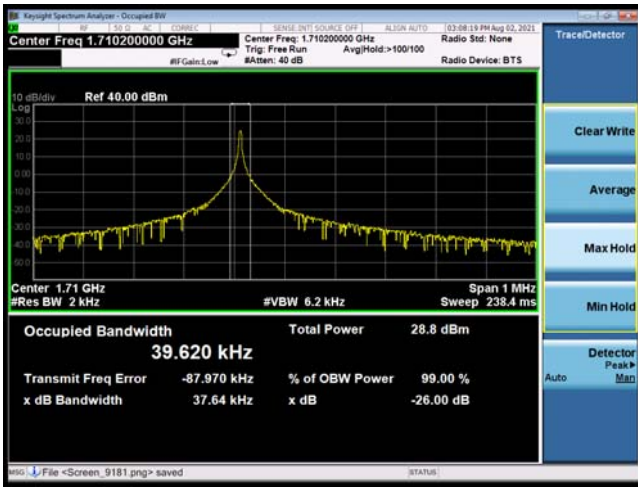

NB-IoT Band 66 BPSK 15KHz 1@0 CH-Low

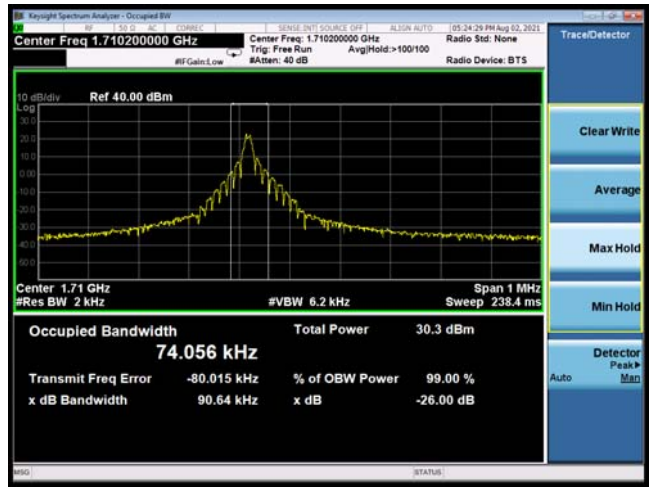

NB-IoT Band 66 BPSK 3.75KHz 1@0 CH-Middle



NB-IoT Band 66 BPSK 15KHz 1@0 CH-Middle



NB-IoT Band 66 BPSK 3.75KHz 1@0 CH-High

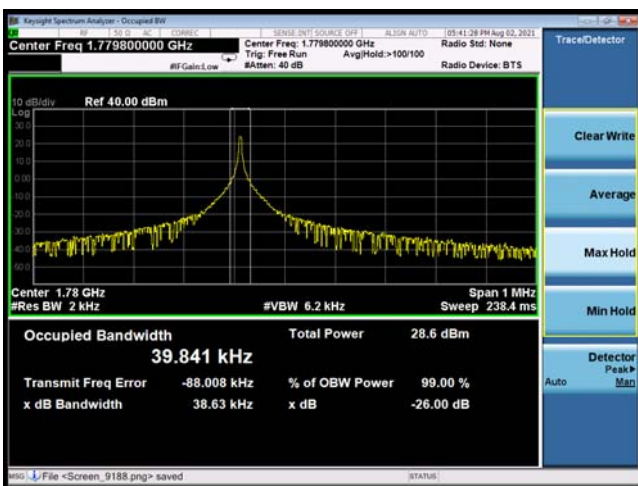

NB-IoT Band 66 BPSK 15KHz 1@0 CH-High



NB-IoT Band 66 QPSK 3.75KHz 1@0 CH-Low

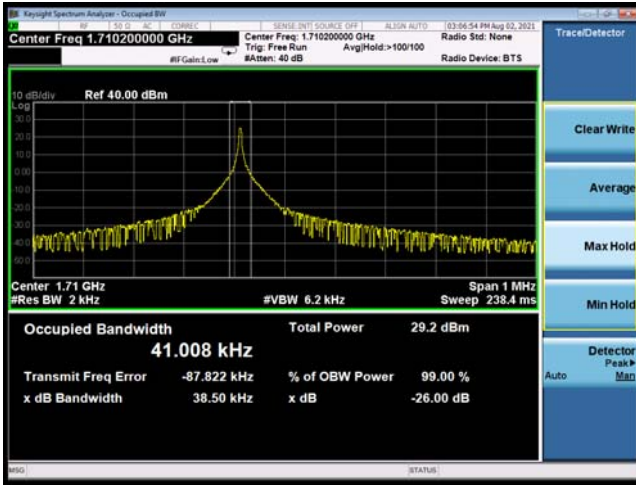

NB-IoT Band 66 QPSK 15KHz 1@0 CH-Low

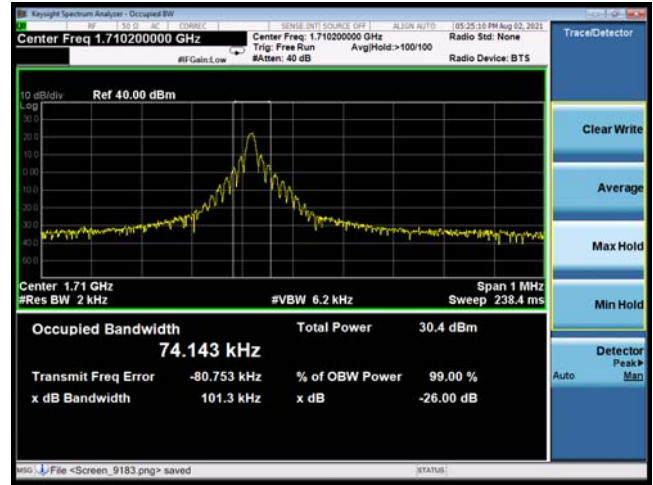

NB-IoT Band 66 QPSK 3.75KHz 1@0 CH-Middle

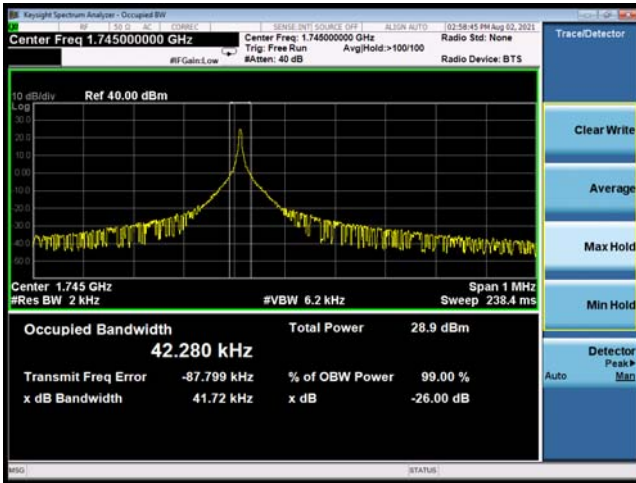

NB-IoT Band 66 QPSK 15KHz 1@0 CH-Middle



NB-IoT Band 66 QPSK 3.75KHz 1@0 CH-High

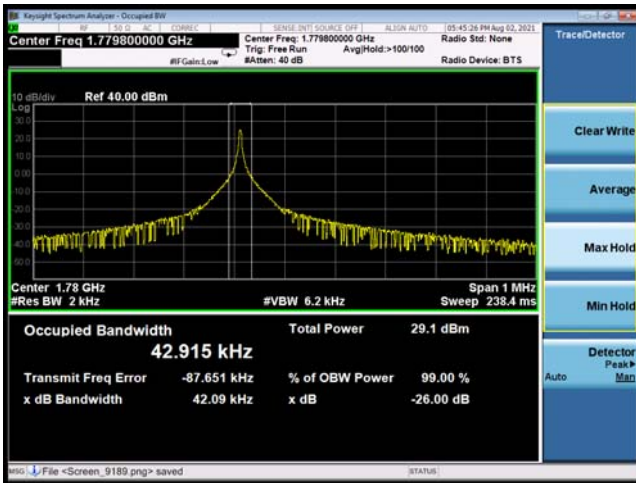

NB-IoT Band 66 QPSK 15KHz 1@0 CH-High



NB-IoT Band 66 QPSK 15KHz 12@0 CH-Low

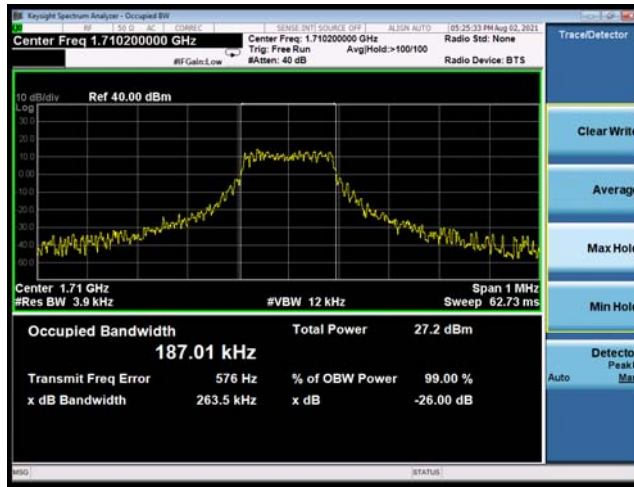

NB-IoT Band 66 QPSK 15KHz 12@0 CH-Middle



NB-IoT Band 66 QPSK 15KHz 12@0 CH-High

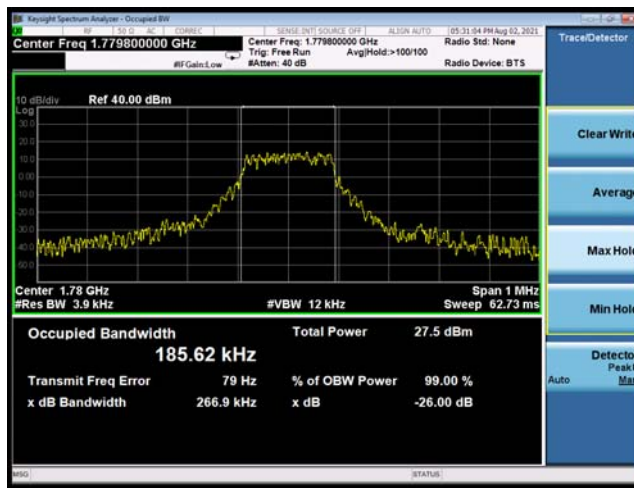

5.3 Band Edge Compliance

Ambient condition

Temperature	Relative humidity	Pressure
23°C ~25°C	45%~50%	101.5kPa

Method of Measurement

The EUT was connected to Spectrum Analyzer and Base Station Simulator via power Splitter. The band edge of the lowest and highest channels were measured.

The testing follows KDB 971168 D01 v03r01 Section 6.0

The EUT was connected to spectrum analyzer and system simulator via a power divider.

The band edges of low and high channels for the highest RF powers were measured.

RBW is set to $\geq 1\%$ EBW, VBW is set to 3x RBW on spectrum analyzer.

Set spectrum analyzer with RMS detector.

The RF fundamental frequency should be excluded against the limit line in the operating frequency band.

Checked that all the results comply with the emission limit line.

Test Setup

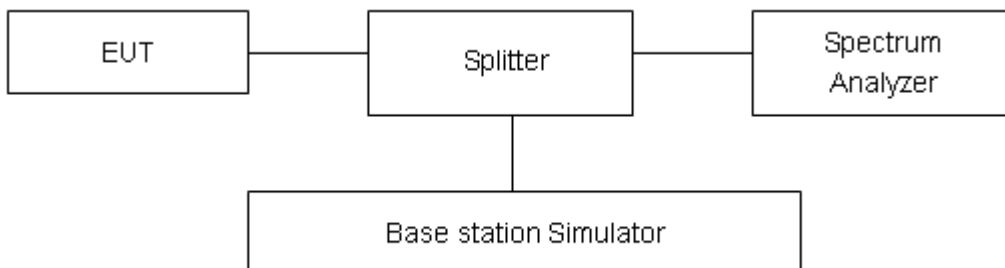

Limits

Rule Part 27.53(h) specifies that “ for operations in the 1695-1710 MHz, 1710-1755 MHz, 1755-1780 MHz, 1915-1920 MHz, 1995-2000 MHz, 2000-2020 MHz, 2110-2155 MHz, 2155-2180 MHz, and 2180-2200 bands, the power of any emission outside a licensee's frequency block shall be attenuated below the transmitter power (P) in watts by at least $43 + 10 \log_{10} (P)$ dB”

Rule Part 27.53(g) For operations in the 600 MHz band and the 698-746 MHz band, the power of any emission outside a licensee's frequency band(s) of operation shall be attenuated below the transmitter power (P) within the licensed band(s) of operation, measured in watts, by at least $43 + 10 \log (P)$ dB. Compliance with this provision is based on the use of measurement instrumentation employing a resolution bandwidth of 100 kilohertz or greater. However, in the 100 kilohertz bands immediately outside and adjacent to a licensee's frequency block, a resolution bandwidth of at least 30 kHz may be employed.

Rule Part 27.53(f) For operations in the 746-758 MHz, 775-788 MHz, and 805-806 MHz bands, emissions in the band 1559-1610 MHz shall be limited to -70 dBW/MHz equivalent isotropically radiated power (EIRP) for wideband signals, and -80 dBW EIRP for discrete emissions of less than 700 Hz bandwidth. For the purpose of equipment authorization, a transmitter shall be tested with an antenna that is representative of the type that will be used with the equipment in normal operation.

Rule Part 27.53 (c) For operations in the 746-758 MHz band and the 776-788 MHz band, the power of any emission outside the licensee's frequency band(s) of operation shall be attenuated below the transmitter power (P) within the licensed band(s) of operation, measured in watts, in accordance with the following:

- (1) On any frequency outside the 746-758 MHz band, the power of any emission shall be attenuated outside the band below the transmitter power (P) by at least $43 + 10 \log (P)$ dB;
- (2) On any frequency outside the 776-788 MHz band, the power of any emission shall be attenuated outside the band below the transmitter power (P) by at least $43 + 10 \log (P)$ dB;
- (3) On all frequencies between 763-775 MHz and 793-805 MHz, by a factor not less than $76 + 10 \log (P)$ dB in a 6.25 kHz band segment, for base and fixed stations;
- (4) On all frequencies between 763-775 MHz and 793-805 MHz, by a factor not less than $65 + 10 \log (P)$ dB in a 6.25 kHz band segment, for mobile and portable stations;
- (5) Compliance with the provisions of paragraphs (c)(1) and (c)(2) of this section is based on the use of measurement instrumentation employing a resolution bandwidth of 100 kHz or greater. However, in the 100 kHz bands immediately outside and adjacent to the frequency block, a resolution bandwidth of at least 30 kHz may be employed;

Measurement Uncertainty

The assessed measurement uncertainty to ensure 95% confidence level for the normal distribution is with the coverage factor $k = 1.96$, $U = 0.684$ dB.

Test Result

All the test traces in the plots shows the test results clearly.

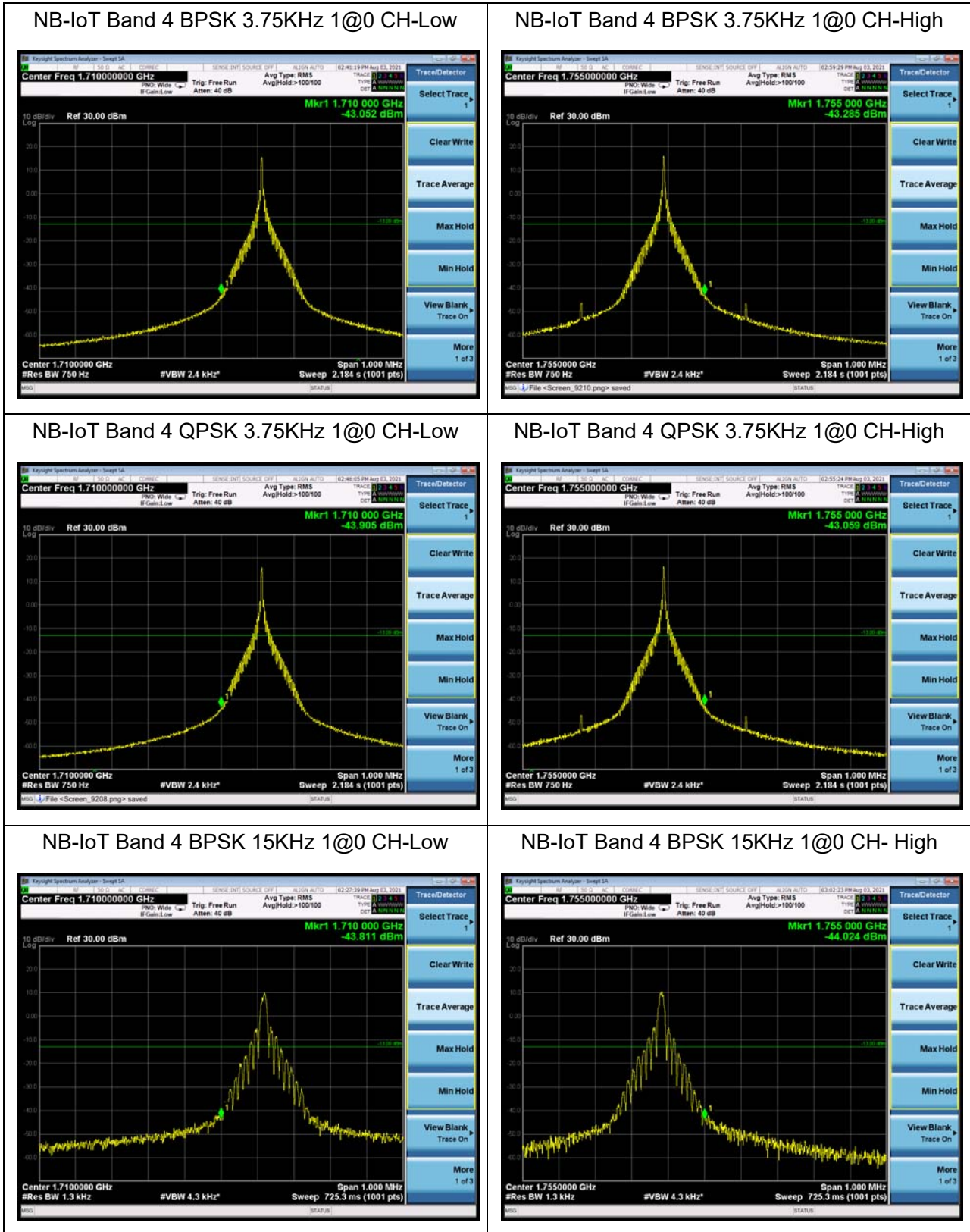

NB-IoT Band 4 QPSK 15KHz 1@0 CH-Low

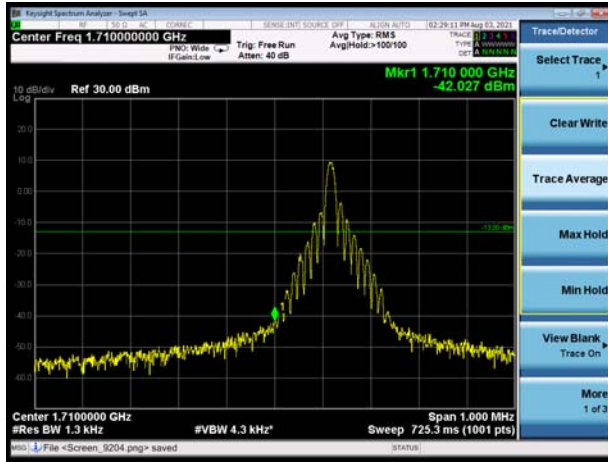

NB-IoT Band 4 QPSK 15KHz 1@0 CH- High

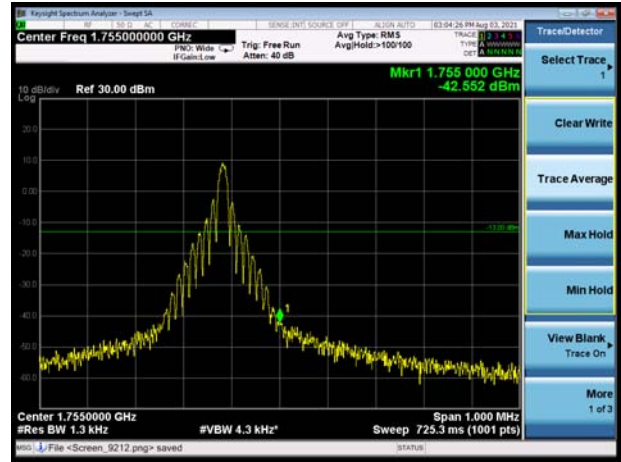

NB-IoT Band 4 QPSK 15KHz 12@0 CH-Low

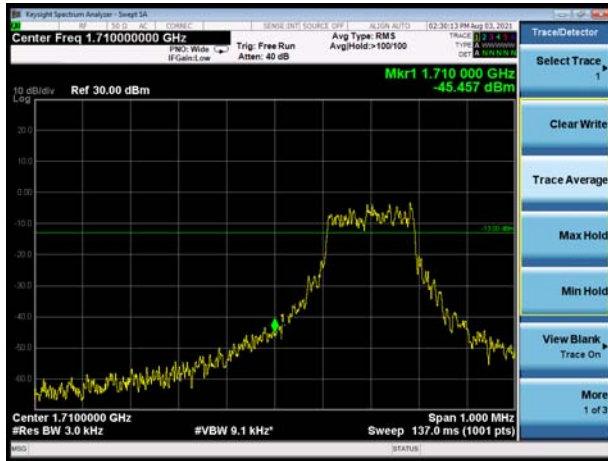

NB-IoT Band 4 QPSK 15KHz 12@0 CH- High

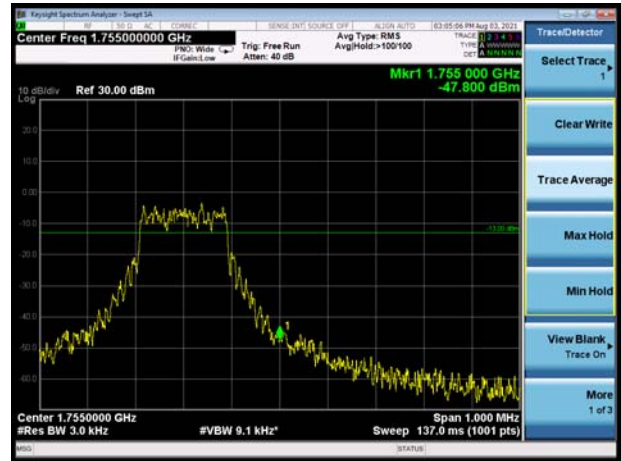

NB-IoT Band 12 BPSK 3.75KHz 1@0 CH-Low

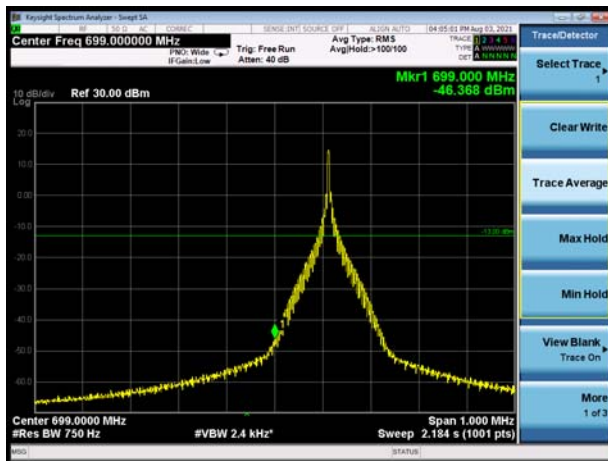

NB-IoT Band 12 BPSK 3.75KHz 1@0 CH- High

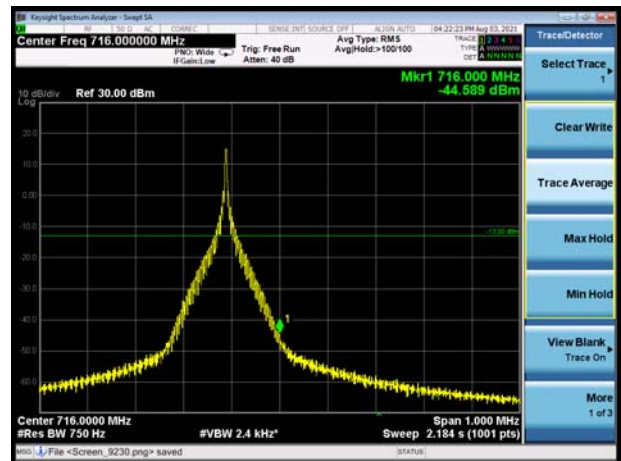

NB-IoT Band 12 QPSK 3.75KHz 1@0 CH-Low

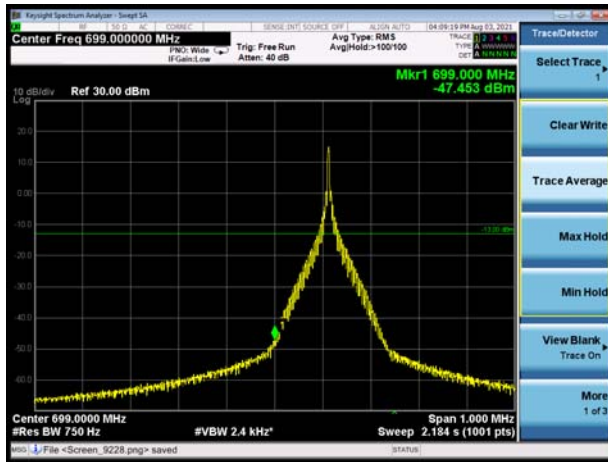

NB-IoT Band 12 QPSK 3.75KHz 1@0 CH- High

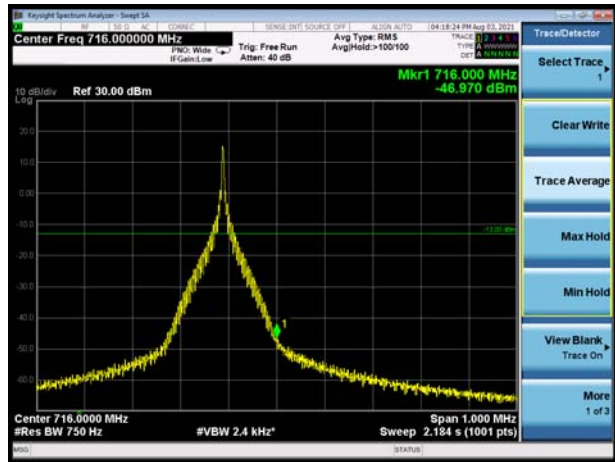

NB-IoT Band 12 BPSK 15KHz 1@0 CH-Low

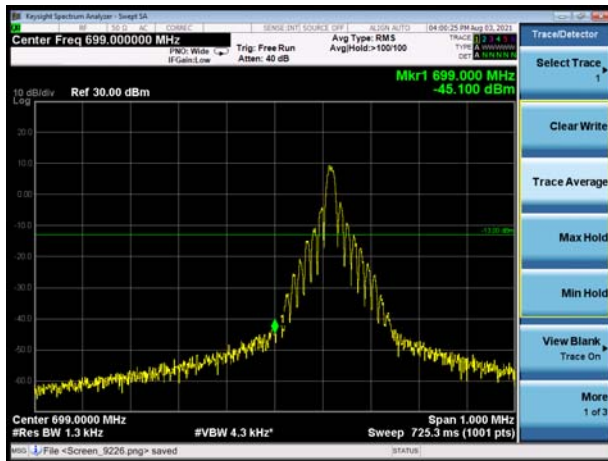

NB-IoT Band 12 BPSK 15KHz 1@0 CH- High

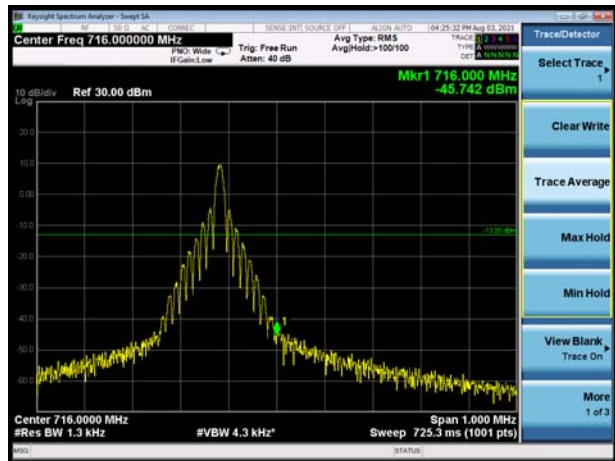

NB-IoT Band 12 QPSK 15KHz 1@0 CH-Low

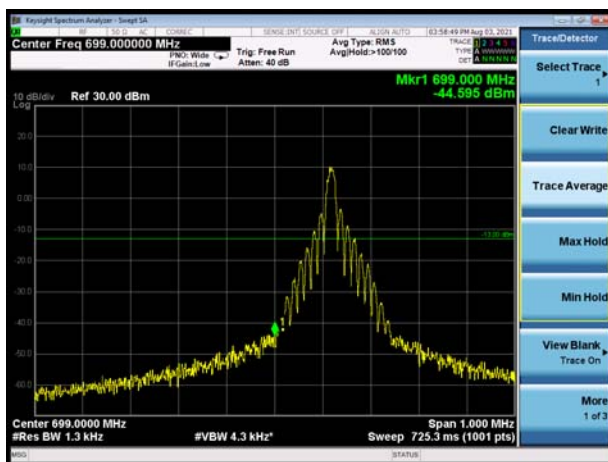

NB-IoT Band 12 QPSK 15KHz 1@0 CH- High

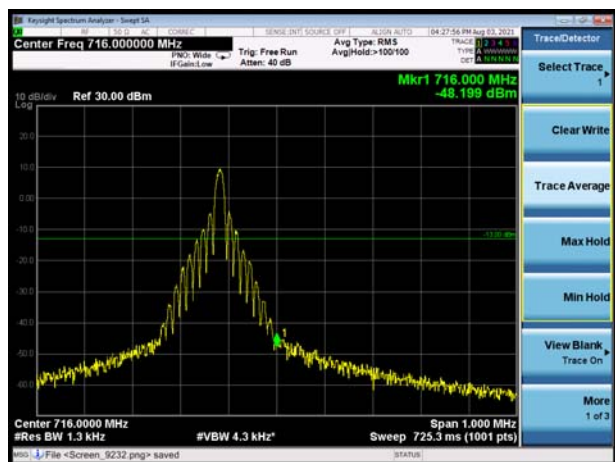

NB-IoT Band 12 QPSK 15KHz 12@0 CH-Low



NB-IoT Band 12 QPSK 15KHz 12@0 CH- High

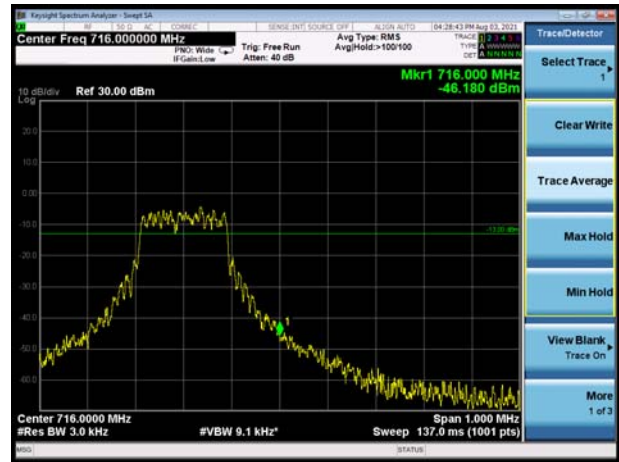

NB-IoT Band 13 BPSK 3.75KHz 1@0 CH-Low

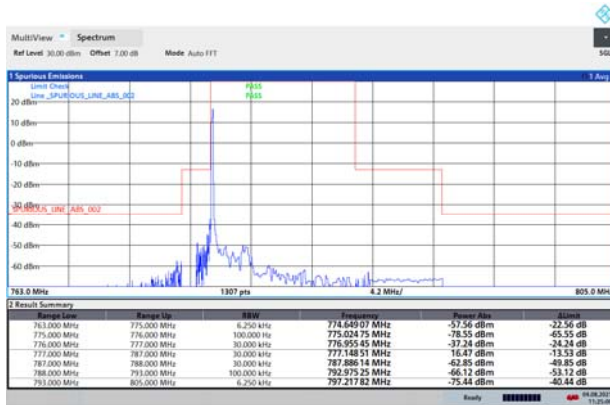

NB-IoT Band 13 BPSK 3.75KHz 1@0 CH- High

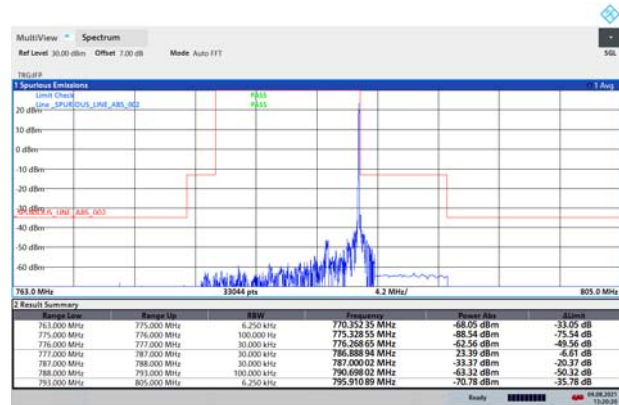

NB-IoT Band 13 QPSK 3.75KHz 1@0 CH-Low

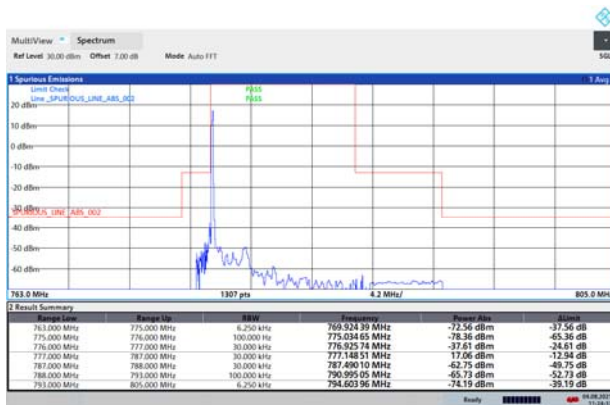

NB-IoT Band 13 QPSK 3.75KHz 1@0 CH- High

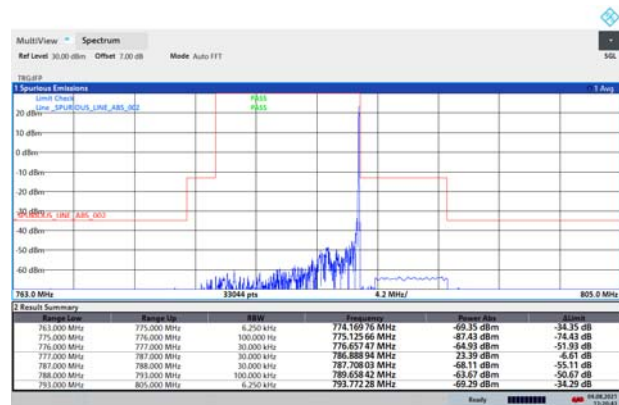

NB-IoT Band 13 BPSK 15KHz 1@0 CH-Low

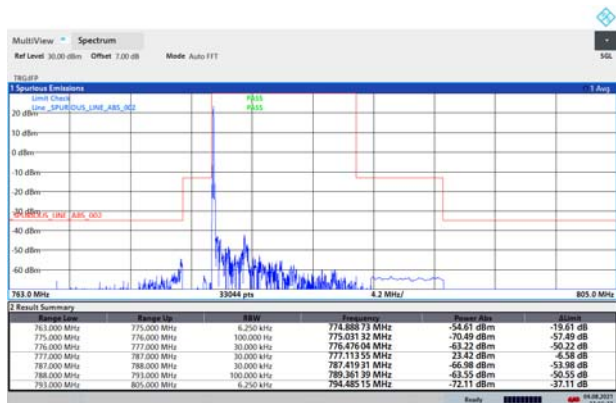

11:55:33 04.09.2021

NB-IoT Band 13 BPSK 15KHz 1@0 CH- High

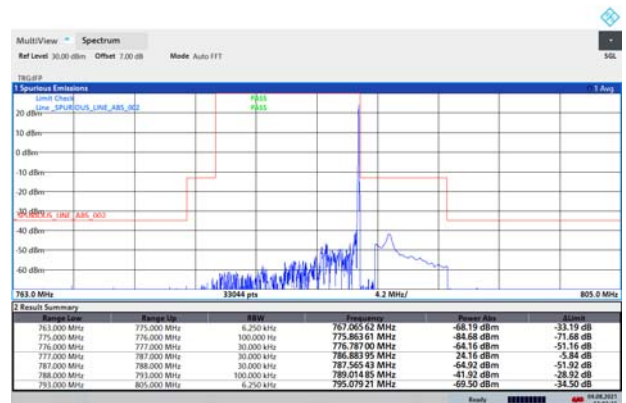

12:02:32 04.09.2021

NB-IoT Band 13 QPSK 15KHz 1@0 CH-Low

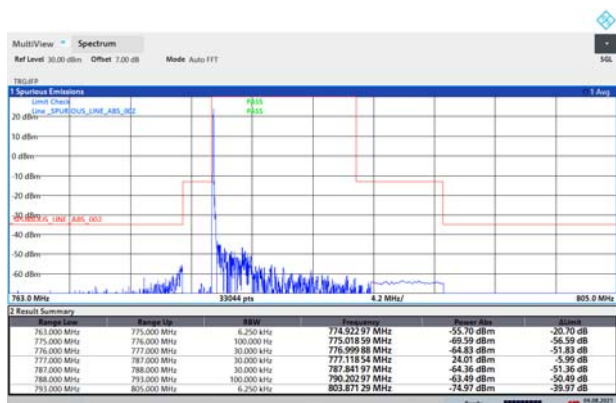

11:55:03 04.09.2021

NB-IoT Band 13 QPSK 15KHz 1@0 CH- High

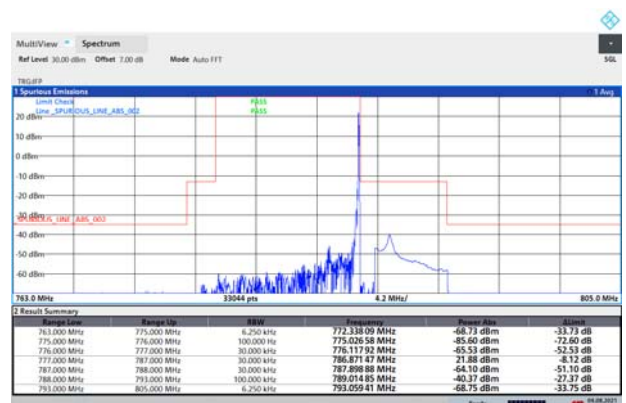

12:02:17 04.09.2021

NB-IoT Band 13 QPSK 15KHz 12@0 CH-Low

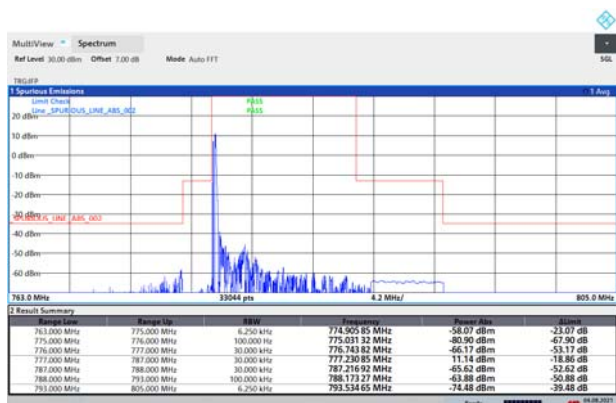

11:54:35 04.09.2021

NB-IoT Band 13 QPSK 15KHz 12@0 CH- High

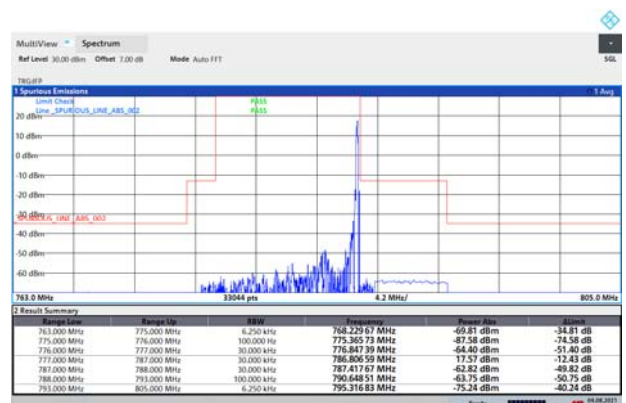

12:01:54 04.09.2021

NB-IoT Band 17 BPSK 3.75KHz 1@0 CH-Low

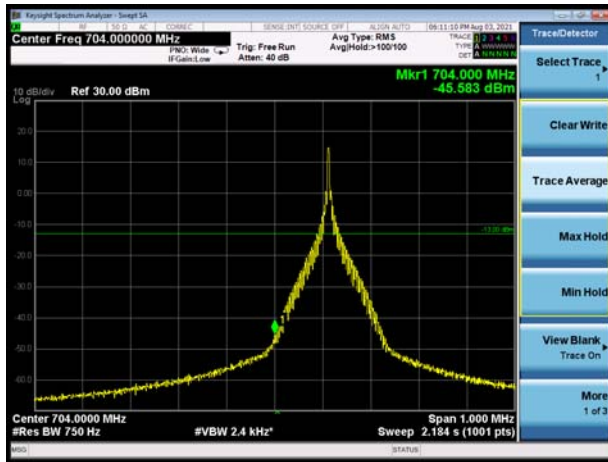

NB-IoT Band 17 BPSK 3.75KHz 1@0 CH- High

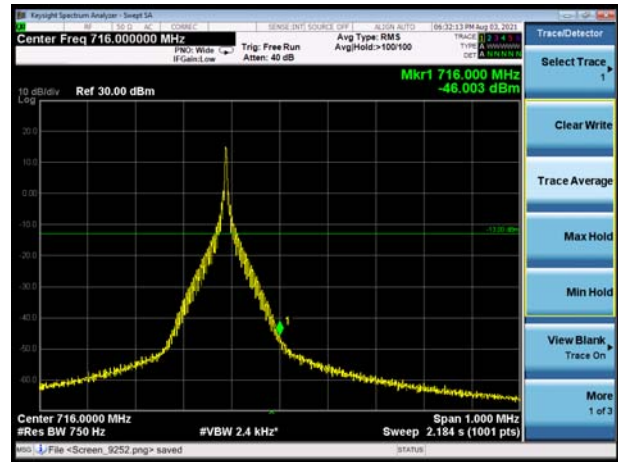

NB-IoT Band 17 QPSK 3.75KHz 1@0 CH-Low

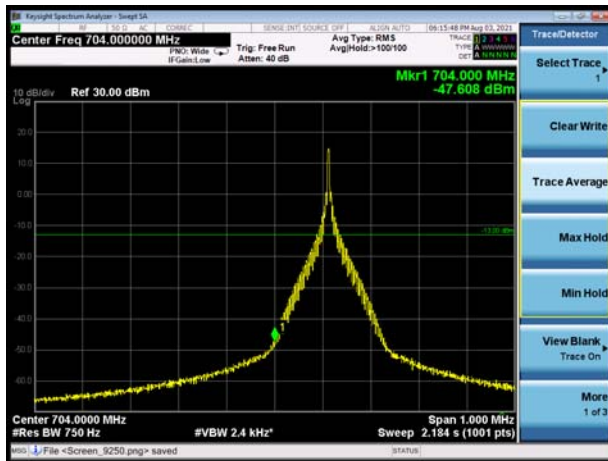

NB-IoT Band 17 QPSK 3.75KHz 1@0 CH- High

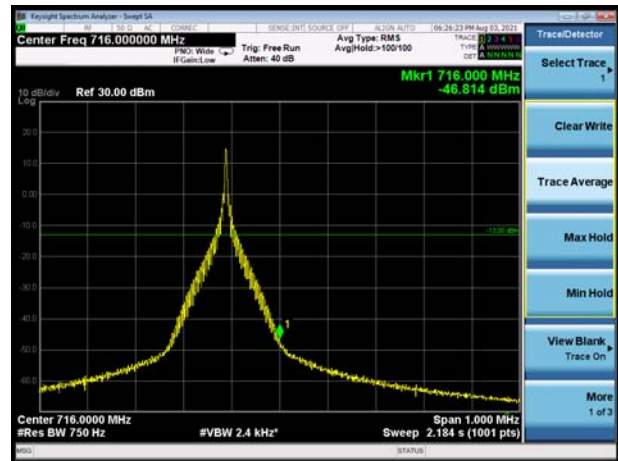

NB-IoT Band 17 BPSK 15KHz 1@0 CH-Low

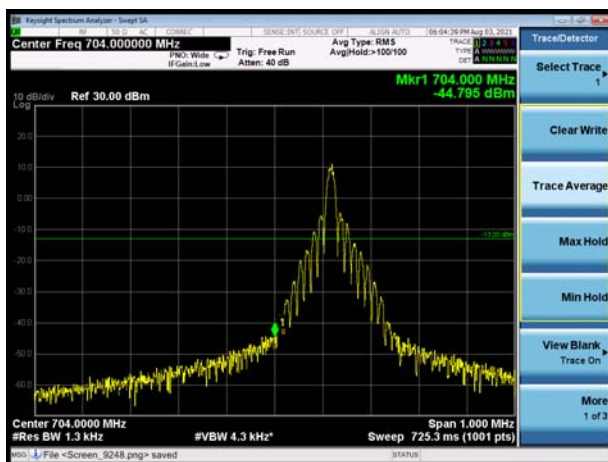

NB-IoT Band 17 BPSK 15KHz 1@0 CH- High

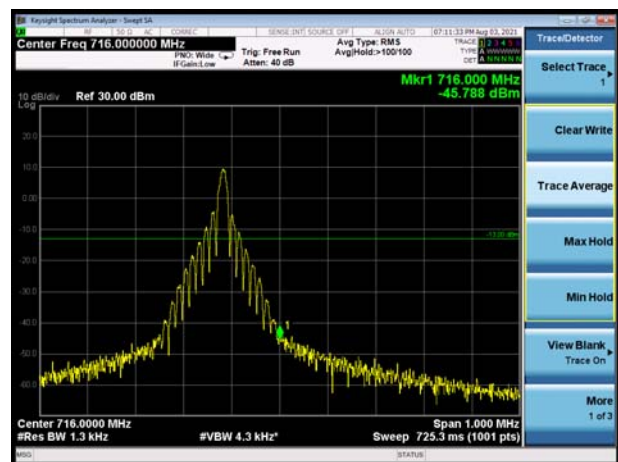

NB-IoT Band 17 QPSK 15KHz 1@0 CH-Low

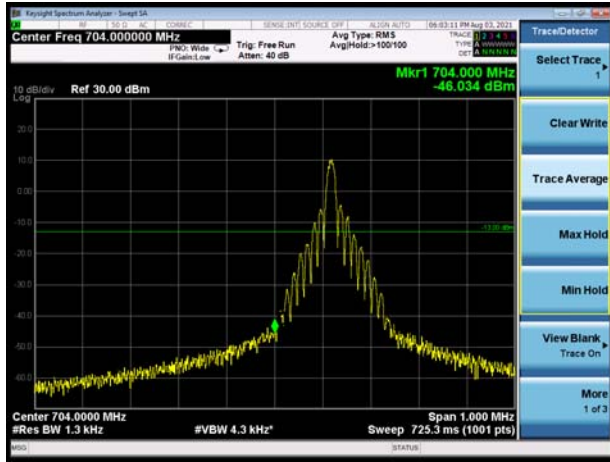

NB-IoT Band 17 QPSK 15KHz 1@0 CH- High

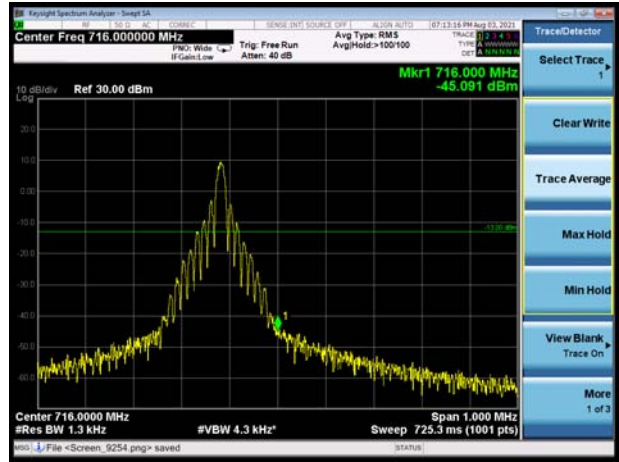

NB-IoT Band 17 QPSK 15KHz 12@0 CH-Low

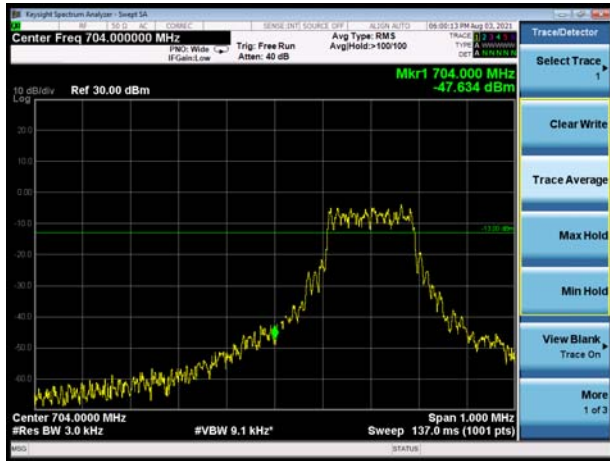

NB-IoT Band 17 QPSK 15KHz 12@0 CH- High



NB-IoT Band 66 BPSK 3.75KHz 1@0 CH-Low

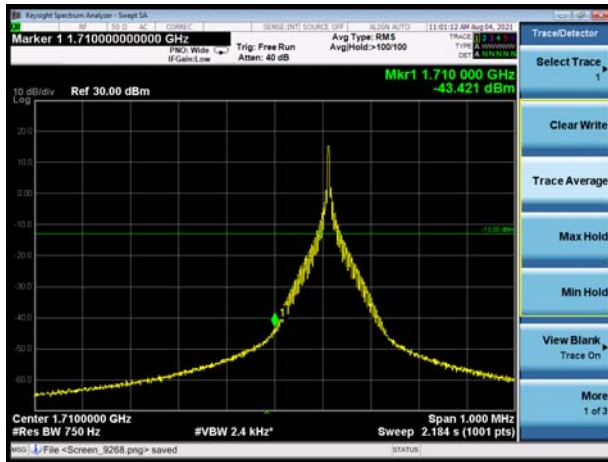

NB-IoT Band 66 BPSK 3.75KHz 1@0 CH- High

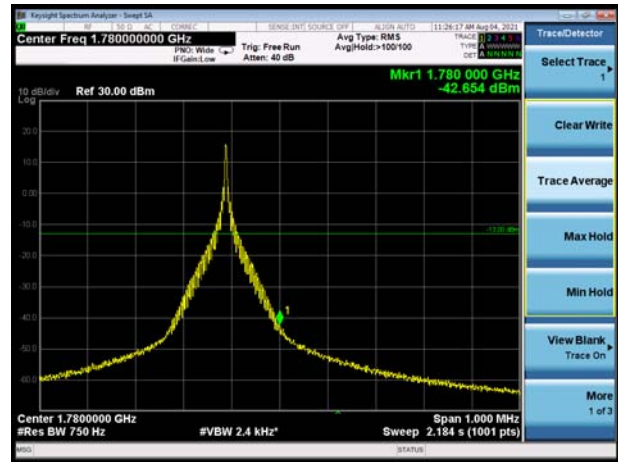

NB-IoT Band 66 QPSK 3.75KHz 1@0 CH-Low

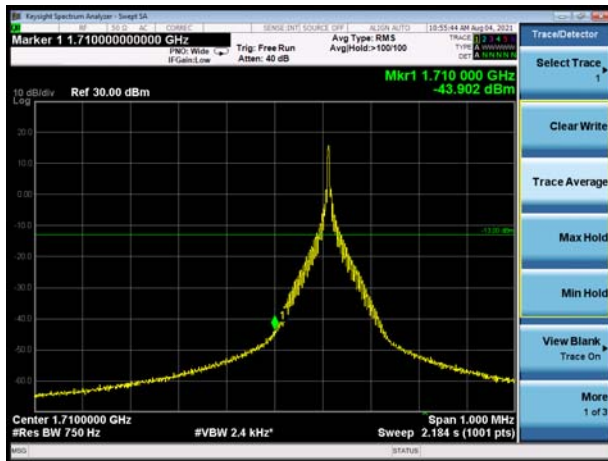

NB-IoT Band 66 QPSK 3.75KHz 1@0 CH- High

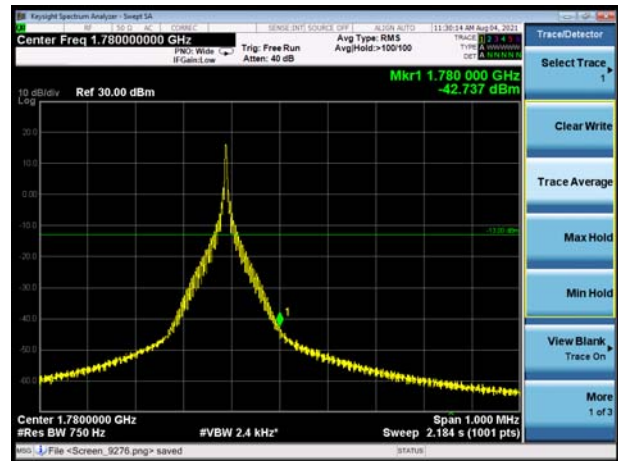

NB-IoT Band 66 BPSK 15KHz 1@0 CH-Low

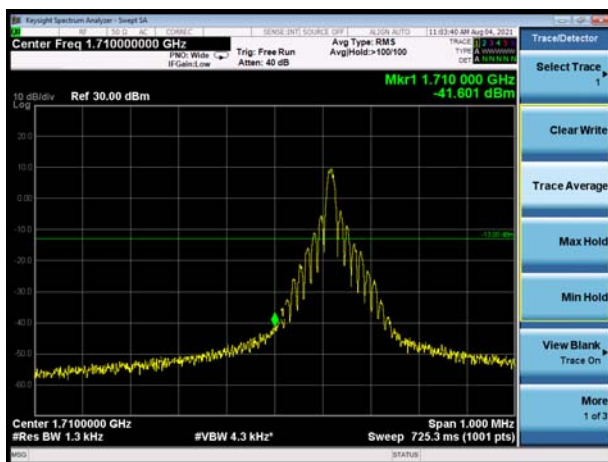

NB-IoT Band 66 BPSK 15KHz 1@0 CH- High

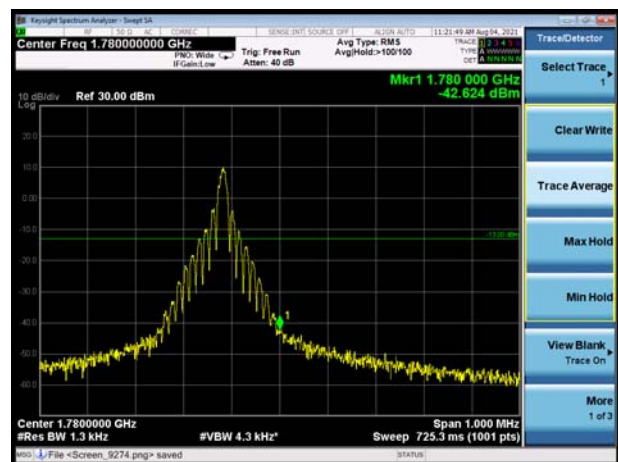

NB-IoT Band 66 QPSK 15KHz 1@0 CH-Low

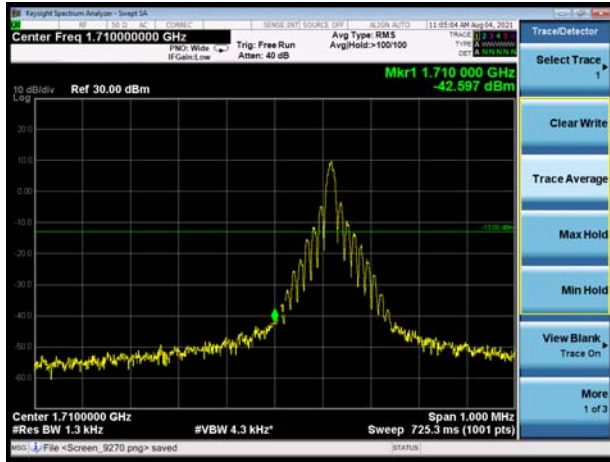

NB-IoT Band 66 QPSK 15KHz 1@0 CH- High

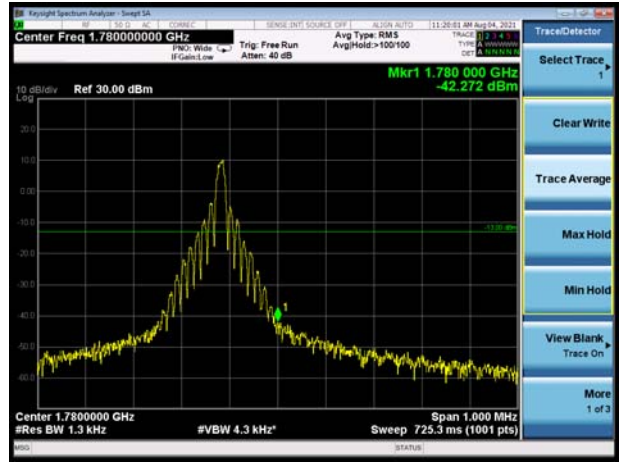

NB-IoT Band 66 QPSK 15KHz 12@0 CH-Low



NB-IoT Band 66 QPSK 15KHz 12@0 CH- High



5.4 Peak-to-Average Power Ratio (PAPR)

Ambient condition

Temperature	Relative humidity	Pressure
23°C ~25°C	45%~50%	101.5kPa

Methods of Measurement

Measure the total peak power and record as PPk. And measure the total average power and record as PAvg. Both the peak and average power levels must be expressed in the same logarithmic units (e.g., dBm). Determine the PAPR from:

$$\text{PAPR (dB)} = \text{PPk (dBm)} - \text{PAvg (dBm)}.$$

Test Setup

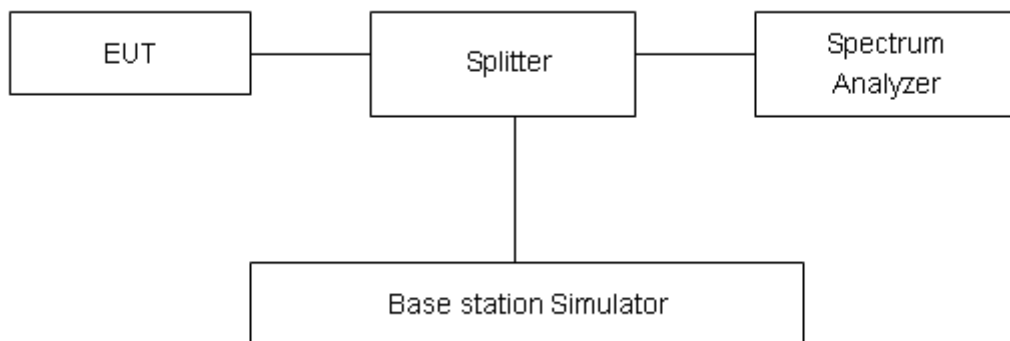

Limits

Rule Part 27.50(d)(5) Equipment employed must be authorized in accordance with the provisions of 24.51. Power measurements for transmissions by stations authorized under this section may be made either in accordance with a Commission-approved average power technique or in compliance with paragraph (d)(6) of this section. In measuring transmissions in this band using an average power technique, the peak-to-average ratio (PAR) of the transmission may not exceed 13 dB.

Measurement Uncertainty

The assessed measurement uncertainty to ensure 95% confidence level for the normal distribution is with the coverage factor $k = 2$, $U = 0.4$ dB.

Test Results

Mode	Modulation	Sub-carrier spacing (KHz)	Channel/ Frequency(MHz)	Peak-to-Average Power Ratio (PAPR)		
				Peak(dBm)	Avg(dBm)	PAPR(dB)
Band 4 Standalone	BPSK	3.75	20175/1732.5	25.24	22.43	2.81
	QPSK	3.75	20175/1732.5	25.36	22.49	2.87
	BPSK	15	20175/1732.5	25.37	19.23	6.14
	QPSK	15	20175/1732.5	25.42	19.03	6.39
Mode	Modulation	Sub-carrier spacing (KHz)	Channel/ Frequency(MHz)	Peak-to-Average Power Ratio (PAPR)		
				Peak(dBm)	Avg(dBm)	PAPR(dB)
Band 12 Standalone	BPSK	3.75	23095/707.5	23.92	21.29	2.63
	QPSK	3.75	23095/707.5	24.13	21.27	2.86
	BPSK	15	23095/707.5	24.96	19.10	5.86
	QPSK	15	23095/707.5	25.03	19.04	5.99
Mode	Modulation	Sub-carrier spacing (KHz)	Channel/ Frequency(MHz)	Peak-to-Average Power Ratio (PAPR)		
				Peak(dBm)	Avg(dBm)	PAPR(dB)
Band 13 Standalone	BPSK	3.75	23230/782	23.92	21.20	2.72
	QPSK	3.75	23230/782	24.07	21.20	2.87
	BPSK	15	23230/782	24.72	18.57	6.15
	QPSK	15	23230/782	24.99	22.12	2.87
Mode	Modulation	Sub-carrier spacing (KHz)	Channel/ Frequency(MHz)	Peak-to-Average Power Ratio (PAPR)		
				Peak(dBm)	Avg(dBm)	PAPR(dB)
Band17 Standalone	BPSK	3.75	23790/710	23.84	21.22	2.62
	QPSK	3.75	23790/710	24.11	21.26	2.85
	BPSK	15	23790/710	24.59	18.60	5.99
	QPSK	15	23790/710	24.55	18.67	5.88
Mode	Modulation	Sub-carrier spacing (KHz)	Channel/ Frequency(MHz)	Peak-to-Average Power Ratio (PAPR)		
				Peak(dBm)	Avg(dBm)	PAPR(dB)
Band 66 Standalone	BPSK	3.75	132322/1745	25.19	22.49	2.70
	QPSK	3.75	132322/1745	25.48	22.62	2.86
	BPSK	15	132322/1745	25.85	19.55	6.30
	QPSK	15	132322/1745	25.77	19.52	6.25

5.5 Frequency Stability

Ambient condition

Temperature	Relative humidity	Pressure
23°C ~25°C	45%~50%	101.5kPa

Method of Measurement

Frequency Stability (Temperature Variation)

The temperature inside the climate chamber is varied from -35°C to + 75°C in 10°C step size.

(1)With all power removed, the temperature was decreased to -10°C and permitted to stabilize for three hours.

(2)Measure the carrier frequency with the test equipment in a “call mode”. These measurements should be made within 1 minute of powering up the mobile station, to prevent significant self warming.

(3) Repeat the above measurements at 10°C increments from -35°C to + 75°C. Allow at least 1.5 hours at each temperature, un-powered, before making measurements.

Frequency Stability (Voltage Variation)

The frequency stability shall be measured with variation of primary supply voltage as follows:

Primary Supply Voltage: The primary supply voltage is varied from 85% to 115% of the nominal value for non hand-carried battery and AC powered equipment. For hand-carried, battery-powered equipment, primary supply voltage is reduced to the battery operating end point which shall be specified by the manufacturer.

This transceiver is specified to operate with an input voltage of between 2.2V and 4.35 V, with a nominal voltage of 3.3V.

Test setup

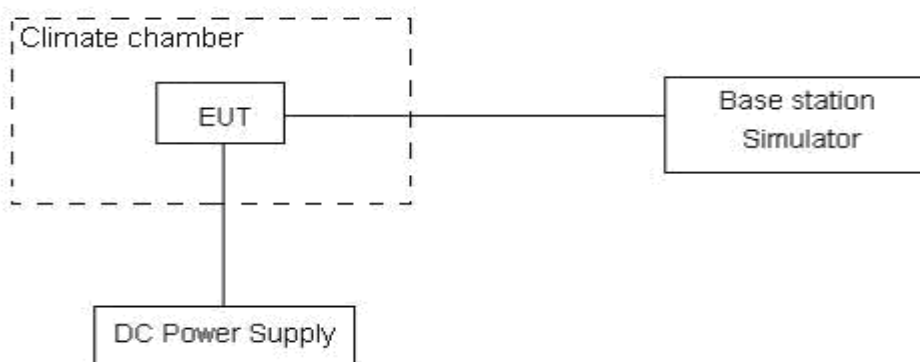

Limits

The frequency stability shall be sufficient to ensure that the fundamental emissions stay within the authorized bands of operation.

Measurement Uncertainty

The assessed measurement uncertainty to ensure 99.75% confidence level for the normal

distribution is with the coverage factor $k = 3, U = 0.01\text{ppm}$.

Test Result

NB-IoT Band 4						
Condition		Freq.Error (Hz)	Freq.Error (Hz)	Frequency Stability(ppm)	Frequency Stability(ppm)	Verdict
Sub-carrier spacing (KHz)	3.75					
Temperature	Voltage	BPSK	QPSK	BPSK	QPSK	
Normal (25°C)	Normal	14.45	14.75	0.00834	0.00851	
Extreme (75°C)		11.92	5.77	0.00688	0.00333	PASS
Extreme (70°C)		9.34	2.92	0.00539	0.00168	PASS
Extreme (60°C)		13.35	11.79	0.00771	0.00680	PASS
Extreme (50°C)		1.92	5.58	0.00111	0.00322	PASS
Extreme (40°C)		15.83	12.77	0.00914	0.00737	PASS
Extreme (30°C)		13.99	15.94	0.00807	0.00920	PASS
Extreme (20°C)		6.51	9.94	0.00376	0.00574	PASS
Extreme (10°C)		8.05	6.17	0.00464	0.00356	PASS
Extreme (0°C)		15.14	5.03	0.00874	0.00290	PASS
Extreme (-10°C)		2.57	8.63	0.00149	0.00498	PASS
Extreme (-20°C)		6.81	1.65	0.00393	0.00095	PASS
Extreme (-30°C)		13.13	16.68	0.00758	0.00963	PASS
Extreme (-35°C)		11.52	6.08	0.00665	0.00351	PASS
25°C	LV	3.08	15.77	0.00178	0.00910	PASS
	HV	7.02	13.52	0.00405	0.00780	PASS
Condition		Freq.Error (Hz)	Freq.Error (Hz)	Frequency Stability(ppm)	Frequency Stability(ppm)	Verdict
Sub-carrier spacing (KHz)	15					
Temperature	Voltage	BPSK	QPSK	BPSK	QPSK	
Normal (25°C)	Normal	5.59	17.43	0.00322	0.01006	
Extreme (75°C)		17.08	14.21	0.00986	0.00820	PASS
Extreme (70°C)		17.14	11.80	0.00989	0.00681	PASS
Extreme (60°C)		2.22	4.35	0.00128	0.00251	PASS
Extreme (50°C)		11.59	10.31	0.00669	0.00595	PASS
Extreme (40°C)		7.93	17.96	0.00458	0.01037	PASS
Extreme (30°C)		6.15	8.69	0.00355	0.00502	PASS
Extreme (20°C)		6.36	15.36	0.00367	0.00887	PASS
Extreme (10°C)		1.52	13.40	0.00088	0.00773	PASS
Extreme (0°C)		11.05	15.70	0.00638	0.00906	PASS
Extreme (-10°C)		3.49	1.69	0.00201	0.00098	PASS
Extreme (-20°C)		15.98	12.90	0.00923	0.00745	PASS
Extreme (-30°C)		2.17	10.07	0.00126	0.00581	PASS

Extreme (-35°C)		14.63	7.84	0.00844	0.00453	PASS
25°C	LV	6.24	9.98	0.00360	0.00576	PASS
	HV	8.20	6.99	0.00473	0.00403	PASS

NB-IoT Band 12						
Condition		Freq.Error (Hz)	Freq.Error (Hz)	Frequency Stability(ppm)	Frequency Stability(ppm)	Verdict
Sub-carrier spacing (KHz)	3.75					
Temperature	Voltage	BPSK	QPSK	BPSK	QPSK	
Normal (25°C)	Normal	1.61	10.61	0.00228	0.01499	PASS
Extreme (75°C)		16.84	10.54	0.02381	0.01489	PASS
Extreme (70°C)		2.24	10.46	0.00316	0.01478	PASS
Extreme (60°C)		13.18	2.28	0.01863	0.00322	PASS
Extreme (50°C)		16.70	11.92	0.02360	0.01684	PASS
Extreme (40°C)		11.17	3.70	0.01579	0.00523	PASS
Extreme (30°C)		4.10	2.91	0.00579	0.00411	PASS
Extreme (20°C)		8.36	1.83	0.01181	0.00258	PASS
Extreme (10°C)		5.00	12.59	0.00707	0.01780	PASS
Extreme (0°C)		6.74	16.00	0.00953	0.02261	PASS
Extreme (-10°C)		10.56	4.76	0.01493	0.00673	PASS
Extreme (-20°C)		5.16	10.84	0.00730	0.01533	PASS
Extreme (-30°C)		12.05	3.81	0.01704	0.00538	PASS
Extreme (-35°C)		13.16	5.75	0.01860	0.00813	PASS
25°C	LV	16.12	5.94	0.02279	0.00839	PASS
	HV	11.91	14.29	0.01683	0.02020	PASS
Condition		Freq.Error (Hz)	Freq.Error (Hz)	Frequency Stability(ppm)	Frequency Stability(ppm)	Verdict
Sub-carrier spacing (KHz)	15					
Temperature	Voltage	BPSK	QPSK	BPSK	QPSK	
Normal (25°C)	Normal	8.97	7.91	0.01268	0.01118	PASS
Extreme (75°C)		5.87	12.67	0.00829	0.01791	PASS
Extreme (70°C)		14.53	6.63	0.02054	0.00937	PASS
Extreme (60°C)		10.81	16.56	0.01528	0.02341	PASS
Extreme (50°C)		16.23	17.82	0.02294	0.02519	PASS
Extreme (40°C)		14.72	16.22	0.02081	0.02293	PASS
Extreme (30°C)		8.19	17.31	0.01157	0.02447	PASS
Extreme (20°C)		9.93	16.55	0.01404	0.02339	PASS
Extreme (10°C)		10.59	3.39	0.01497	0.00480	PASS
Extreme (0°C)		16.62	14.05	0.02350	0.01986	PASS
Extreme (-10°C)		16.25	16.34	0.02296	0.02310	PASS

Extreme (-20°C)		14.97	13.09	0.02115	0.01850	PASS
Extreme (-30°C)		11.50	1.60	0.01626	0.00225	PASS
Extreme (-35°C)		6.37	4.01	0.00900	0.00566	PASS
25°C	LV	3.14	9.46	0.00444	0.01336	PASS
	HV	5.80	9.68	0.00820	0.01368	PASS

NB-IoT Band 13						
Condition		Freq.Error (Hz)	Freq.Error (Hz)	Frequency Stability(ppm)	Frequency Stability(ppm)	Verdict
Sub-carrier spacing (KHz)	3.75					
Temperature	Voltage	BPSK	QPSK	BPSK	QPSK	
Normal (25°C)	Normal	3.78	11.48	0.00483	0.01468	PASS
Extreme (75°C)		10.24	16.51	0.01309	0.02111	PASS
Extreme (70°C)		12.86	4.48	0.01645	0.00573	PASS
Extreme (60°C)		16.11	14.42	0.02060	0.01844	PASS
Extreme (50°C)		7.40	7.52	0.00947	0.00961	PASS
Extreme (40°C)		10.53	14.84	0.01347	0.01897	PASS
Extreme (30°C)		5.34	7.34	0.00683	0.00939	PASS
Extreme (20°C)		8.68	17.00	0.01110	0.02173	PASS
Extreme (10°C)		3.97	4.72	0.00508	0.00603	PASS
Extreme (0°C)		8.49	7.68	0.01086	0.00983	PASS
Extreme (-10°C)		9.44	13.93	0.01208	0.01781	PASS
Extreme (-20°C)		17.03	13.28	0.02177	0.01699	PASS
Extreme (-30°C)		10.08	16.01	0.01289	0.02048	PASS
Extreme (-35°C)		13.93	7.54	0.01782	0.00964	PASS
25°C	LV	6.75	15.29	0.00863	0.01955	PASS
	HV	1.26	9.33	0.00161	0.01193	PASS
Condition		Freq.Error (Hz)	Freq.Error (Hz)	Frequency Stability(ppm)	Frequency Stability(ppm)	Verdict
Sub-carrier spacing (KHz)	15					
Temperature	Voltage	BPSK	QPSK	BPSK	QPSK	
Normal (25°C)	Normal	9.63	12.32	0.01232	0.01575	PASS
Extreme (75°C)		6.73	15.88	0.00860	0.02030	PASS
Extreme (70°C)		8.60	9.96	0.01100	0.01274	PASS
Extreme (60°C)		2.04	6.58	0.00261	0.00841	PASS
Extreme (50°C)		6.51	1.30	0.00833	0.00166	PASS
Extreme (40°C)		15.78	11.94	0.02018	0.01527	PASS
Extreme (30°C)		7.06	7.41	0.00903	0.00947	PASS
Extreme (20°C)		14.67	1.00	0.01877	0.00128	PASS
Extreme (10°C)		14.06	3.09	0.01797	0.00395	PASS

Extreme (0°C)		9.93	16.59	0.01270	0.02121	PASS
Extreme (-10°C)		14.64	8.27	0.01872	0.01058	PASS
Extreme (-20°C)		17.10	16.39	0.02187	0.02096	PASS
Extreme (-30°C)		3.78	6.76	0.00484	0.00864	PASS
Extreme (-35°C)		8.44	5.92	0.01080	0.00757	PASS
25°C	LV	15.21	15.16	0.01945	0.01938	PASS
	HV	9.19	5.48	0.01175	0.00701	PASS

NB-IoT Band 17						
Condition		Freq.Error (Hz)	Freq.Error (Hz)	Frequency Stability(ppm)	Frequency Stability(ppm)	Verdict
Sub-carrier spacing (KHz)	3.75					
Temperature	Voltage	BPSK	QPSK	BPSK	QPSK	
Normal (25°C)	Normal	13.87	10.73	0.01953	0.01512	PASS
Extreme (75°C)		11.58	10.09	0.01631	0.01422	PASS
Extreme (70°C)		10.84	3.93	0.01526	0.00554	PASS
Extreme (60°C)		9.70	7.07	0.01366	0.00996	PASS
Extreme (50°C)		5.94	4.10	0.00837	0.00578	PASS
Extreme (40°C)		9.20	4.11	0.01295	0.00579	PASS
Extreme (30°C)		7.12	14.79	0.01003	0.02083	PASS
Extreme (20°C)		13.54	15.03	0.01908	0.02116	PASS
Extreme (10°C)		1.22	16.75	0.00172	0.02359	PASS
Extreme (0°C)		6.36	5.45	0.00896	0.00768	PASS
Extreme (-10°C)		6.45	3.75	0.00909	0.00529	PASS
Extreme (-20°C)		9.56	6.29	0.01346	0.00887	PASS
Extreme (-30°C)		12.41	2.81	0.01749	0.00396	PASS
Extreme (-35°C)		2.23	8.07	0.00314	0.01136	PASS
25°C	LV	9.40	9.59	0.01324	0.01351	PASS
	HV	3.72	13.74	0.00524	0.01935	PASS
Condition		Freq.Error (Hz)	Freq.Error (Hz)	Frequency Stability(ppm)	Frequency Stability(ppm)	Verdict
Sub-carrier spacing (KHz)	15					
Temperature	Voltage	BPSK	QPSK	BPSK	QPSK	
Normal (25°C)	Normal	11.63	13.79	0.01638	0.01942	PASS
Extreme (75°C)		11.42	2.44	0.01609	0.00343	PASS
Extreme (70°C)		14.98	13.18	0.02109	0.01856	PASS
Extreme (60°C)		3.51	6.51	0.00495	0.00917	PASS
Extreme (50°C)		13.17	15.69	0.01855	0.02210	PASS
Extreme (40°C)		12.93	6.22	0.01821	0.00875	PASS
Extreme (30°C)		5.68	4.99	0.00800	0.00702	PASS

Extreme (20°C)		4.65	12.80	0.00654	0.01803	PASS
Extreme (10°C)		4.47	7.04	0.00629	0.00992	PASS
Extreme (0°C)		2.73	15.47	0.00384	0.02179	PASS
Extreme (-10°C)		2.21	16.70	0.00311	0.02352	PASS
Extreme (-20°C)		16.90	11.34	0.02381	0.01597	PASS
Extreme (-30°C)		15.40	8.79	0.02169	0.01238	PASS
Extreme (-35°C)		10.06	5.95	0.01417	0.00838	PASS
25°C	LV	4.20	17.38	0.00591	0.02448	PASS
	HV	10.43	14.41	0.01469	0.02030	PASS

NB-IoT Band 66						
Condition		Freq.Error (Hz)	Freq.Error (Hz)	Frequency Stability(ppm)		Verdict
Sub-carrier spacing (KHz)	3.75			BPSK	QPSK	
Temperature	Voltage	BPSK	QPSK	BPSK	QPSK	
Normal (25°C)	Normal	1.54	17.60	0.00089	0.01009	PASS
Extreme (75°C)		17.43	9.56	0.00999	0.00548	PASS
Extreme (70°C)		12.01	13.49	0.00688	0.00773	PASS
Extreme (60°C)		4.02	1.65	0.00230	0.00094	PASS
Extreme (50°C)		2.35	14.97	0.00135	0.00858	PASS
Extreme (40°C)		6.34	10.80	0.00364	0.00619	PASS
Extreme (30°C)		5.90	5.28	0.00338	0.00302	PASS
Extreme (20°C)		10.92	11.68	0.00626	0.00670	PASS
Extreme (10°C)		10.83	4.46	0.00621	0.00256	PASS
Extreme (0°C)		5.94	17.23	0.00340	0.00987	PASS
Extreme (-10°C)		13.87	7.23	0.00795	0.00414	PASS
Extreme (-20°C)		16.68	1.79	0.00956	0.00103	PASS
Extreme (-30°C)		14.74	17.13	0.00844	0.00982	PASS
Extreme (-35°C)	1.81	14.12	0.00104	0.00809	PASS	
25°C	LV	14.24	6.44	0.00816	0.00369	PASS
	HV	17.37	15.04	0.00995	0.00862	PASS
Condition		Freq.Error (Hz)	Freq.Error (Hz)	Frequency Stability(ppm)		Verdict
Sub-carrier spacing (KHz)	15			BPSK	QPSK	
Temperature	Voltage	BPSK	QPSK	BPSK	QPSK	
Normal (25°C)	Normal	1.17	13.85	0.00067	0.00794	PASS
Extreme (75°C)		13.30	3.92	0.00762	0.00224	PASS
Extreme (70°C)		5.87	4.52	0.00336	0.00259	PASS
Extreme (60°C)		2.29	5.45	0.00131	0.00312	PASS
Extreme (50°C)		3.08	3.42	0.00176	0.00196	PASS

Extreme (40°C)		10.91	9.37	0.00625	0.00537	PASS
Extreme (30°C)		9.76	14.38	0.00559	0.00824	PASS
Extreme (20°C)		16.25	6.87	0.00931	0.00394	PASS
Extreme (10°C)		9.92	10.49	0.00569	0.00601	PASS
Extreme (0°C)		7.13	12.98	0.00409	0.00744	PASS
Extreme (-10°C)		15.55	17.11	0.00891	0.00980	PASS
Extreme (-20°C)		14.02	8.96	0.00803	0.00514	PASS
Extreme (-30°C)		4.57	13.21	0.00262	0.00757	PASS
Extreme (-35°C)		4.49	6.11	0.00258	0.00350	PASS
25°C	LV	4.22	1.31	0.00242	0.00075	PASS
	HV	7.15	12.79	0.00410	0.00733	PASS

5.6 Spurious Emissions at Antenna Terminals

Ambient condition

Temperature	Relative humidity	Pressure
23°C ~25°C	45%~50%	101.5kPa

Method of Measurement

The EUT was connected to Spectrum Analyzer and Base Station Simulator via power Splitter. The measurement is carried out using a spectrum analyzer. The spectrum analyzer scans from 9kHz to the 10th harmonic of the carrier. The peak detector is used.

RBW is set to 1 kHz (0.009MHz~ 0.15 MHz),

RBW is set to 10 kHz (0.15 MHz~ 30 MHz)

RBW is set to 100 kHz (30MHz~1000 MHz)

RBW is set to 1000 kHz (above 1000MHz)

Sweep is set to ATUO.

Of those disturbances below (limit – 20 dB), the mark is not required for the EUT.

The modulation mode and RB allocation refer to section 5.1, using the maximum output power configuration.

Test setup

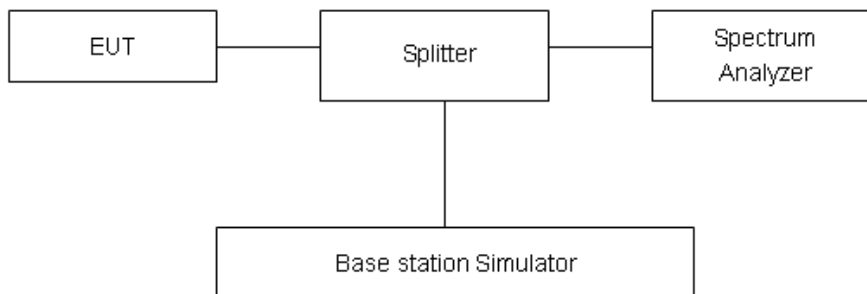

Limits

Rule Part 27.53(h) specifies that “for operations in the 1695-1710 MHz, 1710-1755 MHz, 1755-1780 MHz, 1915-1920 MHz, 1995-2000 MHz, 2000-2020 MHz, 2110-2155 MHz, 2155-2180 MHz, and 2180-2200 bands, the power of any emission outside a licensee's frequency block shall be attenuated below the transmitter power (P) in watts by at least $43 + 10 \log_{10}(P)$ dB..”

Rule Part 27.53 (g) For operations in the 600 MHz band and the 698-746 MHz band, the power of any emission outside a licensee's frequency band(s) of operation shall be attenuated below the transmitter power (P) within the licensed band(s) of operation, measured in watts, by at least $43 + 10 \log(P)$ dB. Compliance with this provision is based on the use of measurement instrumentation employing a resolution bandwidth of 100 kilohertz or greater. However, in the 100 kilohertz bands immediately outside and adjacent to a licensee's frequency block, a resolution bandwidth of at least 30 kHz may be employed.

Rule Part 27.53(f) For operations in the 746-758 MHz, 775-788 MHz, and 805-806 MHz bands, emissions in the band 1559-1610 MHz shall be limited to -70 dBW/MHz equivalent isotropically radiated power (EIRP) for wideband signals, and -80 dBW EIRP for discrete emissions of less than 700 Hz bandwidth. For the purpose of equipment authorization, a transmitter shall be tested with an antenna that is representative of the type that will be used with the equipment in normal operation.

Part 27.53 (c) For operations in the 746-758 MHz band and the 776-788 MHz band, the power of any emission outside the licensee's frequency band(s) of operation shall be attenuated below the transmitter power (P) within the licensed band(s) of operation, measured in watts, in accordance with the following:

- (1) On any frequency outside the 746-758 MHz band, the power of any emission shall be attenuated outside the band below the transmitter power (P) by at least $43 + 10 \log (P)$ dB;
- (2) On any frequency outside the 776-788 MHz band, the power of any emission shall be attenuated outside the band below the transmitter power (P) by at least $43 + 10 \log (P)$ dB;
- (3) On all frequencies between 763-775 MHz and 793-805 MHz, by a factor not less than $76 + 10 \log (P)$ dB in a 6.25 kHz band segment, for base and fixed stations;
- (4) On all frequencies between 763-775 MHz and 793-805 MHz, by a factor not less than $65 + 10 \log (P)$ dB in a 6.25 kHz band segment, for mobile and portable stations;
- (5) Compliance with the provisions of paragraphs (c)(1) and (c)(2) of this section is based on the use of measurement instrumentation employing a resolution bandwidth of 100 kHz or greater. However, in the 100 kHz bands immediately outside and adjacent to the frequency block, a resolution bandwidth of at least 30 kHz may be employed;

Part 27.53(h)/(g) Limit		-13 dBm
Part 27.53(f) Limit	Limit out of the band 1559-1610 MHz	-13 dBm
	Limit in the band 1559-1610 MHz	-40 dBm

Measurement Uncertainty

The assessed measurement uncertainty to ensure 99.75% confidence level for the normal distribution is with the coverage factor $k = 1.96$.

Frequency	Uncertainty
9kHz-1GHz	0.684 dB
1GHz-27GHz	1.407 dB

Test Result

Sweep the whole frequency band through the range from 9kHz to the 10th harmonic of the carrier, the emissions more than 20 dB below the limit are not reported. The signal beyond the limit is carrier.

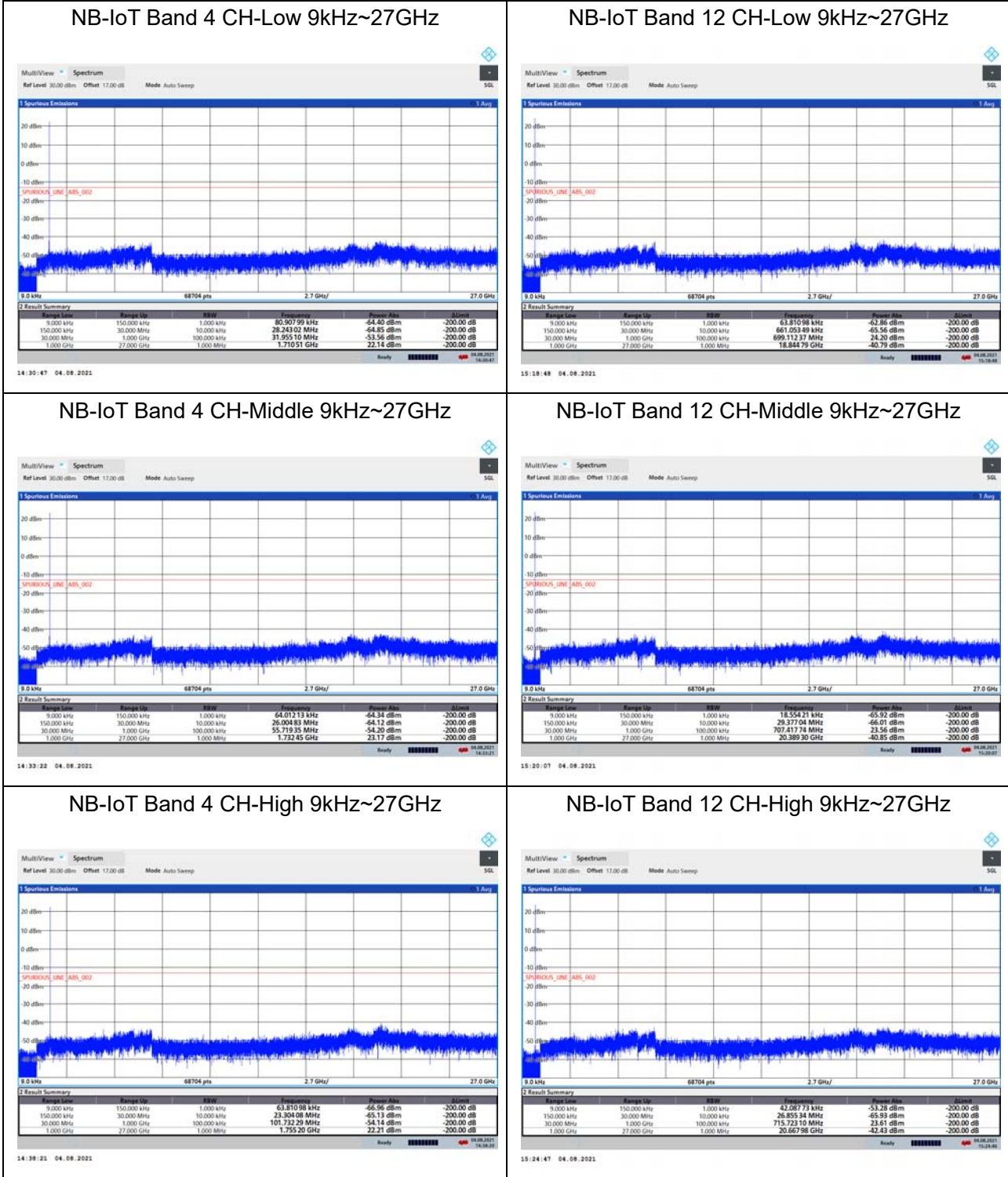

NB-IoT Band 13 CH-Low 9kHz~12.75GHz

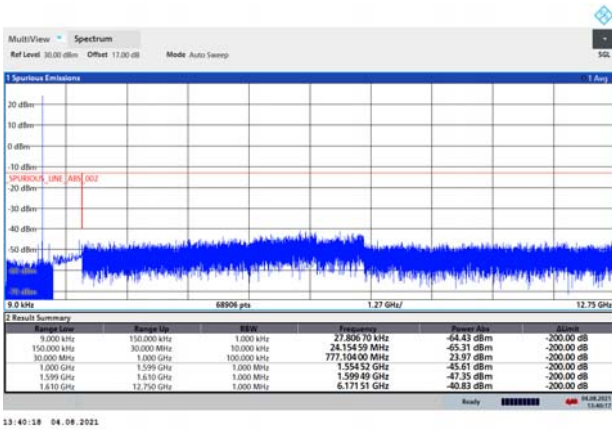

NB-IoT Band 17 CH-Low 9kHz~27GHz

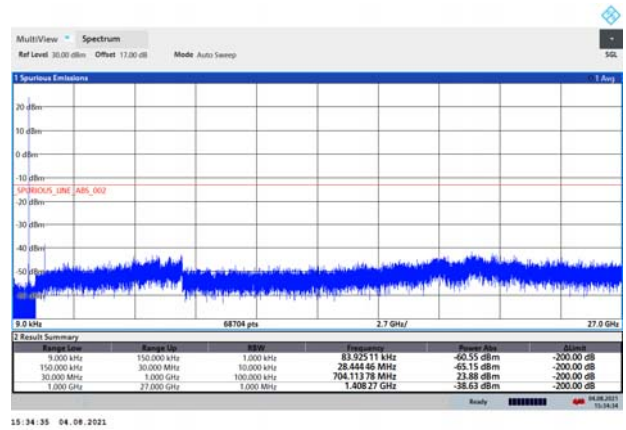

NB-IoT Band 13 CH-Middle 9kHz~12.75GHz

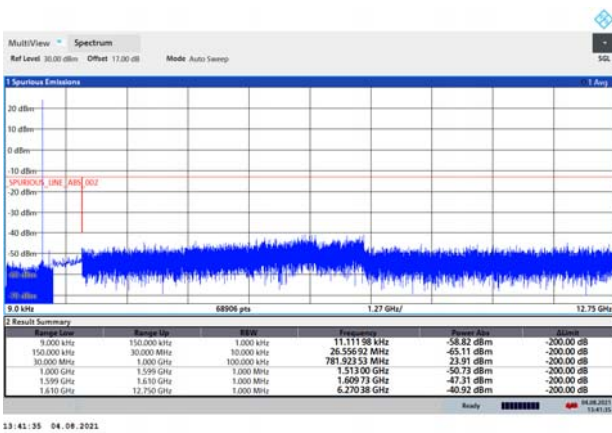

NB-IoT Band 17 CH-Middle 9kHz~27GHz

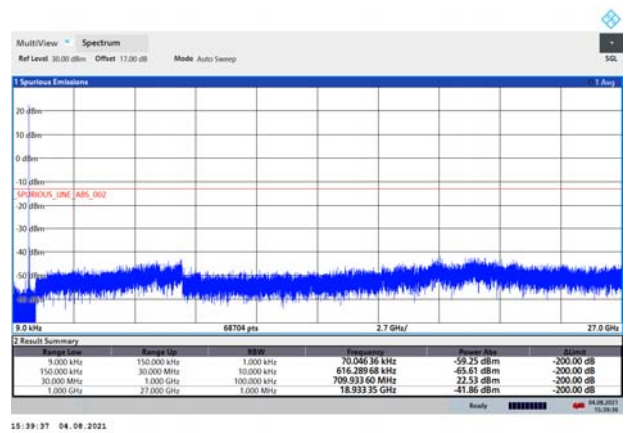

NB-IoT Band 13 CH-High 9kHz~12.75GHz

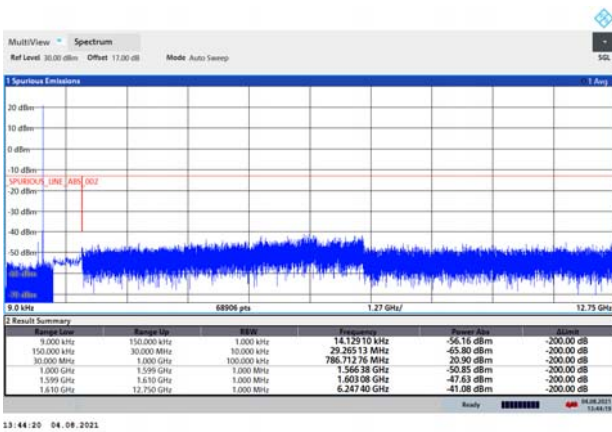

NB-IoT Band 17 CH-High 9kHz~27GHz

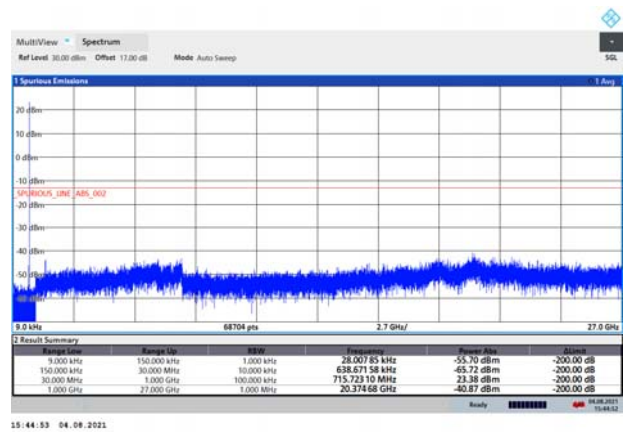

NB-IoT Band 66 CH-Low 9kHz~27GHz

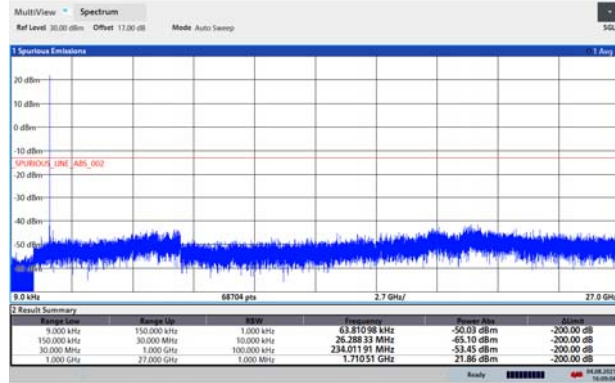

14:09:04 04.08.2021

NB-IoT Band 66 CH-Middle 9kHz~27GHz

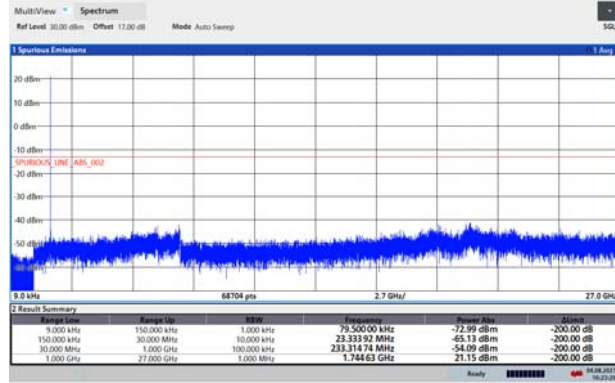

14:23:20 04.08.2021

NB-IoT Band 66 CH-High 9kHz~27GHz

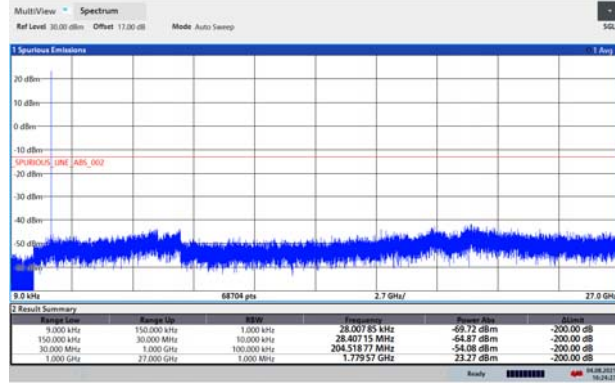

14:24:27 04.08.2021

5.7 Radiates Spurious Emission

Ambient condition

Temperature	Relative humidity	Pressure
23°C ~25°C	45%~50%	101.5kPa

Method of Measurement

- The testing follows FCC KDB 971168 D01 v03r01 Section 5.8 and ANSI C63.26 (2015).
- Below 1GHz: The EUT is placed on a turntable 0.8 meters above the ground in the chamber, 3 meter away from the antenna. The maximal emission value is acquired by adjusting the antenna height, polarisation and turntable azimuth. Normally, the height range of antenna is 1 m to 4 m, the azimuth range of turntable is 0° to 360°, and the receive antenna has two polarizations Vertical (V) and Horizontal (H). Above 1GHz: (Note: the FCC's permission to use 1.5m as an alternative per TCBC Conf call of Dec. 2, 2014.) The EUT is placed on a turntable 1.5 meters above the ground in the chamber, 3 meter away from the antenna. The maximal emission value is acquired by adjusting the antenna height, polarisation and turntable azimuth. Normally, the height range of antenna is 1 m to 4 m, the azimuth range of turntable is 0° to 360°, and the receive antenna has two polarizations Vertical (V) and Horizontal (H).
- A loop antenna, A log-periodic antenna or horn antenna shall be substituted in place of the EUT. The log-periodic antenna will be driven by a signal generator and the level will be adjusted till the same power value on the spectrum analyzer or receiver. The level of the spurious emissions can be calculated through the level of the signal generator, cable loss, the gain of the substitution antenna and the reading of the spectrum analyzer or receiver.
- The EUT is then put into continuously transmitting mode at its maximum power level during the test. Set Test Receiver or Spectrum RBW=100kHz, VBW=300kHz for 30MHz to 1GHz and RBW=1MHz, VBW=3MHz for above 1GHz, and the maximum value of the receiver should be recorded as (Pr).
- The EUT shall be replaced by a substitution antenna. In the chamber, an substitution antenna for the frequency band of interest is placed at the reference point of the chamber. An RF Signal source for the frequency band of interest is connected to the substitution antenna with a cable that has been constructed to not interfere with the radiation pattern of the antenna. A power (PMea) is applied to the input of the substitution antenna, and adjust the level of the signal generator output until the value of the receiver reach the previously recorded (Pr). The power of signal source (PMea) is recorded. The test should be performed by rotating the test item and adjusting the receiving antenna polarization.
- A amplifier should be connected to the Signal Source output port. And the cable should be connect between the Amplifier and the Substitution Antenna. The cable loss (Pcl), the Substitution Antenna Gain (Ga) and the Amplifier Gain (PAg) should be recorded after test.
- The measurement results are obtained as described below:

$$\text{Power(EIRP)} = \text{PMea} - \text{PAg} - \text{Pcl} + \text{Ga}$$
 The measurement results are amend as described below:

$$\text{Power(EIRP)} = \text{PMea} - \text{Pcl} + \text{Ga}$$
- This value is EIRP since the measurement is calibrated using an antenna of known gain (2.15 dBi) and known input power. ERP can be calculated from EIRP by subtracting the gain of the dipole, ERP

= EIRP-2.15dBi.

The modulation mode and RB allocation refer to section 5.1, using the maximum output power configuration.

Test setup

9KHz ~ 30MHz

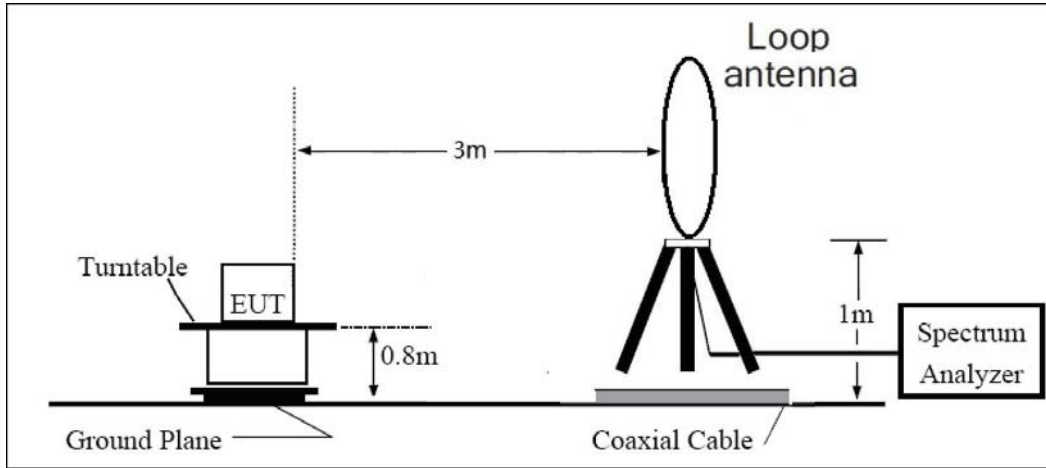

30MHz ~ 1GHz

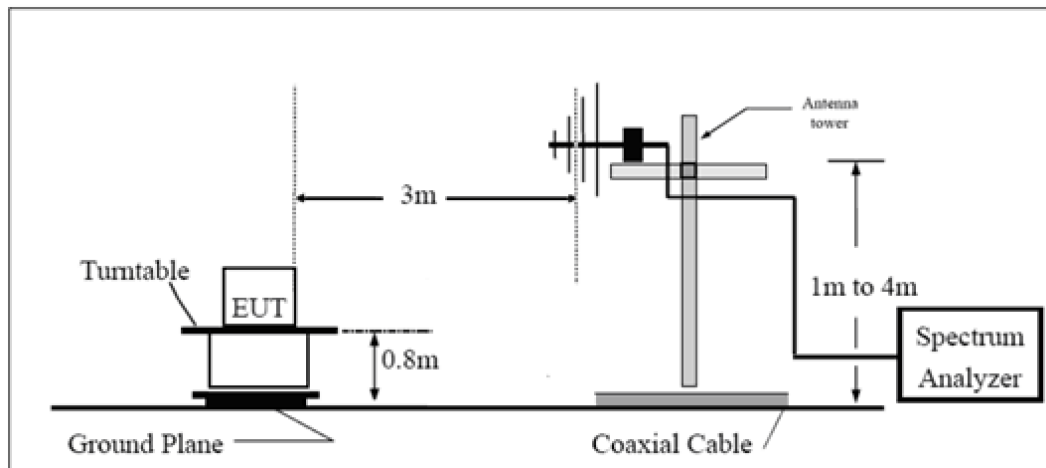

Above 1GHz

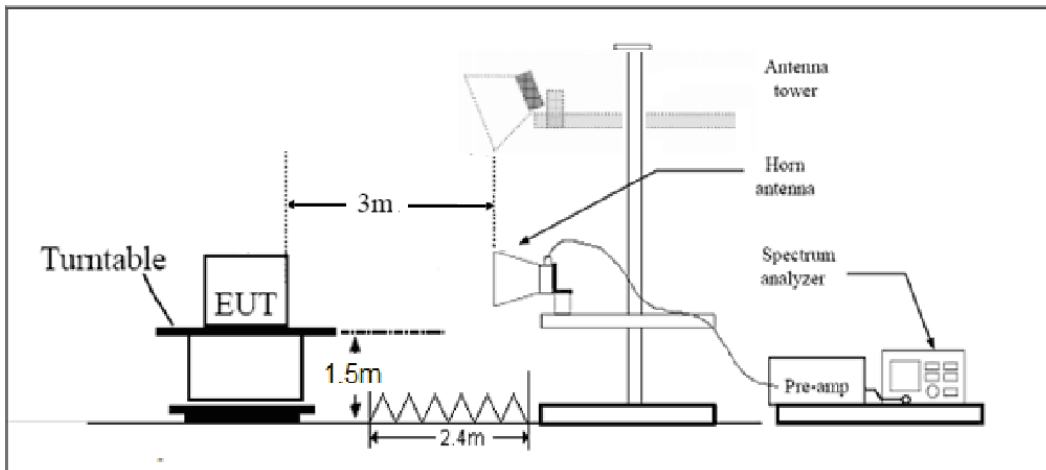

Note: Area side: 2.4mX3.6m

Limits

Rule Part 27.53 (h) specifies that “for operations in the 1695-1710 MHz, 1710-1755 MHz, 1755-1780 MHz, 1915-1920 MHz, 1995-2000 MHz, 2000-2020 MHz, 2110-2155 MHz, 2155-2180 MHz, and 2180-2200 bands, the power of any emission outside a licensee's frequency block shall be attenuated below the transmitter power (P) in watts by at least $43 + 10 \log_{10}(P)$ dB.”

Rule Part 27.53 (g) For operations in the 600 MHz band and the 698-746 MHz band, the power of any emission outside a licensee's frequency band(s) of operation shall be attenuated below the transmitter power (P) within the licensed band(s) of operation, measured in watts, by at least $43 + 10 \log(P)$ dB. Compliance with this provision is based on the use of measurement instrumentation employing a resolution bandwidth of 100 kilohertz or greater. However, in the 100 kilohertz bands immediately outside and adjacent to a licensee's frequency block, a resolution bandwidth of at least 30 kHz may be employed.

Rule Part 27.53 (f) For operations in the 746-758 MHz, 775-788 MHz, and 805-806 MHz bands, emissions in the band 1559-1610 MHz shall be limited to -70 dBW/MHz equivalent isotropically radiated power (EIRP) for wideband signals, and -80 dBW EIRP for discrete emissions of less than 700 Hz bandwidth. For the purpose of equipment authorization, a transmitter shall be tested with an antenna that is representative of the type that will be used with the equipment in normal operation.

Part 27.53 (c) For operations in the 746-758 MHz band and the 776-788 MHz band, the power of any emission outside the licensee's frequency band(s) of operation shall be attenuated below the transmitter power (P) within the licensed band(s) of operation, measured in watts, in accordance with the following:

- (1) On any frequency outside the 746-758 MHz band, the power of any emission shall be attenuated outside the band below the transmitter power (P) by at least $43 + 10 \log(P)$ dB;
- (2) On any frequency outside the 776-788 MHz band, the power of any emission shall be attenuated outside the band below the transmitter power (P) by at least $43 + 10 \log(P)$ dB;
- (3) On all frequencies between 763-775 MHz and 793-805 MHz, by a factor not less than $76 + 10 \log(P)$ dB in a 6.25 kHz band segment, for base and fixed stations;
- (4) On all frequencies between 763-775 MHz and 793-805 MHz, by a factor not less than $65 + 10 \log(P)$ dB in a 6.25 kHz band segment, for mobile and portable stations;
- (5) Compliance with the provisions of paragraphs (c)(1) and (c)(2) of this section is based on the use of measurement instrumentation employing a resolution bandwidth of 100 kHz or greater. However, in the 100 kHz bands immediately outside and adjacent to the frequency block, a resolution bandwidth of at least 30 kHz may be employed;

Part 27.53(a)/(h)/(g) Limit		-13 dBm
Part 27.53(f) Limit	Limit out of the band 1559-1610 MHz	-13 dBm
	Limit in the band 1559-1610 MHz	-40 dBm

Measurement Uncertainty

The assessed measurement uncertainty to ensure 95% confidence level for the normal distribution is with the coverage factor $k = \pm 1.96$, $U = \pm 3.55$ dB.

Test Result

Sweep the whole frequency band through the range from 9kHz to the 10th harmonic of the carrier, the emissions below the noise floor will not be recorded in the report.

NB-IoT Band 4 3.75KHz BPSK CH-Low

Harmonic	Frequency (MHz)	SG (dBm)	Cable Loss (dB)	Gain (dBi)	Antenna Polarization	ERP Level (dBm)	Limit (dBm)	Margin (dB)	Azimuth (deg)
2	3420.00	-61.69	1.70	8.70	Vertical	-54.69	-13.00	41.69	270
3	5130.00	-48.25	2.30	12.00	Vertical	-38.55	-13.00	25.55	225
4	6840.00	-55.50	2.70	12.70	Vertical	-45.50	-13.00	32.50	225
5	8550.00	-59.11	3.00	12.50	Vertical	-49.61	-13.00	36.61	180
6	10260.00	-56.27	3.40	12.50	Vertical	-47.17	-13.00	34.17	270
7	11970.00	-56.29	3.40	12.80	Vertical	-46.89	-13.00	33.89	180
8	13680.00	-52.58	4.10	11.50	Vertical	-45.18	-13.00	32.18	45
9	15390.00	-57.51	4.20	12.20	Vertical	-49.51	-13.00	36.51	315
10	17100.00	-53.94	4.30	12.50	Vertical	-45.74	-13.00	32.74	90

Note: 1.The other Spurious RF Radiated emissions level is no more than noise floor.
 2.The worst emission was found in the antenna is Vertical position.

NB-IoT Band 4 3.75KHz BPSK CH-Middle

Harmonic	Frequency (MHz)	SG (dBm)	Cable Loss (dB)	Gain (dBi)	Antenna Polarization	ERP Level (dBm)	Limit (dBm)	Margin (dB)	Azimuth (deg)
2	3465.00	-60.43	1.70	8.70	Vertical	-53.43	-13.00	40.43	315
3	5197.50	-48.74	2.30	12.00	Vertical	-39.04	-13.00	26.04	315
4	6930.00	-54.69	2.70	12.70	Vertical	-44.69	-13.00	31.69	90
5	8662.50	-61.24	3.00	12.50	Vertical	-51.74	-13.00	38.74	0
6	10395.00	-55.65	3.40	12.50	Vertical	-46.55	-13.00	33.55	225
7	12127.50	-55.46	3.40	12.80	Vertical	-46.06	-13.00	33.06	225
8	13860.00	-50.92	4.10	11.50	Vertical	-43.52	-13.00	30.52	270
9	15592.50	-56.77	4.20	12.20	Vertical	-48.77	-13.00	35.77	135
10	17325.00	-54.02	4.30	12.50	Vertical	-45.82	-13.00	32.82	225

Note: 1.The other Spurious RF Radiated emissions level is no more than noise floor.
 2.The worst emission was found in the antenna is Vertical position.

NB-IoT Band 4 3.75KHz BPSK CH-High

Harmonic	Frequency (MHz)	SG (dBm)	Cable Loss (dB)	Gain (dBi)	Antenna Polarization	ERP Level (dBm)	Limit (dBm)	Margin (dB)	Azimuth (deg)
2	3509.80	-57.36	1.70	8.70	Vertical	-50.36	-13.00	37.36	180
3	5264.70	-52.53	2.30	12.00	Vertical	-42.83	-13.00	29.83	45
4	7019.60	-54.06	2.70	12.70	Vertical	-44.06	-13.00	31.06	315
5	8774.50	-59.88	3.00	12.50	Vertical	-50.38	-13.00	37.38	90
6	10529.40	-55.89	3.40	12.50	Vertical	-46.79	-13.00	33.79	315
7	12284.30	-57.04	3.40	12.80	Vertical	-47.64	-13.00	34.64	315
8	14039.20	-51.43	4.10	11.50	Vertical	-44.03	-13.00	31.03	90
9	15794.10	-56.04	4.20	12.20	Vertical	-48.04	-13.00	35.04	0
10	17549.00	-54.27	4.30	12.50	Vertical	-46.07	-13.00	33.07	45

Note: 1.The other Spurious RF Radiated emissions level is no more than noise floor.

2.The worst emission was found in the antenna is Vertical position.

NB-IoT Band 12 3.75KHz BPSK CH-Low

Harmonic	Frequency (MHz)	SG (dBm)	Cable Loss (dB)	Gain (dBi)	Antenna Polarization	ERP Level (dBm)	Limit (dBm)	Margin (dB)	Azimuth (deg)
2	1398.20	-52.22	1.70	8.70	Vertical	-47.37	-13.00	34.37	180
3	2097.30	-65.35	2.30	12.00	Vertical	-57.80	-13.00	44.80	270
4	2796.40	-65.32	2.70	12.70	Vertical	-57.47	-13.00	44.47	180
5	3495.50	-64.34	3.00	12.50	Vertical	-56.99	-13.00	43.99	0
6	4194.60	-64.29	3.40	12.50	Vertical	-57.34	-13.00	44.34	225
7	4893.70	-58.28	3.40	12.80	Vertical	-51.03	-13.00	38.03	225
8	5592.80	-56.74	4.10	11.50	Vertical	-51.49	-13.00	38.49	270
9	6291.90	-60.23	4.20	12.20	Vertical	-54.38	-13.00	41.38	135
10	6991.00	-59.58	4.30	12.50	Vertical	-53.53	-13.00	40.53	225

Note: 1.The other Spurious RF Radiated emissions level is no more than noise floor.

2.The worst emission was found in the antenna is Vertical position.

NB-IoT Band 12 3.75KHz BPSK CH-Middle

Harmonic	Frequency (MHz)	SG (dBm)	Cable Loss (dB)	Gain (dBi)	Antenna Polarization	ERP Level (dBm)	Limit (dBm)	Margin (dB)	Azimuth (deg)
2	1415.00	-55.09	1.70	8.70	Vertical	-50.24	-13.00	37.24	45
3	2122.50	-67.33	2.30	12.00	Vertical	-59.78	-13.00	46.78	315
4	2830.00	-65.34	2.70	12.70	Vertical	-57.49	-13.00	44.49	90
5	3525.50	-65.39	3.00	12.50	Vertical	-58.04	-13.00	45.04	180
6	4244.40	-62.84	3.40	12.50	Vertical	-55.89	-13.00	42.89	45
7	4952.50	-58.02	3.40	12.80	Vertical	-50.77	-13.00	37.77	315
8	5659.40	-57.02	4.10	11.50	Vertical	-51.77	-13.00	38.77	90
9	6345.90	-59.71	4.20	12.20	Vertical	-53.86	-13.00	40.86	315
10	7075.00	-56.51	4.30	12.50	Vertical	-50.46	-13.00	37.46	315

Note: 1.The other Spurious RF Radiated emissions level is no more than noise floor.

2.The worst emission was found in the antenna is Vertical position.

NB-IoT Band 12 3.75KHz BPSK CH-High

Harmonic	Frequency (MHz)	SG (dBm)	Cable Loss (dB)	Gain (dBi)	Antenna Polarization	ERP Level (dBm)	Limit (dBm)	Margin (dB)	Azimuth (deg)
2	1431.80	-55.24	1.70	8.70	Vertical	-50.39	-13.00	37.39	315
3	2147.70	-64.58	2.30	12.00	Vertical	-57.03	-13.00	44.03	315
4	2863.60	-66.50	2.70	12.70	Vertical	-58.65	-13.00	45.65	90
5	3579.50	-67.34	3.00	12.50	Vertical	-59.99	-13.00	46.99	90
6	4295.40	-63.65	3.40	12.50	Vertical	-56.70	-13.00	43.70	0
7	5011.30	-56.37	3.40	12.80	Vertical	-49.12	-13.00	36.12	45
8	5727.20	-57.01	4.10	11.50	Vertical	-51.76	-13.00	38.76	0
9	6443.10	-57.89	4.20	12.20	Vertical	-52.04	-13.00	39.04	225
10	7159.00	-56.40	4.30	12.50	Vertical	-50.35	-13.00	37.35	90

Note: 1.The other Spurious RF Radiated emissions level is no more than noise floor.

2.The worst emission was found in the antenna is Vertical position.

NB-IoT Band 13 3.75KHz BPSK CH-Low

Harmonic	Frequency (MHz)	SG (dBm)	Cable Loss (dB)	Gain (dBi)	Antenna Polarization	ERP Level (dBm)	Limit (dBm)	Margin (dB)	Azimuth (deg)
2	1554.20	-50.13	1.70	8.70	Vertical	-45.28	-13.00	32.28	135
3	2331.30	-56.48	2.30	12.00	Vertical	-48.93	-13.00	35.93	0
4	3108.40	-64.96	2.70	12.70	Vertical	-57.11	-13.00	44.11	135
5	3885.50	-64.96	3.00	12.50	Vertical	-57.61	-13.00	44.61	180
6	4662.60	-52.20	3.40	12.50	Vertical	-45.25	-13.00	32.25	45
7	5439.70	-53.00	3.40	12.80	Vertical	-45.75	-13.00	32.75	315
8	6216.80	-54.97	4.10	11.50	Vertical	-49.72	-13.00	36.72	90
9	6993.90	-57.89	4.20	12.20	Vertical	-52.04	-13.00	39.04	45
10	7771.00	-55.44	4.30	12.50	Vertical	-49.39	-13.00	36.39	225

Note: 1.The other Spurious RF Radiated emissions level is no more than noise floor.

2.The worst emission was found in the antenna is Vertical position.

NB-IoT Band 13 3.75KHz BPSK CH-Middle

Harmonic	Frequency (MHz)	SG (dBm)	Cable Loss (dB)	Gain (dBi)	Antenna Polarization	ERP Level (dBm)	Limit (dBm)	Margin (dB)	Azimuth (deg)
2	1564.00	-53.23	1.70	8.70	Vertical	-48.38	-40.00	8.38	135
3	2346.00	-59.08	2.30	12.00	Vertical	-51.53	-13.00	38.53	0
4	3128.00	-65.81	2.70	12.70	Vertical	-57.96	-13.00	44.96	180
5	3910.00	-64.36	3.00	12.50	Vertical	-57.01	-13.00	44.01	90
6	4692.00	-52.34	3.40	12.50	Vertical	-45.39	-13.00	32.39	45
7	5474.00	-53.90	3.40	12.80	Vertical	-46.65	-13.00	33.65	315
8	6256.00	-55.52	4.10	11.50	Vertical	-50.27	-13.00	37.27	270
9	7038.00	-54.89	4.20	12.20	Vertical	-49.04	-13.00	36.04	0
10	7820.00	-55.47	4.30	12.50	Vertical	-49.42	-13.00	36.42	225

Note: 1.The other Spurious RF Radiated emissions level is no more than noise floor.

2.The worst emission was found in the antenna is Vertical position.

NB-IoT Band 13 3.75KHz BPSK CH-High

Harmonic	Frequency (MHz)	SG (dBm)	Cable Loss (dB)	Gain (dBi)	Antenna Polarization	ERP Level (dBm)	Limit (dBm)	Margin (dB)	Azimuth (deg)
2	1573.80	-55.41	1.70	8.70	Vertical	-50.56	-40.00	10.56	135
3	2360.70	-59.80	2.30	12.00	Vertical	-52.25	-13.00	39.25	0
4	3147.60	-66.14	2.70	12.70	Vertical	-58.29	-13.00	45.29	135
5	3934.50	-64.76	3.00	12.50	Vertical	-57.41	-13.00	44.41	45
6	4721.40	-50.47	3.40	12.50	Vertical	-43.52	-13.00	30.52	225
7	5508.30	-53.34	3.40	12.80	Vertical	-46.09	-13.00	33.09	90
8	6295.20	-55.81	4.10	11.50	Vertical	-50.56	-13.00	37.56	45
9	7082.10	-55.08	4.20	12.20	Vertical	-49.23	-13.00	36.23	135
10	7869.00	-55.13	4.30	12.50	Vertical	-49.08	-13.00	36.08	90

Note: 1.The other Spurious RF Radiated emissions level is no more than noise floor.

2.The worst emission was found in the antenna is Vertical position.

NB-IoT Band 17 3.75KHz BPSK CH-Low

Harmonic	Frequency (MHz)	SG (dBm)	Cable Loss (dB)	Gain (dBi)	Antenna Polarization	ERP Level (dBm)	Limit (dBm)	Margin (dB)	Azimuth (deg)
2	1408.20	-55.32	1.70	8.70	Vertical	-50.47	-13.00	37.47	135
3	2112.30	-63.87	2.30	12.00	Vertical	-56.32	-13.00	43.32	270
4	2816.40	-66.22	2.70	12.70	Vertical	-58.37	-13.00	45.37	45
5	3520.50	-65.62	3.00	12.50	Vertical	-58.27	-13.00	45.27	90
6	4224.60	-64.16	3.40	12.50	Vertical	-57.21	-13.00	44.21	45
7	4928.70	-58.02	3.40	12.80	Vertical	-50.77	-13.00	37.77	315
8	5632.80	-56.30	4.10	11.50	Vertical	-51.05	-13.00	38.05	90
9	6336.90	-58.18	4.20	12.20	Vertical	-52.33	-13.00	39.33	45
10	7041.00	-56.59	4.30	12.50	Vertical	-50.54	-13.00	37.54	225

Note: 1.The other Spurious RF Radiated emissions level is no more than noise floor.

2.The worst emission was found in the antenna is Vertical position.

NB-IoT Band 17 3.75KHz BPSK CH-Middle

Harmonic	Frequency (MHz)	SG (dBm)	Cable Loss (dB)	Gain (dBi)	Antenna Polarization	ERP Level (dBm)	Limit (dBm)	Margin (dB)	Azimuth (deg)
2	1420.00	-54.77	1.70	8.70	Vertical	-49.92	-13.00	36.92	180
3	2130.00	-66.33	2.30	12.00	Vertical	-58.78	-13.00	45.78	315
4	2840.00	-65.43	2.70	12.70	Vertical	-57.58	-13.00	44.58	90
5	3550.00	-65.56	3.00	12.50	Vertical	-58.21	-13.00	45.21	0
6	4260.00	-64.62	3.40	12.50	Vertical	-57.67	-13.00	44.67	90
7	4970.00	-58.10	3.40	12.80	Vertical	-50.85	-13.00	37.85	45
8	5680.00	-56.16	4.10	11.50	Vertical	-50.91	-13.00	37.91	315
9	6390.00	-59.03	4.20	12.20	Vertical	-53.18	-13.00	40.18	270
10	7100.00	-55.08	4.30	12.50	Vertical	-49.03	-13.00	36.03	90

Note: 1.The other Spurious RF Radiated emissions level is no more than noise floor.
2.The worst emission was found in the antenna is Vertical position.

NB-IoT Band 17 3.75KHz BPSK CH-High

Harmonic	Frequency (MHz)	SG (dBm)	Cable Loss (dB)	Gain (dBi)	Antenna Polarization	ERP Level (dBm)	Limit (dBm)	Margin (dB)	Azimuth (deg)
2	1431.80	-55.27	1.70	8.70	Vertical	-50.42	-13.00	37.42	180
3	2147.70	-62.37	2.30	12.00	Vertical	-54.82	-13.00	41.82	270
4	2863.60	-66.15	2.70	12.70	Vertical	-58.30	-13.00	45.30	45
5	3579.50	-64.74	3.00	12.50	Vertical	-57.39	-13.00	44.39	0
6	4295.40	-63.88	3.40	12.50	Vertical	-56.93	-13.00	43.93	45
7	5011.30	-56.03	3.40	12.80	Vertical	-48.78	-13.00	35.78	315
8	5727.20	-56.39	4.10	11.50	Vertical	-51.14	-13.00	38.14	90
9	6443.10	-59.34	4.20	12.20	Vertical	-53.49	-13.00	40.49	45
10	7159.00	-54.06	4.30	12.50	Vertical	-48.01	-13.00	35.01	225

Note: 1.The other Spurious RF Radiated emissions level is no more than noise floor.
2.The worst emission was found in the antenna is Vertical position.

NB-IoT Band 66 3.75KHz BPSK CH-Low

Harmonic	Frequency (MHz)	SG (dBm)	Cable Loss (dB)	Gain (dBi)	Antenna Polarization	ERP Level (dBm)	Limit (dBm)	Margin (dB)	Azimuth (deg)
2	3420.20	-62.37	1.70	8.70	Vertical	-55.37	-13.00	42.37	0
3	5130.30	-47.80	2.30	12.00	Vertical	-38.10	-13.00	25.10	45
4	6840.40	-55.69	2.70	12.70	Vertical	-45.69	-13.00	32.69	135
5	8550.50	-57.79	3.00	12.50	Vertical	-48.29	-13.00	35.29	180
6	10260.60	-54.44	3.40	12.50	Vertical	-45.34	-13.00	32.34	45
7	11970.70	-54.31	3.40	12.80	Vertical	-44.91	-13.00	31.91	315
8	13680.80	-51.29	4.10	11.50	Vertical	-43.89	-13.00	30.89	90
9	15390.90	-56.80	4.20	12.20	Vertical	-48.80	-13.00	35.80	45
10	17101.00	-53.26	4.30	12.50	Vertical	-45.06	-13.00	32.06	90

Note: 1.The other Spurious RF Radiated emissions level is no more than noise floor.
 2.The worst emission was found in the antenna is Vertical position.

NB-IoT Band 66 3.75KHz BPSK CH-Middle

Harmonic	Frequency (MHz)	SG (dBm)	Cable Loss (dB)	Gain (dBi)	Antenna Polarization	ERP Level (dBm)	Limit (dBm)	Margin (dB)	Azimuth (deg)
2	3490.00	-60.99	1.70	8.70	Vertical	-53.99	-13.00	40.99	45
3	5235.00	-49.23	2.30	12.00	Vertical	-39.53	-13.00	26.53	180
4	6980.00	-55.04	2.70	12.70	Vertical	-45.04	-13.00	32.04	270
5	8725.00	-57.02	3.00	12.50	Vertical	-47.52	-13.00	34.52	0
6	10470.00	-55.47	3.40	12.50	Vertical	-46.37	-13.00	33.37	90
7	12215.00	-55.76	3.40	12.80	Vertical	-46.36	-13.00	33.36	45
8	13960.00	-52.06	4.10	11.50	Vertical	-44.66	-13.00	31.66	135
9	15705.00	-55.18	4.20	12.20	Vertical	-47.18	-13.00	34.18	315
10	17450.00	-53.42	4.30	12.50	Vertical	-45.22	-13.00	32.22	270

Note: 1.The other Spurious RF Radiated emissions level is no more than noise floor.
 2.The worst emission was found in the antenna is Vertical position.

NB-IoT Band 66 3.75KHz BPSK CH-High

Harmonic	Frequency (MHz)	SG (dBm)	Cable Loss (dB)	Gain (dBi)	Antenna Polarization	ERP Level (dBm)	Limit (dBm)	Margin (dB)	Azimuth (deg)
2	3559.80	-60.83	1.70	8.70	Vertical	-53.83	-13.00	40.83	90
3	5339.70	-51.31	2.30	12.00	Vertical	-41.61	-13.00	28.61	270
4	7119.60	-52.46	2.70	12.70	Vertical	-42.46	-13.00	29.46	90
5	8899.50	-57.90	3.00	12.50	Vertical	-48.40	-13.00	35.40	0
6	10679.40	-53.85	3.40	12.50	Vertical	-44.75	-13.00	31.75	0
7	12459.30	-56.00	3.40	12.80	Vertical	-46.60	-13.00	33.60	45
8	14239.20	-50.03	4.10	11.50	Vertical	-42.63	-13.00	29.63	180
9	16019.10	-56.45	4.20	12.20	Vertical	-48.45	-13.00	35.45	315
10	17799.00	-55.25	4.30	12.50	Vertical	-47.05	-13.00	34.05	90

Note: 1.The other Spurious RF Radiated emissions level is no more than noise floor.

2.The worst emission was found in the antenna is Vertical position.

6 Main Test Instruments

Name	Manufacturer	Type	Serial Number	Calibration Date	Expiration Date
Base Station Simulator	R&S	CMW500	113824	2021-05-15	2022-05-14
Power Splitter	Hua Xiang	SHX-GF2-2-13	10120101	/	/
Spectrum Analyzer	Key sight	N9010A	MY50210259	2021-05-15	2022-05-14
Signal Analyzer	R&S	FSV3030	101411	2020-12-13	2021-12-12
Loop Antenna	SCHWARZBECK	FMZB1519	1519-047	2020-04-02	2023-04-01
TRILOG Broadband Antenna	SCHWARZBECK	VULB 9163	391	2019-12-16	2022-12-15
Horn Antenna	R&S	HF907	102723	2018-08-11	2021-08-10
Horn Antenna	ETS-Lindgren	3160-09	00102644	2018-06-20	2023-06-19
Horn Antenna	STEATITE	QSH-SL-26-40-K-15	16779	2019-12-24	2022-12-23
Signal generator	R&S	SMB 100A	102594	2021-05-15	2022-05-14
Climatic Chamber	ESPEC	SU-242	93000506	2020-12-13	2021-12-12
Preamplifier	R&S	SCU18	102327	2021-05-15	2022-05-14
MOB COMMS DC SUPPLY	Keysight	66319D	MY43004105	2021-06-09	2021-12-08
RF Cable	Agilent	SMA 15cm	0001	2021-06-09	2021-12-08
Software	R&S	EMC32	9.26.0	/	/

*****END OF REPORT *****

ANNEX A: The EUT Appearance

The EUT Appearance are submitted separately.

ANNEX B: Test Setup Photos

The Test Setup Photos are submitted separately.

ANNEX C: Product Change Description

The Product Change Description are submitted separately.