



RF TEST REPORT

Applicant Quectel Wireless Solutions Co., Ltd.
FCC ID XMR2021BG770AGL
Product LTE Module
Brand Quectel
Model BG770A-GL
Report No. R2207A0656-R6V1
Issue Date August 29, 2022

TA Technology (Shanghai) Co., Ltd. tested the above equipment in accordance with the requirements in **FCC CFR47 Part 2 (2021)/ FCC CFR 47 Part 24E (2021)**. The test results show that the equipment tested is capable of demonstrating compliance with the requirements as documented in this report.

Prepared by: Xu Ying

Approved by: Xu Kai

TA Technology (Shanghai) Co., Ltd.

Building 3, No.145, Jintang Rd, Tangzhen Industry Park, Pudong Shanghai, China

TEL: +86-021-50791141/2/3

FAX: +86-021-50791141/2/3-8000



TABLE OF CONTENT

- 1. Test Laboratory5
 - 1.1. Notes of the test report.....5
 - 1.2. Test facility.....5
 - 1.3. Testing Location5
- 2. General Description of Equipment under Test.....6
 - 2.1. Applicant and Manufacturer Information6
 - 2.2. General information6
- 3. Applied Standards.....7
- 4. Test Configuration.....8
- 5. Test Case Results.....9
 - 5.1. RF Power Output and Effective Isotropic Radiated Power9
 - 5.2. Occupied Bandwidth12
 - 5.3. Band Edge Compliance.....18
 - 5.4. Peak-to-Average Power Ratio (PAPR)35
 - 5.5. Frequency Stability.....37
 - 5.6. Spurious Emissions at Antenna Terminals44
 - 5.7. Radiates Spurious Emission51
- 6. Main Test Instruments58
- ANNEX A: The EUT Appearance.....59
- ANNEX B: Test Setup Photos60
- ANNEX C: Product Change Description61



Version	Revision description	Issue Date
Rev.0	Initial issue of report.	August 10, 2022
Rev.1	Update information.	August 29, 2022

Note: This revised report (Report No. R2207A0656-R6V1) supersedes and replaces the previously issued report (Report No. R2207A0656-R6). Please discard or destroy the previously issued report and dispose of it accordingly.



Summary of measurement results

No.	Test Case	Clause in FCC rules	Verdict
1	RF Power Output and Effective Isotropic Radiated Power	2.1046 24.232(c)	PASS
2	Occupied Bandwidth	2.1049	PASS
3	Band Edge Compliance	2.1051 /24.238(a)	PASS
4	Peak-to-Average Power Ratio	24.232/KDB 971168 D01(5.7)	PASS
5	Frequency Stability	2.1055 / 24.235	PASS
6	Spurious Emissions at Antenna Terminals	2.1051 / 24.238(a)	PASS
7	Radiates Spurious Emission	2.1053 / 24.238(a)	PASS

Date of Testing: April 21, 2021 ~ May 14, 2021

Date of Sample Received: April 16, 2021

Note: PASS: The EUT complies with the essential requirements in the standard.

FAIL: The EUT does not comply with the essential requirements in the standard.

All indications of Pass/Fail in this report are opinions expressed by TA Technology (Shanghai) Co., Ltd. based on interpretations and/or observations of test results. Measurement Uncertainties were not taken into account and are published for informational purposes only.

BG770A-GL (Report No.: R2207A0656-R6V1) is a variant model of BG770A-GL (Report No.: R2104A0331-R6). Test values all duplicated from Original for variant. There is no test for variant in this report. BG770A-GL supports from Cat NB1 (3GPP R13) to Cat NB2 (3GPP R14) only by FW updating, the hardware remains the same.

The detailed product change description please refers to following table:

Module	BG770A-GL (Cat NB1)	BG770A-GL (Cat NB2)
Category	Cat M1 & NB1	Cat M1 & NB2
Frequency Bands	Cat M1 LTE-HD-FDD: B2/B4/B5 /B12/B13/B25/B26/B66 Cat NB1 LTE-HD-FDD: B2/B4/B5/B12/B13/B17/ B25/B66	Cat M1 LTE-HD-FDD: B2/B4/B5 /B12/B13/B25/B26/B66 Cat NB2 LTE-HD-FDD: B2/B4/B5/B12/B13/B17/ B25/B66
Others	The same	

The detailed product change description please refers to the Difference Declaration Letter.



1. Test Laboratory

1.1. Notes of the test report

This report shall not be reproduced in full or partial, without the written approval of **TA technology (shanghai) co., Ltd.** The results documented in this report apply only to the tested sample, under the conditions and modes of operation as described herein. Measurement Uncertainties were not taken into account and are published for informational purposes only. This report is written to support regulatory compliance of the applicable standards stated above.

1.2. Test facility

FCC (Designation number: CN1179, Test Firm Registration Number: 446626)

TA Technology (Shanghai) Co., Ltd. has been listed on the US Federal Communications Commission list of test facilities recognized to perform measurements.

A2LA (Certificate Number: 3857.01)

TA Technology (Shanghai) Co., Ltd. has been listed by American Association for Laboratory Accreditation to perform measurement.

1.3. Testing Location

Company: TA Technology (Shanghai) Co., Ltd.
Address: Building 3, No.145, Jintang Rd, Tangzhen Industry Park, Pudong Shanghai, China
City: Shanghai
Post code: 201201
Country: P. R. China
Contact: Xu Kai
Telephone: +86-021-50791141/2/3
Fax: +86-021-50791141/2/3-8000
Website: <http://www.ta-shanghai.com>
E-mail: xukai@ta-shanghai.com

2. General Description of Equipment under Test

2.1. Applicant and Manufacturer Information

Applicant	Quectel Wireless Solutions Co., Ltd
Applicant address	Building 5, Shanghai Business Park Phase III (Area B), No.1016 Tianlin Road, Minhang District, Shanghai, 200233 China
Manufacturer	Quectel Wireless Solutions Co., Ltd
Manufacturer address	Building 5, Shanghai Business Park Phase III (Area B), No.1016 Tianlin Road, Minhang District, Shanghai, 200233 China

2.2. General information

EUT Description			
Model	BG770A-GL		
IMEI	863593050006733		
Hardware Version	R1.1		
Software Version	BG770AGLAAR02A01		
Power Supply	External power supply		
Antenna Type	External Antenna		
Antenna Gain	Band	Frequency (MHz)	Gain (dBi)
	LTE Band 2/25	1840	1.36
		1860	1.25
		1880	1.38
		1900	1.59
1920		1.36	
Test Mode(s)	LTE Band 2/25;		
Test Modulation	QPSK,16QAM		
LTE Category	M1		
Maximum E.I.R.P	LTE Band 2:	25.37dBm	
	LTE Band 25:	25.34dBm	
Rated Power Supply Voltage	3.3V		
Operating Voltage	Minimum: 3.1V Maximum: 4.2V		
Operating Temperature	Lowest: -35°C Highest: +75°C		
Extreme Temperature	Lowest: -30°C Highest: +50°C		
Frequency Range(s)	Band	Tx (MHz)	Rx (MHz)
	LTE Band 2	1850 ~ 1910	1930 ~ 1990
	LTE Band 25	1850 ~ 1915	1930 ~ 1995
Note: 1. The EUT is sent from the applicant to TA and the information of the EUT is declared by the applicant.			

3. Applied Standards

According to the specifications of the manufacturer, it must comply with the requirements of the following standards:

Test standards:

FCC CFR 47 Part 24E (2021)

ANSI C63.26 (2015)

Reference standard:

FCC CFR47 Part 2 (2021)

KDB 971168 D01 Power Meas License Digital Systems v03r01

4. Test Configuration

Radiated measurements are performed by rotating the EUT in three different orthogonal test planes. EUT stand-up position (Z axis), lie-down position (X, Y axis). Receiver antenna polarization (horizontal and vertical), the worst emission was found in position (Z axis, horizontal polarization) and the worst case was recorded.

All mode and data rates and positions and RB size and modulations were investigated.

Subsequently, only the worst case emissions are reported.

The following testing in LTE is set based on the maximum RF Output Power.

Test modes are chosen to be reported as the worst case configuration below for LTE Band 2/25:

Test items	Bandwidth (MHz)						Modulation		RB			Test Channel		
	1.4	3	5	10	15	20	QPSK	16QAM	1	50%	100%	L	M	H
RF Power Output and Effective Isotropic Radiated Power	O	O	O	O	O	O	O	O	O	O	O	O	O	O
Occupied Bandwidth	O	O	O	O	O	O	O	O	-	-	O	O	O	O
Band Edge Compliance	O	O	O	O	O	O	O	O	O	-	O	O	-	O
Peak-to-Average Power Ratio	O	O	O	O	O	O	O	O	-	-	O	O	O	O
Frequency Stability	O	O	O	O	O	O	O	O	O	-	-	-	O	-
Spurious Emissions at Antenna Terminals	O	O	O	O	O	O	O	-	O	-	-	O	O	O
Radiates Spurious Emission	O	-	O	-	-	O	O	-	O	-	-	-	O	-
Note	1. The mark "O" means that this configuration is chosen for testing. 2. The mark "-" means that this configuration is not testing.													

5. Test Case Results

5.1.RF Power Output and Effective Isotropic Radiated Power

Ambient condition

Temperature	Relative humidity	Pressure
23°C ~25°C	45%~50%	101.5kPa

Methods of Measurement

During the process of the testing, The EUT was connected to the Base Station Simulator with a known loss. The EUT is controlled by the Base Station Simulator test set to ensure max power transmission with proper modulation.

ERP can then be calculated as follows:

$$\text{EIRP (dBm)} = \text{Output Power (dBm)} - \text{Losses (dB)} + \text{Antenna Gain (dBi)}$$

where:dBd refers to gain relative to an ideal dipole.

$$\text{EIRP (dBm)} = \text{ERP (dBm)} + 2.15 \text{ (dB.)}$$

Test Setup

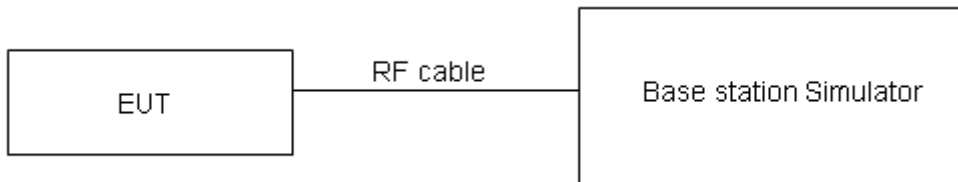

Limits

No specific RF power output requirements in part 2.1046.

Rule Part 24.232(c) Mobile and portable stations are limited to 2 watts EIRP.

Rule Part 24.232(e) Peak transmit power must be measured over any interval of continuous transmission using instrumentation calibrated in terms of an rms-equivalent voltage.

Limit	$\leq 2 \text{ W}$ (33 dBm)
-------	-----------------------------

Measurement Uncertainty

The assessed measurement uncertainty to ensure 95% confidence level for the normal distribution is with the coverage factor $k = 2$, $U = 0.4 \text{ dB}$ for RF power output, $k = 2$, $U = 1.19 \text{ dB}$ for EIRP.



Test Results

LTE Band 2	Channel/ Frequency(MHz)	Index	RB#	RB#	Maximum Output Power (dBm)		EIRP (dBm)	
			Rbstart QPSK	Rbstart 16QAM	QPSK	16QAM	QPSK	16QAM
1.4MHz	18607/1850.7	0	1#0	1#0	23.68	22.27	24.93	23.52
		0	6#0	5#0	22.24	21.68	23.49	22.93
	18900/1880	0	1#0	1#0	22.91	23.02	24.29	24.40
		0	6#0	5#0	21.81	21.74	23.19	23.12
	19193/1909.3	0	1#5	1#5	23.52	22.41	25.11	24.00
		0	6#0	5#0	21.93	21.44	23.52	23.03
3MHz	18615/1851.5	0	1#0	1#0	23.65	22.77	24.90	24.02
		0	6#0	5#0	21.88	21.61	23.13	22.86
	18900/1880	0	1#0	1#0	23.65	22.73	25.03	24.11
		0	6#0	5#0	21.81	21.60	23.19	22.98
	19185/1908.5	1	1#5	1#5	23.58	22.58	25.17	24.17
		1	6#0	5#0	21.75	21.47	23.34	23.06
5MHz	18625/1852.5	3	1#0	1#0	23.63	23.69	24.88	24.94
		0	6#0	5#0	22.94	21.66	24.19	22.91
	18900/1880	0	1#0	1#0	23.63	23.70	25.01	25.08
		0	6#0	5#0	22.89	21.63	24.27	23.01
	19175/1907.5	0	1#5	1#5	23.61	23.54	25.20	25.13
		3	6#0	5#0	22.95	21.44	24.54	23.03
10MHz	18650/1855	3	1#0	1#0	23.62	23.68	24.87	24.93
		0	4#0	4#0	23.44	22.64	24.69	23.89
	18900/1880	0	1#0	1#0	23.64	23.71	25.02	25.09
		0	4#0	4#0	23.21	22.71	24.59	24.09
	19150/1905	4	1#5	1#5	23.64	23.59	25.23	25.18
		7	4#2	4#2	23.30	21.66	24.89	23.25
15MHz	18675/1857.5	3	1#0	1#0	23.66	23.69	24.91	24.94
		0	6#0	5#0	23.45	23.59	24.70	24.84
	18900/1880	0	1#0	1#0	23.64	23.68	25.02	25.06
		0	6#0	5#0	23.43	23.61	24.81	24.99
	19125/1902.5	8	1#5	1#5	23.68	23.63	25.27	25.22
		11	6#0	5#0	23.78	23.47	25.37	25.06
20MHz	18700/1860	3	1#0	1#0	23.68	23.70	24.93	24.95
		0	6#0	5#0	23.50	23.59	24.75	24.84
	18900/1880	0	1#0	1#0	23.20	23.03	24.58	24.41
		0	6#0	5#0	23.73	23.12	25.11	24.50
	19100/1900	12	1#5	1#5	23.62	23.58	25.21	25.17
		15	6#0	5#0	23.37	23.54	24.96	25.13



LTE Band 25	Channel/ Frequency(MHz)	Index	RB#	RB#	Maximum Output Power (dBm)		EIRP (dBm)	
			Rbstart QPSK	Rbstart 16QAM	QPSK	16QAM	QPSK	16QAM
1.4MHz	26047/1850.7	0	1#0	1#0	23.50	22.51	24.75	23.76
		0	6#0	5#0	22.15	21.63	23.40	22.88
	26365/1882.5	0	1#0	1#0	23.55	22.59	24.93	23.97
		0	6#0	5#0	22.18	21.63	23.56	23.01
	26683/1914.3	0	1#5	1#5	23.58	22.40	24.94	23.76
		0	6#0	5#0	21.99	21.48	23.35	22.84
3MHz	26055/1851.5	0	1#0	1#0	23.67	22.80	24.92	24.05
		0	6#0	5#0	21.88	21.60	23.13	22.85
	26365/1882.5	0	1#0	1#0	23.68	22.80	25.06	24.18
		0	6#0	5#0	21.92	21.64	23.30	23.02
	26675/1913.5	1	1#5	1#5	23.68	22.67	25.04	24.03
		1	6#0	5#0	21.83	21.57	23.19	22.93
5MHz	26065/1852.5	3	1#0	1#0	23.69	23.73	24.94	24.98
		0	6#0	5#0	22.79	21.73	24.04	22.98
	26365/1882.5	0	1#0	1#0	23.72	23.76	25.10	25.14
		0	6#0	5#0	22.87	22.05	24.25	23.43
	26665/1912.5	0	1#5	1#5	23.70	23.62	25.06	24.98
		3	6#0	5#0	22.63	21.53	23.99	22.89
10MHz	26090/1855	3	1#0	1#0	23.68	23.73	24.93	24.98
		0	4#0	4#0	23.34	22.72	24.59	23.97
	26365/1882.5	0	1#0	1#0	23.74	23.80	25.12	25.18
		0	4#0	4#0	23.30	22.93	24.68	24.31
	26640/1910	4	1#5	1#5	23.69	23.64	25.05	25.00
		7	4#2	4#2	23.33	21.65	24.69	23.01
15MHz	26115/1857.5	3	1#0	1#0	23.74	23.77	24.99	25.02
		0	6#0	5#0	23.48	23.68	24.73	24.93
	26365/1882.5	0	1#0	1#0	23.75	23.02	25.13	24.40
		0	6#0	5#0	23.44	23.76	24.82	25.14
	26615/1907.5	8	1#5	1#5	23.71	23.68	25.30	25.27
		11	6#0	5#0	23.32	23.51	24.91	25.10
20MHz	26140/1860	3	1#0	1#0	23.70	23.75	24.95	25.00
		0	6#0	5#0	23.52	23.70	24.77	24.95
	26365/1882.5	0	1#0	1#0	23.73	23.78	25.11	25.16
		0	6#0	5#0	23.45	23.77	24.83	25.15
	26590/1905	12	1#5	1#5	23.65	23.62	25.24	25.21
		15	6#0	5#0	23.75	23.48	25.34	25.07

5.2.Occupied Bandwidth

Ambient condition

Temperature	Relative humidity	Pressure
23°C ~25°C	45%~50%	101.5kPa

Method of Measurement

The EUT was connected to Spectrum Analyzer and Base Station Simulator via power Splitter. The occupied bandwidth is measured using spectrum analyzer.

RBW is set to 51kHz, VBW is set to 160kHz for LTE Band 2/25.

99% power and -26dBc occupied bandwidths are recorded. Spectrum analyzer plots are included on the following pages.

Test Setup

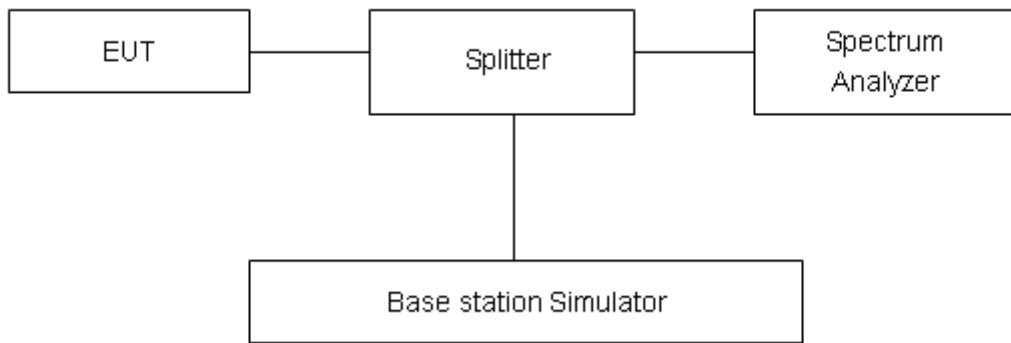

Limits

No specific occupied bandwidth requirements in part 2.1049.

Measurement Uncertainty

The assessed measurement uncertainty to ensure 95% confidence level for the normal distribution is with the coverage factor $k = 2$, $U = 624\text{Hz}$.

Test Result

Mode	Bandwidth	Modulation	Channel/ Frequency(MHz)	Bandwidth(MHz)	
				99% Power	-26dBc
LTE Band 2	1.4MHz	QPSK	18900/1880	1.1168	1.337
		16QAM	18900/1880	0.9671	1.308
	3MHz	QPSK	18900/1880	1.1163	1.336
		16QAM	18900/1880	0.9605	1.290
	5MHz	QPSK	18900/1880	1.1055	1.332
		16QAM	18900/1880	0.9916	1.315
	10MHz	QPSK	18900/1880	1.1111	1.346
		16QAM	18900/1880	0.9954	1.320
	15MHz	QPSK	18900/1880	1.2540	1.531
		16QAM	18900/1880	1.0057	1.339
	20MHz	QPSK	18900/1880	1.1148	1.351
		16QAM	18900/1880	1.0037	1.334

Mode	Bandwidth	Modulation	Channel/ Frequency(MHz)	Bandwidth(MHz)	
				99% Power	-26dBc
LTE Band 25	1.4MHz	QPSK	26365/1882.5	1.1116	1.325
		16QAM	26365/1882.5	0.9599	1.302
	3MHz	QPSK	26365/1882.5	1.1103	1.320
		16QAM	26365/1882.5	0.9620	1.284
	5MHz	QPSK	26365/1882.5	1.1035	1.343
		16QAM	26365/1882.5	0.9790	1.311
	10MHz	QPSK	26365/1882.5	1.1022	1.346
		16QAM	26365/1882.5	0.9874	1.302
	15MHz	QPSK	26365/1882.5	1.1104	1.342
		16QAM	26365/1882.5	1.0025	1.330
	20MHz	QPSK	26365/1882.5	1.1155	1.350
		16QAM	26365/1882.5	0.9956	1.325

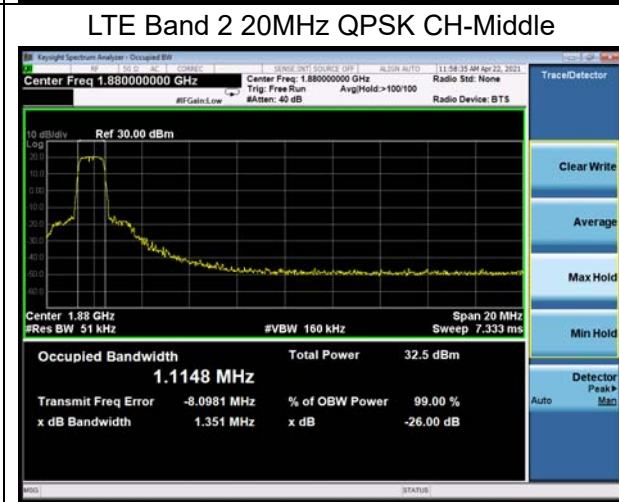
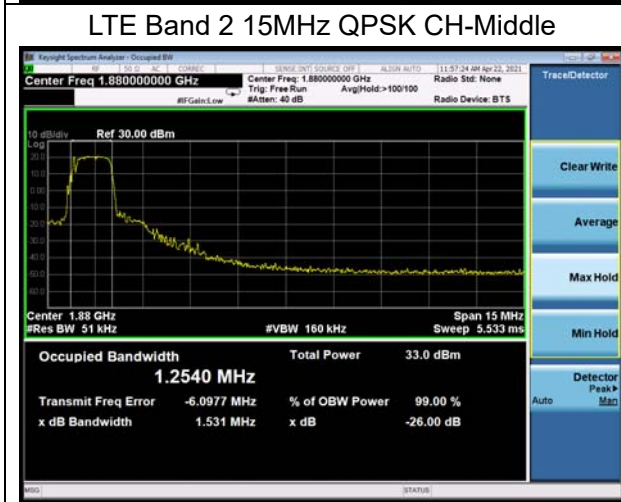
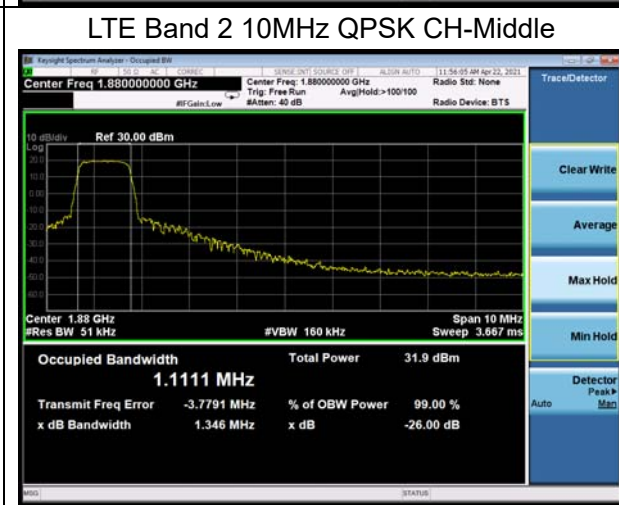
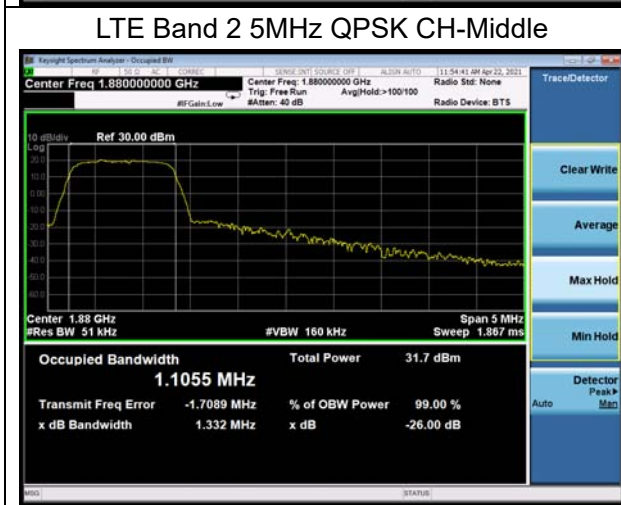
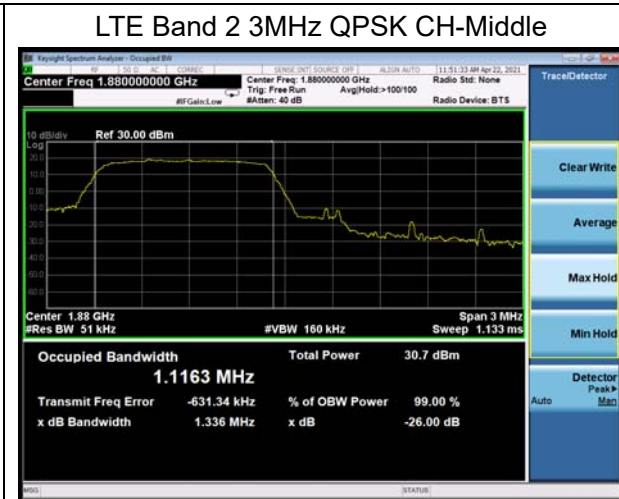
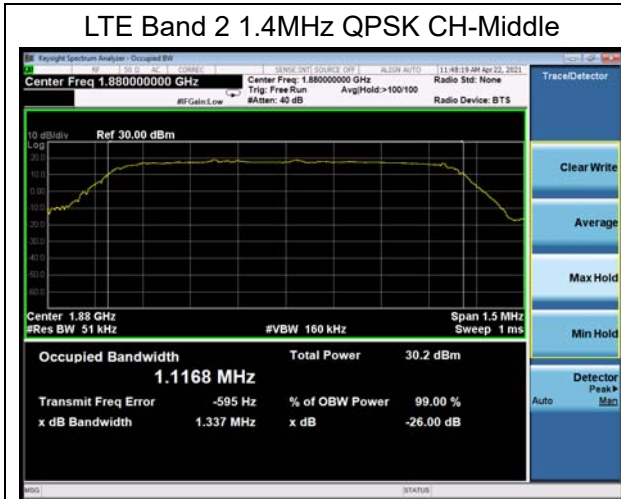



LTE Band 2 1.4MHz 16QAM CH-Middle



LTE Band 2 3MHz 16QAM CH-Middle



LTE Band 2 5MHz 16QAM CH-Middle



LTE Band 2 10MHz 16QAM CH-Middle



LTE Band 2 15MHz 16QAM CH-Middle



LTE Band 2 20MHz 16QAM CH-Middle





LTE Band 25 1.4MHz QPSK CH-Middle



LTE Band 25 3MHz QPSK CH-Middle



LTE Band 25 5MHz QPSK CH-Middle



LTE Band 25 10MHz QPSK CH-Middle



LTE Band 25 15MHz QPSK CH-Middle



LTE Band 25 20MHz QPSK CH-Middle





LTE Band 25 1.4MHz 16QAM CH-Middle



LTE Band 25 3MHz 16QAM CH-Middle



LTE Band 25 5MHz 16QAM CH-Middle

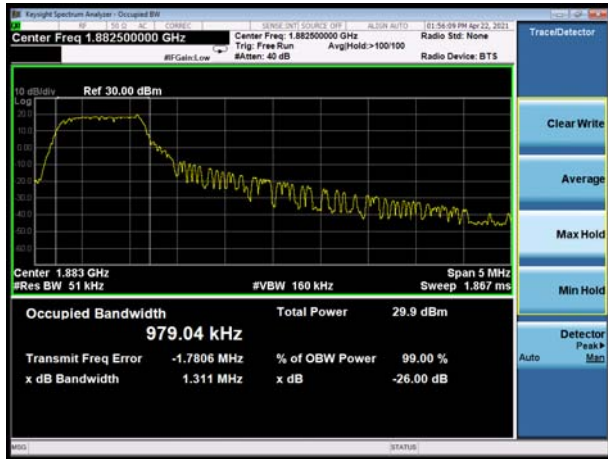

LTE Band 25 10MHz 16QAM CH-Middle



LTE Band 25 15MHz 16QAM CH-Middle



LTE Band 25 20MHz 16QAM CH-Middle

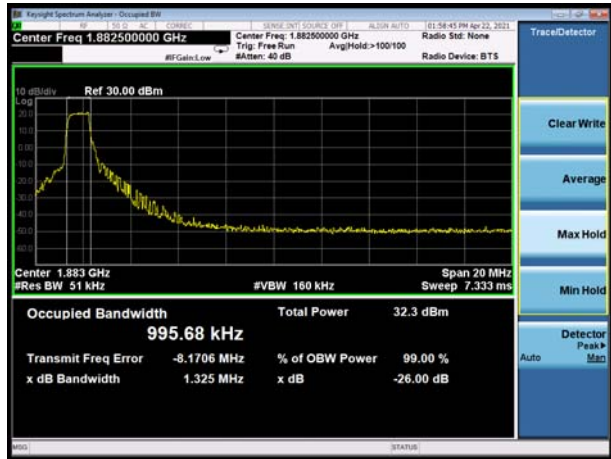

5.3. Band Edge Compliance

Ambient condition

Temperature	Relative humidity	Pressure
23°C ~25°C	45%~50%	101.5kPa

Method of Measurement

The EUT was connected to Spectrum Analyzer and Base Station Simulator via power Splitter. The band edge of the lowest and highest channels were measured. The Average detector is used and RBW is set to 51kHz, VBW is set to 160kHz for LTE Band 2/25. Spectrum analyzer plots are included on the following pages.

Test Setup

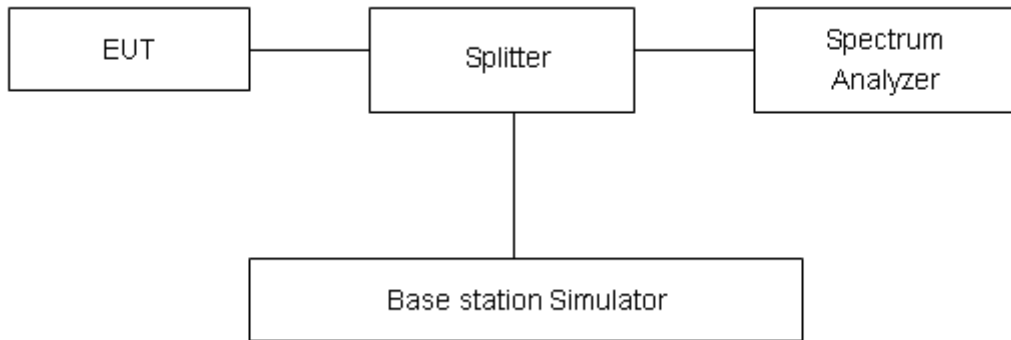

Limits

Rule Part 24.238(a) specifies that “on any frequency outside a licensee’s frequency block, the power of any emission shall be attenuated below the transmitter power (P) by at least $43 + 10 \log_{10} (P)$ dB.”

Limit	-13 dBm
-------	---------

Measurement Uncertainty

The assessed measurement uncertainty to ensure 95% confidence level for the normal distribution is with the coverage factor $k = 1.96$, $U=0.684$ dB.

Test Result:

LTE Band 2 1.4MHz QPSK 1RB CH-Low



LTE Band 2 1.4MHz QPSK 1RB CH-High

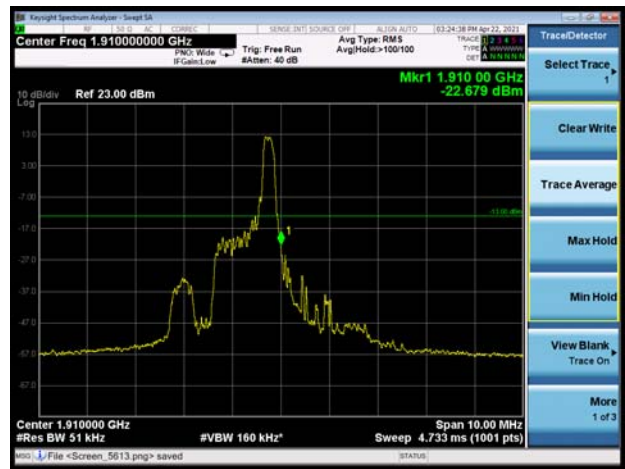

LTE Band 2 1.4MHz QPSK 100%RB CH-Low

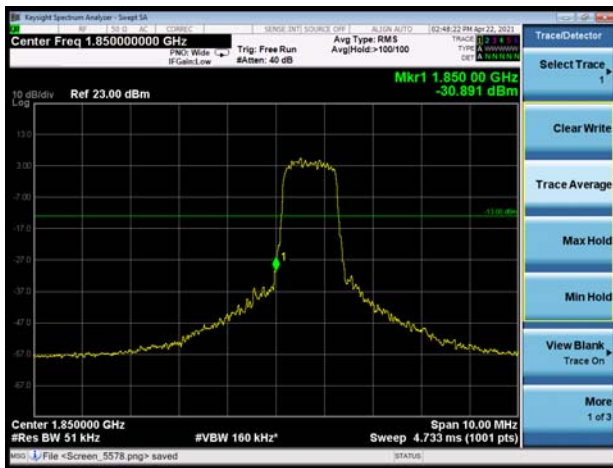

LTE Band 2 1.4MHz QPSK 100%RB CH-High

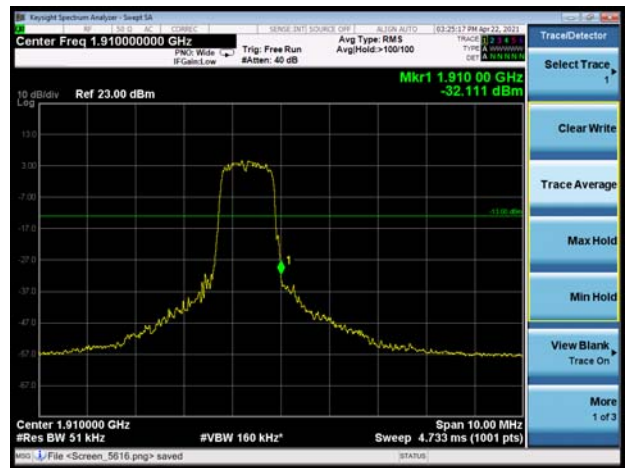

LTE Band 2 3MHz QPSK 1RB CH-Low



LTE Band 2 3MHz QPSK 1RB CH-High

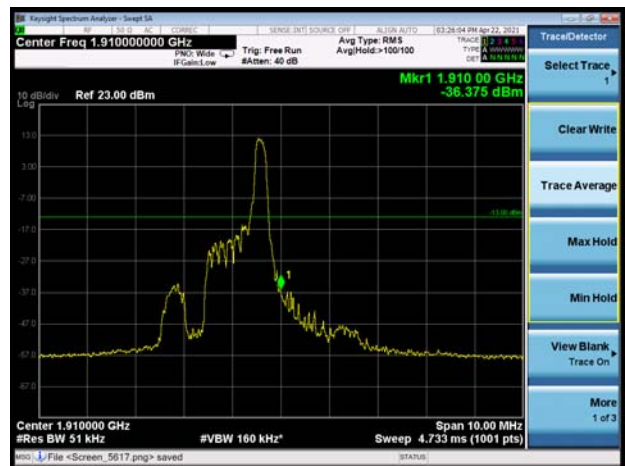

LTE Band 2 3MHz QPSK 100%RB CH-Low

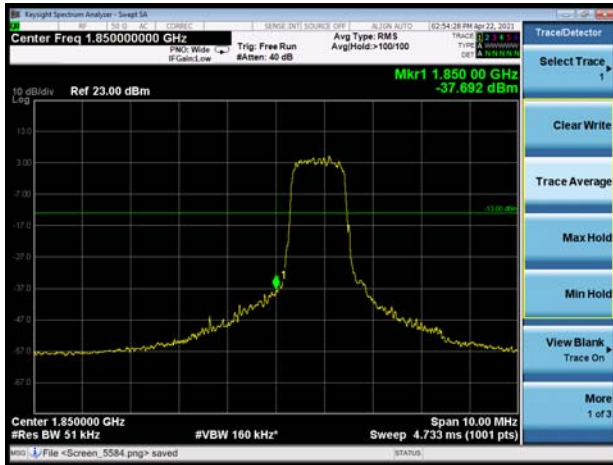

LTE Band 2 3MHz QPSK 100%RB CH-High

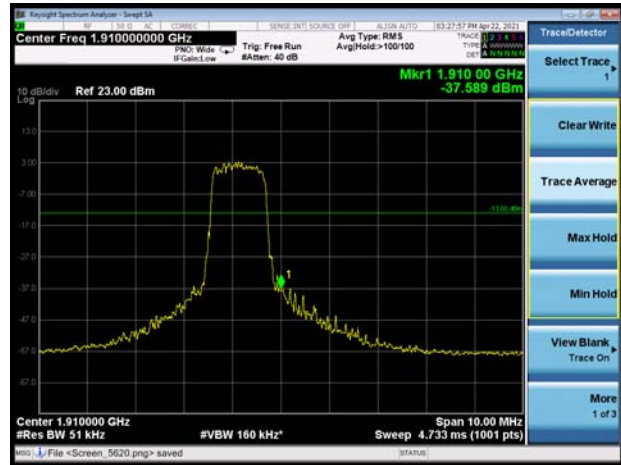

LTE Band 2 5MHz QPSK 1RB CH-Low



LTE Band 2 5MHz QPSK 1RB CH-High

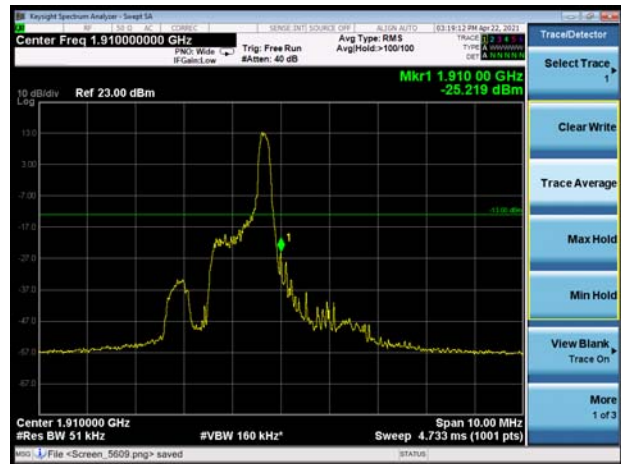

LTE Band 2 5MHz QPSK 100%RB CH-Low

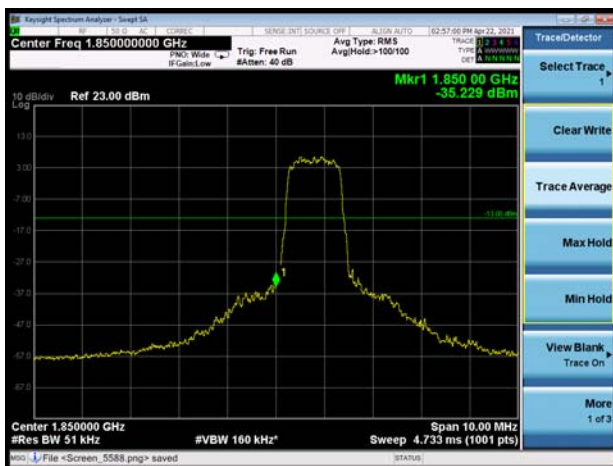

LTE Band 2 5MHz QPSK 100%RB CH-High

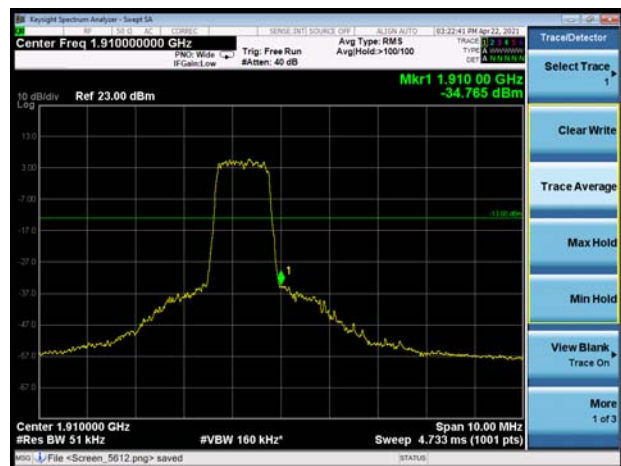

LTE Band 2 10MHz QPSK 1RB CH-Low



LTE Band 2 10MHz QPSK 1RB CH-High



LTE Band 2 10MHz QPSK 100%RB CH-Low

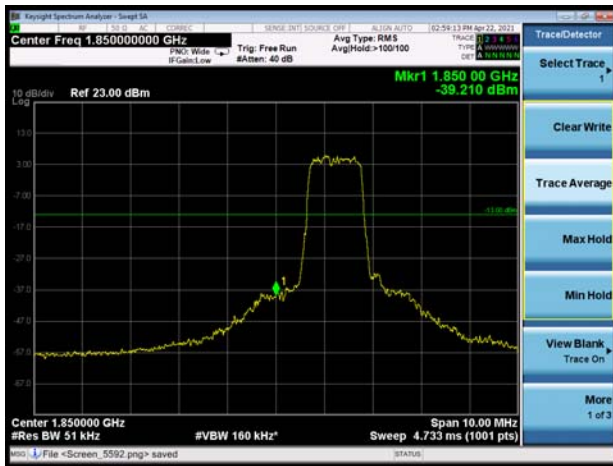

LTE Band 2 10MHz QPSK 100%RB CH-High

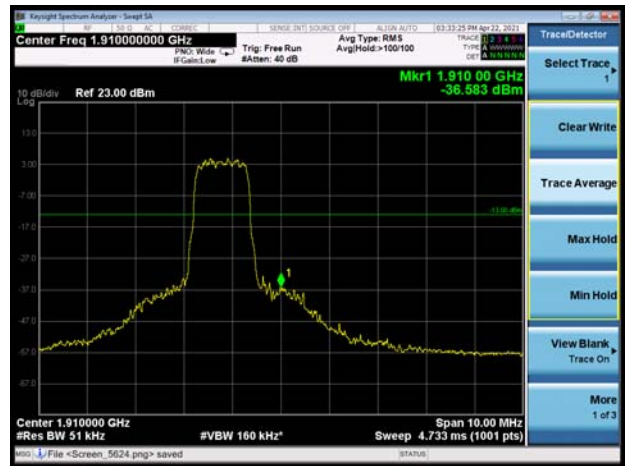

LTE Band 2 15MHz QPSK 1RB CH-Low



LTE Band 2 15MHz QPSK 1RB CH-High





LTE Band 2 15MHz QPSK 100%RB CH-Low

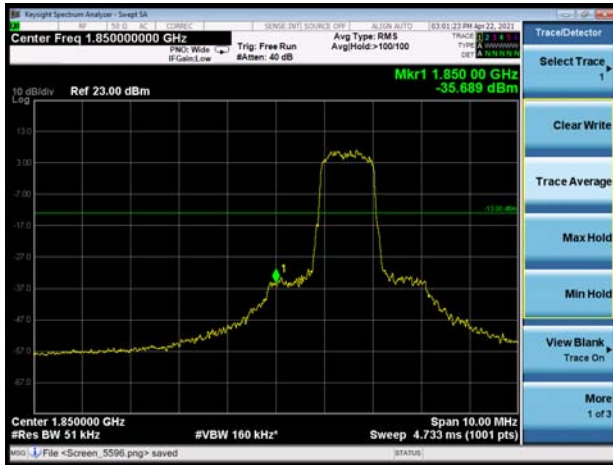

LTE Band 2 15MHz QPSK 100%RB CH-High

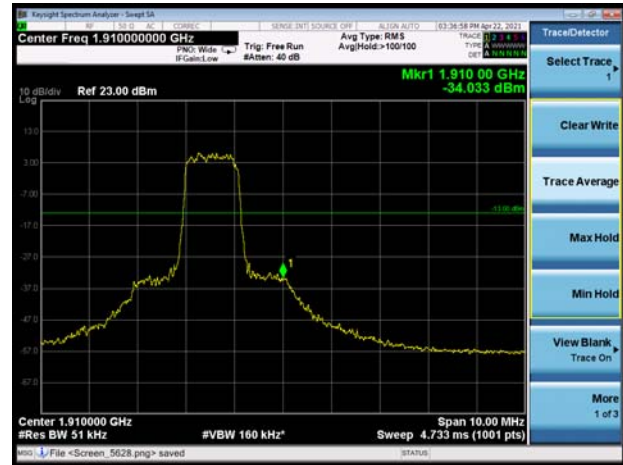

LTE Band 2 20MHz QPSK 1RB CH-Low



LTE Band 2 20MHz QPSK 1RB CH-High

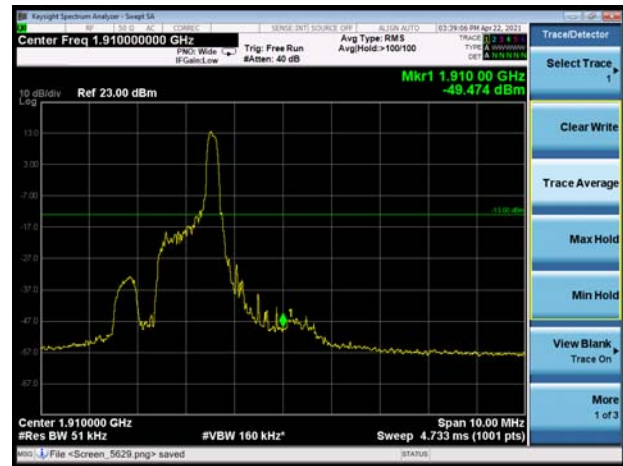

LTE Band 2 20MHz QPSK 100%RB CH-Low



LTE Band 2 20MHz QPSK 100%RB CH-High



LTE Band 2 1.4MHz 16QAM 1RB CH-Low



LTE Band 2 1.4MHz 16QAM 1RB CH-High

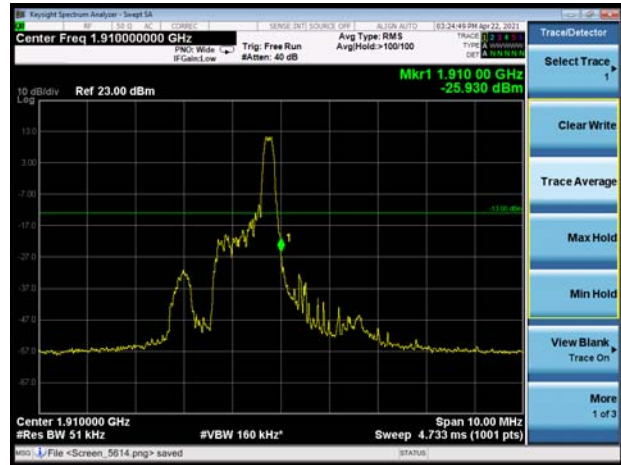

LTE Band 2 1.4MHz 16QAM 100%RB CH-Low

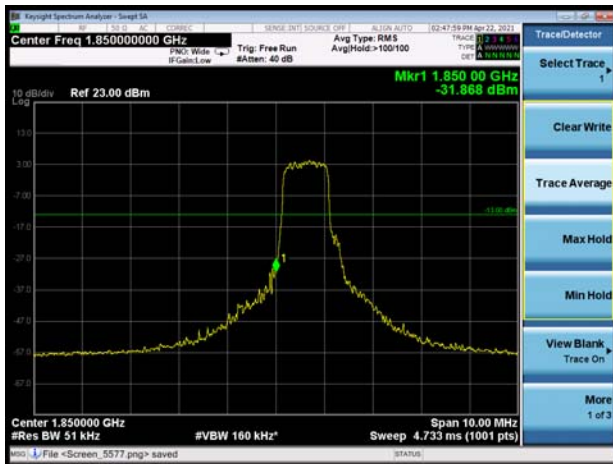

LTE Band 2 1.4MHz 16QAM 100%RB CH-High

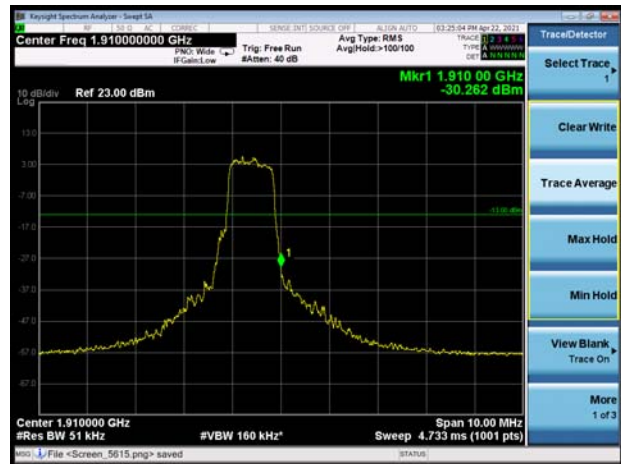

LTE Band 2 3MHz 16QAM 1RB CH-Low



LTE Band 2 3MHz 16QAM 1RB CH-High



LTE Band 2 3MHz 16QAM 100%RB CH-Low

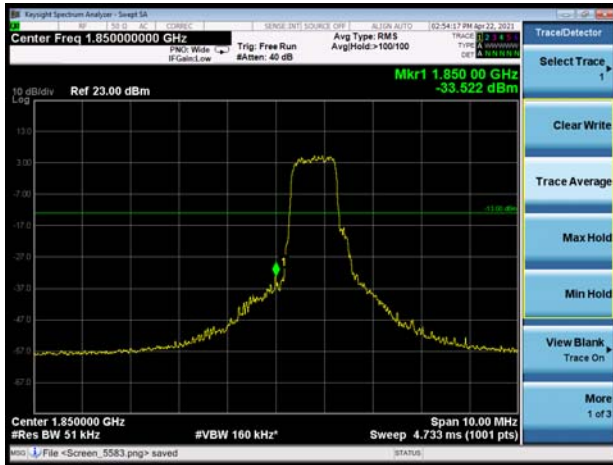

LTE Band 2 3MHz 16QAM 100%RB CH-High

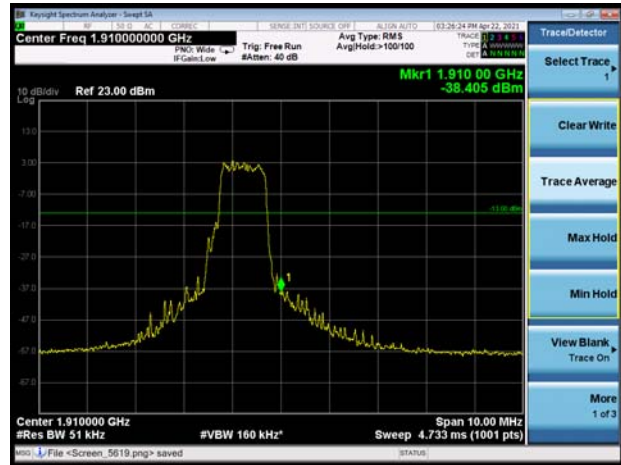

LTE Band 2 5MHz 16QAM 1RB CH-Low



LTE Band 2 5MHz 16QAM 1RB CH-High

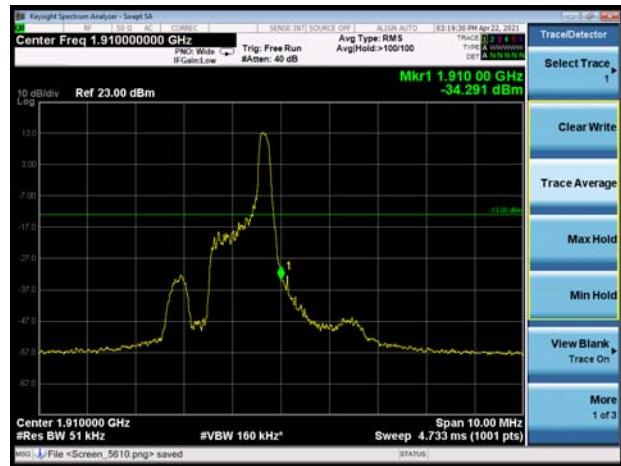

LTE Band 2 5MHz 16QAM 100%RB CH-Low

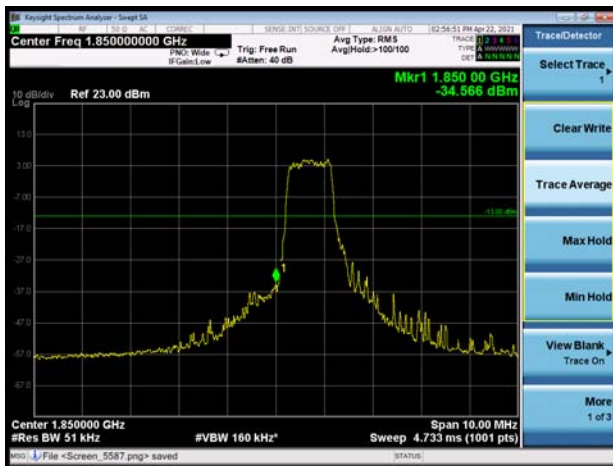

LTE Band 2 5MHz 16QAM 100%RB CH-High





LTE Band 2 10MHz 16QAM 1RB CH-Low



LTE Band 2 10MHz 16QAM 1RB CH-High

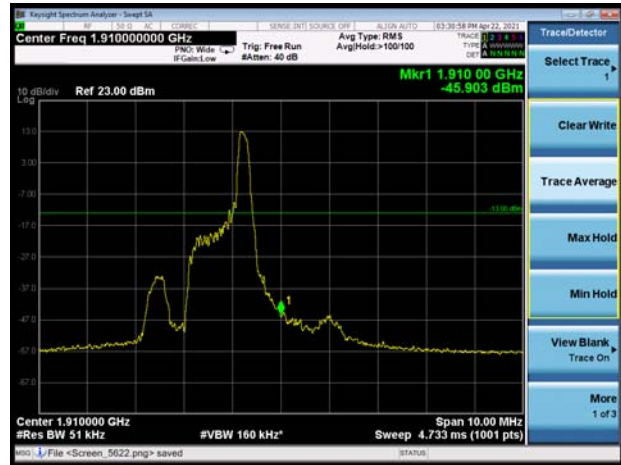

LTE Band 2 10MHz 16QAM 100%RB CH-Low

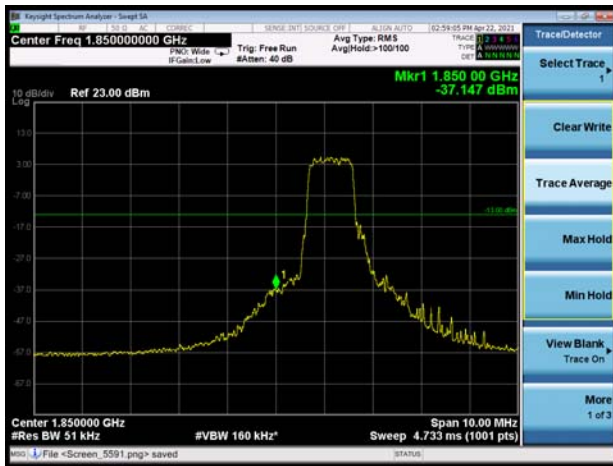

LTE Band 2 10MHz 16QAM 100%RB CH-High

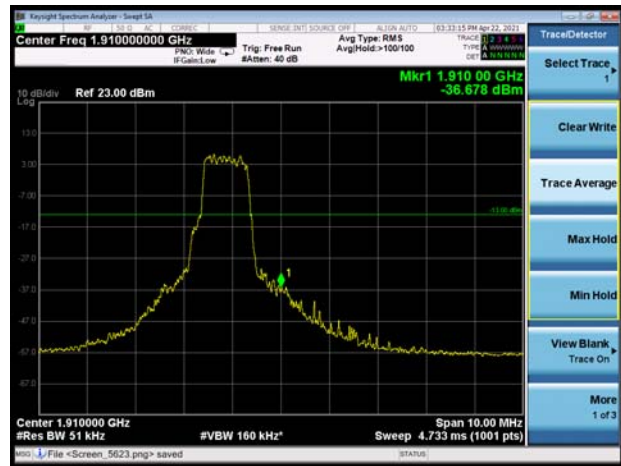

LTE Band 2 15MHz 16QAM 1RB CH-Low



LTE Band 2 15MHz 16QAM 1RB CH-High





LTE Band 2 15MHz 16QAM 100%RB CH-Low

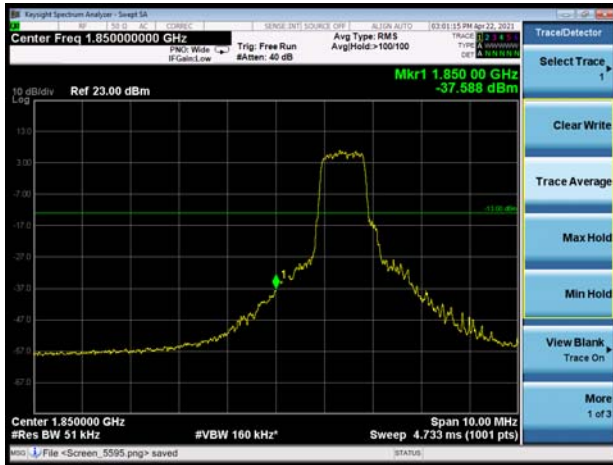

LTE Band 2 15MHz 16QAM 100%RB CH-High

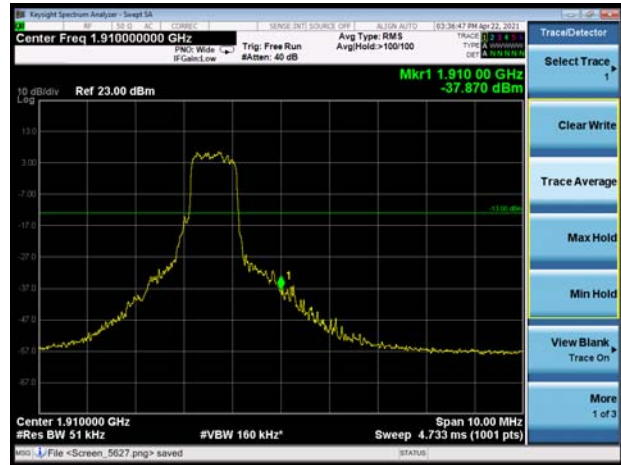

LTE Band 2 20MHz 16QAM 1RB CH-Low



LTE Band 2 20MHz 16QAM 1RB CH-High

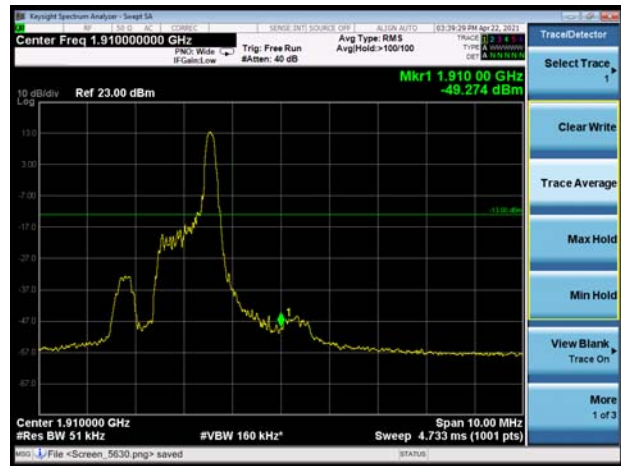

LTE Band 2 20MHz 16QAM 100%RB CH-Low



LTE Band 2 20MHz 16QAM 100%RB CH-High





LTE Band 25 1.4MHz QPSK 1RB CH-Low

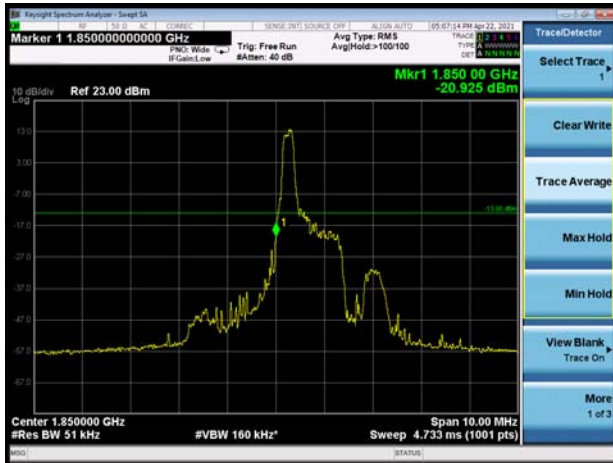

LTE Band 25 1.4MHz QPSK 1RB CH-High

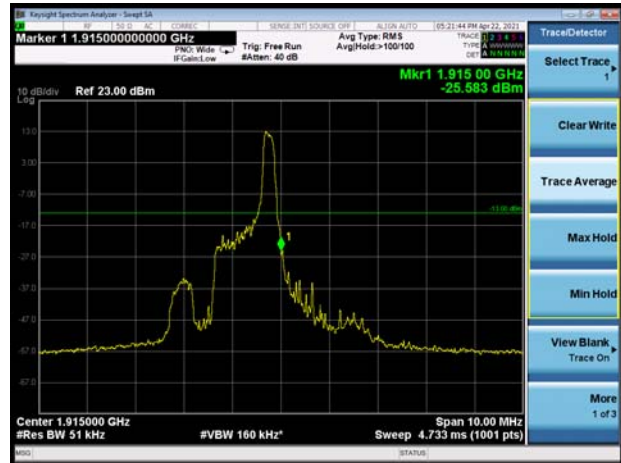

LTE Band 25 1.4MHz QPSK 100%RB CH-Low

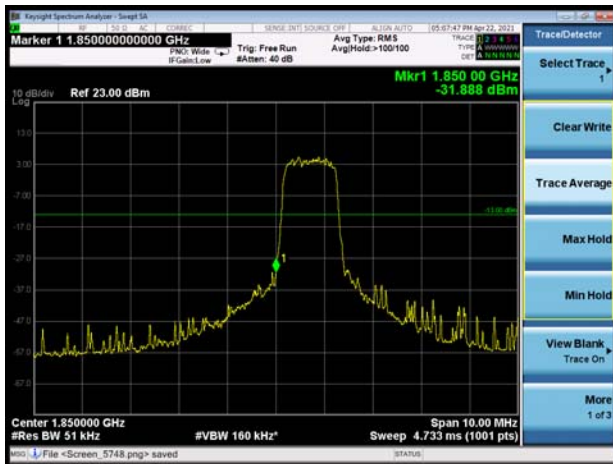

LTE Band 25 1.4MHz QPSK 100%RB CH-High

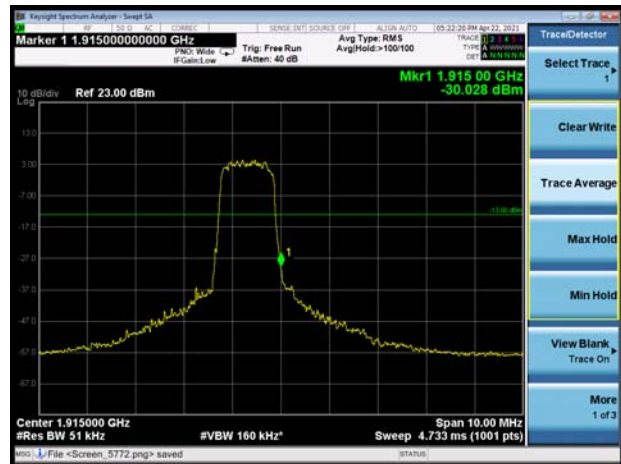

LTE Band 25 3MHz QPSK 1RB CH-Low



LTE Band 25 3MHz QPSK 1RB CH-High



LTE Band 25 3MHz QPSK 100%RB CH-Low

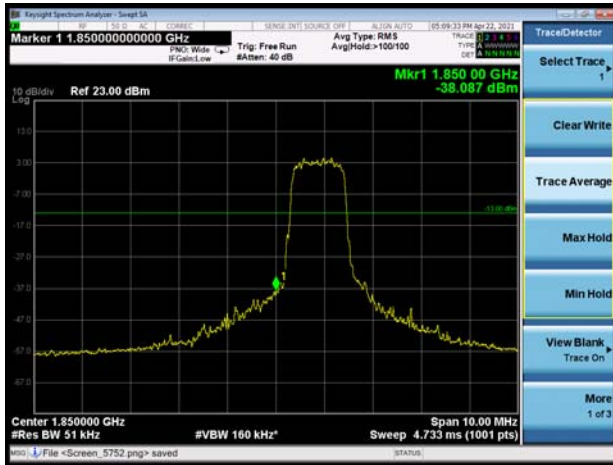

LTE Band 25 3MHz QPSK 100%RB CH-High

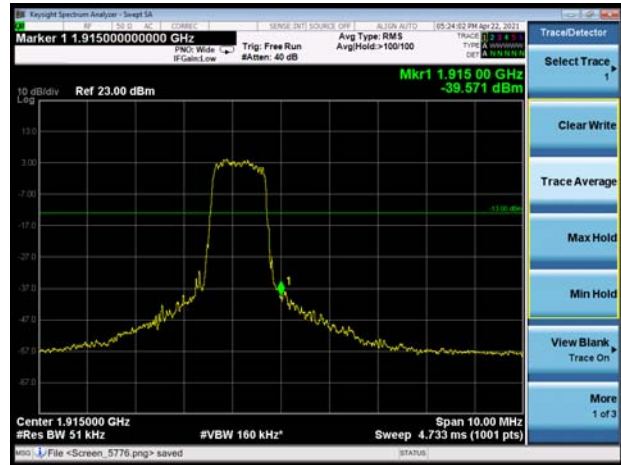

LTE Band 25 5MHz QPSK 1RB CH-Low



LTE Band 25 5MHz QPSK 1RB CH-High



LTE Band 25 5MHz QPSK 100%RB CH-Low

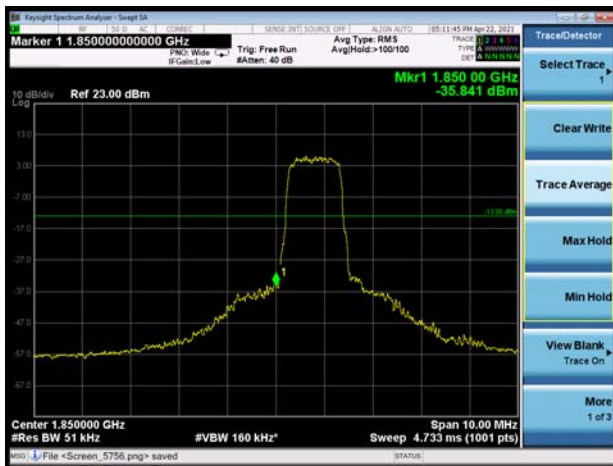

LTE Band 25 5MHz QPSK 100%RB CH-High

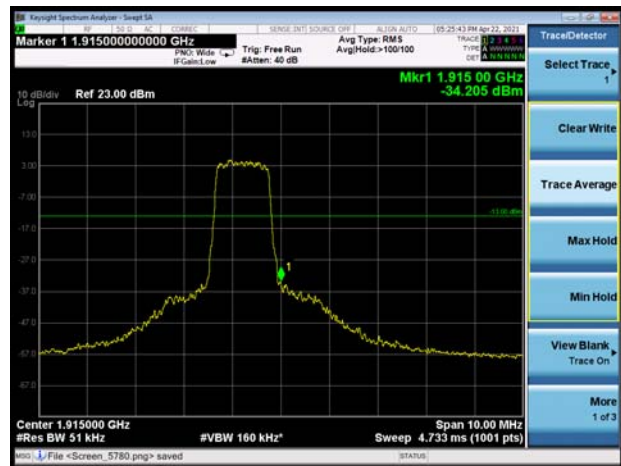



LTE Band 25 10MHz QPSK 1RB CH-Low



LTE Band 25 10MHz QPSK 1RB CH-High



LTE Band 25 10MHz QPSK 100%RB CH-Low

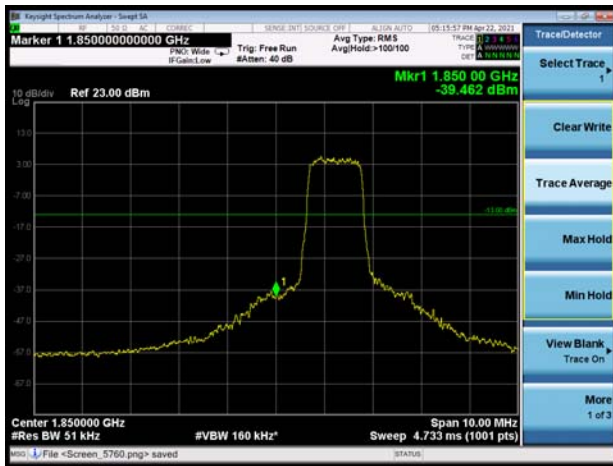

LTE Band 25 10MHz QPSK 100%RB CH-High

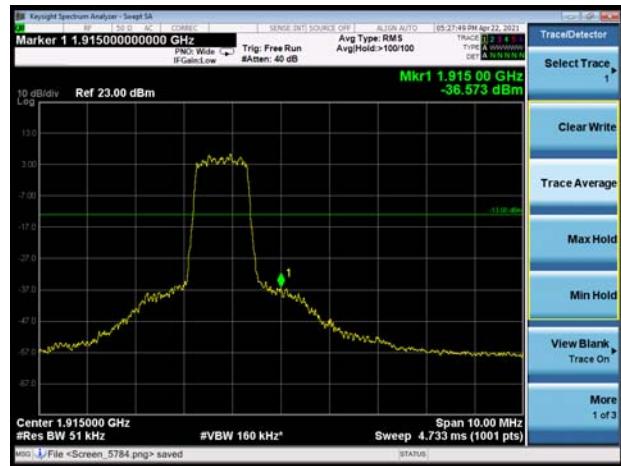

LTE Band 25 15MHz QPSK 1RB CH-Low



LTE Band 25 15MHz QPSK 1RB CH-High





LTE Band 25 15MHz QPSK 100%RB CH-Low

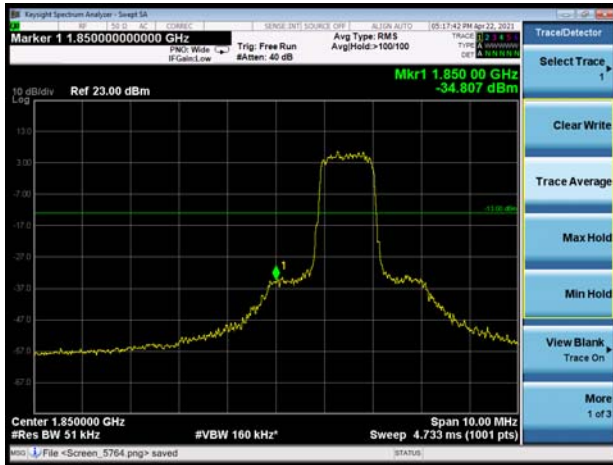

LTE Band 25 15MHz QPSK 100%RB CH-High



LTE Band 25 20MHz QPSK 1RB CH-Low



LTE Band 25 20MHz QPSK 1RB CH-High

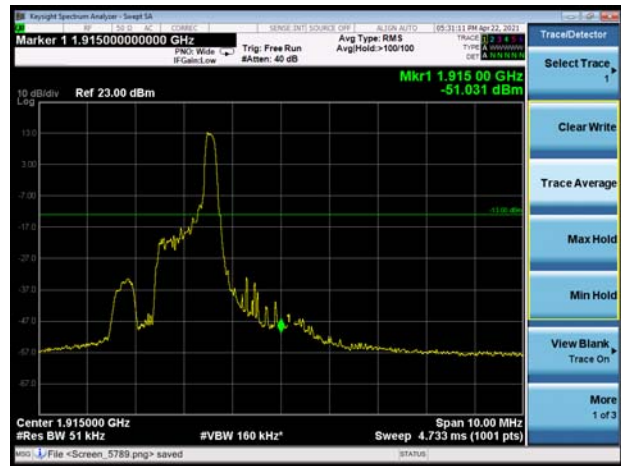

LTE Band 25 20MHz QPSK 100%RB CH-Low

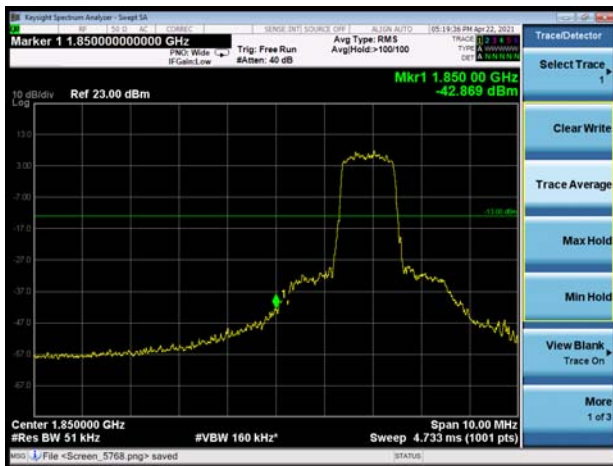

LTE Band 25 20MHz QPSK 100%RB CH-High





LTE Band 25 1.4MHz 16QAM 1RB CH-Low



LTE Band 25 1.4MHz 16QAM 1RB CH-High



LTE Band 25 1.4MHz 16QAM 100%RB CH-Low

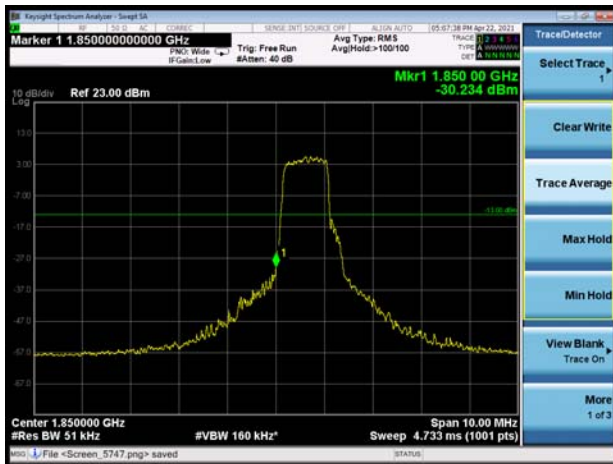

LTE Band 25 1.4MHz 16QAM 100%RB CH-High

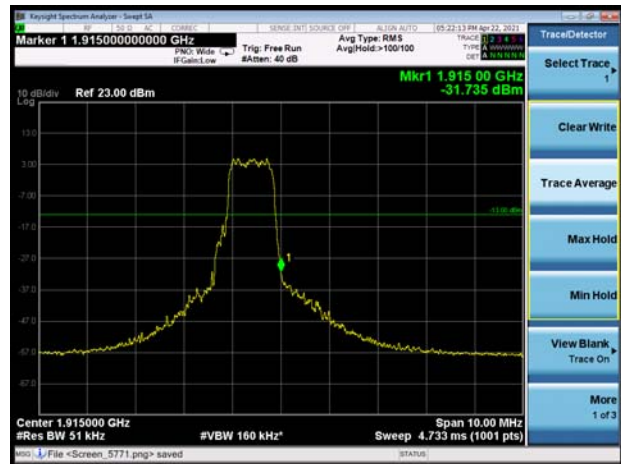

LTE Band 25 3MHz 16QAM 1RB CH-Low



LTE Band 25 3MHz 16QAM 1RB CH-High



LTE Band 25 3MHz 16QAM 100%RB CH-Low

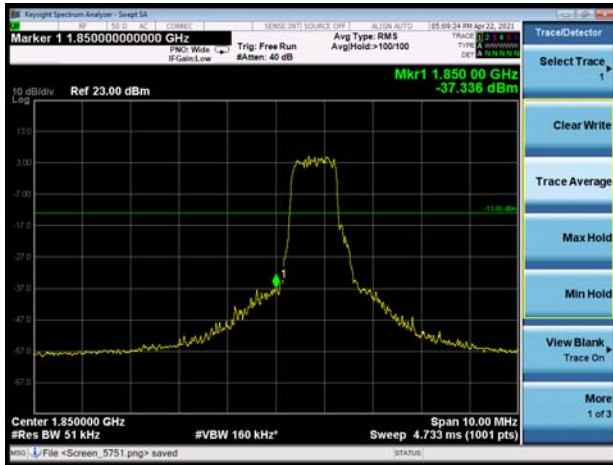

LTE Band 25 3MHz 16QAM 100%RB CH-High

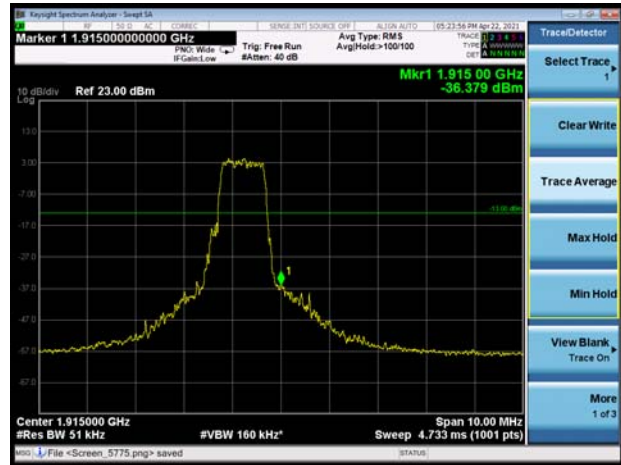

LTE Band 25 5MHz 16QAM 1RB CH-Low



LTE Band 25 5MHz 16QAM 1RB CH-High

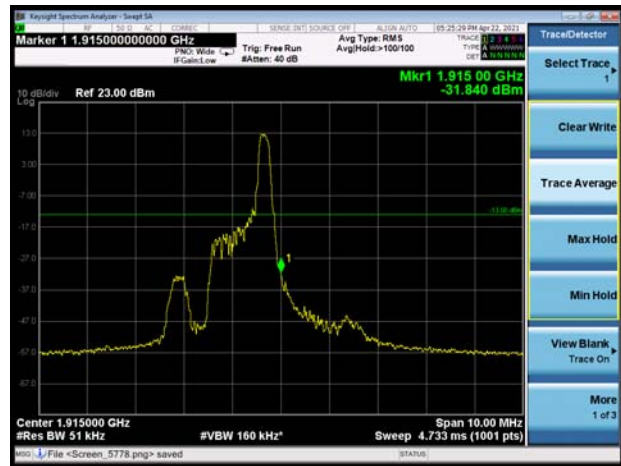

LTE Band 25 5MHz 16QAM 100%RB CH-Low

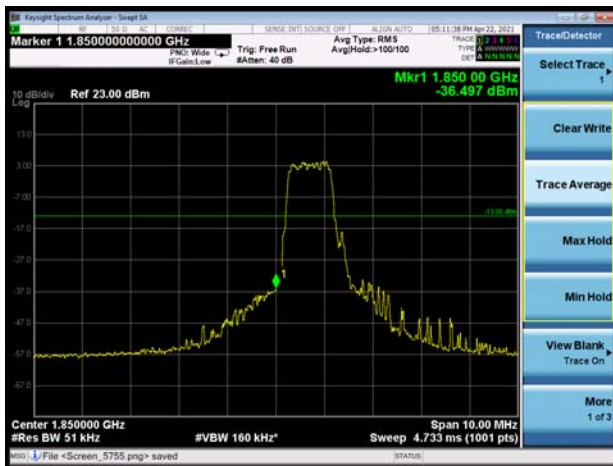

LTE Band 25 5MHz 16QAM 100%RB CH-High

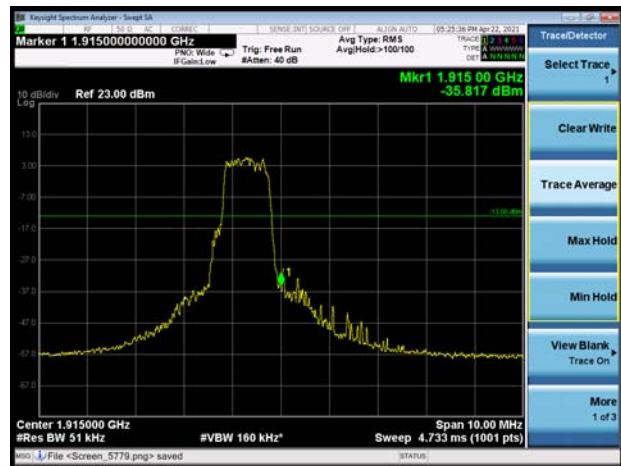



LTE Band 25 10MHz 16QAM 1RB CH-Low



LTE Band 25 10MHz 16QAM 1RB CH-High



LTE Band 25 10MHz 16QAM 100%RB CH-Low

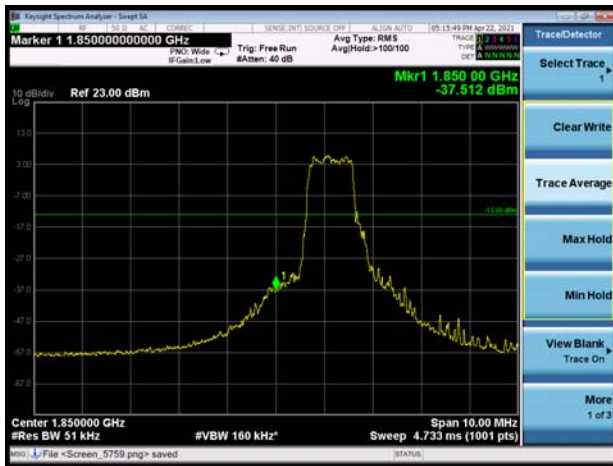

LTE Band 25 10MHz 16QAM 100%RB CH-High

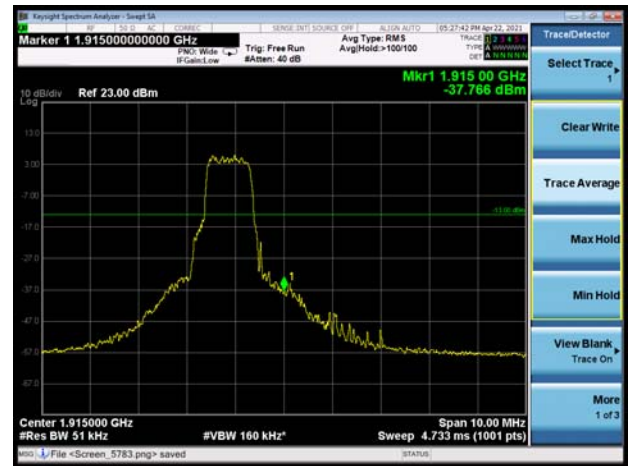

LTE Band 25 15MHz 16QAM 1RB CH-Low



LTE Band 25 15MHz 16QAM 1RB CH-High

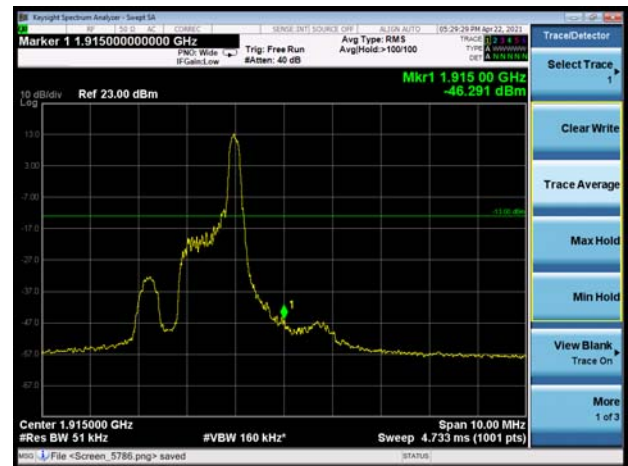



LTE Band 25 15MHz 16QAM 100%RB CH-Low

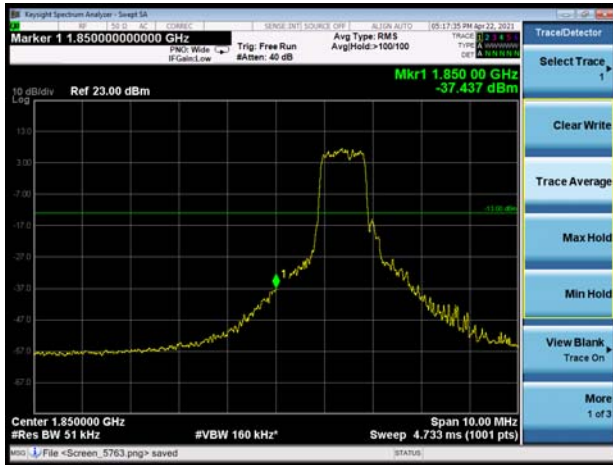

LTE Band 25 15MHz 16QAM 100%RB CH-High

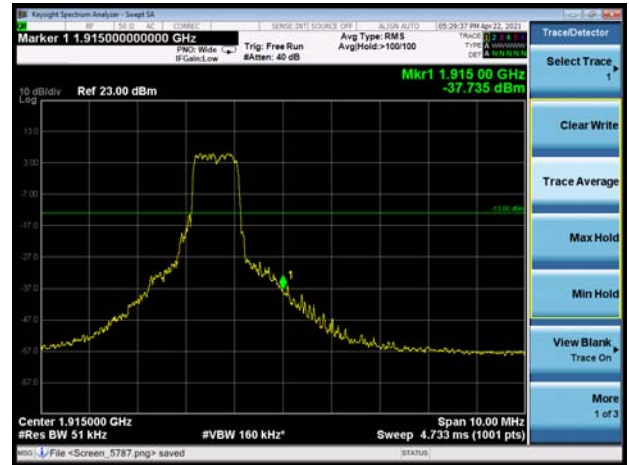

LTE Band 25 20MHz 16QAM 1RB CH-Low



LTE Band 25 20MHz 16QAM 1RB CH-High



LTE Band 25 20MHz 16QAM 100%RB CH-Low



LTE Band 25 20MHz 16QAM 100%RB CH-High



5.4. Peak-to-Average Power Ratio (PAPR)

Ambient condition

Temperature	Relative humidity	Pressure
23°C ~25°C	45%~50%	101.5kPa

Methods of Measurement

Measure the total peak power and record as PPk. And measure the total average power and record as PAvg. Both the peak and average power levels must be expressed in the same logarithmic units (e.g., dBm). Determine the PAPR from:

$$PAPR (dB) = PPk (dBm) - PAvg (dBm).$$

Test Setup

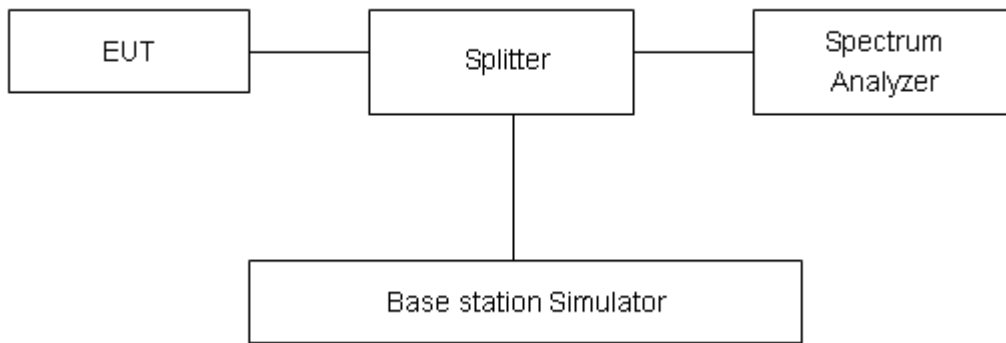

Limits

In measuring transmissions in this band using an average power technique, the peak-to-average ratio (PAR) of the transmission may not exceed 13 dB in 24.232(d).

Measurement Uncertainty

The assessed measurement uncertainty to ensure 95% confidence level for the normal distribution is with the coverage factor $k = 2$, $U = 0.4$ dB.

Test Results

Mode	Bandwidth	Modulation	Channel/ Frequency (MHz)	Peak-to-Average Power Ratio (PAPR)			Limit (dB)	Conclusion
				Peak (dBm)	Avg (dBm)	PAPR (dB)		
LTE Band 2	1.4MHz	QPSK	18900/1880	26.46	16.32	10.14	≤13	PASS
		16QAM	18900/1880	27.07	15.87	11.20	≤13	PASS
	3MHz	QPSK	18900/1880	26.34	16.18	10.16	≤13	PASS
		16QAM	18900/1880	27.06	15.89	11.17	≤13	PASS
	5MHz	QPSK	18900/1880	27.27	17.54	9.73	≤13	PASS
		16QAM	18900/1880	27.16	16.22	10.94	≤13	PASS
	10MHz	QPSK	18900/1880	27.16	17.18	9.98	≤13	PASS
		16QAM	18900/1880	27.65	16.76	10.89	≤13	PASS
	15MHz	QPSK	18900/1880	27.83	18.48	9.35	≤13	PASS
		16QAM	18900/1880	28.14	18.08	10.06	≤13	PASS
	20MHz	QPSK	18900/1880	27.83	18.49	9.34	≤13	PASS
		16QAM	18900/1880	28.18	18.12	10.06	≤13	PASS

Mode	Bandwidth	Modulation	Channel/ Frequency (MHz)	Peak-to-Average Power Ratio (PAPR)			Limit (dB)	Conclusion
				Peak (dBm)	Avg (dBm)	PAPR (dB)		
LTE Band 25	1.4MHz	QPSK	26365/1882.5	26.53	16.45	10.08	≤13	PASS
		16QAM	26365/1882.5	27.02	16.04	10.98	≤13	PASS
	3MHz	QPSK	26365/1882.5	26.31	16.01	10.30	≤13	PASS
		16QAM	26365/1882.5	27.04	16.02	11.02	≤13	PASS
	5MHz	QPSK	26365/1882.5	27.26	17.29	9.97	≤13	PASS
		16QAM	26365/1882.5	27.08	16.06	11.02	≤13	PASS
	10MHz	QPSK	26365/1882.5	27.24	17.71	9.53	≤13	PASS
		16QAM	26365/1882.5	27.72	17.27	10.45	≤13	PASS
	15MHz	QPSK	26365/1882.5	27.82	18.83	8.99	≤13	PASS
		16QAM	26365/1882.5	28.19	18.56	9.63	≤13	PASS
	20MHz	QPSK	26365/1882.5	27.76	18.03	9.73	≤13	PASS
		16QAM	26365/1882.5	28.17	18.48	9.69	≤13	PASS

5.5. Frequency Stability

Ambient condition

Temperature	Relative humidity	Pressure
23°C ~25°C	45%~50%	101.5kPa

Method of Measurement

Frequency Stability (Temperature Variation)

The temperature inside the climate chamber is varied from -30°C to +50°C in 10°C step size,

(1) With all power removed, the temperature was decreased to 0°C and permitted to stabilize for three hours.

(2) Measure the carrier frequency with the test equipment in a “call mode”. These measurements should be made within 1 minute of powering up the mobile station, to prevent significant self warming.

(3) Repeat the above measurements at 10°C increments from -30°C to +50°C. Allow at least 1.5 hours at each temperature, un-powered, before making measurements.

Frequency Stability (Voltage Variation)

The frequency stability shall be measured with variation of primary supply voltage as follows:

Primary Supply Voltage: The primary supply voltage is varied from 85% to 115% of the nominal value for non hand-carried battery and AC powered equipment. For hand-carried, battery-powered equipment, primary supply voltage is reduced to the battery operating end point which shall be specified by the manufacturer.

This transceiver is specified to operate with an input voltage of between 3.1 V and 4.2 V, with a nominal voltage of 3.3V.

Test setup

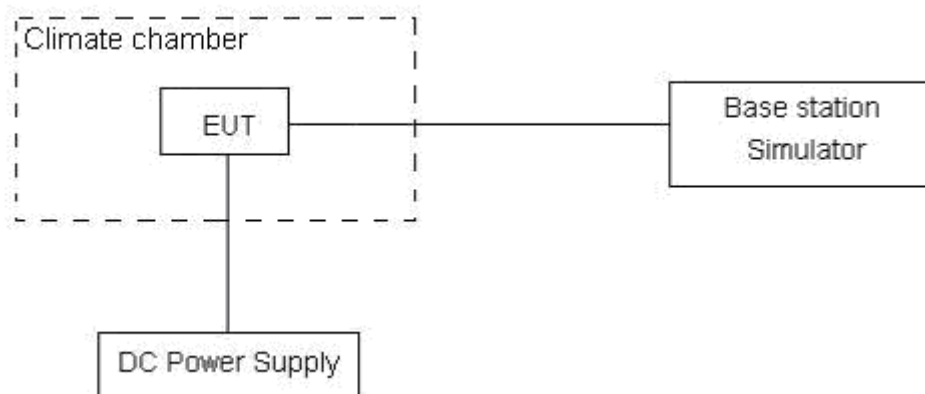

**Limits**

The frequency stability shall be sufficient to ensure that the fundamental emission stays within the authorized frequency block

Measurement Uncertainty

The assessed measurement uncertainty to ensure 99.75% confidence level for the normal distribution is with the coverage factor $k = 3$, $U = 0.01\text{ppm}$.



Test Result

LTE Band 2						
Condition		Freq.Error (Hz)	Freq.Error (Hz)	Frequency Stability (ppm)	Frequency Stability (ppm)	Verdict
BANDWIDTH	1.4MHz	16QAM	QPSK	16QAM	QPSK	
Temperature	Voltage					
Normal (25°C)	Normal	4.99	6.64	0.00265	0.00353	PASS
Extreme (50°C)		16.90	15.14	0.00899	0.00805	PASS
Extreme (40°C)		11.55	9.42	0.00614	0.00501	PASS
Extreme (30°C)		7.19	17.81	0.00383	0.00947	PASS
Extreme (20°C)		3.28	11.02	0.00175	0.00586	PASS
Extreme (10°C)		17.05	5.21	0.00907	0.00277	PASS
Extreme (0°C)		8.89	16.47	0.00473	0.00876	PASS
Extreme (-10°C)		6.66	6.91	0.00354	0.00368	PASS
Extreme (-20°C)		4.51	8.54	0.00240	0.00454	PASS
Extreme (-30°C)		12.60	8.39	0.00670	0.00446	PASS
25°C	LV	16.04	3.79	0.00853	0.00202	PASS
	HV	17.52	11.09	0.00932	0.00590	PASS
Condition		Freq.Error (Hz)	Freq.Error (Hz)	Frequency Stability (ppm)	Frequency Stability (ppm)	Verdict
BANDWIDTH	3MHz	16QAM	QPSK	16QAM	QPSK	
Temperature	Voltage					
Normal (25°C)	Normal	13.04	3.21	0.00694	0.00171	PASS
Extreme (50°C)		8.73	8.99	0.00464	0.00478	PASS
Extreme (40°C)		6.30	7.87	0.00335	0.00418	PASS
Extreme (30°C)		11.49	5.87	0.00611	0.00312	PASS
Extreme (20°C)		2.86	14.04	0.00152	0.00747	PASS
Extreme (10°C)		7.48	8.90	0.00398	0.00474	PASS
Extreme (0°C)		11.13	15.08	0.00592	0.00802	PASS
Extreme (-10°C)		8.23	6.81	0.00438	0.00362	PASS
Extreme (-20°C)		1.31	6.17	0.00070	0.00328	PASS
Extreme (-30°C)		15.63	17.84	0.00831	0.00949	PASS
25°C	LV	15.61	3.27	0.00830	0.00174	PASS
	HV	5.65	2.21	0.00301	0.00118	PASS
Condition		Freq.Error (Hz)	Freq.Error (Hz)	Frequency Stability (ppm)	Frequency Stability (ppm)	Verdict
BANDWIDTH	5MHz	16QAM	QPSK	16QAM	QPSK	
Temperature	Voltage					
Normal (25°C)	Normal	2.39	6.78	0.00127	0.00361	PASS
Extreme (50°C)		8.47	15.44	0.00450	0.00821	PASS



Extreme (40°C)		2.23	14.48	0.00119	0.00770	PASS
Extreme (30°C)		4.35	16.98	0.00231	0.00903	PASS
Extreme (20°C)		2.69	1.63	0.00143	0.00087	PASS
Extreme (10°C)		9.01	11.18	0.00479	0.00594	PASS
Extreme (0°C)		5.02	5.42	0.00267	0.00288	PASS
Extreme (-10°C)		15.95	2.00	0.00848	0.00106	PASS
Extreme (-20°C)		13.85	10.14	0.00737	0.00539	PASS
Extreme (-30°C)		6.11	9.35	0.00325	0.00497	PASS
25°C	LV	16.44	6.79	0.00874	0.00361	PASS
	HV	2.37	17.72	0.00126	0.00943	PASS
Condition		Freq.Error (Hz)	Freq.Error (Hz)	Frequency Stability (ppm)	Frequency Stability (ppm)	Verdict
BANDWIDTH	10MHz					
Temperature	Voltage	16QAM	QPSK	16QAM	QPSK	
Normal (25°C)	Normal	9.59	6.44	0.00510	0.00342	PASS
Extreme (50°C)		11.48	7.75	0.00610	0.00412	PASS
Extreme (40°C)		15.50	11.11	0.00825	0.00591	PASS
Extreme (30°C)		15.91	6.82	0.00846	0.00363	PASS
Extreme (20°C)		1.34	2.68	0.00071	0.00143	PASS
Extreme (10°C)		17.23	10.52	0.00917	0.00560	PASS
Extreme (0°C)		12.30	4.54	0.00654	0.00241	PASS
Extreme (-10°C)		12.03	4.50	0.00640	0.00240	PASS
Extreme (-20°C)		9.97	4.88	0.00530	0.00259	PASS
Extreme (-30°C)		14.86	10.65	0.00790	0.00567	PASS
25°C	LV	10.21	11.65	0.00543	0.00619	PASS
	HV	10.99	2.74	0.00584	0.00146	PASS
Condition		Freq.Error (Hz)	Freq.Error (Hz)	Frequency Stability (ppm)	Frequency Stability (ppm)	Verdict
BANDWIDTH	15MHz					
Temperature	Voltage	16QAM	QPSK	16QAM	QPSK	
Normal (25°C)	Normal	8.80	1.87	0.00468	0.00100	PASS
Extreme (50°C)		13.92	6.10	0.00740	0.00324	PASS
Extreme (40°C)		14.98	10.07	0.00797	0.00535	PASS
Extreme (30°C)		15.66	2.19	0.00833	0.00117	PASS
Extreme (20°C)		11.85	11.65	0.00630	0.00620	PASS
Extreme (10°C)		4.95	13.11	0.00263	0.00698	PASS
Extreme (0°C)		4.60	2.87	0.00245	0.00153	PASS
Extreme (-10°C)		2.34	7.73	0.00125	0.00411	PASS
Extreme (-20°C)		7.52	16.10	0.00400	0.00856	PASS
Extreme (-30°C)		1.65	12.45	0.00088	0.00662	PASS
25°C	LV	11.29	17.05	0.00601	0.00907	PASS



Condition		Freq.Error (Hz)	Freq.Error (Hz)	Frequency Stability (ppm)	Frequency Stability (ppm)	Verdict
BANDWIDTH	20MHz					
Temperature	Voltage	16QAM	QPSK	16QAM	QPSK	
Normal (25°C)	Normal	17.74	5.43	0.00944	0.00289	PASS
Extreme (50°C)		8.63	4.01	0.00459	0.00213	PASS
Extreme (40°C)		4.24	17.00	0.00225	0.00904	PASS
Extreme (30°C)		15.47	6.27	0.00823	0.00334	PASS
Extreme (20°C)		17.49	12.65	0.00930	0.00673	PASS
Extreme (10°C)		3.61	1.49	0.00192	0.00079	PASS
Extreme (0°C)		13.24	10.73	0.00704	0.00571	PASS
Extreme (-10°C)		15.18	11.18	0.00808	0.00595	PASS
Extreme (-20°C)		16.15	2.08	0.00859	0.00110	PASS
Extreme (-30°C)		16.12	10.42	0.00857	0.00554	PASS
25°C	LV	6.07	17.93	0.00323	0.00953	PASS
	HV	13.93	6.61	0.00741	0.00352	PASS

LTE Band 25						
Condition		Freq.Error (Hz)	Freq.Error (Hz)	Frequency Stability (ppm)	Frequency Stability (ppm)	Verdict
BANDWIDTH	1.4MHz					
Temperature	Voltage	16QAM	QPSK	16QAM	QPSK	
Normal (25°C)	Normal	16.14	10.59	0.00859	0.00563	PASS
Extreme (50°C)		13.94	3.33	0.00741	0.00177	PASS
Extreme (40°C)		5.67	3.86	0.00302	0.00205	PASS
Extreme (30°C)		11.26	9.34	0.00599	0.00497	PASS
Extreme (20°C)		2.70	4.91	0.00144	0.00261	PASS
Extreme (10°C)		9.11	16.83	0.00485	0.00895	PASS
Extreme (0°C)		5.18	10.74	0.00275	0.00571	PASS
Extreme (-10°C)		14.65	6.30	0.00779	0.00335	PASS
Extreme (-20°C)		7.91	10.43	0.00421	0.00555	PASS
Extreme (-30°C)		10.28	5.75	0.00547	0.00306	PASS
25°C	LV	11.07	17.55	0.00589	0.00934	PASS
	HV	17.69	1.66	0.00941	0.00089	PASS
Condition		Freq.Error (Hz)	Freq.Error (Hz)	Frequency Stability (ppm)	Frequency Stability (ppm)	Verdict
BANDWIDTH	3MHz					
Temperature	Voltage	16QAM	QPSK	16QAM	QPSK	



Normal (25°C)	Normal	15.51	9.17	0.00825	0.00488	PASS
Extreme (50°C)		13.10	3.10	0.00697	0.00165	PASS
Extreme (40°C)		5.61	12.80	0.00298	0.00681	PASS
Extreme (30°C)		15.64	11.92	0.00832	0.00634	PASS
Extreme (20°C)		14.20	1.37	0.00756	0.00073	PASS
Extreme (10°C)		3.04	15.83	0.00162	0.00842	PASS
Extreme (0°C)		6.94	7.01	0.00369	0.00373	PASS
Extreme (-10°C)		1.07	18.00	0.00057	0.00957	PASS
Extreme (-20°C)		7.38	3.94	0.00393	0.00210	PASS
Extreme (-30°C)		2.91	17.90	0.00155	0.00952	PASS
25°C		LV	9.10	16.01	0.00484	0.00851
	HV	9.23	13.20	0.00491	0.00702	PASS
Condition		Freq.Error (Hz)	Freq.Error (Hz)	Frequency Stability (ppm)	Frequency Stability (ppm)	Verdict
BANDWIDTH	5MHz					
Temperature	Voltage	16QAM	QPSK	16QAM	QPSK	
Normal (25°C)	Normal	3.98	6.84	0.00212	0.00364	PASS
Extreme (50°C)		14.43	15.84	0.00767	0.00843	PASS
Extreme (40°C)		15.94	16.07	0.00848	0.00855	PASS
Extreme (30°C)		14.05	2.61	0.00748	0.00139	PASS
Extreme (20°C)		9.86	10.39	0.00524	0.00553	PASS
Extreme (10°C)		9.89	14.40	0.00526	0.00766	PASS
Extreme (0°C)		16.75	1.23	0.00891	0.00066	PASS
Extreme (-10°C)		6.48	11.10	0.00345	0.00590	PASS
Extreme (-20°C)		7.92	6.07	0.00421	0.00323	PASS
Extreme (-30°C)		6.60	16.25	0.00351	0.00865	PASS
25°C		LV	2.55	13.25	0.00135	0.00705
	HV	7.53	9.49	0.00401	0.00505	PASS
Condition		Freq.Error (Hz)	Freq.Error (Hz)	Frequency Stability (ppm)	Frequency Stability (ppm)	Verdict
BANDWIDTH	10MHz					
Temperature	Voltage	16QAM	QPSK	16QAM	QPSK	
Normal (25°C)	Normal	8.03	7.47	0.00427	0.00398	PASS
Extreme (50°C)		7.96	16.33	0.00423	0.00869	PASS
Extreme (40°C)		6.80	10.96	0.00362	0.00583	PASS
Extreme (30°C)		9.12	9.09	0.00485	0.00484	PASS
Extreme (20°C)		13.30	8.67	0.00708	0.00461	PASS
Extreme (10°C)		15.02	6.97	0.00799	0.00371	PASS
Extreme (0°C)		12.36	14.49	0.00657	0.00771	PASS
Extreme (-10°C)		7.47	15.85	0.00397	0.00843	PASS
Extreme (-20°C)		7.03	13.31	0.00374	0.00708	PASS
Extreme (-30°C)		17.12	10.93	0.00911	0.00581	PASS



25°C	LV	16.59	4.27	0.00883	0.00227	PASS
	HV	12.39	8.85	0.00659	0.00471	PASS
Condition		Freq.Error (Hz)	Freq.Error (Hz)	Frequency Stability (ppm)	Frequency Stability (ppm)	Verdict
BANDWIDTH	15MHz					
Temperature	Voltage	16QAM	QPSK	16QAM	QPSK	
Normal (25°C)	Normal	3.80	12.34	0.00202	0.00656	
Extreme (50°C)		17.66	5.63	0.00940	0.00299	PASS
Extreme (40°C)		14.95	14.67	0.00795	0.00780	PASS
Extreme (30°C)		15.32	17.86	0.00815	0.00950	PASS
Extreme (20°C)		2.97	1.69	0.00158	0.00090	PASS
Extreme (10°C)		3.05	17.36	0.00162	0.00924	PASS
Extreme (0°C)		13.29	2.76	0.00707	0.00147	PASS
Extreme (-10°C)		4.48	6.57	0.00239	0.00350	PASS
Extreme (-20°C)		5.58	17.89	0.00297	0.00951	PASS
Extreme (-30°C)		1.89	7.12	0.00100	0.00379	PASS
25°C	LV	14.90	2.51	0.00793	0.00133	PASS
	HV	15.64	17.48	0.00832	0.00930	PASS
Condition		Freq.Error (Hz)	Freq.Error (Hz)	Frequency Stability (ppm)	Frequency Stability (ppm)	Verdict
BANDWIDTH	20MHz					
Temperature	Voltage	16QAM	QPSK	16QAM	QPSK	
Normal (25°C)	Normal	8.07	10.97	0.00429	0.00583	
Extreme (50°C)		17.14	16.36	0.00912	0.00870	PASS
Extreme (40°C)		11.20	17.54	0.00596	0.00933	PASS
Extreme (30°C)		2.85	1.24	0.00152	0.00066	PASS
Extreme (20°C)		10.05	8.75	0.00534	0.00466	PASS
Extreme (10°C)		13.48	14.89	0.00717	0.00792	PASS
Extreme (0°C)		13.58	5.71	0.00722	0.00304	PASS
Extreme (-10°C)		6.39	13.97	0.00340	0.00743	PASS
Extreme (-20°C)		5.88	3.45	0.00313	0.00183	PASS
Extreme (-30°C)		17.95	2.72	0.00955	0.00145	PASS
25°C	LV	12.28	1.01	0.00653	0.00054	PASS
	HV	3.74	10.42	0.00199	0.00554	PASS

5.6. Spurious Emissions at Antenna Terminals

Ambient condition

Temperature	Relative humidity	Pressure
23°C ~25°C	45%~50%	101.5kPa

Method of Measurement

The EUT was connected to Spectrum Analyzer and Base Station Simulator via power Splitter. The measurement is carried out using a spectrum analyzer. The spectrum analyzer scans from 9kHz to the 10th harmonic of the carrier. The peak detector is used.

RBW is set to 100kHz, VBW is set to 300kHz for 30MHz~1GHz

RBW is set to 1MHz, VBW is set to 3MHz for above 1GHz, Sweep is set to ATUO.

RBW is set to 1 kHz (0.009MHz~ 0.15 MHz),

RBW is set to 10 kHz (0.15 MHz~ 30 MHz)

RBW is set to 100 kHz (30MHz~1000 MHz)

RBW is set to 1000 kHz (above 1000MHz)

The modulation mode and RB allocation refer to section 5.1, using the maximum output power configuration.

Test setup

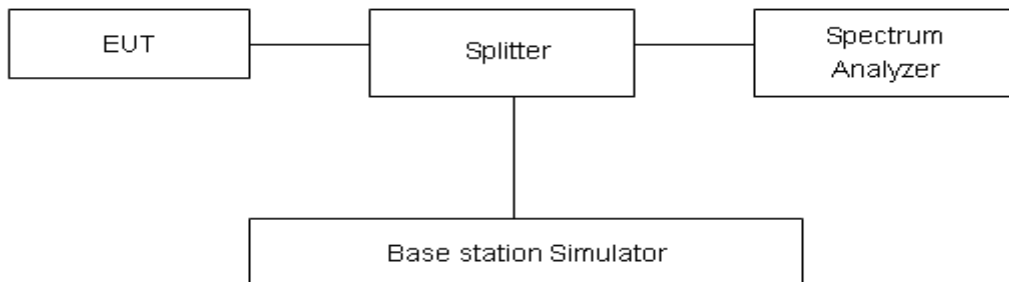

Limits

Rule Part 24.238(a) specifies that “on any frequency outside a licensee’s frequency block, the power of any emission shall be attenuated below the transmitter power (P) by at least 43 + 10 log₁₀ (P) dB.”

Limit	-13 dBm
-------	---------

Measurement Uncertainty

The assessed measurement uncertainty to ensure 99.75% confidence level for the normal distribution is with the coverage factor $k = 1.96$.

Frequency	Uncertainty
9kHz-1GHz	0.684 dB
1GHz-20GHz	1.407 dB

Test Result

Sweep the whole frequency band through the range from 9kHz to the 10th harmonic of the carrier, the emissions more than 20 dB below the limit are not reported.

The signal beyond the limit is carrier.

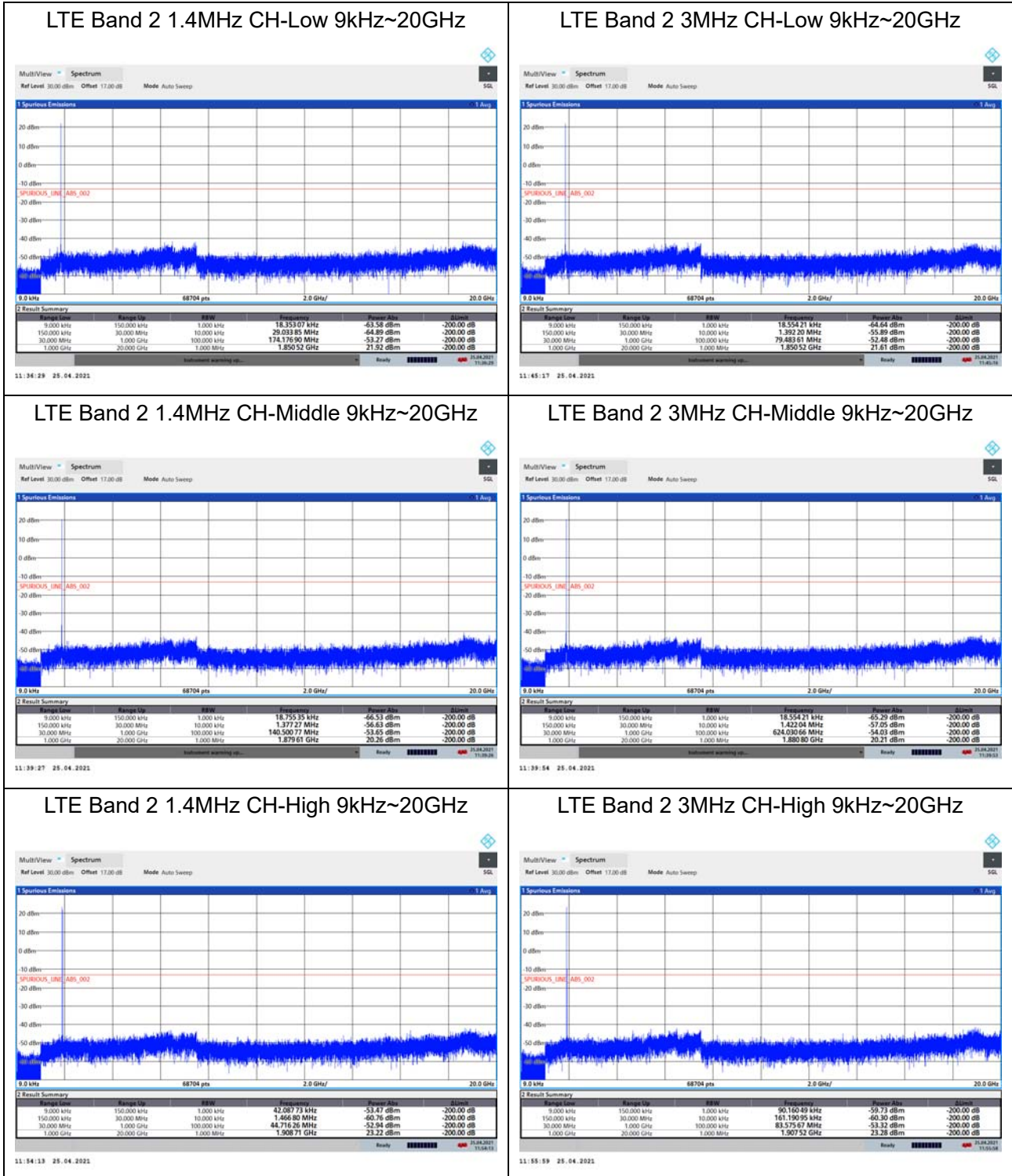



LTE Band 2 5MHz CH-Low 9kHz~20GHz

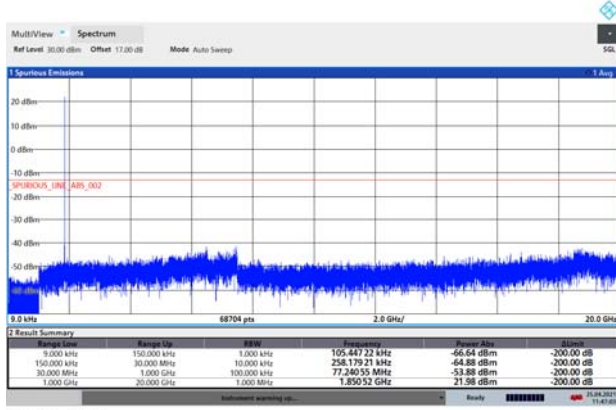

11:47:03 25.04.2021

LTE Band 2 10MHz CH-Low 9kHz~20GHz

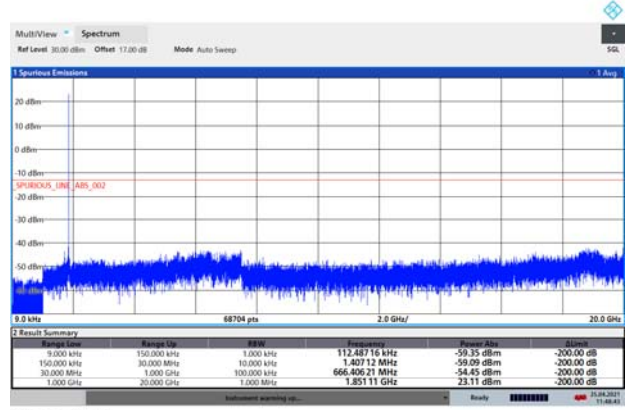

11:48:43 25.04.2021

LTE Band 2 5MHz CH-Middle 9kHz~20GHz

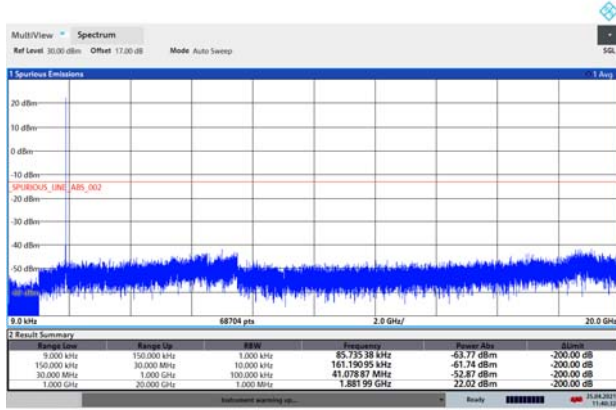

11:40:32 25.04.2021

LTE Band 2 10MHz CH-Middle 9kHz~20GHz

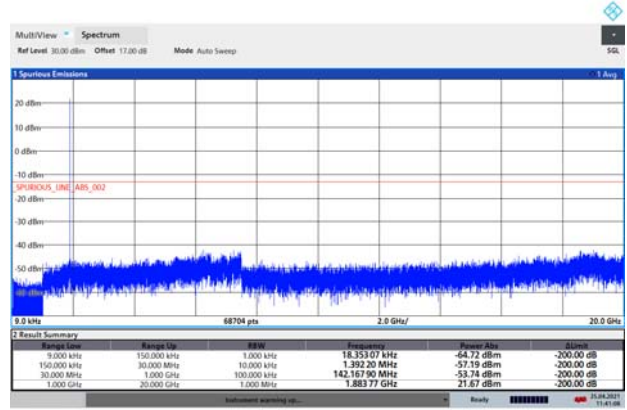

11:41:09 25.04.2021

LTE Band 2 5MHz CH-High 9kHz~20GHz

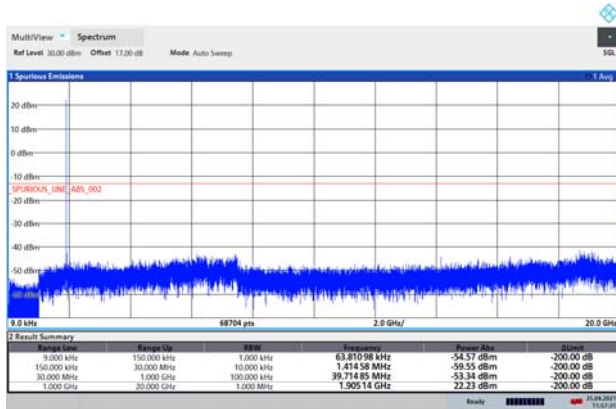

11:57:32 25.04.2021

LTE Band 2 10MHz CH-High 9kHz~20GHz

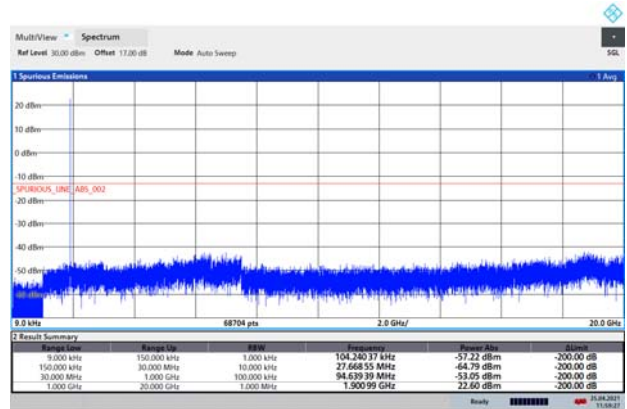

11:59:27 25.04.2021



LTE Band 2 15MHz CH-Low 9kHz~20GHz

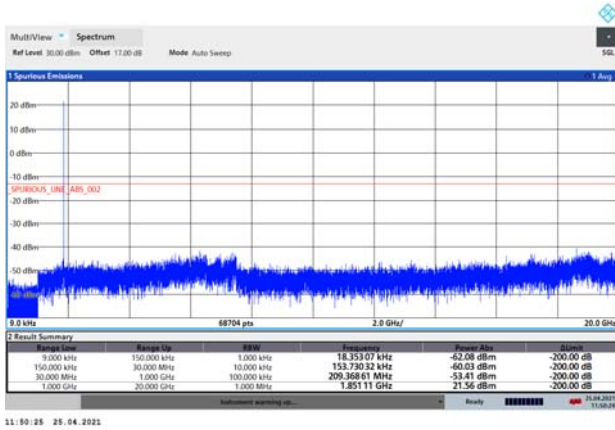

11:50:28 25.04.2021

LTE Band 2 20MHz CH-Low 9kHz~20GHz

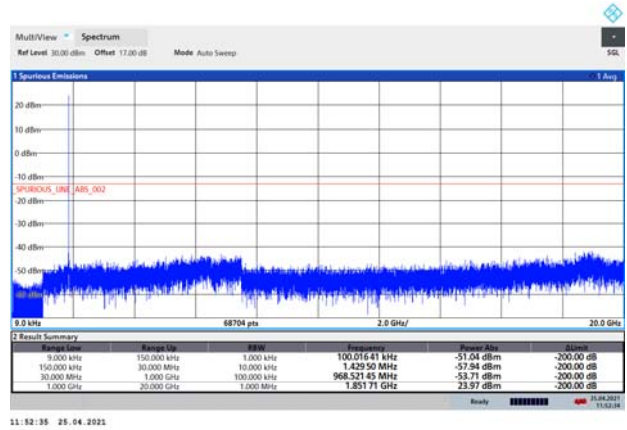

11:52:35 25.04.2021

LTE Band 2 15MHz CH-Middle 9kHz~20GHz

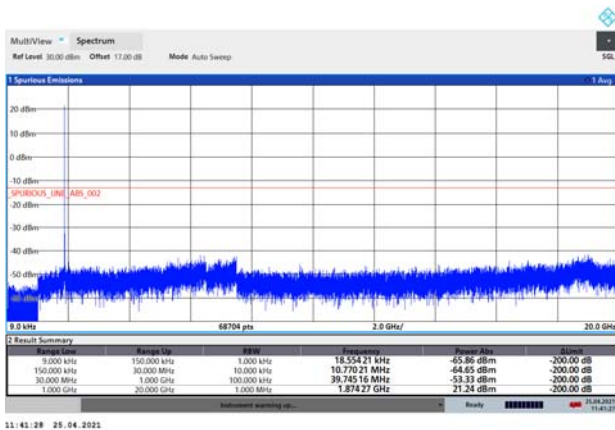

11:41:28 25.04.2021

LTE Band 2 20MHz CH-Middle 9kHz~20GHz

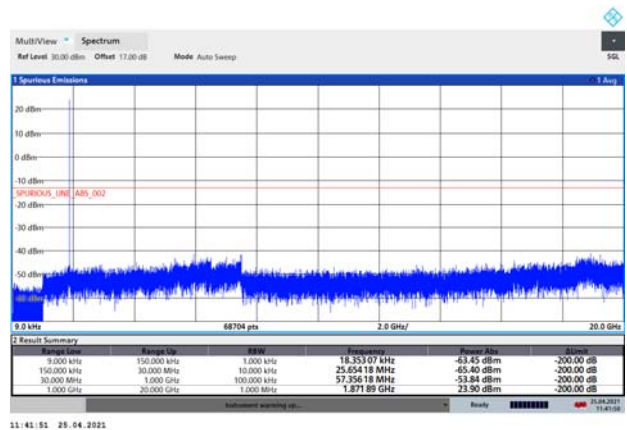

11:41:51 25.04.2021

LTE Band 2 15MHz CH-High 9kHz~20GHz

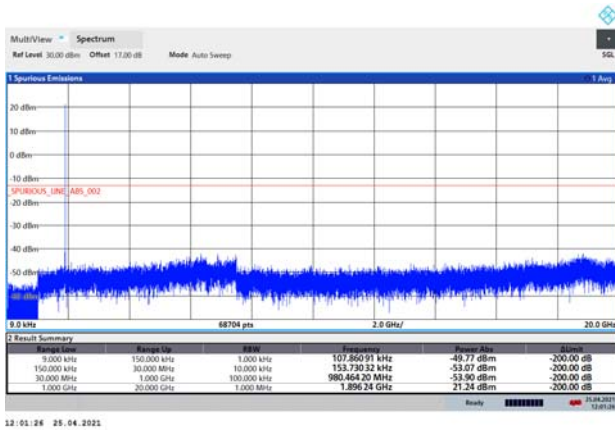

12:01:26 25.04.2021

LTE Band 2 20MHz CH-High 9kHz~20GHz

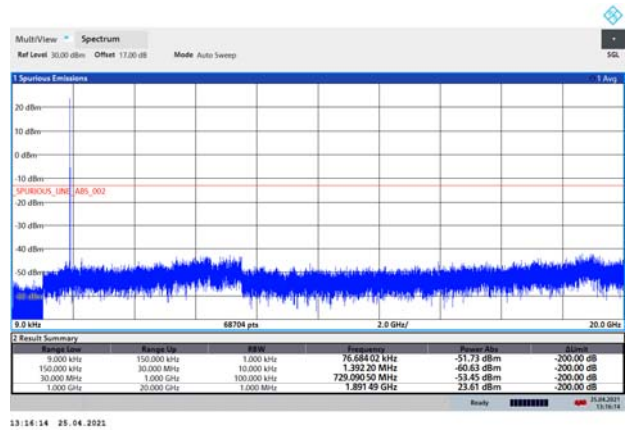

13:14:14 25.04.2021



LTE Band 25 1.4MHz CH-Low 9kHz~20GHz

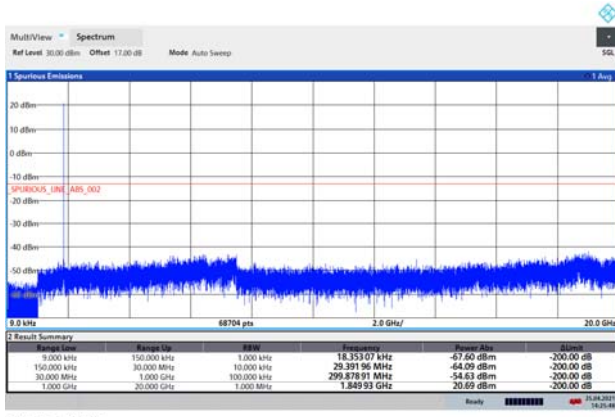

14:25:49 25.04.2021

LTE Band 25 3MHz CH-Low 9kHz~20GHz

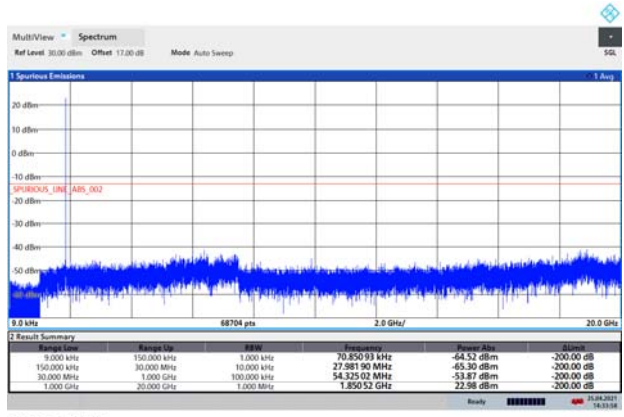

14:33:58 25.04.2021

LTE Band 25 1.4MHz CH-Middle 9kHz~20GHz

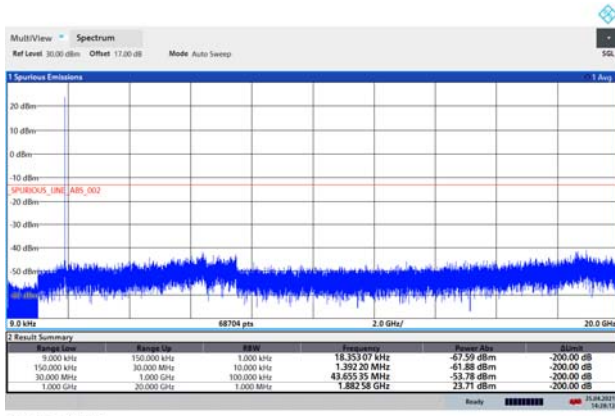

14:28:13 25.04.2021

LTE Band 25 3MHz CH-Middle 9kHz~20GHz

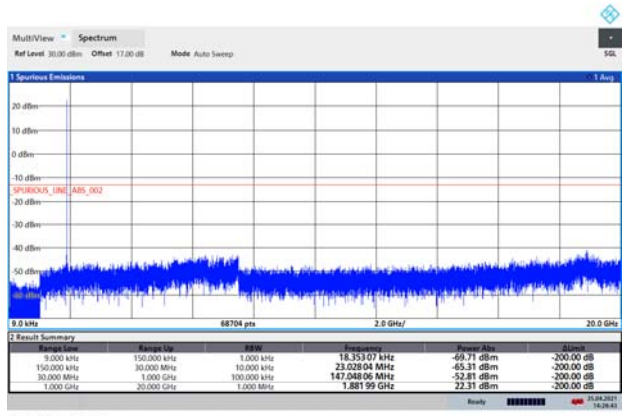

14:28:43 25.04.2021

LTE Band 25 1.4MHz CH-High 9kHz~20GHz

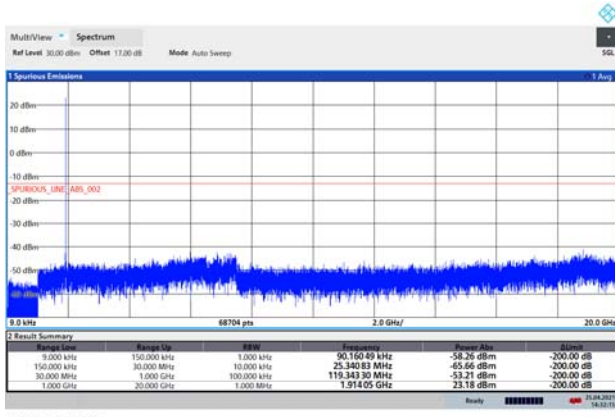

14:32:15 25.04.2021

LTE Band 25 3MHz CH-High 9kHz~20GHz

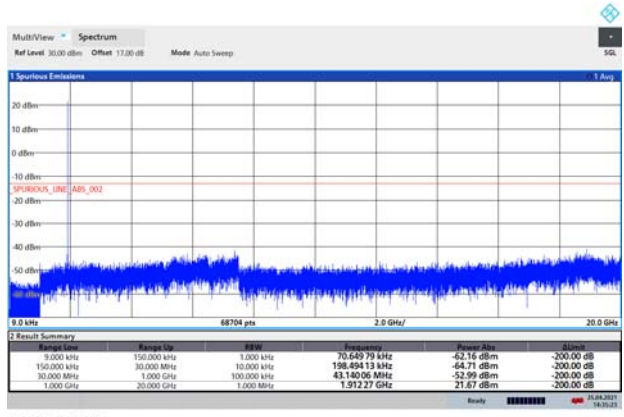

14:35:24 25.04.2021



LTE Band 25 5MHz CH-Low 9kHz~20GHz

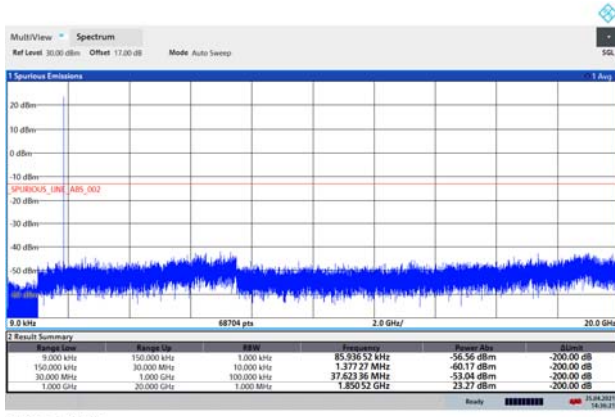

14:34:22 25.04.2021

LTE Band 25 10MHz CH-Low 9kHz~20GHz

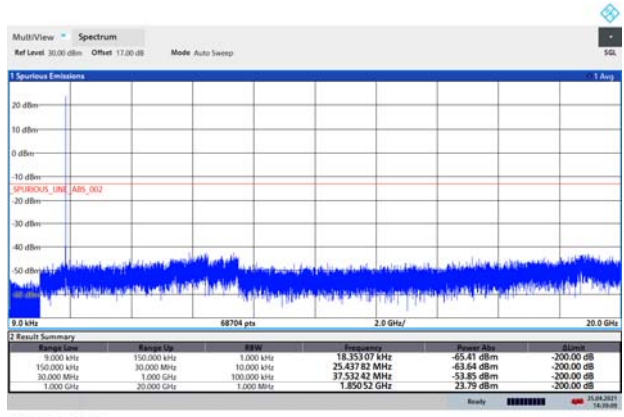

14:39:10 25.04.2021

LTE Band 25 5MHz CH-Middle 9kHz~20GHz

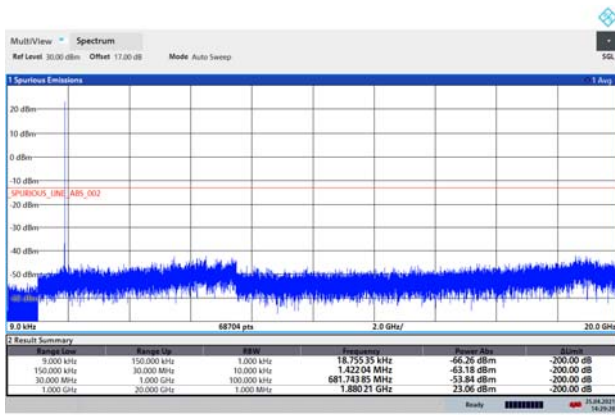

14:39:21 25.04.2021

LTE Band 25 10MHz CH-Middle 9kHz~20GHz

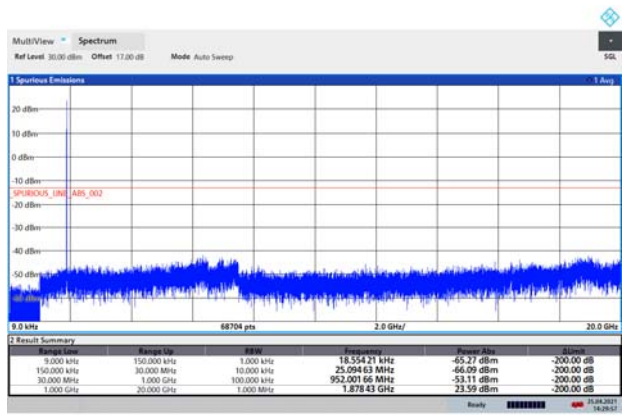

14:39:57 25.04.2021

LTE Band 25 5MHz CH-High 9kHz~20GHz

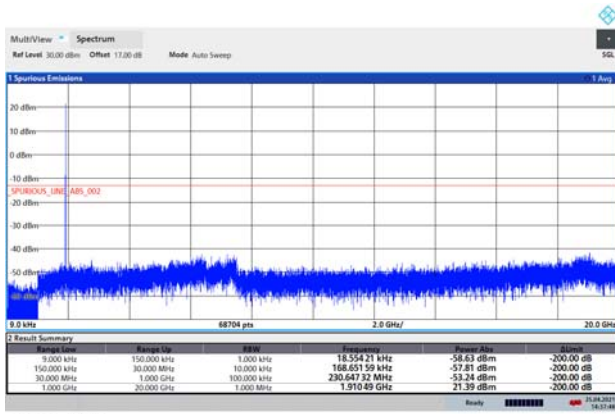

14:37:48 25.04.2021

LTE Band 25 10MHz CH-High 9kHz~20GHz

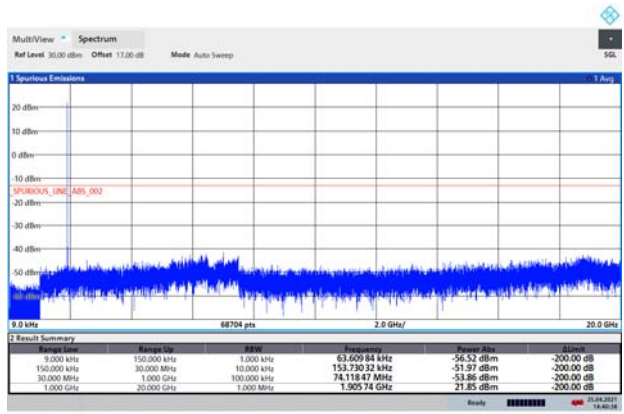

14:40:38 25.04.2021



LTE Band 25 15MHz CH-Low 9kHz~20GHz

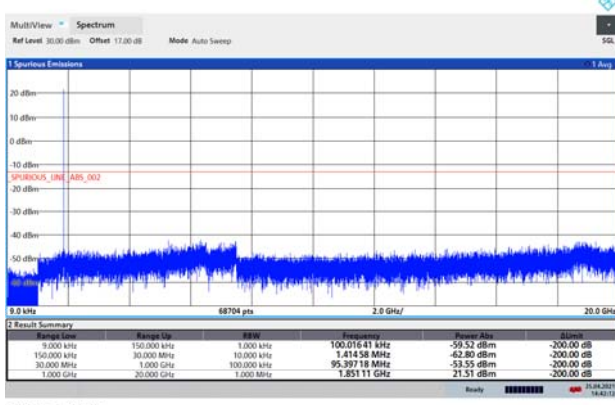

14:42:13 25.04.2021

LTE Band 25 20MHz CH-Low 9kHz~20GHz

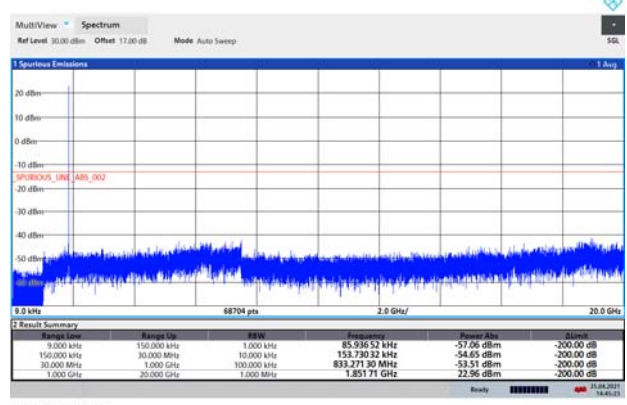

14:45:23 25.04.2021

LTE Band 25 15MHz CH-Middle 9kHz~20GHz

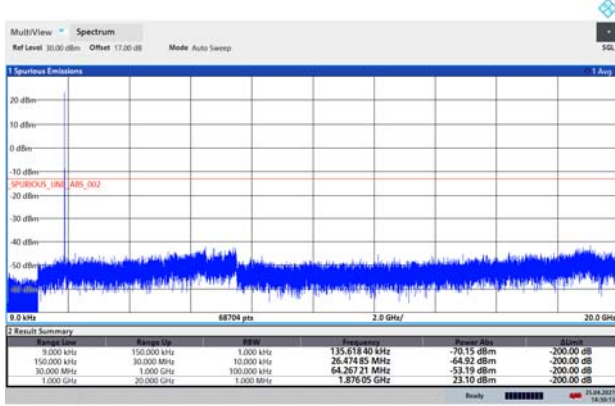

14:40:14 25.04.2021

LTE Band 25 20MHz CH-Middle 9kHz~20GHz

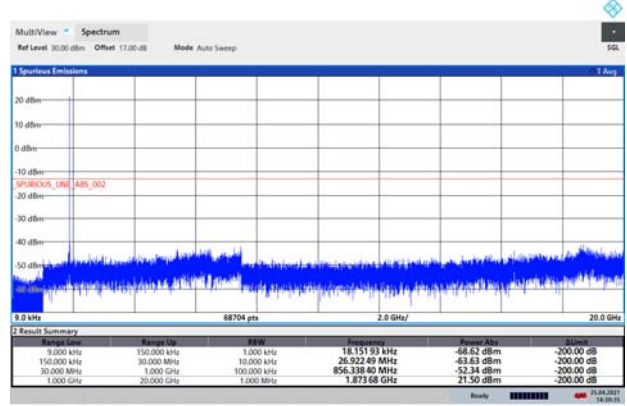

14:40:35 25.04.2021

LTE Band 25 15MHz CH-High 9kHz~20GHz

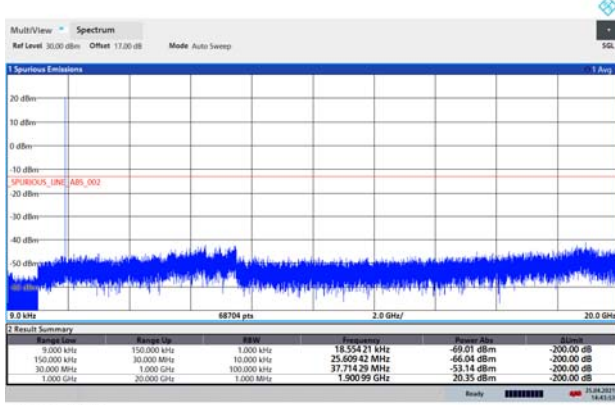

14:43:53 25.04.2021

LTE Band 25 20MHz CH-High 9kHz~20GHz

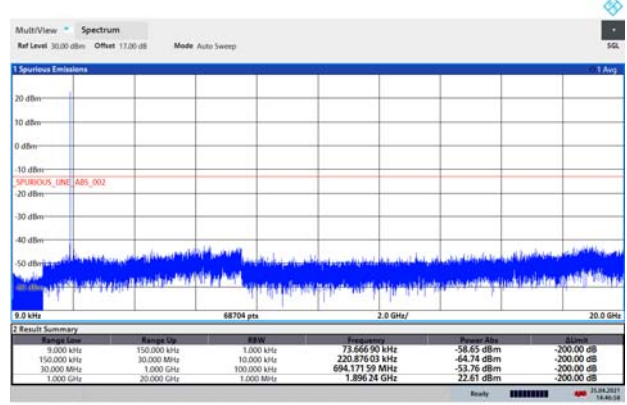

14:46:58 25.04.2021

5.7. Radiates Spurious Emission

Ambient condition

Temperature	Relative humidity	Pressure
23°C ~25°C	45%~50%	101.5kPa

Method of Measurement

- The testing follows FCC KDB 971168 v03r01 Section 5.8 and ANSI C63.26 (2015).
- Below 1GHz: The EUT is placed on a turntable 0.8 meters above the ground in the chamber, 3 meter away from the antenna. The maximal emission value is acquired by adjusting the antenna height, polarisation and turntable azimuth. Normally, the height range of antenna is 1 m to 4 m, the azimuth range of turntable is 0° to 360°, and the receive antenna has two polarizations Vertical (V) and Horizontal (H). Above 1GHz: (Note: the FCC's permission to use 1.5m as an alternative per TCBC Conf call of Dec. 2, 2014.) The EUT is placed on a turntable 1.5 meters above the ground in the chamber, 3 meter away from the antenna. The maximal emission value is acquired by adjusting the antenna height, polarisation and turntable azimuth. Normally, the height range of antenna is 1 m to 4 m, the azimuth range of turntable is 0° to 360°, and the receive antenna has two polarizations Vertical (V) and Horizontal (H).
- A loop antenna, A log-periodic antenna or horn antenna shall be substituted in place of the EUT. The log-periodic antenna will be driven by a signal generator and the level will be adjusted till the same power value on the spectrum analyzer or receiver. The level of the spurious emissions can be calculated through the level of the signal generator, cable loss, the gain of the substitution antenna and the reading of the spectrum analyzer or receiver.
- The EUT is then put into continuously transmitting mode at its maximum power level during the test. Set Test Receiver or Spectrum RBW=1MHz, VBW=3MHz, and the maximum value of the receiver should be recorded as (Pr).
- The EUT shall be replaced by a substitution antenna. In the chamber, an substitution antenna for the frequency band of interest is placed at the reference point of the chamber. An RF Signal source for the frequency band of interest is connected to the substitution antenna with a cable that has been constructed to not interfere with the radiation pattern of the antenna. A power (PMea) is applied to the input of the substitution antenna, and adjust the level of the signal generator output until the value of the receiver reach the previously recorded (Pr). The power of signal source (PMea) is recorded. The test should be performed by rotating the test item and adjusting the receiving antenna polarization.
- A amplifier should be connected to the Signal Source output port. And the cable should be connect between the Amplifier and the Substitution Antenna. The cable loss (Pcl) ,the Substitution Antenna Gain (Ga) and the Amplifier Gain (PAg) should be recorded after test.
- The measurement results are obtained as described below:
 $Power(EIRP)=PMea- PAg - Pcl + Ga$
 The measurement results are amend as described below:
 $Power(EIRP)=PMea- Pcl + Ga$
- This value is EIRP since the measurement is calibrated using an antenna of known gain (2.15 dBi) and known input power. ERP can be calculated from EIRP by subtracting the gain of the dipole, ERP

= EIRP-2.15dBi.

The modulation mode and RB allocation refer to section 5.1, using the maximum output power configuration.

Test setup

9KHz ~ 30MHz

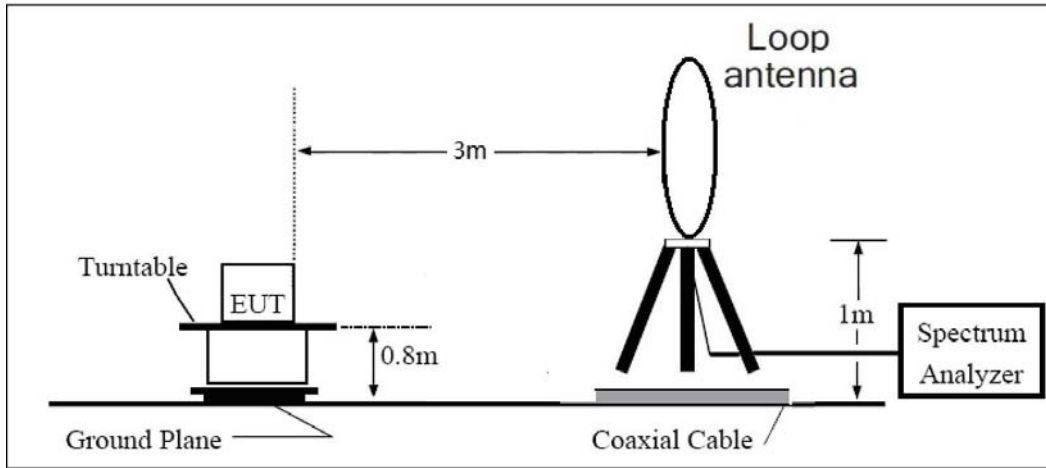

30MHz ~ 1GHz

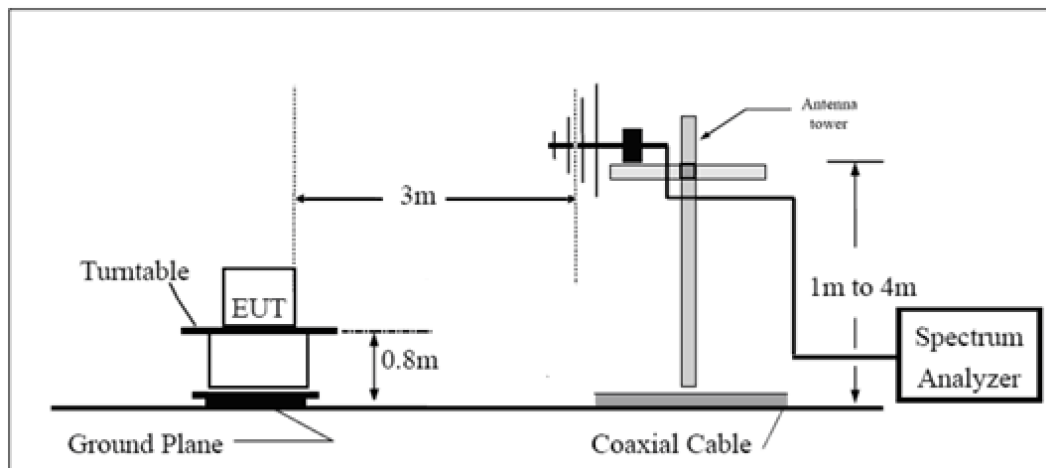

Above 1GHz

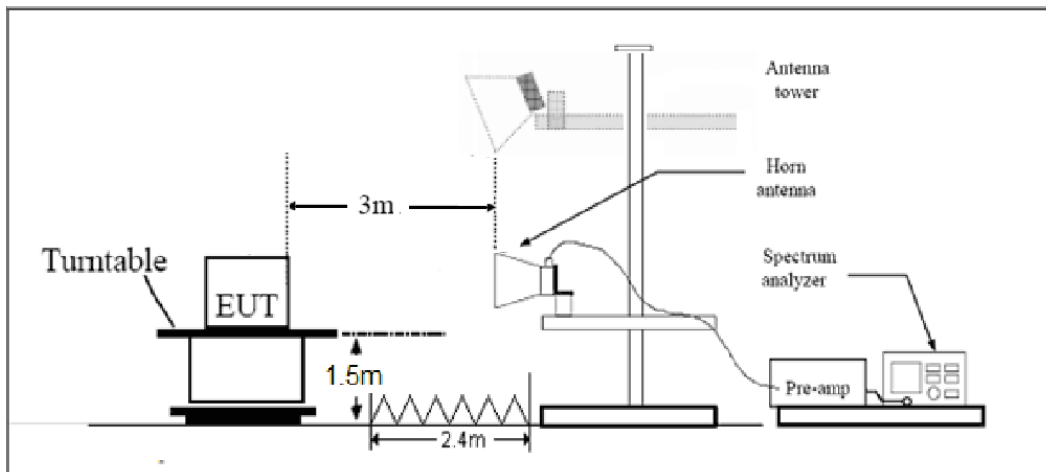

Note: Area side: 2.4mX3.6m

Limits

Rule Part 24.238(a) specifies that “on any frequency outside a licensee's frequency block, the power of any emission shall be attenuated below the transmitter power (P) by at least $43 + 10 \log_{10} (P)$ dB.”

Limit	-13 dBm
-------	---------

Measurement Uncertainty

The assessed measurement uncertainty to ensure 95% confidence level for the normal distribution is with the coverage factor $k = 1.96$, $U = 3.55$ dB.

Test Result

Sweep the whole frequency band through the range from 9kHz to the 10th harmonic of the carrier, the emissions below the noise floor will not be recorded in the report.

LTE Band 2 1.4MHz CH-Middle

Harmonic	Frequency (MHz)	SG (dBm)	Cable Loss (dB)	Gain (dBi)	Antenna Polarization	EIRP Level (dBm)	Limit (dBm)	Margin (dB)	Azimuth (deg)
2	3759.00	-55.25	2.60	12.50	Horizontal	-45.35	-13.00	32.35	180
3	5633.70	-52.07	3.30	12.50	Horizontal	-42.87	-13.00	29.87	45
4	7520.00	-58.35	4.20	12.20	Horizontal	-50.35	-13.00	37.35	90
5	9400.00	-57.64	4.30	11.10	Horizontal	-50.84	-13.00	37.84	135
6	11280.00	-52.17	5.90	11.90	Horizontal	-46.17	-13.00	33.17	45
7	13160.00	-55.00	5.70	14.00	Horizontal	-46.70	-13.00	33.70	270
8	15040.00	-55.01	5.80	13.10	Horizontal	-47.71	-13.00	34.71	180
9	16920.00	-56.36	6.10	14.60	Horizontal	-47.86	-13.00	34.86	90
10	18800.00	-	-	-	-	-	-	-	-

Note: 1.The other Spurious RF Radiated emissions level is no more than noise floor.
 2. The worst emission was found in the antenna is Horizontal position.

LTE Band 2 5MHz CH-Middle

Harmonic	Frequency (MHz)	SG (dBm)	Cable Loss (dB)	Gain (dBi)	Antenna Polarization	EIRP Level (dBm)	Limit (dBm)	Margin (dB)	Azimuth (deg)
2	3755.63	-54.80	2.60	12.50	Horizontal	-44.90	-13.00	31.90	90
3	5633.70	-53.10	3.30	12.50	Horizontal	-43.90	-13.00	30.90	45
4	7520.00	-57.46	4.20	12.20	Horizontal	-49.46	-13.00	36.46	315
5	9400.00	-54.59	4.30	11.10	Horizontal	-47.79	-13.00	34.79	45
6	11280.00	-49.96	5.90	11.90	Horizontal	-43.96	-13.00	30.96	180
7	13160.00	-52.92	5.70	14.00	Horizontal	-44.62	-13.00	31.62	90
8	15040.00	-54.88	5.80	13.10	Horizontal	-47.58	-13.00	34.58	135
9	16920.00	-55.25	6.10	14.60	Horizontal	-46.75	-13.00	33.75	45
10	18800.00	-	-	-	-	-	-	-	-

Note: 1.The other Spurious RF Radiated emissions level is no more than noise floor.
 2. The worst emission was found in the antenna is Horizontal position.



LTE Band 2 20MHz CH-Middle

Harmonic	Frequency (MHz)	SG (dBm)	Cable Loss (dB)	Gain (dBi)	Antenna Polarization	EIRP Level (dBm)	Limit (dBm)	Margin (dB)	Azimuth (deg)
2	3742.13	-54.49	2.60	12.50	Horizontal	-44.59	-13.00	31.59	45
3	5613.38	-53.24	3.30	12.50	Horizontal	-44.04	-13.00	31.04	270
4	7484.63	-59.36	4.20	12.20	Horizontal	-51.36	-13.00	38.36	270
5	9400.00	-55.81	4.30	11.10	Horizontal	-49.01	-13.00	36.01	45
6	11280.00	-51.64	5.90	11.90	Horizontal	-45.64	-13.00	32.64	90
7	13160.00	-54.45	5.70	14.00	Horizontal	-46.15	-13.00	33.15	315
8	15040.00	-56.59	5.80	13.10	Horizontal	-49.29	-13.00	36.29	45
9	16920.00	-54.54	6.10	14.60	Horizontal	-46.04	-13.00	33.04	135
10	18800.00	-	-	-	-	-	-	-	-

Note: 1. The other Spurious RF Radiated emissions level is no more than noise floor.

2. The worst emission was found in the antenna is Horizontal position.



LTE Band 25 1.4MHz CH-Middle

Harmonic	Frequency (MHz)	SG (dBm)	Cable Loss (dB)	Gain (dBi)	Antenna Polarization	EIRP Level (dBm)	Limit (dBm)	Margin (dB)	Azimuth (deg)
2	3765.00	-58.19	2.60	12.50	Horizontal	-48.29	-13.00	35.29	315
3	5647.50	-52.73	3.30	12.50	Horizontal	-43.53	-13.00	30.53	0
4	7530.00	-58.18	4.20	12.20	Horizontal	-50.18	-13.00	37.18	90
5	9412.50	-52.79	4.30	11.10	Horizontal	-45.99	-13.00	32.99	90
6	11295.00	-50.28	5.90	11.90	Horizontal	-44.28	-13.00	31.28	135
7	13177.50	-51.68	5.70	14.00	Horizontal	-43.38	-13.00	30.38	45
8	15060.00	-47.16	5.80	13.10	Horizontal	-39.86	-13.00	26.86	315
9	16942.50	-49.81	6.10	14.60	Horizontal	-41.31	-13.00	28.31	90
10	18825.00	-	-	-	-	-	-	-	-

Note: 1.The other Spurious RF Radiated emissions level is no more than noise floor.

2. The worst emission was found in the antenna is Horizontal position.

LTE Band 25 5MHz CH-Middle

Harmonic	Frequency (MHz)	SG (dBm)	Cable Loss (dB)	Gain (dBi)	Antenna Polarization	EIRP Level (dBm)	Limit (dBm)	Margin (dB)	Azimuth (deg)
2	3765.00	-55.47	2.60	12.50	Horizontal	-45.57	-13.00	32.57	45
3	5647.50	-51.41	3.30	12.50	Horizontal	-42.21	-13.00	29.21	270
4	7530.00	-57.89	4.20	12.20	Horizontal	-49.89	-13.00	36.89	45
5	9412.50	-55.04	4.30	11.10	Horizontal	-48.24	-13.00	35.24	90
6	11295.00	-53.14	5.90	11.90	Horizontal	-47.14	-13.00	34.14	45
7	13177.50	-54.56	5.70	14.00	Horizontal	-46.26	-13.00	33.26	315
8	15060.00	-54.69	5.80	13.10	Horizontal	-47.39	-13.00	34.39	0
9	16942.50	-55.63	6.10	14.60	Horizontal	-47.13	-13.00	34.13	90
10	18825.00	-	-	-	-	-	-	-	-

Note: 1.The other Spurious RF Radiated emissions level is no more than noise floor.

2. The worst emission was found in the antenna is Horizontal position.



LTE Band 25 20MHz CH-Middle

Harmonic	Frequency (MHz)	SG (dBm)	Cable Loss (dB)	Gain (dBi)	Antenna Polarization	EIRP Level (dBm)	Limit (dBm)	Margin (dB)	Azimuth (deg)
2	3748.13	-58.12	2.60	12.50	Horizontal	-48.22	-13.00	35.22	315
3	5622.00	-52.32	3.30	12.50	Horizontal	-43.12	-13.00	30.12	135
4	7496.00	-58.48	4.20	12.20	Horizontal	-50.48	-13.00	37.48	45
5	9370.00	-52.28	4.30	11.10	Horizontal	-45.48	-13.00	32.48	45
6	11244.00	-51.80	5.90	11.90	Horizontal	-45.80	-13.00	32.80	270
7	13118.00	-52.78	5.70	14.00	Horizontal	-44.48	-13.00	31.48	315
8	14992.00	-46.60	5.80	13.10	Horizontal	-39.30	-13.00	26.30	135
9	16866.00	-50.70	6.10	14.60	Horizontal	-42.20	-13.00	29.20	90
10	18740.00	-	-	-	-	-	-	-	-

Note: 1. The other Spurious RF Radiated emissions level is no more than noise floor.

2. The worst emission was found in the antenna is Horizontal position.

6. Main Test Instruments

Name	Manufacturer	Type	Serial Number	Calibration Date	Expiration Date
Base Station Simulator	R&S	CMU200	118133	2020-05-17	2021-05-16
Base Station Simulator	R&S	CMW500	113824	2020-05-18	2021-05-17
Power Splitter	Hua Xiang	SHX-GF2-2-13	10120101	/	/
Spectrum Analyzer	Key sight	N9010A	MY50210259	2020-05-18	2021-05-17
Universal Radio Communication Tester	Key sight	E5515C	MY48367192	2020-05-27	2021-05-26
Signal Analyzer	R&S	FSV30	100815	2020-12-13	2021-12-12
Loop Antenna	SCHWARZBECK	FMZB1519	1519-047	2020-04-02	2023-04-01
TRILOG Broadband Antenna	SCHWARZBECK	VULB 9163	391	2019-12-16	2021-12-15
Horn Antenna	R&S	HF907	102723	2018-08-11	2021-08-10
Horn Antenna	ETS-Lindgren	3160-09	00102643	2018-06-20	2021-06-19
Signal generator	R&S	SMB 100A	102594	2020-05-18	2021-05-17
Climatic Chamber	ESPEC	SU-242	93000506	2020-12-13	2021-12-12
Preamplifier	R&S	SCU18	102327	2020-05-18	2021-05-17
MOB COMMS DC SUPPLY	Keysight	66319D	MY43004105	2020-05-18	2021-05-17
RF Cable	Agilent	SMA 15cm	0001	2021-5-15	2022-5-14
Software	R&S	EMC32	9.26.0	/	/

*****END OF REPORT *****



ANNEX A: The EUT Appearance

The EUT Appearance are submitted separately.



ANNEX B: Test Setup Photos

The Test Setup Photos are submitted separately.



ANNEX C: Product Change Description

The Product Change Description are submitted separately.