

FCC Radio Test Report

FCC ID: XMR202106EG95AUX

This report concerns: Original Grant

Project No. : 2009H029A
Equipment : LTE Module
Brand Name : Quectel
Test Model : EG95-AUX
Series Model : N/A
Applicant : Quectel Wireless Solutions Company Limited
Address : Building 5, Shanghai Business Park Phase III (Area B), No.1016 Tianlin Road, Minhang District, Shanghai, China 200233.
Manufacturer : Quectel Wireless Solutions Co., Ltd.
Address : Building 5, Shanghai Business Park Phase III (Area B), No.1016 Tianlin Road, Minhang District, Shanghai, China 200233.
Date of Receipt : Apr. 16, 2021
Date of Test : Apr. 16, 2021 ~ May 10, 2021
Issued Date : Jun. 01, 2021
Report Version : R01
Test Sample : Engineering Sample No.: SH2020091136 for EUT, SH2020091134-2 for adapter.
Standard(s) : 47 CFR FCC Part 22 Subpart H
47 CFR FCC Part 2
ANSI/TIA/EIA-603-E-2016
FCC KDB 971168 D01 Power Meas License Digital Systems v03r01

The above equipment has been tested and found compliance with the requirement of the relative standards by BTL Inc.

Maker Qi

Prepared by : Maker Qi

Issac Song

Approved by : Issac Song



Certificate # 5123.03

Add: No. 29, Jintang Road, Tangzhen Industry Park, Pudong New Area, Shanghai 201210, China

TEL: +86-021-61765666

Web: www.newbtl.com

Declaration

BTL represents to the client that testing is done in accordance with standard procedures as applicable and that test instruments used has been calibrated with standards traceable to international standard(s) and/or national standard(s).

BTL's reports apply only to the specific samples tested under conditions. It is manufacture's responsibility to ensure that additional production units of this model are manufactured with the identical electrical and mechanical components. **BTL** shall have no liability for any declarations, inferences or generalizations drawn by the client or others from **BTL** issued reports.

The report must not be used by the client to claim product certification, approval, or endorsement by NIST, A2LA, or any agency of the U.S. Government.

This report is the confidential property of the client. As a mutual protection to the clients, the public and ourselves, the test report shall not be reproduced, except in full, without our written approval.

BTL's laboratory quality assurance procedures are in compliance with the **ISO/IEC 17025** requirements, and accredited by the conformity assessment authorities listed in this test report.

BTL is not responsible for the sampling stage, so the results only apply to the sample as received.

The information, data and test plan are provided by manufacturer which may affect the validity of results, so it is manufacturer's responsibility to ensure that the apparatus meets the essential requirements of applied standards and in all the possible configurations as representative of its intended use.

Limitation

For the use of the authority's logo is limited unless the Test Standard(s)/Scope(s)/Item(s) mentioned in this test report is (are) included in the conformity assessment authorities acceptance respective.

Please note that the measurement uncertainty is provided for informational purpose only and is not use in determining the Pass/Fail results.

Table of Contents	Page
REPORT ISSUED HISTORY	5
1 . SUMMARY OF TEST RESULTS	6
1.1 TEST FACILITY	7
1.2 MEASUREMENT UNCERTAINTY	7
1.3 TEST ENVIRONMENT CONDITIONS	7
2 . GENERAL INFORMATION	8
2.1 GENERAL DESCRIPTION OF EUT	8
2.2 DESCRIPTION OF TEST MODES AND TEST CONDITION	10
2.3 BLOCK DIGRAM SHOWING THE CONFIGURATIONOFSYSTEMTESTED	12
3.4 DESCRIPTION OF SUPPORT UNITS	12
3 . TEST RESULT	13
3.1 OUTPUT POWER MEASUREMENT	13
3.1.1 LIMIT	13
3.1.2 TEST PROCEDURE	13
3.1.3 TEST SETUP LAYOUT	13
3.1.4 TEST DEVIATION	13
3.1.5 TEST RESULTS	13
3.2 OCCUPIED BANDWIDTH MEASUREMENT	14
3.2.1 TEST PROCEDURE	14
3.2.2 TEST SETUP LAYOUT	14
3.2.3 TEST DEVIATION	14
3.2.4 TEST RESULTS	14
3.3 CONDUCTED EMISSIONS MEASUREMENT	15
3.3.1 LIMIT	15
3.3.2 TEST PROCEDURES	15
3.3.3 TEST SETUP LAYOUT	15
3.3.4 TEST DEVIATION	15
3.3.5 TEST RESULTS	15
3.4 RADIATED EMISSIONS MEASUREMENT	16
3.4.1 LIMIT	16
3.4.2 TEST PROCEDURES	16
3.4.3 TEST SETUP LAYOUT	17
3.4.4 TEST DEVIATION	18
3.4.5 TEST RESULTS (9KHZ TO 30MHZ)	18
3.4.6 TEST RESULTS (30MHZ TO 1000MHZ)	18
3.4.7 TEST RESULTS (ABOVE 1000MHZ)	18
3.5 BAND EDGE MEASUREMENT	19
3.5.1 LIMIT	19

Table of Contents	Page
3.5.2 TEST PROCEDURES	19
3.5.3 TEST SETUP LAYOUT	19
3.5.4 TEST DEVIATION	19
3.5.5 TEST RESULTS	19
3.6 PEAK TO AVERAGE RATIO MEASUREMENT	20
3.6.1 LIMIT	20
3.6.2 TEST PROCEDURES	20
3.6.3 TEST SETUP LAYOUT	20
3.6.4 TEST DEVIATION	20
3.6.5 TEST RESULTS	20
3.7 FREQUENCY STABILITY MEASUREMENT	21
3.7.1 LIMIT	21
3.7.2 TEST PROCEDURES	21
3.7.3 TEST SETUP LAYOUT	21
3.7.4 TEST DEVIATION	21
3.7.5 TEST RESULTS	21
5. LIST OF MEASUREMENT EQUIPMENTS	22
6. EUT TEST PHOTO	24
APPENDIX A – OUTPUT POWER	26
APPENDIX B – OCCUPIED BANDWIDTH	33
APPENDIX C – CONDUCTED EMISSIONS	45
APPENDIX D – RADIATED EMISSION (9KHZ TO 30MHZ)	51
APPENDIX E – RADIATED EMISSION (30MHZ TO 1GHZ)	52
APPENDIX F – RADIATED EMISSION (ABOVE 1GHZ)	59
APPENDIX G – BAND EDGE	66
APPENDIX H – PEAK TO AVERAGE RATIO	73
APPENDIX I – FREQUENCY STABILITY	80

REPORT ISSUED HISTORY

Report Version	Description	Issued Date
R00	Original Issue.	May. 26, 2021
R01	Revised report to address TCB's comments.	Jun. 01, 2021

1. SUMMARY OF TEST RESULTS

Test procedures according to the technical standard(s):

FCC Part 22 Subpart H & Part 2			
Standard(s) Section	Test Item	Judgment	Remark
2.1046 22.913(a)	Effective Radiated Power	PASS	-----
2.1049	Occupied Bandwidth	PASS	-----
2.1051 22.917(a)	Conducted Spurious Emissions	PASS	-----
2.1053 22.917(a)	Radiated Spurious Emissions	PASS	-----
22.917(a)	Band Edge Measurements	PASS	-----
-	Peak To Average Ratio	PASS	-----
2.1055 22.355	Frequency Stability	PASS	-----

Note:

For the verdict, the "N/A" denotes "not applicable", the "N/T" denotes "not tested".

1.1 TEST FACILITY

The test facilities used to collect the test data in this report is at the location of No. 29, Jintang Road, Tangzhen Industry Park, Pudong New Area, Shanghai 201210, China.

BTL's Test Firm Registration Number for FCC: 476765

BTL's Designation Number for FCC: CN1241

1.2 MEASUREMENT UNCERTAINTY

The measurement uncertainty figures shall be calculated according the methods described in the ETSI TR 100 028 and shall correspond to an expansion factor (coverage factor) $k=1.96$ or $k=2$ (which provide confidence levels of respectively 90% and 95.45% in the case where the distributions characterizing the actual measurement uncertainties are normal (Gaussian)).

Measurement Uncertainty for a Level of Confidence of 95 %, $U=2xUc(y)$.

The BTL measurement uncertainty as below table:

A. Radiated Measurement :

Test Site	Method	Measurement Frequency Range	Ant. H / V	U,(dB)
SH-CB01	CISPR	9KHz ~ 30MHz	V	3.79
		9KHz ~ 30MHz	H	3.57
		30MHz ~ 200MHz	V	4.12
		30MHz ~ 200MHz	H	3.20
		200MHz ~ 1,000MHz	V	3.12
		200MHz ~ 1,000MHz	H	3.18

Test Site	Method	Measurement Frequency Range	U,(dB)
SH-CB01 (3m)	CISPR	1GHz ~ 6GHz	4.40
		6GHz ~ 18GHz	4.86

Test Site	Method	Measurement Frequency Range	U,(dB)
SH-CB01 (3m)	CISPR	18 ~ 26.5 GHz	3.64
		26.5 ~ 40 GHz	3.78

Note: Unless specifically mentioned, the uncertainty of measurement has not been taken into account to declare the compliance or non-compliance to the specification.

1.3 TEST ENVIRONMENT CONDITIONS

Test Item	Temperature	Humidity	Test Voltage	Tested By
Output Power & ERP	26°C	52%	DC 3.8V	Vince Zong
Occupied Bandwidth	26°C	52%	DC 3.8V	Vince Zong
Conducted Spurious Emissions	26°C	52%	DC 3.8V	Vince Zong
Radiated Spurious Emissions	24°C	58%	DC 3.8V	Forest Li
Band Edge	26°C	52%	DC 3.8V	Vince Zong
Peak to Average Ratio	26°C	52%	DC 3.8V	Vince Zong
Frequency Stability	Normal and Extreme			Vince Zong

2. GENERAL INFORMATION

2.1 GENERAL DESCRIPTION OF EUT

Equipment	LTE Module	
Brand Name	Quectel	
Test Model	EG95-AUX	
Series Model	N/A	
Model Difference(s)	N/A	
Software Version	EG95AUXGAR08A03M1G	
Hardware Version	R1.0	
Power Source	DC Voltage supplied from AC/DC adapter(support unit)	
Power Rating	Supply voltage:3.3-4.3V, Typical supply voltage:3.8V	
Antenna Type	Dipole	
Antenna Gain	GSM850	2.53 dBi
	WCDMA V	
	LTE Band 5	
Modulation Type	GSM	GMSK
	GPRS	GMSK
	EDGE	GMSK, 8PSK
	WCDMA	UL: QPSK DL: QPSK, 16QAM
	LTE	UL: QPSK, 16QAM DL: QPSK, 16QAM, 64QAM
Operation Frequency	EDGE/GSM/GPRS	824.2MHz ~ 848.8MHz
	WCDMA Band V	826.4MHz ~ 846.6MHz
	LTE Band 5 (Channel Bandwidth: 1.4MHz)	824.7 MHz ~ 848.3 MHz
	LTE Band 5 (Channel Bandwidth: 3MHz)	825.5 MHz ~ 847.5 MHz
	LTE Band 5 (Channel Bandwidth: 5MHz)	826.5 MHz ~ 846.5 MHz
	LTE Band 5 (Channel Bandwidth: 10MHz)	829.0 MHz ~ 844.0 MHz

Max. ERP Power	GSM	GMSK	33.13	dBm
	GPRS	GMSK	33.02	dBm
	EDGE	8PSK	26.95	dBm
	WCDMA	QPSK	23.90	dBm
	LTE Band 5 (Channel Bandwidth: 1.4MHz)	QPSK	23.44	dBm
		16QAM	22.49	dBm
	LTE Band 5 (Channel Bandwidth: 3MHz)	QPSK	23.22	dBm
		16QAM	22.83	dBm
	LTE Band 5 (Channel Bandwidth: 5MHz)	QPSK	23.27	dBm
		16QAM	22.07	dBm
	LTE Band 5 (Channel Bandwidth: 10MHz)	QPSK	23.16	dBm
		16QAM	22.07	dBm

Note:

1. For a more detailed features description, please refer to the manufacturer's specifications or the user's manual.
2. WCDMA (UL: QPSK; DL: QPSK) mode was found to be the worst case and recorded.

2.2 DESCRIPTION OF TEST MODES AND TEST CONDITION

Pre-Scan has been conducted to determine the worst-case mode from all possible combinations between available modulations, data rates, XYZ axis and antenna ports

The worst case was found when positioned on X-plane for EIRP and X-axis for radiated emission.

Following channel(s) was (were) selected for the final test as listed below:

GSM MODE			
Test Item	Available Channel	Tested Channel	Mode
ERP	128 to 251	128, 190, 251	GSM, GPRS, EDGE
Output Power	128 to 251	128, 190, 251	GSM, GPRS, EDGE
Occupied Bandwidth	128 to 251	128, 190, 251	GSM, EDGE
Conducuted Emission	128 to 251	190	GSM, EDGE
Radiated Emission	128 to 251	190	EDGE
Band Edge	128 to 251	128, 251	GSM, EDGE
Peak to Average Ratio	128 to 251	128, 190, 251	GSM, EDGE
Frequency Stability	128 to 251	190	GSM

WCDMA MODE			
Test Item	Available Channel	Tested Channel	Mode
ERP	4132 to 4233	4132, 4182, 4233	WCDMA, HSDPA, HSUPA
Output Power	4132 to 4233	4132, 4182, 4233	WCDMA, HSDPA, HSUPA
Conducted Emission	4132 to 4233	4182	WCDMA
Radiated Emission	4132 to 4233	4182	WCDMA
Band Edge	4132 to 4233	4132, 4233	WCDMA
Peak to Average Ratio	4132 to 4233	4132, 4182, 4233	WCDMA
Frequency Stability	4132 to 4233	4182	WCDMA

LTE BAND 5						
Test Item	Available Channel	Tested Channel	Channel Bandwidth	Modulation	Mode	
Output Power & ERP	20407 to 20643	20407, 20525, 20643	1.4MHz	QPSK, 16QAM	1RB/3RB/6RB	
	20415 to 20635	20415, 20525, 20635	3MHz	QPSK, 16QAM	1RB/8RB/15RB	
	20425 to 20625	20425, 20525, 20625	5MHz	QPSK, 16QAM	1RB/12RB/25RB	
	20450 to 20600	20450, 20525, 20600	10MHz	QPSK, 16QAM	1RB/25RB/50RB	
Occupied Bandwidth	20407 to 20643	20407, 20525, 20643	1.4MHz	QPSK, 16QAM	6 RB	
	20415 to 20635	20415, 20525, 20635	3MHz	QPSK, 16QAM	15 RB	
	20425 to 20625	20425, 20525, 20625	5MHz	QPSK, 16QAM	25 RB	
	20450 to 20600	20450, 20525, 20600	10MHz	QPSK, 16QAM	50 RB	
Conducted Emission	20407 to 20643	20525	1.4MHz	QPSK	1 RB	
	20425 to 20625	20525	5MHz	QPSK	1 RB	
	20450 to 20600	20525	10MHz	QPSK	1 RB	
Radiated Emission	20407 to 20643	20525	1.4MHz	QPSK	1 RB	
	20425 to 20625	20525	5MHz	QPSK	1 RB	
	20450 to 20600	20525	10MHz	QPSK	1 RB	
Band Edge	20407 to 20643	20407	1.4MHz	QPSK	1 RB	
		20643	1.4MHz	QPSK	6 RB	
	20415 to 20635	20415	3MHz	QPSK	1 RB	
		20635	3MHz	QPSK	15 RB	
	20425 to 20625	20425	5MHz	QPSK	1 RB	
		20625	5MHz	QPSK	25 RB	
	20450 to 20600	20450	10MHz	QPSK	1 RB	
		20600	10MHz	QPSK	50 RB	
	Peak To Average Ratio	20407 to 20643	20407, 20525, 20643	1.4MHz	QPSK, 16QAM	1 RB
		20415 to 20635	20415, 20525, 20635	3MHz	QPSK, 16QAM	1 RB
		20425 to 20625	20425, 20525, 20625	5MHz	QPSK, 16QAM	1 RB
		20450 to 20600	20450, 20525, 20600	10MHz	QPSK, 16QAM	1 RB
Frequency Stability	20407 to 20643	20525	1.4MHz	QPSK	1 RB	
	20415 to 20635	20525	3MHz	QPSK	1 RB	
	20425 to 20625	20525	5MHz	QPSK	1 RB	
	20450 to 20600	20525	10MHz	QPSK	1 RB	

2.3 BLOCK DIGRAM SHOWING THE CONFIGURATIONOFSYSTEMTESTED

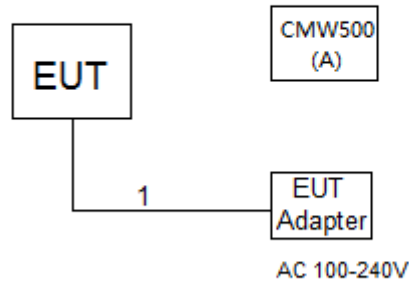

3.4 DESCRIPTION OF SUPPORT UNITS

The EUT has been tested as an independent unit together with other necessary accessories or support units. The following support units or accessories were used to form a representative test configuration during the tests.

Item	Equipment	Mfr/Brand	Model/Type No.	Series No.
A	CMW500	N/A	N/A	131463

Item	Cable Type	Shielded Type	Ferrite Core	Length
1	DC Cable	NO	NO	1.5m

3. TEST RESULT

3.1 OUTPUT POWER MEASUREMENT

3.1.1 LIMIT

Mobile / Portable station are limited to 7 watts e.r.p.

3.1.2 TEST PROCEDURE

EIRP/ ERP:

1. EIRP= Output Power +Antenan gain
ERP power= EIPR power-2.15dBi.

Output Power:

The EUT was set up for the maximum power with GSM, GPRS, EDGE, WCDMA and LTE link data modulation and link up with simulator. Set the EUT to transmit under low, middle and high channel and record the power level shown on simulator.

3.1.3 TEST SETUP LAYOUT

Output Power Measurement

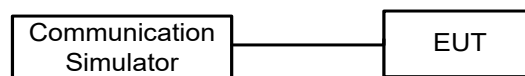

3.1.4 TEST DEVIATION

No deviation

3.1.5 TEST RESULTS

Please refer to the Appendix A.

3.2 OCCUPIED BANDWIDTH MEASUREMENT

3.2.1 TEST PROCEDURE

The EUT makes a call to the communication simulator. All measurements were done at low, middle and high operational frequency range. The communication simulator station system controlled a EUT to export maximum output power under transmission mode and specific channel frequency. Use OBW measurement function of Spectrum analyzer to measure 99 % occupied bandwidth and 26dB bandwidth.

3.2.2 TEST SETUP LAYOUT

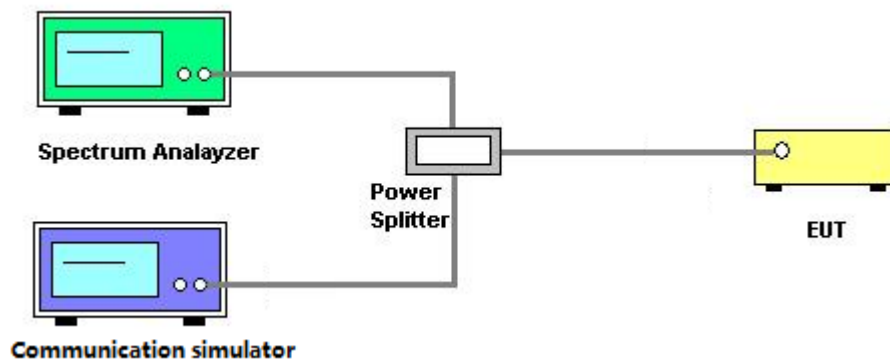

3.2.3 TEST DEVIATION

No deviation

3.2.4 TEST RESULTS

Please refer to the Appendix B.

3.3 CONDUCTED EMISSIONS MEASUREMENT

3.3.1 LIMIT

The power of any emission outside of the authorized operating frequency ranges must be attenuated below the transmitting power (P) by a factor of at least $43 + 10 \log(P)$ dB. The emission limit equal to -13dBm.

3.3.2 TEST PROCEDURES

1. The testing follows FCC KDB 971168 v03r01 Section 6.0.
2. The EUT was connected to spectrum analyzer and system simulator via a power divider.
3. The band edges of low and high channels for the highest RF powers were measured. Set RBW $\geq 1\%$ EBW in the 1MHz band immediately outside and adjacent to the band edge.
4. Set spectrum analyzer with RMS detector.
5. The RF fundamental frequency should be excluded against the limit line in the operating frequency band.

3.3.3 TEST SETUP LAYOUT

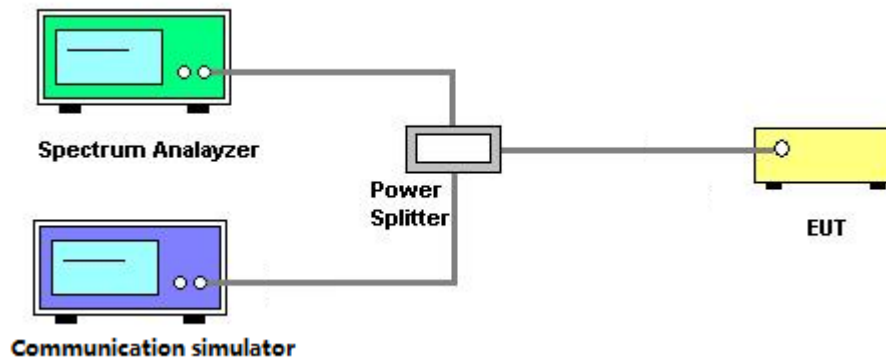

3.3.4 TEST DEVIATION

No deviation

3.3.5 TEST RESULTS

Please refer to the Appendix C.

3.4 RADIATED EMISSIONS MEASUREMENT

3.4.1 LIMIT

The power of any emission outside of the authorized operating frequency ranges must be attenuated below the transmitting power (P) by a factor of at least $43 + 10 \log(P)$ dB. The emission limit equal to -13dBm.

3.4.2 TEST PROCEDURES

1. Substitution method is used for E.I.R.P measurement. In the semi-anechoic chamber, EUT placed on the 0.8m height of Turn Table, rotated the table around 360 degrees to search the maximum radiation power and receiver antenna shall be rotated vertical and horizontal polarization and moved height from 1m to 4m to find the maximum polar radiated power. The "Read Value" is the spectrum reading the maximum power value.
2. The substitution horn antenna is substituted for EUT at the same position and signals generator export the CW signal to the substitution antenna via a TX cable. Rotated the Turn Table and moved receiving antenna to find the maximum radiation power. Adjust output power level of S.G to get a Value of spectrum reading equal to "Read Value " of step a. Record the power level of S.G
3. $EIRP = \text{Output power level of S.G} - \text{TX cable loss} + \text{Antenna gain of substitution horn.}$
4. E.R.P power can be calculated form E.I.R.P power by subtracting the gain of dipole, $E.R.P \text{ power} = E.I.P.R \text{ power} - 2.15\text{dBi.}$
5. The resolution bandwidth and video bandwidth of test receiver/spectrum analyzer is 1MHz/3MHz.

3.4.3 TEST SETUP LAYOUT

Below 30MHz

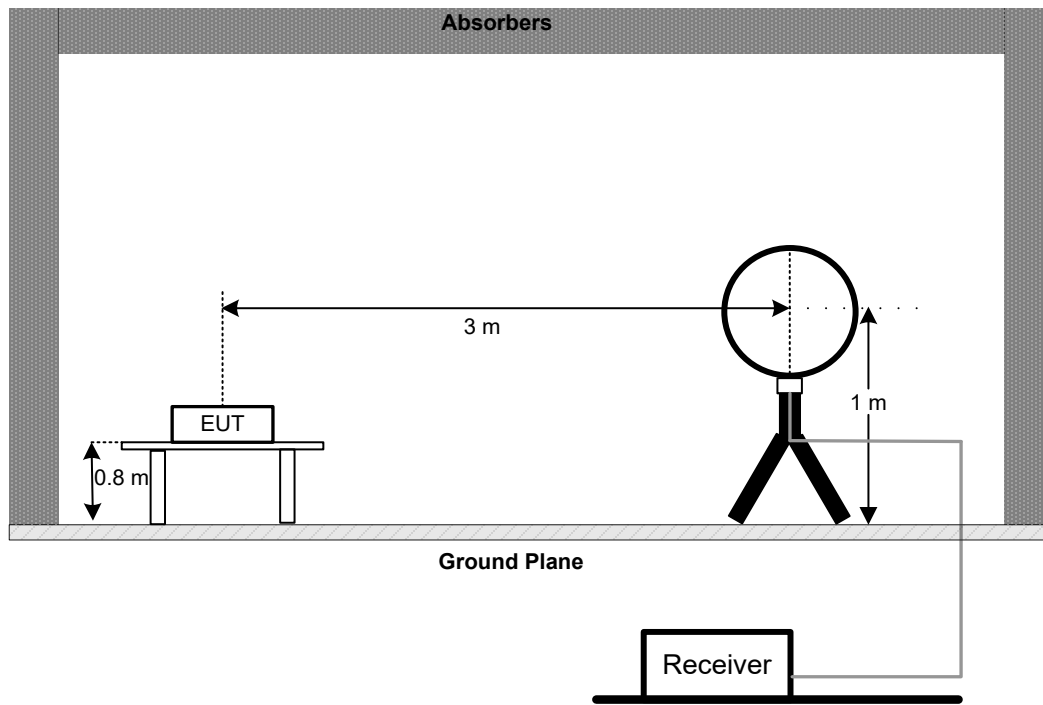

30MHz to 1GHz

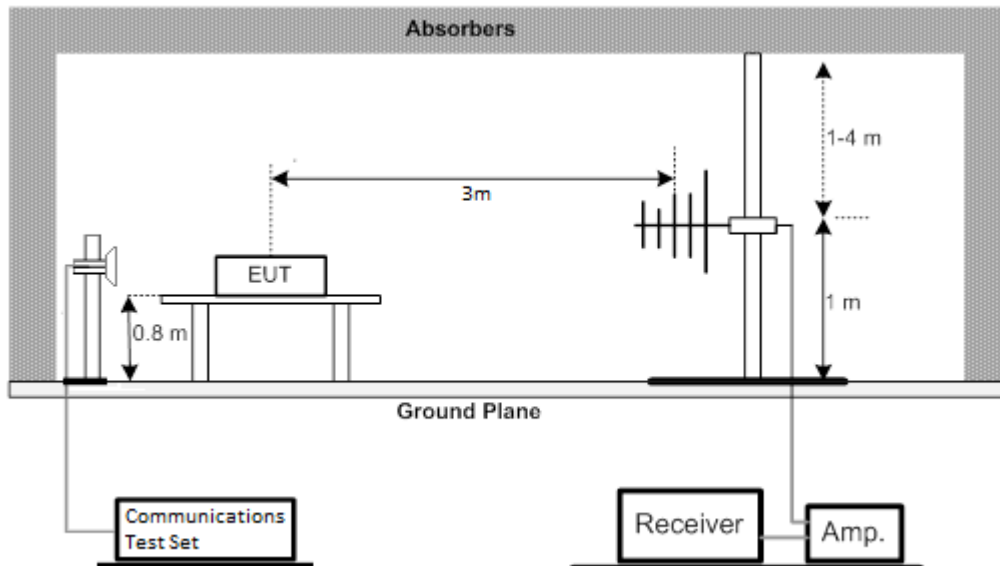

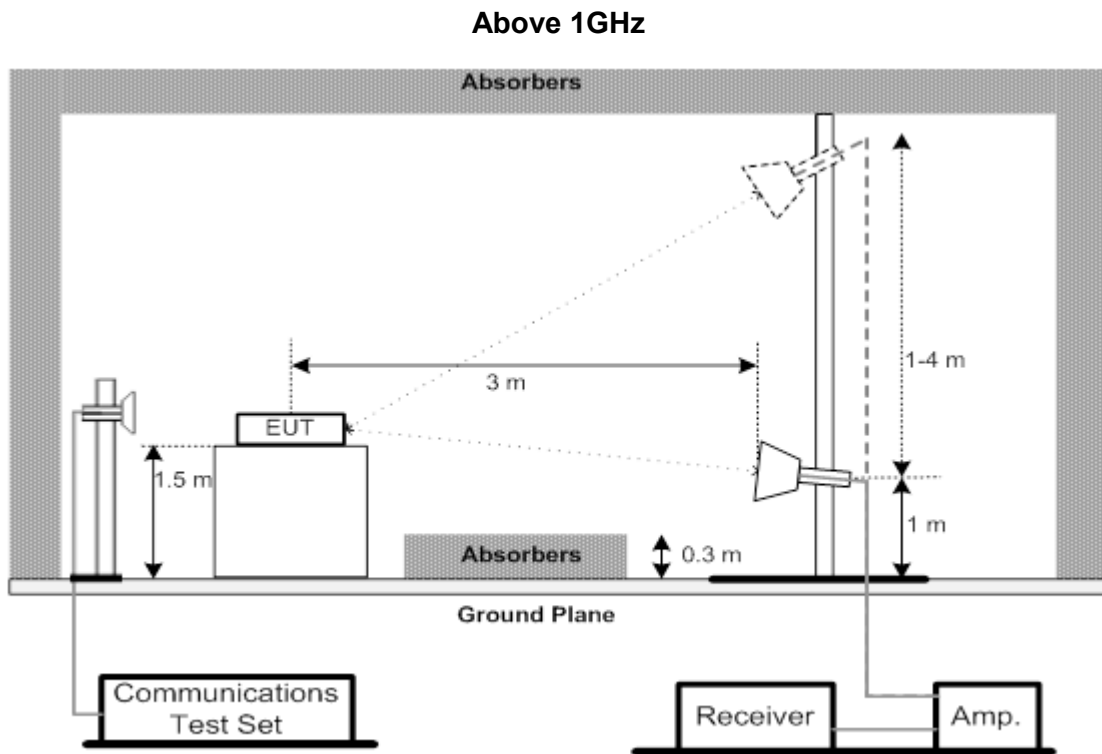

3.4.4 TEST DEVIATION

No deviation

3.4.5 TEST RESULTS (9KHZ TO 30MHZ)

Please refer to the Appendix D.

3.4.6 TEST RESULTS (30MHZ TO 1000MHZ)

Please refer to the Appendix E.

3.4.7 TEST RESULTS (ABOVE 1000MHZ)

Please refer to the Appendix F.

3.5 BAND EDGE MEASUREMENT

3.5.1 LIMIT

A Power of any emission outside of the authorized operating frequency ranges must be attenuated below the transmitting power (P) by a factor of at least $43 + 10 \log(P)$ dB. In the 1 MHz bands immediately outside and adjacent to the frequency block a resolution bandwidth of at least one percent of the emission bandwidth of the fundamental emission of the transmitter may be employed.

3.5.2 TEST PROCEDURES

1. All measurements were done at low and high operational frequency range.
2. The center frequency of spectrum is the band edge frequency and span is 1.5MHz. RB of the spectrum is 3kHz and VB of the spectrum is 10kHz (GSM/EDGE).
3. The center frequency of spectrum is the band edge frequency and span is 10MHz. RB of the spectrum is 100kHz and VB of the spectrum is 300kHz (WCDMA).
4. The center frequency of spectrum is the band edge frequency and span is 2MHz. RB of the spectrum is 15kHz and VB of the spectrum is 43kHz (LTE Bandwidth 1.4MHz).
5. The center frequency of spectrum is the band edge frequency and span is 2MHz. RB of the spectrum is 30kHz and VB of the spectrum is 91kHz (LTE Bandwidth 3MHz).
6. The center frequency of spectrum is the band edge frequency and span is 2MHz. RB of the spectrum is 51kHz and VB of the spectrum is 150kHz (LTE Bandwidth 5MHz).
7. The center frequency of spectrum is the band edge frequency and span is 2MHz. RB of the spectrum is 100kHz and VB of the spectrum is 300kHz (LTE Bandwidth 10MHz).
8. The center frequency of spectrum is the band edge frequency and span is 2MHz. RB of the spectrum is 150kHz and VB of the spectrum is 470kHz (LTE Bandwidth 15MHz).
9. The center frequency of spectrum is the band edge frequency and span is 2MHz. RB of the spectrum is 200kHz and VB of the spectrum is 620kHz (LTE Bandwidth 20MHz).

3.5.3 TEST SETUP LAYOUT

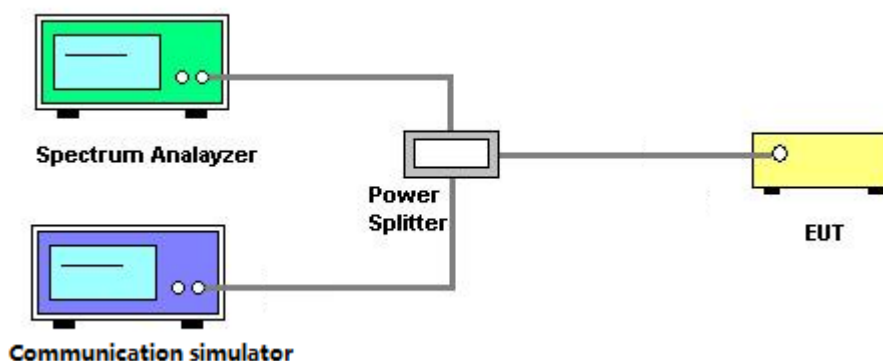

3.5.4 TEST DEVIATION

No deviation

3.5.5 TEST RESULTS

Please refer to the Appendix G.

3.6 PEAK TO AVERAGE RATIO MEASUREMENT

3.6.1 LIMIT

In measuring transmissions in this band using an average power technique, the peak to-average ratio (PAR) of the transmission may not exceed 13 dB.

3.6.2 TEST PROCEDURES

1. Set resolution/measurement bandwidth \geq signal's occupied bandwidth;
2. Set the number of counts to a value that stabilizes the measured CCDF curve;
3. Record the maximum PAPR level associated with a probability of 0.1%.

3.6.3 TEST SETUP LAYOUT

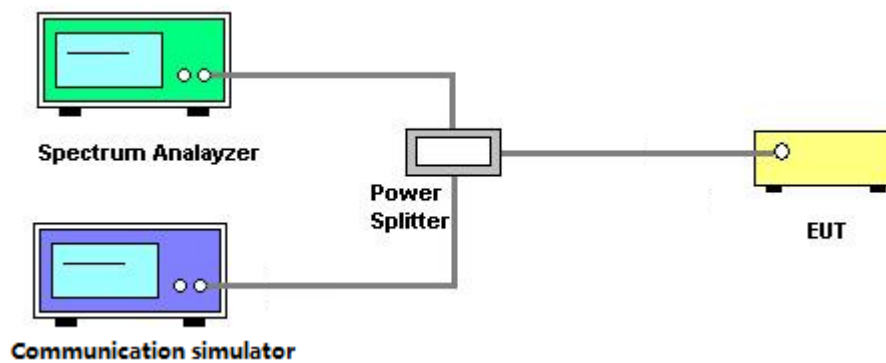

3.6.4 TEST DEVIATION

No deviation

3.6.5 TEST RESULTS

Please refer to the Appendix H.

3.7 FREQUENCY STABILITY MEASUREMENT

3.7.1 LIMIT

± 1.5 ppm is for base and fixed station. ± 2.5 ppm is for mobile station.

3.7.2 TEST PROCEDURES

1. Device is placed at the oven room. The oven room could control the temperatures and humidity. Power warm up is at least 15 min and power applied should perform before recording frequency error.
2. EUT is connected the external power supply to control the DC input power. The test voltage range is from minimum to maximum working voltage. Each step shall be record the frequency error rate.
3. The temperature range step is 10 degrees in this test items. All temperature levels shall be hold the $\pm 0.5^{\circ}\text{C}$ during the measurement testing. The each temperature step shall be at least 0.5 hours, consider the EUT could be test under the stability condition.
4. The frequency error was recorded frequency error from the communication simulator.

3.7.3 TEST SETUP LAYOUT

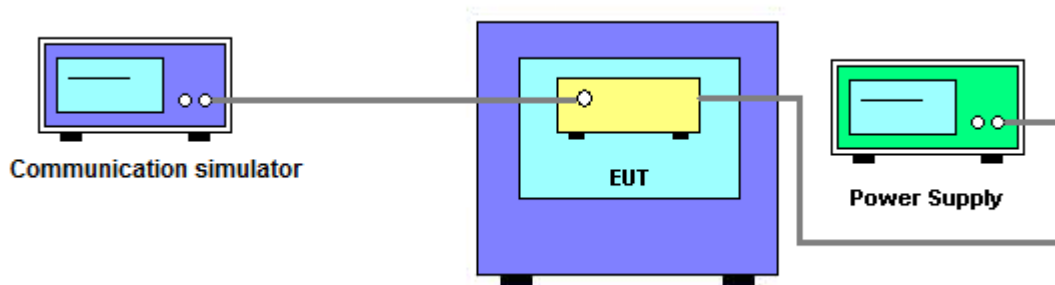

3.7.4 TEST DEVIATION

No deviation

3.7.5 TEST RESULTS

Please refer to the Appendix I.

5. LIST OF MEASUREMENT EQUIPMENTS

Radiated Emission Measurement(9K-30M)					
Item	Kind of Equipment	Manufacturer	Type No.	Serial No.	Calibrated until
1	Loop Antenna	EMCI	EMCI LPA600	275	Apr. 14, 2022
2	EMI Test Receiver	R&S	ESCI	100082	Mar. 21, 2022
3	Measurement Software	Farad	EZ-EMC Ver.NB-03A1-01	N/A	N/A
4	Wideband Radio Communication Test	R&S	CMW500	129246	Aug. 23, 2021

Radiated Emission Measurement(30M-1G)					
Item	Kind of Equipment	Manufacturer	Type No.	Serial No.	Calibrated until
1	TRILOG Broadband Antenna	Schwarzbeck	VULB 9168	719	Mar. 26, 2022
2	Pre-Amplifier	emci	EMC9135	980400	Mar. 20, 2022
3	MXE EMI Receiver	Keysight	N9038A	MY56400088	Mar. 21, 2022
4	Test Cable	emci	EMC104-SM-SM-7000	170330	Apr. 11, 2022
5	Test Cable	emci	EMC104-SM-SM-1000	170331	Apr. 11, 2022
6	Test Cable	emci	EMC104-SM-NM-3500	170621	Apr. 11, 2022
7	Measurement Software	Farad	EZ-EMC Ver.NB-03A1-01	N/A	N/A
8	Wideband Radio Communication Test	R&S	CMW500	129246	Aug. 23, 2021

Radiated Emission Measurement(1G-18G)					
Item	Kind of Equipment	Manufacturer	Type No.	Serial No.	Calibrated until
1	Double-Ridged Waveguide Horn Antenna	ETS-Lindgren	9120D	00206960	Mar. 26, 2022
2	Pre-Amplifier	emci	EMC012645SE	980421	May. 11, 2021
3	EXA Spectrum Analyzer	Keysight	N9010A	MY56480545	Mar. 20, 2022
4	Test Cable	emci	EMC104-SM-SM-7000	170330	Apr. 11, 2022
5	Test Cable	emci	EMC104-SM-SM-1000	170331	Apr. 11, 2022
6	Test Cable	emci	EMC104-SM-NM-3500	170621	Apr. 11, 2022
7	Measurement Software	Farad	EZ-EMC Ver.NB-03A1-01	N/A	N/A
8	Wideband Radio Communication Test	R&S	CMW500	129246	Aug. 23, 2021

For WCDMA

Conducted Emission & Band Edge & Occupied Bandwidth Measurement					
Item	Kind of Equipment	Manufacturer	Type No.	Serial No.	Calibrated until
1	Wideband Radio Communication Test	R&S	CMW500	129246	Aug. 23, 2021
2	Spectrum Analyzer	R&S	FSP40	100626	May. 06, 2021 May. 05, 2022
3	EXA Spectrum Analyzer	Keysight	N9010A	MY56480579	Mar. 21, 2022
4	Power Divider	JUK	PD-2SF-2060	N/A	N/A

Frequency Stability Measurement					
Item	Kind of Equipment	Manufacturer	Type No.	Serial No.	Calibrated until
1	Wideband Radio Communication Test	R&S	CMW500	129246	Aug. 23, 2021
2	Spectrum Analyzer	R&S	FSP40	100626	May. 06, 2021 May. 05, 2022
3	EXA Spectrum Analyzer	Keysight	N9010A	MY56480579	Mar. 21, 2022
4	Power Divider	JUK	PD-2SF-2060	N/A	N/A
5	Temperature And Humidity Box	Blue pand	BPHS-120B	170616454	Aug. 23, 2021

For LTE

Conducted Emission & Band Edge & Occupied Bandwidth Measurement					
Item	Kind of Equipment	Manufacturer	Type No.	Serial No.	Calibrated until
1	EXA Spectrum Analyzer	Keysight	N9010A	MY56480579	Mar. 21, 2022
2	Power Divider	JUK	PD-4SF-2060	N/A	N/A
3	Wideband Radio Communication Test	R&S	CMW500	129246	Aug. 23, 2021
4	Spectrum Analyzer	R&S	FSP40	100626	May. 06, 2021 May. 05, 2022

Frequency Stability Measurement					
Item	Kind of Equipment	Manufacturer	Type No.	Serial No.	Calibrated until
1	EXA Spectrum Analyzer	Keysight	N9010A	MY56480579	Mar. 21, 2022
2	Power Divider	JUK	PD-4SF-2060	N/A	N/A
3	Wideband Radio Communication Test	R&S	CMW500	129246	Aug. 23, 2021
4	Spectrum Analyzer	R&S	FSP40	100626	May. 06, 2021 May. 05, 2022
5	Temperature And Humidity Box	Blue pand	BPHS-120B	170616454	Aug. 23, 2021

Remark: "N/A" denotes no model name, serial no. or calibration specified.

All calibration period of equipment list is one year.

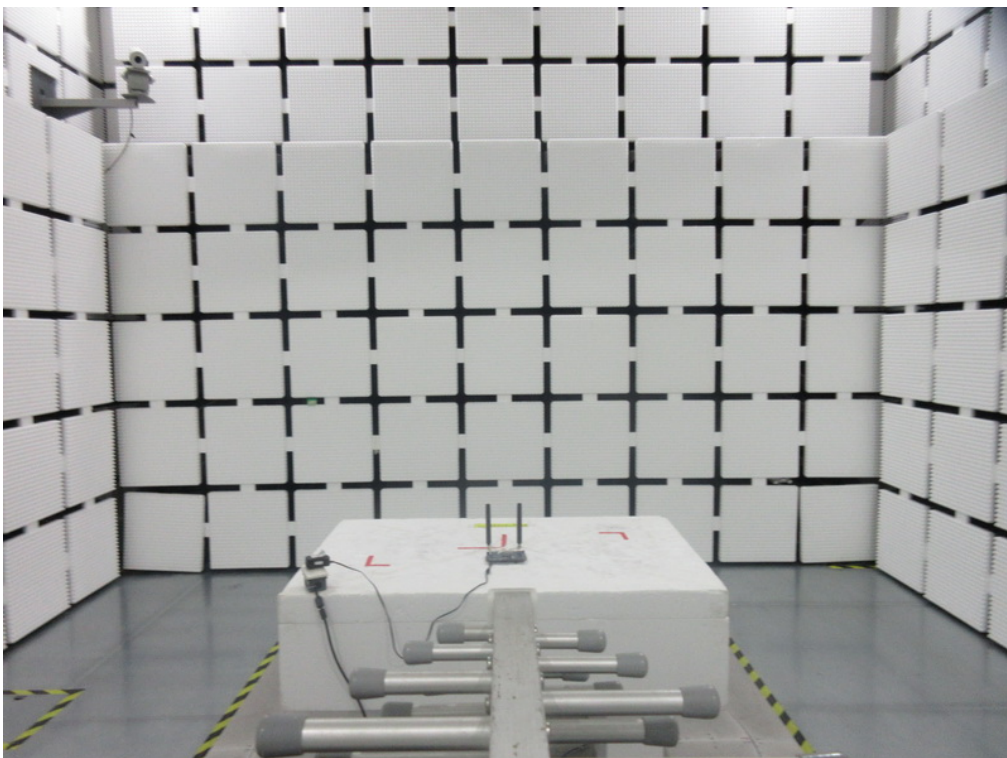
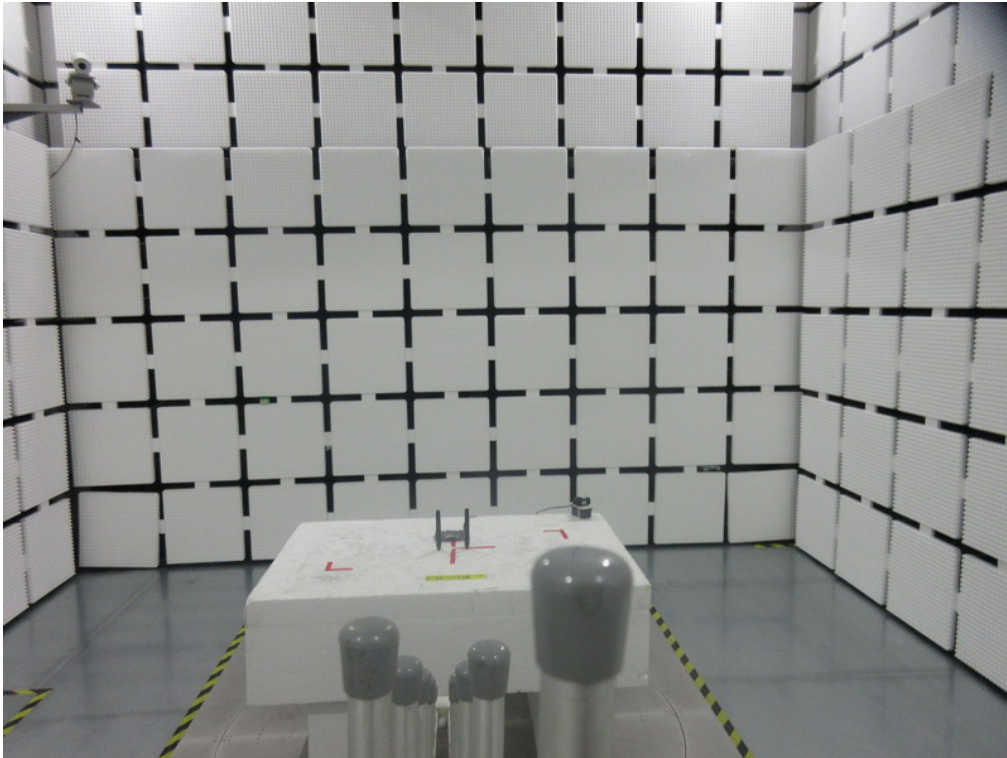
6. EUT TEST PHOTO**Radiated Emissions Test Photos****30 MHz to 1000 MHz**

Radiated Emissions Test Photos

Above 1 GHz

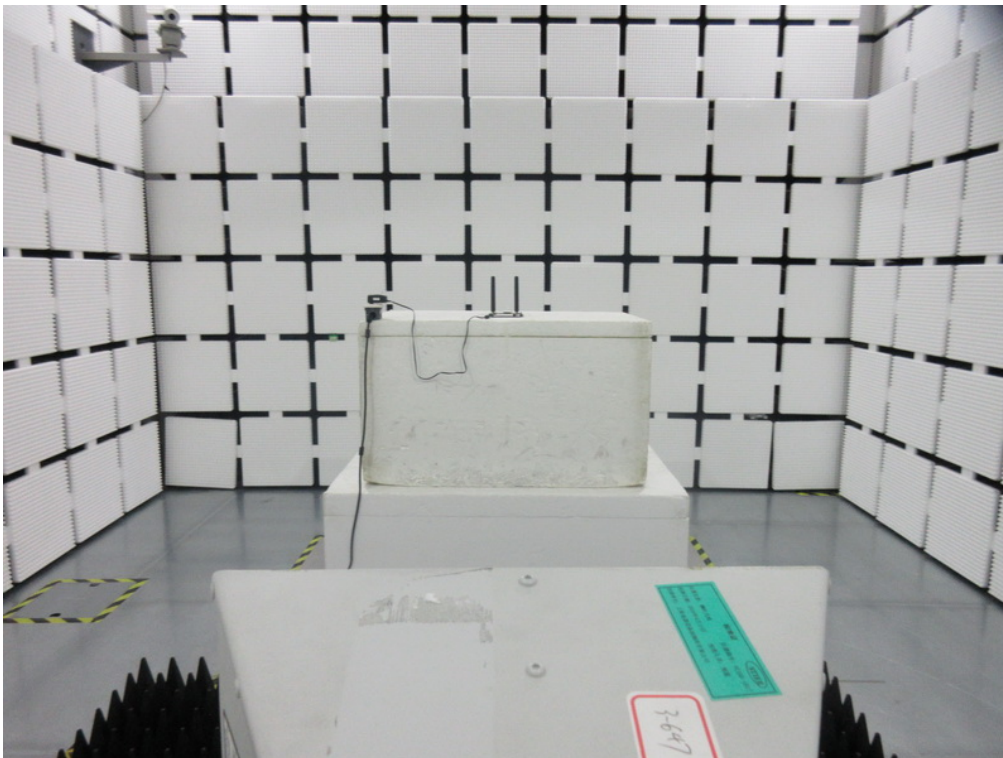
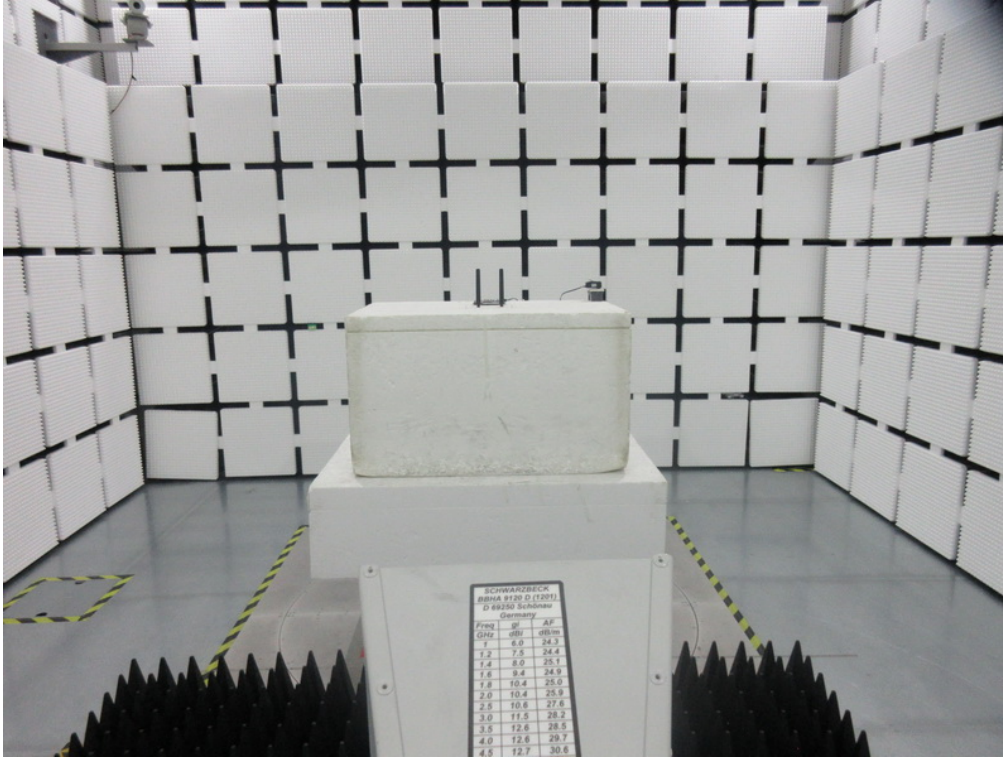

APPENDIX A - OUTPUT POWER

Output Power (dBm):

GSM850		Burst Output Power		
		128CH	190CH	251CH
		824.2MHz	836.6MHz	848.8MHz
GSM(GMSK)		32.72	32.69	32.75
GPRS/EDGE (GMSK)	1 Tx Slot	32.61	32.55	32.64
	2 Tx Slot	31.27	31.21	31.19
	3 Tx Slot	30.06	30.14	30.08
	4 Tx Slot	28.79	28.75	28.83
EDGE (8PSK)	1 Tx Slot	26.47	26.42	26.57
	2 Tx Slot	24.64	24.36	24.51
	3 Tx Slot	22.72	22.77	22.84
	4 Tx Slot	21.87	21.79	21.93

Modulation	Band	WCDMA V		
	Tx Channel	4132CH	4182CH	4233CH
	Frequency	826.4MHz	836.4MHz	846.6MHz
QPSK	RMC 12.2K	23.46	23.39	23.44
	RMC 64K	23.52	23.4	23.44
	RMC 144K	23.50	23.37	23.43
	RMC 384K	23.49	23.43	23.42
	HSDPA Subtest-1	23.06	22.94	23.00
	HSDPA Subtest-2	22.75	22.73	22.71
	HSDPA Subtest-3	22.60	22.59	22.60
	HSDPA Subtest-4	22.41	22.47	22.51
	HSUPA Subtest-1	22.41	22.39	22.84
	HSUPA Subtest-2	22.33	22.17	22.63
	HSUPA Subtest-3	22.21	22.11	22.59
	HSUPA Subtest-4	22.14	21.85	22.44
	HSUPA Subtest-5	22.02	21.70	22.35

LTE Band / BW	Modulation	RB Size	RB Offset	Low CH	Mid CH	High CH
				20407CH	20525CH	20643CH
				824.7MHz	836.5MHz	848.3MHz
5 / 1.4M	QPSK	1	0	22.72	23.06	22.89
		1	2	22.71	23.02	22.93
		1	5	22.70	23.04	22.84
		3	0	22.86	22.81	22.77
		3	1	22.84	22.79	22.75
		3	2	22.85	22.82	22.76
	16QAM	6	0	21.98	21.92	21.77
		1	0	20.88	21.89	22.04
		1	2	22.01	21.88	22.01
		1	5	21.60	21.86	22.03
		3	0	21.66	22.11	21.97
		3	1	21.70	22.08	21.96
		3	2	21.81	22.11	21.94
		6	0	20.55	20.93	20.85

LTE Band / BW	Modulation	RB Size	RB Offset	Low CH	Mid CH	High CH
				20415CH	20525CH	20635CH
				825.5MHz	836.5MHz	847.5MHz
5 / 3M	QPSK	1	0	22.84	22.71	22.75
		1	7	22.81	22.68	22.71
		1	14	22.82	22.69	22.69
		8	0	21.83	21.82	21.73
		8	4	21.80	21.78	21.69
		8	7	21.79	21.77	21.71
		15	0	21.80	21.96	21.76
	16QAM	1	0	21.58	21.97	22.45
		1	7	21.56	21.94	22.35
		1	14	21.55	21.92	22.39
		8	0	20.68	21.38	20.45
		8	4	20.65	21.35	20.39
		8	7	20.61	21.32	20.42
		15	0	20.83	21.14	20.49

LTE Band / BW	Modulation	RB Size	RB Offset	Low CH	Mid CH	High CH
				20425CH	20525CH	20625CH
				826.5MHz	836.5MHz	846.5MHz
5 / 5M	QPSK	1	0	22.89	22.85	22.81
		1	13	22.82	22.84	22.78
		1	24	22.85	22.83	22.75
		12	0	21.75	21.71	21.78
		12	6	21.68	21.68	21.74
		12	11	21.66	21.69	21.71
	16QAM	25	0	21.97	21.95	21.81
		1	0	21.69	21.46	20.69
		1	13	21.65	21.40	20.64
		1	24	21.64	21.47	20.61
		12	0	20.90	20.73	20.56
		12	6	20.83	20.68	20.50
		12	11	20.84	20.69	20.55
		25	0	20.95	21.01	20.61

LTE Band / BW	Modulation	RB Size	RB Offset	Low CH	Mid CH	High CH
				20450CH	20525CH	20600CH
				829.0MHz	836.5MHz	844.0MHz
5 / 10M	QPSK	1	0	22.76	22.61	22.78
		1	25	22.68	22.58	22.75
		1	49	22.71	22.59	22.71
		25	0	21.91	21.90	21.87
		25	13	21.88	21.88	21.81
		25	25	21.79	21.90	21.85
		50	0	21.93	21.94	21.76
	16QAM	1	0	21.61	21.66	21.69
		1	25	21.58	21.58	21.65
		1	49	21.56	21.61	21.66
		25	0	20.82	20.85	20.77
		25	13	20.78	20.79	20.74
		25	25	20.79	20.77	20.75
		50	0	20.82	20.85	20.70

ERP Power (dBm):

GSM850		ERP Power		
		128CH	190CH	251CH
		824.2MHz	836.6MHz	848.8MHz
GSM(GMSK)		33.10	33.07	33.13
GPRS/EDGE (GMSK)	1 Tx Slot	32.99	32.93	33.02
	2 Tx Slot	31.65	31.59	31.57
	3 Tx Slot	30.44	30.52	30.46
	4 Tx Slot	29.17	29.13	29.21
EDGE (8PSK)	1 Tx Slot	26.85	26.80	26.95
	2 Tx Slot	25.02	24.74	24.89
	3 Tx Slot	23.10	23.15	23.22
	4 Tx Slot	22.25	22.17	22.31

Modulation	Band	WCDMA V		
	Tx Channel	4132CH	4182CH	4233CH
	Frequency	826.4MHz	836.4MHz	846.6MHz
QPSK	RMC 12.2K	23.84	23.77	23.82
	RMC 64K	23.90	23.78	23.82
	RMC 144K	23.88	23.75	23.81
	RMC 384K	23.87	23.81	23.80
	HSDPA Subtest-1	23.44	23.32	23.38
	HSDPA Subtest-2	23.13	23.11	23.09
	HSDPA Subtest-3	22.98	22.97	22.98
	HSDPA Subtest-4	22.79	22.85	22.89
	HSUPA Subtest-1	22.79	22.77	23.22
	HSUPA Subtest-2	22.71	22.55	23.01
	HSUPA Subtest-3	22.59	22.49	22.97
	HSUPA Subtest-4	22.52	22.23	22.82
	HSUPA Subtest-5	22.40	22.08	22.73

LTE Band / BW	Modulation	RB Size	RB Offset	Low CH	Mid CH	High CH
				20407CH	20525CH	20643CH
				824.7MHz	836.5MHz	848.3MHz
5 / 1.4M	QPSK	1	0	23.10	23.44	23.27
		1	2	23.09	23.40	23.31
		1	5	23.08	23.42	23.22
		3	0	23.24	23.19	23.15
		3	1	23.22	23.17	23.13
		3	2	23.23	23.20	23.14
	16QAM	6	0	22.36	22.30	22.15
		1	0	21.26	22.27	22.42
		1	2	22.39	22.26	22.39
		1	5	21.98	22.24	22.41
		3	0	22.04	22.49	22.35
		3	1	22.08	22.46	22.34
		3	2	22.19	22.49	22.32
		6	0	20.93	21.31	21.23

LTE Band / BW	Modulation	RB Size	RB Offset	Low CH	Mid CH	High CH
				20415CH	20525CH	20635CH
				825.5MHz	836.5MHz	847.5MHz
5 / 3M	QPSK	1	0	23.22	23.09	23.13
		1	7	23.19	23.06	23.09
		1	14	23.20	23.07	23.07
		8	0	22.21	22.20	22.11
		8	4	22.18	22.16	22.07
		8	7	22.17	22.15	22.09
		15	0	22.18	22.34	22.14
	16QAM	1	0	21.96	22.35	22.83
		1	7	21.94	22.32	22.73
		1	14	21.93	22.30	22.77
		8	0	21.06	21.76	20.83
		8	4	21.03	21.73	20.77
		8	7	20.99	21.70	20.80
		15	0	21.21	21.52	20.87

LTE Band / BW	Modulation	RB Size	RB Offset	Low CH	Mid CH	High CH
				20425CH	20525CH	20625CH
				826.5MHz	836.5MHz	846.5MHz
5 / 5M	QPSK	1	0	23.27	23.23	23.19
		1	13	23.20	23.22	23.16
		1	24	23.23	23.21	23.13
		12	0	22.13	22.09	22.16
		12	6	22.06	22.06	22.12
		12	11	22.04	22.07	22.09
	16QAM	25	0	22.35	22.33	22.19
		1	0	22.07	21.84	21.07
		1	13	22.03	21.78	21.02
		1	24	22.02	21.85	20.99
		12	0	21.28	21.11	20.94
		12	6	21.21	21.06	20.88
		12	11	21.22	21.07	20.93
		25	0	21.33	21.39	20.99

LTE Band / BW	Modulation	RB Size	RB Offset	Low CH	Mid CH	High CH
				20450CH	20525CH	20600CH
				829.0MHz	836.5MHz	844.0MHz
5 / 10M	QPSK	1	0	23.14	22.99	23.16
		1	25	23.06	22.96	23.13
		1	49	23.09	22.97	23.09
		25	0	22.29	22.28	22.25
		25	13	22.26	22.26	22.19
		25	25	22.17	22.28	22.23
		50	0	22.31	22.32	22.14
	16QAM	1	0	21.99	22.04	22.07
		1	25	21.96	21.96	22.03
		1	49	21.94	21.99	22.04
		25	0	21.20	21.23	21.15
		25	13	21.16	21.17	21.12
		25	25	21.17	21.15	21.13
		50	0	21.20	21.23	21.08

APPENDIX B - OCCUPIED BANDWIDTH

GSM850					
GSM			EDGE		
GMSK			8PSK		
Channel	Frequency (MHz)	99% Occupied Bandwidth (MHz)	Channel	Frequency (MHz)	99% Occupied Bandwidth (MHz)
128	824.2	0.2417	128	824.2	0.2566
190	836.6	0.2441	190	836.6	0.2585
251	848.8	0.2474	251	848.8	0.2546
Channel	Frequency (MHz)	26dB Bandwidth (MHz)	Channel	Frequency (MHz)	26dB Bandwidth (MHz)
128	824.2	0.3197	128	824.2	0.3304
190	836.6	0.3092	190	836.6	0.3229
251	848.8	0.3157	251	848.8	0.3223

Spectrum Plot

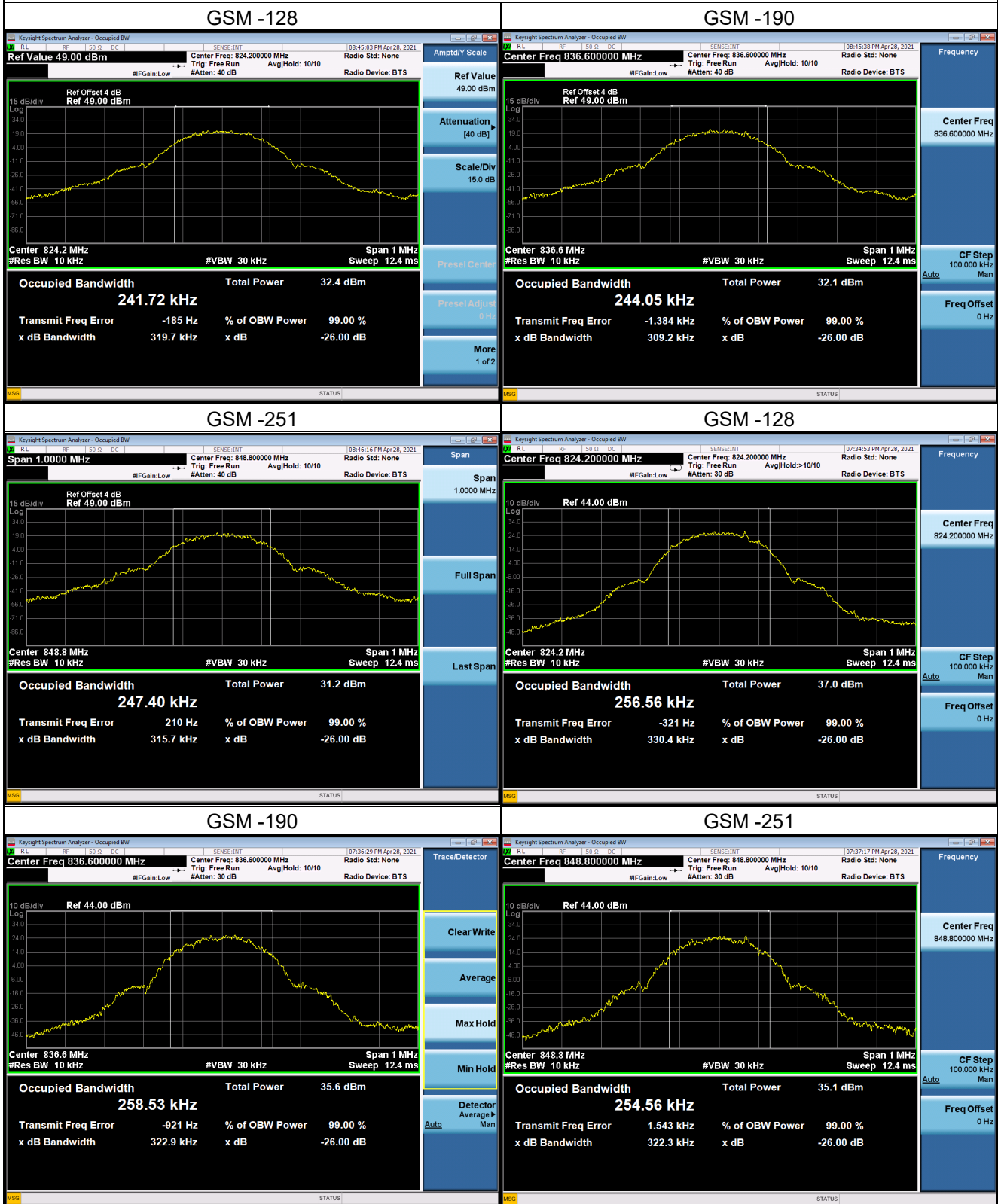

WCDMA Band V					
QPSK					
Channel	Frequency (MHz)	99% Occupied Bandwidth (MHz)	Channel	Frequency (MHz)	26dB Bandwidth (MHz)
4132	826.4	4.1338	4132	826.4	4.716
4182	836.4	4.1478	4182	836.4	4.709
4233	846.6	4.1355	4233	846.6	4.709

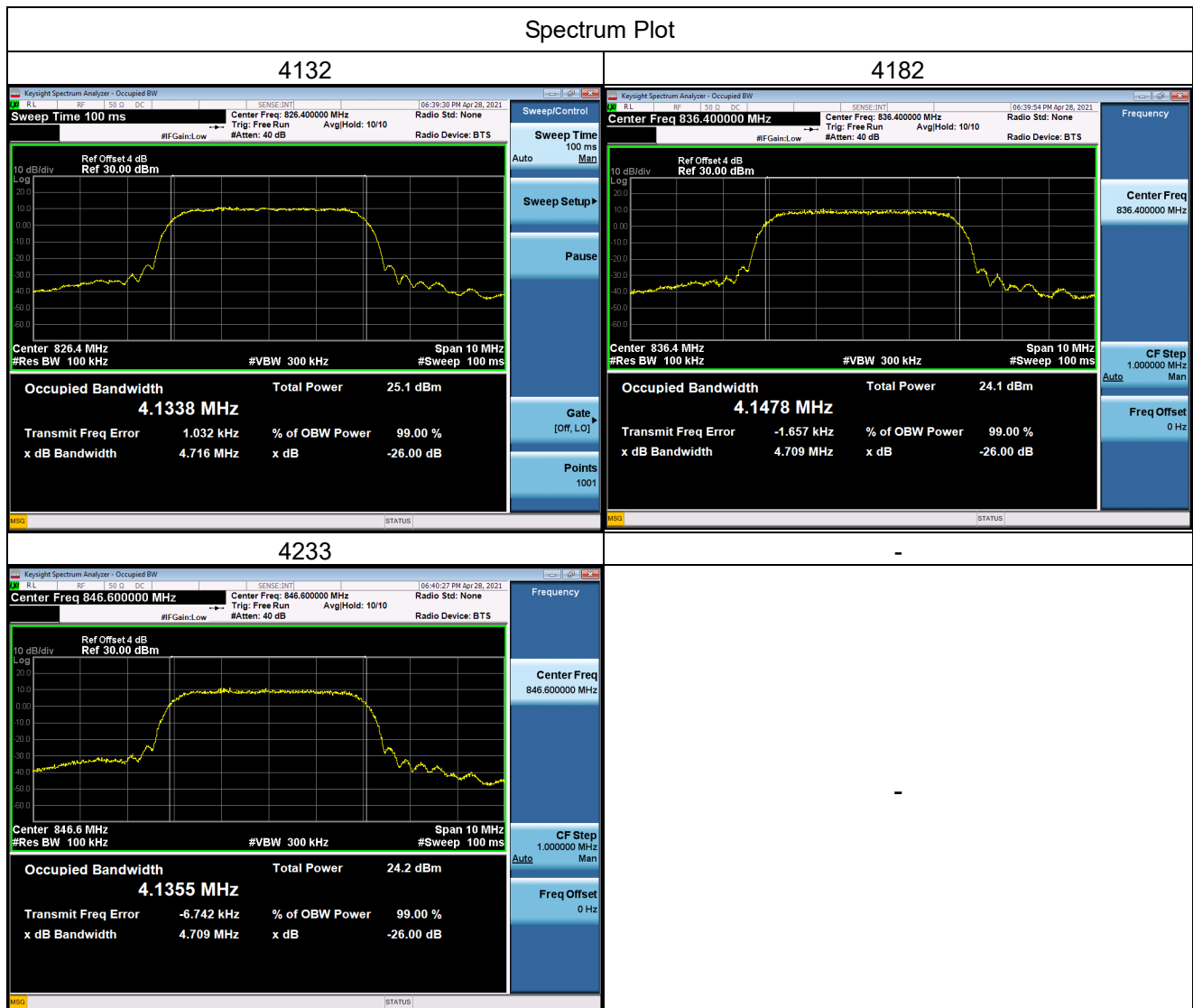

LTE Band 5_1.4M					
QPSK			16QAM		
Channel	Frequency (MHz)	99% Occupied Bandwidth (MHz)	Channel	Frequency (MHz)	99% Occupied Bandwidth (MHz)
20407	824.7	1.0890	20407	824.7	1.0988
20525	836.5	1.1004	20525	836.5	1.0913
20643	848.3	1.0879	20643	848.3	1.0903
Channel	Frequency (MHz)	26dB Bandwidth (MHz)	Channel	Frequency (MHz)	26dB Bandwidth (MHz)
20407	824.7	1.290	20407	824.7	1.289
20525	836.5	1.312	20525	836.5	1.287
20643	848.3	1.274	20643	848.3	1.300

Spectrum Plot

QPSK-20407

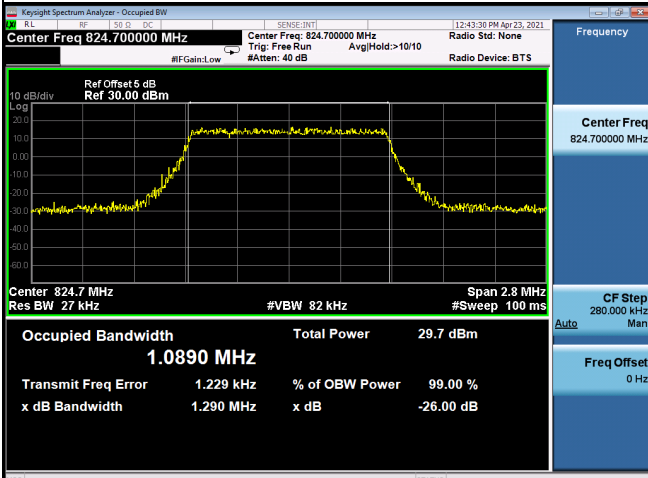

QPSK-20525

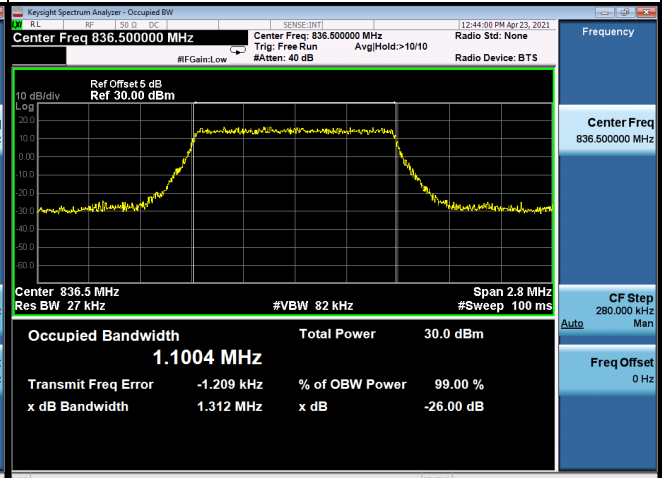

QPSK-20643

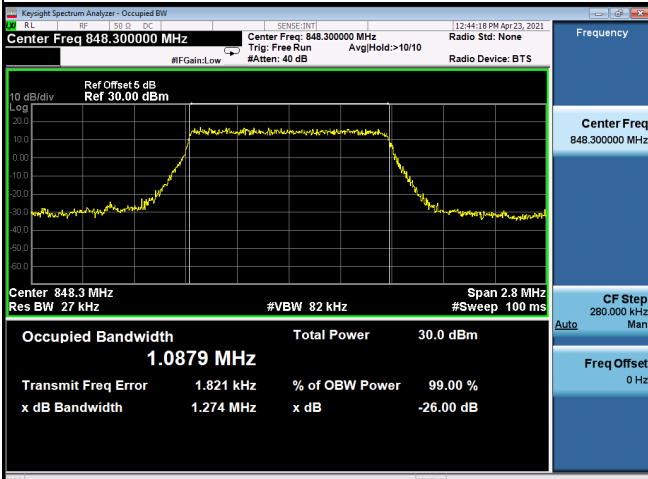

16QAM-20407

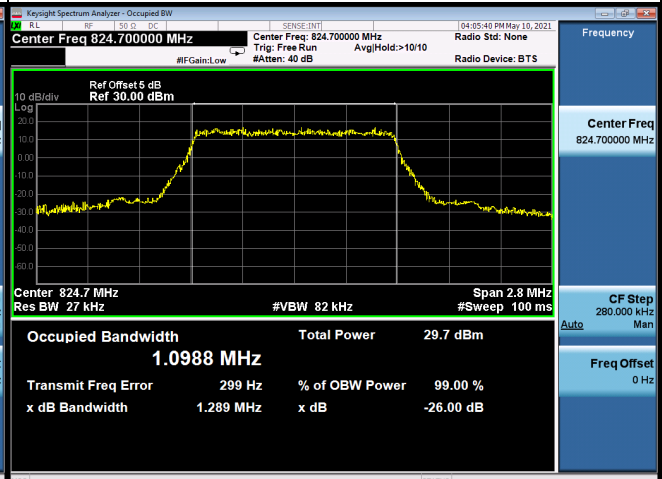

16QAM-20525



16QAM-20643

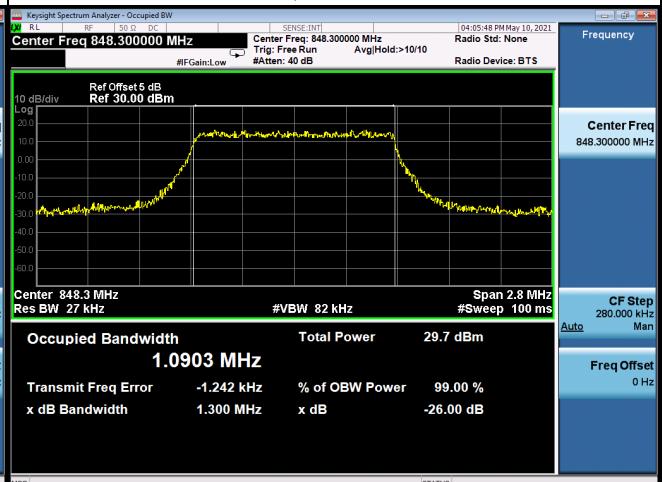

LTE Band 5_3M					
QPSK			16QAM		
Channel	Frequency (MHz)	99% Occupied Bandwidth (MHz)	Channel	Frequency (MHz)	99% Occupied Bandwidth (MHz)
20415	825.5	2.6983	20415	825.5	2.7033
20525	836.5	2.7024	20525	836.5	2.6980
20635	847.5	2.6973	20635	847.5	2.6935
Channel	Frequency (MHz)	26dB Bandwidth (MHz)	Channel	Frequency (MHz)	26dB Bandwidth (MHz)
20415	825.5	2.979	20415	825.5	2.993
20525	836.5	2.981	20525	836.5	2.975
20635	847.5	2.961	20635	847.5	2.986

Spectrum Plot

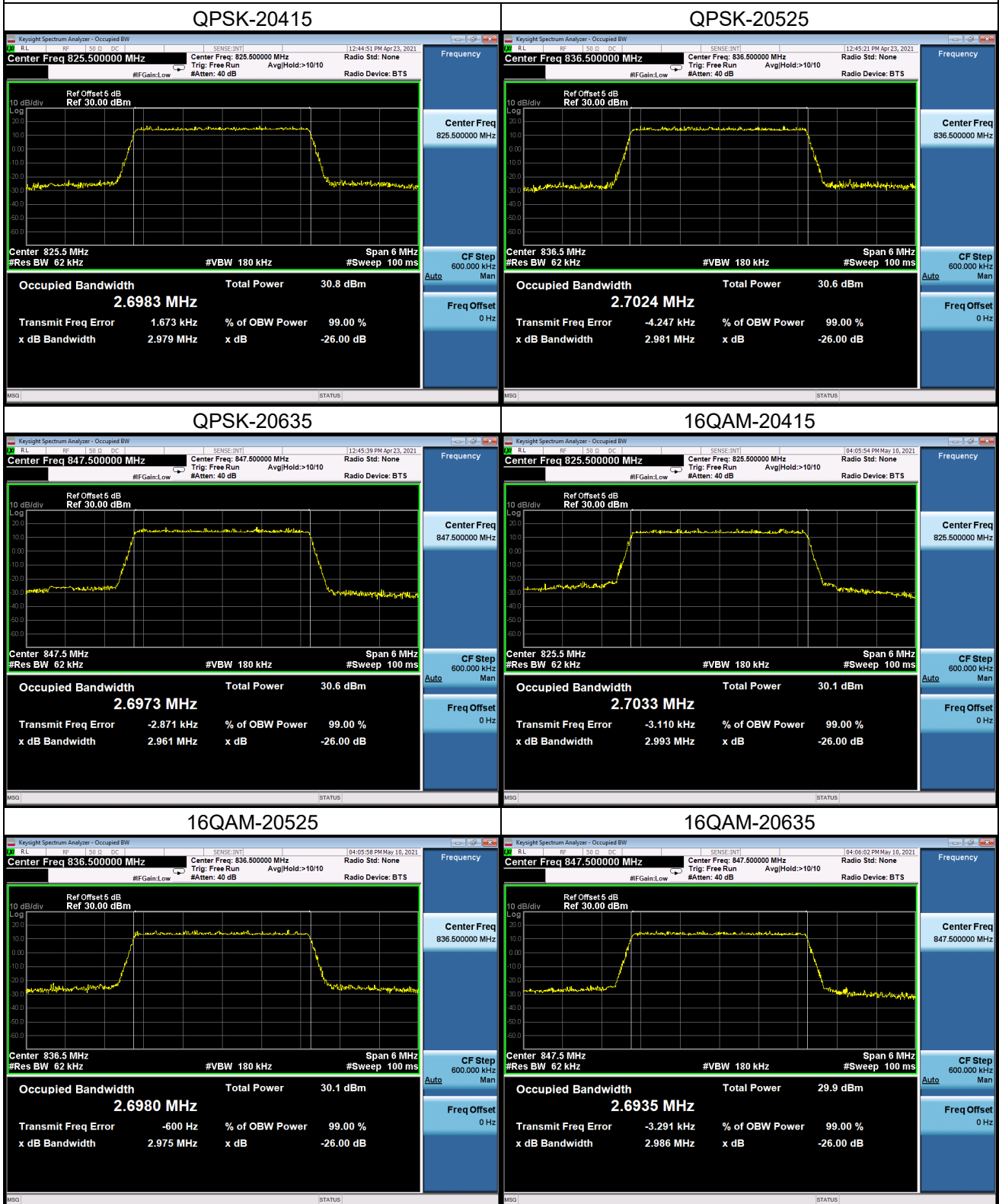

LTE Band 5_5M					
QPSK			16QAM		
Channel	Frequency (MHz)	99% Occupied Bandwidth (MHz)	Channel	Frequency (MHz)	99% Occupied Bandwidth (MHz)
20425	826.5	4.5276	20425	826.5	4.4978
20525	836.5	4.5090	20525	836.5	4.4954
20625	846.5	4.5080	20625	846.5	4.4977
Channel	Frequency (MHz)	26dB Bandwidth (MHz)	Channel	Frequency (MHz)	26dB Bandwidth (MHz)
20425	826.5	5.000	20425	826.5	5.011
20525	836.5	4.954	20525	836.5	5.018
20625	846.5	4.970	20625	846.5	4.940

Spectrum Plot

QPSK-20425

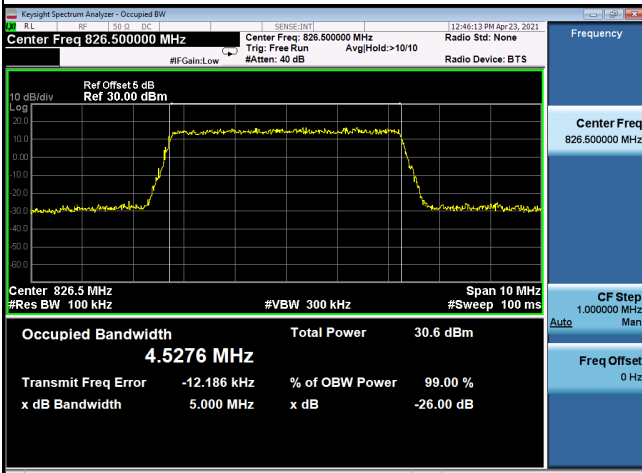

QPSK-20525

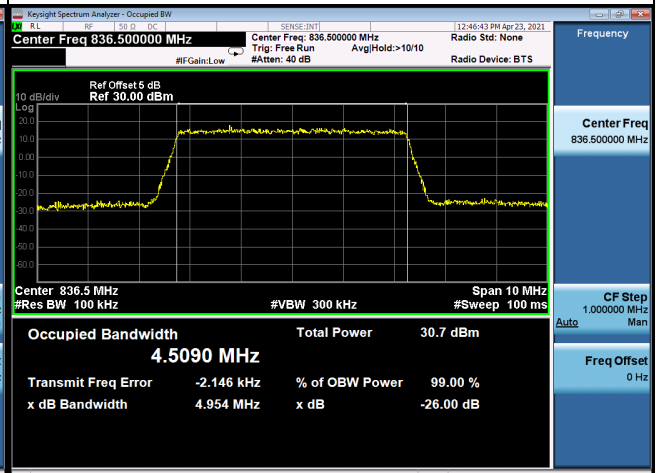

QPSK-20625

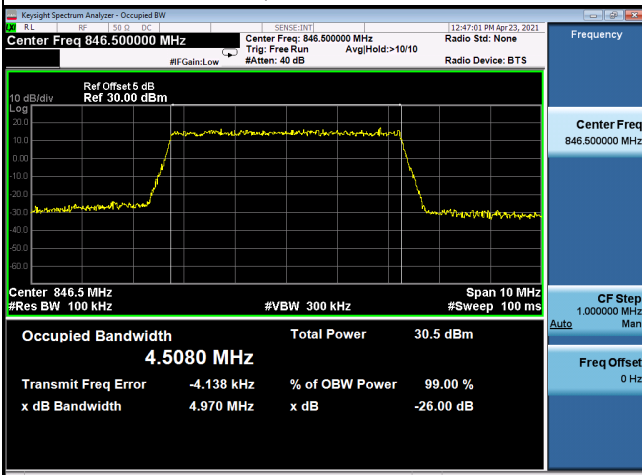

16QAM-20425

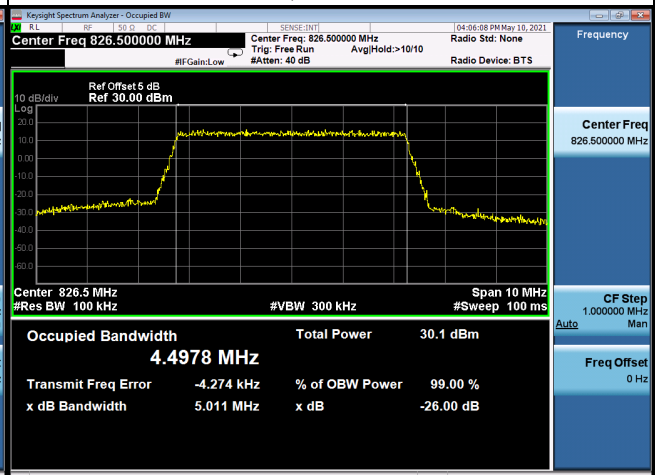

16QAM-20525

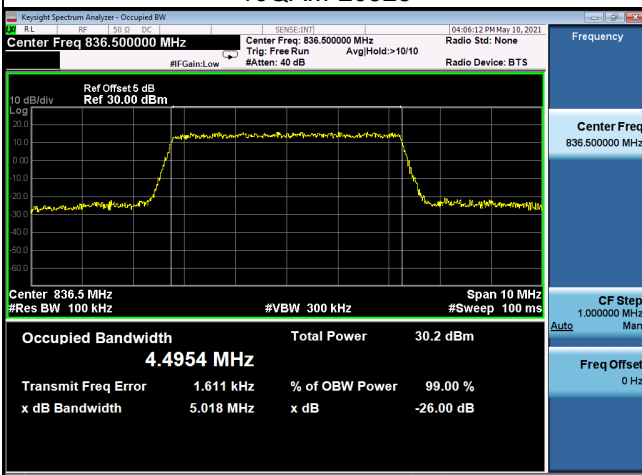

16QAM-20625

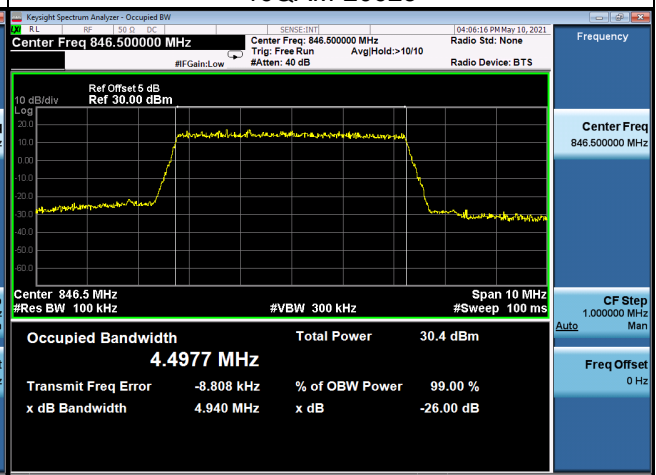

LTE Band 5_10M					
QPSK			16QAM		
Channel	Frequency (MHz)	99% Occupied Bandwidth (MHz)	Channel	Frequency (MHz)	99% Occupied Bandwidth (MHz)
20450	829.0	8.9487	20450	829.0	8.9514
20525	836.5	8.9605	20525	836.5	8.9443
20600	844.0	8.9603	20600	844.0	8.9614
Channel	Frequency (MHz)	26dB Bandwidth (MHz)	Channel	Frequency (MHz)	26dB Bandwidth (MHz)
20450	829.0	9.891	20450	829.0	9.834
20525	836.5	9.937	20525	836.5	9.837
20600	844.0	9.835	20600	844.0	9.753

Spectrum Plot

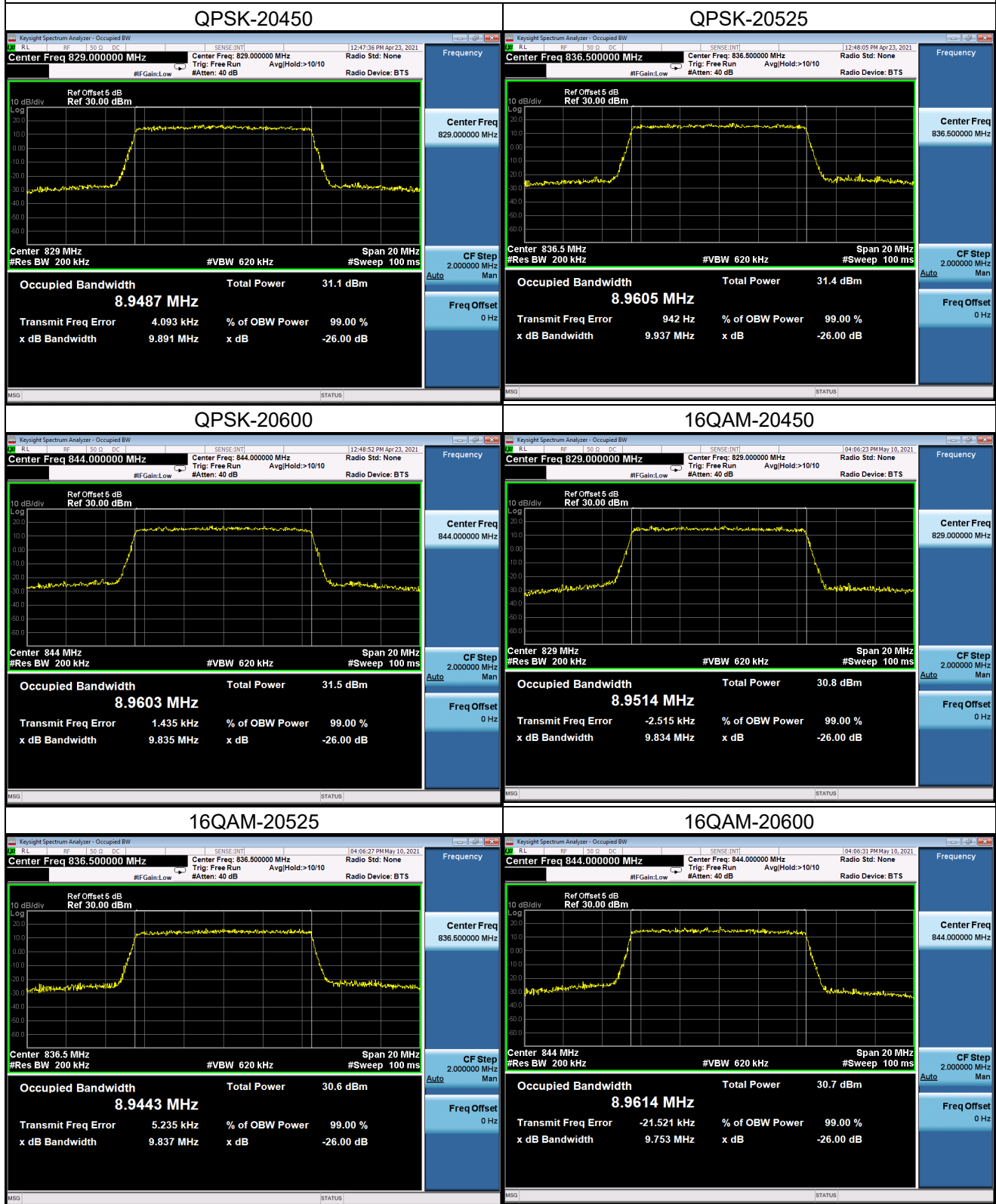

APPENDIX C - CONDUCTED EMISSIONS

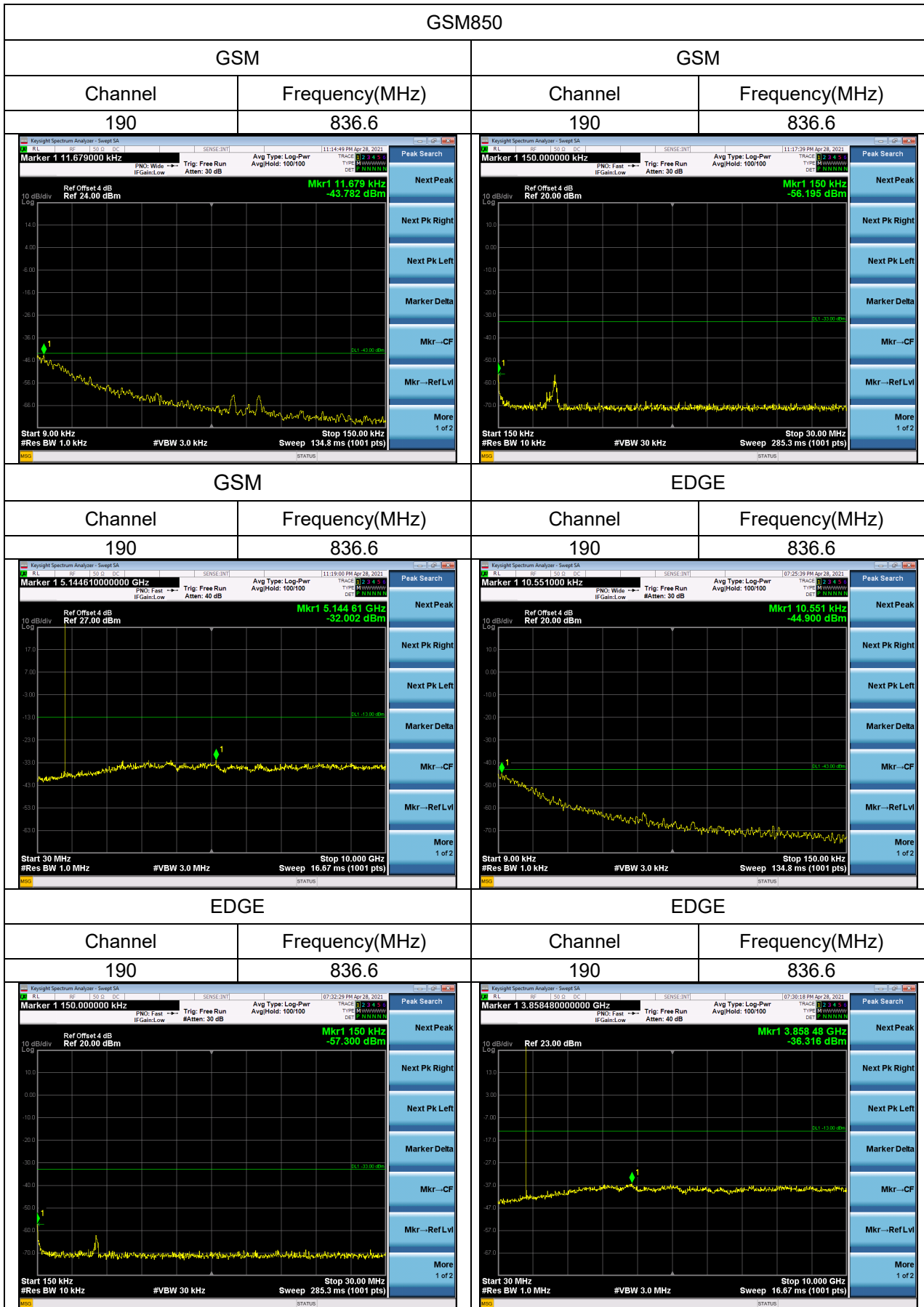

WCDMA Band V			
Channel	Frequency(MHz)	Channel	Frequency(MHz)
4182	836.4	4182	836.4
Channel	Frequency(MHz)	-	-
4182	836.4	-	-
		-	

LTE Band 5_1.4M

Channel	Frequency(MHz)	Channel	Frequency(MHz)
20525	836.5	20525	836.5
Channel	Frequency(MHz)	-	-
20525	836.5	-	-
		-	

LTE Band 5_5M

Channel	Frequency(MHz)	Channel	Frequency(MHz)
20525	836.5	20525	836.5
Channel	Frequency(MHz)	-	-
20525	836.5	-	-
		-	

LTE Band 5_10M

Channel	Frequency(MHz)	Channel	Frequency(MHz)
20525	836.5	20525	836.5
Channel	Frequency(MHz)	-	-
20525	836.5	-	-
		-	

APPENDIX D - RADIATED EMISSION (9KHZ TO 30MHZ)

Note: Below 30MHz, The measured value have enough margin over 20dB than the limit, therefore they are not reported.

APPENDIX E - RADIATED EMISSION (30MHZ TO 1GHZ)

Test Mode: GSM850

Vertical

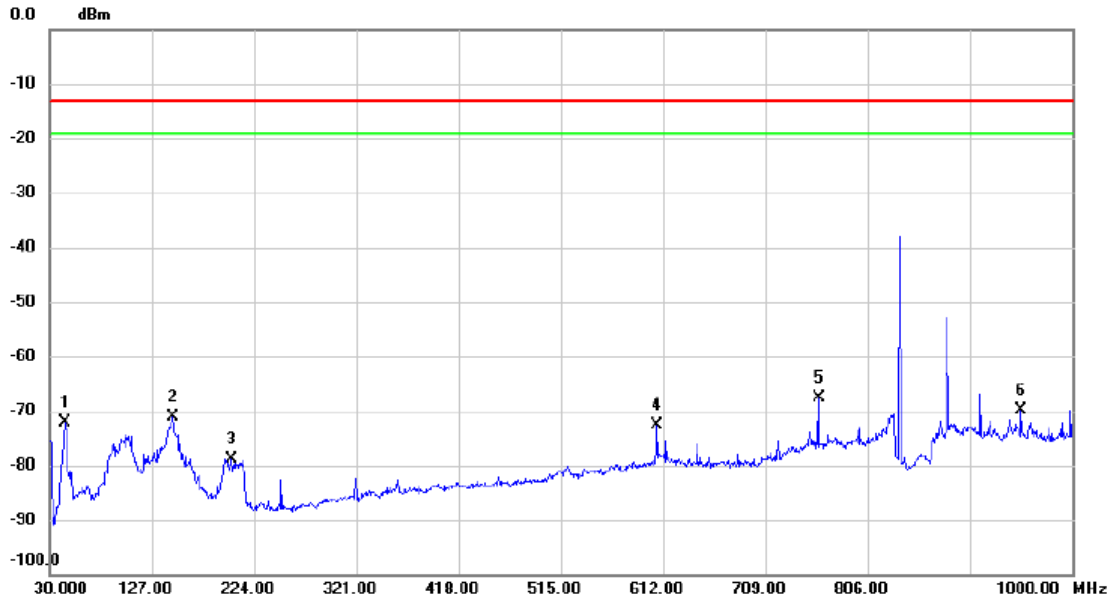

No.	Mk.	Freq. MHz	Reading Level dBm	Correct Factor dB	Measure- ment dBm	Limit dBm	Margin dB	Detector	Comment
1		45.0350	-60.82	-11.18	-72.00	-13.00	-59.00	RMS	
2		146.8850	-71.70	0.63	-71.07	-13.00	-58.07	RMS	
3		203.1450	-75.35	-3.58	-78.93	-13.00	-65.93	RMS	
4		606.1800	-76.75	4.15	-72.60	-13.00	-59.60	RMS	
5	*	759.4400	-73.44	5.73	-67.71	-13.00	-54.71	RMS	
6		951.5000	-77.10	7.26	-69.84	-13.00	-56.84	RMS	

Test Mode: GSM850

Horizontal

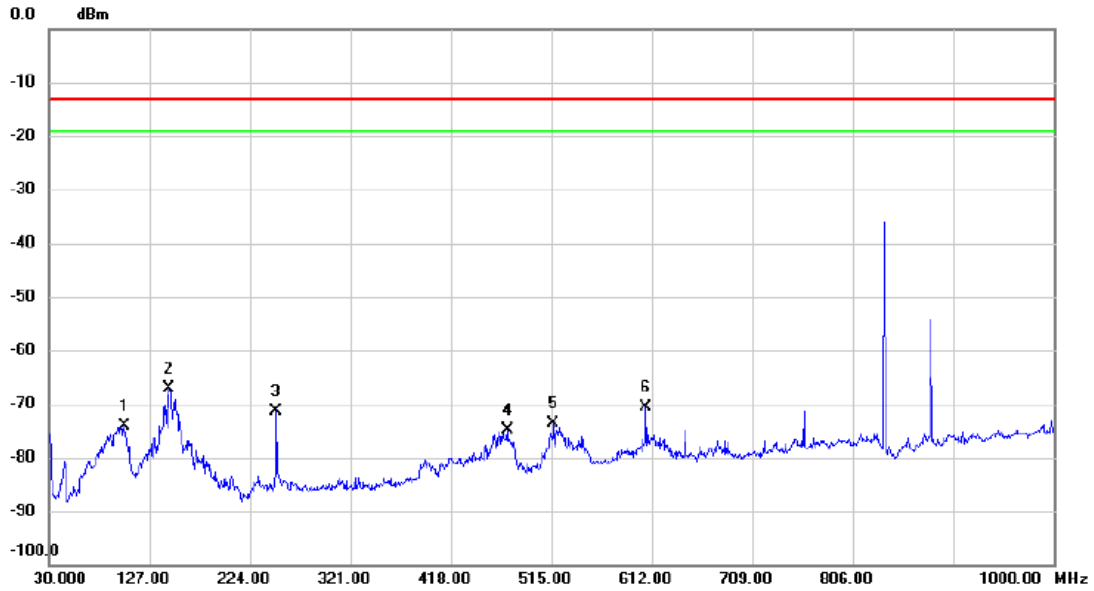

No.	Mk.	Freq. MHz	Reading Level dBm	Correct Factor dB	Measure- ment dBm	Limit dBm	Margin dB	Detector	Comment
1		103.2350	-67.57	-6.63	-74.20	-13.00	-61.20	RMS	
2	*	145.9150	-64.00	-3.14	-67.14	-13.00	-54.14	RMS	
3		249.7050	-70.09	-1.27	-71.36	-13.00	-58.36	RMS	
4		472.3200	-76.08	1.20	-74.88	-13.00	-61.88	RMS	
5		517.4250	-75.83	2.12	-73.71	-13.00	-60.71	RMS	
6		606.1800	-74.78	4.10	-70.68	-13.00	-57.68	RMS	

Test Mode: WCDMA Band V_TX Mode

Vertical

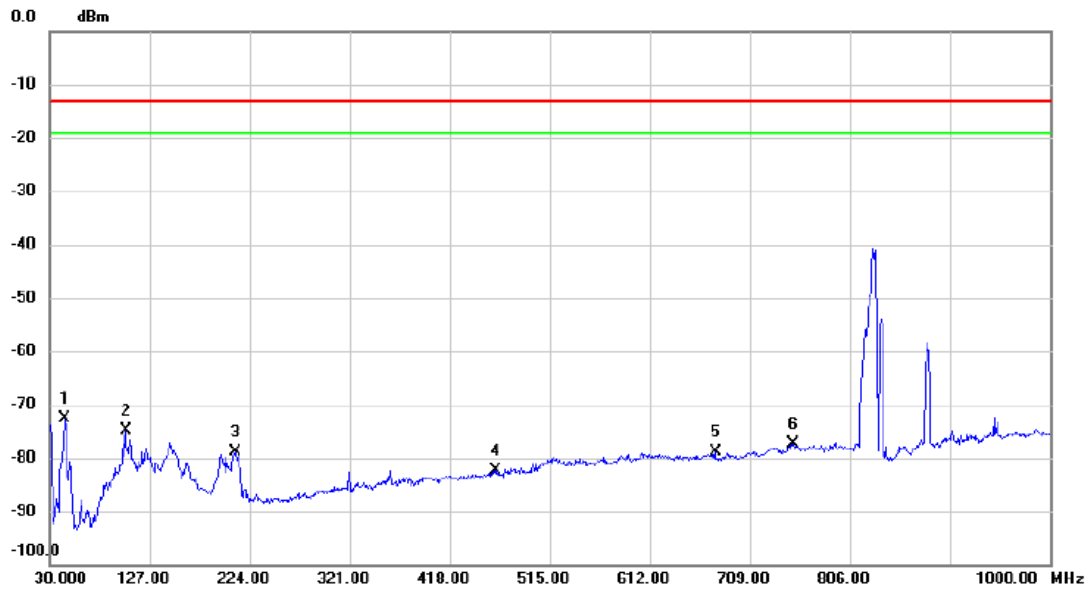

No.	Mk.	Freq. MHz	Reading Level dBm	Correct Factor dB	Measure- ment dBm	Limit dBm	Margin dB	Detector	Comment
1	*	44.5500	-61.20	-11.34	-72.54	-13.00	-59.54	RMS	
2		103.7200	-77.40	2.44	-74.96	-13.00	-61.96	RMS	
3		209.9350	-75.25	-3.53	-78.78	-13.00	-65.78	RMS	
4		463.1050	-83.44	1.04	-82.40	-13.00	-69.40	RMS	
5		675.5350	-83.01	4.10	-78.91	-13.00	-65.91	RMS	
6		750.7100	-83.07	5.76	-77.31	-13.00	-64.31	RMS	

Test Mode: WCDMA Band V_TX Mode

Horizontal

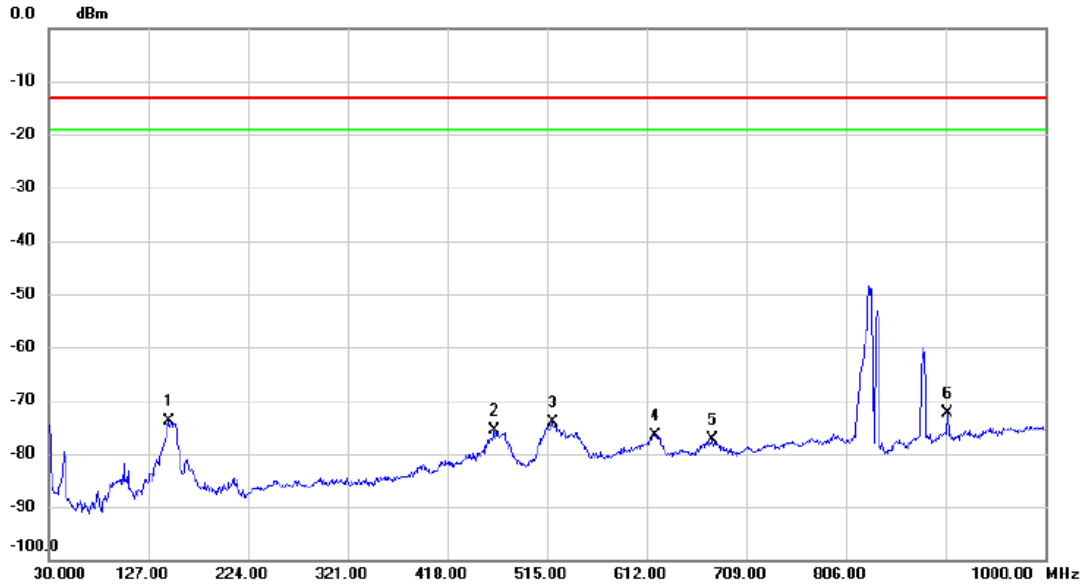

No.	Mk.	Freq. MHz	Reading Level dBm	Correct Factor dB	Measure- ment dBm	Limit dBm	Margin dB	Detector	Comment
1		146.4000	-70.73	-3.10	-73.83	-13.00	-60.83	RMS	
2		464.0750	-76.81	1.08	-75.73	-13.00	-62.73	RMS	
3		520.3350	-76.40	2.20	-74.20	-13.00	-61.20	RMS	
4		620.2450	-80.66	4.10	-76.56	-13.00	-63.56	RMS	
5		676.5050	-81.58	4.11	-77.47	-13.00	-64.47	RMS	
6	*	904.9400	-78.75	6.48	-72.27	-13.00	-59.27	RMS	

Test Mode: LTE Band 5_TX Mode_10M

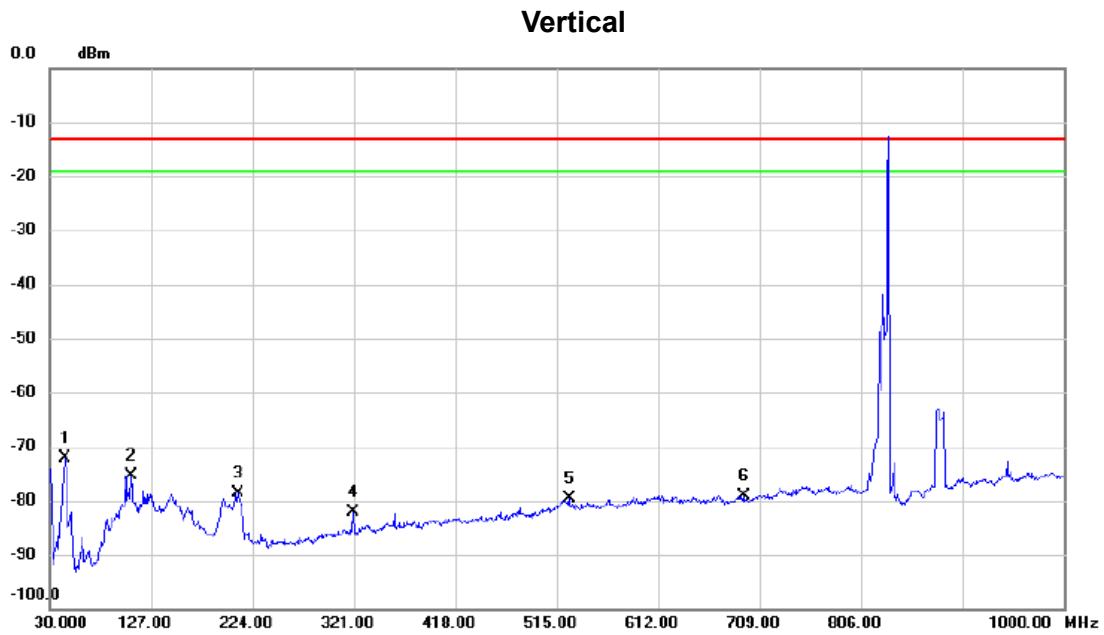

No.	Mk.	Freq. MHz	Reading Level dBm	Correct Factor dB	Measure- ment dBm	Limit dBm	Margin dB	Detector	Comment
1	*	44.5500	-60.80	-11.34	-72.14	-13.00	-59.14	RMS	
2		107.6000	-77.54	2.28	-75.26	-13.00	-62.26	RMS	
3		209.9350	-75.21	-3.53	-78.74	-13.00	-65.74	RMS	
4		320.0300	-81.07	-1.00	-82.07	-13.00	-69.07	RMS	
5		526.6400	-81.78	2.21	-79.57	-13.00	-66.57	RMS	
6		693.4800	-83.13	4.11	-79.02	-13.00	-66.02	RMS	

Test Mode: LTE Band 5_TX Mode_10M

Horizontal

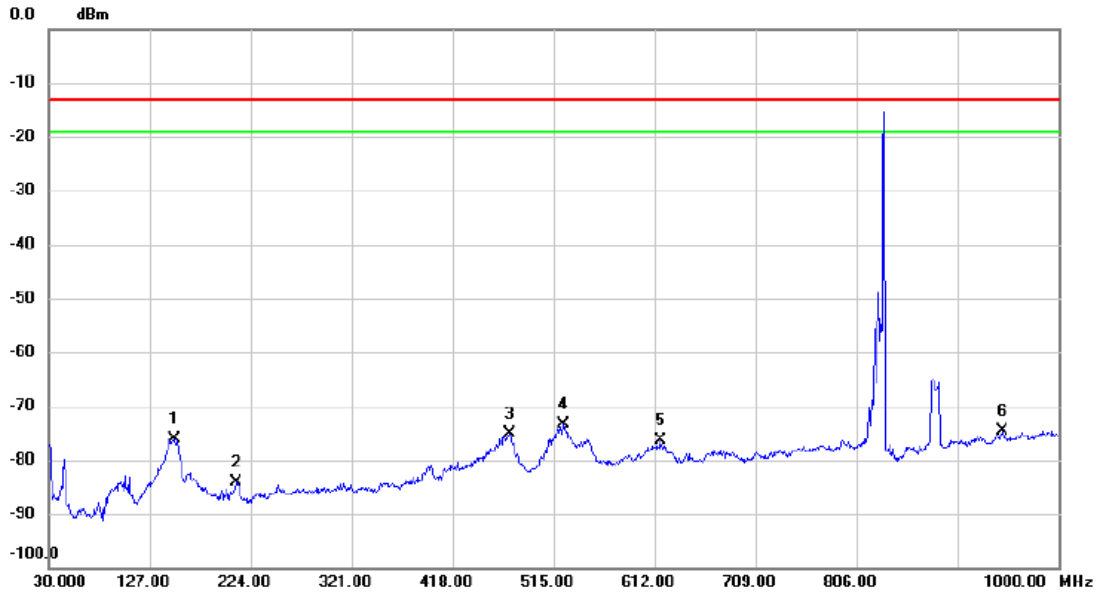

No.	Mk.	Freq. MHz	Reading Level dBm	Correct Factor dB	Measure- ment dBm	Limit dBm	Margin dB	Detector	Comment
1		150.2800	-73.35	-2.82	-76.17	-13.00	-63.17	RMS	
2		210.4200	-80.41	-3.61	-84.02	-13.00	-71.02	RMS	
3		472.8050	-76.27	1.21	-75.06	-13.00	-62.06	RMS	
4	*	525.1850	-75.73	2.35	-73.38	-13.00	-60.38	RMS	
5		617.3350	-80.48	4.10	-76.38	-13.00	-63.38	RMS	
6		946.1650	-81.70	7.05	-74.65	-13.00	-61.65	RMS	

APPENDIX F - RADIATED EMISSION (ABOVE 1GHZ)

Test Mode: GSM850_

Vertical

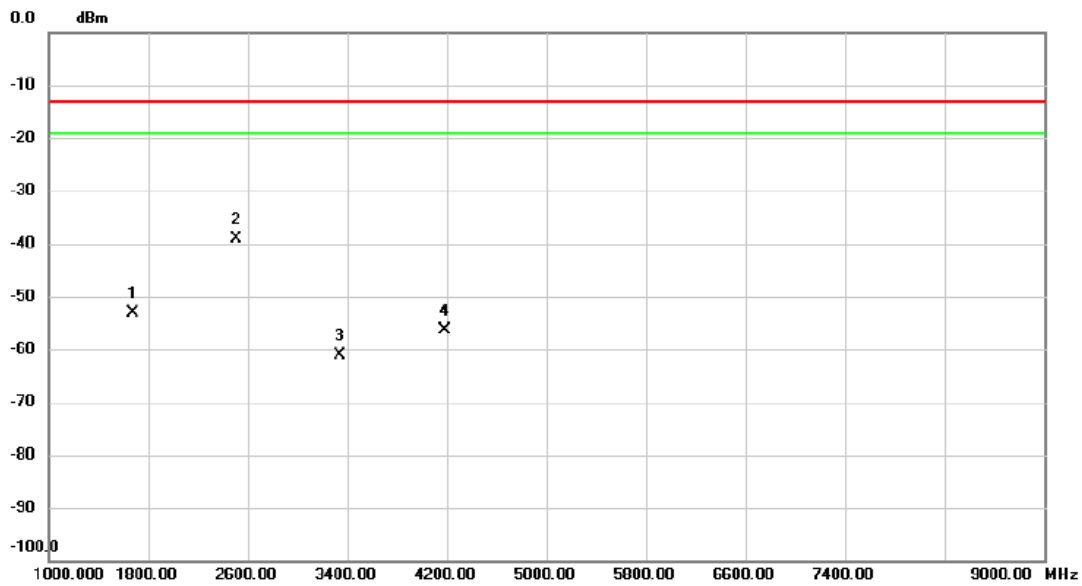

No.	Mk.	Freq. MHz	Reading Level dBm	Correct Factor dB	Measure- ment dBm	Limit dBm	Margin dB	Detector	Comment
1		1672.928	-46.48	-6.52	-53.00	-13.00	-40.00	RMS	
2	*	2509.370	-35.92	-3.17	-39.09	-13.00	-26.09	RMS	
3		3345.600	-59.90	-1.18	-61.08	-13.00	-48.08	RMS	
4		4182.000	-58.65	2.23	-56.42	-13.00	-43.42	RMS	

Test Mode: GSM850_

Horizontal

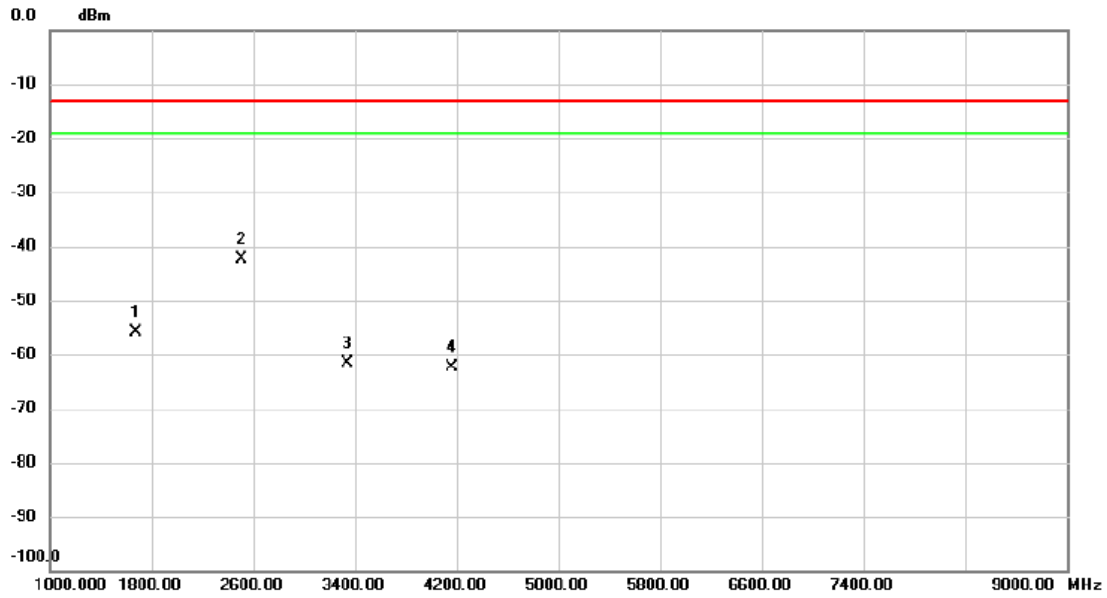

No.	Mk.	Freq.	Reading Level	Correct Factor	Measurement	Limit	Margin	Detector	Comment
		MHz	dBm	dB	dBm	dBm	dB		
1		1672.749	-48.67	-7.10	-55.77	-13.00	-42.77	RMS	
2	*	2509.273	-38.47	-3.81	-42.28	-13.00	-29.28	RMS	
3		3345.600	-60.10	-1.49	-61.59	-13.00	-48.59	RMS	
4		4162.800	-64.08	1.77	-62.31	-13.00	-49.31	RMS	

Test Mode: WCDMA Band V_

Vertical

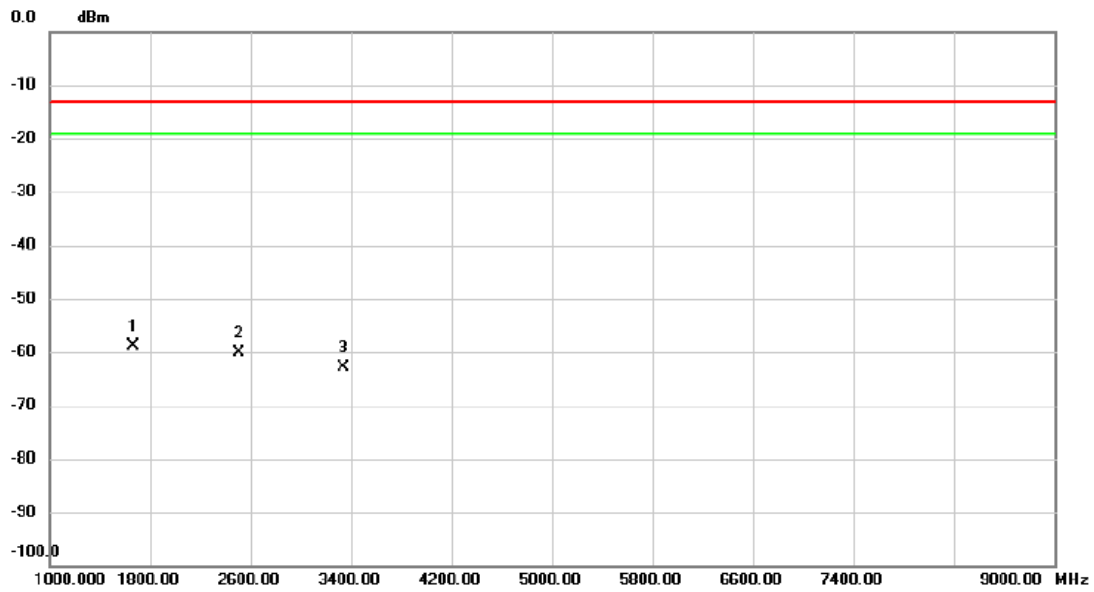

No.	Mk.	Freq. MHz	Reading Level dBm	Correct Factor dB	Measure- ment dBm	Limit dBm	Margin dB	Detector	Comment
1	*	1671.177	-52.36	-6.52	-58.88	-13.00	-45.88	RMS	
2		2506.081	-56.97	-3.18	-60.15	-13.00	-47.15	RMS	
3		3342.800	-61.77	-1.17	-62.94	-13.00	-49.94	RMS	

Test Mode: WCDMA Band V_

Horizontal

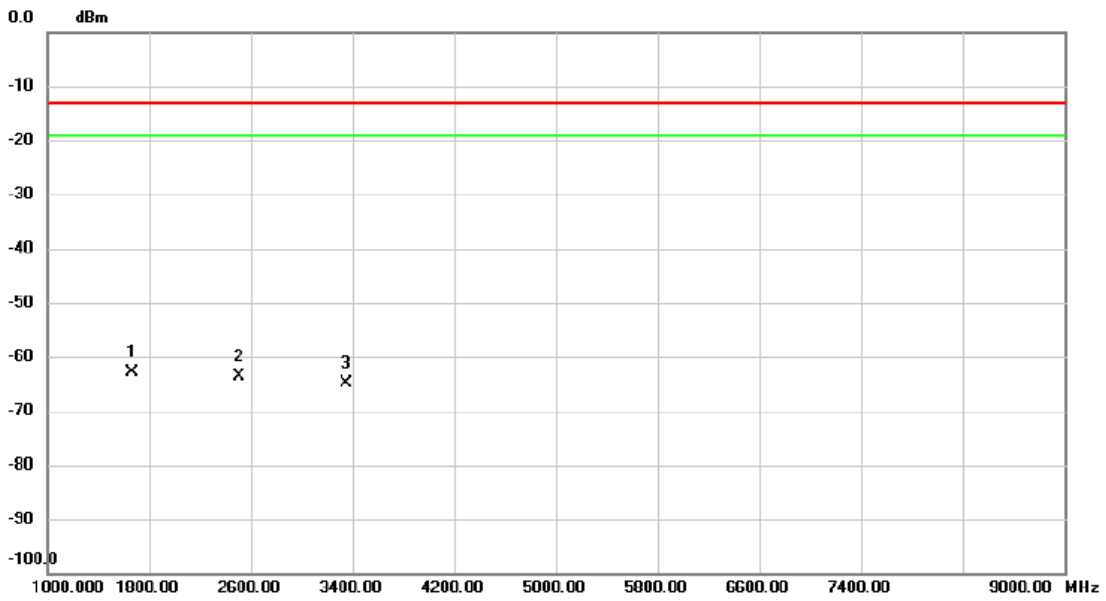

No.	Mk.	Freq. MHz	Reading Level dBm	Correct Factor dB	Measure- ment dBm	Limit dBm	Margin dB	Detector	Comment
1	*	1671.200	-55.80	-7.10	-62.90	-13.00	-49.90	RMS	
2		2506.800	-59.92	-3.81	-63.73	-13.00	-50.73	RMS	
3		3354.000	-63.40	-1.50	-64.90	-13.00	-51.90	RMS	

Test Mode: LTE Band 5_TX CH20525_10M

Vertical

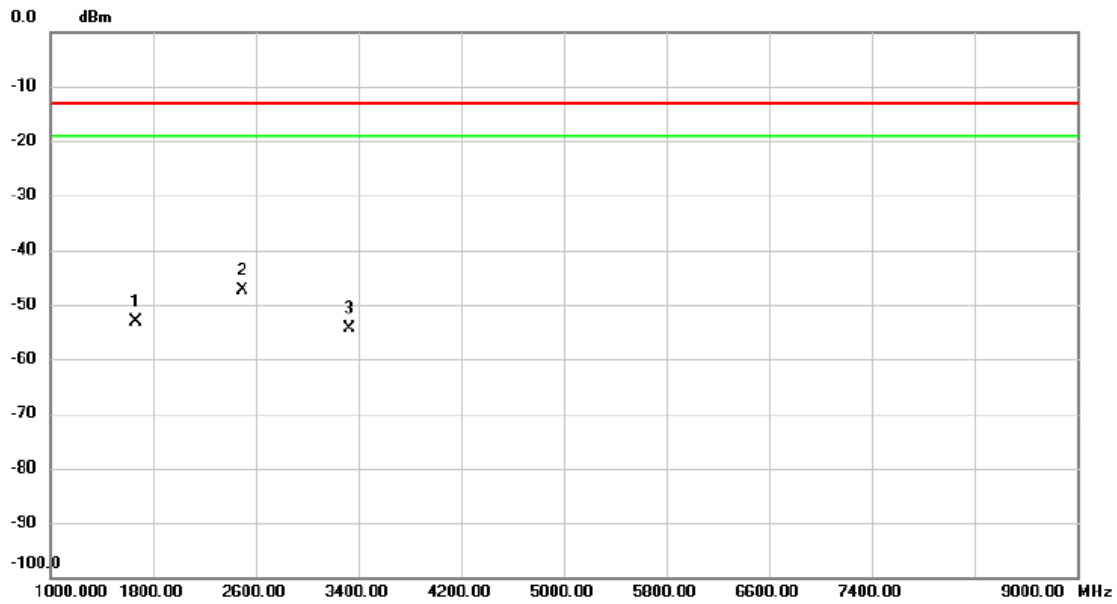

No.	Mk.	Freq. MHz	Reading Level dBm	Correct Factor dB	Measure- ment dBm	Limit dBm	Margin dB	Detector	Comment
1		1664.083	-46.48	-6.53	-53.01	-13.00	-40.01	RMS	
2	*	2496.284	-44.20	-3.19	-47.39	-13.00	-34.39	RMS	
3		3328.368	-53.18	-1.12	-54.30	-13.00	-41.30	RMS	

Test Mode: LTE Band 5_TX CH20525_10M

Horizontal

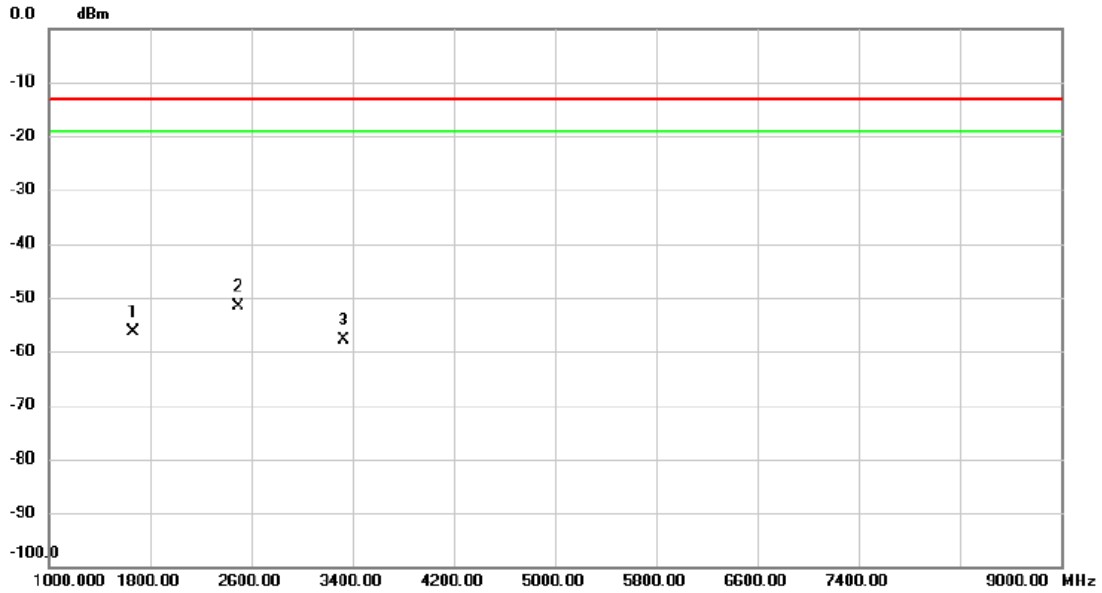

No.	Mk.	Freq. MHz	Reading Level dBm	Correct Factor dB	Measure- ment dBm	Limit dBm	Margin dB	Detector	Comment
1		1664.177	-49.35	-7.11	-56.46	-13.00	-43.46	RMS	
2	*	2496.357	-47.87	-3.80	-51.67	-13.00	-38.67	RMS	
3		3328.450	-56.48	-1.47	-57.95	-13.00	-44.95	RMS	

APPENDIX G - BAND EDGE