

MEASUREMENT REPORT

FCC PART 90

FCC ID: XMR2020EM160RGL2

Application: Quectel Wireless Solutions Company Limited

Application Type: Certification

Product: LTE-A Cat 16 M.2 Module

Model No.: EM160R-GL

Brand Name: 

FCC Rule Part(s): Part 90 Subpart R

Classification: PCB Licensed Transmitter (PCB)

Test Procedure(s): ANSI C63.26-2015, KDB 971168 D01v03r01

Test Date: June 12 ~ August 17, 2020

Reviewed By: 
(Sunny Sun)

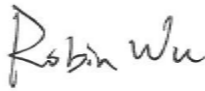
Approved By: 
(Robin Wu)



The test results relate only to the samples tested.

This equipment has been shown to be capable of compliance with the applicable technical standards as indicated in the measurement report and was tested in accordance with the measurement procedures specified in ANSI C63.26-2015. Test results reported herein relate only to the item(s) tested.

The test report shall not be reproduced except in full without the written approval of MRT Technology (Suzhou) Co., Ltd.

Revision History

Report No.	Version	Description	Issue Date	Note
2009RSU020-U3	Rev. 01	Initial Report	09-02-2020	Valid

CONTENTS

Description	Page
1. INTRODUCTION	6
1.1. Scope	6
1.2. MRT Test Location	6
2. PRODUCT INFORMATION	7
2.1. Equipment Description	7
2.2. Product Specification Subjective to this Report	7
2.3. Description of Available Antennas	8
2.4. EMI Suppression Device(s)/Modifications	8
2.5. Maximum Power, Frequency Tolerance, and Emission Designator	8
2.6. Configuration of Tested System	9
2.7. Test Environment Condition	9
3. TEST EQUIPMENT CALIBRATION DATE.....	10
4. MEASUREMENT UNCERTAINTY.....	12
5. TEST RESULT	13
5.1. Summary	13
5.2. Occupied Bandwidth.....	14
5.2.1. Test Limit	14
5.2.2. Test Procedure.....	14
5.2.3. Test Setting	14
5.2.4. Test Setup	14
5.2.5. Test Result	15
5.3. Frequency Stability Measurement.....	17
5.3.1. Test Limit	17
5.3.2. Test Procedures Used.....	17
5.3.3. Test Setting	17
5.3.4. Test Setup	18
5.3.5. Test Result	19
5.4. Equivalent Isotropically Radiated Power Measurement	20
5.4.1. Test Limit	20
5.4.2. Test Procedures Used.....	20
5.4.3. Test Setting	20
5.4.4. Test Setup	21
5.4.5. Test Result	22
5.5. Band Edge Measurement	25

5.5.1.	Test Limit	25
5.5.2.	Test Procedure Used.....	25
5.5.3.	Test Setting	25
5.5.4.	Test Setup	26
5.5.5.	Test Result	27
5.6.	Emission Mask.....	29
5.6.1.	Test Limit	29
5.6.2.	Test Procedure Used.....	29
5.6.3.	Test Setting	29
5.6.4.	Test Setup	30
5.6.5.	Test Result	31
5.7.	Conducted Spurious Emissions.....	34
5.7.1.	Test Limit	34
5.7.2.	Test Procedure Used.....	34
5.7.3.	Test Setting	34
5.7.4.	Test Setup	35
5.7.5.	Test Result	36
5.8.	Radiated Spurious Emissions Measurements	38
5.8.1.	Test Limit	38
5.8.2.	Test Procedure Used.....	38
5.8.3.	Test Setting	38
5.8.4.	Test Setup	39
5.8.5.	Test Result	40
6.	CONCLUSION	41
	Appendix A - Test Setup Photograph	42
	Appendix B - EUT Photograph.....	43

General Information

Applicant:	Quectel Wireless Solutions Company Limited
Applicant Address:	Building 5, Shanghai Business Park Phase III (Area B), No.1016 Tianlin Road, Minhang District, Shanghai, China 200233
Manufacturer:	Quectel Wireless Solutions Company Limited
Manufacturer Address:	Building 5, Shanghai Business Park Phase III (Area B), No.1016 Tianlin Road, Minhang District, Shanghai, China 200233
Test Site:	MRT Technology (Suzhou) Co., Ltd
Test Site Address:	D8 Building, No.2 Tian'edang Rd., Wuzhong Economic Development Zone, Suzhou, China

Test Facility / Accreditations

Measurements were performed at MRT Laboratory located in Tian'edang Rd., Suzhou, China.

- MRT facility is an FCC accredited testing laboratory (MRT Designation No. CN1166) on the FCC website.
- MRT facility is an ISED recognized testing laboratory (MRT Reg. No. CN0001) on the ISED website.
- MRT facility is a VCCI registered (R-20025, G-20034, C-20020, T-20020) test laboratory with the site description on file at VCCI Council.
- MRT Lab is accredited to ISO 17025 by the A2LA under the A2LA Program (Cert. No. 3628.01) and CNAS under the CNAS Program (Cert. No. L10551) in EMC, Safety, Radio, Telecommunications and SAR testing.

1. INTRODUCTION

1.1. Scope

Measurement and determination of electromagnetic emissions (EMC) of radio frequency devices including intentional and/or unintentional radiators for compliance with the technical rules and regulations of the Federal Communications Commission and the Innovation, Science and Economic Development Canada and Certification and Engineering Bureau.

1.2. MRT Test Location

The map below shows the location of the MRT LABORATORY, its proximity to the Taihu Lake. These measurement tests were conducted at the MRT Technology (Suzhou) Co., Ltd. Facility located at D8 Building, No.2 Tian'edang Rd., Wuzhong Economic Development Zone, Suzhou, China. The detailed description of the measurement facility was found to be in compliance with the requirements of § 2.948 according to ANSI C63.4-2009 on September 30, 2013.



2. PRODUCT INFORMATION

2.1. Equipment Description

Product Name:	LTE-A Cat 16 M.2 Module
Model No.:	EM160R-GL
Brand Name:	QUECTEL
IMEI:	864292050003514
Single Band:	Band 2, 4, 5, 7, 12, 13, 14, 25, 26, 30, 38, 41, 48, 66
Intra-Band:	CA_41C
Category:	Category 16
Operating Temperature:	-25 ~ 75 °C
Power Type:	3.1 ~ 4.4Vdc, typical 3.7Vdc

2.2. Product Specification Subjective to this Report

FDD Tx Frequency Range:	Band 14: 788 ~ 798 MHz
FDD Rx Frequency Range:	Band 14: 758 ~ 768 MHz
Type of Modulation:	QPSK, 16QAM, 64QAM, 256QAM (DL)

Note 1: For other features of this EUT, test report will be issued separately.

Note 2: The declared of product specification for EUT presented in the report are provided by the manufacturer, and the manufacturer takes all the responsibilities for the accuracy of product specification.

2.3. Description of Available Antennas

Technology	Frequency Range (MHz)	Antenna Type	Max Peak Gain (dBi)
LTE Band 2	1850 ~ 1910	Dipole	1.15
LTE Band 4	1710 ~ 1755		-0.50
LTE Band 5	824 ~ 849		1.85
LTE Band 7	2500 ~ 2570		1.32
LTE Band 12	699 ~ 716		-2.43
LTE Band 13	777 ~ 787		-0.10
LTE Band 14	788 ~ 798		2.40
LTE Band 25	1850 ~ 1915		1.15
LTE Band 26	814 ~ 849		1.85
LTE Band 30	2305 ~ 2315		-3.64
LTE Band 38	2570 ~ 2620		0.93
LTE Band 41	2496 ~ 2690		0.93
LTE Band 48	3550 ~ 3700		-3.37
LTE Band 66	1710 ~ 1780		-0.50

Note: All antenna information (Antenna type and Peak Gain) is provided by the manufacturer.

2.4. EMI Suppression Device(s)/Modifications

No EMI suppression device(s) were added and/or no modifications were made during testing.

2.5. Maximum Power, Frequency Tolerance, and Emission Designator

LTE Band 14		QPSK			16QAM			64QAM		
BW (MHz)	Feq. (MHz)	Designator	Tolerance (ppm)	Max Power (W)	Designator	Tolerance (ppm)	Max Power (W)	Designator	Tolerance (ppm)	Max Power (W)
5	790.5 ~ 795.5	4M49G7D	-	0.2307	4M46W7D	-	0.1968	4M46W7D	-	0.1514
10	793	8M94G7D	0.0073	0.2280	8M93W7D	-	0.2009	9M92W7D	-	0.1517

2.6. Configuration of Tested System

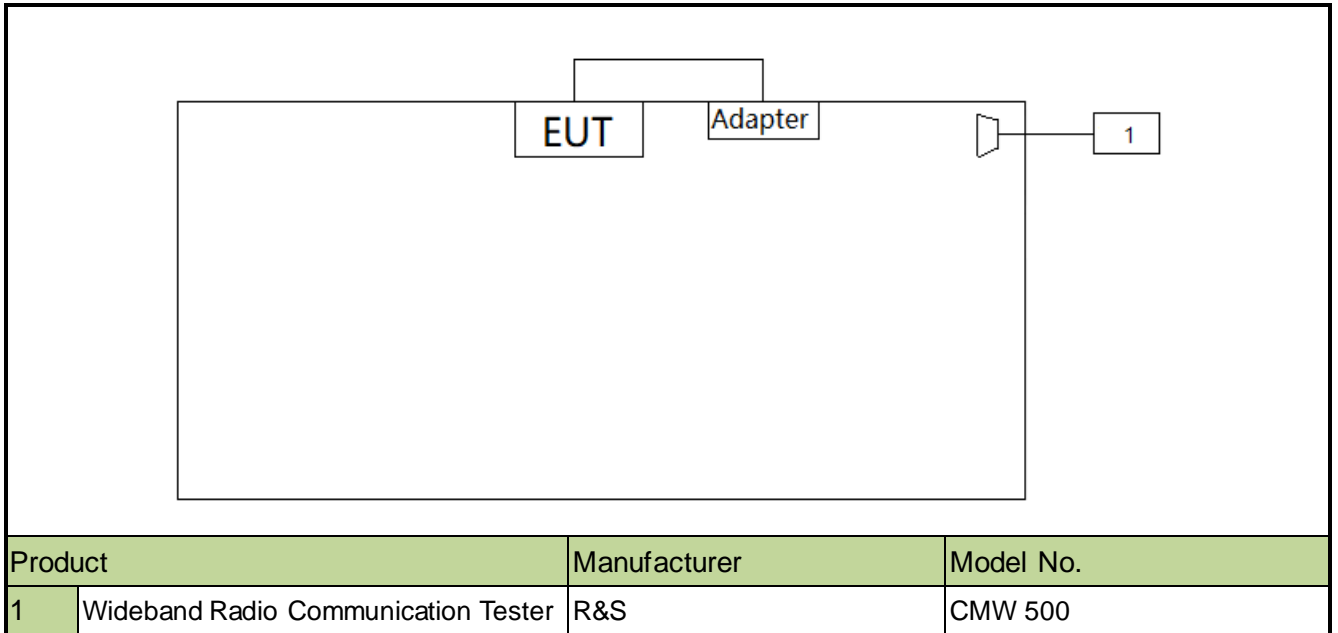

2.7. Test Environment Condition

Ambient Temperature	15°C~35°C
Relative Humidity	20%RH ~75%RH

3. TEST EQUIPMENT CALIBRATION DATE

Radiated Emission - AC1

Instrument	Manufacturer	Type No.	Asset No.	Cali. Interval	Cali. Due Date
EMI Test Receiver	R&S	ESR7	MRTSUE06001	1 year	2021/08/01
Wideband Radio Communication Tester	R&S	CMW 500	MRTSUE06243	1 year	2020/11/07
PXA Signal Analyzer	Keysight	9030B	MRTSUE06395	1 year	2020/09/03
Loop Antenna	Schwarzbeck	FMZB 1519	MRTSUE06025	1 year	2020/11/10
Bilog Period Antenna	Schwarzbeck	VULB 9168	MRTSUE06172	1 year	2021/03/31
Broad Band Horn Antenna	Schwarzbeck	BBHA 9120D	MRTSUE06023	1 year	2020/10/13
Broad Band Horn Antenna	Schwarzbeck	BBHA 9170	MRTSUE06597	1 year	2021/02/23
Microwave System Amplifier	Agilent	83017A	MRTSUE06076	1 year	2020/11/15
Preamplifier	Schwarzbeck	BBV 9721	MRTSUE06121	1 year	2021/06/11
EMC Cable	HUBER+SUHN ER	SF126-2M	MRTSUE06732	1 year	2021/04/11
Thermohyrometer	Testo	608-H1	MRTSUE06403	1 year	2021/08/08
Anechoic Chamber	TDK	Chamber-AC1	MRTSUE06212	1 year	2021/04/30

Radiated Emission - AC2

Instrument	Manufacturer	Type No.	Asset No.	Cali. Interval	Cali. Due Date
Spectrum Analyzer	Keysight	N9038A	MRTSUE06125	1 year	2021/08/01
Wideband Radio Communication Tester	R&S	CMW 500	MRTSUE06243	1 year	2020/11/07
Loop Antenna	Schwarzbeck	FMZB 1519	MRTSUE06025	1 year	2020/11/10
Bilog Period Antenna	Schwarzbeck	VULB 9162	MRTSUE06022	1 year	2020/10/13
Horn Antenna	Schwarzbeck	BBHA9120D	MRTSUE06171	1 year	2020/10/27
Broad Band Horn Antenna	Schwarzbeck	BBHA 9170	MRTSUE06597	1 year	2021/02/23
Broadband Coaxial Preamplifier	Schwarzbeck	BBV 9718	MRTSUE06176	1 year	2020/11/15
Preamplifier	Schwarzbeck	BBV 9721	MRTSUE06121	1 year	2021/06/11
EMC Cable	HUBER+SUHN ER	SF126-2M	MRTSUE06733	1 year	2021/04/10
Temperature/Humidity Meter	Minggao	ETH529	MRTSUE06170	1 year	2020/12/15
Anechoic Chamber	RIKEN	Chamber-AC2	MRTSUE06213	1 year	2021/04/30

Conducted Test Equipment

Instrument	Manufacturer	Type No.	Asset No.	Cali. Interval	Cali. Due Date
EXA Signal Analyzer	Agilent	N9020A	MRTSUE06106	1 year	2021/04/15
EXA Signal Analyzer	Keysight	N9010B	MRTSUE06452	1 year	2021/07/11
Signal Analyzer	R&S	FSV40	MRTSUE06218	1 year	2021/04/15
Wideband Radio Communication Tester	R&S	CMW 500	MRTSUE06243	1 year	2020/11/07
Power Meter	Agilent	U2021XA	MRTSUE06030	1 year	2020/11/18
DC Power Supply	GWINSTEK	DPS-3303C	MRTSUE06064	N/A	N/A
True RMS Clamp Meter	Fluke	319	MRTSUE06080	1 year	2021/05/06
Directional Coupler	Agilent	87301D	MRTSUE06082	1 year	2021/03/25
Attenuator	MVE	6dB	MRTSUE06534	1 year	2020/12/12
Attenuator	MVE	10dB	MRTSUE06543	1 year	2020/12/12
Temperature & Humidity Chamber	BAOYT	BYH-150CL	MRTSUE06051	1 year	2020/11/07
Thermohygrometer	testo	608-H1	MRTSUE06401	1 year	2021/08/08

Software	Version	Function
EMI Software	V3	EMI Test Software

4. MEASUREMENT UNCERTAINTY

Where relevant, the following test uncertainty levels have been estimated for tests performed on the EUT as specified in CISPR 16-4-2. This uncertainty represents an expanded uncertainty expressed at approximately the 95% confidence level using a coverage factor of $k = 2$.

Radiated Emission Measurement
Measurement Uncertainty for a Level of Confidence of 95% ($U=2Uc(y)$): Horizontal: 9kHz~300MHz: 5.04dB 300MHz~1GHz: 4.95dB 1GHz~40GHz: 6.40dB Vertical: 9kHz~300MHz: 5.24dB 300MHz~1GHz: 6.03dB 1GHz~40GHz: 6.40dB
Spurious Emissions, Conducted
Measuring Uncertainty for a Level of Confidence of 95% ($U=2Uc(y)$): 0.78dB
Output Power
Measuring Uncertainty for a Level of Confidence of 95% ($U=2Uc(y)$): 1.13dB
Power Spectrum Density
Measuring Uncertainty for a Level of Confidence of 95% ($U=2Uc(y)$): 1.15dB
Occupied Bandwidth
Measuring Uncertainty for a Level of Confidence of 95% ($U=2Uc(y)$): 0.28%

5. TEST RESULT

5.1. Summary

FCC Part Section(s)	Test Description	Test Limit	Test Condition	Test Result	Reference
2.1049	Occupied Bandwidth	N/A	Conducted	Pass	Section 5.2
2.1055, 90.539(e)	Frequency Stability	< 1.25 ppm		Pass	Section 5.3
90.542(a)(7)	Equivalent Radiated Power	< 30 Watts Max ERP		Pass	Section 5.4
2.1051, 90.543(e)(2)(3)	Band Edge	Refer to section 5.5		Pass	Section 5.5, 5.6, 5.7
2.1051, 90.210(n)	Emission Mask	Mask B			
2.1051, 90.543(e)(3)	Spurious Emission	> 43 + 10log ₁₀ (P _[Watts])	Radiated	Pass	Section 5.8
2.1053, 90.543(e)(3) 90.543(f)	Spurious Emissions	> 43 + 10log ₁₀ (P _[Watts])			

Notes:

- 1) The analyzer plots shown in this section were all taken with a correction table loaded into the analyzer. The correction table was used to account for the losses of the cables and attenuators used as part of the system to connect the EUT to the analyzer at all frequencies of interest.
- 2) All supported modulation types were evaluated. The worst-case emission of modulation was selected. Therefore, the Frequency Stability, Channel Band Edge, Radiated & Conducted Spurious Emission were presented in the test report.
- 3) This report is supplemented to MRT Original "2006RSU008-U3" Report & FCC ID: XMR2020EM160RGL updating FCC ID.

5.2. Occupied Bandwidth

5.2.1. Test Limit

The occupied bandwidth, that is the frequency bandwidth such that, below its lower and above its upper frequency limits, the mean powers radiated are each equal to 0.5 percent of the total mean power radiated by a given emission shall be measured.

5.2.2. Test Procedure

ANSI C63.26-2015 - Section 5.4

5.2.3. Test Setting

1. Set center frequency to the nominal EUT channel center frequency
2. RBW = The nominal RBW shall be in the range of 1% to 5% of the anticipated OBW
3. VBW $\geq 3 \times$ RBW
4. Detector = Peak
5. Trace mode = max hold
6. Sweep = auto couple
7. Allow the trace to stabilize
8. Use the 99% power bandwidth function of the instrument and report the measured bandwidth.

5.2.4. Test Setup

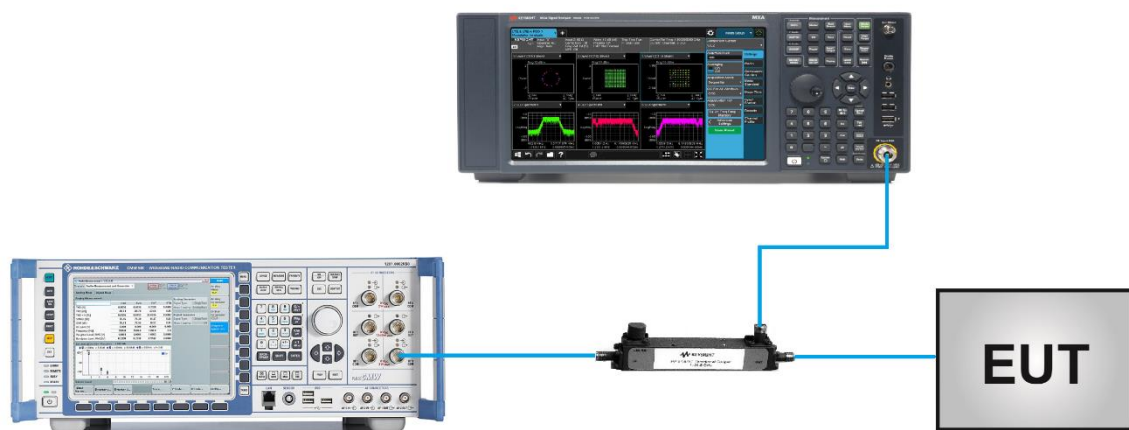

5.2.5. Test Result

Product	LTE-A Cat 16 M.2 Module	Test Engineer	Candy Luo
Test Date	2020/06/19	Test Site	SR6
Test Band	Band 14		

Modulation	Frequency (MHz)	Bandwidth (MHz)	99% Bandwidth (MHz)
QPSK	793	5	4.49
		10	8.94
16QAM	793	5	4.46
		10	8.93
64QAM	793	5	4.46
		10	8.92

99% Bandwidth - QPSK

5MHz Channel Bandwidth

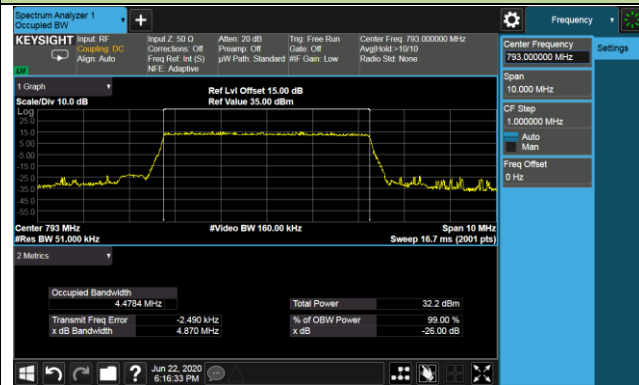

10MHz Channel Bandwidth

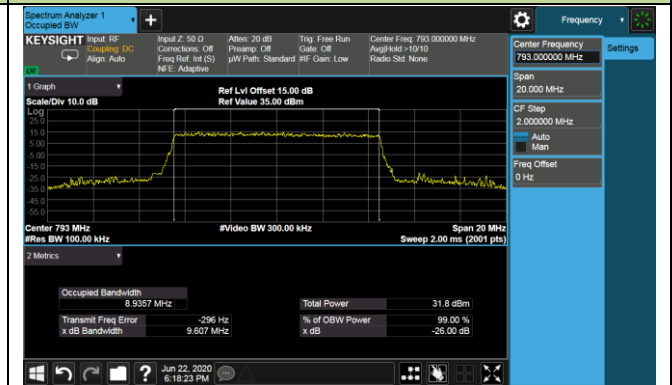

99% Bandwidth - 16QAM

5MHz Channel Bandwidth

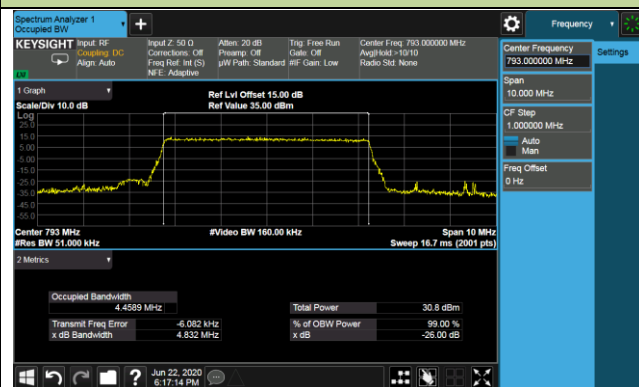

10MHz Channel Bandwidth

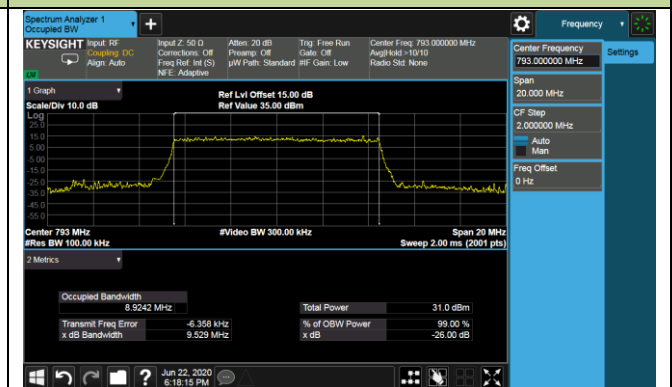

99% Bandwidth - 64QAM

5MHz Channel Bandwidth

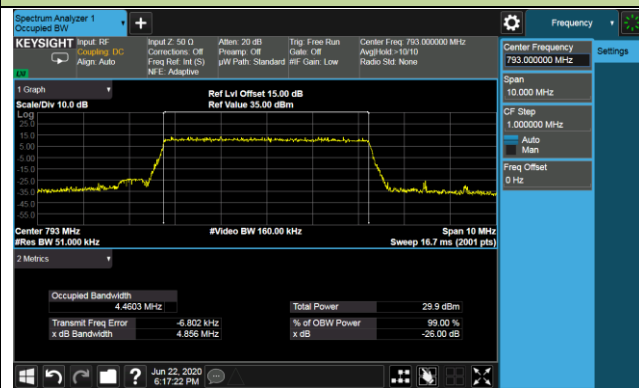

10MHz Channel Bandwidth

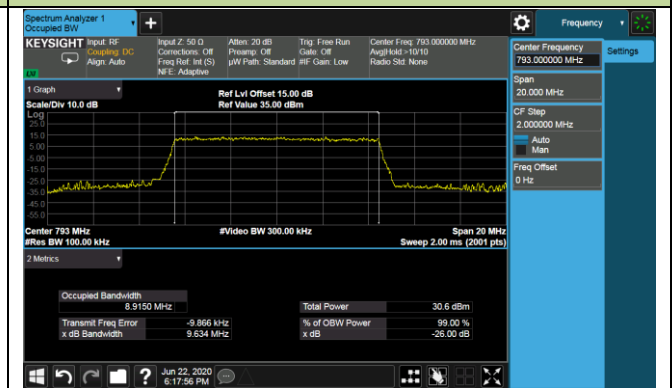

5.3. Frequency Stability Measurement

5.3.1. Test Limit

The frequency stability of mobile, portable and control transmitters operating in the wideband segment must be 1.25 parts per million or better when AFC is locked to a base station, and 5 parts per million or better when AFC is not locked

5.3.2. Test Procedures Used

ANSI C63.26-2015 - Section 5.6

5.3.3. Test Setting

Frequency Stability Under Temperature Variations:

The equipment under test was connected to an external AC or DC power supply and input rated voltage. RF output was connected to a frequency counter or spectrum analyzer via feed through attenuators. The EUT was placed inside the temperature chamber. Set the spectrum analyzer RBW low enough to obtain the desired frequency resolution and measure EUT 20°C operating frequency as reference frequency. Turn EUT off and set the chamber temperature to highest. After the temperature stabilized for approximately 30 minutes recorded the frequency. Repeat step measure with 10°C decreased per stage until the lowest temperature reached.

Frequency Stability Under Voltage Variations:

Set chamber temperature to 20°C. Use a variable AC power supply / DC power source to power the EUT and set the voltage to rated voltage. Set the spectrum analyzer RBW low enough to obtain the desired frequency resolution and recorded the frequency.

Reduce the input voltage to specify extreme voltage variation ($\pm 15\%$) and endpoint, record the maximum frequency change.

5.3.4. Test Setup

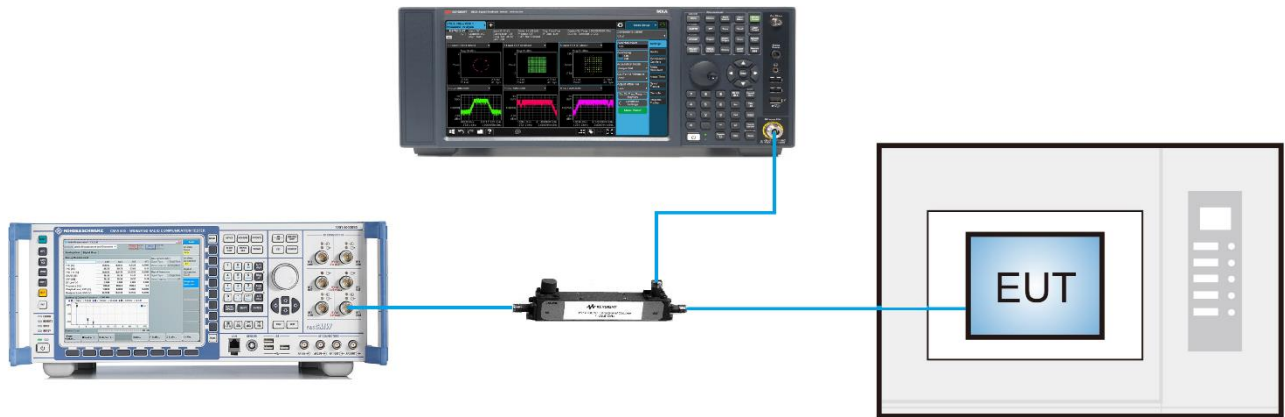

5.3.5. Test Result

Product	LTE-A Cat 16 M.2 Module	Temperature	-30 ~ 50°C
Test Engineer	Candy Luo	Relative Humidity	53%
Test Site	TR3	Test Date	2020/06/19
Test Band	LTE Band 14		

Voltage (%)	Power (VDC)	Temp (°C)	Frequency Tolerance (ppm)
100%	3.7	- 30	0.0073
		- 20	0.0060
		- 10	0.0041
		0	0.0057
		+ 10	0.0043
		+ 20 (Ref)	0.0045
		+ 30	0.0054
		+ 40	0.0040
		+ 50	0.0043
115%	4.2	+ 20	0.0039
85%	3.1	+ 20	0.0045

5.4. Equivalent Isotropically Radiated Power Measurement

5.4.1. Test Limit

Control stations and mobile stations transmitting in the 758-768 MHz band and the 788-798 MHz band are limited to 30 watts ERP.

5.4.2. Test Procedures Used

ANSI C63.26-2015 - Section 5.2

5.4.3. Test Setting

Average power measurements were performed only when the EUT was transmitting at its maximum power control level using a broadband power meter with a pulse sensor. The power meter implemented triggering and gating capabilities which were set up such that power measurements were recorded only during the ON time of the transmitter.

The relevant equation for determining the maximum ERP or EIRP from the measured RF output power is given in Equation (1) as follows:

$$\text{ERP or EIRP} = P_{\text{Meas}} + G_{\text{T}}$$

where

ERP or EIRP effective radiated power or equivalent isotropically radiated power, respectively (expressed in the same units as P_{Meas} , e.g., dBm or dBW)

P_{Meas} measured transmitter output power or PSD, in dBm or dBW

G_{T} gain of the transmitting antenna, in dBd (ERP) or dBi (EIRP)

$$\text{ERP} = \text{EIRP} - 2.15$$

5.4.4. Test Setup

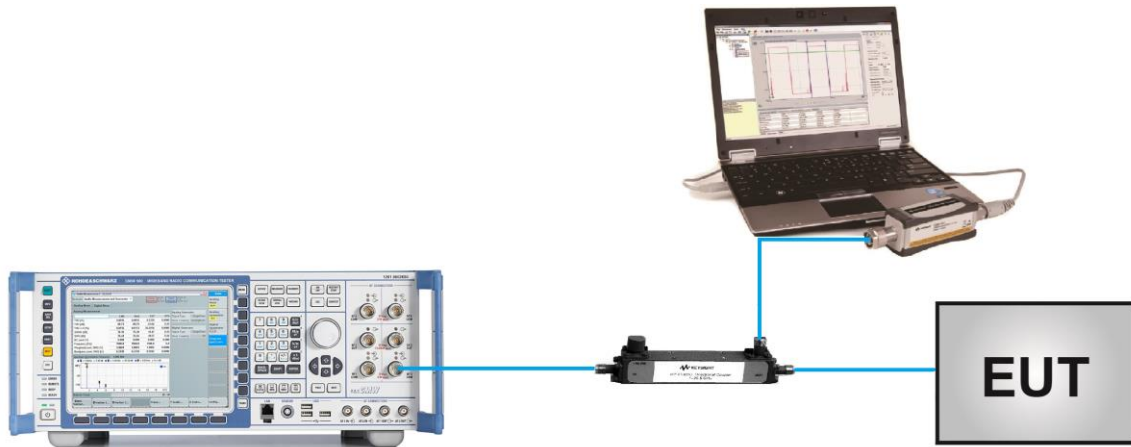

5.4.5. Test Result

Product	LTE-A Cat 16 M.2 Module	Test Engineer	Candy Luo
Test Date	2020/08/17	Test Site	SR6
Test Band	LTE Band 14		

Channel No.	Frequency (MHz)	Channel Bandwidth (MHz)	RB Size	RB Offset	Output Power (dBm)	EIRP (dBm)	Limit (dBm)
QPSK							
23305	790.5	5	1	0	23.45	23.70	< 44.77
23330	793.0				23.54	23.79	< 44.77
23355	795.5				23.58	23.83	< 44.77
23305	790.5	5	1	12	23.59	23.84	< 44.77
23330	793.0				23.60	23.85	< 44.77
23355	795.5				23.63	23.88	< 44.77
23305	790.5	5	1	24	23.42	23.67	< 44.77
23330	793.0				23.46	23.71	< 44.77
23355	795.5				23.50	23.75	< 44.77
23305	790.5	5	25	0	23.62	23.87	< 44.77
23330	793.0				23.61	23.86	< 44.77
23355	795.5				23.45	23.70	< 44.77
23330	793.0	10	1	0	23.58	23.83	< 44.77
23330	793.0			24	23.43	23.68	< 44.77
23330	793.0			49	23.51	23.76	< 44.77
23330	793.0	10	50	0	23.23	23.48	< 44.77

Note: The ERP (dBm) = Output Power (dBm) + Antenna Gain (dBi) - 2.15

Channel No.	Frequency (MHz)	Channel Bandwidth (MHz)	RB Size	RB Offset	Output Power (dBm)	EIRP (dBm)	Limit (dBm)
16QAM							
23305	790.5	5	1	0	22.61	22.86	< 44.77
23330	793.0				22.77	23.02	< 44.77
23355	795.5				22.63	22.88	< 44.77
23305	790.5	5	1	12	22.41	22.66	< 44.77
23330	793.0				22.94	23.19	< 44.77
23355	795.5				22.66	22.91	< 44.77
23305	790.5	5	1	24	22.63	22.88	< 44.77
23330	793.0				22.84	23.09	< 44.77
23355	795.5				22.61	22.86	< 44.77
23305	790.5	5	25	0	22.62	22.87	< 44.77
23330	793.0				21.62	21.87	< 44.77
23355	795.5				21.63	21.88	< 44.77
23330	793.0	10	1	0	23.03	23.28	< 44.77
23330	793.0			24	23.02	23.27	< 44.77
23330	793.0			49	23.03	23.28	< 44.77
23330	793.0	10	50	0	22.41	22.66	< 44.77
Note: The ERP (dBm) = Output Power (dBm) + Antenna Gain (dBi) - 2.15							

Channel No.	Frequency (MHz)	Channel Bandwidth (MHz)	RB Size	RB Offset	Output Power (dBm)	EIRP (dBm)	Limit (dBm)
64QAM							
23305	790.5	5	1	0	21.73	21.98	< 44.77
23330	793.0				21.58	21.83	< 44.77
23355	795.5				21.49	21.74	< 44.77
23305	790.5	5	1	12	21.80	22.05	< 44.77
23330	793.0				21.62	21.87	< 44.77
23355	795.5				21.11	21.36	< 44.77
23305	790.5	5	1	24	21.79	22.04	< 44.77
23330	793.0				21.13	21.38	< 44.77
23355	795.5				21.17	21.42	< 44.77
23305	790.5	5	25	0	20.74	20.99	< 44.77
23330	793.0				20.70	20.95	< 44.77
23355	795.5				20.67	20.92	< 44.77
23330	793.0	10	1	0	21.81	22.06	< 44.77
23330	793.0			24	21.52	21.77	< 44.77
23330	793.0			49	21.80	22.05	< 44.77
23330	793.0	10	50	0	20.46	20.71	< 44.77
Note: The ERP (dBm) = Output Power (dBm) + Antenna Gain (dBi) - 2.15							

5.5. Band Edge Measurement

5.5.1. Test Limit

For operations in the 758-768 MHz and the 788-798 MHz bands, the power of any emission outside the licensee's frequency band(s) of operation shall be attenuated below the transmitter power (P) within the licensed band(s) of operation, measured in watts, in accordance with the following:

- (1) On all frequencies between 769-775 MHz and 799-805 MHz, by a factor not less than $65 + 10 \log (P)$ dB in a 6.25 kHz band segment, for mobile and portable stations;
- (2) On any frequency between 775-788 MHz, above 805 MHz, and below 758 MHz, by at least $43 + 10 \log (P)$ dB.

5.5.2. Test Procedure Used

ANSI C63.26-2015 - Section 5.7

5.5.3. Test Setting

1. Set the analyzer frequency to low or high channel
2. $RBW \geq$ The nominal RBW shall be in the range of 1% of the anticipated OBW (in the 1MHz band immediately outside and adjacent to the band edge). For improvement of the accuracy in the measurement of the average power of a noise-like emission, a RBW narrower than the specified reference bandwidth can be used (generally limited to no less than 1% of the OBW), provided that a subsequent integration is performed over the full required measurement bandwidth. This integration should be performed using the spectrum analyzer's band power functions.
3. $VBW \geq 3 * RBW$
4. Sweep time = auto
5. Detector = power averaging (rms)
6. Set sweep trigger to "free run."
7. User gate triggered such that the analyzer only sweeps when the device is transmitting at full power
8. Trace average at least 100 traces in power averaging (rms) mode if sweep is set to auto-couple. To accurately determine the average power over the on and off time of the transmitter, it can be necessary to increase the number of traces to be averaged above 100, or if using a manually configured sweep time, increase the sweep time.

5.5.4. Test Setup

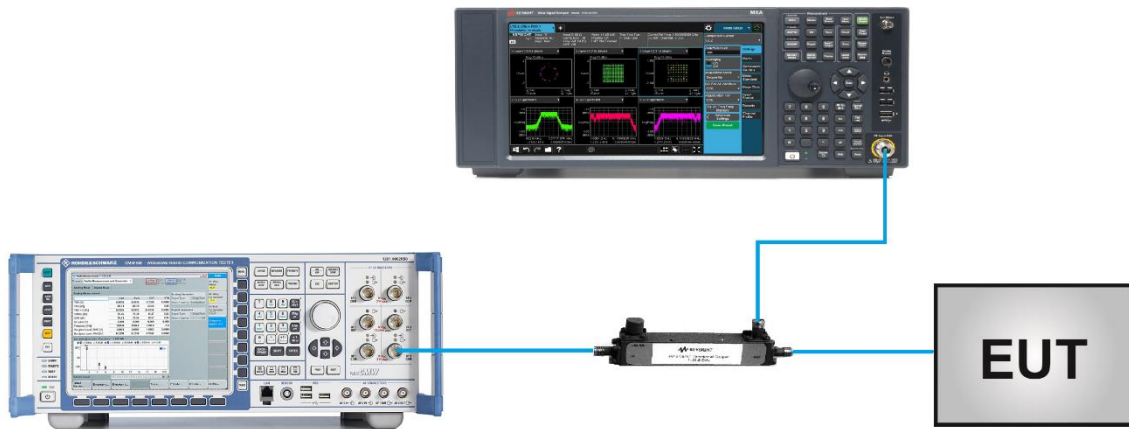

5.5.5. Test Result

Product	LTE-A Cat 16 M.2 Module	Test Engineer	Gordon Qi
Test Date	2020/08/03	Test Site	SR6
Test Band	Band 14	Test Result	Pass

5MHz Channel Bandwidth 1RB



10MHz Channel Bandwidth 1RB



5MHz Channel Bandwidth Full RB

Lower ACP

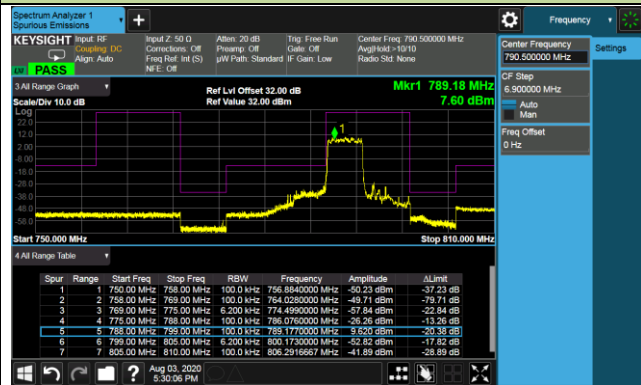

Upper ACP

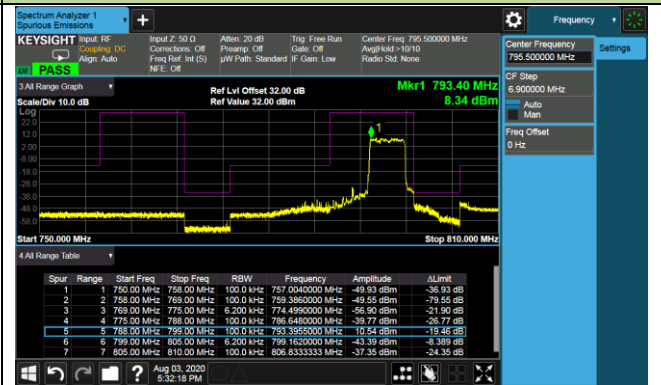

10MHz Channel Bandwidth Full RB

Middle ACP

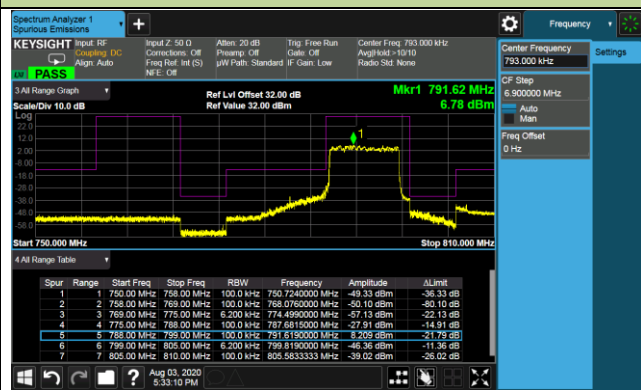

5.6. Emission Mask

5.6.1. Test Limit

Emission Mask B. For transmitters that are equipped with an audio low-pass filter, the power of any emission must be attenuated below the unmodulated carrier power (P) as follows:

- (1) On any frequency removed from the assigned frequency by more than 50 percent, but not more than 100 percent of the authorized bandwidth: At least 25 dB.
- (2) On any frequency removed from the assigned frequency by more than 100 percent, but not more than 250 percent of the authorized bandwidth: At least 35 dB.
- (3) On any frequency removed from the assigned frequency by more than 250 percent of the authorized bandwidth: At least $43 + 10 \log (P)$ dB.

5.6.2. Test Procedure Used

ANSI C63.26-2015 - Section 5.7

5.6.3. Test Setting

1. Set the analyzer frequency to low or high channel
2. $RBW \geq$ The nominal RBW shall be in the range of 1% of the anticipated OBW (in the 1MHz band immediately outside and adjacent to the band edge). For improvement of the accuracy in the measurement of the average power of a noise-like emission, a RBW narrower than the specified reference bandwidth can be used (generally limited to no less than 1% of the OBW), provided that a subsequent integration is performed over the full required measurement bandwidth. This integration should be performed using the spectrum analyzer's band power functions.
3. $VBW \geq 3 * RBW$
4. Sweep time = auto
5. Detector = power averaging (rms)
6. Set sweep trigger to "free run."
7. User gate triggered such that the analyzer only sweeps when the device is transmitting at full power
8. Trace average at least 100 traces in power averaging (rms) mode if sweep is set to auto-couple. To accurately determine the average power over the on and off time of the transmitter, it can be necessary to increase the number of traces to be averaged above 100, or if using a manually configured sweep time, increase the sweep time.

5.6.4. Test Setup

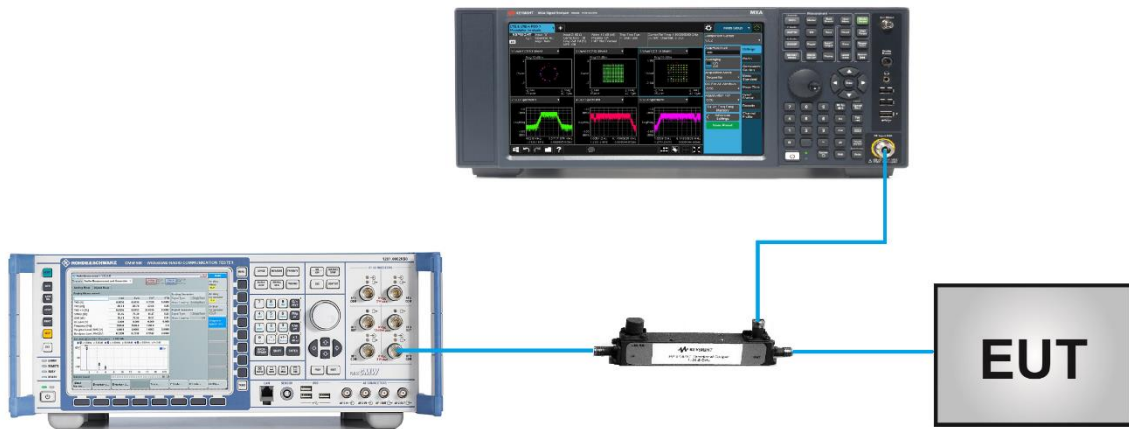

5.6.5. Test Result

Product	LTE-A Cat 16 M.2 Module	Test Engineer	Gordon Qi
Test Date	2020/08/03	Test Site	SR6
Test Band	Band 14	Test Result	Pass

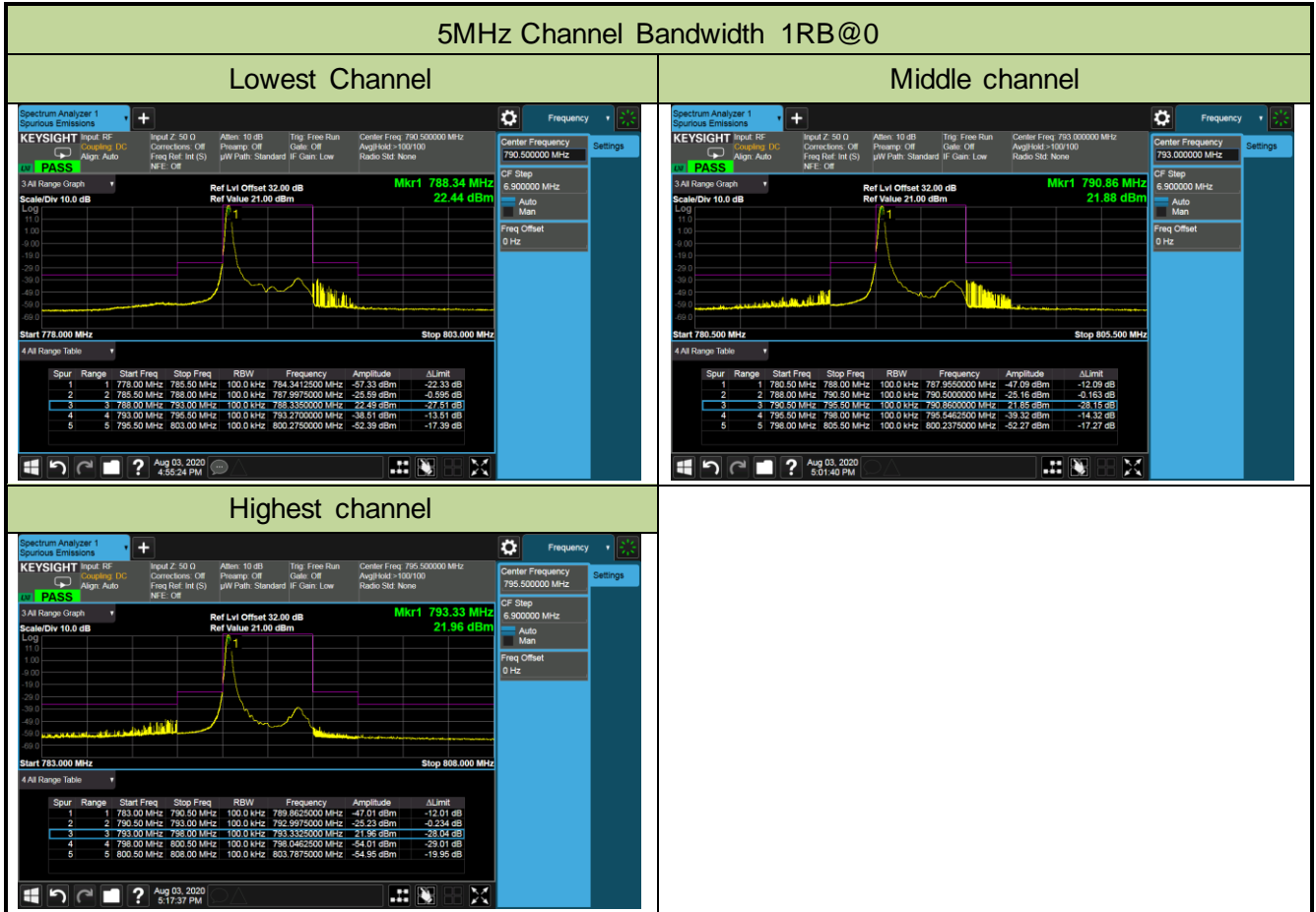

5MHz Channel Bandwidth 1RB@24

Lowest Channel

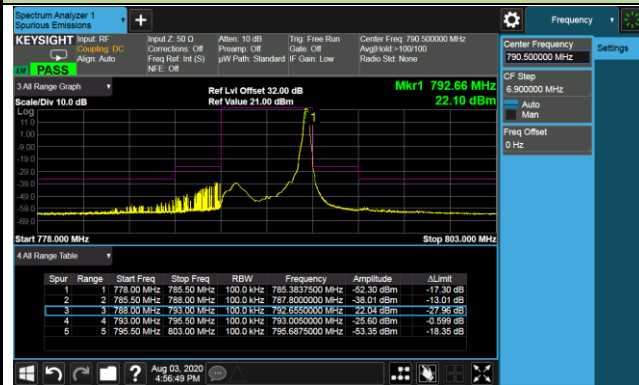

Middle channel

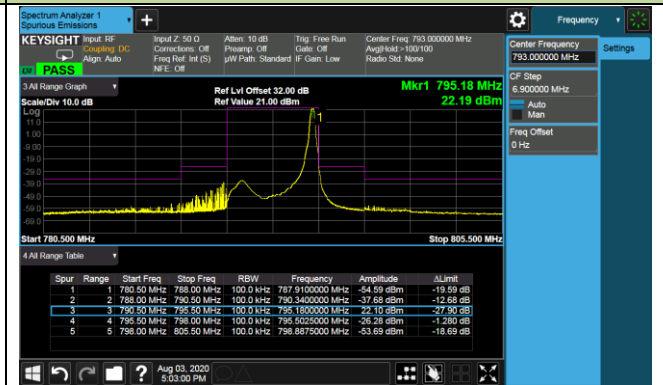

Highest channel

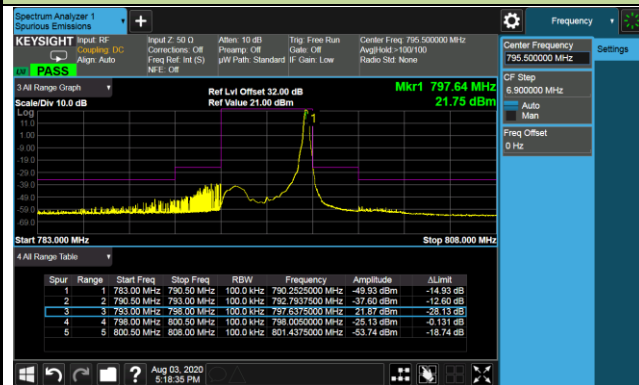

5MHz Channel Bandwidth Full RB

Lowest Channel

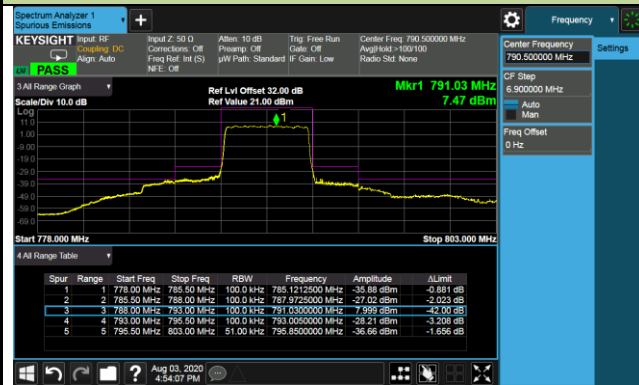

Middle channel

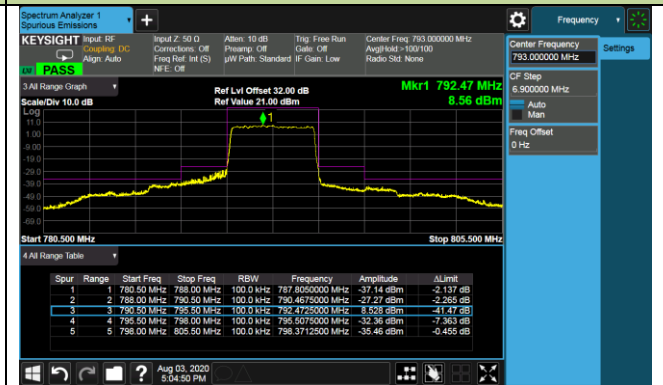

Highest channel

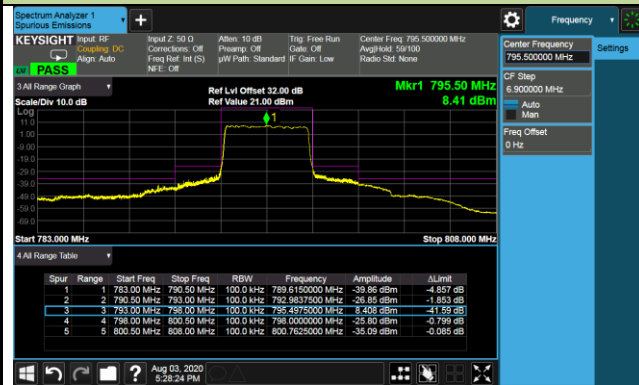

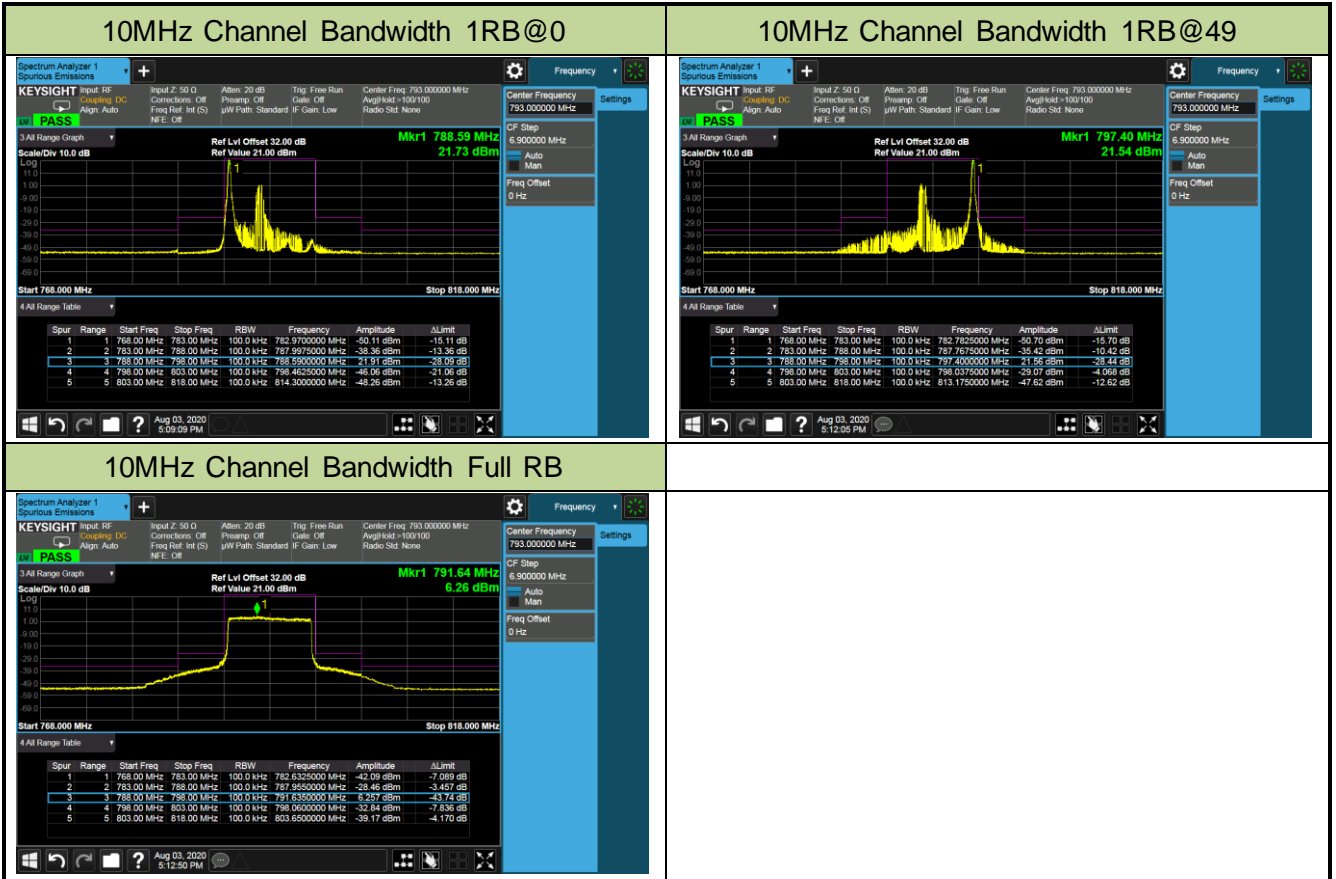

5.7. Conducted Spurious Emissions

5.7.1. Test Limit

The level of the carrier and the various conducted spurious and harmonic frequencies is measured by means of a calibrated spectrum analyzer. The spectrum is scanned from the lowest frequency generated in the equipment up to a frequency including its 10th harmonic. All out of band emissions are measured with a spectrum analyzer connected to the antenna terminal of the EUT while the EUT is operating at its maximum duty cycle, at maximum power, and at the appropriate frequencies. All data rates were investigated to determine the worst-case configuration. All modes of operation were investigated and the worst-case configuration results are reported in this section.

On any frequency between 775-788 MHz, above 805 MHz, and below 758 MHz, by at least $43 + 10 \log (P)$ dB.

5.7.2. Test Procedure Used

ANSI C63.26-2015 - Section 5.7

5.7.3. Test Setting

1. Set the analyzer frequency to low, mid, high channel.
2. RBW = 1MHz
3. VBW $\geq 3 \cdot$ RBW
4. Sweep time = auto
5. Detector = power averaging (rms)
6. Set sweep trigger to "free run."
7. User gate triggered such that the analyzer only sweeps when the device is transmitting at full power.
8. Trace average at least 100 traces in power averaging (rms) mode if sweep is set to auto-couple.
To accurately determine the average power over the on and off time of the transmitter, it can be necessary to increase the number of traces to be averaged above 100, or if using a manually configured sweep time, increase the sweep time.

5.7.4. Test Setup

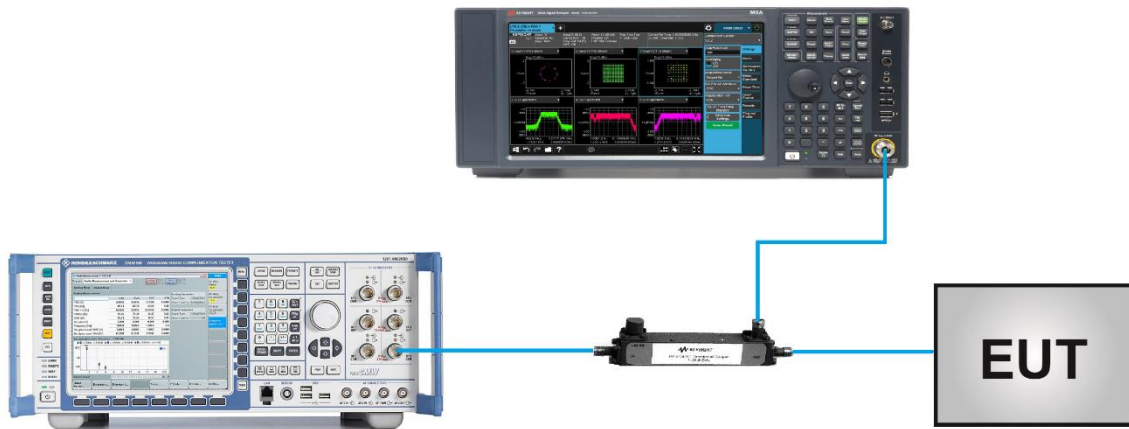

5.7.5. Test Result

Product	LTE-A Cat 16 M.2 Module	Test Engineer	Candy Luo
Test Date	2020/06/30	Test Site	SR6
Test Band	Band 14	Test Result	Pass

Channel	Frequency (MHz)	Channel Bandwidth (MHz)	Frequency Range (MHz)	Max Spurious Emissions (dBm)	Limit (dBm)	Result
QPSK						
23305	790.5	5	30 ~ 10000	-46.99	≤ -13.00	Pass
23330	793.0	5	30 ~ 10000	-49.06	≤ -13.00	Pass
23355	795.5	5	30 ~ 10000	-48.56	≤ -13.00	Pass
23330	793.0	10	30 ~ 10000	-47.59	≤ -13.00	Pass

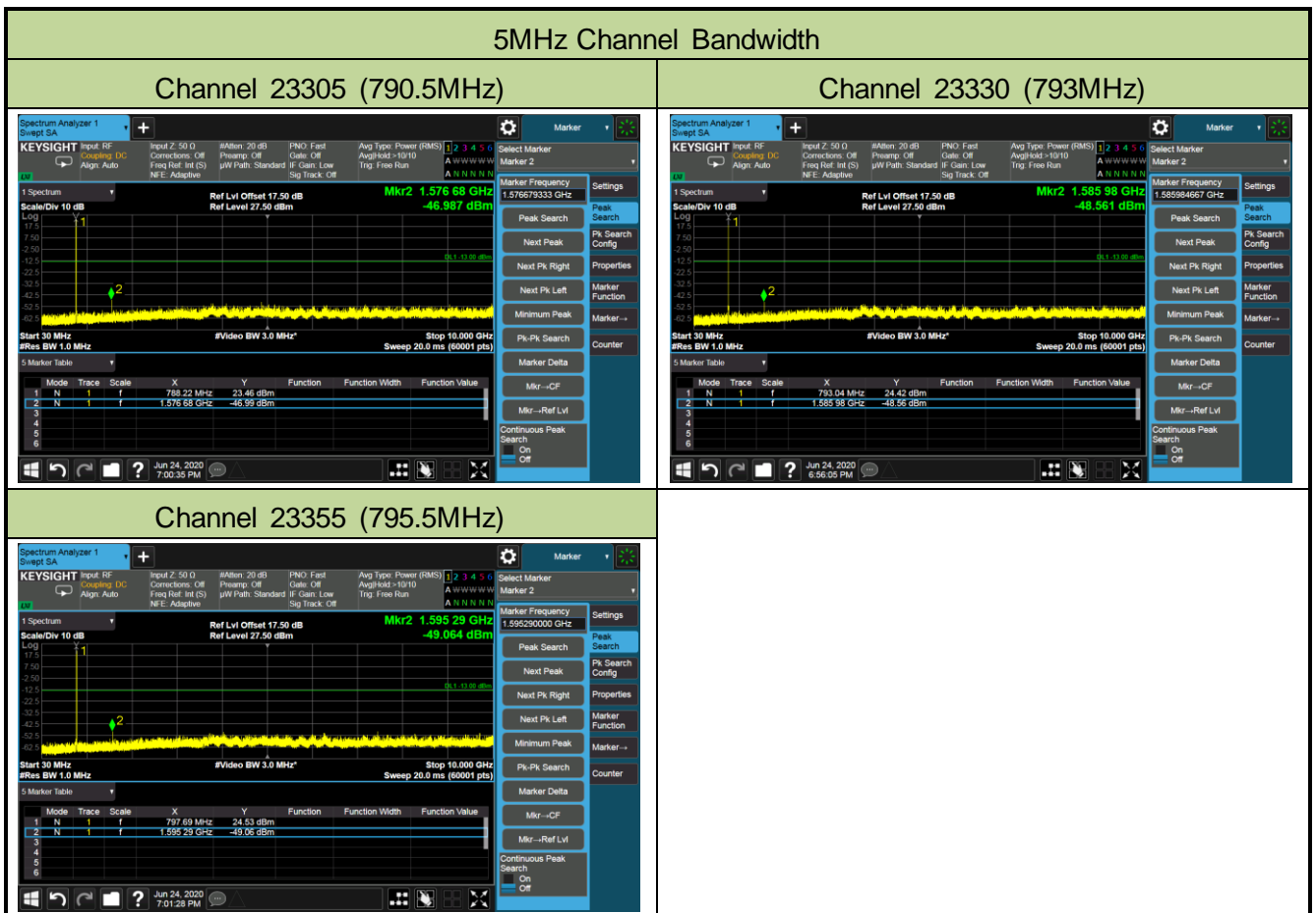

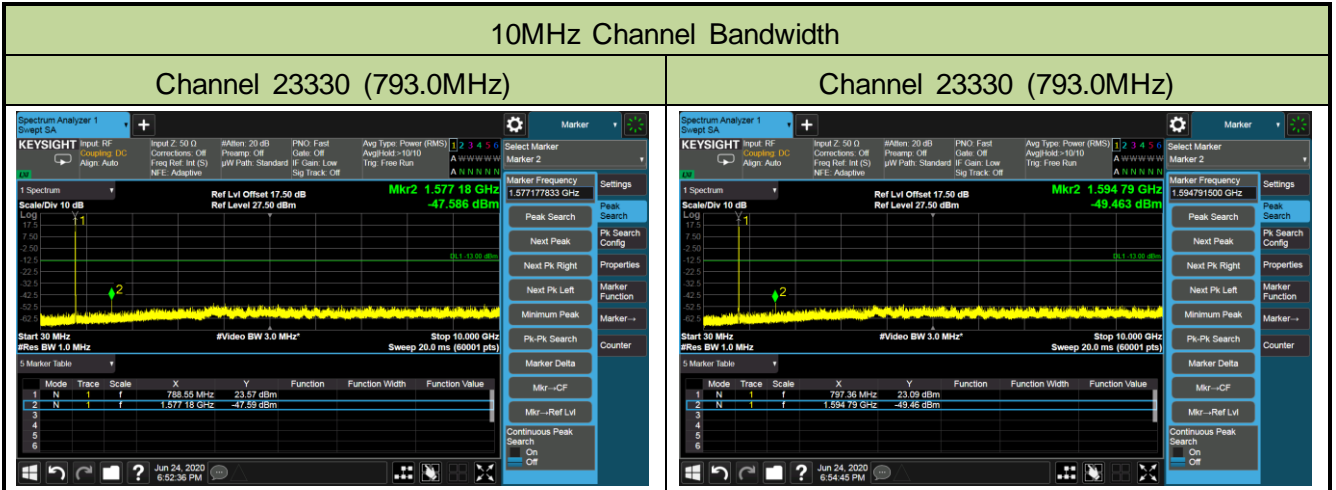

5.8. Radiated Spurious Emissions Measurements

5.8.1. Test Limit

Out of band emissions: The power of any emission outside of the authorized operating frequency ranges must be attenuated below the transmitting power (P) by a factor of at least $43 + 10 \log(P)$ dB. The emission limit equal to -13dBm.

For operations in the 758-775 MHz and 788-805 MHz bands, all emissions including harmonics in the band 1559-1610 MHz shall be limited to -70 dBW/MHz (-40 dBm/MHz) equivalent isotropically radiated power (EIRP) for wideband signals, and -80 dBW (-50 dBm) EIRP for discrete emissions of less than 700 Hz bandwidth. For the purpose of equipment authorization, a transmitter shall be tested with an antenna that is representative of the type that will be used with the equipment in normal operation.

E (dB μ V/m) = EIRP (dBm) - $20 \log D$ + 104.8; where D is the measurement distance in meters. The emission limit equal to 82.3dB μ V/m or 55.3dB μ V/m.

5.8.2. Test Procedure Used

ANSI C63.26-2015 - Section 5.2.7 & 5.5

5.8.3. Test Setting

1. RBW = 1MHz
2. VBW \geq 3*RBW
3. Sweep time \geq $10 \times$ (number of points in sweep) \times (transmission symbol period)
4. Detector = Peak
5. Trace mode = max hold
6. The trace was allowed to stabilize

5.8.4. Test Setup

Below 1GHz Test Setup:

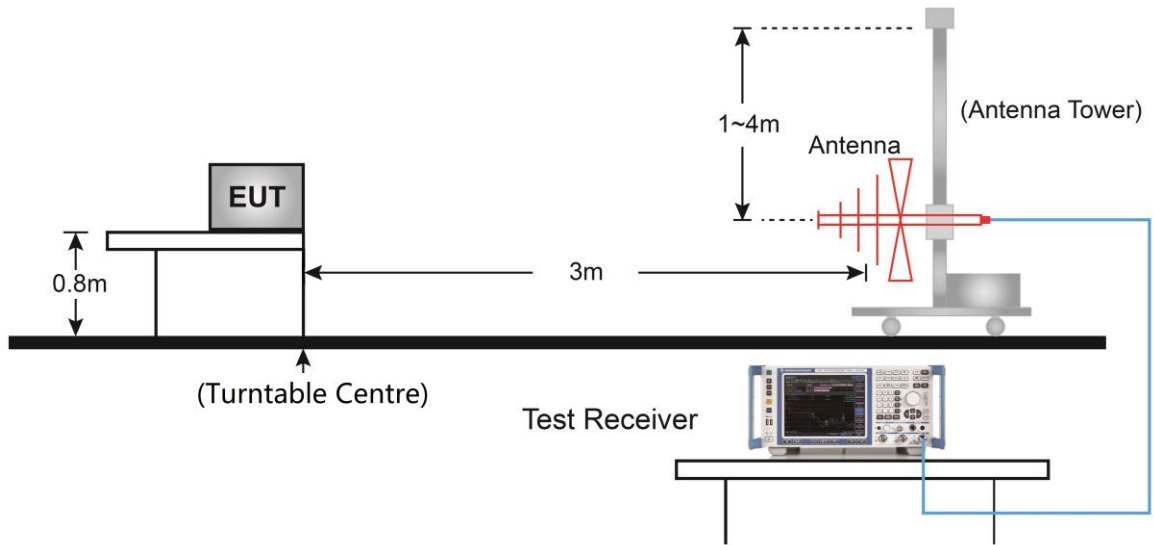

Above 1GHz Test Setup:

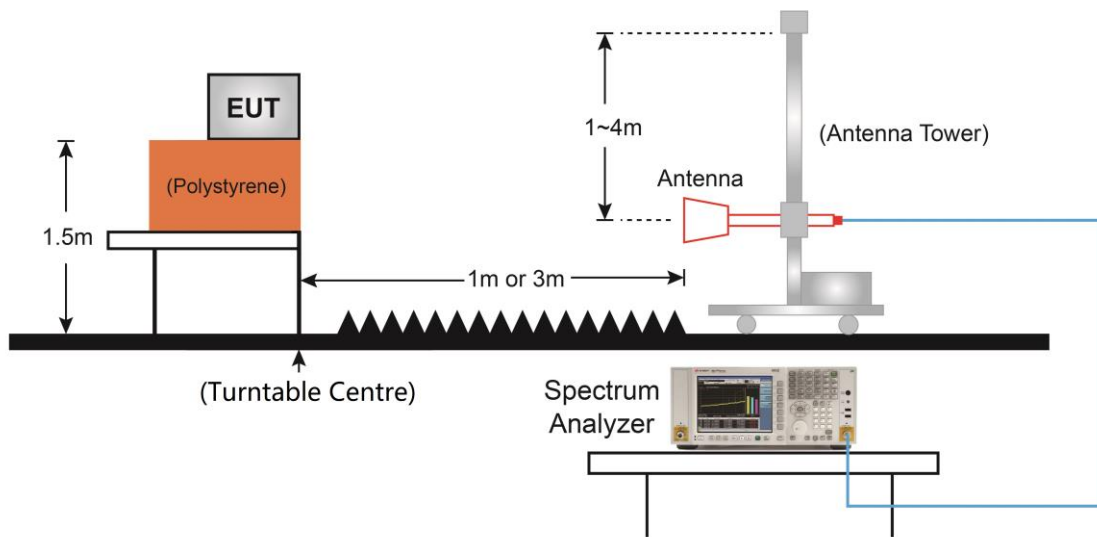

5.8.5. Test Result

Product	LTE-A Cat 16 M.2 Module	Test Engineer	Buter Shi
Test Site	AC1	Test Date	2020/08/04
Test Mode	LTE Band 14 - 5MHz Bandwidth, 1RB, QPSK		

Frequency (MHz)	Reading Level (dBμV)	Factor (dB)	Measure Level(dBμV/m)	Limit (dBμV/m)	Margin (dB)	Detector	Polarization
Bottom CH 23305 (790.5MHz)							
312.3	29.7	20.4	50.1	82.3	-32.2	Peak	Horizontal
359.3	25.7	21.3	47.0	82.3	-35.3	Peak	Horizontal
312.3	19.9	20.4	40.3	82.3	-42.0	Peak	Vertical
361.3	19.8	21.3	41.1	82.3	-41.2	Peak	Vertical
1576.0	36.0	-4.4	31.6	55.3	-23.7	Peak	Horizontal
2366.0	33.1	-1.2	31.8	82.3	-50.5	Peak	Horizontal
1576.0	35.3	-4.4	30.9	55.3	-24.4	Peak	Vertical
2366.0	32.9	-1.2	31.7	82.3	-50.6	Peak	Vertical
Middle CH 23330 (793.0MHz)							
312.3	28.3	20.4	48.7	82.3	-33.6	Peak	Horizontal
360.3	25.8	21.3	47.1	82.3	-35.2	Peak	Horizontal
311.3	19.7	20.4	40.1	82.3	-42.2	Peak	Vertical
364.2	19.4	21.4	40.8	82.3	-41.5	Peak	Vertical
1582.0	35.5	-4.4	31.2	55.3	-24.1	Peak	Horizontal
2372.0	33.2	-1.3	31.9	82.3	-50.4	Peak	Horizontal
1582.0	35.6	-4.4	31.2	55.3	-24.1	Peak	Vertical
2372.0	33.5	-1.3	32.3	82.3	-50.0	Peak	Vertical
Top CH 23355 (795.5MHz)							
312.3	27.8	20.4	48.2	82.3	-34.1	Peak	Horizontal
361.3	25.0	21.3	46.3	82.3	-36.0	Peak	Horizontal
313.2	19.0	20.5	39.4	82.3	-42.9	Peak	Vertical
362.2	21.5	21.3	42.9	82.3	-39.4	Peak	Vertical
1586.0	35.1	-4.4	30.7	55.3	-24.6	Peak	Horizontal
2380.0	33.5	-1.3	32.2	82.3	-50.1	Peak	Horizontal
1586.0	35.7	-4.4	31.3	55.3	-24.0	Peak	Vertical
2380.0	33.4	-1.3	32.1	82.3	-50.2	Peak	Vertical

Note: Measure Level (dBm) = Reading Level (dBm) + Factor (dB).

6. CONCLUSION

The data collected relate only the item(s) tested and show that unit is compliance with FCC Rules.

Appendix A - Test Setup Photograph

Refer to "2009RSU020-UT" file.

Appendix B - EUT Photograph

Refer to "2009RSU020-UE" file.